

TENDER NO: PSER:SCT:BAR-C1971:19

VOLUME -ID

SPECIAL CONDITIONS OF CONTRACT

FOR

LEVELLING GRADING, PILING WORK INCLUDING TESTING OF PILES AND OTHER ASSOCIATED WORKS ETC. OF FGD SYSTEM FOR BARH STAGE-I (3X660 MW) & STAGE-II (2X660 MW), STPP, BIHAR.

BHARAT HEAVY ELECTRICALS LIMITED

(A GOVT. OF INDIA UNDERTAKING)

POWER SECTOR – EASTERN REGION

PLOT NO. – 9 / 1, DJ – BLOCK,

SECTOR – II, KARUNAMOYEE,

SALT LAKE CITY,

KOLKATA – 700091.

Bharat Heavy Electricals Limited		
Power Sector – Eastern Region, Kolkata		
TENDER NO. PSER:SCT:BAR-C1971:19		
VOLUME-ID	SPECIAL CONDITIONS OF CONTRACT (SERVICE)	PAGE1OF47

CONTENTS

SN	DESCRIPTION	Chapter	No. OF PAGES
1	General Intent of the Specifications	Chapter-I	
2	General Services to be rendered by the Bidder	Chapter-II	
3	General Technical Requirements (Codes and Standards)	Chapter-III	
4	Obligations of Contractor (In respect of Tools, Tackles, Consumables, etc employment of supervisory staff and workmen)	Chapter-IV	
5	Responsibilities of Contractor (In respect of employment of Labour, Supervisory staff, etc)	Chapter-V	
6	Material Handling, Storage, Preservation, etc	Chapter-VI	
7	Drawings and Documents	Chapter-VII	
8	Inspection and Quality	Chapter-VIII	
9	HSE & OHSAS Obligations	Chapter-IX	
10	RA Bill Payment	Chapter-X	
11	Performance Monitoring	Chapter-XI	
12	Suspension of Business Dealings	Chapter-XII	

SPECIAL CONDITIONS OF CONTRACT (SCC)
Chapter - I : General Intent of Specifications

1.0	INTENT OF THE SPECIFICATION
1.1	The intent of this erection specification is to provide services for execution of the project according to most modern and proven techniques and codes. The omission of specific reference to any method, equipment or material necessary for the proper and efficient services towards installation of the plant shall not relieve the contractor of the responsibility of providing such services / facilities to complete the work or portion of work awarded to him. The quoted / accepted rates / price shall deem to be inclusive of all such contingencies.
1.2	The work shall conform to dimensions and tolerances given in various drawings and documents that will be provided during erection. If any portion of works is found to be defective in workmanship and not conforming to drawings / documents or other stipulations, the contractor shall dismantle and re-do the work duly replacing the defective materials at their own cost, failing which recoveries, as determined by BHEL, shall be effected from contractor's bills.
1.3	It is not the intent of this specification to specify herein all the details of erection and commissioning. However, the system shall conform in all respects to high standards of quality and workmanship for performing the required duties in a manner acceptable to purchaser who will interpret the meaning of drawings and specifications and shall be entitled to reject any work or material, which in his judgments is not in full accordance herewith.
1.4	The omission of specific reference to any fabrication / erection or other method, equipment or material necessary for proper and efficient working of the plant shall not relieve the tenderer of the responsibility of providing such facilities to complete the work at quoted rates. Any mismatch/ defect found due to mistake in fabrication / erection shall have to be rectified by the vendor free of cost. Inspection by BHEL/Customer does not relieve vendor of his responsibility of executing quality erection.
1.5	The work covered under this specification is of highly sophisticated nature, requiring the best quality workmanship, supervision, engineering and construction management. The contractor should ensure proper planning and successful and timely completion of the work to meet the overall project schedule. The contractor must deploy adequate quantity of tools & plants, modern / latest construction aids etc. He must also deploy adequate trained, qualified and experienced supervisory staff and skilled personnel.

SPECIAL CONDITIONS OF CONTRACT (SCC)
Chapter - I : General Intent of Specifications

1.6	Contractor shall erect and commission all the equipments and auxiliaries as per the sequence & methodology prescribed by BHEL depending upon the technical requirements. Availability of materials and fronts will decide this. BHEL Engineer's decision regarding correctness of the work and method of working shall be final and binding on the contractor. No claims for extra payment from the contractor will be entertained on the ground of deviation from the methods / sequence adopted in erection of similar sets elsewhere.
1.7	Following shall be the minimum responsibility of contractor and have to be provided within finally accepted rates / prices:
1.7.1	Provision as required of all types of labour, supervisors, engineers, watch and ward, tools & tackles, calibrated MMEs (Monitoring and Measuring Equipment) as specified and otherwise required for the work, consumables for erection, testing and commissioning including material handling
1.7.2	Achieving Proper out-turn / Turn-over as per BHEL plan and commitment.
1.7.3	Completion of work as per BHEL Schedule
1.7.4	Good quality and accurate workmanship for proper performance of the equipment
1.7.5	Repair and rectification
1.7.6	Preservation / Re-conservation of all components during storage / erection / commissioning till handing over.

SPECIAL CONDITIONS OF CONTRACT (SCC)
Chapter - II : General Services to be rendered by the Bidder

2.0	GENERAL SERVICES TO BE RENDERED BY THE BIDDER
2.1	Services for construction, fabrication, equipment erection testing as well as trial run & commissioning of various equipment and accessories under the contract shall include but not be limited to the following:
2.2	Issuing materials from store/open yard from time to time for erection as per the construction programme. The Contractor shall be the custodian of all the materials issued till the plant/equipment is officially taken over by the owner / BHEL after complete erection any successful trial run & commissioning.
2.3	Transport of material to their respective places of erection and erection of the complete plant & equipment as supplied under this specification.
2.4	Trial run and commissioning of individual equipment / sub-systems to the satisfaction of Owner/BHEL.
2.5	Deployment of all skilled and unskilled manpower required for erection, supervision of erection, watch & ward, commissioning and other services to be rendered under this specification.
2.6	Deployment of all erection tools & tackle, construction machinery, transportation vehicles and all other implements in adequate number and size, appropriate for the erection work to be handled under scope of this specification except otherwise specified.
2.7	Supply of all consumables, eg welding electrodes, cleaning agents, diesel oil, lubricant etc as well as materials required for temporary supports, scaffolding etc as necessary for such erection work, unless specified other wise.
2.8	Providing support services for the contractor's erection staff eg construction of site offices, temporary stores, residential accommodation and transport to work site for erection personnel, watch and ward for security and safety of the materials under the Contractor's custody etc. as required.
2.9	Maintaining proper documentation of all the site activities undertaken by the Contractor as per the proforma mutually agreed with BHEL, Submission of monthly progress reports and any such document as and when desired by BHEL/owner, taking approval of all statutory authorities i.e Boiler Inspector, Factory Inspector, Inspector of Explosives etc , as applicable for respective portions of work fall under the jurisdiction of such statutes of laws.
2.10	Any other service, although not specifically called for but required for a contract of the size and nature indicated in the specification.

SPECIAL CONDITIONS OF CONTRACT (SCC)
Chapter - III : General Technical Requirements (Codes and Standards)

3.0	GENERAL TECHNICAL REQUIREMENTS (CODES AND STANDARDS)
3.1	Except where otherwise specified, the plant/equipment shall comply with the appropriate Indian Standard or an agreed internationally accepted Standard Specification as mentioned elsewhere in contract specifications, each incorporating the latest revisions at the time of tendering. Where no internationally accepted standard is applicable, the Bidder shall give all particulars and details as necessary, to enable BHEL to identify all of the plant/equipment in the same detail as would be possible had there been a Standard Specification.
3.2	Where the Bidder proposes alternative codes or standards he shall include in his tender one copy (in English) of each Standard Specification to which materials offered shall comply. In such case, the adopted alternative standard shall be equivalent or superior to the standards mentioned in the specification.
3.3	In the event of any conflict between the codes and standards referred above, and the requirements of this specification, the requirements which are more stringent shall govern.
3.4	Tools used during erection and commissioning shall not be accepted except with the specific approval of the Engineer.

SPECIAL CONDITIONS OF CONTRACT (SCC)
Chapter - IV : Obligations of Contractor

4.0	OBLIGATIONS OF CONTRACTOR
4.1	CONSUMABLES & OTHER ITEMS
4.1.1	The contractor shall provide within finally accepted price / rates, all consumables (excepting those indicated in BHEL scope) like welding electrodes (including alloy steel and stainless steel), filler wires, TIG filler wires (over & above as supplied by the unit along with the plant materials, which will be given free of cost to bidder), gases (inert, welding, cutting), soldering material, dye penetrants, radiography films, etc. Other erection consumables such as tapes, jointing compound, grease, mobile oil, M-seal, Araldite, petrol, CTC / other cleaning agents, grinding and cutting wheels are to be provided by the contractor. Steel, packers, shims, wooden planks, scaffolding materials hardware items etc required for temporary works such as supports, scaffoldings are to be arranged by the contractor. Sealing compounds, gaskets, gland packing, wooden/concrete sleepers, for temporary work, required for completion of work except those which are specifically supplied by manufacturing unit are also to be arranged by the contractor.
4.1.2	All the shims, gaskets and packing, which go finally as part of plant equipment, shall be supplied by BHEL free of cost.
4.1.3	It shall be the responsibility of the contractor to plan the activities and store sufficient quantity of consumables. Non-availability of any consumable materials or equivalent suggested by BHEL cannot be considered as reason for not attaining the required progress or for additional claim.
4.1.4	<u>TIG Filler wire for Boiler and Filler wires for Electrodes for P91/T91 piping:</u> These shall be supplied by BHEL free of cost as supplied by BHEL Manufacturing Units as part of regular supply. Required quantity as arrived at by calculation / standards will only be supplied. It would be the contractors' responsibility to account for the consumption of these filler wires. Additional consumption beyond standard / calculated quantity will be at cost recovery basis only unless and otherwise accounted for. Surplus quantity of TIG filler wire, if any, shall be properly stored and returned to BHEL stores.
4.1.5	It shall be the responsibility of the contractor to obtain prior approval of BHEL, regarding suppliers, type of electrodes etc before procurement of welding electrodes. On receipt of electrodes at site these shall be subjected to inspection and approval by BHEL. The contractor shall inform BHEL details regarding type of electrodes, batch number, date of expiry etc and produce test certificate for each lot / batch with correlation of batch / lot number with respective test certificate. No

SPECIAL CONDITIONS OF CONTRACT (SCC)

Chapter - IV : Obligations of Contractor

	electrode without a valid test certificate will to be used.
4.1.6	BHEL reserves the right to reject the use of any consumable including electrodes, gases, lubricants / special consumables if it is not found to be of the required standard / make / purity or when shelf life has expired. Contractor shall ensure display of shelf life on consumable wherever required and records maintained.
4.1.7	Storage of all consumables including welding electrodes shall be done as per requirement / instruction of the Engineer by the contractor at his cost.
4.1.8	In case of improper arrangement for procurement of any consumable, BHEL reserves the right to procure the same from any source and recover the cost from the Contractor's first subsequent bill at market value plus the departmental charges of BHEL from time to time. Postponement of such recovery is normally not permitted. The decision of Engineer in this regard shall be final and binding on the Contractor.
4.1.9	All lubricants and chemicals required for pre-commissioning, commissioning, testing, preservation and lubricants for trial runs of the equipment shall be supplied by BHEL / BHEL's client. All services including labour and T&P will be provided by the contractor for handling, filling, emptying, refilling etc. The consumption of lubricants / chemicals shall be properly accounted for. Surplus material if any shall be properly stacked/tagged and returned to BHEL/ CUSTOMER stores at no extra cost to BHEL. BHEL reserves the right to recover costs for wastage by the contractor.
4.1.10	Transportation of oil drums, from stores, filling of oil for flushing, first filling, subsequent changeover if any, topping/making up till the unit is fully commissioned and handed over to customer is included in scope of this contract. The contractor shall have to return all the empty drums to BHEL / BHEL's client store at no extra cost. Any loss / damage to above drums shall be to contractor's account.
4.1.11	All charges on account of Octroi, terminal or sales tax and other duties on materials obtained from any source for carrying out the works in the scope of the contractor shall be borne by the contractor.
4.2	TOOLS AND PLANTS / MONITORING AND MEASURING EQUIPMENT (MMEs)
4.2.1	T&Ps and MMEs to be provided by Contractor
4.2.1.1	All T&Ps and MMEs excepting those specifically indicated in BHEL scope are to be provided by the Contractor. Contractor has to make his own arrangement at his cost for completing the formalities (including arrangement of Road permits, if any) if required with Sales Tax/VAT authorities, for bringing their materials, plants and

Bharat Heavy Electricals Limited
Power Sector – Eastern Region, Kolkata

VOLUME-ID

TENDER NO. PSER:SCT:BAR-C1971:19

PAGE7OF47

SPECIAL CONDITIONS OF CONTRACT (SCC)

Chapter - IV : Obligations of Contractor

	equipments at site for the execution of work under this contract.
4.2.1.2	All suitable cranes, lifting and transport equipments for material handling at stores/yard/siding of BHEL/Customer are included in scope. BHEL's cranes will not be available for this purpose unless otherwise specifically permitted as per contract conditions
4.2.1.3	All T&Ps to be deployed by the contractor shall have the approval of BHEL Engineer with regard to brand, quality and specification.
4.2.1.4	Indicative list of Major T&Ps in the scope of Contractor are given in the Technical Conditions of Contract. Bidders to note that these are only indicative and as such all other T&P necessary for timely and satisfactory completion of work in scope shall be mobilized by Contractor
4.2.1.5	Timely deployment of adequate T&Ps is the responsibility of the contractor. The contractor shall be prepared to augment the T&P at short notice to match the planned programme and to achieve the milestones.
4.2.1.6	Contractor shall maintain and operate his tools and plants in such a way that major breakdowns are avoided. In the event of major breakdown, contractor shall make alternative arrangements expeditiously so that the progress of work is not hampered.
4.2.1.7	In the event of contractor failing to arrange the required tools, plants, machinery, equipment, material or non-availability of the same owing to breakdown, BHEL will make alternative arrangement at the risk and cost of the contractor. Decision of BHEL shall be final and binding on the contractor
4.2.1.8	The T&P to be arranged by the contractor shall be in proper working condition and their operation shall not lead to unsafe condition. The movements of cranes, and other equipment should be such that no damage / breakage occurs to foundations, other equipments, material, property and men. All arrangements for the movement of the T&P etc shall be the contractor's responsibility.
4.2.1.9	Use of welding generators/ rectifiers only shall be permitted for welding. Use of welding transformers will be subject to specific approval of BHEL engineer.
4.2.1.10	The contractor at his cost shall carry out periodical testing of his construction equipments. Test certificates shall be furnished to BHEL.
4.2.1.11	Contractor shall ensure deployment of serviced and healthy T&Ps including cranes, lifting tackles, wire ropes, manila ropes, winches and slings etc. History card and maintenance records for major T&Ps will be maintained by the contractor and will be made available to BHEL Engineer for inspection as and when required.

Bharat Heavy Electricals Limited

Power Sector – Eastern Region, Kolkata

VOLUME-ID

TENDER NO. PSER:SCT:BAR-C1971:19

PAGE8OF47

SPECIAL CONDITIONS OF CONTRACT (SCC)

Chapter - IV : Obligations of Contractor

	<p>Fitness certificate / Test Certificates of T&P shall have to be submitted before it is put in use. Identification for such T&Ps will be done as per BHEL Engineer's advice.</p> <p>BHEL reserves the right to permit only new slings up to 20 mm and lifting tackles up to 3 MT capacities.</p>
4.2.1.12	<p>Contractor shall ensure deployment of reliable and calibrated MMEs (Inspection measuring and Monitoring equipment). The MMEs shall have test / calibration certificates from authorized / Government approved / accredited agencies traceable to National / International standards. Each MME shall have a label indicating calibration status i.e. date of calibration, calibration agency and due date for calibration. A list of such instruments deployed by contractor at site with its calibration status is to be submitted to BHEL Engineer for control.</p>
4.2.1.13	<p>Re-testing / re-calibration shall also be arranged at regular intervals during the period of use as advised by BHEL Engineer within the contract price. The contractor will also have alternate arrangements for such MME so that work does not suffer when the particular instrument is sent for calibration. If any MMEs not found fit for use, BHEL shall have the right to stop the use of such item. It will be necessary for the contractor to deploy proper item. Any readings taken by the defective instrument will be recalled and repeat the readings taken by that instrument with a proper one. In case he fails to do so, BHEL may deploy MMEs and retake the readings at contractor's cost.</p>
4.2.1.14	<p>BHEL shall have lien on all T&P, MMEs and other equipment of the contractor brought to the site for the purpose of erection, testing and commissioning. BHEL shall continue to hold the lien on all such items throughout the period of contract / extended period. The contractor and / or his sub-contractors, without the prior written approval of the Engineer, shall remove no material brought to the site.</p>
4.2.1.15	<p>The month wise T&P deployment plan to execute the work is to be submitted as per relevant format as per the instruction of BHEL. It shall be the contractor's responsibility to deploy the required T&P, for timely and successful completion of the job, to any extent.</p>
4.2.2	<p>Obligations in respect of T&Ps and MMEs provided by BHEL</p>
4.2.2.1	<p>T&P / MMEs being provided by BHEL to sub-contractor free of hire charges shall be shared by other subcontractors working for BHEL at site and the allotment done by BHEL Engineer shall be final and binding.</p>
4.2.2.2	<p>BHEL T&P will be issued in basic assembled condition. Additional loose components / sub-assemblies / attachments as and when necessary, will be</p>

Bharat Heavy Electricals Limited

Power Sector – Eastern Region, Kolkata

VOLUME-ID

TENDER NO. PSER:SCT:BAR-C1971:19

PAGE9OF47

SPECIAL CONDITIONS OF CONTRACT (SCC)

Chapter - IV : Obligations of Contractor

	issued by BHEL. Assembly of such additional loose components/sub-assemblies/ attachments is in contractor's scope.
4.2.2.3	In case of non-availability of the T&Ps to be provided by BHEL due to breakdown, major overhauls, distribution pattern or any other reason, the contractor shall plan / amend / alter his activities to meet erection / commissioning targets in consultation with BHEL.
4.2.2.4	void
4.2.2.5	The contractor shall engage trained and experienced operators for the operation of BHEL's T&Ps. Their skill / performance will be checked by BHEL Engineer before they are allowed to operate the same. However checking of skills by BHEL does not absolve the contractor of his responsibilities for proper and safe handling of equipment, consistent good performance of operators and regular performance evaluation of operators.
4.2.2.6	<p>The day to day operation and maintenance of BHEL's T&Ps (Other than cranes) shall be carried out by contractor as per manufacturer's / BHEL's maintenance schedule at his cost. The contractor shall arrange, at his own cost, trained operators, fuel and other consumables for their operation. BHEL shall arrange all spares needed for upkeep of major T&Ps provided like Huck Bolting Machine*, DG Set, Induction Machine and Hydraulic Test pumps. The contractor has to arrange for fixing of the spares; supervision in specialized cases will be provided by BHEL. For upkeep of all other T&Ps supplied by BHEL, spares shall be arranged by the Contractor. BHEL supplied T&Ps shall be maintained in good working condition during the entire period of use. T&Ps in defective / damaged condition shall be rectified promptly to the full satisfaction of BHEL engineer. Contractor shall maintain records for maintenance of major T&Ps. These shall be made available for Inspection whenever required. In case of any lapses on the part of the contractor, BHEL at its own discretion shall get the servicing / repair of equipment done at the risk and cost of the contractor along with BHEL overheads. Further, if there are breakdowns / damages due to negligence of the contractor, the complete service / repair charges and cost of all the spares damaged with BHEL overheads shall be recovered from contractor's RA bills.</p> <p>*: for operation and maintenance of ESP Huck bolting machine, BHEL shall provide the basic power rig and hose. Balance toolingsie Guns, chuck jaws etc are to be arranged by contractor.</p>
4.2.2.7	void

SPECIAL CONDITIONS OF CONTRACT (SCC)

Chapter - IV : Obligations of Contractor

4.2.2.8	Increasing / shortening of the crane boom to suit work requirements shall have to be arranged by the indenting contractor at his cost including restoration to a state as directed by BHEL. All necessary manpower tools, support, consumables, illumination etc. will have to be arranged by contractor at his cost. If required, contractor has to return the crane with original boom.
4.2.2.9	The area and infrastructure development of the area to be carried out by the customer. However in construction projects of this magnitude it is possible that all the areas / approaches may not be ready. In such cases backfilling of approaches where ever necessary, consolidation of ground and arrangement of sleepers / sand bag filling etc for safe operation / movement of equipment including cranes / trailers etc shall be the responsibility of the contractor at his cost. No compensation on this account shall be payable.
4.2.2.10	In the event of contractor not using and maintaining BHEL T&Ps according to BHEL's instructions. BHEL will have the right to withdraw such item without any notice and no claim in this regard shall be entertained and contractor shall be responsible for delay in execution on this account.
4.2.2.11	The contractor shall furnish regular utilization report of the BHEL T&Ps, as per requirement of BHEL.
4.2.2.12	Any loss / damage to any part of BHEL T&Ps and MMEs shall be to the contractor's account and any expenditure on these accounts by BHEL will be recovered from the contractor's bill in case the contractor fails to make good the loss.
4.2.2.13	It shall be responsibility of the contractor to take delivery of T&Ps and MMEs from stores or place of use by other contractor at project site, transport the same to site and return the same to BHEL store / place as intimated by Engineer in project site in good working conditions after use.
4.2.2.14	The contractor shall return BHEL T&Ps and MMEs issued to him in good working condition as and when desired by BHEL (on completion or reduction of workload). If contractor delays return of T&P and MME, hire charges as applicable shall be levied by BHEL from time, it was requisitioned till the time of actual return. T&Ps and MMEs returned in damaged / unserviceable condition shall be got repaired by BHEL at its own discretion and entire cost of repair with BHEL overheads shall be recovered from the contractor.
4.2.2.15	Replacement cost including BHEL overheads in respect of irreparable / completely damaged / non return of T&Ps and MMEs shall be recovered from the

Bharat Heavy Electricals Limited

Power Sector – Eastern Region, Kolkata

VOLUME-ID

TENDER NO. PSER:SCT:BAR-C1971:19

PAGE11OF47

SPECIAL CONDITIONS OF CONTRACT (SCC)

Chapter - IV : Obligations of Contractor

	contractor's running / final bills
4.2.2.16	Obligations in respect of Cranes provided by BHEL
a)	BHEL will make available the cranes (as per Technical Conditions of Contract) free of charge to the contractor on sharing basis mainly for the purposes enumerated/indicated therein. BHEL cranes have to be shared with other agencies / contractors of BHEL. The allocation of cranes shall be the discretion of BHEL engineer, which shall be binding on the contractor.
b)	BHEL Cranes may be initially issued in basic assembled condition. Any alteration/addition like boom reduction / extension, assembly of components/sub-assemblies needed for modulating the capacity/reach/other features of cranes and restoration to the state as directed by BHEL shall be the contractor's responsibility.
c)	<p>In case the BHEL cranes are not covered under AMC of BHEL, then the day-to-day upkeep and running maintenance like filling / topping up of lubricants, changing filters, etc including repair of self starter and dynamo of these cranes shall be the responsibility of the contractor. If on checking it is found that the same is not followed, BHEL will exercise its right to get the job/works done at the risk and cost of contractor.</p> <p>In case BHEL cranes are covered under AMC awarded by BHEL, then the day-to-day upkeep and running maintenance as described above are excluded from scope. However any additional helpers if any required during Preventive/Breakdown Maintenance, Assembly/disassembly shall be provided by contractor at no extra cost.</p> <p>BHEL may also provide cranes through crane hiring agencies in which case the day-to-day upkeep and running maintenance shall be excluded from scope of contractor.</p>
d)	Minor consumables like cotton cloth, cotton waste, etc is to be supplied by Contractor. All spares and lubricants/grease is excluded from scope. Contractor to give the requirements of these items well in advance in case the cranes provided by BHEL are BHEL owned cranes.
e)	Unless otherwise specified, trained operators for BHEL owned cranes shall be provided by the contractor. These operators should possess valid license for heavy vehicle.
f)	BHEL cranes will be withdrawn for regular and capital maintenance as per the respective schedule of maintenance. As far as possible such schedules will be intimated to the contractor in advance and may be adjusted depending on the work

SPECIAL CONDITIONS OF CONTRACT (SCC)
Chapter - IV : Obligations of Contractor

	requirements at site. However no claim whatsoever will be entertained on account of non-availability of cranes.
g)	Where the services of the cranes provided by BHEL are to be shared by other agencies/ contractors of BHEL, the contractor's responsibilities defined above will also be apportioned accordingly to the beneficiary agency. Working arrangements in this regard will be done at site by BHEL engineer and in any case his decision shall be final and binding.
h)	Major breakdowns will be attended to by BHEL. However, in case of breakdowns or damages due to negligence of the contractor, the complete service/repair charges including cost of spares shall be to the account of the contractor, along with BHEL overheads.
4.2.2.17	Obligations in respect of Construction Lift/Elevators provided by BHEL
a)	The total erection including commissioning, maintenance, statutory clearances shall be included in scope of work. Supervision by the original equipment supplier or their authorized agency shall be arranged for by BHEL, in case found necessary.
b)	All day to day and routine maintenance and checking is to be carried out by the contractor as per the recommendations of the supplier. He should periodically check the brakes and carry out the all works to ensure the safety of all those using the lift/elevator. BHEL shall arrange spares required for upkeep of Construction lift/elevator
c)	The construction lift/elevator should never be overloaded as this can lead to serious accidents. Ensuring all safety aspects in operation of the lift shall be the responsibility of the contractor. Erection of all the required number of landing platforms is included in scope. Landing platforms are to be provided with proper barricades and hand railings.
d)	After completion of contractual scope of work or as per BHEL advice, the temporary elevator/lift shall be dismantled and handed over to BHEL neatly identified/tagged. Temporary structures/platforms etc erected for the elevators/lifts are also to be dismantled and materials to be returned to stores as applicable. The construction and dismantling of the foundations required for the construction/elevator lifts is included in the scope of the contractor.

SPECIAL CONDITIONS OF CONTRACT (SCC)
**Chapter – V : Responsibilities of Contractor in respect of Labour,
Supervisory Staff, etc.**

5.0	RESPONSIBILITIES OF CONTRACTOR IN RESPECT OF LABOUR, SUPERVISORY STAFF, ETC.
5.1	Refer relevant clauses of General Conditions of Contract (GCC) also in this regard
5.2	The contractor shall deploy all the necessary skilled/semiskilled/ unskilled labour including highly skilled workmen etc. These workmen should have previous experience on similar job. They shall hold valid certificates wherever necessary. BHEL reserves the right to insist on removal of any employee of the contractor at any time if he is found to be unsuitable and the contractor shall forthwith remove him.
5.3	Contractor shall also comply with the requirements of local authorities/ project authorities calling for police verification of antecedents of the workmen, staff etc.
5.4	It is the responsibility of the contractor to engage his workmen in shifts and or on overtime basis for achieving the targets set by BHEL. This target may be set to suit BHEL's commitments to its customer or to advance date of completion of events or due to other reasons. The decision of BHEL in regard to setting the erection and commissioning targets will be final and binding on the contractor.
5.5	Contractor shall provide at different elevation suitable arrangement for urinal and drinking water facility with necessary plumbing & disposal arrangement including construction of septic tank. These installations shall be maintained in hygienic condition at all times.
5.6	The Contractor in the event of engaging 20 or more workmen, shall obtain Independent license under the Contract labour (Regulation and Abolition) Act 1970 from the concerned authorities based on Form-V issued by the Principal Employer/Customer. In order to issue Form-V by Customer, Contractor shall fulfill all Statutory requirements like Insurance Policy, PF Code/PF Account number etc as per the requirement of BHEL/Customer
5.7	Contractor shall deduct the necessary amount towards Provident Fund and contribute equal amount as per Government of India laws. This amount will be deposited regularly to the provident Fund Commissioner. BHEL/Customer may insist for submission of the account code duly certified by PF Commissioner
5.8	Contractor may also be required to comply with provisions of ESI Act in vogue if applicable and submit evidence to BHEL.
5.9	BHEL / customer may insist for witnessing the regular payment to the labour. They may also like to verify the relevant records for compliance with statutory

SPECIAL CONDITIONS OF CONTRACT (SCC)

Chapter – V : Responsibilities of Contractor in respect of Labour, Supervisory Staff, etc.

	requirements. Contractor shall enable such facilities to BHEL / Customer.
5.10	Contractor shall deploy only qualified and experienced engineers/ supervisors. They shall have professional approach in executing the work.
5.11	The contractor's supervisory staff shall execute the work in the most professional manner in the stipulated time. Accuracy of work and aesthetic finish are essential part of this contract. They shall be responsible to ensure that the assembly and workmanship conform to dimensions and tolerances given in the drawings/instructions given by BHEL engineer from time to time.
5.12	The supervisory staff employed by the contractor shall ensure proper outturn of work and discipline on the part of the labour put on the job by the contractor. Also in general they should see that the works are carried out in a safe and proper manner and in coordination with other labour and staff employed directly by BHEL or other contractors of BHEL or BHEL's client.
5.13	It is the responsibility of the contractor to arrange gate pass for all his employees, T&P etc for entering the project premises. Necessary coordination with customer officials is the responsibility of the contractor. Contractor to follow all the procedures laid down by the customer for making gate passes. Where permitted, by customer / BHEL, to work beyond normal working hours, the contractor shall arrange necessary work permits for working beyond normal working hours.
5.14	The actual deployment will of Labour and Engineer/supervision staff shall be so as to satisfy the erection and commissioning targets set by BHEL. If at any time, it is found that the contractor is not in a position to deploy the required engineers/supervisors/workmen due to any reason, BHEL shall have the option to make alternate arrangements at the contractor's risk and cost. The expenditure incurred along with BHEL overheads thereon shall be recovered from the contractor
5.15	Contractor shall not deploy women labour at night.

SPECIAL CONDITIONS OF CONTRACT (SCC)
Chapter – VI: Material Handling, Storage & preservation

6.0	MATERIAL HANDLING, STORAGE AND PRESERVATION ETC
6.1	MATERIAL HANDLING AND STORAGE
6.1.1	All the equipments/materials furnished under this contract shall be received from the project stores, sheds / storage yards and transported to pre assembly area / erection site and stored in the storage spaces in a manner so that they are easily retrievable till the contractor erects them. While drawing/lifting material from BHEL / customer stores, the contractor shall ensure that the balance / other materials are stacked back immediately. No claim is admissible on this account
6.1.2	While BHEL will endeavor to store / stack / identify materials properly in their open / close / semi closed / tarpaulins covered storage yard / shed, it shall be contractor's responsibility to assist BHEL in identifying materials well in time for erection. They should take the delivery of the same, following the procedure indicated by BHEL, and transport the material safely to pre-assembly yard / erection site in time, according to program.
6.1.3	The contractor shall take delivery of components, equipment / consumables from storage area after getting the approval of BHEL Engineer on standard indent forms.
6.1.4	The contractor shall identify and deploy necessary Engineers / supervisors / workmen for the above work in sufficient number as may be needed by BHEL, for areas covering their scope.
6.1.5	All the equipment shall be handled very carefully to prevent any damage or loss. No untested wire ropes / slings etc. shall be used for unloading / handling. The equipment shall be properly protected to prevent damage either to the equipment or to the floor where they are stored. The equipment from the stores shall be moved to the actual location at the appropriate time so as to avoid damage of such equipment at site.
6.1.6	Contractor shall ensure that while lifting slings shall be put over the points indicated on the equipment or as indicated in the manufacturer's drawings. Slings / shackles of proper size shall be used for all lifting and rigging purposes. All care shall be taken to safe guard the equipment against any damage. Dragging of piping / valves should be avoided. In case of any damage the cost shall be covered from the contractor.
6.1.7	Approach road conditions from the stores / yards to the erection site may not

SPECIAL CONDITIONS OF CONTRACT (SCC)
Chapter – VI: Material Handling, Storage & preservation

	be equipped and ideal for smooth transportation of the equipment. Contractor may have to be adequately prepared to transport the materials under the above circumstances without any extra cost. . The contractor may familiar himself with soil conditions at site.
6.1.8	Contractor shall be responsible for examining all the plant and materials issued to him and notify the Engineer immediately of any damage, shortage, discrepancy etc before they are moved out of the stores / storage area. The contractor shall be solely responsible for any shortages or damages in transit, handling, storage and erection of the equipment once received by him. As the erection work will be spread in different areas / locations of the project, contractor has to arrange sufficient number of watch / ward personal to avoid any pilferage of material
6.1.9	The contractor shall maintain an accurate and exhaustive record-detailing out the list of all equipment received by him for the purpose of erection and keep such record open for the inspection of the engineer at any time.
6.1.10	All the material in the custody of contractor and stored in the open or dusty locations must be covered with suitable weather proof / fire retardant covering material wherever applicable and shall be blocked up on raised level above ground. All covering materials including blocks and sleeper shall be arranged by the contractor at his cost.
6.1.11	If the material belonging to the contractor are stored in area other than those earmarked for his operation the engineer will have the right to get it moved to the area earmarked for the contractor at the contractors risk and cost.
6.1.12	The contractor shall be responsible for making suitable indoor storage facilities to store all equipment (drawn by the contractor from BHEL / customer stores), which require indoor storage till the time of their installation. The Engineer will direct the contractor in this regard, which item in his opinion will require indoor storage, and the contractor shall comply with Engineer's decision.
6.1.13	The contractor shall ensure that all surplus / damaged / scrap / unused material, packing wood / containers/ special transporting frames etc are returned to BHEL at a place in project area identified by the Engineer. The contractor will maintain an account for all items received and returned to BHEL. Any shortage in returning such items shall be chargeable to the contractor except allowable wastage for packing wood only.
6.1.14	The contractor shall hand over all parts / materials remaining extra over the normal requirement with proper identification tags to the stores as directed by

SPECIAL CONDITIONS OF CONTRACT (SCC)
Chapter – VI: Material Handling, Storage & preservation

	the concerned BHEL engineer.
6.1.15	The contractor shall ensure that all the packing materials and protective devices installed on equipment during transit and storage are removed before installation.
6.1.16	It shall be the responsibility of the contractor to keep the work / storage areas in neat, tidy and working conditions. All surplus/unusable packing and other materials shall be removed and deposited at location(s) specified by BHEL within the project premises. If required weighing of the same within the project premises will have to be carried out.
6.2	PRESERVATION OF COMPONENTS
6.2.1	After taking delivery from BHEL / customer's stores, plant materials storage shall be subjected to the following protection besides other provisions indicated in these specifications elsewhere.
6.2.1.1	Items stored outdoors shall be stacked up at least six inches (6") off the ground. Items should not be stored in a low lying area where water logging is a possibility. Contractor should have sufficient numbers of wooden / concrete / steel sleepers for the job.
6.2.1.2	Motors, valves, electrical equipment, control equipment and instruments, and special or precision items requiring special care, etc shall be stored indoors. Motor windings shall be kept dry by use of external heat or space heaters.
6.2.1.3	Bearings and other wearing surfaces of plant materials shall be protected against corrosion and kept clean and should be regularly monitored.
6.2.1.4	Insulation materials shall be stored indoors or otherwise protected against getting wet/ damaged, using suitable measures and should be protected from direct rain.
6.2.2	It shall be the responsibility of the contractor to apply preservatives / touch up paints (primer) on equipment handled and erected by him till such time of final painting. It shall be contractor's responsibility to arrange for required paints (primer), thinners, labour, scaffolding materials, cleaning materials like wire brush, emery sheets, etc, cleaning of surface and provide one coat of preservatives / paints (primer) from time to time as decided by BHEL engineer. The accepted rate shall include this work also. It is to be noted that such painting may have to be done as and when required till such time the final painting is carried out.
6.2.3	The contractor shall effectively protect the finished work from action of weather

SPECIAL CONDITIONS OF CONTRACT (SCC)
Chapter – VI: Material Handling, Storage & preservation

	and from damage or defacement and shall cover the finished parts then and there for their protection.
6.2.4	Any failure on the part of contractor to carry out works according to above clauses will entail BHEL to carry out the job from any other party and recover the cost from contractor.

SPECIAL CONDITIONS OF CONTRACT (SCC)
Chapter – VII: Drawings and documents

7.0	DRAWINGS AND DOCUMENTS
7.1	The detailed drawings, specifications available with BHEL engineers will be made available to the contractor during execution of work at site. The contractor will also ensure availability of all drawings / documents at work place.
7.2	Necessary drawings to carry out the erection work will be furnished to the contractor by BHEL on loan, which shall be returned to BHEL Engineer at site after completion of work. Contractor shall ensure safe storage and quick retrieval of these documents.
7.3	The contractor shall maintain a record of all drawings and documents available with him in a register as per format given by BHEL Engineer. Contractor shall ensure use of pertinent drawings / data / documents and removal of obsolete ones from work place and returning to BHEL.
7.4	The data furnished in various annexure enclosed with this tender specification are only approximate and for guidance. However, the change in the design and in the quantity may occur as is usual in any such large scale of work. The contractors quoted rates shall be inclusive of the above factor
7.5	Should any error or ambiguity be discovered in the specification or information the contractor shall forthwith bring the same to the notice of BHEL before commencement of work. BHEL's interpretation in such cases shall be final and binding on the contractor.
7.6	Deviation from design dimensions should not exceed permissible limit. The contractor shall not correct or alter any dimension / details, without specific approval of BHEL.

SPECIAL CONDITIONS OF CONTRACT (SCC)
Chapter – VIII: Inspection and Quality

8.0	INSPECTION AND QUALITY
8.1	Inspection, Quality Assurance, Quality Control
8.1.1	Preparation of quality assurance log sheets and protocols with customer/ consultants/statutory authority, welding logs, NDE records, testing & calibration records and other quality control and quality assurance documentation as per BHEL engineer's instructions, is within the scope of work/specification. These records shall be submitted to BHEL/customer for approval from time to time.
8.1.2	The protocols between contractor and customer/ BHEL shall be made prior to installation for correctness of foundations, materials, procedures, at each stage of installation, generally as per the requirement of customer/ BHEL. This is necessary to ensure elimination of errors or keeping them within tolerable limits and to avoid accumulation and multiplication of errors.
8.1.3	<p>A daily log book should be maintained by every supervisor/engineer of contractor on the job in duplicate (one for BHEL and one for contractor) for detailing and incorporating alignment/clearance / centering / leveling readings and inspection details of various equipments etc.</p> <p>High pressure welding details like serial number of weld joints, welders name, date of welding, details of repair, heat treatment etc. will be documented in welding log as per BHEL Engineer's instructions.</p> <p>Record of radiography containing details like serial number of weld joints, date of radiography, repairs, if any, re-shots etc shall also be maintained as per BHEL Engineer's instructions.</p> <p>Record of heat treatments performed shall be maintained as prescribed by BHEL</p>
8.1.4	The performance of welders will be reviewed from time to time as per the BHEL standards. Welders' performance record shall be furnished periodically furnished for scrutiny of BHEL's Engineer. Corrective action as informed by BHEL shall be taken in respect of those welders not conforming to these standards. This may include removal/ discontinuance of concerned welder(s). Contractor shall arrange for the alternate welders immediately
8.1.5	All the welders shall carry identity cards as per the proforma prescribed by BHEL/Customer/Consultant. Only welders duly authorized by

SPECIAL CONDITIONS OF CONTRACT (SCC)

Chapter – VIII: Inspection and Quality

	BHEL/customer/consultant shall be engaged on the work.
8.1.6	Contractor shall provide all the Measuring Monitoring Equipments (MMEs) required for completion of the work satisfactorily. These MMEs shall be of brand, quality and accuracy specified by BHEL Engineer and should have necessary calibration and other certificates as per the requirement of BHEL Engineer. Decision of BHEL Engineer regarding acceptance or otherwise of the measuring instruments/gauges/tools for the work under this specification, is final and binding on the contractor. BHEL may give an indicative list of MMEs required for this work and to be made available by the contractor. The list will be reviewed by BHEL and the contractor shall meet any augmentation needed wherever required.
8.1.7	It is the responsibility of the contractor to prove the accuracy of the testing/measuring/calibrating equipments brought by him based on the periodicity of calibration as called for in the BHEL's quality assurance standards/BHEL Engineer's instructions.
8.1.8	Any re-laying or re-termination of cables/re-erection of instruments/recalibration of instruments etc. required due to contractor's mistake or design requirement and found at any stage inspection, shall be carried out by the contractor at no extra cost.
8.1.9	BHEL, Power Sector Regions (PSNR/PSER/PSWR/PSSR) have already been accredited with ISO 9001 certification and as such this work is subject to various audits to meet ISO 9001 requirements. One particular aspect which needs special mention is about arrangement of calibration of instruments by the contractor. Contractor shall ensure deployment of reliable and calibrated MMEs (Measuring and Monitoring Equipments). The MMEs shall have test / calibration certificates from authorised / Government approved / Accredited agencies traceable to National / International Standards. Re-testing / re-calibration shall also be arranged at regular intervals during the period of use as advised by BHEL Engineer within the contract price. The contractor will also have alternate arrangements for such MMEs so that work does not suffer when the particular equipment / instrument is sent for calibration. Also if any MMEs not found fit for use, BHEL shall have the right to stop the use of such item and instruct the contractor to deploy proper item and recall ie repeat the readings taken by that instrument, failing which BHEL may deploy MME and retake the readings at Contractor's cost.
8.1.10	Re-work necessitated on account of use of invalid MMEs shall be entirely to the

Bharat Heavy Electricals Limited
Power Sector – Eastern Region, Kolkata

VOLUME-ID

TENDER NO. PSER:SCT:BAR-C1971:19

PAGE 22 OF 47

SPECIAL CONDITIONS OF CONTRACT (SCC)
Chapter – VIII: Inspection and Quality

	contractor's account. He shall be responsible to take all corrective actions, including resource augmentation if any, as specified by BHEL to make-up for the loss of time.
8.1.11	In the courses of erection, it may become necessary to carry repeated checks of the work with instruments recently calibrated, re-calibrated. BHEL may counter/ finally check the measurements with their own MMEs. Contractor shall render all assistance in conduct of such counter/final measurements.
8.1.12	Total Quality is the watchword of the work and Contractor shall strive to achieve the Quality Standards, procedures laid down by BHEL. He shall follow all the instructions as per BHEL drawings and Quality Standards.
8.2	Stage Inspection By FES/QA Engineers
8.2.1	Apart from day-to-day inspection by BHEL Engineers stationed at Site and Customer's Engineers, stage inspection of equipments under erection and commissioning at various stages shall also be conducted by teams of Engineers from Field Engineering Services of BHEL's Manufacturing Units, Quality Assurance teams from Field Quality Assurance, Unit/Factory Quality Assurance and Commissioning Engineers from Technical Services etc. Contractor shall arrange all labour, tools and tackles etc along with proper access for such stage inspections free of cost.
8.2.2	Any modifications suggested by BHEL FES and QA Engineers' team shall be carried out. Claims of contractor, if any, shall be dealt as per Section 13, and provided such modifications have not arisen for reasons attributable to the contractor.
8.3	Statutory Inspection of Work
8.3.1	The work to be executed under these specifications has to be offered for inspection, at appropriate stages of work completion, to various statutory authorities for compliance with applicable regulations. The work related statutory inspections, though not limited to, are as under: <ol style="list-style-type: none"> 1) Inspectorate of Steam Boilers and Smoke Nuisance 2) Electrical Inspector 3) Factory Inspector, Labour Commissioner, PF Commissioner and other authority connected to this project work

SPECIAL CONDITIONS OF CONTRACT (SCC)
Chapter – VIII: Inspection and Quality

	The scope includes getting the approvals from the statutory authorities, which includes arranging for inspection visits of statutory authority periodically as per BHEL Engineer's instructions, arranging materials for ground inspection, taking rub outs for the pressure parts to be offered for inspection, submitting co-related inspection reports, documents, radiographs etc and following up the matter with them. Contractor shall also make all arrangements for offering the Products / Systems for inspection at location, as applicable, to the concerned authority.
8.3.2	Contractor should be qualified to execute pressure parts & piping work coming under the purview of IBR, for which he should register himself with CIB of state concerned. contractor also should be aware of the latest IBR regulations and Electricity Act, including the amendments thereof.
8.3.3	Contractor shall comply with 'Qualification Tests for welders engaged in welding of Boilers and Steam Pipes under Construction, Erection and Fabrication at Site in India and in repairing Boilers and steam pipes by welding' in line with Chapter XIII of Indian Boiler Regulations-1950, for testing his welders / men / workers, including all associated fees, procedures, required instruments and equipments and their calibration there of. It shall be contractor's responsibility to obtain approval of Statutory Authorities, wherever applicable, for the conducting of any work which comes under the purview of these authorities, at his cost.
8.3.4	The following fees shall be excluded from scope of Contractor: 1. Registration Fee as per Regulation 385 of Chapter IX of Indian Boiler Regulations-1950 2. Fees for inspection of Boiler at the site of Construction as per Regulation 395 A, sl no 4 of Chapter IX of Indian Boiler Regulations-1950 However all other fees like visit fees charged by the Boiler Inspector and other arrangements for his visit or visits till satisfactory completion of work, shall be included in scope of Contractor
8.4	The Quality Management System of BHEL, Power Sector Regions (PSNR/PSER/PSWR/PSSR) have already been certified and accredited under ISO 9002 standards in this regard. The basic philosophy of the Quality Management System is to define the organizational responsibility, work as per

SPECIAL CONDITIONS OF CONTRACT (SCC)
Chapter – VIII: Inspection and Quality

	documented procedures, verify the output with respect to acceptance norms, identify the non-conforming product/ procedure and take corrective action for removal of non-conformance specifying the steps for avoiding recurrence of such non-conformities, & maintain the relevant quality records. The nonconformities are to be identified through the conduct of periodical audit of implementation of quality systems at various locations/stages of work. Suppliers/vendors of various products/services contributing in the work are also considered as part of the quality management system. .as such the contractor is expected not only to conform to the quality management system of BHEL but also it is desirable that they themselves are accredited under any quality management system standard.
8.5	Field Quality Assurance
8.5.1	Contractor shall carry out all activities conforming to the approved Field Quality Plan (FQP) as revised from time to time. Total quality shall be the watchword of the work and contractor shall strive to achieve the quality standards, procedures laid down by BHEL. He shall follow all the instructions as per BHEL drawings and quality standards. Contractor shall provide the services of quality assurance engineer as per the relevant clauses.

SPECIAL CONDITIONS OF CONTRACT (SCC)
Chapter - IX: HSE & OHSAS

9.0	<p>OCCUPATIONAL HEALTH, SAFETY & ENVIRONMENT MANAGEMENT/ QUALITY ASSURANCE PROGRAMME: BHEL, Power Sector Regions (PSNR/ER/WR/SR) are each certified for ISO 9001. Quality of work to customer's satisfaction and fulfillment of system requirements are the essence of ISO 9001 certification. BHEL, PS Regions have HSE certification (ISO 14001 & OHSAS 18001) and therefore Contractor also shall organise/ plan/ perform all their activities to meet with the applicable requirements of these standards.</p>
9.1	<p>HSE (Health, safety & Environment): Contractor will comply with HSE (Health, safety & Environment) requirements of BHEL. HSE requirements in brief, are given below :-</p>
9.1.1	<p>Contractor will nominate one of their qualified and experienced employees as Safety Officer, who will be responsible for all HSE related issues of contractors work area. Safety Officer will have authority to stop any activity, in case he observes that the activity is not being carried out in safe manner. He will conduct surprise inspection as well as periodic inspection/drill (at least once in a month) and submit such reports to BHEL. He will conduct periodic meetings with supervisors of different working groups and explain HSE issues and use of PPEs to them. Reports of such meetings will be submitted to BHEL. Contractor will develop suitable work procedures based upon HSE guidelines and OCPs and implement it. Such work procedures will consist of Area of work, T&P Details, Work Procedure, PPE requirements etc. Please refer Schedule VIII of BOCW Rules for number of safety officers, qualification, duties etc.</p> <p>Contractor should highlight the requirement of safety to staff and labour through daily tool box meeting before start of the days job.</p> <p>Contractor to also submit monthly safety reports as per the format/procedure of BHEL.</p>
9.1.2	<p>The contractor shall arrange induction and regular health check of their employees as per schedule VII of BOCW rules by aregistered medical practitioner. The contractor shall take special care of the employees affected with occupational diseases under rule 230 and schedule II of BOCW Rules. The employees not meeting the fitness requirement should not be engaged for such job</p>
9.1.3	<p>Following personnel protective equipments (PPEs), in adequate numbers, will</p>

SPECIAL CONDITIONS OF CONTRACT (SCC)
Chapter - IX: HSE & OHSAS

	be made available at site & their regular use by all concerned will be ensured :-
	- HELMET
	- SAFETY GOGGLES & WELDING FACE SHIELDS
	- SAFETY BELTS AND PROTECTIVE NET FOR WORKING AT HEIGHT
	- SAFETY SHOES
	- EAR PLUG
	- ANY OTHER SAFETY EQUIPMENT REQUIRED FOR SAFE COMPLETION OF THE WORK
	Contractor to also submit monthly reports on above as per the format/procedure of BHEL.
9.1.4	Providing appropriate First Aid facilities for prompt treatment of injuries and illness at work place. Arranging training to contractor workmen/ employees for giving first aid.
9.1.5	Arranging ambulance in case of any emergency situation .
9.1.6	Identification of nearest hospital and health check-up of workmen/employees
9.1.7	Providing filtered drinking water at work place in cool container.
9.1.8	Providing Canteen, Rest Room, Washing facilities to the contracted employees as per provisions of Contract Labour Regulation Act 1970 (Chapter V).
9.1.9	Providing appropriate fire fighting equipment at designated work place and nominate a fire officer/warden adequately trained for his job.
9.1.10	Identification of nearest fire station and display contact telephone nos. / person's name around work places for cases of emergencies .
9.1.11	Providing adequate no. of 24 V sources and ensure that no hand lamps are operating at voltage level above 24 Volts.
9.1.12	Fulfilling safety requirements at all power tapping points.
9.1.13	Red & White caution tape of proper width(1.5 to 2 inch) to be used for cordoning unsafe area such as open trench, excavation area etc.
9.1.14	Providing contractors company logo on cloths /uniform/ proper identity cards with photographs, for correct identification of people working at project site .
9.1.15	High/ Low pressure welders to be identified with separate colourclothings. No welders will be deployed without passing appropriate tests and holding valid welding certificates. Approved welding procedure should be displayed at work place.
9.1.16	Displaying safe handling procedures for all chemicals such as lube oil, acid, alkali, sealing compounds etc , at work place .

SPECIAL CONDITIONS OF CONTRACT (SCC)

Chapter - IX: HSE & OHSAS

9.1.17	All scaffolding/ platforms should be made from materials of appropriate quality/grade so that these are safe for use. It should be certified/declared safe for use by an experienced contractor person, before any scaffolding/platform is used. Please refer IS:3696 part 1&2 and 4014 part 1 & 2
9.1.18	All T&Ps/ MMEs should be of reputed brand/appropriate quality & must have valid test/calibration certificates bearing endorsement from competent authority of BHEL.. Contractor to also submit monthly reports of T&Ps deployed and validity test certificates to BHEL safety Officer as per the format/procedure of BHEL.
9.1.19	Ensure that the regulatory requirement of excessive weight limit (to carry/lift/ move weights beyond prescribed limits) for male and female workers are complied with.
9.1.20	Safety slogan, Safety/ Caution boards , wherever required to be displayed in consultation with BHEL.
9.1.21	Take suitable measures for waste management and environment related laws/legislation as a part of normal construction activities. Compliance with the legal requirements on storage/ disposal of paint drums (including the empty ones), Lubricant containers, Chemical Containers, and transportation and storage of hazardous chemicals will be strictly maintained. Ensure proper cleanliness of work place, housekeeping and waste management (including proper waste disposal) on daily basis.
9.1.22	It is imperative on the part of the contractor to join and effectively contribute in joint measures such as tree plantation, environment protection, contributing towards social upliftment, conversion of packing woods to school furniture, keeping good relation with local populace etc.
9.1.23	The contractor shall carry out periodic air and water quality check and illumination level checking in his area of work place and take suitable control measure.
9.1.24	The Contractor is required to provide proper safety net systems (IS-11057) where ever the hazard of fall from height is present as per instruction of BHEL Engineer. The safety nets shall be fire resistant, duly tested and shall be of ISI Mark and the nets shall be located as per site requirements to arrest or to reduce the consequences of a possible fall of persons working at different heights.
9.1.25	All applicable OCPs (Operational control procedures) will be followed by contractor as per BHEL instructions. This will be done as part of normal scope of work. List of such OCPs is given below . In case any other OCP is found to

SPECIAL CONDITIONS OF CONTRACT (SCC)

Chapter - IX: HSE & OHSAS

	<p>be applicable during the execution of work at site, then contractor will follow this as well, within quoted rate. These OCPs (applicable ones) will be made available to contractor during work execution at site. However for reference purpose, these are kept with Safety Officer of BHEL at the Power Sector Regional HQ, or available in downloadable format in the website, which may be refereed by contractor, if they so desire.</p>
■	OCP for safe handling of chemicals
■	OCP for Electrical safety
■	OCP for energy conservation
■	OCP for safe welding and gas cutting operation
■	OCP for fire safety
■	OCP for safety in use of hand tools
■	OCP for first aid
■	OCP for food safety at canteen
■	OCP for safety in use of cranes
■	OCP for storage and handing of gas cylinders
■	OCP for manual arc welding
■	OCP for safe use of helmets
■	OCP for good house keeping
■	OCP for working at height
■	OCP for safe excavation
■	OCP for safe filling of Hydrogen in cylinder
■	OCP for illumination
■	OCP for handling and erection of heavy metals
■	OCP for safe acid cleaning
■	OCP for safe alkali boil out
■	OCP for safe oil flushing
■	OCP for steam blowing
■	OCP for safe working in confined area
■	OCP for safe operation of passenger lift, material hoists & cages
■	OCP for Vehicle maintenance
■	OCP for safe radiography
■	OCP for waste disposal
■	OCP for working at night
■	OCP for blasting
■	OCP for DG Set
■	OCP for handling & storage of mineral wool

SPECIAL CONDITIONS OF CONTRACT (SCC)
Chapter - IX: HSE & OHSAS

	<ul style="list-style-type: none"> ■ OCP for drilling, reaming and grinding(machining) etc. ■ OCP for hydraulic test ■ OCP for spray insulation ■ OCP for trial run of rotary equipment ■ OCP for stress relieving ■ OCP for material preservation ■ OCP for cable laying/tray work ■ OCP for electrical maintenance ■ OCP for transformer charging ■ OCP for safe handling of battery system ■ OCP for computer operation ■ OCP for storage in open yard ■ OCP for sanitary maintenance ■ OCP for batching ■ OCP for piling rig operation ■ OCP for gas distribution test ■ OCP for cleaning of hotwell / deaerator ■ OCP for electro-resistance heating ■ OCP for compressor operation ■ OCP for O&M of control of AC plant & system ■ OCP for air compressor ■ OCP for passivation ■ OCP for Safe EDTA Cleaning ■ OCP for Safe Chemical cleaning of Pre boiler system ■ OCP for Safe Boiler Light up ■ OCP for Safe Rolling and Synchronisation ■ OCP for Safe Loading of Unit
9.2	<p>SAFETY AND CLEANLINESS :</p> <p>The contractor shall take all necessary safety precautions and arrange for appropriate appliances as per discretion of BHEL or its authorised officials (Site Construction Manager) to prevent loss of human lives, injuries, to personnel engaged and damage to property. Before commencing the work, the contractor shall submit a "Safety Plan" to the above authorised BHEL official and obtain approval on the same. The safety plan shall indicate in detail the measures that would be taken by the contractor to ensure safety of men, equipment, materials and environment during execution of the work. This will also include an organization structure, role and responsibilities of the concerned key</p>

SPECIAL CONDITIONS OF CONTRACT (SCC)

Chapter - IX: HSE & OHSAS

	personnel, the safety practices that will be followed, PPEs deployed, plan for handling critical activities and emergencies.
9.3	If the contractor fails to take appropriate safety precautions or to provide necessary safety devices and equipment or to carry out instructions issued by the authorised BHEL official, BHEL shall have the right to take corrective steps at the risk and cost of the contractor.
9.4	During the course of construction, alternation or repairs, scrap with protruding nail, sharp edge etc and all other debris shall be kept clean from working areas, passage, ways and stairs in and around site.
9.5	Combustible scrap and debris shall be removed at regular intervals during the course of execution. Safe means shall be provided to facilitate such removal. The combustible scrap should be stored in safe place away from the plant materials to avoid fire accidents. The area shall be chosen in consultation with the Engineer and to be cordoned off.
9.6	Rigging equipment for materials handling shall be inspected prior to use in each shift and as necessary during its use to ensure that it is safe. Defective rigging equipment will be removed from service.
9.7	Rigging equipment shall not be loaded in excess of its recommended safe working load. Rigging equipment, when not in use, shall be removed from the original work area so as not to present a hazard to employees.
9.8	Contractor shall notify the engineer, of his intention to bring on to site any equipment or any container, with liquid or gaseous fuel or other substance which may create a hazard. The Engineer shall have the right to prescribe the condition under which such equipment or container may be handled and used during the performance of the works and the contractor shall strictly adhere to such instructions. The Engineer shall have the right to inspect any construction tool and to forbid its use, if in his opinion it is unsafe. No claim due to such prohibition will be entertained.
9.9	Where it is necessary to provide and/or store petroleum products or petroleum mixture & explosives, the contractor shall be responsible for carrying out such provision / storage in accordance with the rules & regulations laid down in the relevant petroleum act, explosive act and petroleum and carbide of calcium manual, published by the chief inspector of explosives of India. All such storage shall have prior approval if necessary from the chief inspector of explosives or any other statutory authority. The contractor shall be responsible for obtaining

Bharat Heavy Electricals Limited

Power Sector – Eastern Region, Kolkata

VOLUME-ID

TENDER NO. PSER:SCT:BAR-C1971:19

PAGE31OF47

SPECIAL CONDITIONS OF CONTRACT (SCC)
Chapter - IX: HSE & OHSAS

	the same.
9.10	Cylinders shall be moved by tilting and rolling them on their bottom edges. They shall not be intentionally dragged, struck or permitted to strike each other violently.
9.11	When cylinders are transported by powered vehicle they shall be secured in a vertical position.
9.12	All workmen of the contractor working on construction area shall wear safety shoes, hand gloves, safety helmets and safety belt as applicable. The contractor shall provide to its workforce and ensure the use of following personnel protective equipment as found necessary and as directed by BHEL.
9.12.1	Safety Helmets conforming to IS-2925 : 1984
9.12.2	Safety Belts conforming to IS-3521:1983
9.12.3	Safety Shoes conforming to IS-1989 : 1978
9.12.4	Eye and face protection devices conforming to IS – 1179:1967, IS 5983:1980, IS 8521 Part 1:1977, IS 8521 Part 2: 1994.
9.12.5	Hand and body protection devices conforming to IS 4770:1991 and IS- 6994 : Part 1: 1973, IS – 8619 : 1977
9.12.6	Ear protection IS-9167:1979
9.12.7	Respiratory Protective Devices as per IS-9473:2002, i4746:1999 and 14166:1994
9.13	The contractor shall insure his workmen against all accidents and the policy shall be presented to BHEL Engineer on demand. Other wise, BHEL will arrange the same and the expenditure towards this will be debited to the contractor. In case of a fatal or disabling injury accident to any person at construction site due to lapses by the contractor, the victim and/or his/her dependants shall be compensated by the contractor as per statutory requirements. However, if considered necessary BHEL shall have the right to impose appropriate financial penalty on contractor and recover the same from payments due to the contractor for suitably compensating the victim and/or his/her dependence before imposing any such penalty. Appropriate enquiry shall be held by BHEL giving opportunity to the contractor for presenting his case. Above safety conditions are not exhaustive but gives an idea for the contractor and contractor shall adhere to all safety precaution given by the

SPECIAL CONDITIONS OF CONTRACT (SCC)
Chapter - IX: HSE & OHSAS

	Engineer at site.
9.14	The contractor shall arrange at his cost adequate lighting facilities e.g. flood lighting, hand lamps, area lighting etc. at various levels for safe and proper working operations during night hours at the work spot as well as at the pre-assembly area.
9.15	The contractor shall be responsible for provision of all the safety notices and safety equipment as enjoined on him by the application of relevant statutory regulation / provisions and/or as called upon by BHEL from time to time. He shall be held responsible for any violation of statutory regulations (local, state or central) and BHEL instruction that may endanger safety of men, equipment and material.
9.16	The contractor shall provide temporary fencing wherever required as a safety measure against accident and damage to properties. Suitable caution notices shall be displayed where access to any part is found to be unsafe and hazardous.
9.17	Contractor shall ensure safety of all the workmen, material and equipment either belonging to him or to others working at site. He shall observe safety rules and codes applied by BHEL without exception.
9.18	It will be the responsibility of the contractor to ensure safe lifting of the equipment, taking due precaution to avoid any accident and damage to other equipment and personnel. All requisite tests and inspection of handling equipment, tools & tackle shall be periodically done by the contractor by engaging only the COMPETENT PERSONS as per law. Defective equipment or uncertified shall be removed from service. Any equipment shall not be loaded in excess of its recommended safe working load.
9.19	The contractor shall provide necessary first aid facilities as per schedule III. In addition, ambulance facilities, OHC and CMO as per schedule IV, V, X and XI of BOCW Rules as applicable for all his employees, representatives and workmen at site and BHEL shall have no obligation in this regard. The first aid boxes should be placed at various elevations so as to make them available within the reach and at the quickest possible time. The contractor should conduct periodical first –aid classes to keep his supervisor and Engineers properly trained for attending to any emergency.
9.20	Training

SPECIAL CONDITIONS OF CONTRACT (SCC)
Chapter - IX: HSE & OHSAS

9.20.1	The contractor shall arrange induction safety training for all employees before assigning work. In addition, awareness programme, mock drill at regular intervals and daily tool box meetings shall be arranged. Monthly report of the above to be given to BHEL safety Officer as per prescribed BHEL formats
9.20.2	All the contractor's supervisory personnel and sufficient number of workers shall be trained for fire protection systems. Enough number of such trained personnel must be available during the tenure of contract. Contractor should nominate his supervisor to coordinate and implement the safety measures.
9.21	Contractor shall provide enough fire protecting equipment of the types and numbers at his office, stores, temporary structure in labour colony etc. Such fire protection equipment shall be easy and kept open at all times. The fire extinguishers shall be properly refilled and kept ready which should be certified at periodic intervals. The date of changing should be marked on the Cylinders. All other fire safety measures as laid down in the "codes for fire safety at construction site" issued by safety coordinator of BHEL shall be followed. Non-compliance of the above requirement under fire protection shall in no way relieve the contractor of any of his responsibility and liabilities to fire accident occurring either to his materials or equipment or those of others. Emergency contacts nos must be displayed at prominent locations
9.22	The contractor shall at his cost, remove from vicinity of work at least once each day all combustible waste, scrap, panting materials, rubbish, unused or other materials and deposit them in places specified by BHEL to keep the work site clear and tidy. Use of undercoated canvas paper, corrugated paper, fabricated carton, plastic or other flammable materials shall be restricted to the minimum and promptly removed.
9.23	The contractor shall not use any hand lamp energized by Electric power with supply voltage of more than 24 volts in confined spaces like inside water boxes, turbine casings, condensers etc.
9.24	All portable electric tools used by the contractor shall have safe plugging system to source of power and be appropriately earthed. Only electricians licensed by appropriate statutory authority shall be employed by the contractor to carry out all types of electrical works. Details of earth resource ad their test date to be given to BHEL safety officer as per the prescribed formats of BHEL
9.25	In case of any delay in completion of a job due to mishaps attributable to lapses by the contractor, BHEL shall have the right to recover cost of such delay from

SPECIAL CONDITIONS OF CONTRACT (SCC)
Chapter - IX: HSE & OHSAS

	the payments due to the contractor, after notifying the contractor suitably.
9.26	Valve protection caps shall be kept in place and secured.
9.27	The contractor shall be responsible for the safe storage and handling of his radio-active sources as per BARC rules and regulations.
9.28	Tarpaulin being inflammable should not be used (instead, only non infusible covering materials shall be used) as protective cover while preheating, welding, stress relieving etc. at site.
9.29	If the contractor fails to improve the standards of safety in its operation to the satisfaction of BHEL after being given reasonable opportunity to do so and/or if the contractor fails to take appropriate safety precautions or to provide necessary safety devices and equipment or to carry out instruction regarding safety issued by BHEL, BHEL shall have the right to take corrective steps at the risk and cost of the contractor after giving a notice of not less than 7 days indicating the steps that would be taken by BHEL.
9.30	If the contractor succeeds in carrying out its job in time with out any fatal or disabling injury accident and without any damage to property BHEL may, at its sole discretion, favorably consider to reward the contractor suitably for the performance.
9.31	The contractor shall carefully follow the safety requirement of BHEL/ the purchaser with the regard to voltages used in critical areas.
9.32	The contractor shall use only properly insulated and armored cables which conform to the requirement of Indian Electricity Act and Rules for all wiring, electrical applications at site. BHEL reserves the right to replace any unsafe electrical installations, wiring, cabling etc. at the cost of the contractor. All electrical appliances used in the work shall be in good working condition and shall be properly earthed. No maintenance work shall be carried out on live equipment. The contractor shall maintain adequate number of qualified electricians to maintain his temporary electrical installations. Area wise Electrical safety inspection is to be carried out on monthly basis as per "Electrical Safety Inspection checklist" and the report is to be submitted to BHEL safety officer
9.33	The contractor shall arrange adequate number of persons specifically for clearing any debris and for house keeping of the erection area including restacking of components in the erection areas. Housekeeping to be carried out

SPECIAL CONDITIONS OF CONTRACT (SCC)

Chapter - IX: HSE & OHSAS

	as per BHEL's checklist and report is to be submitted to BHEL safety officer
9.34	In case of any damage to property due to lapses by the contractor, BHEL shall have the right to recover the cost of such damages from the contractor after holding an appropriate enquiry.
9.35	The contractor shall submit report of all accidents, fires and property damage etc to the Engineer immediately after such occurrence, but in any case not later than 24 hours of the occurrence. Such reports shall be furnished in the manner prescribed by BHEL. In addition periodic reports on safety shall also be submitted by the contractor to BHEL from time to time as prescribed by the Engineer. Compiled monthly reports of all kinds of accidents, fires and property damage to be submitted to BHEL safety officer as per prescribed formats
9.36	Before commencing the work, the contractor shall appoint/nominate a responsible person to supervise implementation of all safety measures and liaison with his counterpart of BHEL.
9.37	Suitable scaffolds shall be provided for workman for all works that cannot safely be done from the ground, or from solid construction except in the case of short duration of work which can be done safely from ladders. When a ladder is used, it shall be of rigid construction made of steel. The steps shall have a minimum width of 45 cm and a maximum rise of 30 cm. Suitable handholds of good quality wood or steel shall be provided and the ladder shall be given an inclination not steeper than ¼ horizontal and 1 vertical.
9.38	Scaffolding or staging more than 3.6 m above the ground floor, swung or suspended from an overhead support or erected with stationery support shall have a guard rail properly bolted, braced or otherwise secured, at least 90 cm above the floor or platform of such scaffolding or staging and extending along the entire length of the out side and ends thereof with only such openings as may be necessary for the delivery of materials. Such scaffolding or staging shall be so fastened as to prevent it from swaying, from the building or structure.
9.39	Working platforms, gangways and stairways shall be so constructed that they do not sag unduly or unequally and if the height of the platform gangways provided is more than 3.6 m above ground level or floor level, they shall be closely boarded and shall have adequate width which shall not be less than 750 mm and be suitably fenced as described above.

SPECIAL CONDITIONS OF CONTRACT (SCC)

Chapter - IX: HSE & OHSAS

9.40	Every opening in the floor or a building or in a working platform shall be provided with suitable means to prevent the fall of persons or materials by providing suitable fencing or railing whose minimum height shall be 90 cm.
9.41	Wherever there are open excavation in ground, they shall be fenced off by suitable railing and danger signals installed at night so as to prevent persons slipping into the excavations.
9.42	Safe means of access shall be provided to all working places. Every ladder shall be securely fixed. No portable single ladder shall be over 9 m in the length while the width between side rails in rung ladder shall in no case be less than app. 29.2 cm for ladder upto and including 3 m in length. For longer ladders this width shall be increased at least ¼” for each additional foot of length.
9.43	A sketch of the ladders and scaffolds proposed to be used shall be prepared and approval of the Engineer obtained prior to Construction.
9.44	All personnel of the Contactor working within the plant site shall be provided with safety helmets. All welders shall wear welding goggles while doing welding work and all metal worker shall be provided with safety gloves. Persons employed on metal cutting and grinding shall wear safety glasses.
9.45	Adequate precautions shall be taken to prevent danger for electrical equipment. No materials on any of the sites of work shall be so stacked or placed as to cause danger or inconvenience to any person or the public.
9.46	All trenches, four feet or more in depth, shall at all times be supplied with at least one ladder for each 30 m in length or fraction thereof. The ladder shall be extended from bottom of the trench to at least 90 cm above the surface of the ground. Sides of the trenches which are 1.50 m or more in depth shall be stepped back to give suitable slope or securely held by timer bracing, so as to avoid the danger of sides collapsing. The excavated materials shall not be placed within 1.5 m of the edges of the trench or half of the depth of the trench whichever is more. Cutting shall be done from top to bottom. Under no circumstances undermining or undercutting shall be done.
9.47.1	The contractor shall take permission of BHEL prior to risky jobs such as working at height, hot work, liftig activities, etc through permits. No job should be started without permits.
9.47.2	The Contactor shall take all measures at the sites of the work to protect all persons from accidents and shall be bound to bear the expenses of defense of

SPECIAL CONDITIONS OF CONTRACT (SCC)

Chapter - IX: HSE & OHSAS

	every suit, action or other proceeding at law that may be brought by any persons for injury sustained or death owing to neglect of the above precautions and to pay any such persons such compensation or which may with the consent of the Contractor be paid to compromise any claim by any such person should such claim proceeding be filed against BHEL, the Contractor hereby agrees to indemnify BHEL against the same.
9.48	Before any demolition work is commenced and also during the process of the work the following shall be ensured:
9.48.1	All roads and open areas adjacent to the work site shall either be closed or suitably protected.
9.48.2	No electric cable or apparatus which is liable to be a source of danger nor a cable or an apparatus used by the operator shall remain electrically charged.
9.48.3	All practical steps shall be taken to prevent danger to persons employed from the risks of fire or explosion or flooding. No floor, roof or other part of the building shall be so overloaded with debris or materials as to render them unsafe.
9.49	All necessary personnel safety equipment as considered adequate by the Engineer should be kept available for the use of the persons employed in the Site and maintained in a condition suitable for immediate use and the Contractor should take adequate steps to ensure proper use of equipment by those concerned.
9.49.1	Workers employed on mixing asphalted materials, cement and lime mortars shall be provided with protective foot wear and protective goggles.
9.49.2	Those engaged in white washing and mixing or stacking of cement bags or any materials which is injurious to the eyes shall be provided with protective goggles.
9.49.3	Those engaged in welding works shall be provided with welder's protective eyesight lids.
9.49.4	Stone breakers shall be provided with protective goggles and protective clothing and seated sufficient to safe intervals.
9.49.5	Where workers are employed in sewers and manholes, which are in use, the Contractor shall ensure that the manhole covers are opened and ventilated at least for an hour before the workers are allowed to get into manhole, and the manholes so opened shall be cordoned off with suitable railing and provided

Bharat Heavy Electricals Limited
Power Sector – Eastern Region, Kolkata

VOLUME-ID

TENDER NO. PSER:SCT:BAR-C1971:19

PAGE38OF47

SPECIAL CONDITIONS OF CONTRACT (SCC)
Chapter - IX: HSE & OHSAS

	with warning signals or boards to prevent accident to the public.
9.49.6	The Contractor shall not employ men below the age of 18 years and women on the work of painting with products containing lead in any form. Wherever men above the age of 18 are employed on the work of lead painting, the following precautions should be taken.
9.49.6.1	No paint containing lead or lead products shall be used except in the form of paste or ready made paint.
9.49.6.2	Suitably face masks should be supplied for use by the workers where paints are applied in the form of spray or a surface having lead paint dry rubbed and scrapped.
9.49.6.3	Overalls shall be supplied by the Contractor to the workmen and adequate facilities shall be provided to enable the working painters to wash during the cessation of work.
9.50	When the work is being done near any place where there is risk of drowning all necessary equipment should be provided and kept ready for use and all necessary steps taken for prompt rescue of any person in danger and adequate provision should be made for prompt first aid treatment of all injuries likely to be sustained during the course of the work.
9.51	Motors, gearing, transmission, electric wiring and other dangerous parts of hoisting appliances should be provided with efficient safe guards. Hoisting appliance should be provided with such means as will reduce to the minimum the risk of any part of a suspended load becoming accidentally displaced. When workers employed on electrical installations which are already energized, insulating mats, wearing apparel, such as gloves, sleeves and boots as may be necessary should be provided. The worker should not wear any rings, watches and carry keys or other materials which are good conductor of electricity.
9.52	All scaffolds, ladders and other safety devices mentioned or described herein shall be maintained in safe condition and no scaffold, ladder or equipment shall be altered or removed while it is in use. Adequate washing facilities should be provided at or near the places of work.
9.53	The contractor shall maintain and ensure necessary safety measures as required for inspection and tests HV test, Pneumatic test, Hydraulic test, Spring test, Bend test etc as applicable, to enable inspection Agency for performing Inspection. If any test equipment is found not complying with proper safety

SPECIAL CONDITIONS OF CONTRACT (SCC)
Chapter - IX: HSE & OHSAS

	requirements then the Inspection Agency may withhold inspection, till such time the desired safety requirements are met.
9.54	The Contractor shall notify BHEL of his intention to bring to site any equipment or material which may create hazard. BHEL shall have the right to prescribe the conditions under which such equipment or materials may be handled and the contractor shall adhere to such instructions. BHEL may prohibit the use of any construction machinery, which according to him is unsafe. No claim for compensation due to such prohibition will be entertained by BHEL.
9.55	All safety precautions shall be taken for welding and cutting operations as per IS-818. All safety precautions shall be taken for foundation and other excavation marks as per IS-3764.
9.56	.All gas cylinders shall be stored in upright position. Suitable trolley shall be used. There shall be flash-back arrestors conforming to IS-11006 at both cylinder and burner ends. Damaged tube and regulators must be immediately replaced. No of cylinders shall not exceed the specified quantity as per OCP
9.57	These safety provisions should be brought to the notice of all concerned by display on a notice board at a prominent, place at work spot. The persons responsible for compliance of the safety code shall be named therein by the Contractor
9.58	To ensure effective enforcement of the rules and regulations relating to safety precautions the arrangement made by the contract shall be open to inspection by the Engineer of the Engineer's Representative.
9.59	Keeping the work area clean/ free from debris, removed scaffoldings, scraps, insulation/sheeting wastage /cut pieces, temporary structures, packing woods etc. will be in the scope of the contractor. Such cleanings has to be done by contractor within quoted rate, on daily basis by an identified group. If such activity is not carried out by contractor / BHEL is not satisfied, then BHEL may get it done by other agency and actual cost alongwith BHEL overheads will be deducted from contractor's bill. Such decisions of BHEL shall be binding on the contractor.
9.60	Notwithstanding the above clauses there is nothing to exit the Contractor from the operations of any other Act or Rule in force in area of work in this respect. Provided always that all safety measures apart from those specifically provided in this agreement which are brought to the notice of the Contractor from time to time by the Engineer shall be complied by the Contractor. Provided further that

SPECIAL CONDITIONS OF CONTRACT (SCC)

Chapter - IX: HSE & OHSAS

	all consequences, damages, or losses arising by reason of any safety code shall be met with by the Contractor.																																																																
9.61	<p><u>NON COMPLIANCE:-</u> NONCONFORMITY OF SAFETY RULES AND SAFETY APPLIANCES WILL BE VIEWED SERIOUSLY AND BHEL HAS RIGHT TO IMPOSE FINES ON THE CONTRACTOR AS UNDER <u>for every instance of violation noticed:</u></p> <table border="1"> <thead> <tr> <th>SN</th> <th>Violation of Safety Norms</th> <th>Fine (in Rs)</th> </tr> </thead> <tbody> <tr> <td>01</td> <td>Not Wearing Safety Helmet</td> <td>50/- *</td> </tr> <tr> <td>02.</td> <td>Not wearing Safety Belt or not anchoring life line</td> <td>100/-*</td> </tr> <tr> <td>03</td> <td>Not wearing safety shoe</td> <td>100/-*</td> </tr> <tr> <td>04</td> <td>Not keeping gas cylinders vertically</td> <td>100/-</td> </tr> <tr> <td>05</td> <td>Not using flash back arrestors</td> <td>50/-</td> </tr> <tr> <td>06</td> <td>Not wearing gloves</td> <td>50/- *</td> </tr> <tr> <td>07.</td> <td>Grinding Without Goggles</td> <td>50/- *</td> </tr> <tr> <td>08.</td> <td>Not using 24 V Supply For Internal Work</td> <td>500/-</td> </tr> <tr> <td>09.</td> <td>Electrical Plugs Not used for hand Machine</td> <td>100/-</td> </tr> <tr> <td>10.</td> <td>Not Slinging property</td> <td>200/-</td> </tr> <tr> <td>11.</td> <td>Using Damaged Sling</td> <td>200/-</td> </tr> <tr> <td>12.</td> <td>Lifting Cylinders Without Cage</td> <td>500/-</td> </tr> <tr> <td>13.</td> <td>Not Using Proper Welding Cable With Lot of Joints And Not Insulated Property.</td> <td>200/-</td> </tr> <tr> <td>14.</td> <td>Not Removing Small Scrap From Platforms</td> <td>200/-</td> </tr> <tr> <td>15.</td> <td>Gas Cutting Without Taking Proper Precaution or Not Using Sheet Below Gas Cutting</td> <td>200/-</td> </tr> <tr> <td>16.</td> <td>Not Maintaining Electric Winches Which are Operated Dangerously</td> <td>500/-</td> </tr> <tr> <td>17.</td> <td>Improper Earthing Of Electrical T&P</td> <td>500/-</td> </tr> <tr> <td>18</td> <td>No or improper barricading</td> <td>500/-</td> </tr> <tr> <td>19.</td> <td>Activity carried out without Safety work permit (Height work, Lifting activity, Hot work-each person/case)</td> <td>1000/-</td> </tr> <tr> <td>20.</td> <td>Accident Resulting in Partial Loss in Earning Capacity</td> <td>25,000/- per victim</td> </tr> </tbody> </table>		SN	Violation of Safety Norms	Fine (in Rs)	01	Not Wearing Safety Helmet	50/- *	02.	Not wearing Safety Belt or not anchoring life line	100/-*	03	Not wearing safety shoe	100/-*	04	Not keeping gas cylinders vertically	100/-	05	Not using flash back arrestors	50/-	06	Not wearing gloves	50/- *	07.	Grinding Without Goggles	50/- *	08.	Not using 24 V Supply For Internal Work	500/-	09.	Electrical Plugs Not used for hand Machine	100/-	10.	Not Slinging property	200/-	11.	Using Damaged Sling	200/-	12.	Lifting Cylinders Without Cage	500/-	13.	Not Using Proper Welding Cable With Lot of Joints And Not Insulated Property.	200/-	14.	Not Removing Small Scrap From Platforms	200/-	15.	Gas Cutting Without Taking Proper Precaution or Not Using Sheet Below Gas Cutting	200/-	16.	Not Maintaining Electric Winches Which are Operated Dangerously	500/-	17.	Improper Earthing Of Electrical T&P	500/-	18	No or improper barricading	500/-	19.	Activity carried out without Safety work permit (Height work, Lifting activity, Hot work-each person/case)	1000/-	20.	Accident Resulting in Partial Loss in Earning Capacity	25,000/- per victim
SN	Violation of Safety Norms	Fine (in Rs)																																																															
01	Not Wearing Safety Helmet	50/- *																																																															
02.	Not wearing Safety Belt or not anchoring life line	100/-*																																																															
03	Not wearing safety shoe	100/-*																																																															
04	Not keeping gas cylinders vertically	100/-																																																															
05	Not using flash back arrestors	50/-																																																															
06	Not wearing gloves	50/- *																																																															
07.	Grinding Without Goggles	50/- *																																																															
08.	Not using 24 V Supply For Internal Work	500/-																																																															
09.	Electrical Plugs Not used for hand Machine	100/-																																																															
10.	Not Slinging property	200/-																																																															
11.	Using Damaged Sling	200/-																																																															
12.	Lifting Cylinders Without Cage	500/-																																																															
13.	Not Using Proper Welding Cable With Lot of Joints And Not Insulated Property.	200/-																																																															
14.	Not Removing Small Scrap From Platforms	200/-																																																															
15.	Gas Cutting Without Taking Proper Precaution or Not Using Sheet Below Gas Cutting	200/-																																																															
16.	Not Maintaining Electric Winches Which are Operated Dangerously	500/-																																																															
17.	Improper Earthing Of Electrical T&P	500/-																																																															
18	No or improper barricading	500/-																																																															
19.	Activity carried out without Safety work permit (Height work, Lifting activity, Hot work-each person/case)	1000/-																																																															
20.	Accident Resulting in Partial Loss in Earning Capacity	25,000/- per victim																																																															

Bharat Heavy Electricals Limited
Power Sector – Eastern Region, Kolkata

VOLUME-ID

TENDER NO. PSER:SCT:BAR-C1971:19

PAGE41OF47

SPECIAL CONDITIONS OF CONTRACT (SCC)
Chapter - IX: HSE & OHSAS

21.	Fatal Accident/Accidents Resulting in total loss in Earning Capacity	1,00,000/- per victim #
<p>Legend:-*: per head, #: or as deducted by Customer whichever is higher</p> <p>Any other non-conformity noticed not listed above will also be fined as deemed fit by BHEL. The decision of BHEL engineer is final on the above. The amount will be deducted from running bills of the contractor. The amount collected above will be utilized for giving award to the employees who could avoid accident by following safety rules. Also the amount will be spent for purchasing the safety appliances and supporting the safety activity at site.</p>		
9.61	<p>CITATION:-If safety record of the contractor in execution of the awarded job is to the satisfaction of safety department of BHEL, issue of an appropriate certificate to recognize the safety performance of the contractor may be considered by BHEL after completion of the job</p>	
9.62	<p>MEMORANDUM OF UNDERSTANDING After Award Of Work, Contractors Are Required To Enter Into A Memorandum Of Understanding As Given Below:</p> <p style="text-align: center;"><u>Memorandum of Understanding</u></p> <ul style="list-style-type: none"> ➤ BHEL, Power Sector _____ Region is committed to Health, Safety and Environment Policy (EHS Policy). ➤ M/s _____ do hereby also commit to the same EHS Policy while executing the Contract Number _____ ➤ M/s _____ shall ensure that safe work practices not limited to the above are followed by all construction workers and supervisors. Spirit and content therein shall be reached to all workers and supervisors for compliance. ➤ BHEL will be carrying out EHS audits twice a year and M/s _____ shall ensure to close any non-conformity observed/reported within fifteen days. <p>Signed by authorized representative of M/s -----</p>	

SPECIAL CONDITIONS OF CONTRACT (SCC)
Chapter - IX: HSE & OHSAS

	Name : Place & Date:
--	-----------------------------

SPECIAL CONDITIONS OF CONTRACT (SCC)
Chapter-X: RA Bill Payments

10.0	RA Bill Payments
10.1	The contractor shall submit his monthly RA bills with all the details required by BHEL on specified date every month covering progress of work in all respects and areas for the previous calendar month.
10.2	Mode of payment and measurement of work completed shall be as per relevant clauses of General Conditions of Contract
10.3	Release of payment in each running bill including PVC Bills where ever applicable will be restricted to 95% of the value of work admitted as per stages of progressive pro rata payments.
10.4	The 5% thus remaining shall be treated as 'Retention Amount' and shall be released as per terms specified in the General Conditions of Contract.
10.5	<p>The payment for running bills will normally be released within 30 days of submission of running bill complete in all respects with all documents. It is the responsibility of the contractor to make his own arrangements for making timely payments towards labour wages, statutory payments, outstanding dues etc and other dues in the meanwhile.</p> <p>In case of Civil works, 60% of RA Bills complete and correct in all respects and certified by BHEL Engineer, shall be paid within 15 days of receipt. Balance payment shall be within 30 days.</p>
10.6	<p>BHEL shall release payment through Electronic Fund Transfer (EFT)/RTGS. In order to implement this system, Contractor to furnish details pertaining to his Bank Accounts where proceeds will be transferred through BHEL's banker, as per prescribed formats:</p> <p>Note: BHEL may also choose to release payment by other alternative modes as applicable</p>
10.7	Paying Authority shall be the Construction Manager of the Site. Any change in the paying Authority shall be intimated to the Contactor accordingly.

SPECIAL CONDITIONS OF CONTRACT (SCC)
Chapter-XI : Performance Monitoring

11.0	Performance Monitoring
11.1	Performance of the contractor is monitored through various reports/reviews and shall be jointly evaluated every month for unit wise identified packages as per prescribed formats. Based on the net weighted scores obtained, Contractors shall be rated 'Good' or 'Satisfactory' or 'Unsatisfactory'
11.2	In case of any dispute on performance rating and the contractor refuses to sign on the performance rating given by BHEL package Incharge, the same shall be reviewed by BHEL site Incharge/Construction Manager and his decision shall be final.
11.3	Release of RA Bills will be contingent upon joint evaluation of performance
11.4	Performance of the contractor will be taken into consideration for assessing the capacity of the bidder to execute future jobs under tender, as detailed in the Notice Inviting Tender. Risk of non evaluation or non availability of the Monthly performance evaluation reports is to be borne by the Bidder.
11.5	In case of 'Unsatisfactory performance' for a continuous period of three or more months for a package or packages, BHEL has the right to get the balance works executed at the risk and cost of the contractor.
11.6	In case of 'Unsatisfactory performance' in a financial year, BHEL reserves the right to put on hold such Contractors for a period of six months for similar package or similar packages

SPECIAL CONDITIONS OF CONTRACT (SCC)
Chapter-XII: Suspension of Business Dealings

12.0	Suspension of Business dealings
12.1	BHEL reserves the right to take action against contractors who fail to perform or indulge in malpractices, by suspending business dealings with them.
12.2	Suspension could be in the form of 'Hold', 'De-listing' or 'Banning' a contractor.
12.3	<p>A bidder may be put on HOLD for a period of 6 months, for future tenders for specific works on the basis of one or more of the following reasons:</p> <ol style="list-style-type: none"> a) Bidder does not honour his own offer or any of its conditions within the validity period. b) Bidder fails to respond against three consecutive enquires of BHEL. c) After placement of order, Bidder fails to execute a contract. d) Bidder fails to settle sundry debt account, for which he is legitimately liable, within one year of its occurrence. e) Bidder's performance rating falls below 60% in specific category (more fully described in chapter 'Performance Monitoring') f) Bidder works are under strike/ lockout for a long period.
12.4	<p>A Bidder may be de-listed from the list of registered Bidders of the region for a period of 1 year on the basis of one or more of the following reasons:-</p> <ol style="list-style-type: none"> a) Bidder tampers with tendering procedure affecting ordering process or commits any misconduct which is contrary to business ethics. b) Bidder has substituted, damaged, failed to return, short returned or unauthorizedly disposedoff materials/ documents/ drawings/ tools etc of BHEL. c) Bidder no longer has the technical staff, equipment, financial resources etc. required to execute the orders/ contracts.
12.5	<p>A Bidder can be banned from doing any business with all Units of BHEL for a period of 3 years on the basis of one or more of the following reasons:</p> <ol style="list-style-type: none"> a) Bidder is found to be responsible for submitting fake/ false/ forged documents, certificates, or information prejudicial to BHEL's interest. b) In spite of warnings, the Bidder persistently violates or circumvents the provisions of labour laws/ regulations/ rules and other statutory requirements. c) Bidder is found to be involved in cartel formation

SPECIAL CONDITIONS OF CONTRACT (SCC)
Chapter-XII: Suspension of Business Dealings

	<p>d) The Bidder has indulged in malpractices or misconduct such as bribery, corruption and fraud, pilferage etc which are contrary to business ethics.</p> <p>e) The Bidder is found guilty by any court of law for criminal activity/ offences involving moral turpitude in relation to business dealings.</p> <p>f) The Bidder is declared bankrupt, insolvent, has wound up or been dissolved; i.e ceases to exist for all practical purposes.</p> <p>g) Bidder is found to have obtained Official Company information/ documentation by questionable means.</p> <p>h) Communication is received from the administrative Ministry of BHEL to ban the Bidder from business dealings.</p>
12.6	Contracts already entered with a contractor before the date of issue of order of 'HOLD' or 'DE-LISTING' shall not be affected.
12.7	All existing contracts with a 'BANNED' contractor shall normally be short closed
12.8	Once the order for suspension is passed, existing offers/new offers of the contractor shall not be entertained
12.9	The above guidelines are not exhaustive but enunciate broad principles governing action against contractors



HEALTH, SAFETY and ENVIRONMENT PLAN

For

SITE OPERATIONS

By

SUB-CONTRACTORS

POWER SECTOR- EASTERN REGION

 PS-ER	HEALTH, SAFETY AND ENVIRONMENT PLAN FOR SUB-CONTRACTORS (GENERAL)	Doc. No.: HSEP:14-ER
		Rev.: 00
		Date: 25.04.19
		Page 2 of 162

DOCUMENT ISSUE SHEET

	PREPARED BY	APPROVED BY
NAME	Saswajeet Rout	
DESIGNATION		
SIGNATURE		<div style="display: flex; align-items: center;"> <div style="font-size: 2em; font-weight: bold; margin-right: 10px;">Pradip Ghosh</div> <div style="font-size: 0.8em;"> Digitally signed by Pradip Ghosh DN: cn=Pradip Ghosh, o=BHEL, ou=HSE-PSER, email=pradipg@bhelpser.co.in, c=IN Date: 2019.06.15 13:02:14 +05'30' </div> </div>
ISSUED BY:		
ISSUED TO:		
COPY NO:		
DATE OF ISSUE:		

THIS PLAN SUPERSEDES THE STANDARD HSE PLAN

 PS-ER	HEALTH, SAFETY AND ENVIRONMENT PLAN FOR SUB-CONTRACTORS (GENERAL)	Doc. No.: HSEP:14-ER
		Rev.: 00
		Date: 25.04.19
		Page 3 of 162

HSE PLAN FOR SITE OPERATIONS BY BHEL'S SUBCONTRACTORS AT A GLANCE

BEFORE START	SIGNING OF MOU	
	Agree to comply to HSE requirement- Statutory and BHEL's	Agree to accept BHEL's decision on release of 1.5% (as specified in the contract) of Gross bill Amount or part thereof or otherwise (non-release), based on our HSE performance as evaluated by BHEL during the execution period
PLAN	HSE ORGANISATION	
	Manpower <ul style="list-style-type: none"> • 1 (one) safety officer for every 300 workers or part thereof • 1(one) safety-supervisor for every 150 workers • 1(one) safety-steward/ supervisor for every 50 workers As per Cl. 7.1	HSE Roles and responsibilities <ul style="list-style-type: none"> • All employees as per 7.2.1 • Site In-charge & Package In-charges- As per clause 7.2.2 • Safety officer- As per clause 7.2.3
	HSE Planning for Man, Machinery / Equipment/ Tools & Tackles	
PROVIDE	HSE INFRASTRUCTURE	
	<ul style="list-style-type: none"> • PPEs • Drinking Water • Washing Facilities • Latrines and Urinals • Provision of shelter for rest • Medical facilities 	<ul style="list-style-type: none"> • Canteen facilities • Labor Colony • Emergency Vehicle • Pest Control • Scrapyard • Illumination • Crèches (if required)
TRAIN	HSE TRAINING , AWARENESS & PROMOTION	
	Training <ul style="list-style-type: none"> • Induction training • Height work and other critical areas • Tool Box talk & Pep Talk • Job Specific Training 	Awareness & Promotion <ul style="list-style-type: none"> • Posters & Signage • Emergency Contact/Information Display • Banner • Competition & Awards
COMMUNICATE	HSE COMMUNICATION	
	Incident Reporting <ul style="list-style-type: none"> • Accident- Fatal, Major & Minor • Property damage • Near Miss Safety Performance Reporting	Event Reporting <ul style="list-style-type: none"> • Celebrations • Training • Medical camp • Motivational Activities



**HEALTH, SAFETY AND ENVIRONMENT PLAN
FOR
SUB-CONTRACTORS
(GENERAL)**

Doc. No.: HSEP:14-ER

Rev.: 00

Date: 25.04.19

Page 4 of 162

EXECUTE SAFELY

SAFETY DURING WORK EXECUTION**PERMIT TO WORK**

Height work (above 2 meters), Hot Work, Heavy Lifting, Confined Space, Radiography, Excavation (More than 1.22 meters), Lockout / Tag out

OPERATIONAL CONTROL

- | | |
|---|--|
| <ul style="list-style-type: none"> • Welding, Gas Cutting Grinding • Rigging, Signaling • Cylinder- Storage & Movement • Demolition work • T&Ps • Chemical Handling • Electrical works • Painting | <ul style="list-style-type: none"> • Fire • Scaffolding • Height work • Working Platform • Excavation / Civil Work • Ladder • Lifting • Hoisting appliance • Hard Barricading |
|---|--|

HOUSE KEEPING**WASTE MANGEMENT****TRAFFIC MANAGEMENT****ENVIRONMENTAL CONTROL****EMERGENCY PREPAREDNESS AND RESPONSE PLANNING****HSE AUDITS & INSPECTION**

- | | |
|---|---|
| <ul style="list-style-type: none"> • Daily Checks • Inspection of Height work • Inspection of PPEs • Inspection of T & Ps | <ul style="list-style-type: none"> • Inspection of Cranes & Winches • Inspection of Welding and Gas cutting • Inspection of elevators etc. |
|---|---|

HSE PERFORMANCE EVALUATION PARAMETERS

CHECKS

PENALTY for NON CONFORMANCE

**Refer Clause 16 Incremental
penalty**

For repeated violation by the same person, the penalty would be double of the previous penalty

For repeated fatal incident in the same contract / package, incremental penalty to be imposed. The subcontractor will pay 2 times the penalty compared to the previously paid in case there are repeated cases of fatal incidents under the same subcontractor for the same package in the same unit.

NON CONFORMANCE

COMPENSATION TO ACCIDENT VICTIMS

Refer Clause 17

Employee Compensation Act, 1922

Other Acts and Guidelines relevant to employee compensation



PS-ER

HEALTH, SAFETY AND ENVIRONMENT PLAN
FOR
SUB-CONTRACTORS
(GENERAL)

Doc. No.: HSEP:14-ER

Rev.: 00

Date: 25.04.19

Page 5 of 162

ORGANIZATION OF THIS DOCUMENT

- **GENERAL SECTION**
- **SECTION A:**
MAIN REQUIREMENTS APPLICABLE IN FULL
- **SECTION B:**
SPECIAL REQUIREMENTS
- **ANNEXES**



PS-ER

**HEALTH, SAFETY AND ENVIRONMENT PLAN
FOR
SUB-CONTRACTORS
(GENERAL)**

Doc. No.: HSEP:14-ER

Rev.: 00

Date: 25.04.19

Page 6 of 162

CONTENTS

S. No.	Description	Page No.
GENERAL		
1	PURPOSE	9
2	SCOPE	9
3	OBJECTIVES AND TARGETS	10
4	REFERENCES	11
5	HEALTH, SAFETY & ENVIRONMENT POLICY	12
	MEMORANDUM OF UNDERSTANDING	13
6	TERMS & DEFINITIONS	14
SECTION-A		
7	HSE ORGANIZATION	17
7.1	DEPLOYMENT (NUMBERS, QUALIFICATIONS & EXPERIENCE)	17
7.2	HSE RESPONSIBILITIES	19
8	PLANNING BY SUBCONTRACTOR	23
8.1	MOBILISATION OF MACHINERY/EQUIPMENT/TOOLS	23
8.2	MOBILISATION OF MANPOWER BY SUBCONTRACTOR	24
8.3	PROVISION OF PPEs	25
8.4	ARRANGEMENT OF INFRASTRUCTURE	26
9	HSE TRAINING & AWARENESS	32
10	HSE PROMOTION – SIGNAGE, POSTERS, COMPETITIONS, AWARDS ETC	34
11	HSE COMMUNICATION & PARTICIPATION	35
12	INCIDENT INVESTIGATION & CORRECTIVE ACTION	36
13	SAFETY DURING WORK EXECUTION	37
13.1	HSE SYSTEMS & PROCEDURES	37
13.2	WORK PERMIT SYSTEM	39
13.3	ACTIVITY SPECIFIC SAFETY REQUIREMENTS	40
13.4	ENVIRONMENTAL CONTROL	46
13.5	HOUSEKEEPING	47



PS-ER

**HEALTH, SAFETY AND ENVIRONMENT PLAN
FOR
SUB-CONTRACTORS
(GENERAL)**

Doc. No.: HSEP:14-ER

Rev.: 00

Date: 25.04.19

Page 7 of 162

S. No.	Description	Page No.
13.6	WASTE MANAGEMENT	47
13.7	TRAFFIC MANAGEMENT	48
13.8	EMERGENCY PREPAREDNESS & RESPONSE	50
13.9	CONTROL OF DOCUMENTS	50
13.10	CONTROL OF RECORDS	50
14	HSE INSPECTION	51
15	HSE PERFORMANCE	54
16	HSE PENALTIES FOR NON-COMPLIANCE	55
17	OTHER REQUIREMENTS	56
18	INTERNAL & EXTERNAL HSE AUDITS	56
19	HSE REVIEW	57
20	FORMATS USE	58
	<i>FORMATS</i>	
SECTION B		
	ESTABLISHMENT OF COMMON FACILITIES / INFRASTRUCTURE	
	SHARED FACILITIES	
ANNEXES		
	ANNEXURE-1	
	ANNEXURE-2	
	ANNEXURE-3	
	ANNEXURE-A: ACTIVITY SPECIFIC REQUIREMENTS FOR SAFETY	
	ANNEXURE-B: HSE PRECAUTIONS FOR ADVERSE CLIMATES & WEATHER CONDITIONS	
	ANNEXURE-C: FIRE EXTINGUISHER REQUIREMENTS	
	ANNEXURE-D: SPECIFICATIONS	
	RECORD OF REVISIONS	

GENERAL



POWER SECTOR

**HEALTH, SAFETY AND ENVIRONMENT PLAN
FOR
SUB-CONTRACTORS
(GENERAL)**

Doc. No.: HSEP:14-ER

Rev.: 00

Date: 25.04.19

Page 9 of 162

1. PURPOSE

- 1.0** The purpose of this HSE Plan is to provide for the systematic identification, evaluation, prevention and control of general workplace hazards, specific job hazards, potential hazards and environmental impacts that may arise from foreseeable conditions during installation and servicing of industrial projects and power plants.
- 1.1** This document shall be followed by BHEL's Sub-Contractors at all installation and servicing sites. In case BHEL has contractual HSE obligations towards customer, this document will be followed in conjunction with (BHEL's) customer specific requirements, ensuring that applicable systems, controls and checks of both are implemented in letter and spirit.
- 1.2** In case the customer has any specific requirement, the same is to be fulfilled but may not include financial inclusion.
- 1.3** This document shall be followed unless otherwise mentioned in TCC (technical condition of contract) or elsewhere in NIT or contract documents. This supersedes all HSE clauses in GCC.
- 1.4** Although every effort has been made to make the procedures and guidelines in line with statutory requirements, in case of any discrepancy relevant statutory guidelines must be followed.

2. SCOPE

The document is applicable on all activities and assets including managerial, supervisory, professional, technical, clerical and other workers including contract laborers; and equipment operating under the control of BHEL's Subcontractors at all installation / servicing activities of BHEL Power Sector as per the relevant contractual obligations.



POWER SECTOR

**HEALTH, SAFETY AND ENVIRONMENT PLAN
FOR
SUB-CONTRACTORS
(GENERAL)**

Doc. No.: HSEP:14-ER

Rev.: 00

Date: 25.04.19

Page 10 of 162

3. OBJECTIVES

The HSE Plan reflects that BHEL places high priority upon the Occupational Health, Safety and Environment at workplaces. The Sub-contractor shall:

Health & Safety

- Prevent injury and ill health of all persons at site ('Persons' refers to all personnel including managerial, supervisory, professional, technical, clerical and other workers including contract laborers)

Environment

- Prevent pollution to environment and ensure protection of environment taking into account interested party concern and conservation of resources and reduction of wastage

Legal Requirements

- Comply at all times with the relevant statutory and contractual HSE requirements.

Planning & Resources

- Ensure that all work planning takes into account all persons that may be affected by the work.
- Ensure timely provision of resources to facilitate effective implementation of HSE requirements.

Competency, Training & Awareness

- Provide trained, experienced and competent personnel. Ensure medically fit personnel only are engaged at work.
- Provide all personnel with adequate information, instruction, training and supervision on the safety aspect of their work.

Maintenance of Equipment

- Ensure fitness testing of all T&Ps. Lifting appliances like cranes, chain pulley blocks etc. are certified by competent authority.

Safety during Operations

- Provide and maintain plant, places and systems of work that are safe and without risk to health and the environment.
- Effectively control, co-ordinate and monitor the activities of all personnel on the Project sites including subcontractors in respects of HSE.
- Establish effective communication on HSE matters with all relevant parties involved in the Project works.

HSE Improvement

- Capture the data of all incidents including near misses, process deviation etc. Investigate and analyze the same to find out the root cause
- Ensure timely implementation of correction, corrective action.
- Ensure continual improvement in HSE performance



POWER SECTOR

**HEALTH, SAFETY AND ENVIRONMENT PLAN
FOR
SUB-CONTRACTORS
(GENERAL)**

Doc. No.: HSEP:14-ER

Rev.: 00

Date: 25.04.19

Page 11 of 162

GOALS AND TARGETS

- ❖ To achieve “Zero Incident at Site” (LTI)
- ❖ 100% compliance of all legal/statutory requirements related to HSE.
- ❖ 100% Health, Safety and Environmental Induction training attendance for all workers.
- ❖ 100% High Risk activities to be carried out only after approved Method Statement, HIRA / Aspect-Impact / JSA / OCP and Permit to Work are implemented.
- ❖ 100% PPEs compliance in high and medium risk activities.
- ❖ 100% monitoring of all Work Areas
- ❖ 100% detection of non-conformities in work area and 100% closure within specified time
- ❖ 100% incident (near miss, minor, major, other) reporting, recording and reviewing for corrective actions.
- ❖ Regular Safety Reviews to assess HSE program compliance and 100% closure of any recognized gaps to continually improve safety management and incident prevention.

4. REFERENCES

1. ALL CONTRACTUAL HSE REQUIREMENTS INCLUDING THIS DOCUMENT
2. ALL APPLICABLE ACTS, RULES & REGULATIONS
3. BHEL POWER SECTOR HSE MANAGEMENT SYSTEM
 - I. HSE PROCEDURES (13.1.1)
 - II. WORK PERMITS (See Clause 13.1.2)
 - III. OPERATIONAL CONTROL PROCEDURES (See Clause 13.1.3)
 - IV. FORMATS (See Clause 21)
4. BHEL CORPORATE STANDARD PPE GUIDELINES
5. RELEVANT INDIAN STANDARDS FOR SAFETY (See Annexure 02)

(Note: Wherever, the date or revision number of a document is not mentioned, latest revision is implied)



**HEALTH, SAFETY AND ENVIRONMENT PLAN
FOR
SUB-CONTRACTORS
(GENERAL)**

Doc. No.: HSEP:14-ER

Rev.: 00

Date: 25.04.19

Page 12 of 162

5. BHEL HEALTH, SAFETY & ENVIRONMENT POLICY:

In BHEL, Health, Safety and Environment (HSE) responsibilities are driven by our commitment to protect our employees and people we work with, community and environment. BHEL believes in zero tolerance for unsafe work/non-conformance to safety and in minimizing environmental footprint associated with all its business activities. We commit to continually improve our HSE performance by:

- Developing safety and sustainability culture through active leadership and by ensuring availability of required resources.
- Ensuring compliance with applicable legislation, regulations and BHEL systems.
- Taking up activities for conservation of resources and adopting sound waste management by following Reduce/Recycle/Reuse approach.
- Continually identifying, assessing and managing environmental impacts and Occupational Health & Safety risks of all activities, products and services adopting approach based on elimination/substitution/reduction/control.
- Incorporating appropriate Occupational Health, Safety and Environment criteria into business decisions, design of products & systems and for selection of plants, technologies and services.
- Imparting appropriate structured training to all persons at workplace and promoting awareness amongst customers, contractors and suppliers on HSE issues.
- Reviewing periodically this policy and HSE Management Systems to ensure its relevance, appropriateness and effectiveness.
- Communicating this policy within BHEL and making it available to interested parties.

Atul Sobti
Chairman & Managing Director



POWER SECTOR

**HEALTH, SAFETY AND ENVIRONMENT PLAN
FOR
SUB-CONTRACTORS
(GENERAL)**

Doc. No.: HSEP:14-ER

Rev.: 00

Date: 25.04.19

Page 13 of 162

6. TERMS AND DEFINITIONS

6.0 INCIDENT

Work- related or natural event(s) in which an injury or ill health (regardless of severity) or fatality, damage to property/environment occurred, or could have occurred.

6.1 NEAR MISS

An incident where no ill health, injury, damage or other loss occurs, but it had a potential to cause, is referred to as "Near-Miss incident".

6.2 MAN-HOURS WORKED

The total number of employee hours worked by all employees including subcontractors working in the premises.

It includes managerial, supervisory, professional, technical, clerical and other workers including contract laborers.

Man-hours worked shall be calculated from the payroll or time clock recorded including overtime. When this is not feasible, the same shall be estimated by multiplying the total man-days worked for the period covered by the number of hours worked per day. The total number of workday for a period is the sum of the number of men at work on each day of period. If the daily hours vary from department to department separate estimate shall be made for each department and the result added together.

6.3 FIRST AID CASES (FAC)

First aid cases include:

1. Visit to a physician or a licensed health care professional solely for observation or counselling
2. Conduct of diagnostic procedures like X rays, blood test including the prescription medications used solely for diagnostic purposes (e.g. eye drops to dilate eyes)
3. Using a non-prescription medicine at non-prescription strength (for medication available in both prescription and non-prescription form as recommendation by a physician or other licensed health care professional to use a non-prescription medication at prescription strength is considered medical treatment for record keeping purposes);
4. Administering tetanus immunizations (other immunizations, such as Hepatitis B vaccine or rabies vaccine, are considered medical treatment);
5. Cleaning, flushing or soaking wounds on the surface of the skin;
6. Using wound coverings such as bandages, Band-Aids TM, gauze pads, etc.; or using butterfly bandages or Steri-Strips TM (other wound closing devices such as sutures, staples, etc., are considered medical treatment);
7. Using hot or cold therapy;
8. Using any non-rigid means of support, such as elastic bandages, wraps, non-rigid back belts, etc. (devices with rigid stays or other systems designed to immobilize parts of the body are considered medical treatment for record-keeping purposes);



POWER SECTOR

**HEALTH, SAFETY AND ENVIRONMENT PLAN
FOR
SUB-CONTRACTORS
(GENERAL)**

Doc. No.: HSEP:14-ER

Rev.: 00

Date: 25.04.19

Page 14 of 162

9. Using temporary immobilization devices while transporting an accident victim (e.g., splints, slings, neck collars, back boards, etc.).
 10. Drilling of a fingernail or toenail to relieve pressure, or draining fluid from a blister;
 11. Using eye patches;
 12. Removing foreign bodies from the eye using only irrigation or a cotton swab;
 13. Removing splinters or foreign material from areas other than the eye by irrigation, tweezers, cotton swabs or other simple means;
 14. Using finger guards;
 15. Using massages (physical therapy or chiropractic treatment are considered medical treatment for recordkeeping purposes); or
 16. Drinking fluids for relief of heat stress.
- No other treatments are considered first aid.

6.4 MEDICAL TREATMENT CASES (MTC)

An incident involved with an injury or illness that needs medical attention beyond First-aid as per 6.3 above.

6.5 Dangerous Occurrence is defined as:

- (1) Collapse or failure of lifting appliances or hoist or conveyors or other similar equipment/machine;
- (2) Collapse or failure of a crane, derrick, winch, hoist or other appliance used in raising or lowering persons or goods or any part thereof, or the overturning of a crane;
- (3) Explosion or fire causing damage to the structure of any room or place in which persons are employed, or to any machine or plant, resulting in the complete suspension of ordinary work;
- (4) Electrical short circuit or failure of electrical machinery, plant or apparatus, attended by explosion or fire, causing structural damage involving its stoppage or disuse;
- (5) Explosion of a receiver or container used for the storage at a pressure greater than atmospheric pressure of any gas or gases (including air) or any liquid or solid resulting from the compression of gas;
- (6) Collapse in whole or part from any cause whatsoever of any roof, wall, floor, Structure or foundation forming part of the construction site in which persons are employed;
- (7) Total or partial collapse of any overburden, face, tip or embankment on the Construction site;
- (8) The overturning of, or collision with any object by any bulldozer, dumper, excavator, grader, lorry or shovel loader, or any mobile machine used for the handling of any substance on the construction site.

6.6 **Fire:** Except Dangerous occurrence, any incident involving fire.

6.7 **Property Damage:** Except Dangerous Occurrences and Fire, any incident of property (materials, building, equipment etc) getting damaged.

6.8 TYPE OF INCIDENT / ACCIDENT & THEIR REPORTING:

The categories of Incident / accident are as follows:

Non-Reportable Cases or NON-LTI: (Including First-aid cases as per 6.3 and MTC as per 6.4)

Minor: In this case the injured person resumes duty within 48 hours of incident.



POWER SECTOR

**HEALTH, SAFETY AND ENVIRONMENT PLAN
FOR
SUB-CONTRACTORS
(GENERAL)**

Doc. No.: HSEP:14-ER

Rev.: 00

Date: 25.04.19

Page 15 of 162

Reportable Cases (LTI or Loss Time Injury Cases):

Major: In this case the injured person is disable for 48 hours or more and is not able to perform his duty. (as per IS 3786). It includes fatality.

All incidents must be reported orally immediately and in writing within 24 hours of time of incident. However, in case of fatality, it shall be reported to the statutory authority within prescribed timeline through proper channel. Internal reporting shall be done within 6 hours of time of the incident

6.9 TOTAL REPORTABLE FREQUENCY RATE

Frequency rate is the number of Reportable Lost Time Injury (LTI) per one Million Man hours worked. Mathematically, the formula read as:

$$\frac{\text{Number of Reportable LTI}}{\text{Total Man Hours Worked}} \times 1,000,000$$

6.10 SEVERITY RATE

Severity rate is the Number of days lost due to Lost Time Injury (LTI) per one Million Man hours worked. Mathematically, the formula reads as:

$$\frac{\text{Days lost due to LTI}}{\text{Total Man Hours Worked}} \times 1,000,000$$

6.11 FREQUENCY SEVERITY INDEX (FSI)

Frequency Severity Index, $FSI = \sqrt{FR * SR / 1000}$

6.12 INCIDENCE RATE

Incidence Rate is the Number of LTI per one thousand manpower deployed. Mathematically, the formula reads as:

$$\frac{\text{Number of LTI} \times 1000}{\text{Average number of manpower deployed}}$$

6.13 JOB SAFETY ANALYSIS

A job safety analysis (JSA) is a procedure which helps integrate accepted safety and health principles and practices into a particular task or job operation. In a JSA, each basic step of the job is to identify potential hazards and to recommend the safest way to do the job. Other terms used to describe this procedure are job hazard analysis (JHA) and job hazard breakdown.



POWER SECTOR

**HEALTH, SAFETY AND ENVIRONMENT PLAN
FOR
SUB-CONTRACTORS
(GENERAL)**

Doc. No.: HSEP:14-ER

Rev.: 00

Date: 25.04.19

Page 16 of 162

6.14 SAFETY WALK

It's a walk (conducted periodically) by an official through a portion or whole of a site as an HSE officer, noting down HSE observations, speaking to concerned workmen and supervisor on observation, recording and reporting to in charges of agencies, getting the same rectified with personal follow up - to send out a strong message on Management's commitment to safety.

6.15 HEAVY & COMPLEX LIFTING

A heavy and complex lifting activity includes:

1. Lifting above 50 Tons
 2. Tandem Lifting using multiple cranes
 3. Total load exceeding 75% of capacity of crane
 4. Lift of unusual difficulty or geometry or rigging
 5. Lift over operating units
 6. Any other lift as decided by site HSE / Erection
- In any case, Job Safety Analysis to be carried out for any lift above 5 Tons.

6.16 SAFETY COMMITTEE

As per the BOCW, Safety Committee shall be constituted if there are more than five hundred or more construction workers are employed at any site. As per the Factories Act, 1948 it is for 250 workers. It shall be represented by equal number of representatives of employer and construction workers.

6.17 NIGHT WORK

Work conducted after sunset when only a fraction of total manpower is available

Section-A

Main Requirements

(Applicable in Full)



POWER
SECTOR

HEALTH, SAFETY AND ENVIRONMENT PLAN
FOR
SITE OPERATIONS
(SECTION-A)

Doc. No.: HSEP:14-
ER

Rev.: 00

Date: 25.04.19

Page 18 of 58

7. HSE ORGANISATION

7.1 DEPLOYMENT

7.1.1 Minimum Number (Availability per contract / package per Working Shift)

7.1.1.1 HSE Officer	7.1.1.2 HSE Supervisor	7.1.1.3 HSE Steward / Observer
1 per 300 workers or part thereof as a minimum or as mandated by applicable legal requirements, whichever more stringent	1 per 150 workers or part thereof	1 per 50 workers or part thereof

7.1.1.4 The safety officers shall be engaged directly by the sub-contractor, whereas safety supervisors and safety stewards may be from the agencies engaged by the sub-contractor.

7.1.1.5 Deployment Plan:

- 7.1.1.5.1 These shall be minimum one HSE officer along with HSE supervisor and HSE steward in the aforesaid ratio for every shift for each unit of Boiler/ESP/Power House & TG/ Chimney/ Whole of Cooling Tower.
- 7.1.1.5.2 For Civil works and other BOP items, deployment shall be broadly as specified in the above table. But BHEL shall finally approve the deployment based on nature and volume of jobs, Risks and hazards associated etc.
- 7.1.1.5.3 The deployment plan of Safety manpower at various locations shall be submitted to BHEL for approval by subcontractor

BHEL reserves the right to demand more safety personnel than what is stipulated here and change the deployment pattern

 POWER SECTOR	HEALTH, SAFETY AND ENVIRONMENT PLAN FOR SITE OPERATIONS (SECTION-A)		Doc. No.: HSEP:14-ER
			Rev.: 00
			Date:
			Page 19 of 58

7.1.2 QUALIFICATION & EXPERIENCE

All Degrees/ Diplomas shall be recognized by State Council for Technical Education & Vocational Training (SCTE & VT) / All India Council for Technical Education (AICTE) / University

7.1.2.1 HSE Officer	7.1.2.2 HSE Supervisor	7.1.2.3 HSE Steward / Observer
<p>A.</p> <p>i. Recognized degree in any branch of Engg. or Tech. or Architecture with practical experience of working in a building or other construction work in supervisory capacity for a period of not less than two years, or Recognized diploma in any branch of Engg. or Tech with practical experience of working in a building or other construction work in supervisory capacity for a period of not less than five years.</p> <p>ii. Recognized degree or diploma in Industrial safety</p> <p>iii. (Preferably) have adequate knowledge of the language spoken by majority of the workers at the construction site.</p> <p>Alternatively:</p> <p>B. Graduation Degree in Science with Physics & Chemistry and degree or diploma in Industrial Safety (from any Indian institutes recognized by AICTE or State Council of Tech. Education of any Indian State) with practical experience of working in a building, plant or other construction works (as Safety Officer, in line with Indian Factories Act, 1958) for a period of not less than five years.</p>	<p>As a minimum, (s)he shall possess:</p> <p>A recognized graduation Degree in Science (with Physics & Chemistry) or a recognized diploma in Engg. or Tech. with:</p> <p>a. Minimum Two years of practical experience in construction work environment and</p> <p>b. Should possess requisite skills to deal with construction safety & fire related day-to-day issues.</p>	<p>As a minimum, (s)he shall possess:</p> <p>1. Class XII pass certificate and</p> <p>2. Trained in fire-fighting as well as in safety / occupational health related subjects, with:</p> <p>a. Minimum two year of practical experience in construction work environment and</p> <p>b. Should have adequate knowledge of the local language spoken by majority of the workers at the construction site.</p>

7.1.3 HSE IN-CHARGE

In case there are more than one HSE Officers with any subcontractor, one of them, who is senior most by experience (in HSE discipline), may be designated as HSE In-Charge. Duties & responsibilities of such person shall be commensurate with that of relevant statute and primarily to coordinate with top management of Client and subcontractors.

 POWER SECTOR	HEALTH, SAFETY AND ENVIRONMENT PLAN FOR SITE OPERATIONS (SECTION-A)	Doc. No.: HSEP:14-ER
		Rev.: 00
		Date:25.04.19
		Page 20 of 162

7.1.4 AVAILABILITY AND PENALTY FOR NON-DEPLOYMENT:

Subcontractor shall ensure physical availability of safety personnel at the place of specific work location including where Height Work Permit is required/granted. No work shall be started in any area until above safety personnel & concerned Site Engineer of subcontractor are physically deployed at site.

The Subcontractor shall prepare an organization chart identifying the areas of operations, responsibilities and reporting structure of all safety personnel and submit the same to BHEL.

The subcontractor shall deploy sufficient safety officers, supervisors and safety-stewards, as per numbers & qualifications mandated in this Section since mobilization of first batch of manpower and add more in proportion to the added strength in work force. Any delay in deployment will attract a penalty at following rates:

Non-deployment of HSE Officer	–	Rs 50000 per man-month
Non-deployment of HSE Supervisor	–	Rs 30000 per man-month
Non-deployment of HSE Steward	–	Rs 20000 per man-month

Penalty shall be collected for the period of non-availability of safety personnel after allowing a grace period of 15 days for finding a replacement.

7.1.5 QUALIFICATION OF CRANE & WINCH OPERATORS, DRIVERS etc.:

The Crane and Winch Operators, Drivers, Riggers and other professionals deployed shall be qualified and experienced, and have valid license for the class of vehicle / machinery as applicable. The subcontractor shall certify competence of these persons.in writing as and when they join.

Crane/Winch operator should have certificate on subject course or owner experience certificate in letterhead.

7.1.6 In case the statutory requirements i.e. State or Central Acts and / or Rules as applicable like the Building and Other Construction Workers' Regulation of Employment and Conditions of Service- Act,1996 or State Rules (wherever notified), the Factories Act, 1948 or Rules (wherever notified), etc. are more stringent than above clarifications, the same shall be followed.

7.1.7 **BILLING:** Deployment of Safety manpower as per this clause **shall be** a billable item.

7.1.8 The Subcontractor shall verify & authenticate credentials of the HSE personnel detailed in this Section and furnish Bio-Data/Resume / Curriculum Vitae of the safety personnel as above for BHEL / Owner's approval, at least 1 month before the mobilization. The Subcontractor, whenever required, shall arrange submission of original testimonials / certificates of their Safety personnel, to BHEL / Owner (for verification/scrutiny, etc.)

7.1.9 Prior approval of CVs by BHEL for Safety Officer and Safety Supervisor is mandatory, however BHEL has right to check suitability of Safety Stewards as well.

 POWER SECTOR	HEALTH, SAFETY AND ENVIRONMENT PLAN FOR SITE OPERATIONS (SECTION-A)	Doc. No.: HSEP:14-ER
		Rev.: 00
		Date:25.04.19
		Page 21 of 162

7.2 HSE RESPONSIBILITIES

The subcontractors shall communicate the HSE responsibilities as indicated in this section to relevant employees in written Form and ensure awareness of the same

7.2.1 ALL EMPLOYEES

1. To be aware of, get involved in and ensure implementation of all HSE related Systems and Procedures including but not limited to:
 - a) BHEL HSE Management System including HSE Procedures and OCPs
 - b) Work Permit System
 - c) Emergency Preparedness Response Plans
 - d) Contractual HSE requirements
 - e) Legal Requirements
 - f) Penalty System
 - g) Training requirements
2. To ensure that the persons engaged in respective area follow the safety rules like using appropriate PPEs.
3. To keep track of repetitive minor or major incident observation/ report and submit to BHEL.
4. To prepare HIRA / JSA as required and submit to BHEL for verification.
5. To record all incidents including near miss and report to BHEL.
6. To adopt safe working practices at all times and act as role model for Safety
7. To take immediate corrective action actions in case any non-conformity is observed on product / process / system with respect to Occupational Health, Safety and Environment.
8. In case any particular activity / work has extremely high consequential risk or high environmental impact, same shall be brought to the notice of BHEL Package In-charge before starting the work.
9. To interfere/ stop work as & when identified unsafe.
10. To maintain & promote improved level of house-keeping all the time at site.
11. To support/co-operate with audit team members as & when safety audits are carried out.
12. To involve in investigation, if any incident occurs in his work area.
13. To participate in safety promotional programmes.
14. To attend the safety committee meeting, if member/ invitee
15. To ensure that only fit T&Ps and qualified persons are engaged for all activities.
16. Shall ensure that person working above 2.0 meter should use Safety Harness tied to a life line/stable structure.
17. Shall ensure that materials are not thrown from height. Cautions to be exercised to

 <p>POWER SECTOR</p>	HEALTH, SAFETY AND ENVIRONMENT PLAN FOR SITE OPERATIONS (SECTION-A)	Doc. No.: HSEP:14-ER
		Rev.: 00
		Date:25.04.19
		Page 22 of 162

prevent fall of material from height.

18. Shall ensure that all T&Ps engaged are tested for fitness and have valid certificates from competent authorities.

7.2.2 SITE IN –CHARGE & PACKAGE IN-CHARGES OF SUBCONTRACTOR

1. All requirements as per 7.2.1
2. **Shall ensure fulfillment of HSE requirements of BHEL contract as given in this document.**
3. Shall engage qualified safety manpower as per this document at all times.
4. Shall adhere to the rules and regulations mentioned in this document, practice very strictly in his area of work in consultation with his concerned engineer and the safety coordinator.
5. Shall screen all workmen for health and competence requirement before engaging for the job and periodically thereafter as required.
6. Shall ensure that all the workers are engaged after undergoing induction training.
7. Shall arrange for all necessary PPEs like safety helmets, belts, full body harness, shoes, face shield, hand gloves etc. before starting the job. Shall ensure that no working men /women carry excessive weight more than stipulated in Factory Rule Regulation R57.
8. Shall ensure that provisions stipulated in contract Labor Regulation Act 1970, Chapter V C.9, canteen, rest rooms/washing facilities to contracted employees at site.
9. Shall report all incidents (Fatal/Major/Minor/Near Miss) to the Site engineer /HSE officer of BHEL.
10. Shall conduct Safety Walks and safety inspections, and act as a role model for Safety.
11. Shall ensure that Horseplay is strictly forbidden.
12. Shall ensure that adequate illumination is arranged during night work.
13. Shall ensure that all personnel working under subcontractor are working safely and do not create any Hazard to self and to others.
14. Shall ensure display of adequate signage/posters on HSE.
15. Shall ensure that mobile phone is not used by workers while working.
16. Shall ensure conductance of HSE audit, mock drill, medical camps, induction training and training on HSE at site.
17. Shall ensure full co-operation during Client/External /Customer HSE audits.
18. Shall ensure submission of look-ahead plan for procurement of HSE equipment's and PPEs as per work schedule.
19. Shall ensure adequate valid fire extinguishers are provided at the work site.
20. Shall ensure availability of sufficient number of toilets /restrooms and adequate drinking water at work site and labor colony.
21. Shall ensure adequate emergency preparedness
22. Site In-charge also involve in the induction training so as to share knowledge of some incident and guide the worker to perform work safely.
23. Shall ensure power source for hand lamps shall be maximum of 24 v.
24. Shall ensure temporary fencing should be done for open edges if Hand – railings and Toe-

 <p>POWER SECTOR</p>	HEALTH, SAFETY AND ENVIRONMENT PLAN FOR SITE OPERATIONS (SECTION-A)	Doc. No.: HSEP:14-ER
		Rev.: 00
		Date:25.04.19
		Page 23 of 162

guards are not available.

25. Shall be responsible for the periodic testing of T&Ps (winches / crane /hydra/tools/equipment so on.) and Pressure Vessels as per applicable codes and submit report to BHEL
26. Shall be member of site HSE committee and attend all meetings of the committee

7.2.3 HSE OFFICER OF SUBCONTRACTOR

1. All requirements as per 7.2.1
2. Carry out safety inspection of Work Area, Work Method, Men, Machine & Material, P&M and other tools and tackles.
3. Facilitate HIRA and Aspect/Impact Study in the area and ensure control measures.
4. Highlight the requirements of safety through Tool-box / other meetings.
5. Help concerned HOS to prepare Job Specific instructions for critical jobs.
6. Maintain record and conduct investigation of all incident/dangerous occurrences & recommend appropriate safety measures.
7. Advice & co-ordinate for implementation of HSE permit systems, OCPs & MPs.
8. Convene HSE meeting & minute the proceeding for circulation & follow-up action.
9. Plan procurement of PPE & Safety devices and inspect their healthiness.
10. Report to BHEL on all matters pertaining to status of safety and promotional programmes at site level.
11. Encourage raising Near Miss Report on safety along with, improvement initiatives on safety.
12. Facilitate administration of First Aid
13. Facilitate screening of workmen and safety induction.
14. Conduct fire Drill and facilitate emergency preparedness
15. Design campaigns, competitions & other special programs to promote safety in the workplace.
16. Notify non-conformance to safety norms observed during site visits / site inspections.
17. Recommend to Site In-charge, immediate discontinuance of work until rectification, of such situations warranting immediate action in view of imminent danger to life or property or environment.
18. To decline acceptance of such PPE / safety equipment that do not conform to specified requirements.

7.2.4 HSE SUPERVISOR OF SUBCONTRACTOR

1. All requirements as per 7.2.1
2. To assist Safety officer

7.2.5 HSE STEWARD / OBSERVER OF SUBCONTRACTOR

1. All requirements as per 7.2.1
2. To monitor allotted area for Safety violations, take required action and inform the concerned Safety Supervisor / Officer

 <p>POWER SECTOR</p>	HEALTH, SAFETY AND ENVIRONMENT PLAN FOR SITE OPERATIONS (SECTION-A)	Doc. No.: HSEP:14-ER
		Rev.: 00
		Date:25.04.19
		Page 24 of 162

3. To assist Safety Officer and Safety Supervisor

7.2.6 HSE DOCUMENTS, SYSTEMS & PROCEDURES:

BHEL shall provide the subcontractor soft copies of all applicable HSE Procedures, Work Permits, Operational Control Procedures, Formats and any other instructions required for the implementation of HSE Management System before commencing operations at site. Subcontractor shall ensure the availability of the same.

7.2.7 IMPORTANT SITE EHS RULES RESULTING IN POSSIBLE EXPULSION FROM SITE

- ❖ Pre-employment Medical fitness is compulsory for all workers.
- ❖ EHS induction is mandatory for all new workers, supervisor and engineers, subcontractor managers etc.
- ❖ No visitors are allowed for site visit without safety induction.
- ❖ **Mandatory PPEs are**
 - ✓ Safety helmet,
 - ✓ Hard toe safety shoes,
 - ✓ Safety glasses
 - ✓ Reflective vest
 - ✓ Full/half sleeve (at least 4-inch-long) shirt
 - ✓ Full length pant/trousers for male and preferably Salwar Kameez for female
- ❖ **Zero Tolerance Safety Rules**
 - Violation of Fall protection / not anchoring & wearing safety harness above 6 feet,
 - Work without PTW
 - Child labor at site
- ❖ Restricted Use of cell phone in the working zone, operating vehicle/crane and at height. Encourage the people not to bring mobile phones inside the project premises.
- ❖ All vehicle being used at site to be in good condition in all respect.
- ❖ All electrical installations should have individual 30 mA ELCBs
- ❖ **Fighting:** Fighting anywhere on the Project site, including in parking areas, is strictly forbidden; violators will be barred from site and possibly subjected to legal action by local authorities.
- ❖ **Horseplay:** Running, pushing, practical jokes, and other horseplay are forbidden on the project site, including in parking areas.
- ❖ **Gambling:** Gambling on the Project site is not permitted
- ❖ **Alcohol & Drugs:** Intoxication or possession of alcohol or illegal drugs is strictly forbidden.
- ❖ **Weapons:** Possession of weapons on the Project site is strictly prohibited
- ❖ **Asbestos Material:** No asbestos material is allowed to use in Project Site
- ❖ **Hair:** Anyone working on site property with scalp hair longer than the top of his/her shoulders must tie-up and restrains the hair within the hard hat or coveralls, shirt or jacket collar.
- ❖ **Jewelry:** Loose necklaces, dangling earrings and bracelets shall not be worn when working on the Project site.



POWER
SECTOR

HEALTH, SAFETY AND ENVIRONMENT PLAN
FOR
SITE OPERATIONS
(SECTION-A)

Doc. No.: HSEP:14-
ER

Rev.: 00

Date:25.04.19

Page 25 of 162

- ❖ **Contact Lens:** While the site does not prohibit the wearing of contact lens, BHEL Project does not recommend their use.
- ❖ **Use of Empty Drums:** Use of empty drums to climb up and work is banned. Proper stool/ ladder/ stage required to be used if intended to work at height.
- ❖ Projects must comply in full with all applicable EHS local and national legislation. In circumstances where there is a conflict between local or national legislation and client requirements, the higher (more protective) requirement must prevail.
- ❖ All persons working on suspended scaffolds/cradles/gondolas must wear and use appropriate fall prevention equipment so as to protect them effectively at all times when they are at risk from any failure of any part of the scaffold/cradle/gondola, including its suspension system
- ❖ **Construction Trucks/Vehicles**
 - ✓ Vehicles must be equipped with proper seat belts for driver and passengers. All persons riding in vehicles must be advised of the requirement that seat belts are to be used whenever the vehicles are being operated.
 - ✓ The subcontractor is responsible for assuring the overall safe condition of vehicles assigned to its projects.
 - ✓ The speed limit on the project site is a maximum of 20 Km/hr.
 - ✓ Any person found operating or driving in a reckless or careless manner without regard for the safety of other employees or the general public will be immediately removed for the equipment they were operating and permanently prohibited from operating or driving any equipment on the project.
 - ✓ Any mobile equipment found to be unsafe or defective must be immediately removed from service and sent for repair or replacement. The subcontractor must ensure that the proper repairs have been made prior to putting the equipment back into service.
- ❖ **Construction Material Handling Heavy Equipment**
 - ✓ No equipment may be modified without equipment manufacturer's authorization.
 - ✓ Rollover Protective Structures must be provided for all equipment as required.
 - ✓ Seat belts must be provided and used by operators of all equipment that has a Rollover Protective Structure.
 - ✓ All bi-directional equipment must be equipped with an operable horn that must be used as needed when the machinery is moving in either direction.
 - ✓ All bi-directional equipment must also have an operable alarm in addition to the horn.
 - ✓ All equipment must be provided with a multi-purpose (class A, B, and C) fire extinguisher mounted in an easily accessible location.
 - ✓ Braking systems, controls, safety devices must be maintained in effective operating condition.
 - ✓ The operator must inspect the equipment at the beginning of the shift and test for acceptable



POWER
SECTOR

HEALTH, SAFETY AND ENVIRONMENT PLAN
FOR
SITE OPERATIONS
(SECTION-A)

Doc. No.: HSEP:14-
ER

Rev.: 00

Date:25.04.19

Page 26 of 162

- ✓ operation as per the equipment's manufacturer's instructions. Inspections must be documented and filed.
- ✓ Only qualified personnel must be allowed to operate equipment. Qualification must be documented and filed.

In case any worker violates any of the EHS rules identified by BHEL as above, following punitive action shall be taken:

First Offence	Second Offence	Third Offence	Fourth Offence
<i>Oral warning</i>	<i>Gate Pass Punched</i>	<i>Gate pass punched (second)</i>	<i>Gate Pass Punched(third) and person sent out of the gate</i> <i>Photo of concerned worker to be displayed on Notice boards and prominent locations.</i>

BHEL has the right to send out such person even earlier than fourth offence after considering the severity of the offence and/or the persons track record related to following general/EHS rules.

BHEL reserves right to expel even concerned supervisor or engineer as well in case of repeat of such cases of indiscipline.

Note:

The appellate authority in this case shall be the BHEL Site In-charge whose decision shall be final on the matter and binding on all parties.

8. PLANNING FOR HSE

A. Identifying Hazards / Risks & Aspects / Impacts and implementing control measures

1. Subcontractor shall identify all OHS Hazards and Risks applicable to all activities in scope as per *HSEP01: HSE Procedure for OHS Hazards and Risks*, and plan & implement the required control measures.
2. Subcontractor shall identify all Environmental Aspects and Impacts applicable to all activities in scope as per *HSEP02: HSE Procedure for Environmental Aspects and Impacts*, and plan & implement the control measures.

B. Register of Regulations:

Subcontractor shall prepare a register of applicable rules and regulations in the scope as per

 <p>POWER SECTOR</p>	HEALTH, SAFETY AND ENVIRONMENT PLAN FOR SITE OPERATIONS (SECTION-A)	Doc. No.: HSEP:14-ER
		Rev.: 00
		Date:25.04.19
		Page 27 of 162

HSEP03: HSE Procedure for Register of Regulations and plan to ensure compliance.

The detailed plans and registers in A and B to be submitted to BHEL for review and approval within 60 days of start of work at site.

Note: The plans above are dynamic and shall be periodically reviewed as per BHEL requirement.

8.1 MOBILISATION OF MACHINERY / EQUIPMENT / TOOLS

1. Subcontractor shall furnish to BHEL, the Test Certificates issued by the jurisdictional competent persons of machinery, equipment and other T&Ps to be deployed at site, before deployment. BHEL reserves the right to disallow the same if found non-conforming to HSE / legal requirements
2. As a further measure to ensure that machinery, equipment and tools being mobilized to the construction site are fit for purpose and are maintained in safe operating condition and comply with legislative and owner requirement, inspection shall be arranged by in-house expert / competent authority (preferable) for acceptance. **(Report Format: HSEP:14-F15)**
3. **The equipment considered for this purpose shall include all those in the T&P list in the tender document. Conventional Hydra crane with carriage in front shall not be permitted. Other models like FX or TRX series of Escorts or equivalent shall be permitted.**
4. In the course of work, the subcontractor shall notify the BHEL Engineer, of his intention to bring on to site any equipment or any container, with liquid or gaseous fuel or other substance which may create a hazard.
5. The Engineer shall have the right to prescribe the condition under which such equipment or container may be handled and used during the performance of the works and the subcontractor shall strictly adhere to such instructions.
6. The Engineer shall have the right to inspect any construction tool and to forbid its use, if in his opinion it is unsafe. No claim due to such prohibition will be entertained.
7. Following items should be only ISO certified and not more than 2 yr. of purchase
 - i. Chain pulley block
 - ii. Wire rope slings
 - iii. Grinding machine and wheel and buffing wheel
 - iv. Gas cutting equipment
8. Following equipment should not be more than 5 Yr. old
 1. Welding machine
 2. Vibrator Machine
 3. Concrete cutter
 4. DB/Electrical panel
9. **Office Infrastructure** - subcontractor shall arrange a computer / Laptop with Network

 <p>POWER SECTOR</p>	HEALTH, SAFETY AND ENVIRONMENT PLAN FOR SITE OPERATIONS (SECTION-A)	Doc. No.: HSEP:14-ER
		Rev.: 00
		Date:25.04.19
		Page 28 of 162

connection, chair and table for HSE Staff to facilitate HSE reporting and recordkeeping.

8.2 MOBILISATION OF MANPOWER

1. As a measure to ensure that manpower being mobilized to the construction site is fit and competent for safe working, screening arrangement shall be made by the sub-contractor to ensure fulfillment of contractual as well as legislative requirement by:
 - i. Ensuring the required qualification/ training/ certification/ license and experience for the job as per Section 7 of this document & applicable legal requirements
 - ii. **Medical Checkup:** Examination of medical fitness shall be conducted through qualified medical professional for all workers to be deployed. (Record: Format No. HSEP14:F02). For height workers, height phobia test to be carried out as qualification criteria.
 - iii. **Induction Training:** Induction training of all workers to be ensured as per clause 9.1 and HSEP04: *HSE Procedure for Training & Awareness (Record: Format No. HSEP14:F03)*

Only on successfully meeting above criteria, permanent gate passes to be issued.

2. The subcontractor shall strictly adhere to the maximum daily working hours and other requirements as per applicable laws and shall not engage any employee below 18 years of age.
3. The subcontractor shall take special care of the employees affected with occupational diseases under rule 230 and schedule II of BOCW Rules. The employees not meeting the fitness requirement should not be engaged for such job.
4. Ensure that the regulatory requirements of excessive weight limit (to carry / lift / move weights beyond prescribed limits) for male and female workers are complied with.
5. System for Issue of Gate Passes to authorized personnel only shall be ensured at site
6. The subcontractor shall keep accurate and updated records of all manpower preferably in soft form
7. The subcontractor shall ensure appropriate infrastructure for workers as per Clause 8.4.

8.3 PROVISION OF PPEs

1. Adequate numbers of Personnel Protective Equipment (PPEs), will be made available at site & their effectiveness and regular use by all will be ensured
2. The PPEs shall conform to the relevant standards as listed in Annexure 02, and bear ISI mark.
3. The following matrix recommends usage of minimum PPEs against the respective job. For details, the respective OCPs to be referred.



**POWER
SECTOR**

**HEALTH, SAFETY AND ENVIRONMENT PLAN
FOR
SITE OPERATIONS
(SECTION-A)**

Doc. No.: HSEP:14-
ER
Rev.: 00
Date:25.04.19
Page 29 of 162

Sl. No	Type of work	Suggested PPEs
1	Work at height	Double lanyard full body harness with rope grab (as applicable), retractable Fall arrestor (specific cases), Safety nets (single / double)
2	Concrete and asphalt mixing	Nose mask, hand glove, apron, gum boot, goggles
3	Welders/ Grinders/ Gas cutters	Welding/face screen, apron, hand gloves, nose mask and ear muffs if noise level exceeds 90dB. Helmet fitted with welding shield is preferred for welders, safety goggles
4	Stone/ concrete breakers	Ear muffs, safety goggles, hand gloves
5	Electrical Work	Rubber hand glove, Electrical Resistance shoes, Arc-flash resistant suit.
6	Insulation Work	Respiratory mask, Hand gloves, safety goggles
7	Grit/Sand blasting	Blast suit, blast helmet, respirator, leather gloves, safety goggles
8	Painting	Plastic gloves, Respirators (particularly for Spray painting)
9	Radiography	As per BARC guidelines
10	General	Helmets, Safety Shoes Reflective vests, ear plugs, nose masks, safety goggles

4. The exact PPEs required for a particular task shall be chosen to ensure there are multiple lines of defense against accident or injury. All applicable safety precautions for a job shall be ensured notwithstanding the duration or perceived importance of the task.
5. Additionally, the BHEL safety officer may demand additional PPEs based on specific requirement
6. The applicability of PPEs shall be as per the concept of Hierarchy of controls, i.e.:
Elimination->Substitution->EngineeringControls->AdministrativeControls-PPEs
7. Relying solely on PPEs without other applicable controls to be strictly avoided.
8. The issuing agency shall maintain register for issue and receipt of PPEs (Format No. HSEP: 14-F06A). All the PPEs shall be checked for quality before issue and the shall be periodically re-checked. The users shall be advised to check the PPEs themselves for any defect before putting on. The defective ones shall be replaced.
9. The body harnesses shall be serial numbered.
10. All worker should wear reflecting Jacket during both shift Day/Night.
11. Where workers are employed in sewers and manholes, which are in use, the subcontractor shall ensure that the manhole covers are opened and ventilated at least for an hour before the workers are allowed to get into manhole, and the manholes so opened shall be cordoned off with suitable railing and provided with warning signals or boards to prevent incident to the public
12. Besides the PPEs mentioned above, the persons shall use helmet, safety shoe and reflective vest at all times. The visitors shall use Helmet and any other PPEs as



POWER
SECTOR

HEALTH, SAFETY AND ENVIRONMENT PLAN FOR SITE OPERATIONS (SECTION-A)

Doc. No.: HSEP:14-ER
Rev.: 00
Date:25.04.19
Page 30 of 162

deemed appropriate for the area of work.

13. Following color scheme for Helmets to be maintained:
 - a. Workmen: Yellow
 - b. Safety staff: Green or white with green band
 - c. Electrician: Red
 - d. Others including visitors: White
14. The Helmets shall have logo or name (abbreviation of agency name permitted) affixed or printed on the front along with the person's gate pass no. & blood group. An awarded worker shall have reflective logo

8.4 ARRANGEMENT OF INFRASTRUCTURE

The subcontractor is responsible for ensuring and maintaining the required HSE infrastructure at site as described in this Section

8.4.1 DRINKING WATER

1. Drinking Water Storage Tanks shall be provided and maintained at suitable places at different elevations / locations to ensure easy accessibility. The tank/container shall be kept on a platform at an elevation of at least 2 feet and should be covered:



2. **Construction and Quantity:** The design of Drinking Water Storage Tank (DWST) shall be submitted to BHEL for approval prior to initiating construction. Provision of 5 liter water daily for each worker to be maintained.
3. **Labelling:** DWST should be labeled as "Drinking Water". Date of last cleaning, next due date shall be indicated on the container besides Date of source testing as per IS 10500.
4. Cleaning of the DWST shall be ensured at least once in a week. Mild cleaning detergents as used for cleaning vessels shall be applied and scrubbers (3M or equivalent) shall be used for removing scales and deposits on the inside surface. The tank shall be thoroughly cleaned with potable water only before it is refilled.
5. Suitability of the water source should be tested as per IS10500.
6. For all tanks containing water unsuitable for drinking, prominent "Do Not Drink" signage shall be pasted in English, Hindi and local language.
7. In Hot Work and other critical areas, drinking water shall be made available near the activity
8. Provision of supplying drinking water to height workers and those working in difficult to reach

 <p>POWER SECTOR</p>	HEALTH, SAFETY AND ENVIRONMENT PLAN FOR SITE OPERATIONS (SECTION-A)	Doc. No.: HSEP:14-ER
		Rev.: 00
		Date:25.04.19
		Page 31 of 162

areas shall be made available through dedicated personnel.

- 8.4.2 **PROVISION OF LATRINES AND URINALS AT SITE** (Ref: Interstate Migrant Workmen (Regulation & Employment and Act, 1979) read with The Inter-State Migrant Workmen (Regulation of employment and conditions of service) central rules, 1980 (PI refer rule no. 42)

LATRINES

1. Latrines shall be provided in every establishment on the following scale, namely: -
 - a. Where females are employed, there shall be at least one latrine for every 25 females;
 - b. Where males are employed, there shall be at least one latrine for every 25 males:

Provided that where the number of males or females exceeds 190, it shall be sufficient if there is one latrine for 25 males or females, as the case may be, up to the first 100, and one for every 30 thereafter

2. Every latrine shall be under cover and so partitioned off as to secure privacy, and shall have a proper door and fastenings.
3. Where workers of both sexes are employed there shall be displayed outside each block of latrine and urinal a notice in the language understood by the majority of the workers '**For Men Only**', or '**For Women Only**', as the case may be.
4. The notice shall also bear the figure of a man or of a woman, as the case may be.

URINALS

5. There shall be at least one urinal for male workers up to fifty and one for female up to fifty employed at a time:
6. Provided that where the number of male or female workmen, as the case may be, exceeds 500 it shall be sufficient if there is one urinal for every fifty females up to the first 500 and one for every 100 or part thereof thereafter.
7. The urinals shall be designed and located so as to ensure privacy.
8. In case a structure encompasses multiple floors, urinals shall be provided suitably for quick access
9. The latrines and urinals shall be conveniently situated and accessible to workers at all times at the establishment.
10. The latrines and urinals shall be adequately lighted and shall be maintained in a clean and sanitary condition at all times.
11. Latrines and urinals other than those connected with a flush sewage system shall comply with the requirements of the public health authorities.
12. Water shall be provided by the means of tap or otherwise so as to be conveniently accessible in or near the latrines and urinals.

8.4.3 WASHING FACILITIES

1. In every workplace, adequate and suitable facilities for washing shall be provided and maintained.
2. Separate and adequate cleaning facilities shall be provided for the use of male and female workers. Such facilities shall be conveniently accessible and shall be kept in clean and hygienic

 <p>POWER SECTOR</p>	HEALTH, SAFETY AND ENVIRONMENT PLAN FOR SITE OPERATIONS (SECTION-A)	Doc. No.: HSEP:14-ER
		Rev.: 00
		Date:25.04.19
		Page 32 of 162

condition and dully illuminated for night use.

3. Overalls shall be supplied by the subcontractor to the workmen and adequate facilities shall be provided to enable the painters and other workers to wash during the cessation of work.

8.4.4 PROVISION OF REST SHELTER FOR WOKERS

Proper Sheds & Shelters big enough to accommodate all possible workers shall be provided for workers to rest during break. Taking rest at height, in activity area and other hazardous locations shall not be allowed.

The drawing of such sheds shall be submitted to BHEL for approval before construction.

8.4.5 MEDICAL FACILITIES

Refer Section B for applicability of requirements pertaining to Clause 8.4.5.1

8.4.5.1 MEDICAL CUM FIRST-AID CENTER

- a) A medical center shall be setup at site with basic facilities for handling medical emergencies. The medical center shall be developed independently by BHEL/an agency as specified in the contract and run jointly by all agencies on proportionate sharing basis as stipulated in the contract.
- b) A qualified medical professional, not less than MBBS, shall be deployed at medical center as stipulated in the contract.(Part-time or full time as decided at the site).
- c) There shall be a full-time trained first aider and a nurse. Depending upon the working hours at the site, First-aider shall be deployed accordingly.
- d) The center shall have all articles as per Schedule IV of BOCW(Central) Rules'1998. In addition,, one Stokes basket stretcher shall be available.
- e) An ambulance shall be deployed for every 1000 persons along with trained driver and accessories as per schedule V of Central BOCW Rules'1998. Depending upon the working hours at the site, First-aider shall be deployed accordingly.
- f) The center shall be adequately equipped for Resuscitation, Immobilisation, Dressing, dealing with poisoning cases including snake and insect-bites and sufficient stock of emergency medicines as prescribed by the qualified medical professional as per point (b)

8.4.5.2 IMPORTANT

- g) If there is no specific mention of responsibility of deployment or setting up of any of the above facilities and operating expenses thereof, BHEL site management shall have the liberty to give this responsibility to any of the contractors on cost sharing basis.
- h) Medical waste shall be disposed as per prevailing legislation (Bio-Medical Waste –Management and Handling Rules, 1998)
- i) Every injury shall be treated, recorded and reported.
- j) All First Aid injuries shall be recorded as per Format No. HSEP:14-F17
- k) List of qualified first aiders and their contact numbers to be displayed at conspicuous places.



POWER
SECTOR

HEALTH, SAFETY AND ENVIRONMENT PLAN
FOR
SITE OPERATIONS
(SECTION-A)

Doc. No.: HSEP:14-
ER

Rev.: 00

Date:25.04.19

Page 33 of 162

8.4.5.3 FIRST AID

A. In addition to 8.4.5.1 &2, The subcontractor with Boiler&ESP, TG, Civil shall:

1. Provide necessary first aid facilities for every work place.
2. Ensure availability of qualified First-aider throughout the working hours.
3. Every injury shall be treated, recorded and reported.
4. Refresher course on first aid shall be conducted as necessary.
5. List of qualified first aiders and their contact numbers to be displayed at conspicuous places.
6. All First Aid injuries shall be recorded as per Format No. HSEP:14-F17

B. FIRST AID BOX

1. The first aid box shall be maintained by first aider who shall always be readily available during the working hours of the work place.
2. **Details of First Aid Box:**
 - a) Details of contents of first aid box is given in **Annexure 03**. A slip of contents shall be pasted on the First Aid Box with following details:

Name, Quantity, Expiry Date, Checked by...
 - b) First Aider's name and contact no to be displayed on the box.
 - c) The first aid box shall be distinctly marked with a Green Cross on white background.
 - d) The box shall be properly secured with lock & key to avoid misuse
7. The first aid boxes should be placed at various locations so as to make them available within easy reach of hazardous activities and at the quickest possible time.
8. The subcontractor shall ensure that the Supervisors and Engineers are adequately trained for attending to any emergency.
9. Monthly inspection of First Aid Box to be conducted by the subcontractor as per Format no. HSEP:14-F01

8.4.5.4 HEALTH CHECK UP

The persons engaged at the site shall undergo health checkup as per the **Format no. HSEP:14-F02** before induction. The persons engaged in the following works shall additionally undergo regular health checkup using same Format at least once in a year:

Height workers	Drivers/crane operators/riggers	Confined space workers
Shot/sand blaster	Welding and NDE personnel	Any person referred by BHEL

8.4.5.4.1 HEIGHT PHOBIA TEST

1. The persons engaged in working at heights (above 2 meters) to be assessed for Height Phobia and associated conditions.
2. Such workers are to be allowed only on successful completion of this test, otherwise they shall be allocated ground based jobs. IDs / Height passes shall be issued to such workers.

8.4.6 PROVISION OF CANTEEN FACILITY



POWER
SECTOR

HEALTH, SAFETY AND ENVIRONMENT PLAN
FOR
SITE OPERATIONS
(SECTION-A)

Doc. No.: HSEP:14-
ER
Rev.: 00
Date:25.04.19
Page 34 of 162

Minimum or better facilities to be ensured as per BOCW (Rule 244) / Factories Act, specially taking care of the following:

1. Canteen facilities shall be provided for the workmen of the subcontractor inside the project site.
2. Proper cleaning and hygienic condition shall be maintained.
3. Proper care should be taken to prevent biological contamination.
4. Adequate drinking water should be available at canteen.
5. Fire extinguisher shall be provided inside canteen.
6. Regular health check-up and medication to the canteen workers shall be ensured.
7. Canteen waste to be disposed of in compliance with law
8. Domestic LPG cylinder shall not be used
9. Canteen should be periodically inspected using standard checklist finalized along with BHEL

8.4.7 PROVISION OF ACCOMMODATION / LABOR COLONY

1. The subcontractor shall provide to every workman (within fifteen days of the commencement of the employment of migrant workmen):
 - a) In case he is accompanied by any other member of his family, a suitable barrack so as to accommodate one room having at least a floor area of 10 square meters, a verandah and adequate additional covered space for cooking food as well as one common sanitary latrine, one common bathroom for every three such quarters; and
 - b) In case he is unaccompanied by any other member of his family, a suitable barrack so as to accommodate not more than ten such migrant workmen, having at least a floor area of not less than 6.5 square meters for each such migrant workman making use of the barrack, a verandah and adequate additional covered space for cooking food as well as one common sanitary latrine and one common bathroom for every ten such migrant workmen
2. Every quarter and the barrack shall be so constructed as to afford adequate ventilation, protection against heat, wind, rain and shall have smooth, hard and impervious floor surface.
3. The quarters or the barracks, as the case may be, shall be at a convenient distance from the establishment and shall have adequate supply of wholesome drinking water.
4. The area in which the quarters and/or barracks are located as well as the latrines and bathrooms provided therein shall be kept in a clean and sanitary condition at all times.
5. Regular housekeeping of the labor colony shall be ensured.
6. Availability of Bathing/ washing bay to be ensured



POWER
SECTOR

HEALTH, SAFETY AND ENVIRONMENT PLAN
FOR
SITE OPERATIONS
(SECTION-A)

Doc. No.: HSEP:14-
ER
Rev.: 00
Date:25.04.19
Page 35 of 162

7. Room ventilation and safe electrification to be ensured
8. MSDS of LPG shall be put up prominently and shall be included in the induction training also.
9. The labor colony shall be secure so that only authorized persons have access to it.
10. Availability of local market to be ensured by the Sub-contractor
11. A "Suggestion Register" shall be made available at the labor colony for workers. The feedback shall be reviewed on weekly basis and acted upon.
12. Labor colony shall be inspected fortnightly by Subcontractor Safety Officer & HR executive, and report submitted to BHEL as per Format No. HSEP:4-F16
13. **Facility of Crèches** – to be provided wherein more than fifty female workers are deployed
14. Provisions of Clause 8.4.1, 8.4.2 and 8.4.3 shall be applicable on labor colony as well

8.4.8 PROVISION OF EMERGENCY VEHICLE

Dedicated emergency vehicle shall be made available at workplace by subcontractor for evacuation of victim from site.

However, Ambulance shall be used exclusively for transporting victim to hospital

8.4.9 PEST CONTROL

Regular pest control should be carried out at all offices, mainly laboratories, canteen, labor colony and stores by the subcontractor.

8.4.10 SCRAPYARD

1. Scrapyard shall be developed by subcontractor to store metal scrap, wooden scrap, waste, hazardous waste.
2. Scrap/Waste shall be segregated as Bio-degradable and non-bio-degradable and stored separately.

8.4.11 ILLUMINATION

1. The subcontractor shall provide adequate lighting facilities e.g. flood lighting, hand lamps, area lights etc. to ensure adequate lighting at all work places & their approaches including passage ways as per IS: 3646 (Part-II) at all times. Indicative recommended values are given below:

S. No.	Location	Lux Level
A.	Construction Site	
1	Outdoor areas like store yards, entrance and exit roads	20
2	Platforms	50
3	Entrances, corridors and stairs	100
4	General illumination of work area	150
5	Rough work like fabrication, assembly of major items	150



**POWER
SECTOR**

**HEALTH, SAFETY AND ENVIRONMENT PLAN
FOR
SITE OPERATIONS
(SECTION-A)**

Doc. No.: HSEP:14-
ER
Rev.: 00
Date:25.04.19
Page 36 of 162

6	Medium work like assembly of small machined parts	300
7	Fine work like precision assembly, precision measurements etc.	700
8	Sheet metal works	200
9	Electrical and instrument labs	450
B.	Office	
1	Outdoor area like entrance and exit roads	20
2	Entrance halls	150
3	Corridors and lift cars	70
4	Lift landing	150
5	Stairs	100
6	Office rooms, conference rooms, library reading tables	300
7	Drawing table	450
8	Manual telephone exchange	200

In case any area is not mentioned above, the applicable illumination for the same shall be specified by BHEL based on applicable standards and international norms

1. Level of illumination shall be checked periodically using a calibrated lux meter and recorded for each work area on minimum weekly basis as per Format No. HSEP:14-F21
2. Lamp (hand held) shall not be powered by mains supply but either by 24V or dry cells.
3. Lamps shall be protected by suitable guards where necessary to prevent danger, in case of breakage of lamp.
4. Emergency lighting provision for night work shall be made to minimize danger in case of main supply failure.

9. HSE TRAINING & AWARENESS

9.1 HSE INDUCTION TRAINING

1. All persons entering into project site shall be given HSE induction training before being assigned to work, which shall be imparted through audio-visual medium and shall be of minimum 2-hour duration.
2. Any single trainee batch size should not exceed 40.
3. Proper safety wear & gear must be issued to all the workers being registered for the induction (i.e., Shoes/Helmets/Goggles/Leg guard/Apron etc.)
 - i. They must arrive fully dressed in safety wear & gear to attend the induction.
 - ii. Any one failing to conform to this safety wear& gear requirement shall not qualify to attend.
4. In-house induction training subjects shall include but not limited to:



**POWER
SECTOR**

**HEALTH, SAFETY AND ENVIRONMENT PLAN
FOR
SITE OPERATIONS
(SECTION-A)**

Doc. No.: HSEP:14-
ER
Rev.: 00
Date:25.04.19
Page 37 of 162

- i. Briefing of the Project details and importance of employee for the project and for the nation.
 - ii. Safety related cardinal rules, objectives and targets.
 - iii. Site HSE rules.
 - iv. Site HSE hazards and aspects.
 - v. First aid facility.
 - vi. Emergency Contact No. and procedures
 - vii. Details of Fire prevention and emergency response systems & procedures at site.
 - viii. Requirement of incident / near miss reporting by all.
 - ix. Accident case studies
 - x. Rules to be followed in the labor colony (if applicable)
5. Evaluation to be carried out after training and induction training to be repeated in case of failure of participant in evaluation
 6. On completing subcontractor's in-house HSE induction, each employee shall sign an induction training form (format no. HSEP: 14-F03) to declare that he had understood the content and shall abide to follow and comply with safe work practices. They may only then be qualified to be issued with a personal I.D. card, for access to the work site (provided Health Checkup is over).

9.2 HSE TOOLBOX TALK

1. HSE Tool Box talk shall be conducted by frontline foreman/supervisor of subcontractor to specific work groups daily prior to the start of work. The agenda shall consist of the following:
 - i. Visual checkup of workers regarding health, any signs of fatigue, intoxication etc.
 - ii. Details of the job being intended for immediate execution.
 - iii. The relevant hazards and risks involved in executing the job and their control measures.
 - iv. Specific site condition to be considered while executing the job like high temperature, humidity, unfavorable weather etc.
 - v. Recent non-compliances observed.
 - vi. Appreciation of good work and warning for any unsafe acts done by any person.
 - vii. Any doubt clearing session at the end
2. Record of Tool box talk shall be maintained as per Format no. HSEP:14-F04

9.3 TRAINING ON HEIGHT WORK

Due to the large percentage of fall from height in incidents, training of minimum 2-hour duration on height work shall be imparted to all height workers by in- house / external faculty for every batch of new inductees. The training shall include following topics:

1. Inspection of work area, access and egress w.r.t height hazards
2. Use of PPEs; use of fall arrester, retractable fall arrester, life line, safety nets etc.
3. Safe climbing through monkey ladders.
4. Inspection of PPEs.
5. Medical fitness requirements.
6. Mock drill on rescue at height.
7. Dos & Don'ts during height work.

 <p>POWER SECTOR</p>	HEALTH, SAFETY AND ENVIRONMENT PLAN FOR SITE OPERATIONS (SECTION-A)	Doc. No.: HSEP:14-ER
		Rev.: 00
		Date:25.04.19
		Page 38 of 162

8. Accident case studies

In case, above is organized by BHEL, proportionate cost shall be borne by subcontractors

9.4 HSE TRAINING DURING PROJECT EXECUTION

1. HSE training shall be arranged by subcontractor as per the need of the project execution and recommendation of BHEL.
2. The topics of the HSE training shall be as follows but not limited to:
 - i. Hazards identification and risk analysis & Identification of Environmental Aspects / Impacts
 - ii. Work Permit System
 - iii. Learning from past incidents
 - iv. First aid, Firefighting & Fire-warden training
 - v. EMS and OHSMS
 - vi. T & Ps fitness and operation
 - vii. Electrical & Chemical safety
 - viii. Welding, NDE & Radiological safety
 - ix. Material handling.
3. Safety awareness and on-the-job training programmes shall be carried out at site for all workers periodically. Periodicity to be decided by BHEL but shall be minimum once in six months
4. Penalty Training – In case of any incident, the involved person, group or agency shall undergo a penalty HSE training for a minimum period of 2 hrs or as decided by BHEL.
5. In case it is not possible to provide training to all workers at once, same shall be imparted in Batch-wise manner so as to cover all workers with specified periodicity.
6. An up-to-date record to be maintained with attendance of participants and trainers preferably in soft copy as per Format No. HSEP:14-F03.
7. Every employee of agency should be provided at least 2 hr. safety training in every month.

In case, above is organized by BHEL, proportionate cost shall be borne by subcontractors

10. HSE PROMOTION: SIGNAGE, POSTERS, COMPETITION, AWARDS ETC

10.1 DISPLAY OF HSE POSTERS AND BANNERS

Site shall arrange appropriate posters, banners, slogans in local/Hindi/English languages at work place.

10.2 DISPLAY OF HSE SIGNAGE

Appropriate HSE signage shall be displayed at the work area to enhance awareness of HSE workmen and passersby about the work going on and do's and don'ts to be followed.

10.3 COMPETITIONS ON HSE, AWARDS & REWARDS



POWER
SECTOR

HEALTH, SAFETY AND ENVIRONMENT PLAN
FOR
SITE OPERATIONS
(SECTION-A)

Doc. No.: HSEP:14-
ER

Rev.: 00

Date:25.04.19

Page 39 of 162

1. Subcontractor shall arrange competitions (slogan, poster, essay etc.) on HSE for workers and employees from time to time (Safety day, World Environment Day etc. minimum one such function each month) and winners will be suitably awarded during the functions.
2. Subcontractor shall identify workers following good HSE practices and reward them from time to time as encouragement to follow good HSE practices.
3. Alternatively, if a common monthly function is organized at site, subcontractor shall participate in the same so that a minimum frequency of one such function per month is maintained.

10.4 HSE AWARENESS PROGRAMMES

Subcontractor shall arrange HSE awareness programmes periodically on different topics including medical awareness for all personnel working at site from time to time including officials involved in execution.

11. HSE COMMUNICATION AND PARTICIPATION

11.1 MONTHLY HSE REPORTING

1. HSE activities shall be reported to BHEL monthly as per Format no. HSEP: 14-F05. The reporting medium can be hard/soft as per BHEL requirement.
2. The period of reporting shall be 25th of the preceding month to 24th of the present month and report shall be submitted by the end of the calendar month or as conveyed by BHEL.
3. BHEL can modify the reporting requirements as per requirement

11.2 HSE EVENT REPORTING

1. Important HSE events like HSE Training, Mock / Fire/Rescue Drills, Medical camp etc. organized by subcontractor shall be reported to BHEL in detail with photographs
2. Celebration of important days like National Safety Day, World Environment Day etc. shall also be reported likewise.

11.3 HSE INCIDENT REPORTING

All incidents (near misses, property damage, first-aid cases, minor, major and fatal incidents) shall be reported to BHEL as they happen through SMS and Hard/Soft copy as per Format No. HSEP: 14-F22

11.4 HSE SUGGESTIONS

All workers and employees to be encouraged to provide suggestions for improvement in

 <p>POWER SECTOR</p>	HEALTH, SAFETY AND ENVIRONMENT PLAN FOR SITE OPERATIONS (SECTION-A)	Doc. No.: HSEP:14-ER
		Rev.: 00
		Date:25.04.19
		Page 40 of 162

Health, Safety & Environment at site. The suggestions to be recorded in a "Suggestions Register". Suggestions to be reviewed and those having potential of significant beneficial effects are to be implemented, and recognition / award to be given to the individual.

11.5 CLIENT COMMUNICATON

All HSE related communication from BHEL, customer / external statutory and regulatory agencies to be handled on priority. The relevant issues to be resolved in expeditious manner

11.6 RECORDS OF COMMUNICATON

Records of all communication and their responses as detailed above shall be maintained by subcontractor in hard / soft copy and produced when required.

12. INCIDENT REPORTING, INVESTIGATION & CORRECTIVE ACTION

1. A conducive environment for reporting of near misses and other incidents shall be developed at site through system of rewards etc.
2. Priority to be given to ensure medical treatment of the victim. Victim to be given immediate First Aid and transported to Medical Facility in a well-equipped Ambulance
3. All incidents, as they happen, shall be reported to BHEL immediately over phone/SMS/Whatsapp/mail and then in Format No. HSEP:14-F22 within 24 hrs. of occurrence. Immediate SMS shall be sent to concerned Package In-charge with following Details:

- a. Project & Customer Name:
- b. Subcontractor Name & Scope:
- c. Incident Area:
- d. Number of Injured / Fatalities:
- e. Date & Time of Accident:
- f. Incident Description in few lines:

No incident shall be hidden

4. Records of all incidents shall be maintained in hard / soft copy as per Format No. HSEP:14-F23.
5. For all incidents:
 - a. The incident area, equipment / tools involved, documents & records etc. shall be maintained as-it-is pending investigation
 - b. Root Cause Analysis (RCA) to be conducted and corresponding Corrective / Preventive Action (CAPA) ensured
 - c. Responsibility shall be assigned and action to be taken against the erring individual
 - d. In case presence of manufacturer of the equipment involved is required, subcontractor will arrange the same

 <p>POWER SECTOR</p>	HEALTH, SAFETY AND ENVIRONMENT PLAN FOR SITE OPERATIONS (SECTION-A)	Doc. No.: HSEP:14-ER
		Rev.: 00
		Date:25.04.19
		Page 41 of 162

- e. All expenses pertaining to the RCA / CAPA shall be borne by the subcontractor
6. RCA and CAPA reports of all near misses and minor injuries shall be identified and report submitted to BHEL within 7 days of occurrence.
 7. For incidents, where worker does not resume duty within 48 hours of occurrence, Joint investigation along with BHEL shall be conducted within 7 days, and CAPA ensured.
 8. Corrective action shall be immediately implemented at the work place. Work shall be put on hold in the area till corrective actions are verified by BHEL
 9. All incidents, their Root Cause Analyses and Corrective actions shall be recorded, and analyzed so as to identify weak areas and actions to be taken to reduce the incident trend.

13. SAFETY DURING WORK EXECUTION

13.1 HSE SYSTEMS AND PROCEDURES

BHEL Power Sector HSE Management System (HSEMS) shall be referred for controlling hazards, aspects, and carrying out HSE activities at site. Subcontractor shall get familiar with and follow the HSEMS documents provided by BHEL which include the follows:

13.1.1 HSE PROCEDURES:

All HSE Procedures defined in HSEMS, as referred in various sub-clauses of this Section as given in Annexure 01

13.1.2 PERMIT TO WORK (PTW) SYSTEM

1. The following activities shall be carried out by the subcontractor strictly after obtaining Permit to Work (PTW) from BHEL
 - i. General Work Permit (**Format No. HSEP14-FP01**)
 - ii. Height working (**Format No. HSEP14-FP02**)
 - iii. Hot working (**Format No. HSEP14-FP03**)
 - iv. Confined space Work (**Format No. HSEP14-FP04**)
 - v. Excavation more than 2-meter depth (**Format No. HSEP14-FP05**)
 - vi. Radiography / Radiation Work (**Format No. HSEP14-FP06**)
 - vii. Heavy / Complex / Critical Lifting Activity (**Format No. HSEP14-FP07**)
 - viii. Night / Holiday Work (**Format No. HSEP14-FP08**)
 - ix. Material Loading / Unloading Permit (**Format No. HSEP14-FP09**)
 - x. Grating / Safety Net / Safety Facility Removal Permit (**Format No. HSEP14-FP10**)
 - xi. Live Electrical Maintenance etc. - Lockout / Tag (**Format No. HSEP14-FP07**)



**POWER
SECTOR**

**HEALTH, SAFETY AND ENVIRONMENT PLAN
FOR
SITE OPERATIONS
(SECTION-A)**

Doc. No.: HSEP:14-
ER
Rev.: 00
Date:25.04.19
Page 42 of 162

2. The above list is not exhaustive. BHEL reserves right to introduce additional Permits or modify requirements for usage of existing Permits. The conditions for using the Permit are specified in the Format (General Requirements).
3. Where customer is having separate Work Permit System the same shall be followed in conjunction to ensure all activities and checks are covered in all systems.
4. Permit applicant shall apply for work permit of particular work activity at particular location before starting of the work along with Job Hazard Analysis.
5. All Permit signatories shall physically visit the work area and check that all the safety control measures necessary for the activity are in place. Only then the permit shall be issued.
 - a. Signatory shall physically visit the area of work and ensure all required safeguards before signing the Permit
 - b. Signatory shall periodically visit the area to confirm the availability of required safeguards throughout the currency of the permit
 - c. In case any Permit requirement is not available, work will be stopped till it is made available
6. Permit holder shall implement and maintain all control measures during the period of permit. The permit will be closed after completion of the work and submitted to BHEL.

13.1.3 Operational Control Procedures

1. All applicable OCPs (Operational Control Procedures) as identified from outcomes of HIRA, Aspect / Impact studies and BHEL inputs will be followed by subcontractor. This will be done as part of normal scope of work.
2. Illustrative list of such OCPs is given in Table 13.1 and same will be made available to subcontractor by BHEL during work execution at site.
3. In case any other OCPs are required or existing ones need to be modified in order to control the risks / impacts associated with any activity during the execution of work subcontractor shall prepare / update and follow the same with information to BHEL.

Table 13.1 - LIST of Reference OCPs

No.	Topic	No.	Topic	No.	Topic
0	General Safety	20	Oil flushing	40	Gas distribution test
1	Handling of chemicals	21	Alkali boil out	41	Cleaning of Hotwell / Deaerator
2	Electrical safety	22	Steam blowing	42	Electrical maintenance
3	Energy conservation	23	Working in confined area	43	O&M of control of AC plant & system
4	Welding and gas cutting operation	24	Operation of passenger lift, material hoists & cages	44	Material preservation
5	Fire safety	25	Vehicle/ Crane maintenance	45	Electro-resistance heating
6	Use of hand tools	26	Radiography	46	Blasting
7	First aid	27	Waste disposal	47	Transformer charging



**POWER
SECTOR**

**HEALTH, SAFETY AND ENVIRONMENT PLAN
FOR
SITE OPERATIONS
(SECTION-A)**

Doc. No.: HSEP:14-
ER
Rev.: 00
Date:25.04.19
Page 43 of 162

8	Food safety at canteen	28	Handling & storage of mineral wool	48	Handling of battery system
9	Use of cranes	29	Working at night	49	DG set
10	Storage and handling of gas cylinders	30	Computer operation	50	Sanitary maintenance
11	Manual arc welding	31	Storage in open yard	51	Piling rig operation
12	Use of helmets	32	Drilling, reaming and grinding(machining)	52	Passivation
13	Good house keeping	33	Stress relieving	53	EDTA Cleaning
14	Safe excavation	34	Hydraulic test	54	Chemical cleaning of Pre boiler system
15	Working at height	35	Trial run of rotary equipment	55	Boiler Light up
16	Filling of hydrogen in cylinder	36	Batching	56	Rolling and Synchronization
17	Illumination	37	Cable laying/tray work	57	Loading of Unit
18	Handling and erection of heavy metals	38	Spray insulation	58	Air compressor
19	Acid cleaning	39	Compressor operation	59	Hydra Operation

13.2 ACTIVITY SPECIFIC REQUIREMENTS FOR SAFETY:

All Work shall be commenced only after taking the respective Work Permits (as applicable) and precautions as per relevant codes, systems and OCPs in order to ensure safe conditions throughout the duration of work. Additionally, activity specific safeguards as per this section shall be followed.

13.2.1 WORK AT HEIGHT:

1. All work at height above 2 meter above ground level without complete platforms, handrails and other related fall protection shall require a work permit in the prescribed form. This shall require approval by the competent authority. The HSE officer of sub-contractors shall follow the checklist religiously by physically verifying the condition of the work area before recommending for approval.
2. Prior to the start of work at elevation, the HSE Officer involved with the work must meet the work supervisor to review the scope of work, and must review all the possible fall hazards and effective safety responses. The evaluation / analysis must be documented and kept on file and on site by the HSE Officer.
3. Whenever a fall hazard or other exposure exists for working at heights more than 2.0m/6ft, the nature and scope of work will be evaluated for conditions and environmental factors before selecting the appropriate fall protection system (active, passive or a combination of measures, as appropriate).



POWER
SECTOR

HEALTH, SAFETY AND ENVIRONMENT PLAN
FOR
SITE OPERATIONS
(SECTION-A)

Doc. No.: HSEP:14-
ER

Rev.: 00

Date:25.04.19

Page 44 of 162

4. All Engineering and Administrative Controls including barricading, safe platform, Safety Nets etc. shall be made available at work location. Under no circumstances, there shall be total reliance on PPEs only
5. **Safety Nets**
 - a. Contractor shall maintain sufficient stock of Safety Nets for deployment
 - b. Safety Nets as per IS: 11057:1984 should be used extensively for prevention / arrest men and materials falling from height.
 - c. The safety nets shall be fire resistant, duly tested and shall be of ISI marked.
 - d. Safety Nets shall be deployed below all platforms where height work is envisaged. Duration of work, delay shall be no excuses for non-installation of Safety Net
6. Reaching beyond barricaded area without lifeline support, moving with support of bracings, walking on beams without support, jumping from one level to another, throwing objects and taking shortcut must be discouraged.
7. Monkey Ladder shall be fitted with cages. Rope ladder should be discouraged.
8. In case of pipe-rack, persons should not walk on pipes and walk on platforms only.
9. In case of roof work, walking ladder/ platform should be provided along with lifeline and/ or fall arrestor.
10. For chimney or structure painting, both hanging platform and men should be anchored separately to a firm structure along with separate fall arrestor.
11. The procedures for the safety response to identified fall hazards developed and rescue plans must be reviewed with all individuals exposed to the hazards.
12. The HSE Officer must establish an inspection process of fall protection systems. Some equipment requires documented inspections by its manufacture on a regular schedule. Such equipment must have evidence of the inspection and re-certification process on it. This information must be reviewed before the equipment is actually used. Individuals must visually inspect the fall protection equipment before each use. Failure to complete this inspection process could result in serious injury or death.
13. Immediately remove from service any fall protection equipment that is identified as defective, damaged, or has been subjected to an impact. Damaged fall protective equipment must be destroyed to prevent re-use and not be discarded into trash containers, as the worn or damaged equipment could be unintentionally re-used.
14. Aerial lifting devices, excluding scissor lifts require the use of full body harnesses and lanyards in any elevated position.



POWER
SECTOR

HEALTH, SAFETY AND ENVIRONMENT PLAN
FOR
SITE OPERATIONS
(SECTION-A)

Doc. No.: HSEP:14-
ER

Rev.: 00

Date:25.04.19

Page 45 of 162

13.2.1.1 Personnel fall protection system must include:

a. Safety Harness

All height workers must use Safety harness with double lanyards. The primary lanyard is never unhooked until the secondary lanyard is secure. The design of the working platform should be such that **under no circumstances, worker should have both lanyards unhooked while at height.**

b. Lanyard

- i. The type of work and the environment conditions determine lanyard and lifeline selection. If welding, chemical cleaning that may damage lanyards, connectors or lifelines, sandblasting, etc., either protect the components or use more appropriate type of system.
- ii. Lanyards and lifelines must incorporate, or be used with, an appropriate deceleration (shock absorbing) device. Deceleration devices include rope grabs, rip-stitch lanyards, specially woven lanyards, tearing, or deforming lanyards, automatic self-retracting lifelines and lanyards which dissipate or limit the energy imposed on the employee during fall arrest.
- iii. Once in use, the system's effectiveness is to be monitored. In some cases, a program for cleaning and maintaining the system may be necessary. Lanyard and lifelines must use locking snap hooks only and under no circumstances must two lanyard snap hooks be connected.

c. Lifeline

All lifelines in general are to be made of min 8mm dia steel rope (plastic coated) and tied to columns with 3 clamps at each end. Wherever columns are not available to tie the lifelines, the vertical posts as per the design below are to be provided after carrying out drop load test initially. A load of 240kg to be dropped off the mid-point of lifeline in this test.

d. Lifeline Post



POWER
SECTOR

HEALTH, SAFETY AND ENVIRONMENT PLAN
FOR
SITE OPERATIONS
(SECTION-A)

Doc. No.: HSEP:14-
ER
Rev.: 00
Date:25.04.19
Page 46 of 162

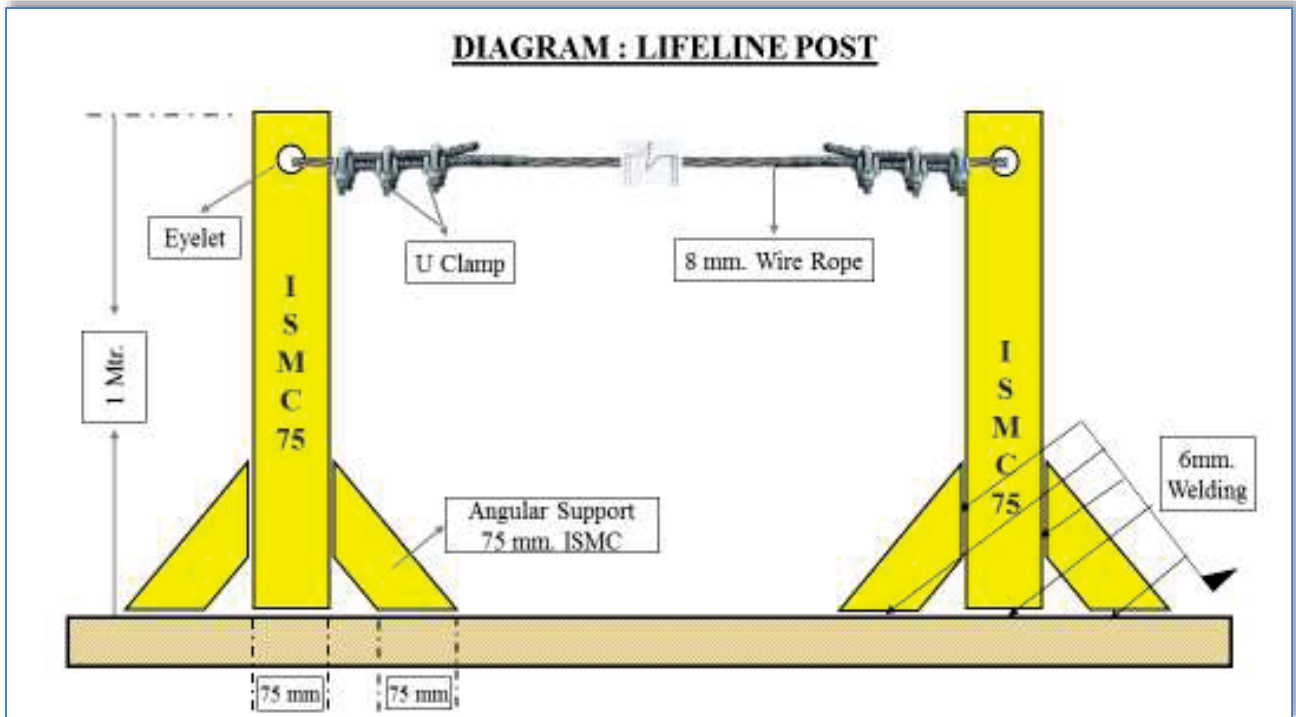

Fig. 13.2.1.1 Lifeline Post

- i. The support at vertical post shall be fixed at end-to-end. The maximum length of one end to another end shall be 18 meters
- ii. If the length of a lifeline is more than 18 meters, then intermediate vertical post(s) are to be used. Such intermediate post(s) will act as supports and the lifeline rope should simply pass through the eyelets (holes) of such supports without being anchored
- iii. The lifeline need not be wrapped / clamped to any intermediate post
- iv. Such intermediate posts must be used at an interval of every 18 meters
- v. The post(s) in which the original lifeline is to be installed should be capable of sustaining a tensile stress of 2268 Kgs
- vi. In a horizontal lifeline installation, maximum allowable sagging is 500-600 mm
- vii. For a single spun lifeline, no more than 2 persons are allowed to work; for more than two workers, another lifeline should be installed
- viii. Horizontal lifeline should be so installed that it does not impede safe movement of workers
- ix. All the installation work must be carried out by competent person with adequate knowledge

13.2.1.2 Working Platform

1. Working platforms, gangways and stairways shall be so constructed that they do not sag unduly or unequally and if the height of the platform gangways provided is more than 3.6 m above ground level or floor level, they shall be closely boarded and shall have adequate width, which shall not be less than 750 mm and be suitably fenced.

2. Precautions against the fall of Materials, Persons and Collapse of Structures



**POWER
SECTOR**

**HEALTH, SAFETY AND ENVIRONMENT PLAN
FOR
SITE OPERATIONS
(SECTION-A)**

Doc. No.: HSEP:14-
ER
Rev.: 00
Date:25.04.19
Page 47 of 162

- i. Every opening in the floor or a building or in a working platform shall be suitably barricaded to prevent the fall of persons by providing suitable fencing or railing whose minimum height shall be 90 cm.
- ii. Adequate precautions should be taken such as the provision of fencing, or barriers to protect any person who might be injured by the fall of materials, or tools or equipment being raised or lowered. Cradle may be used for lifting materials - however this shall be made of MS angles and flats only and duly certified by the HSE officer. Operators may also use designed containers for lifting small tools.
- iii. Guardrails (including scaffolding) erected over/adjacent working areas must have the guardrails screened (opening < 0.5), to prevent material from falling outside the platform/decking.
- iv. Guardrails must be able to withstand a 200-pound force exerted in any one direction.
- v. Where necessary to prevent danger, guys, stays or supports should be used or other effective precautions should be taken to prevent the collapse of structures or parts of structures that are being erected, maintained, repaired, dismantled or demolished.
- vi. All openings through which workers are liable to fall should be kept effectively covered or fenced and indicated in the most appropriate manner.
- vii. Guardrails and toe-board/barricades and sound platform conforming to IS: 4912-1978 and other Indian laws and regulations as depicted below should be provided.

Guardrail system

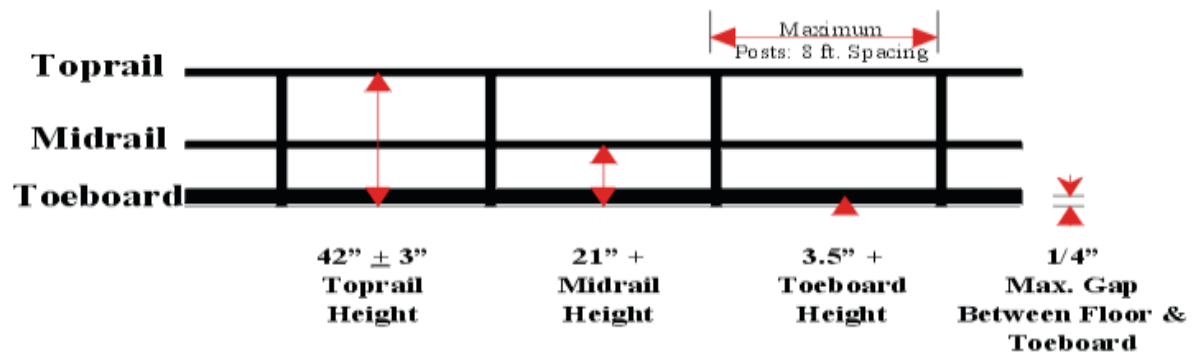



Fig. 13.2.1.2 Guard Rail System

- viii. Guardrails shall be provided to protect workers from falling from elevated work places. The rails are generally made of MS pipes of suitable dia. Rebar shall not be used for any handrails, ladder or cover purpose. Wherever the guard-rails and toe-boards cannot be provided:
 - a. adequate safety nets or safety sheets shall be erected and maintained; or
 - b. adequate safety harnesses shall be provided and used and / or
 - c. adequate fall arrestor shall be provided and used.

As mentioned under PPE clause, all these PPEs shall be defect free and regularly inspected for any defect. The full body safety harness shall have double lanyard only with max 1.8m length.

- ix. The monkey ladders shall have sufficient fall arrestors. Adequate lifelines of 8mm steel wire

 <p>POWER SECTOR</p>	HEALTH, SAFETY AND ENVIRONMENT PLAN FOR SITE OPERATIONS (SECTION-A)	Doc. No.: HSEP:14-ER
		Rev.: 00
		Date:25.04.19
		Page 48 of 162

rope shall be provided across the work area.

- x. The HSE officer shall recommend appropriate PPEs after analyzing hazards and risks involved.

13.2.1.3 Scaffolding

All scaffolds shall be conformant to the relevant standards including IS 3696 and IS 4014 as applicable. A sketch of the scaffolds proposed to be used shall be prepared and approval of the BHEL Engineer obtained prior to construction / use.

General

1. The scaffolding work must be carried out by a competent person, who shall train the scaffold users on safety aspects
2. All scaffolds shall be erected / dismantled by scaffolding crew under direct supervision of competent scaffolding supervisors.
3. All scaffolds shall be capable of supporting 4 times maximum intended load and erected on sound, rigid footing, capable of carrying the maximum intended load without settling or displacement. Bamboo scaffolding is not permitted for use on site.
4. Each employee on the scaffold shall use an approved safety harness attached to an independent lifeline. The lifeline is to be securely attached to substantial members of the structure (not the scaffold itself) or to securely rigged lines, which shall safely suspend a worker in event of a fall.
5. Guard rails and toe boards shall be installed on all open sides and ends of platforms more than (2) meters above ground or floor
6. Scaffold planks must be at least 5 cm x 25 cm (2" x 10") full thickness lumber scaffold grade or better.
7. Scaffold planks shall not span distances greater than 2.5 meters (8 feet).
8. Scaffold planks shall extend over end supports not less than 6 inches nor more than 12 inches and be secured to the scaffold. Scaffolding and accessories with defective parts shall be immediately repaired or replaced.
9. All scaffolding must be a minimum of two planks wide. No one may work from a single plank.
10. Scaffold planks must be inspected before use. Planks that have been damaged must be removed from the site.
11. Access ladders must be provided for each scaffold. Climbing the end frames is prohibited unless the design incorporates an approved ladder.
12. Adequate mudsills or other rigid footing capable of withstanding the maximum intended load must be provided.
13. Scaffolds more the 6 meters (20 feet) in height must be tied to the building or structure at intervals which do not exceed 4 meters (13 feet) vertically and 6 meters (20 feet) horizontally.
14. Do not overload scaffolds. Material should be brought up as needed. Scaffolding must not be loaded in excess of its rated capacity.
15. Barrels, boxes, kegs, blocks or similar unstable object must never be used as work platforms or to support scaffold.
16. Where persons must work under or pass under a scaffold then a 18 gauge wire mesh screen must be installed between the toe board and guard rail.
17. Employees exposed to overhead hazards while working on a scaffold will be protected by 5 cm (2") thick planks.
18. Wooden/bamboo ladders shall not be allowed at any cost. Ladder's rungs shall be fitted /welded properly. Before every use the rungs should be checked for safe use.



POWER
SECTOR

HEALTH, SAFETY AND ENVIRONMENT PLAN FOR SITE OPERATIONS (SECTION-A)

Doc. No.: HSEP:14-
ER
Rev.: 00
Date:25.04.19
Page 49 of 162

19. Wooden scaffolds shall not be used in areas where fire / fire products are expected
20. Ropes made of jute / Plastic and other fire prone material shall not be used to tie up scaffolding components together
21. The platform should have permanent hand rail and mid rail with Toe board without fail.
22. All platforms are to be tightly planked for the full width of the scaffold, except as may be necessary for entrance openings. Platforms shall be secured in place.
23. On suspension scaffolds designed for a working load of 500 pounds, no more than two workers are permitted to work on the scaffold simultaneously. On suspension scaffolds with a working load of 750 pounds, no more than three workers are permitted on the scaffold simultaneously.

24. Requirements for different types of Scaffolds:

A. Suspended Scaffold

- i. Suspended scaffolds are platforms suspended by ropes, or other non-rigid means, from an overhead structure.
- ii. Requirements for use are to be preapproved by HSE Head, under a specific Permit to Work.

B. Rolling Scaffolds

- i. The height of rolling scaffolds shall not exceed three times the minimum base dimension.
- ii. The minimum base dimension of rolling scaffold will be 1.25 meters (4 feet).
- iii. Adequate help must be provided when moving a rolling scaffold.
- iv. Secure or remove all loose materials, equipment and tools before moving a rolling scaffold.
- v. No one is permitted to ride a rolling scaffold when it is being moved. Castor brakes must be locked-on when the scaffold is not being moved.

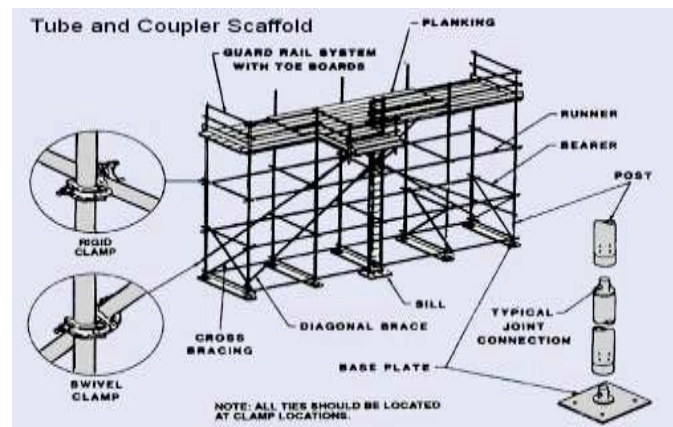
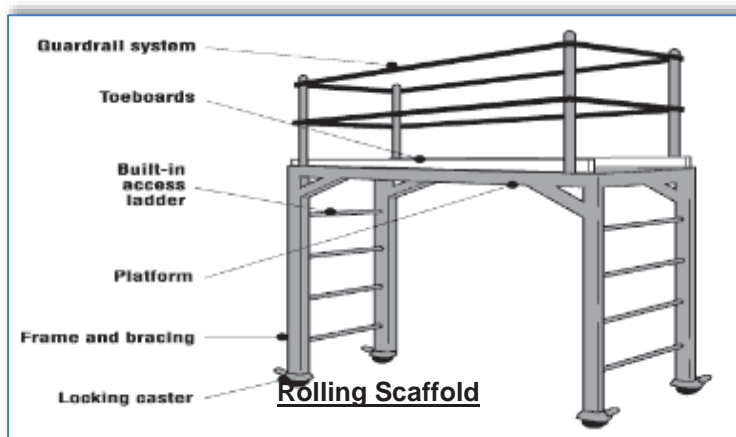



Fig. 13.2.1.3 Types of Scaffolds

25. Scaffold Tagging

Scaffolds being erected, modified or dismantled must be tagged as suitable for use. The scaffolds can only be accessed by those involved with the process.

GREEN scaffold tag- shall be fixed when scaffold is complete and safe for use, signed and dated by

 POWER SECTOR	HEALTH, SAFETY AND ENVIRONMENT PLAN FOR SITE OPERATIONS (SECTION-A)	Doc. No.: HSEP:14-ER
		Rev.: 00
		Date:25.04.19
		Page 50 of 162

the scaffolding competent person daily.

RED scaffold tag – to be fixed if scaffold is in some way defective and cannot be used or is still under erection.

Examples of scaffold tags:



Fig. 13.2.1.4 Scaffold Tagging

13.2.1.4 Ladder Safety

A sketch of the ladders proposed to be used shall be prepared and approval of the BHEL Engineer obtained prior to construction / use

Safe Use of Ladders:

1. Fall protection is required when working on a ladder above 2 meters and when climbing above nearby guardrails.
2. Ladders must be inspected prior to use and by a competent person quarterly, with documentation.
3. Use portable ladders for height up to 4 M only
4. Provide fixed ladders for height above 4 M
5. Place the ladder at an angle of 75 degrees (approx.) from the horizontal (1:4)
6. Extend ladder at least 1 M above the top landing
7. Secure top and bottom of the ladder firmly to prevent displacement- anti skid lining at the bottom
8. Ensure that the width of the ladder is not less than 300 mm and distance between rungs is not more than 300 mm
9. Provide landings of minimum size 600 x 600 mm at intervals not more than 6 M for fixed ladders. Check the ladders daily for any defects
10. Ensure that the areas around base and top of the ladder are clear. Getting on and off the ladder is more hazardous than using it. Use a mudsill if the ladder is to rest on soft, loose or rough soil
11. Do not use ladders of conducting material near power lines, and only use ladders near power line or other energize system with exposed parts if they are confirmed locked-out and de-



**POWER
SECTOR**

**HEALTH, SAFETY AND ENVIRONMENT PLAN
FOR
SITE OPERATIONS
(SECTION-A)**

Doc. No.: HSEP:14-
ER

Rev.: 00

Date:25.04.19

Page 51 of 162

energized.

12. Stand no higher than the fourth rung from the top for carrying out any job standing on a ladder.
13. Never reach out from a ladder to perform work where your belt buckle protrudes past the ladder rung.
14. Always face the ladder while climbing up or down
15. Maintain three-point contact while climbing up or down a ladder i.e. two hands and one foot or two feet and one hand on the ladder at all the times.
16. Avoid climbing up or down a ladder while carrying anything in hands. Lift tools, equipment and materials with a rope.
17. Work from portable and extension ladders near guardrail where fall expose exists over the guardrail regardless of height, and above 2.0 mtr. heights from the working/walking surface will require the use of personal fall arrest equipment

13.2.2 EXCAVATION & CIVIL WORKS

All safety precautions shall be taken for foundation and other excavation marks as per IS-3764.

13.2.2.1 Excavation

The following safety measures are to be ensured before and during excavation:

1. All Excavation activities more than with depth of 1.22 meter or more shall require and Excavation Work Permit
2. Check for underground utilities like electrical / telephone cables, sewage, water lines and proper care has to be exercised to protect and prevent damage to it
3. Proper and adequate slope is maintained while excavating
4. Adequate shoring or sheeting is done wherever require to prevent soil sliding
5. Safe access through ladder or steps for exit & entry to excavation
6. No material /excavated soil is kept within one meter from the edge
7. Safe way is planned and provided for movement of HEM /transport equipment near excavation
8. Safety helmet and shoes/gum boots are provided and worn by the workmen at excavation works
9. Dewatering arrangement is made where water seepage is prevailed.
10. Stop blocks are provided to avoid vehicles reversing into the excavated trenches
11. Danger signs /Caution boards are displayed at work spot
12. Barricading is provided at excavated pits



POWER
SECTOR

HEALTH, SAFETY AND ENVIRONMENT PLAN
FOR
SITE OPERATIONS
(SECTION-A)

Doc. No.: HSEP:14-
ER
Rev.: 00
Date:25.04.19
Page 52 of 162

Soil Type	Height/Depth ratio	Slope Angle
Stable Rock	Vertical	90 deg.
Type A	¾ : 1	53 deg.
Type B	1 : 1	45 deg.
Type C	1½ : 1	34 deg.

Determining Soil Type		
Type	Description	Examples
A	Cohesive soils with an unconfined compressive strength of 1.5 tons per square foot or greater.	Clay, silty clay, sandy clay, clay loam and in some cases: silty clay loam and sandy clay loam.
B	Cohesive soils with unconfined compressive strength greater than 0.5 tsf but less than 1.5 tsf.	Angular gravel (similar to crushed rock), silt, silt loam, sandy loam and, in some cases silty clay loam and sandy clay loam.
C	Cohesive soils with unconfined compressive strength greater than 0.5 tsf or less.	Granular soils such as gravel, sand and loamy sand; submerged soil or soil from which water is freely seeping; submerged rock that is not stable.

Fig. 13.2.2.1 Excavation Reference

13.2.2.2 Piling

Ensure the following precautionary measures before starting piling works:

1. Inspection of piling equipment by responsible person for its condition before initiating piling operation.
2. Checklist and OCP for piling to be prepared using manufacturer's instructions and used
3. Testing and its certification wire ropes, slings, D-shackles, chain pulley blocks using in the process of piling work by competent person
4. Adequate support and secured foundation of the piling equipment to avoid toppling
5. Hoses should be lashed and adequately secured
6. Proper work platform is to be provided on piling frame
7. Safe work procedures and close supervision to prevent unsafe acts of operators/any unsafe conditions that may arise
8. Only experienced and trained operators are engaged for the piling operation
9. Provision of Personal Protective Equipment (PPE) like safety shoes/gumshoes/safety helmet/safety belt etc. and its use by their workmen.
10. Special care and precautions If work is near electrical live cables/ electrical equipment
11. Cordoning of work area to prevent un authorized entry
12. Guarding of revolving parts
13. Specific measures to prevent over turning of pile driver/missing of hammer/ hammer movement out of range

13.2.2.3 Batching

Following Safety considerations for batching plant are to be ensured:

1. Modern type batching plant should be used in which all the moving parts are protected and

 <p>POWER SECTOR</p>	HEALTH, SAFETY AND ENVIRONMENT PLAN FOR SITE OPERATIONS (SECTION-A)	Doc. No.: HSEP:14-ER
		Rev.: 00
		Date:25.04.19
		Page 53 of 162

emergency and safety features are incorporated.

2. Installation of external Electric moto-vibrators in the feeding hopper of all batching plants to reduce human intervention.
3. Installation of safety devices like pull-chord on both the sides of conveyor for stopping the conveyor in emergency
4. Workers carrying cement / sand to be given appropriate PPEs like respiratory masks & gloves.
5. Conveyor belt/rotating parts must be guarded properly.
6. Safety awareness shall be inculcated in workmen about the risk involved in rotating parts.
7. The agency shall ensure to erect the batching plant as per drawing including installation of all safety devices as provided by manufacturer and witnessed by BHEL Engineer in charge before starting of machine in future.
8. Safety audit to also focus on Batching plant.
9. The site shall impose penalty on the agency who has violated the safety norms as per contract.

13.2.2.4 Mobile Plant

Mobile plant includes tractors, trailers, dumpers, excavators, bulldozers, road rollers etc. for earthmoving purpose and concrete mixers, concrete transit mixtures, concrete pumps etc for concreting purpose. Due to the very nature of their function and movement in difficult terrains, congested areas, working in tandem with manual work and other operations the danger is inherent. Reverse horn is compulsory for all earth moving machineries.

Following Safety measures to be ensured for Mobile Plant:

1. Where movement around site is involved, routes should be planned, obstruction free and well maintained
2. Observe specified speed limits
3. Operating personnel should be aware of associated risks and its preventive measures
4. Only experienced, trained and authorized persons with valid license (wherever applicable) should operate the mobile equipment/vehicles
5. Provide and use Warning lights and reverse horn for cautioning the people around
6. Operation should be on level and stable ground with adequate working clearance.
7. Loading of out riggers/stabilizers should be well within safe ground bearing capacity
8. No person should be on equipment or vehicle during loading and unloading of material
9. Operators should be protected by warning barriers or switching off power when working in close proximity of overhead power lines
10. The equipment /vehicles should be well maintained and provided with effective brake system and other safety devices (wherever require)
11. Rotating parts of equipment should be adequately guarded
12. Provide necessary personal protective appliances and ensure its use by the operating personnel
Ensure effective measures at source to control harmful emissions, dust, fumes contaminating atmosphere and cause health hazards to the operators and people in the vicinity.
13. No overloading/over stressing of vehicles/plant is allowed
14. Hoses, pipes, receivers, gauges and valves involved in carrying out hydraulic fluid/ compressed air should be checked for leaks and tested prior to operation.
15. Adequate safe clearance for swing and movement is to be judged during operation of Concrete mixer



POWER
SECTOR

HEALTH, SAFETY AND ENVIRONMENT PLAN
FOR
SITE OPERATIONS
(SECTION-A)

Doc. No.: HSEP:14-
ER

Rev.: 00

Date:25.04.19

Page 54 of 162

16. Setting of machine on firm and level ground with wheel locked to prevent movement of machine
17. Proper instructions and Special precautions are to be ensured to prevent entry in to the danger zone of projectile of bucket while dropping bucket
18. Operator leaving work spot should ensure that the equipment/vehicle is kept in neutral position and place on firm and level ground.
19. The hand brake should be kept in position and block road wheels as additional safety measure
20. Blades/buckets should be kept low while moving
21. The dozer blades should not be used as brakes except in emergency
22. The ground should be examined for its bearing capacity and general safety especially when operating road roller at the edges of slopes, embankments.
23. The roller should not be moved downhill with the engine out of gear
24. If operating near excavations the following precautionary measures are to be ensured
25. Barricading, edge protection to prevent fall of persons/vehicles over running while reversing etc.
26. Suitable support system and adequate allowance to avoid the danger of side collapsing
27. Experienced signaller /attendant should be always accompanied with operator/driver for proper direction /signal and also to caution others in the working Zone during operation of mobile plant

13.2.2.5 Concrete Vibrators

1. Revolving parts/belt drives should be adequately guarded and Vibrating unit shall be completely enclosed and have suitable overload relays and effectively earthed
2. Ensure sufficient length of cable to the Vibrator.
3. Ensure electric starters and other accessories are firmly fixed adequately supported
4. Ensure locking of needle load while inserting needle in to the vibrator,
5. Ensure periodical lubrication and maintenance

13.2.2.6 Concrete Mixers

1. Setting of machine on firm and level ground with wheel locked to prevent movement of machine
2. Proper instructions and Special precautions are to be ensured to prevent entry in to the danger zone of projectile of bucket while dropping bucket

13.2.3 WELDING & GAS CUTTING SAFETY (HOT WORK)

1. All Hot Work shall require a Hot Work Permit
2. There shall be flash-back arrestors conforming to IS-11006 at both cylinder and burner ends. Damaged tube and regulators must be immediately replaced.
3. All safety precautions shall be taken for welding and cutting operations as per IS-818.
4. When possible, items to be welded, cut, heated, etc. shall be moved to a safe location free of combustible or flammable material. If this is not possible, then all combustibles/ flammables that can be removed from the area shall be removed within a 35-foot circumference and a positive means of confining arcs and sparks generated by the process shall be ensured and additional person(s) shall be stationed as fire-watch for the area(s) still exposed, along with obtaining the Hot Work Permit as applicable.
5. Appropriate fire-fighting equipment is to be available in close proximity of any welding and gas cutting operations at all times suitable for the type of Fire.
6. Drums, tanks, and similar containers that have contained flammable or toxic material shall not be welded, cut, or heated until they have been made safe by water filling, thorough cleansing or similar accepted practices. The container shall also be ventilated during the welding, cutting, or heating process.



POWER
SECTOR

HEALTH, SAFETY AND ENVIRONMENT PLAN FOR SITE OPERATIONS (SECTION-A)

Doc. No.: HSEP:14-
ER

Rev.: 00

Date:25.04.19

Page 55 of 162

7. Proper ventilation is required for any welding or torch operations performed in a confined space.
8. Any welding or gas cutting operations performed on metals of toxic compounds or coating such as zinc, stainless steel, lead, cadmium, chromium, and beryllium shall be properly ventilated and/or proper respiratory protection shall be worn by any person that could be exposed to fumes, vapors, and gasses created by the welding and gas cutting processes.
9. Wherever it is practical, all arc welding operations shall be shielded to prevent direct light rays or sparks from contacting persons in the vicinity or from reaching areas normally used to travel through or into the vicinity. Where this is not practical, persons who shall be in the area are to use proper eye and skin protection. Other persons who are not participating in the welding or gas cutting operations are not to be allowed into the hazard zone.
10. Welders and other employees who are exposed to arc welding radiation shall wear suitable clothing and protective apparel to prevent burns and other types of ultraviolet radiation damage to the skin.
11. Arc welding machines shall be shut down when being moved or when they are not in continuous use. Electrode holders left unattended shall have electrodes removed and shall not be left where they might contact employees or conducting objects.
12. Arc welding power supply cable shall be of proper rating and material, e.g. copper.
13. Welders shall guard against allowing materials adjacent to or behind them to reflect radiation back toward them or towards others in the area. Reflected radiation can cause skin burns and eye flash burns.
14. Valve caps shall be in place when cylinders are not in use. Valve caps shall never be used for lifting the cylinder vertically.
15. Torches shall only be lit by approved strikers; never with matches, cigarette lighters, or hot-work.
16. **Splatter / Slag Collector**

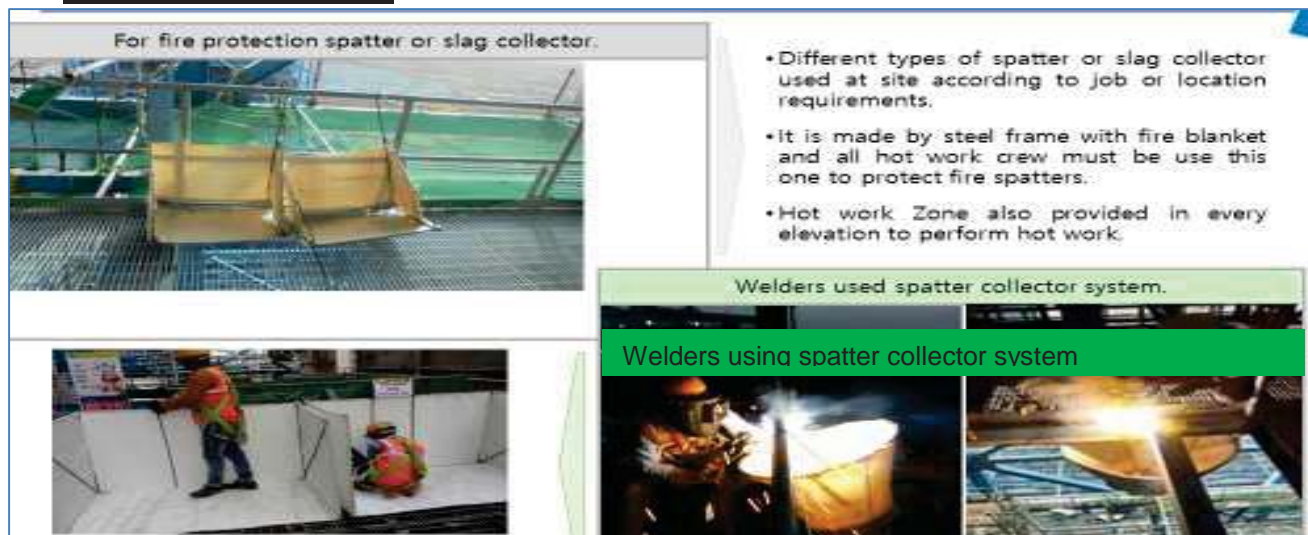

Fig. 13.2.3.1 Splatter / Slag Collector

While carrying out job at height, the sparks or molten slag shall be prevented from falling down by putting a fire-resistant (non-asbestos) sheet or pater/ slag collector or even MS Sheet. The passage of falling sparks or molten slag shall be barricaded till ground floor and any cable/ tubes/ any other objects interfering in the passages hall either be removed or covered with Fire-resistant sheet or MS Sheet.



POWER
SECTOR

HEALTH, SAFETY AND ENVIRONMENT PLAN
FOR
SITE OPERATIONS
(SECTION-A)

Doc. No.: HSEP:14-
ER

Rev.: 00

Date:25.04.19

Page 56 of 162

13.2.3.1 COMPRESSED GAS

1. All cylinder valves shall be closed when any work is finished and when any Cylinders are empty or being moved. Valve protection caps shall be placed and secured properly before gas cylinders are transported, moved or stored.
1. Compressed gas cylinders shall be secured in an upright position with chain or appropriate means during storage & use. However, a trolley shall be used for transportation.
2. Compressed gas cylinders shall always be secured from tipping or falling, whether in use, in storage or in transit. The cylinders shall always be secured upright, except during times when actually being hoisted or carried.
3. When cylinders are transported by powered vehicle they shall be secured in a vertical position.
4. Regulators shall be removed when cylinders are not in use or are in transit, unless the cylinder is firmly secured on a special carrier designed for this purpose.
5. Gas cylinders are not allowed to be used in man-basket when occupied.
6. Cylinders containing oxygen or fuel gasses shall not be taken into confined spaces.
7. Oxygen cylinders shall be stored a minimum of 6 meters from fuel gas cylinders or shall have an approved firewall between them.
2. All cylinders shall be kept at a safe distance from welding or cutting operations or shielded from arc/ sparks / slag.
3. All cylinders shall be placed where they cannot become part of the electrical circuit.
4. Oxygen and acetylene shall not be stored together. Oxygen must be separated from acetylene (or ANY fuel gas) or combustible material by at least 20ft or a barrier with a 30 minute fire resistance rating.
5. All Cylinders should be stored upright in a designated area with labels for the type of gas. All applicable precautions to be ensured during storage
6. Oxygen and fuel gas regulators, hoses and associated equipment shall not be altered and shall be in proper working order while in use.
7. Compressed air can be extremely dangerous if allowed to penetrate the skin. As such, the use of compressed air to clean off yourself or other workers shall be strictly prohibited.
8. All gas cylinders shall be stored in upright position. Suitable trolley shall be used for cylinder movement, the design of which shall be submitted to BHEL Engineer for approval.
9. No of cylinders shall not exceed the specified quantity as per OCP
10. Cylinders shall be moved by tilting and rolling them on their bottom edges. They shall not be intentionally dragged, struck or permitted to strike each other violently.
11. All cylinder should be kept only in cylinder trolley.
12. Cylinder shall be transported in upright vertical position by suitable mean.

13.2.4 LIFTING & RIGGING SAFETY

1. All Heavy / Complex Lifting operations as defined in Clause 6.12 shall require a Lifting Work Permit.
2. All the cranes and lifting tools & tackles shall be inspected on daily / weekly basis as well as



POWER
SECTOR

HEALTH, SAFETY AND ENVIRONMENT PLAN
FOR
SITE OPERATIONS
(SECTION-A)

Doc. No.: HSEP:14-
ER

Rev.: 00

Date:25.04.19

Page 57 of 162

monthly by expert as per applicable formats.

3. In addition, inspection / certification as mandated by law shall be carried out wherein these shall be tested and certificates of fitness shall be obtained from 3rd party State Govt. approved competent agency before deploying at site and later periodically. BHEL shall be given advance intimation of any such inspections
4. The last date of Third Party Inspection and the next Due date shall be conspicuously displayed on all cranes. A copy of certificate shall be pasted on operator's cabin of all the lifting equipment.
5. Following requirements shall be mandatorily followed, wherever applicable:
 - a. The manufacturer's instruction for maintenance shall also be followed. All safety measures shall be followed.
 - b. All tools tackles, lifting appliances; material-handling equipment etc. used by the subcontractor shall be of safe design and construction.
 - c. The operators, slingers and signalers shall be qualified as per IS 13367 (part-1):2003 "Safe use of cranes- code of practices".
 - d. There shall be a person responsible for co-ordination among cranes where multiple cranes are used, and lifting over 75% of the crane capacity to be avoided.
 - e. Mobile phone should be banned for crane operator and lifting operation. Only walki talki shall be allowed in rigging/Lifting purpose.

13.2.4.1 Personnel Lifts (Man-Basket / Jhoola):

The design of personnel man basket shall be submitted to BHEL Engineer for approval before use. Relevant permit (Height work & others as applicable) shall be completed prior to lifting any people, along with a rigging plan.

- a. A separate Lifeline / Fall arrestor anchored to a fixed structure outside of Jhoola shall be provided for the workers inside the basket. All occupants of the basket shall have Safety Harnesses equipped with rope grabs, which are to be hooked to the vertical lifeline.
- b. Man-basket shall be used where access through ladders or scaffolding is not feasible.
- c. Man-baskets shall be designed and engineered by a manufacturer (job made man-baskets are not allowed, unless designed and tested by a certified engineer), and built robust with MS Angles and flats or plates or channels only.
- d. Guard rails top and mid, must be in place and screened-in to avoid material from falling out of basket. The factor of safety shall be 200%.
 - e. It shall have a door with double latches and shall open inside. Anchor points shall be identified within the man-basket.
- f. The man-basket shall be thoroughly inspected and load tested and a trial run performed without personnel before being put to job.
- g. It shall be treated as a lifting tool (T&P Item) and shall undergo same certification cycle and inspection as other lifting equipment.
- h. An additional sling of required lifting capacity shall be fixed the man-basket main lifting point and attached to the crane above the ball or block.



POWER
SECTOR

HEALTH, SAFETY AND ENVIRONMENT PLAN
FOR
SITE OPERATIONS
(SECTION-A)

Doc. No.: HSEP:14-
ER
Rev.: 00
Date:25.04.19
Page 58 of 162

- i. While lifting man-basket, the crane shall maintain a uniform speed of lift without any swing.
- j. Once man-basket reaches the destination, the lift brakes shall be locked as long as the basket remains at that point. The same care shall be taken in its descent.
- k. As for hanging man-basket, the same shall be hung off a rigid structure with help U-shaped handle welded to man-basket. This shall be tested once in a year by a competent person.
- l. Use of Rebar steel for making and monkey-ladder must be avoided.

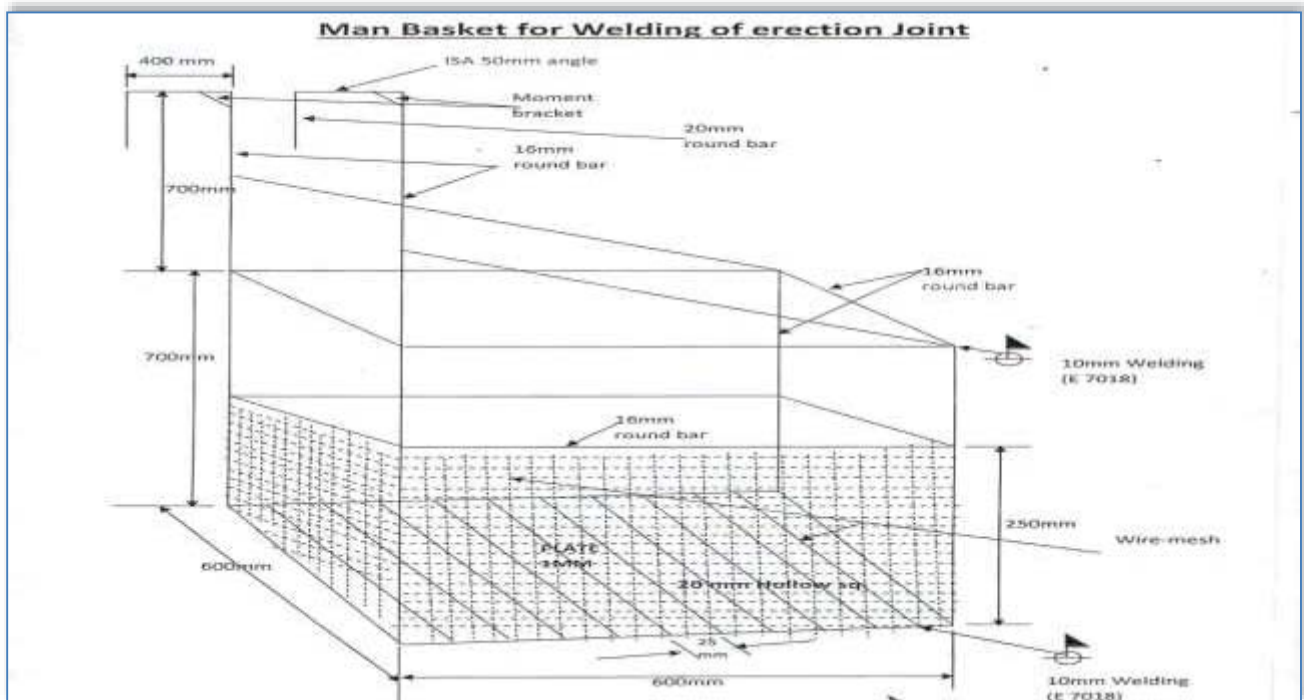

Fig. 13.2.4.1 Man Basket for Welding Erection Joint

13.2.4.2 Cranes & Hoisting Equipment:

This section provides the guidelines to ensure proper rigging and lifting activities are accomplished safely and in accordance with applicable specifications, codes, and regulations.



POWER
SECTOR

HEALTH, SAFETY AND ENVIRONMENT PLAN
FOR
SITE OPERATIONS
(SECTION-A)

Doc. No.: HSEP:14-
ER
Rev.: 00
Date:25.04.19
Page 59 of 162

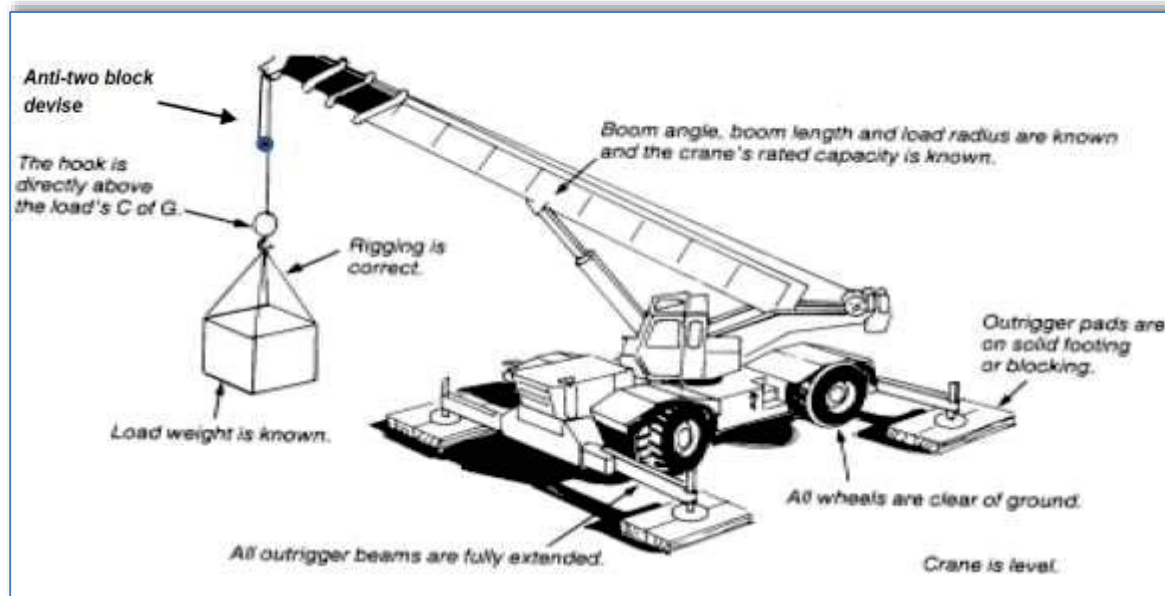

Fig. 13.2.4.2 Proper Crane Setup

- On every crane or piece of hoisting equipment notices of all rated load capacities, recommended operating speeds, and any hazard warnings or special instructions shall be conspicuously posted. All instructions and warning shall be visible from the equipment operator 's station.
- Cranes shall have an Anti-Two-block safety device installed
- All mobile cranes shall have overload and backup alarms, load angle indicators and limit switches
- All areas within swing radius of cranes that are potentially accessible by pedestrian, vehicular, or equipment movement shall be barricaded to prevent anyone or any vehicle or equipment from being struck by the crane or hoisting equipment, or its load(s).
- No part of the lifting equipment or its load shall be within the distance as specified in the Indian Electricity Act from an energized power line
- Cranes shall have annual certified third party inspection and be inspected before use by the operator. Any defects shall be corrected before use. Logs of crane inspection shall be kept with the crane.
- Make certain that the rigging personnel, material, and equipment have the necessary capabilities for the job and are in safe condition.
- Communicate with person(s) directly responsible for accomplishing the work and / or work area to establish requirements/responsibilities and make certain that all preparatory work is complete.
- Mats/Pads must be used on all lifting equipment, equipped with out riggers.
- Pick and carry must have the load secured to the rig in front.
- Only BHEL Approved Plate Lifting Spreader Beam configuration shall be used (Sample in Fig. 13.2.4.2)



POWER
SECTOR

HEALTH, SAFETY AND ENVIRONMENT PLAN
FOR
SITE OPERATIONS
(SECTION-A)

Doc. No.: HSEP:14-
ER
Rev.: 00
Date:25.04.19
Page 60 of 162

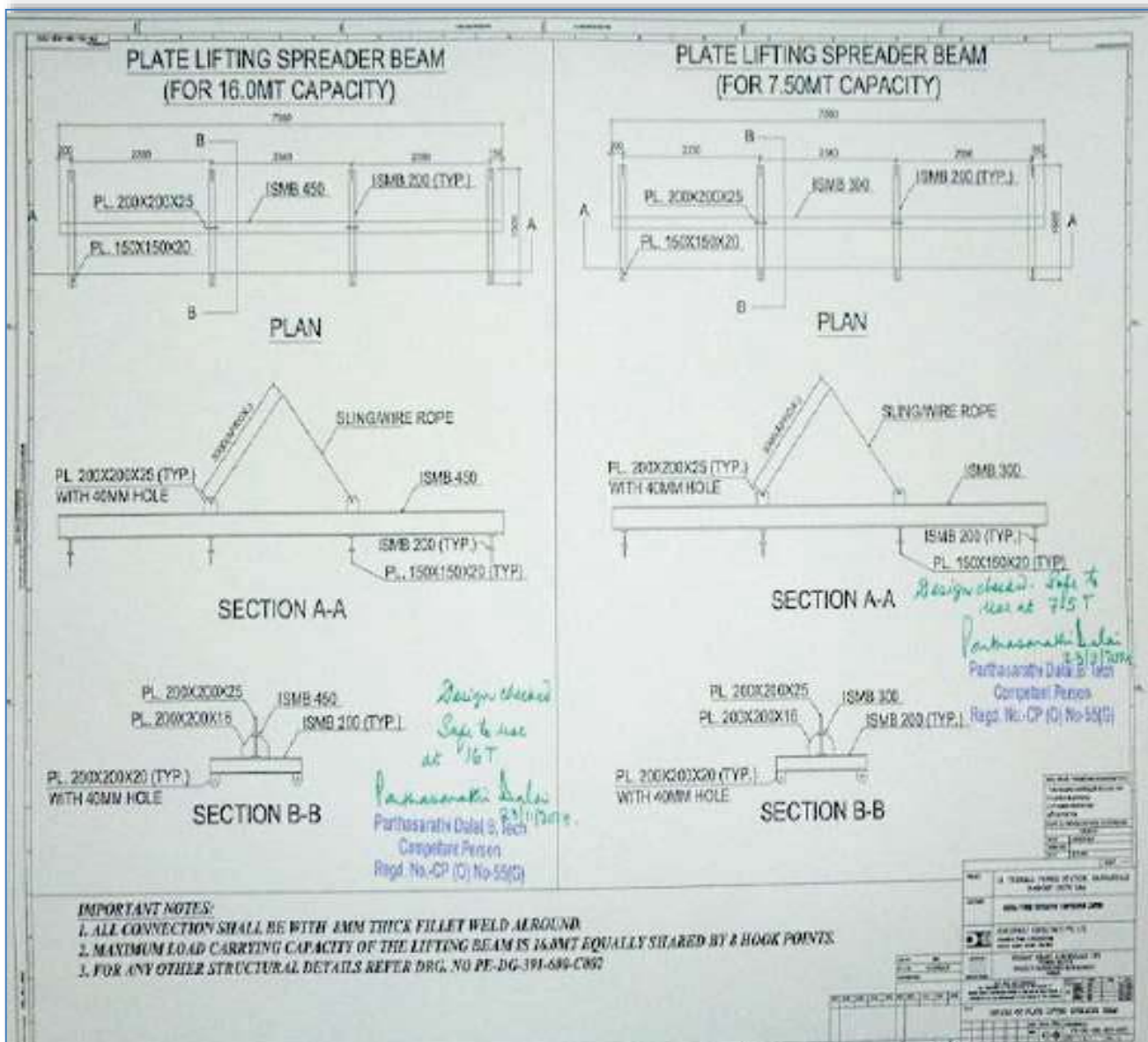

Fig. 13.2.4.3 Typical Plate Lifting Spreader Beam Configuration for 7.5 MT and 15 MT Loads

I. Crane operators must follow the following:

1. Pass an annual Operator's Physical examination
2. Carry a valid training certification card at all time while operating issued by the Govt. or other recognized institute.



POWER
SECTOR

HEALTH, SAFETY AND ENVIRONMENT PLAN
FOR
SITE OPERATIONS
(SECTION-A)

Doc. No.: HSEP:14-
ER

Rev.: 00

Date:25.04.19

Page 61 of 162

13.2.4.3 SAFE RIGGING PRACTICES

13.2.4.4

- a. Review the planned operation and requirements with the operator and rigging crew.
- b. Ensure a pre-lift meeting is conducted with crane operator, tagline operator, signal personnel, and Safety Manager.
- c. Designate a qualified person from the rigging crew to observe clearance of the equipment and give timely warning for all operations where it is difficult for the operator to maintain the desired clearance by visual means.
- d. Clear the lift area of all unnecessary personnel.
- e. Hydras shall only be allowed for loading & unloading works & shall not be allowed to move with load

13.2.4.4.1 RULES FOR SAFE RIGGING

1. Use loops, thimbles and corner pads to prevent damage to slings when used around corners or on cutting edges.
2. Never allow wire rope to lie on the ground for any length of time or on rusty steel or near solvents, chemicals or corrosive substances.
3. Slings must not be pulled from between or under loads with load resting on the sling.
4. Keep all rope away from flame cutting or welding operations.
5. Never use rope as sling material.
6. Never wrap a wire rope completely around a hook.
7. Do not bend wire rope near any attached fitting.
8. The sling must be selected to suit the most heavily loaded leg rather than the total weight when using multi-legged sling to lift loads in which one end is heavier than the other.
9. When using 3 and 4 legged sling configurations, any two legs must be capable of supporting the entire load.
10. Where possible, wire rope choker hitches must include a shackle with the eye around the shackle pin to prevent breaking wires of the choke. The choker hitch must be "snugged down" prior to lifting, not after tension is applied.
11. Unless authorized by the hook manufacturer when more than two rope eyes are placed over a hook, install a shackle, pin resting in the hook, and place the rope eyes in the bowl of the shackle.
12. Properly rig all loads to prevent dislodgment of any part.
13. Use guide ropes or tag lines to prevent the rotation or uncontrolled motion of the load when necessary.
14. Loads must be safely landed and properly blocked before being unhooked and unslung. Tag lines must not be used in situations that jeopardize the safety of the lift.
15. Lifting beams must be plainly marked with their weight and designed working load and must only be used in the manner for which they were designed.



POWER
SECTOR

HEALTH, SAFETY AND ENVIRONMENT PLAN
FOR
SITE OPERATIONS
(SECTION-A)

Doc. No.: HSEP:14-
ER
Rev.: 00
Date:25.04.19
Page 62 of 162

16. The hoist rope or chain must never be wrapped around the load. The load must be attached to the hook by slings or other rigging devices that are adequate for the load being lifted.
17. Multiple part lines must not be twisted around each other.
18. The hook must be brought over the center of gravity of load before the lift is started.
19. If there has been a slack rope condition, determine that the rope is properly seated on the drum and in the sheaves prior to lifting.
20. Keep hands away from pinch points as the slack is being taken up.
21. Leather gloves are recommended when handling wire rope.
22. Avoid impact loading caused by sudden jerking when lifting or lowering. Lift the load gradually until the slack is eliminated.
23. Never ride on a load that is suspended.
24. Avoid allowing the load to be carried over the heads of any personnel.
25. Never work under a suspended load until the load has been adequately supported from the floor and all conditions have been approved by the supervisor in charge of the operation.
26. Never leave a load suspended unless emergency evacuation is required.
27. Never make temporary repairs to sling.
28. The capacity of a sling is determined by its angle, construction, type of hitch and size.
29. Never lift loads with one leg of a multi-leg sling until the unused legs are made secure.
30. Never point load a hook unless it is especially designed and rated for such use.
31. Make certain that the load is broken free before lifting and that all legs are taking the load.
32. When using two or more slings on a load make certain all slings are made from the same materials.
33. Lower the loads on to adequate blocking to prevent damage to the slings.
34. Materials and equipment being hoisted must be loaded and secured to prevent any movement which could create a hazard in transit.
35. The weight of the hook, load block and any material handling devices must be included when determining crane capacity.
36. Calculated weights cannot exceed 75% of the chart without written approval.
37. Personnel must be completely clear of loads being picked up or set down by crane. Tag lines will be used to control the loads. Loads must not be touched by hand while placing/ moving.

13.2.4.4.2 SLINGS

a. Synthetic Slings

The following are rules for safe use of synthetic slings:

- i. Synthetic slings must be marked to show the rated capacity for each type of hitch and type of web material.
- ii. Nylon web slings must not be used where fumes, vapors, sprays or mists or liquids of acids or phenolic are present. Web slings with aluminum fittings must apply in this category.
- iii. **Synthetic web slings must be removed from service and destroyed if any of the following conditions are present:**



POWER
SECTOR

HEALTH, SAFETY AND ENVIRONMENT PLAN
FOR
SITE OPERATIONS
(SECTION-A)

Doc. No.: HSEP:14-
ER

Rev.: 00

Date:25.04.19

Page 63 of 162

- a. Acid or caustic burns
- b. Melting or charring of any part of the sling surface
- c. Snags, punctures, tears or cuts
- d. Broken stitches
- e. Distortion of fittings
- f. Synthetic web slings of polyester or nylon must not be used at or come in contact with temperatures in excess of 82°C
- g. Polypropylene web slings must not be used at or come in contact with temperatures in excess of 93°C
- h. Insulated hooks must be tested yearly to insure insulation integrity to at least manufacturer's specifications.

iv. Wire Rope Slings must be removed from service and destroyed if any of the following conditions are present:

- a. In (10) randomly distributed wires broken in one (1) rope lay, or five (5) broken wires in one (1) strand in one (1) rope lay.
- b. Wear or scraping of one-third the original diameter of outside wires.
- c. Kinking, crushing, bird caging or any other damage resulting in distortion of the wire rope structure such as:
- d. Evidence of heat damage.
- e. End attachments that are cracked, deformed worn.
- f. Corrosion of the rope or end attachments.

v. Metal mesh slings must be immediately removed from service if any of the following conditions are present:

- a. A broken weld or broken brazed joint along the sling edge.
- b. Reduction in wire diameter of 25 percent due to abrasion or 15 percent due to corrosion.
- c. Lack of flexibility due to distortion or corrosion.

vi. Synthetic web slings must be removed from service and destroyed if any of the following conditions are present:

- a. Acid or caustic burns
- b. Melting or charring of any part of the sling service
- c. Snags, punctures, tears or cuts
- d. Broken stitches
- e. Distortion of fittings

vii. Requirements of Plate Clamps:

1. The rated load of the plate clamp must be marked on the main structure.
2. Care must be taken to make certain the load is correctly distributed for the plate clamp being used.
3. Do not allow load or plate clamp to come into contact with any obstruction.
4. The plate clamp must not be used for side pulls or sliding the load.
5. When lifting stainless steel or special alloys, ensure plate clamp is designed for use on



POWER
SECTOR

HEALTH, SAFETY AND ENVIRONMENT PLAN FOR SITE OPERATIONS (SECTION-A)

Doc. No.: HSEP:14-
ER
Rev.: 00
Date:25.04.19
Page 64 of 162

the specific metal.

13.2.4.4.3 SIGNALING PRACTICES:

- The "slinger" is responsible for attaching and detaching the load to and from the crane. He shall:
 - have received appropriate training on general safe lifting operations;
 - be capable of selecting lifting gears suitable for the loads;
 - liaise with the operator and direct the movement of the crane safely.
- The "signaller" is responsible for relaying the signal from the slinger to the crane operator. He shall:
 - have received appropriate training on general safe lifting operations;
 - be able to direct the movement of the crane and loads.

Suggested hand signals



Note: During the lifting operation, either the slinger or signaller shall communicate with the operator. Other communication methods (e.g., wireless walkie-talkies, telephones, etc.) may also be used.

Fig. 13.2.4.4 Recommended Signalling Practices



**POWER
SECTOR**

**HEALTH, SAFETY AND ENVIRONMENT PLAN
FOR
SITE OPERATIONS
(SECTION-A)**

Doc. No.: HSEP:14-
ER

Rev.: 00

Date:25.04.19

Page 65 of 162

13.2.5 DEMOLITION WORK

Before any demolition work is commenced and also during the process of the work the following shall be ensured, besides using the Work Permit:

1. All roads and open areas adjacent to the work site shall either be closed, suitably protected or restricted for movement
2. No electric cable or apparatus which is liable to be a source of danger nor a cable or an apparatus used by the operator shall remain electrically charged.
3. All practical steps shall be taken to prevent danger to persons employed from the risks of fire or explosion or flooding. No floor, roof or other part of the building shall be so overloaded with debris or materials as to render them unsafe.

13.2.6 T&Ps General

1. All T&Ps/ MMEs should be of reputed brand/appropriate quality & must have valid test /calibration certificates bearing endorsement from competent authority of BHEL.
2. Subcontractor to also submit monthly reports of T&Ps deployed and validity test certificates to BHEL safety Officer as per the format/procedure of BHEL.
3. Tagging and punching in all lifting tool is compulsory with SWL, sr. no. and due date.
4. All T&Ps shall be inspected by authorized Third Party agency as per applicable frequency. BHEL shall be kept informed of any such scheduled inspection
5. All T&Ps shall be internally inspected in each quarter and colour coded as below.

13.2.6.1 T&P Color Coding Procedure:

Inspections and tests shall be documented by means of color coding which shall verify that inspections or testing are current and that all receptacles, portable Power tools, Lifting Tools & Tackles have been inspected and tested as required. The color codes used on the project shall be:

GREEN	BLUE	YELLOW	RED
January February March	April May June	July August September	October November December

Table. 13.2.6.1 T&P Color Coding Procedure

- i. The cycle of colors shall be Quarterly as a minimum or as decided by BHEL. The color code tape / Sticker shall be clearly visible to designate the period for which the inspections and tests were conducted.



POWER
SECTOR

HEALTH, SAFETY AND ENVIRONMENT PLAN
FOR
SITE OPERATIONS
(SECTION-A)

Doc. No.: HSEP:14-
ER

Rev.: 00

Date:25.04.19

Page 66 of 162

- ii. Following the initial inspection, the equipment must be color-coded quarterly as per color-coding instructions that will be issued by the subcontractor.
- iii. Fire extinguisher with the current month color-coding inspection sticker must be provided and secured in the platform.
- iv. All slings shall be regularly inspected in accordance with the requirement of the project for frequent and periodic inspections and discard immediately if they fail to meet the minimum requirements of the project.
- v. The Subcontractor's Safety Officer shall ensure that all PPE is inspected prior to its issue. He is to ensure all subcontractor personnel are using safe and proper PPE equipment. Regular inspections on the PPE shall be carried out and personnel not adhering to those inspections shall be removed immediately from the site.
- vi. A five (10) day interval period shall be given into each monthly color code change. During this five (10) day period either color shall be acceptable.

13.2.7 CHEMICAL HANDLING

1. Displaying safe handling procedures & MSDS for all chemicals such as lube oil, acid, alkali, sealing compounds etc, at work place.
2. Where it is necessary to provide and/or store petroleum products or petroleum mixture & explosives, the subcontractor shall be responsible for carrying out such provision / storage in accordance with the rules & regulations laid down in the relevant petroleum act, explosive act and petroleum and carbide of calcium manual, published by the chief inspector of explosives of India. All such storage shall have prior approval if necessary from the chief inspector of explosives or any other statutory authority. The subcontractor shall be responsible for obtaining the same.
3. The used containers of chemicals shall be segregated and disposed off suitably
4. In case the used containers need to be re-used, all traces of the chemical to be removed by thorough cleaning with detergents etc. under trained supervision

13.2.8 ELECTRICAL SAFETY

1. Only electricians licensed by appropriate statutory authority shall be employed by the subcontractor to carry out all types of electrical works. The subcontractor shall maintain adequate number of qualified electricians to maintain his temporary electrical installations.
2. Power supply to all equipment at site to be routed through MCBs of appropriate rating. A 'Power Supply Distribution Plan' shall be prepared and submitted to BHEL Engineer for approval



POWER
SECTOR

HEALTH, SAFETY AND ENVIRONMENT PLAN
FOR
SITE OPERATIONS
(SECTION-A)

Doc. No.: HSEP:14-
ER
Rev.: 00
Date:25.04.19
Page 67 of 162

3. All power supplies through cables shall be underground or overhead with height > 3mtrs.
4. All distribution boxes shall be locked and the key controlled by site management of concerned subcontractor.
5. All individual equipment & tools at site shall be powered through Earth Leakage Circuit Breakers of 30 mA sensitivity.
6. These MCBs and ELCBs shall be regularly tested as per Clause 14
7. All fuses and fuse wires shall be of standard size and rating.
8. All electrical appliances used in the work shall be in good working condition and shall be properly double earthed other than armour earthing.
9. All extension boards shall have separate switches for all sockets / connections
10. All portable electric tools used by the subcontractor shall have safe plugging system to source of power and be appropriately earthed.
11. Providing adequate no. of 24 V sources and ensure that no hand lamps are operating at voltage level above 24 Volts especially in confined spaces like inside water boxes, turbine casings, condensers etc.
12. Electrical appliance shall have proper earthing and for appliances equal to & more than 415V shall have two separate earthing (as per IS-3043-1987)
13. Details of earth resource and their test date to be given to BHEL safety officer as per the prescribed formats of BHEL
14. The subcontractor shall use only properly insulated and armoured cables and conform to the requirement of Indian Electricity Act and Rules for all wiring, electrical applications at site.
15. BHEL reserves the right to replace any unsafe electrical installations, wiring, cabling etc. at the risk & cost of the subcontractor.
16. No maintenance work shall be carried out on live equipment
17. Adequate precautions shall be taken to prevent danger for electrical equipment. No materials on any of the sites of work shall be so stacked or placed as to cause danger or inconvenience to any person or the public
18. The subcontractor shall carefully follow the safety requirement of BHEL/ the purchaser with the regard to voltages used in critical areas.
19. Wiring and Branch Circuits Must be protected by a proper amperage over-current device such as a HRC fuse or circuit breaker. Such installations must be located so as to prevent physical damage to the wire conductors & panels.

20. Portable Electric Lights

- a. Portable electric lights used in wet or potentially wet locations must be either low voltage type (24 volts or less) or protected by a GFI (ground fault interrupter).
- b. They must be visually checked before each use and periodically while in use to assure their original integrity is maintained.
- c. Cords with cuts, breaks, deep abrasions, etc. shall be taken out of service immediately.
- d. Repairs to extension cords shall only be performed by qualified/ licensed electricians.
- e. Must not be allowed to lie in wet or potentially wet areas.



POWER
SECTOR

HEALTH, SAFETY AND ENVIRONMENT PLAN
FOR
SITE OPERATIONS
(SECTION-A)

Doc. No.: HSEP:14-
ER

Rev.: 00

Date:25.04.19

Page 68 of 162

21. Underground Cables:

- a. Every electric line or cable of unknown origin that is discovered or exposed during a digging, drilling, probing, or similar operation is to be considered as energized and life threatening.
 - b. The senior company employee on the site will ensure that all necessary safety precautions are taken in order to isolate the line from all workers and the public.
 - c. Such precautions may include halting the operation if appropriate.
 - d. The senior company employee on the site is to then contact the proper authorities to have the line identified and either confirmed to be abandoned and/or made safe for continuing the work.
 - e. Any and all underground lines that are discovered or become severed must be considered energized on both sides, and be treated accordingly.
22. In general, equipment or machinery being moved or transported must maintain minimum clearances of 25 ft. to all power lines.
 23. TAG IN/ TAG OUT must be in force in Switch Room and all Distribution Boxes for live power line. The authorized person's name and contact no shall be displayed
 24. Ensure "double insulated" three - core cables and three pin connectors are used and are properly ground "all insulated" types, all electrical tools and appliances must be manufactured for industrial use.
 25. All connections shall be electrically and mechanically sound and properly insulated. Taped joints are not permitted. Connections to socket outlets must be made with proper plugs.
 26. Splices in electrical cords are not permitted. Repairs must be made at the socket connection and retain the same mechanical and dielectric condition of the original connection.
 27. Damaged or defective electric tools, equipment and extension cords, etc. must not be used and shall be tagged out of service, removed from the work area and taken back to stores.
 28. Only licensed electricians are authorized to repair and work on electrical equipment. Tampering with electric tools or equipment by others could result in termination.
 29. Temporary electric cabling should be elevated 2.2 meters above the floor/ground or covered for protection. It must be kept clear of walkways and other locations where it may be exposed to damage or create a tripping hazard.
 30. Energized wiring in junction boxes, circuit breaker panels and similar places must be covered and locked at all times.
 31. Areas with live high voltage wires or terminals must be barricaded against entry and warning signs posted Danger – High Voltage and Authorized Personnel Only.
 32. Personnel should never work on energized equipment, de-energizing (lockout/tag out) the equipment is always the first requirement.
 33. The lockout and tag out procedure will be used when testing or working on, or around, energized installation.
 34. Working around energized equipment should never be done alone. A second electrician must always be available for assistance.



POWER
SECTOR

HEALTH, SAFETY AND ENVIRONMENT PLAN
FOR
SITE OPERATIONS
(SECTION-A)

Doc. No.: HSEP:14-
ER

Rev.: 00

Date:25.04.19

Page 69 of 162

35. If lockout/tag out of the work is infeasible (must be demonstrated), work on energized electrical circuits must be approved by the Site In-charge. All safety precautions necessary must be taken, PPE use must be evaluated per the exposure and used, i.e high/low voltage gloves, insulated shoes, overcoats/aprons, face shields, and other protective equipment like insulated tools, blankets, mats, etc. must be used.
36. The welding machines earth leads shall be properly fixed without loose contacts. The earth cable only has to be used. No steel members shall be used as earth leads.
37. Electrical crews must be qualified for the equipment and tools they work on, including being trained in Cardio-Pulmonary Resuscitation (CPR) methods and First Aid for rendering help in the event of electric shock.

38. Qualified Persons for Electrical Works

One who is trained and wiremen licensed to Govt of State and familiar with the construction, operation and safety hazards of the equipment upon which they are permitted to work.

- i. Qualified persons are intended to be only those who are well acquainted/experienced with and thoroughly conversant in the electric equipment and electrical hazards involved with work being performed.
- ii. Only qualified persons may be permitted to work on or near exposed energized parts. Such persons are required to have been trained in three specific areas:
- iii. Qualified persons must be capable of working safely on energized circuits;
- iv. Must be familiar with the proper use of special precautionary techniques and procedures based on equipment and exposure; and
- v. Must be familiar with required personal protective equipment, insulating and shielding materials, and insulated tools.
- vi. Qualified persons are expected to be able to evaluate unknown situations and adjust their activities in such a way that only safe work practices are used. Such behavior is the responsibility of the qualified person.
- vii. It is possible and likely for an individual to be 'qualified' with regard to certain equipment in the work place, and unqualified on other equipment they must know their limitation and stop work if not qualified on what equipment they were to work on.
- viii. An employee who is undergoing on-the-job training, who, in the course of such training, has demonstrated an ability to perform duties safely at his or her level of training, and who is under the direct supervision of a qualified person is considered to be a qualified person for the performance of those duties. The process must be documented as proof.

13.2.9 USE OF HAND TOOLS AND POWER-OPERATED TOOLS

13.2.9.1 General Provisions

- a. All hand and power tools and similar equipment, shall be maintained in safe condition.
- b. When power operated tools are designed to accommodate guards, they shall be equipped
- c. with such guards, when in use;
- d. Belts, gears, shafts, pulleys, sprockets, spindles, drums, fly wheels, chains and other reciprocating, rotating or moving parts of the equipment shall be similarly guarded;
- e. Personnel using hand and power tools and exposed to the hazard of falling, flying, abrasive, and splashing objects, or exposed to harmful dusts, fumes, mists, vapors, or gases shall be



POWER
SECTOR

HEALTH, SAFETY AND ENVIRONMENT PLAN
FOR
SITE OPERATIONS
(SECTION-A)

Doc. No.: HSEP:14-
ER

Rev.: 00

Date:25.04.19

Page 70 of 162

provided with the particular personal protective equipment necessary to protect them from the hazards;

- f. All hand-held powered platen sanders, grinders, grinders with wheels of 5 cm or less, routers, planers, laminate trimmers, nibblers, shears, scroll saws and jigsaws with blade shanks of 0.5 cm wide or less shall be equipped with only a positive on-off control.
- g. All hand-held powered drills, tappers, fastener drivers, horizontal, vertical or angle grinders with wheels greater than 5 cm in diameter, disc sanders, belt sanders, reciprocating saws, saber saws and other operating powered tools shall be equipped with a momentary contact on control provided that turnoff can be accomplished by a single motion of the same finger or fingers that turn it on.

13.2.9.2 Hand Tools

- a. The subcontractor shall not issue or permit the use of unsafe hand tools;
- b. Wrenches including adjustable pipe end and socket wrenches shall not be used when saws are sprung to the point that slippage occurs;
- c. Impact tools such as drift pins, wedges and chisels shall be kept free of mushroomed heads;
- d. The wooden handles of tools shall be kept free of splinters or cracks and shall be kept tight on the tools.

13.2.9.3 Power Operated Tools

- a. Electric power operated tools shall be either of the approved double-insulated type or shall be grounded;
- b. The use of electric cords for hoisting or lowering loads shall not be permitted;
- c. Pneumatic power tools shall be secured to the hose or whip by some positive means to prevent the tool from becoming incidentally disconnected;
- d. Safety clips or retainers shall be securely installed or maintained on pneumatic impact (percussion) tools to prevent attachments from being incidentally expelled;
- e. All pneumatically riveting machine staplers and other similar equipment provided with automatic fastener feed, which operate at more than 7 kg/cm² pressure at the tool a safety device on the muzzle to prevent the tool from ejecting the fasteners unless the muzzle is in contact with the work surface;
- f. Compressed air shall not be used for cleaning purposes except when the pressure is reduced to less than 2 kg/cm² and that too with effective chip guarding. The 2 kg/cm² pressure requirement does not apply to concrete form, mill scale and similar cleaning purposes;
- g. The manufacturer's safe operating for hoses, pipes, valves, filters and other fittings shall not be exceeded;
- h. Only personnel who has been trained in the operation of the particular tool shall be allowed to operate power-actuated tools;
- i. The tool shall be tested each day before loading to see that the safety devices are in proper working condition. The method of testing shall be accordance with the manufacturer's



POWER
SECTOR

HEALTH, SAFETY AND ENVIRONMENT PLAN
FOR
SITE OPERATIONS
(SECTION-A)

Doc. No.: HSEP:14-
ER

Rev.: 00

Date:25.04.19

Page 71 of 162

recommended procedure;

- j. Any tool found not in proper working order, or that which develops a defect during use, shall be immediately removed from service and not used until properly repaired;
- k. Tools shall not be loaded until just prior to the intended firing time. Neither loaded nor empty tools are to be pointed at any other person. Hands shall be kept clear of the open barrel end;
- l. Loaded tools shall not be left unattended;
- m. Fasteners shall not be driven into very hard or brittle materials including, but not limited to, cast iron, glazed tiles, surface hardened steel, glass block, live rock, face brick or hollow tiles;
- n. Driving into materials that can be easily penetrated shall be avoided unless backed by a
- o. substance that will prevent the pin or fastener from passing completely through and creating a flying missile hazard on the other side;
- p. No fastener shall be driven into a palled area caused by an unsatisfactory fastening;
- q. Only non-sparking tools shall be used in an explosive or flammable atmosphere;
- r. All tools shall be used with the correct shield, guard or attachment as recommended by the manufacturer.

13.2.9.4 Abrasive Wheels and Tools

- a. All grinding wheel must be ISO certified only.
- b. All grinding machines shall be supplied with sufficient power to maintain the spindle speed at safe levels under all conditions of normal operation;
- c. Grinding machines shall be equipped with suitable safety guards;
- d. The maximum angular exposure of the grinding wheel periphery and sides shall not be more than 90°, except that when the work requires contact with the wheel below the horizontal plane of the spindle, the angular exposure shall not exceed 120°. In either case, the exposure shall begin not more than 8.650 above the horizontal plane of the spindle. Safety guards shall be strong enough to withstand the bursting of the wheel;
- e. Floor and bench-mounted grinders shall be work-rests, which shall be rigidly supported and readily adjustable. Such work-rests shall be kept at a distance not to exceed 5 mm from the surface of the wheel;
- f. Cup type wheels used for external grinding shall be protected by either revolving cup guard or a band type guard;
- g. When safety guards are required, they shall be mounted as to maintain proper alignment with the wheel and the guard and the guard and its fastening shall be adequate strength to retain the fragments of the wheel in case of incidental breakage. The maximum angular exposure of the grinding wheel periphery and sides shall not exceed 180°;
- h. Portable abrasive wheel used for internal grinding shall be provided with suitable safety flanges;
- i. When safety flanges are required, they shall be used only with wheels designed to fit the flanges. Only safety flanges, of a type and design and properly assembled so as to ensure that the pieces of the wheel will be retained in case of incidental breakage, shall be used;
- j. All abrasive wheels shall be closely inspected and ring tested before mounting to ensure that



POWER
SECTOR

HEALTH, SAFETY AND ENVIRONMENT PLAN
FOR
SITE OPERATIONS
(SECTION-A)

Doc. No.: HSEP:14-
ER

Rev.: 00

Date:25.04.19

Page 72 of 162

they are free from cracks or defects;

- k. Grinding wheels shall fit freely on the spindle and shall not be forced on. The spindle nut shall be tightened only enough to hold the wheel in place;
- l. All employees using abrasive wheels shall be protected by suitable eye protection equipment.

13.2.9.5 Wood Working Tools

- a. All fixed power driven woodworking tools shall be provided with a disconnect switch that can either be locked or tagged in the off-position;
- b. The operating speed shall be attached or otherwise permanently marked on all circular saws over 0.5 m in diameter or operating at over 3000 peripheral rpm. Any saw so marked shall not be operated at a speed other than that marked on the blade. When a marked saw is re-tensioned for a different speed, the marking shall be corrected to show the new speed;
- c. Automatic feeding devices shall be installed on machines wherever the nature of the work will permit. Feeder attachments shall have the feed rolls or other moving parts covered or guarded so as to protect the operator from hazardous points;
- d. All portable power driven circular saws shall be equipped with guards above and below the base plate or shoe. The upper guard shall cover the saw to the depth of the teeth, except for the minimum arc required to permit the base to be tilted for bevel cuts. The lower guard shall cover the saw to the depth of the teeth, except for the minimum arc required to allow proper retraction and contact with the work. When the tool is withdrawn from the work, the lower guard shall automatically and instantly return to the covering position.

13.2.10 START UP, COMMISSIONING AND TESTING:

There are various activities involved prior to commissioning- the major ones are -Hydraulic Test, Steam Blowing, Transformers Charging, Boiler Light Up, Rolling and Synchronisation and Full loading of unit.

- a. These activities shall be personally supervised by the site executive along with the commissioning engineer.
- b. Appropriate Work Permits shall be taken as applicable
- c. The readiness of upstream and downstream system shall be ensured before taking up.
- d. These shall be handled strictly by the authorized persons only and the team shall be suitably briefed about the activity including hazards & risks involved and control plan by the concerned executive-in-charge before start.
- e. Entry of persons to the area of activity shall be suitably restricted and the emergency functions like Ambulance, first aid center and Fire station shall be intimated about the plan well in advance.
- f. Tag-in/ Tag-out shall be in place while charging transformer and whenever necessary.
- g. Electricians with valid wiremen license only shall be permitted to work on power lines.
- h. The area and the passage shall be adequately illuminated.



POWER
SECTOR

HEALTH, SAFETY AND ENVIRONMENT PLAN
FOR
SITE OPERATIONS
(SECTION-A)

Doc. No.: HSEP:14-
ER

Rev.: 00

Date:25.04.19

Page 73 of 162

13.2.11 FIRE SAFETY

Numbers and types of Fire Extinguishers shall be ensured as follows:

Sl. No	Type of Fire Risk (Class of Fire)	Extinguishing Medium & Relevant Indian Standard	Scale of Equipment (Minimum recommended)
1.	CLASS 'A' Fires involving ordinary combustible materials like wood, paper, textiles, rubber etc. (Ordinary hazard or low fire load)	WATER Soda acid type, water type (gas pressure) and water type (constant air pressure) IS: 934 -1976; IS: 940 -1976; IS: 6234 -1971	For every 600 square meter floor area or part, one 9-litre capacity. Minimum 4 numbers per floor or room; should not be required to travel more than 15 meter to reach any extinguisher.
2.	CLASS 'A' (Extra hazard & high fire load)	-do	-do – (Also, consult local fire authority).
3.	CLASS 'A' (Special hazards)	-do	-do – Extra provision For every 100 square meter floor area or part, one 4.5 Kg. CO ₂ ; minimum 2 numbers per room; should not be required to travel more than 10 meter to reach any extinguisher.
4.	CLASS 'B' (Fires in flammable liquids like oils, solvents, petroleum, products, varnishes, paints, etc. where blanketing effect is essential) (Storage and handling in small quantities)	FOAM / CARBON DIOXIDE / DRY CHEMICAL POWDER IS: 933 -1976; IS: 2878 1976; IS: 2171 1976; IS: 4308 -1982	For every 50 square meter floor area or part, 2 numbers 9 -liters foam or 5 kg dry powder; should not be required to travel more than 10 m in the area of storage to reach any extinguisher.
5.	CLASS 'B' (Bulk storage other than in tank form)	-do -	-do- (but minimum 3 numbers per room)
6.	CLASS 'C' (Fires involving gaseous substances under pressure where it is necessary to dilute the burning gas at a very fast rate with an inert gas or powder) (locations of storage and handling of gas cylinders)	CARBON DIOXIDE / DRY CHEM. POWDER. The best way to extinguish such fire is by stopping the flow of fuel gas to the fire. Container is kept cool with water spray. IS: 2878 1976; IS: 2171 -1976; IS: 4308 -1982	For every 100 square meter floor area or part; 2 numbers, 10 kg powder extinguisher or 6 kg CO ₂ ; minimum 3 nos. per room; should not be required to travel more than 10 meter to reach any extinguisher.
7.	CLASS 'D' Fires involving metals like magnesium, aluminum, zinc, potassium etc. where the burning metal is reactive to water and which require special extinguishing media or technique	SPECIAL DAY POWDER IS: 2171 -1976 IS: 4861 -1968	For every 50 square meter floor area or part, 2 nos. 5 kg special dry powder; minimum 3 nos. per room; should not be required to travel more than 10 meter to reach any extinguisher.
8.	MIXED OCCUPANCY (electrical); Generators; Transformers; etc.	CARBON DIOXIDE DRY POWDER, IS: 2878 -1976; IS: 2171 -1976	For every 100 square meter floor area or part one 10 kg CO ₂ . Minimum 2 numbers for every location should not be required to travel more than 10 meter to reach an extinguisher.

Note: Due to peculiarities of the power plant construction sites, there would be locations in the construction areas of Boiler, Turbine, Generator, Transformer, etc. where different types of fire risk (classes of fire) may co-exist. Special



POWER
SECTOR

HEALTH, SAFETY AND ENVIRONMENT PLAN
FOR
SITE OPERATIONS
(SECTION-A)

Doc. No.: HSEP:14-
ER

Rev.: 00

Date:25.04.19

Page 74 of 162

care shall be taken while selecting and installing portable fire extinguishers for such locations so that all types of fire risk that may co-exist, are adequately covered. Similar special care shall be taken for storage areas.

1. All Electrical welding booths shall be equipped with appropriate Fire Extinguisher
2. Appropriate Fire Extinguishers shall be made within easy reach of all welding operations
3. Fire extinguishers shall be regularly tested and last checked date to be indicated on each.
4. Providing appropriate firefighting equipment at designated work place and nominate a fire officer/warden adequately trained for his job.
5. Subcontractor shall provide enough fire protecting equipment of the types and numbers at his office, stores, temporary structure in labour colony etc. Such fire protection equipment shall be easy and kept open at all times.
6. The fire extinguishers shall be properly refilled and kept ready which should be certified at periodic intervals. The date of changing should be marked on the Cylinders.
7. All other fire safety measures as laid down in the "codes for fire safety at construction site" issued by safety coordinator of BHEL shall be followed.
8. Non-compliance of the above requirement under fire protection shall in no way relieve the subcontractor of any of his responsibility and liabilities to fire incident occurring either to his materials or equipment or those of others.
9. Emergency contacts nos. must be displayed at prominent locations
10. Tarpaulin being inflammable should not be used (instead, only non-infusible covering materials shall be used) as protective cover while preheating, welding, stress relieving etc. at site.

13.2.12 HSE PREPAREDNESS FOR ADVERSE CLIMATES AND WEATHER

Subcontractor to remain updated on possible adverse weather conditions through reliable sources and all precautions taken accordingly.

13.2.12.1 SUMMER

1. The Working Time and Lunch Hour will be as per instruction of Statutory Authorities (no work between 11am to 3:30pm). However, in case temp comes down due to rain/cloudy weather work will continue as per normal routine.
2. During long lunch break, worker will be allowed to go back home for rest. Those who will like to stay back will avail at the facility of rest shed or other designed area.
3. They will be allowed to take small break during work as per their need.
4. Water sprinkling will be done on roads to reduce dust concentration.
5. Workers will be provided with adequate cool drinking water and Butter milk/Lemon water etc.
6. Adequate ORS stock will be made available at the work location in the First-Aid Box for use as needed and at First-aid Center for emergency need.
7. Fire prevention shall be on high alert, with removal of dry grass and bushes, etc, inside and outside the surrounding work areas. No smoking, and control of open flame/sparks shall be maintained and monitored.
8. Worker will be informed about the Do's and Don'ts to be followed during summer in the Pre Job Brief.



POWER
SECTOR

HEALTH, SAFETY AND ENVIRONMENT PLAN
FOR
SITE OPERATIONS
(SECTION-A)

Doc. No.: HSEP:14-
ER
Rev.: 00
Date:25.04.19
Page 75 of 162

Do's & Don'ts

9. Drink plenty of cool water and other non-alcoholic fluid and keep body well hydrated.
10. Eat salt in food to replenish loss of salt through sweating.
11. Avoid over physical exercise.
12. Have adequate sleep at night.
13. Eat light and less spicy food
14. Avoid eating food which was cooked long time ago.
15. Nobody should use small water bodies such as pits, running rain water through crevices etc. for drinking and cleaning purpose as it may be unhygienic.

Emergency Handling

In case of emergency due to heat disorder:

16. Rescue the victim from workplace and place under shed.
17. If to be rescued from height, use stoke basket or rescue kit.
18. Inform Ambulance immediately.
19. If nearby any air conditioned room/shed is available, place him inside the room/shed.
20. Administer First aid by trained First aider for Heat Disorder
21. If conscious, give him ORS solution to drink.
22. If required send the victim hospital immediately.

13.2.12.2 Monsoon

A. Height Work & Structural Safety:

1. Ensure that all height work platforms are barricaded and avoid any highly hazardous
2. height work.
3. Ensure that all personnel have good quality and intact safety shoes
4. Stop all dangerous height work during rain
5. Explain Do's and Don'ts to workers during Tool Box Meetings
6. Ensure that there are no weak structures, boards etc. that can fall during high winds
7. Do not allow any loose material (e.g. GI sheet, Ply board, empty cement bag, aluminum foil, foam sheets etc.) on roof sheds or top of structures.
8. Do not permit any one to ride up or come down scaffolds frame work during heavy wind or rain.
9. Provide "anchor" of adequate strength to scaffolds and other high-rise structures.
10. All rest sheds and GI sheds will be anchored into the round and wall and roof panels will be secured with J hook to prevent shed from blowing over or parts/pieces becoming airborne. Proper earthing per IS standard is also to be installed.
11. Do not go alone nor permit anyone to stay at tower-tops, roof-tops, high structures or on electrical poles during the course of stormy weather or heavy rain.



POWER
SECTOR

HEALTH, SAFETY AND ENVIRONMENT PLAN
FOR
SITE OPERATIONS
(SECTION-A)

Doc. No.: HSEP:14-
ER

Rev.: 00

Date:25.04.19

Page 76 of 162

B. Electrical:

1. All electrical connections / loads have to be routed through ELCB / RCCB (residual current circuit breaker) whose rating should be 30mA.
2. RCCB operational checks need to be done DAILY / WEEKLY during monsoon season.
3. Avoid joints on power cables which need to be laid over-head or under-ground, better not to have any joint at all. In case joints become essential, such cables must be housed rigidly and insulation must be provided as per approved standard. The joint shall be suitable for outdoor use.
4. All electrical distribution board shall be properly covered at top and sides to protect from rain water. Extension boards shall be protected from rain water.
5. Ensure proper "earthing" for each and every electrical appliance.
6. Double earthing need to be provided for 3-phase power supply and for voltage more than 220V.
7. Provide lightening arrestors at the top of Boiler 3 and boiler 4 and rest sheds which are not covered by existing lightening arrestor of other installation.

C. Others:

1. Maintain smooth flow on open drains. i.e. no obstruction or blockade shall be made on storm water drains. If required, make temporary drains.
2. Arrange back-filling of excavated pits on war-footing basis.
3. Arrange bringing down booms of all cranes, hydra machines during stormy weather (wind speed 40-50 kmph)
4. Confirm that all gantry cranes are effectively choked to prevent rolling and toppling.
5. Do not forget to deep ready a dew battery operated lights at site-offices during rainy season.
6. Avoid using wet damp clothes.
7. Barricade excavated zone filled with water.
8. Engage diesel operated water pump to dewater work area. For electrically operated water pump, the starter shall be protected from rain water. All rotating parts shall be guarded. Ensure availability of sufficient water pumps.

D. Health and hygiene:

1. Monsoon reduces the immunity of our body and makes us vulnerable to many diseases which are commonly associated with this season. It is time for us to keep our body challenging against disease by boosting our immunity and taking safety measures against these diseases.



**POWER
SECTOR**

**HEALTH, SAFETY AND ENVIRONMENT PLAN
FOR
SITE OPERATIONS
(SECTION-A)**

Doc. No.: HSEP:14-
ER

Rev.: 00

Date:25.04.19

Page 77 of 162

2. The diseases associated with monsoon are Malaria, Jaundice, Gastro-intestinal infections, like typhoid, cholera etc. apart from these viral infections like cold and cough also make their presence felt. Majority of above said diseases are on account of:
3. Puddle of water formed due to rain become breeding grounds for mosquitoes which spread disease like, malaria and dengue fever. As a precautionary measure against mosquito-bite disease one can use mosquito net around the end which is better choice to mosquito repellants like mats and coils.
4. Pollution of drinking water during monsoon is very common. It is very necessary to drink clean and pure water when water-borne monsoon diseases like diarrhea and gastro-intestinal infections threaten us.
5. Walking in dirty water during rainy season leads of numerous fungal infection which affect toes and nails. Diabetic patients have to take a special care about their feet. Keeping feet always dry and clean is very necessary. Avoid walking in dirty water. Keep shoes socks and raincoats dry and clean.

E. Workmen will be made aware of following Do's and Don'ts:

1. Do not sleep in daytime.
2. Avoid over physical exertion.
3. During lightning and thunder storm, do not take shelter under tree. Take shelter inside rest shed or store room.
4. Wash vegetables with clean water and steam them well to kill germs.
5. Avoid eating un-cooked foods and salads should be washed properly before consumption.
6. Drink plenty of water and keep body well-hydrated.
7. Always keep the surrounding area dry and clean. Don't allow to get water accumulated around.
8. Keep body warm as viruses attack immediately when body temperature goes down.
9. Do not enter air conditioned room with wet hair and damp cloths.
10. Dry your feet and webs with soft dry cloth whenever they are wet.
11. Eat light and less spicy food.
12. Avoid eating food which was cooked long time ago.
13. Eat salt in food to replenish loss of salt through sweating.

13.2.12.3 Emergency Weather Conditions

A. Cyclone/Severe thunder storm

In the event of Cyclone/Severe thunder storm, alert will be issued by subcontractor on notification received by Govt. authorities/Metrological departments Customer or BHEL.

The actions required during cyclone/rough weather:

1. Check and advice subcontractors to cleanup work area. Pick up all loose and unused material of respective supervisor's area.
2. Tie to secure all gas cylinders to avoid displacement and unsafe conditions which could be due to wind pressure.



**POWER
SECTOR**

**HEALTH, SAFETY AND ENVIRONMENT PLAN
FOR
SITE OPERATIONS
(SECTION-A)**

Doc. No.: HSEP:14-ER
Rev.: 00
Date:25.04.19
Page 78 of 162

3. Secure portable electricity generating sets and other equipment, pumps, hoses etc.
4. Make preparation for removal of water logging.
5. Take review of work activity and make preparation for removal of equipment and material from vulnerable areas.
6. Isolate/turn off all electrical power form the main panel/switches. Secure and anchor panels properly.
7. Recheck anchorage/tie of all temporary structures/sheds, tall objects, cranes, rigs, scaffolds etc. to avoid toppling due to wind force.
8. Cranes boom shall be secured, either locked or lowered the booms as reasonably and practicably possible and rigs to safe position for the safety point of view.
9. Group up all trash barrels, wooden pallets, forms; wooden decks etc. and anchor properly.
10. Welding machines, air compressors and such equipment are to be grouped together and secured to the stable objects. Welding leads, electrical cables, hoses are to be rolled up and secured properly.
11. Set on site vehicles on high ground in the site area with brakes set firmly.
12. Anchor all tanks, vessels, gas cylinders that may be moved by high wind and water.
13. Evacuate job site.

Personnel Evacuation:

14. Personnel Evacuation will be required if predicted wind speed and storm surge heights are beyond acceptable limits as per the instructions from Govt. Authorities/ Metrological departments or Customer.
15. Once the warning is received for personnel evacuation, an emergency response team shall be formed. The team will work with local authorities and other agencies formed/deployed to evacuate and transport all personnel involved in the project to the cyclone shelter.
16. Cyclone may be followed by the calm "EYE", be aware of it. If the wind suddenly drops, don't assume the cyclone is over. Violent wind may resume from the opposite side direction. Wait for the official "All clear Signal".
17. After the cyclone, do not go outside until officially communicated about safe situation outside. Use recommended routes for returning. Do not panic or rush while returning.
18. Checking of gas leaks and well being of electrical appliances is essential before leaving the site.
19. Follow local communications for official warning and advice. The construction Manager shall also obtain updates from customer/metrological departments and communicate to the personnel on project site.

13.2.12.4 Preparedness for Other Adverse Climates and Weather Conditions

All Preventive and Precautionary measures to ensure Health & Safety of workers in all possible adverse weather conditions based on the analysis of the local area conditions to be taken by the subcontractor

13.3 ENVIRONMENTAL CONTROL

1. Environment protection has always been given prime importance by BHEL. Environmental



POWER
SECTOR

HEALTH, SAFETY AND ENVIRONMENT PLAN
FOR
SITE OPERATIONS
(SECTION-A)

Doc. No.: HSEP:14-
ER
Rev.: 00
Date:25.04.19
Page 79 of 162

damage is a major concern of the principal subcontractor and every effort shall be made, to have effective control measures in place to avoid pollution of Air, Water and Land and associated life.

2. Subcontractor shall list out all applicable environmental aspects and impacts, and ensure control measures to manage the same.
3. Chlorofluorocarbons such as carbon tetrachloride and trichloroethylene shall not be used.
4. Waste disposal shall be done in accordance with the guidelines laid down in the project specification.
5. Any chemical including solvents and paints, required for construction shall be stored in designated bonded areas around the site as per MSDS.
6. In the event of any spillage, the principle is to recover as much material as possible before it enters drainage system and to take all possible action to prevent spilled materials from running off the site. Subcontractor shall use appropriate MSDS for clean-up technique. Subcontractor shall be responsible for the cleanliness of their own areas.
7. Subcontractor shall ensure that noise levels generated by plant or machinery are as low as reasonably practicable. Where the subcontractor anticipates the generation of excessive noise levels from his operations the subcontractor shall inform BHEL accordingly so that reasonable & practicable precautions can be taken to protect other persons who may be affected.
8. It is imperative on the part of the subcontractor to join and effectively contribute to environmental protection measures such as tree plantation and towards social causes and maintaining good relations with local populace.
9. The subcontractor shall carry out periodic air and water quality check and illumination level checking in respective area of work place and take suitable control measure to maintain the same as per applicable laws / standards

13.3.1 WASTE MANAGEMENT

1. Subcontractor shall take suitable measures for waste management and fulfilling requirements of environment related laws/legislation as a part of normal construction activities.
2. Compliance with the legal requirements on storage/ disposal of paint drums (including the empty ones), Lubricant containers, Chemical Containers, and transportation and storage of hazardous chemicals will be strictly maintained.
3. Details of E-Waste, Hazardous Waste, shall be submitted to BHEL as per Format No. HSEP: 14-F18 and HSEP: 14-F19 respectively

13.3.1.1 BINS AT WORK PLACE

1. Sufficient rubbish bins shall be provided close to workplaces.
2. Bins should be painted yellow and numbered.
3. Sufficient nos. of drip trays shall be provided to collect oil and grease.
4. Sufficient qty. of broomsticks with handle shall be provided.
5. Adequate strength of employees should be deployed to ensure daily monitoring and service for waste management.

13.3.1.2 STORAGE AND COLLECTION

1. Different types of rubbish/waste should be collected and stored separately.



POWER
SECTOR

HEALTH, SAFETY AND ENVIRONMENT PLAN
FOR
SITE OPERATIONS
(SECTION-A)

Doc. No.: HSEP:14-
ER

Rev.: 00

Date:25.04.19

Page 80 of 162

2. Paper, oily rags, smoking material, flammable, metal pieces should be collected in separate bins with close fitting lids.
3. Rubbish should not be left or allowed to accumulate on construction and other work places.
4. Do not burn construction rubbish near working site.

13.3.1.3 SEGREGATION

1. Earmark the scrap area for different types of waste.
2. Store wastes away from building.
3. Oil spill absorbed by non-combustible absorbent should be kept in separate bin.
4. Clinical and first aid waste stored and incinerated separately.

13.3.1.4 DISPOSAL

1. Sufficient containers and scrap disposal area should be allocated.
2. All scrap bin and containers should be conveniently located.
3. Provide self-closing containers for flammable/spontaneously combustible material.
4. Keep drainage channels free from choking.
5. Make schedule for collection and disposal of waste.

13.3.1.5 WARNING AND SIGNS

1. Appropriate signage to be displayed at scrap storage area
2. No toxic, corrosive or flammable substance to be discarded into public sewage system.
3. Waste disposal shall be in accordance with best practice.
4. Comply with all the requirements of Pollution Control Board (PCB) for storage and disposal of hazardous waste.

13.4 HOUSEKEEPING

1. Keeping the work area clean/ free from debris, removing unused scaffoldings, scraps, insulation/ sheeting wastage /cut pieces temporary structures, packing woods etc. will be in the scope of the subcontractor.
2. Such cleaning has to be done by subcontractor within quoted rate, on daily basis by dedicated identified groups equipped with all require PPEs and training. The details of housekeeping group shall be provided to BHEL.
3. If such activity is not carried out by subcontractor / BHEL is not satisfied, then BHEL may get it done by other agency and actual cost along with BHEL overheads will be deducted from subcontractor's bill. Such decisions of BHEL shall be binding on the subcontractor.
4. Pests, such as beehives etc. shall be periodically removed in a humane fashion
5. **Following are to be taken care of on daily basis.**
 - i. All surplus earth and debris are removed/disposed of from the working areas to identified locations.
 - ii. Unused/Surplus cables, steel items and steel scrap lying scattered at different places /elevation within the working areas are removed to identify locations.
 - iii. All wooden scrap, empty wooden cable drums and other combustible packing materials, shall



POWER
SECTOR

HEALTH, SAFETY AND ENVIRONMENT PLAN
FOR
SITE OPERATIONS
(SECTION-A)

Doc. No.: HSEP:14-
ER

Rev.: 00

Date:25.04.19

Page 81 of 162

be removed from workplace to identified locations. Sufficient waste bins shall be provided at different work places for easy collection of scrap/waste. Scrap chute shall be installed to remove scrap from high locations

- iv. Access and egress (stair case, gangways, ladders etc.) path should be free from all scrap and other hindrances.
- v. Workmen shall be educated through tool box talk about the importance of housekeeping and encourage not to litter.
- vi. Labor camp area shall be kept clear and materials like pipes, steel, sand, concrete, chips and bricks, etc. shall not be allowed in the camp to obstruct free movement of men and machineries.
- vii. Fabricated steel structures, pipes & piping materials shall be stacked properly.
- viii. No parking of trucks/trolleys, cranes and trailers etc. shall be allowed in the camp, which may obstruct the traffic movement as well as below LT/HT power line.
- ix. Utmost care shall be taken to ensure over all cleanliness and proper upkeep of the working areas

13.5 TRAFFIC MANAGEMENT

13.5.1 SAFE WORKPLACE TRANSPORT SYSTEM

1. Traffic routes in a work place shall be suitable for the persons or vehicles using them.
2. Traffic routes for pedestrians and vehicles shall be clearly demarcated and indicated
3. Traffic routes shall never intersect the area of work and shall not endanger the site personnel
4. For internal traffic, lines marked on roads / access routes and between buildings shall clearly indicate where vehicles are to pass.
5. Temporary obstacles shall be brought to the attention of drivers by warning signs / hazard cones.
6. Power cables shall be maintained at a minimum height above ground as specified in Indian Electricity Act & Rules.
7. Sensible speed limits shall set and clearly displayed. Painted Speed ramps preceded by a warning signs or marker are necessary for stretches of roads exceeding 50 meters.
8. The traffic route should be wide enough to allow vehicles to pass and re-pass oncoming or parked traffic and it may be advisable to introduce on-way system or parking restrictions.
9. Safest route shall be provided between places where vehicles have to call or deliver.
10. Avoid vulnerable areas/items such as fuel or chemicals tanks or pipes, open or unprotected edges and structures likely to collapse
11. Safe areas shall be provided for loading and unloading of material. Loading / Unloading Permit shall be taken from BHEL prior to any significant loading / unloading activity
12. Avoid sharp or blind bends. If this is not possible hazards should be indicated e.g. blind corner.
13. Ensure road crossings are minimum and clearly signed.
14. Entrance and gateways shall be wide enough to accommodate a second vehicle without causing obstruction.
15. Forklift trucks shall not pass over road hump unless of a type capable of doing so.



**POWER
SECTOR**

**HEALTH, SAFETY AND ENVIRONMENT PLAN
FOR
SITE OPERATIONS
(SECTION-A)**

Doc. No.: HSEP:14-ER
Rev.: 00
Date:25.04.19
Page 82 of 162

16. Overhead electric cable, pipes containing flammable hazardous chemical shall be shielded by using goal posts height gauge posts or barriers.
17. The height of Power cables above areas of movement shall conform to Indian Electricity Rules
18. Road traffic signs shall be provided on prominent locations for prevention of accidents and hazards and for quick guidance and warning to employees and public.
19. Safety signs shall be displayed as per the project working requirement and guideline of the state in which project is done.
20. Vehicles hired or used shall not be parked within the 15m radius of any working area. Any vehicle, that is required to be at the immediate/near the vicinity, shall be approved by the person in-charge of the site.

13.5.2 TRAFFIC ROUTE FOR PEDESTRIANS

1. Where traffic routes are used by both pedestrians and vehicles road shall be wide enough to allow vehicles and pedestrians safely.
2. Separate routes shall be provided for pedestrians to keep them away from vehicles. Provide suitable barriers/guard at entrances/exit and the corners or buildings.
3. Where pedestrian and vehicle routes cross, appropriate crossing shall be provided.
4. Where crowd is likely to use roadway e.g. at the end of shift, stop vehicles from using them at such times.
5. Provide high visibility clothing for people permitted in delivery area.

13.5.3 WORK VEHICLES

Work vehicles shall be as safe stable efficient and roadworthy as private vehicles on public roads. Subcontractors shall ensure that drivers are suitably trained and have valid license and experience for the designated class of vehicle. All vehicle e.g. heavy motor vehicle forklift trucks dump trucks mobile cranes shall ensure that the work equipment conforms to the following:

1. A high level of stability.
2. A safe means of access/egress.
3. Suitable and effective service and parking brakes.
4. Windscreens with wipers and external mirrors giving optimum all round visibility.
5. Provision of horn, vehicle lights, reflectors, reversing lights, reversing alarms.
6. Provision of seat belts.
7. Guards on dangerous parts.
8. Driver protection - to prevent injury from overturning and from falling objects/materials.
9. Driver protection from adverse weather.
10. No vehicle shall be parked below HT/LT power lines in conformance to Indian Electricity Act & Rules.
11. Valid Pollution Under Control certification for all vehicles



POWER
SECTOR

HEALTH, SAFETY AND ENVIRONMENT PLAN
FOR
SITE OPERATIONS
(SECTION-A)

Doc. No.: HSEP:14-
ER
Rev.: 00
Date:25.04.19
Page 83 of 162

13.5.4 DAILY CHECKS BY DRIVER

There should also be daily safety checks containing below mentioned points by the driver before the vehicle is used. Subcontractors should ensure that drivers carry out these checks as a minimum.

Brakes	Mirrors	Warning signals
Tires	Windscreen waters	Specific safety system i.e. control interlocks
Steering	Wipers	

13.5.5 TRANSPORTATION OF PERSONNEL AND MATERIALS BY VEHICLES

1. All drivers shall hold a valid driving License for the class of vehicle to be driven and be registered as an authorized BHEL driver with the Administration Department.
2. Securing of the load shall be by established and approved methods, i.e. chains with patented tightening equipment for steel/heavy loads. Sharp corners on loads shall be avoided when employing ropes for securing.
3. All overhangs shall be made clearly visible and restricted to acceptable limits
4. Load shall be checked before moving off and after traveling a suitable distance.
5. On no account is construction site to be blocked by parked vehicles Drivers of vehicles shall only stop or park in the areas designate by the stringing foreman.
6. Warning signs shall be displayed during transportation of material.
7. All vehicles used by Subcontractor shall be in worthy condition and in conformance to the Land Transport requirement

13.5.6 MAINTENANCE

All Vehicles used for transportation of man and material shall undergo scheduled inspections on frequent intervals to secure safe operation. Such inspections shall be conducted in particular for steering, brakes, lights, horn, doors etc. Site management shall ensure that work equipment is maintained in an efficient, working order and in good repair. Inspections and services carried out at regular intervals of time and or mileage. No maintenance shall be carried below HT/LT power lines.

13.6 EMERGENCY PREPAREDNESS AND RESPONSE

1. Subcontractor shall develop Emergency preparedness and response capability and Emergency Response Team as per [HSEP06: HSE Procedure for Emergency Preparedness and Response](#)
2. Availability of adequate number of first aiders and fire warden shall be ensured
3. All the subcontractor's supervisory personnel and sufficient number of workers shall be trained for fire protection systems. Enough number of such trained personnel must be available during the tenure of contract. Subcontractor should nominate his supervisor to coordinate and implement the safety measures and communicate the same to BHEL.
4. Assembly point shall be earmarked and access to the same from different location shall be shown
5. Fire exit shall be identified and pathway shall be clear for emergency escape.
6. Appropriate type and number of fire extinguisher shall be deployed as per Clause No. 13.2.11 and validity shall be ensured periodically through inspection
7. Adequate number of first aid boxes shall be strategically placed at different work places to cater



POWER
SECTOR

HEALTH, SAFETY AND ENVIRONMENT PLAN
FOR
SITE OPERATIONS
(SECTION-A)

Doc. No.: HSEP:14-
ER

Rev.: 00

Date:25.04.19

Page 84 of 162

- to all emergency needs. Holder of the first aid box shall be identified on the box itself who will have the responsibility to maintain the same.
8. First aid center shall be developed at site with trained medical personnel and ambulance
 9. Emergency contact numbers of the site shall be displayed at prominent locations.
 10. Tie up with fire brigade shall be done in case customer is not having fire station.
 11. Tie up with hospital shall be ensured in order to ensure the availability of following services to victims quickly without wasting precious time:
 - a. Intensive Care Unit with Ventilator and other necessary life support systems
 - b. Facility of specialized Orthopedic Surgery – in case of fracture / amputation
 - c. Facility of specialized brain / neuro surgery – in case of head trauma
 - d. Facility of specialized burn unit / ward – in case of Fire / burn injury
 - e. and other facilities as per requirement at site location

In case tie up with multiple hospitals is required to cover all possible accidents, same shall be done. The list of facilities to be regularly checked and updated.
 12. A detailed emergency services (Fire / Medical etc.) tie up plan shall be submitted to BHEL in monthly report Format No. HSEP:14-F05
 13. Mock drill shall be conducted on different emergencies periodically to find out gaps in emergency preparedness and taking necessary corrective action

14 HSE INSPECTION

Inspection on HSE for different activities being carried out at site shall be done to ensure compliance to HSEMS requirements. The subcontractor shall maintain necessary safety equipment as applicable, to enable inspection personnel/agency perform Inspection. If any test equipment is found not complying with proper safety requirements then the Inspection Agency may withhold inspection, till such time the desired safety requirements are met.

The requirements of respective work permits are to be ensured by respective supervisors, safety personnel and area in-charges. In addition, the formats & checklists as per Clause 21 of this document provided by BHEL shall be used for inspection by Safety personnel (as a minimum), and records of inspection to be maintained. BHEL shall reserve the right to modify any Format in this document or introduce additional checklists / formats to ensure regular inspection of all equipment as per requirement.

14.1 DAILY HSE CHECKS

Both the Site Supervisors and HSE Supervisors are to conduct daily site Safety inspection around work activities and premises to ensure that work methods and the sites are maintained to an acceptable standard. The following are to form the common subjects of a daily safety inspection:



POWER
SECTOR

HEALTH, SAFETY AND ENVIRONMENT PLAN
FOR
SITE OPERATIONS
(SECTION-A)

Doc. No.: HSEP:14-
ER
Rev.: 00
Date:25.04.19
Page 85 of 162

1. Height Work:

- a. Safe, barricaded platform
 - b. PPEs
 - c. Proper method
 - d. Awareness
2. Personal Safety wears & gear compliance.
 3. Complying with site safety rules and permit-to-work (PTW).
 4. Positions and postures of workers.
 5. Use of tools and equipment etc. by the workers.
 6. The inspection shall be carried out just when work starts in beginning of the day, during peak activities period of the day and just before the day's work ends.

14.2 INSPECTION OF HEIGHT WORKING

1. Any kind of height work (above 2 meters) shall not be carried out without active physical supervision by concerned supervisor or safety personnel. All non-conformances related to height work shall be handled on priority and closed immediately after halting the work.
2. A roster of personnel deployed for inspection of height work and other critical activities shall be prepared and submitted to BHEL in monthly report Format No. HSEP:14-F05, in order to ensure effective supervision at all times
3. Inspection on height working shall be conducted **daily** by supervisors before start of work to ensure safe working condition including provision of:

a. Fall arrestor	d. Fencing and barricading	g. Proper scaffolding with valid Tags, access and egress.
b. Lifelines	e. Warning signage	h. Illumination
c. Safety nets	f. Covering of opening	

4. Inspection on height working shall be conducted once in a week by HSE officer as per
5. Format no. HSEP: 14-F10.
6. Medical fitness, including vertigo test of height worker shall be ensured.
7. Height working shall not be allowed during adverse weather.

14.3 INSPECTION OF PPE

PPEs shall be inspected by HSE officer at random once in a week as per Format no. HSEP: 14-F06 for compliance to standard and provisions and any adverse observation shall be recorded in the PPE register.

14.4 INSPECTION OF T&Ps

1. All T& Ps being used at site shall be inspected by HSE officer once in a month as per specific Formats in this document, or (if not available) general Format no. HSEP: 14-F07 for its healthiness and maintenance.
2. A master list of T&Ps and validity of their inspection certificates shall be maintained by each agency and details shall be submitted to BHEL in monthly format no. HSEP:14-F05.
3. The T&Ps which require third party inspection shall be checked for its validity during inspection.

 <p>POWER SECTOR</p>	HEALTH, SAFETY AND ENVIRONMENT PLAN FOR SITE OPERATIONS (SECTION-A)	Doc. No.: HSEP:14-ER
		Rev.: 00
		Date:25.04.19
		Page 86 of 162

The third party test certificate should be accompanied with a copy of the concerned competent person's valid qualification record. BHEL shall be given advance intimation of Third Party Inspection. BHEL shall associate with Inspection as per discretion.

14.5 INSPECTION OF CRANES AND WINCHES

1. Cranes and winches shall be inspected by the operator through a daily checklist for its safe condition (as provided by the equipment manufacturer) before first use of the day.
2. Cranes and Winches shall be inspected by HSE officer once in a month as per Format no. HSEP: 14-F08 & F09 for healthiness, maintenance and validity of third party inspection.
3. The date of third party inspection and next due date shall be painted on cranes and winches.
4. The operators/drivers shall be authorized by sub-contractor based on their competency and experience and shall carry the I-card.
5. The operator should be above 18 years of age and should be in possession of driving license of HMV man & goods), vision test certificate and should have minimum qualification so that he can read the instructions and check list.

14.6 INSPECTION ON WELDING AND GAS CUTTING OPERATION

1. Supervisor shall ensure that no flammable items are available in near vicinity during welding and gas cutting activity.
2. Gas cylinders shall be kept upright.
3. Use of Flash back arrestor shall be ensured at both ends.
4. Inspection during welding and gas cutting operations shall be carried out by HSE officer once a month as per Format no. HSEP: 14-F11.
5. Use of fire blanket to be ensured to avoid falling of splatters during welding or gas cutting operation at height.
6. Availability of fire extinguisher in vicinity shall be ensured.

14.7 INSPECTION ON ELECTRICAL INSTALLATION / APPLIANCES

1. Ensure proper earthing in electrical installation
2. Use of ELCB at electrical booth
3. Electrical installation shall be properly covered at top where required
4. Use appropriate PPEs while working
5. Use portable electrical light < 24 V in confined space and potentially wet area.
6. Monthly inspection shall be carried out as per Format no. HSEP: 14-F12.

14.8 INSPECTION OF ELEVATOR

1. Elevators shall be inspected by concerned supervisors once in a week as per Format no. HSEP: 14-F13.
2. All elevators shall be inspected by competent person and validity shall be ensured.
3. The date of third party inspection and next due date shall be painted on elevator.



POWER
SECTOR

HEALTH, SAFETY AND ENVIRONMENT PLAN
FOR
SITE OPERATIONS
(SECTION-A)

Doc. No.: HSEP:14-
ER
Rev.: 00
Date:25.04.19
Page 87 of 162

14.9 MONTHLY SITE INSPECTION

Subcontractor shall carry out monthly HSE inspection of all work areas as per Format No. HSEP:14-F20 and submit to BHEL

14.10 NON-CONFORMITY HANDLING:

Any serious non-conformances identified during inspection observed shall be addressed immediately.

In case immediate closure of non-conformities is not possible:

- work to be halted in the area
- Non-conformance to be generated and submitted to responsible person and BHEL
- non-conformance to be resolved through responsible agency / person
Only after closure of serious non-conformances, work to be allowed to resume.

All non-conformances & safety violations to be recorded and closed in a time bound manner.

15 HSE PERFORMANCE

HSE performance of subcontractor shall be monitored as per BHEL criteria, based on which, marks will be awarded. Marks can be used to evaluate and rate the contractor as per BHEL internal systems

HSE performance of the subcontractor shall be monitored as per the following parameters: (For each contract-wise package). **Periodicity:** RA Bill period

Sl. No.	Parameters of measurement	Ref Clauses	Weightage	Actual
1	Availability of safety officers at site – absence up to 15% permissible. Score proportionately gets reduced with higher rate of absence. Availability to be reckoned from start date of manpower mobilization	7.1	10	
2	Attendance by the safety officer and site CM (as applicable) in the meeting convened by BHEL	20	5	
3	Level of compliance w.r.t decisions taken in previous meetings/audit/inspection/as reported.	-do-	5	
4	Timely submission of monthly report on safety in the prescribed format	11	3	
5	Timely reporting any incident including near-miss to BHEL /Customer/statutory authority (if required) and submission of investigation report of all LTIs/	12	10	



**POWER
SECTOR**

**HEALTH, SAFETY AND ENVIRONMENT PLAN
FOR
SITE OPERATIONS
(SECTION-A)**

Doc. No.: HSEP:14-
ER
Rev.: 00
Date:25.04.19
Page 88 of 162

	Major Property Loss incident and HSE events			
6	Degree of PPE compliance, Fall protection arrangements and safety net coverage	8.3, 14	15	
7	Level of compliance w.r.t safety rules	13,14	25	
8	Availability of proper first-aid facility, ambulance, hygienic labor colony and other adequate labor welfare initiatives, conducting of health check-up as per BOCW requirements	8	6	
9	Conducting induction training, skill training, tool box meeting, mock-drills, HSE Promotion, Emergency Preparedness and Response. Participation in BHEL training also counted	9.0	6	
10	Level of House-keeping, Environmental Control	13.3, 13.5	10	
11	Level of general illumination	8.4.11	5	
A	TOTAL Obtained		100	

Penalty score:

- i. For each fatality: -10
- ii. For each Major Incident: -07

NET TOTAL score will be arrived after deducting penalty score from Total score.

Subcontractor shall make available all data required for evaluation to BHEL as and when demanded.

1. If safety record of the subcontractor in execution of the awarded job is to the satisfaction of safety department of BHEL, issue of an appropriate certificate to recognize the safety performance of the subcontractor may be considered by BHEL after completion of the job.
2. 1.5% of running bill shall be cleared subject to certification of desired safety performance by BHEL

16 HSE PENALTIES FOR NON-COMPLIANCE

1. Nonconformity of safety rules and safety appliances will be viewed seriously and BHEL has right to impose fines on the subcontractor for every instance of violation noticed.
2. The applicable penalties for HSE violations are given in Format No. HSEP14-F14 of this document



POWER
SECTOR

HEALTH, SAFETY AND ENVIRONMENT PLAN
FOR
SITE OPERATIONS
(SECTION-A)

Doc. No.: HSEP:14-
ER
Rev.: 00
Date:25.04.19
Page 89 of 162

3. The list of non-compliances given in above format is not exhaustive. The BHEL site in-charge has liberty to impose a penalty for any other non-compliance and incidents of any nature.
4. If principal customer or statutory and regulatory bodies impose penalty on ground of statutory non-compliance or non-compliance of HSE rules by the subcontractor or any incident of any nature including fatality or permanent disability, the same shall be passed on to the subcontractor with appropriate overhead
5. The penalty amount shall be recovered from subcontractors from the RA Bill, otherwise Final bill.

17 COMPENSATION TO ACCIDENT VICTIMS

1. BHEL shall recover the amount of compensation paid to victim(s) by BHEL towards loss of life / permanent disability due to an accident which is attributable to the negligence of contractor, agency or firm or any of its employees as detailed below.
 - b. **Victim:** Any person who suffers permanent disablement or dies in an accident as defined below.
 - c. **Accident:** Any death or permanent disability resulting solely and directly from any unintended and unforeseen injurious occurrence caused during the manufacturing/ operation and works incidental thereto at BHEL factories/ offices and precincts thereof, project execution, erection and commissioning, services, repairs and maintenance, trouble shooting, serving, overhaul, renovation and retrofitting, trial operation, performance guarantee testing undertaken by the company or during any works / during working at BHEL Units/ Offices/ townships and premises! Project Sites.
 - d. **Compensation in respect of each of the victims:**
 - i. In the event of death or permanent disability resulting from Loss of both limbs: Rs. 10,00,000/- (Rs. Ten Lakh)
 - ii. (ii) In the event of other permanent disability: Rs. 7,00,0001- (Rs. Seven Lakh)
 - e. **Permanent Disability:** A disablement that is classified as a permanent total disablement under the proviso to Section 2 (I) of the Employee's Compensation Act, 1923. "
2. In addition to above, contractor shall provide appropriate compensation to victims of major and fatal incidents as per Employee Compensation Act, 1923, ESIC Act, 1948 or as per any existing Acts and guidelines

 POWER SECTOR	HEALTH, SAFETY AND ENVIRONMENT PLAN FOR SITE OPERATIONS (SECTION-A)	Doc. No.: HSEP:14-ER
		Rev.: 00
		Date:25.04.19
		Page 90 of 162

18 INTERNAL & EXTERNAL HSE AUDITS

1. Subcontractor shall extend full co-operation and maintain necessary documents & records as required by Internal & External HSE Audit carried out by BHEL. / Third Party
2. All non-conformities and observations on HSE shall be disposed of-by subcontractor in a time bound manner as detailed in Audit Report.
3. All required corrective actions shall be taken by the subcontractor in order to avoid recurrence

19 OTHER REQUIREMENTS

1. In case of any delay in completion of a job due to mishaps attributable to lapses by the subcontractor, BHEL shall have the right to recover cost of such delay from the payments due to the subcontractor, after holding an appropriate enquiry and notifying the subcontractor suitably.
2. **RISK & COST:**

If the subcontractor fails to improve the standards of safety in its operation to the satisfaction of BHEL after being given reasonable opportunity to do so and/or if the subcontractor fails to take appropriate safety precautions or to provide necessary safety devices and equipment or to carry out instruction regarding safety as per contractual requirements, BHEL shall have the right to take corrective steps at the risk and cost of the subcontractor after giving a notice of not less than 7 days indicating the steps that would be taken by BHEL.
3. If the subcontractor succeeds in carrying out its job in time without any fatal or disabling injury incident and without any damage to property BHEL may, at its sole discretion, favourably consider to reward the subcontractor suitably for the performance.
4. The subcontractor shall take all measures at all the sites of work to protect all persons from incidents and shall be bound to bear the expenses of every suit, action or other proceeding of law that may be brought by any persons for injury sustained, death or damage to environment



POWER
SECTOR

HEALTH, SAFETY AND ENVIRONMENT PLAN
FOR
SITE OPERATIONS
(SECTION-A)

Doc. No.: HSEP:14-
ER

Rev.: 00

Date:25.04.19

Page 91 of 162

owing to neglect of the HSE precautions by the subcontractor; and shall be liable to pay any such persons such compensation, should such claim proceeding be filed against BHEL.

The subcontractor hereby agrees to indemnify BHEL against the same.

20 HSE REVIEW

BHEL shall hold HSE review meeting every month or as per requirement in order to discuss and resolve HSE issues of site and improve HSE performance. It will also discuss the incidents occurred since previous meeting, its root cause and Corrective action. The indicative agenda is given below:

1. Implementation of earlier MOM
2. HSE performance review
3. HSE inspection review w.r.t non-conformances observed and their status
4. HSE audit and CAPA
5. HSE training conducted and requirement
6. Health check-up camp
7. HSE planning for the erection and commissioning and installation activities in the coming month
8. HSE reward and promotional activities
9. HSE data analysis and improvement – Data analyzed will include non-conformances closed and pending, incident data, training data etc.

Subcontractor shall ensure presence of site in-charge, all package in-charges and safety officers, as communicated by BHEL in the meeting.

Subcontractor shall take requisite actions as per record notes and as decided in the meeting, in a time bound manner and submit compliance report to BHEL.

 POWER SECTOR	HEALTH, SAFETY AND ENVIRONMENT PLAN FOR SITE OPERATIONS (SECTION-A)	Doc. No.: HSEP:14-ER
		Rev.: 00
		Date:25.04.19
		Page 92 of 162

21 FORMATS USED

This is minimum list of Formats to be used for reporting by the subcontractor. Other Formats are indicated in respective HSE Procedures, Work Permits, OCPs or as specified by BHEL. The medium of reporting can be hard / soft as indicated by BHEL.

BHEL can modify these Formats or introduce new Formats to the extent necessary to get the desired performance data of all HSE activities.

SN	Format Name	Format No.	Frequency of check	Rev
1	Work at Height Permit	HSEP:14-FP01	Before start of work and regularly thereafter as per Permit conditions	00
2	Hot Work Permit	HSEP:14-FP02		00
3	Confined Space Work Permit	HSEP:14-FP03		00
4	Excavation Work Permit	HSEP:14-FP04		00
5	Radiation Work Permit	HSEP:14-FP05		00
6	Lifting Activity Work Permit	HSEP:14-FP06		00
7	Lockout-Tagout Work Permit	HSEP:14-FP07		00
8	Inspection of First Aid Box	HSEP:14-F01	Weekly	00
9	Health Check Up	HSEP:14-F02	With new Induction & as per requirement thereafter	00
10	HSE Induction / Regular / On-the-Job Training	HSEP:14-F03	With new Induction & as per requirement thereafter	00
11	Tool Box Talk	HSEP:14-F04	Daily before job start	00
12	Site HSE Report	HSEP:14-F05	Monthly	00
13	PPE Inspection	HSEP:14-F06	Weekly	00
14	PPE Issue and Receipt	HSEP:14-F06A	With new Induction	
15	Inspection of T&Ps (General)	HSEP:14-F07	Monthly / As per requirement	00
16	Inspection of Cranes	HSEP:14-F08	Monthly / As per requirement	00
17	Inspection of Winches	HSEP:14-F09	Monthly / As per requirement	00
18	Inspection of Height Working	HSEP:14-F10	Daily / As per requirement	00
19	Inspection on Welding & Gas Cutting	HSEP:14-F11	Weekly / As per requirement	00
20	Inspection on Electrical Installation	HSEP:14-F12	Weekly / As per requirement	00
21	Inspection on Elevator	HSEP:14-F13	Weekly / As per requirement	00
22	HSE Penalty	HSEP:14-F14	-	00
23	Initial Verification of PPE's & Lifting Tools & Tackles	HSEP:14-F15	As and when new PPEs and T&Ps are received	00
24	Inspection of Labor Colony	HSEP:14-F16	Monthly / as per requirement	00
25	Recording of First Aid Injuries	HSEP:14-F17	As and when such injuries occur	00
26	E-waste Handled / Generated	HSEP:14-F18	Half Yearly	00
27	Hazardous Waste at the Facility	HSEP:14-F19	Half Yearly	00
28	HSE Checklist-cum-Compliance Report	HSEP:14-F20	As per Audit Calendar	00
29	Illumination Levels	HSEP:14-F21	Weekly / As per requirement	00
30	Incident Reporting	HSEP:14-F22	-	00
31	Incident Recording	HSEP:14-F23	-	00



HSEP:14-FP01

WORK AT HEIGHTS PERMIT C1971:19		Permit No. & Date
Project & Unit:		Emergency Contact Nos:
BHEL Sub-contractor:		

Exact Location of Work: _____

Nature / Description of Work: _____

Duration of Work Execution *: From Date: _____ to Date: _____ Daily from _____ hrs. to _____ hrs.

Name of Sub-Contractor Performing the Work: _____

Name of Sub-Contractor's Site Engineer (Permit Requesting Authority): _____ Sign: _____

Name of Sub-Contractor's Package In-charge: _____ Sign: _____ Date: _____

The above described work will be done under all the safety precautions mentioned as under during the currency of the Permit.

No.	Item	Yes	Not required / Remarks
1	All workers on job are competent and medically fit (No Height Phobia) for working at height		
2	Hazards in the vicinity are identified, controlled and communicated to the worker.		
3	Scaffolding soundness inspected is available for use with valid tag		
4	Work platform is not made of bamboo or weak material. Barricading is available with Top, Mid Rails and Toe Guard.		
5	Working platform is clean without any unwanted material. Floor openings are covered.		
6	Access and exit to workplace are safe, marked and without obstruction.		
7	Adequate lighting provided (for dark hours) as per applicable lux standards (Refer HSEP:13)		
8	Safety nets are provided below working area.		
9	Area below the working platform has been cleared of all activity		
10	Ladders have been secured, inspected and provided as per BHEL standard/contract.		
11	Horizontal life lines are provided to cater to design specification of 2300 kg per person.		
12	Safety harness with life line support/ fall arrester are checked and available in working condition		
13	Safety shoes (non-slip), Helmet with chin strip available with employees		
14	Visible Signboards provided on working platforms in workers' understandable language		
15	All lifting / tightening tools, hand tools/equipment checked and in good condition		
16	ELCB provided for Electrical connections individually. Electrical cable, welding Hose/Compressed air hose properly secured and laid down without obstruction. Earth resistance is OK.		
17	Crane / Winch / Hydra operator is qualified and experienced		
18	Emergency response team & Medical Facilities available. Work area is cordoned off.		
19	Job Safety Analysis Submitted		
20	Additional Permits to be taken (Please specify & attach):		

Declaration: All the points mentioned in the above checklist have been checked and found OK

Permit Receiver:

Site Engineer (Sub- Contractor):
Signature:
Name: Designation:

Site Safety Officer (Sub-Contractor):
Signature:
Name: Designation:

Permit Issuer:

Engineer of Concerned Execution Department (BHEL):
Signature:
Name: Designation:

Site Safety Officer (BHEL):
Signature:
Name: Designation:

Package-in-charge (BHEL):
Signature:
Name: Designation:

Verified by Customer Representative (if applicable), Name: _____ Sign: _____ Date: _____ Time: _____

(* Permit valid for 7 days, subject to daily renewal, and extension as per overleaf instructions / record formats)

Daily Work Area Condition Endorsement

Sl. No.	Date	Signature with Date & Time		Remarks
		Agency Safety	BHEL Safety	
Day 2				
Day 3				
Day 4				
Day 5				
Day 6				
Day 7				

Permit Extension Beyond Initially Requested Hours

Sl. No.	Extension Period		Remarks	Signature with Date & Time			
	From..... (Date & Time)	To..... (Date & Time)		Agency Site Engineer	Agency Safety Officer	BHEL Site Engineer (PIA)	BHEL Safety Officer
1.							
2.							
3.							
4.							
5.							
6.							

TO BE SIGNED BY THE BHEL HSE & EXECUTION AFTER THE WORK IS OVER

Permit is here by returned after completing the job & ensuring safe removal of men and material.

Site Engineer, BHEL		Site HSE Engineer, BHEL	
Signature:		Signature:	
Name:		Name:	

General Instructions:

1	This Permit is required for working at height of 2 mtr. and above or above excavation of 2 mtr or deeper.
2	This permit must be available at the work site all the times of the work.
3	Location and description of the work must be clearly indicated by the permittee.
4	Terms applicable must be clearly indicated by the permittee.
5	This permit shall be endorsed each day only after checking all the compliance jointly by the contractor and BHEL safety.
6	Permit shall be issued for not more than 7 days including the issue date.
7	Permit shall be returned to the HSE Department of BHEL after completion of the job.
8	Before engaging anybody to work at height, height phobia needs to be ascertained and proper fitness certificate to be ensured.
9	All safety precautions to be taken as per work site HSE plan.
10	Distribution of copy:
	Original- Permittee, Duplicate –Department HOS, Contractor, Triplicate - Site HSE Dept.,



HSEP:14-FP02

TENDER WORKS PERMIT BAR-C1971:19		Permit No. & Date
Project & Unit:		Emergency Contact Nos:
BHEL Sub-contractor:		

Exact Location of Work: _____

Nature / Description of Work: _____

Duration of Work Execution *: From Date: _____ to Date: _____ Daily from _____ hrs. to _____ hrs.

Name of Sub-Contractor Performing the Work: _____

Name of Sub-Contractor's Site Engineer (Permit Requesting Authority): _____ Sign: _____

Name of Sub-Contractor's Package In-charge: _____ Sign: _____ Date: _____

The above described work will be done under all the safety precautions mentioned as under during the currency of the Permit.

No.	Item	Yes	Not required / Remarks
1.	Welder is trained and qualified with good attendance in on-the-job training		
2.	Area ensured safe and free from all hazards (explosives etc.) with barricading and safe inlet / exit		
3.	Proper ventilation and lighting provided (in case of dark hours).		
4.	Gas hoses are in good condition and not cut / leaking		
5.	Pressure gauges/Flash back arrestor (at both ends) provided and in working condition.		
6.	Gas pressure in cylinder is within limits and hydraulic test certificate is available		
7.	Gas cylinders are stacked vertically and not below the welding / cutting area. Regulator key is available with cylinder. Gas cylinders covered with shields to prevent falling splinters.		
8.	Power supply to welding machine is through ELCB of 30 mA rating, which is tested and found ok; Earthing is tested and found OK		
9.	Welding machine input/output cables, welding holder and weld return clamp (Holder) are insulated and in good condition.		
10.	In case of welding in enclosed / confined spaces, the integrity of the structure and supports are ensured, Gas Testing done and evacuation system ensured in place		
11.	Emergency STOP buttons are in working condition. Welder /Helper knows how to operate it.		
12.	Welder & Fitter trained to connect ground/work return clamps (Holder) to work place prior to energization of welding machine.		
13.	Personal Protective equipment Minimum applicable: safety helmet, safety goggles, welding helmet, safety (rubber) shoes, leather gloves, long sleeve and nose mask -provided		
14.	In case of pits, water removed from the pit and wood/rubber insulation provided.		
15.	Safety signboards / cautions are in place.		
16.	Adequate and Suitable nos. of applicable firefighting extinguisher provided.		
17.	Nearby combustible material removed. Housekeeping done.		
18.	All workers explained about the hazards		
19.	First aid in attendance.		
20.	Any other Precautions or Permits required (Height Work, Confined Space etc.), give details and attach		

Declaration: All the points mentioned in the above checklist have been checked and found OK

Permit Receiver:

Site Engineer (Sub- Contractor):
Signature:
Name: _____ Designation: _____

Site Safety Officer (Sub-Contractor):
Signature:
Name: _____ Designation: _____

Permit Issuer:

Engineer of Concerned Execution Department (BHEL):
Signature:
Name: _____ Designation: _____

Site Safety Officer (BHEL):
Signature:
Name: _____ Designation: _____

Package-in-charge (BHEL):
Signature:
Name: _____ Designation: _____

Verified by Customer Representative (if applicable), Name: _____ Sign: _____ Date: _____ Time: _____

(* Permit valid for 7 days, subject to daily renewal, and extension as per overleaf instructions / record formats)

Daily Work Area Condition Endorsement

Sl. No.	Date	Signature with Date & Time		Remarks
		Agency Safety	BHEL Safety	
Day 2				
Day 3				
Day 4				
Day 5				
Day 6				
Day 7				

Permit Extension Beyond Initially Requested Hours

Sl. No.	Extension Period		Remarks	Signature with Date & Time			
	From..... (Date & Time)	To..... (Date & Time)		Agency Site Engineer	Agency Safety Officer	BHEL Site Engineer (PIA)	BHEL Safety Officer
1.							
2.							
3.							
4.							
5.							
6.							

TO BE SIGNED BY THE BHEL HSE & EXECUTION AFTER THE WORK IS OVER

Permit is here by returned after completing the job & ensuring safe removal of men and material.

Site Engineer, BHEL		Site HSE Engineer, BHEL	
Signature:		Signature:	
Name:		Name:	

General Instructions:

1	This Permit is required for all kinds of Hot Work eg. Welding, cutting etc..
2	This permit must be available at the work site all the times of the work.
3	Location and description of the work must be clearly indicated by the permittee.
4	Terms applicable must be clearly indicated by the permittee.
5	This permit shall be endorsed each day only after checking all the compliance jointly by the contractor and BHEL safety.
6	Permit shall be issued for not more than 7 days including the issue date.
7	Permit shall be returned to the HSE Department of BHEL after completion of the job.
8	Before engaging anybody to work, competency and fitness to be ensured.
9	All safety precautions to be taken as per work site HSE plan.
10	Distribution of copy:
	Original- Permittee, Duplicate –Department HOS, Contractor, Triplicate - Site HSE Dept.,



HSEP:14-FP03

CONFINED SPACE WORK PERMIT 71:19		Permit No. & Date
Project & Unit:		Emergency Contact Nos:
BHEL Sub-contractor:		

Exact Location of Work: _____

Nature / Description of Work: _____

Duration of Work Execution *: From Date: _____ to Date: _____ Daily from _____ hrs. to _____ hrs.

Name of Sub-Contractor Performing the Work: _____

Name of Sub-Contractor's Site Engineer (Permit Requesting Authority): _____ Sign: _____

Name of Sub-Contractor's Package In-charge: _____ Sign: _____ Date: _____

The above described work will be done under all the safety precautions mentioned as under during the currency of the Permit.

No.	Item	Yes	Not required / Remarks
1.	Has the equipment been Isolated from Power/Steam/Air?		
2.	Has the equipment been Isolated from liquid or gases?		
3.	Has the equipment been de-pressurized &/or drained?		
4.	Has the equipment been Blanked/blinded or disconnected?		
5.	Has the equipment been water flushed &/or steamed?		
6.	Whether man ways open and ventilated?		
7.	Whether constant Inert gas flow arranged?		
8.	Whether mechanically ventilated and adequately cooled?		
9.	Whether 24 V lighting provided inside the confined space?		
10.	Whether Radiation sources removed?		
11.	Whether training on confined space provided to the individual / group?		
12.	Whether required PPEs (hand gloves, goggles, face shield, ear plug/muff, protective clothing etc.) used?		
13.	Whether Safety harness and Lifeline used?		
14.	Whether Dust/Gas/Air Line mask used?		
15.	Whether attendant with SCBA/Air mask available?		
16.	Whether grounded air Exhaust/Blower/ AC provided?		
17.	Whether Personal Gas alarm provided?		
18.	Whether communication Equipment Provided?		
19.	Whether rescue equipment/team available?		
20.	Whether firefighting arrangement done		
21.	Any other Precautions or Permits required (Height Work, Confined Space etc.), give details and attach		

Declaration: All the points mentioned in the above checklist have been checked and found OK

Permit Receiver:

Site Engineer (Sub- Contractor):
Signature:
Name: _____ Designation: _____

Site Safety Officer (Sub-Contractor):
Signature:
Name: _____ Designation: _____

Permit Issuer:

Engineer of Concerned Execution Department (BHEL):
Signature:
Name: _____ Designation: _____

Site Safety Officer (BHEL):
Signature:
Name: _____ Designation: _____

Package-in-charge (BHEL):
Signature:
Name: _____ Designation: _____

Verified by Customer Representative (if applicable), Name: _____ Sign: _____ Date: _____ Time: _____

(* Permit valid for 7 days, subject to daily renewal, and extension as per overleaf instructions / record formats)

Daily Work Area Condition Endorsement

Sl. No.	Date	Signature with Date & Time		Remarks
		Agency Safety	BHEL Safety	
Day 2				
Day 3				
Day 4				
Day 5				
Day 6				
Day 7				

Permit Extension Beyond Initially Requested Hours

Sl. No.	Extension Period		Remarks	Signature with Date & Time			
	From..... (Date & Time)	To..... (Date & Time)		Agency Site Engineer	Agency Safety Officer	BHEL Site Engineer (PIA)	BHEL Safety Officer
1.							
2.							
3.							
4.							
5.							
6.							

TO BE SIGNED BY THE BHEL HSE & EXECUTION AFTER THE WORK IS OVER

Permit is here by returned after completing the job & ensuring safe removal of men and material.

Site Engineer, BHEL		Site HSE Engineer, BHEL	
Signature:		Signature:	
Name:		Name:	

General Instructions:

1	This Permit is required for all confined space tasks, where injury can happen due to lack of oxygen, or chances of fire are there due to gas accumulation.
2	This permit must be available at the work site all the times of the work.
3	Location and description of the work must be clearly indicated by the permittee.
4	Terms applicable must be clearly indicated by the permittee.
5	This permit shall be endorsed each day after checking all the compliance jointly by the contractor and BHEL safety.
6	Permit shall be issued for not more than 7 days including the issue date.
7	Permit shall be returned to the HSE Department of BHEL after completion of the job.
8	Before engaging anybody to work, competency and fitness to be ensured.
9	All safety precautions to be taken as per work site HSE plan.
10	Distribution of copy:
	Original- Permittee, Duplicate –Department HOS, Contractor, Triplicate - Site HSE Dept.,



HSEP:14-FP04

EXTENSION PERMIT 1971:19		Permit No. & Date
Project & Unit:		Emergency Contact Nos:
BHEL Sub-contractor:		

Exact Location of Work: _____

Nature / Description of Work: _____

Duration of Work Execution *: From Date: _____ to Date: _____ Daily from _____ hrs. to _____ hrs.

Name of Sub-Contractor Performing the Work: _____

Name of Sub-Contractor's Site Engineer (Permit Requesting Authority): _____ Sign: _____

Name of Sub-Contractor's Package In-charge: _____ Sign: _____ Date: _____

The above described work will be done under all the safety precautions mentioned as under during the currency of the Permit.

No.	Item	Yes	Not required / Remarks
1	Precautions taken for Underground Electrical Cable		
2	Precautions taken for Under / Above ground sewer/Drinking Water Line		
3	Precautions taken for Underground Telecommunication Line		
4	Precautions taken for Underground Product/Utility Line		
5	Precautions taken for Underground Fire Water Line		
6	Shoring / Shuttering / Sheet piling done to prevent collapse of excavation walls. Strength of Excavation wall ensured at all times		
7	Hard Barricading & Edge Protection provided		
8	Separate Safe Access for Man and Vehicle		
9	Lighting arrangement		
10	Banks Man Provided		
11	Required basic PPEs provided		
12	Slope Cutting/Benching Maintained		
13	Excavated soil / Construction Material / equipment kept away from the edge.		
14	First aid in attendance.		
15	Any other Precautions or Permits required (Height Work, Confined Space etc.), give details and attach		

Declaration: All the points mentioned in the above checklist have been checked and found OK

Permit Receiver:

Site Engineer (Sub- Contractor):
Signature:
Name: _____ Designation: _____

Site Safety Officer (Sub-Contractor):
Signature:
Name: _____ Designation: _____

Permit Issuer:

Engineer of Concerned Execution Department (BHEL):
Signature:
Name: _____ Designation: _____

Site Safety Officer (BHEL):
Signature:
Name: _____ Designation: _____

Package-in-charge (BHEL):
Signature:
Name: _____ Designation: _____

Verified by Customer Representative (if applicable), Name: _____ Sign: _____ Date: _____ Time: _____

(* Permit valid for 7 days, subject to daily renewal, and extension as per overleaf instructions / record formats)

Daily Work Area Condition Endorsement

Sl. No.	Date	Signature with Date & Time		Remarks
		Agency Safety	BHEL Safety	
Day 2				
Day 3				
Day 4				
Day 5				
Day 6				
Day 7				

Permit Extension Beyond Initially Requested Hours

Sl. No.	Extension Period		Remarks	Signature with Date & Time			
	From..... (Date & Time)	To..... (Date & Time)		Agency Site Engineer	Agency Safety Officer	BHEL Site Engineer (PIA)	BHEL Safety Officer
1.							
2.							
3.							
4.							
5.							
6							

TO BE SIGNED BY THE BHEL HSE & EXECUTION AFTER THE WORK IS OVER

Permit is here by returned after completing the job & ensuring safe removal of men and material.

Site Engineer, BHEL		Site HSE Engineer, BHEL	
Signature:		Signature:	
Name:		Name:	

General Instructions:

1	This Permit is required for all excavation tasks 1.22 mtr or deeper
2	This permit must be available at the work site all the times of the work.
3	Location and description of the work must be clearly indicated by the permittee.
4	Terms applicable must be clearly indicated by the permittee.
5	This permit shall be endorsed each day after checking all the compliance jointly by the contractor and BHEL safety.
6	Permit shall be issued for not more than 7 days including the issue date.
7	Permit shall be returned to the HSE Department of BHEL after completion of the job.
8	Before engaging anybody to work, competency and fitness to be ensured.
9	All safety precautions to be taken as per work site HSE plan.
10	Distribution of copy:
	Original- Permittee, Duplicate –Department HOS, Contractor, Triplicate - Site HSE Dept.,



HSEP:14-FP05

RADIATION WORKS PERMIT (RT) 1971:19		Permit No. & Date
Project & Unit:		Emergency Contact Nos:
BHEL Sub-contractor:		

Exact Location of Work: _____

Nature / Description of Work: _____

Duration of Work Execution *: From Date: _____ to Date: _____ Daily from _____ hrs. to _____ hrs.

Name of Sub-Contractor Performing the Work: _____

Name of Sub-Contractor's Site Engineer (Permit Requesting Authority): _____ Sign: _____

Name of Sub-Contractor's Package In-charge: _____ Sign: _____ Date: _____

The above described work will be done under all the safety precautions mentioned as under during the currency of the Permit.

No.	Item	Yes	Not required / Remarks
1.	All the persons at the site informed/removed from the area.		
2.	Area around the source of radiation cordoned off with the rope/chord.		
3.	Radiation warning symbol/boards displayed around radiography work on rope/chord.		
4.	Radiographer worn radiation badges during testing and is within safe limits.		
5.	Radiography camera and carrying case box having radiation symbol.		
6.	Radiation Survey Meter is in working condition, calibrated & within validity period.		
7.	Radiographer has valid certificate from BARC.		
8.	Blinking light provided on road during radiography (in dark hours).		
9.	Proper required Illumination provided		
10.	Safe access and working platform provided to conduct RT work		
11.	All the persons involved in Radiography work are aware of the hazard of radiation		
12.	Any other Precautions or Permits required (Height Work, Confined Space etc.), give details and attach		

Declaration: All the points mentioned in the above checklist have been checked and found OK

Permit Receiver:

Site Engineer (Sub- Contractor):	Site Safety Officer (Sub-Contractor):
Signature:	Signature:
Name: Designation:	Name: Designation:

Permit Issuer:

Engineer of Concerned Execution Department (BHEL):	Site Safety Officer (BHEL):
Signature:	Signature:
Name: Designation:	Name: Designation:
Package-in-charge (BHEL):	
Signature:	
Name: Designation:	

Verified by Customer Representative (if applicable), Name: _____ Sign: _____ Date: _____ Time: _____

(* Permit valid for 7 days, subject to daily renewal, and extension as per overleaf instructions / record formats)

Daily Work Area Condition Endorsement

Sl. No.	Date	Signature with Date & Time		Remarks
		Agency Safety	BHEL Safety	
Day 2				
Day 3				
Day 4				
Day 5				
Day 6				
Day 7				

Permit Extension Beyond Initially Requested Hours

Sl. No.	Extension Period		Remarks	Signature with Date & Time			
	From..... (Date & Time)	To..... (Date & Time)		Agency Site Engineer	Agency Safety Officer	BHEL Site Engineer (PIA)	BHEL Safety Officer
1.							
2.							
3.							
4.							
5.							
6							

TO BE SIGNED BY THE BHEL HSE & EXECUTION AFTER THE WORK IS OVER

Permit is here by returned after completing the job & ensuring safe removal of men and material.

Site Engineer, BHEL		Site HSE Engineer, BHEL	
Signature:		Signature:	
Name:		Name:	

General Instructions:

1	This Permit is required for all activities in which there is danger of exposure to harmful radiation
2	This permit must be available at the work site all the times of the work.
3	Location and description of the work must be clearly indicated by the permittee.
4	Terms applicable must be clearly indicated by the permittee.
5	This permit shall be endorsed each day after checking all the compliance jointly by the contractor and BHEL safety.
6	Permit shall be issued for not more than 7 days including the issue date.
7	Permit shall be returned to the HSE Department of BHEL after completion of the job.
8	Before engaging anybody to work, competency and fitness to be ensured.
9	All safety precautions to be taken as per work site HSE plan.
10	Distribution of copy:
	Original- Permittee, Duplicate –Department HOS, Contractor, Triplicate - Site HSE Dept.,



HSEP:14-FP06

LIFTING PERMIT FOR WORK		Permit No. & Date
Project & Unit:		Emergency Contact Nos:
BHEL Sub-contractor:		

Exact Location of Work: _____

Nature / Description of Work: _____

Duration of Work Execution *: From Date: _____ to Date: _____ Daily from _____ hrs. to _____ hrs.

Name of Sub-Contractor Performing the Work: _____

Name of Sub-Contractor's Site Engineer (Permit Requesting Authority): _____ Sign: _____

Name of Sub-Contractor's Package In-charge: _____ Sign: _____ Date: _____

The above described work will be done under all the safety precautions mentioned as under during the currency of the Permit.

No.	Item	Yes	Not required / Remarks
1.	Crane used for lifting activity TPI tested, certified and approved for rated lifting		
2.	All lifting tackles, gears/appliances are tested and certified for lifting works.		
3.	Crane operator is trained and competent for lifting operation.		
4.	Lifting sling/ belt is protected against sharp edge of the jobs to be lifted.		
5.	Lifting hook is properly latched to prevent material falling over		
6.	Access and exit marked and without obstruction.		
7.	In case of lifting multiple materials at once, same are tied up with strong rope / material		
8.	Area below lifting activity barricaded to prevent movement		
9.	Minimum 2 guidelines have been provided for balancing and guiding jobs to be lifted.		
10.	Periphery area of crane booms as well as lifting job is barricaded and unauthorized/no-entry sign board posted.		
11.	Rigger and signal man is trained and competent for lifting work. Signal is clearly visible to the operator and understood		
12.	No lifting activity to be carried out during lightening, heavy wind/rain. No forecast of these conditions during work period		
13.	If scaffolding to be used during lift, scaffolding with valid tag available for use.		
14.	Add drawing /procedure etc. relevant for the lifting.		
15.	Any other Precautions or Permits required (Height Work, Confined Space etc.), give details and attach		

Declaration: All the points mentioned in the above checklist have been checked and found OK

Permit Receiver:

Site Engineer (Sub- Contractor):	Site Safety Officer (Sub-Contractor):
Signature: _____	Signature: _____
Name: _____ Designation: _____	Name: _____ Designation: _____

Permit Issuer:

Engineer of Concerned Execution Department (BHEL):	Site Safety Officer (BHEL):
Signature: _____	Signature: _____
Name: _____ Designation: _____	Name: _____ Designation: _____
Package-in-charge (BHEL):	
Signature: _____	
Name: _____ Designation: _____	

Verified by Customer Representative (if applicable), Name: _____ Sign: _____ Date: _____ Time: _____

(* Permit valid for 7 days, subject to daily renewal, and extension as per overleaf instructions / record formats)

Daily Work Area Condition Endorsement

Sl. No.	Date	Signature with Date & Time		Remarks
		Agency Safety	BHEL Safety	
Day 2				
Day 3				
Day 4				
Day 5				
Day 6				
Day 7				

Permit Extension Beyond Initially Requested Hours

Sl. No.	Extension Period		Remarks	Signature with Date & Time			
	From..... (Date & Time)	To..... (Date & Time)		Agency Site Engineer	Agency Safety Officer	BHEL Site Engineer (PIA)	BHEL Safety Officer
1.							
2.							
3.							
4.							
5.							
6.							

TO BE SIGNED BY THE BHEL HSE & EXECUTION AFTER THE WORK IS OVER

Permit is here by returned after completing the job & ensuring safe removal of men and material.

Site Engineer, BHEL		Site HSE Engineer, BHEL	
Signature:		Signature:	
Name:		Name:	

General Instructions:

1	This Permit is required for all Heavy Lifting Activities that are either / all of the following: 1. Above 50 Tons; 2. Tandem Lifting; 3. Total Load exceeding 75% of capacity of crane; 4. Lift of unusual difficulty or geometry or rigging; 5. Lift over operating Units; 6. Any other Lift as decided by Site HSE / Erection
2	Job Safety Analysis (JSA) to be created for every Lift above 5 Tons.
3	This permit must be available at the work site all the times of the work.
4	Location and description of the work, and terms applicable must be clearly indicated by the permittee.
5	This permit shall be endorsed each day after checking all the compliance jointly by the contractor and BHEL safety.
6	Permit shall be issued for not more than 7 days including the issue date.
7	Permit shall be returned to the HSE Department of BHEL after completion of the job.
8	Before engaging anybody to work, competency and fitness to be ensured.
9	All safety precautions to be taken as per work site HSE plan.
10	Distribution of copy: Original- Permittee, Duplicate –Department HOS, Contractor, Triplicate - Site HSE Dept.



HSEP:14-FP07

LOCKOUT/TAGOUT (LIVE ELECTRICAL MAINTENANCE) WORK PERMIT		Permit No. & Date
Project & Unit:		Emergency Contact Nos:
BHEL Sub-contractor:		

Exact Location of Work: _____

Nature / Description of Work: _____

Duration of Work Execution *: From Date: _____ to Date: _____ Daily from _____ hrs. to _____ hrs.

Name of Sub-Contractor Performing the Work: _____

Name of Sub-Contractor's Site Engineer (Permit Requesting Authority): _____ Sign: _____

Name of Sub-Contractor's Package In-charge: _____ Sign: _____ Date: _____

The above described work will be done under all the safety precautions mentioned as under during the currency of the Permit.

Tag No.	Device to be Tagged / Locked I.D. No.	Device Location	Device Position OPEN / CLOSED - ON/OFF	Lock No.	Tag Lock		Tag / Lock	
					Placed by Name/Sign - Date/Time	Removed by Name/Sign - Date/Time		

Declaration: All the points mentioned in the above checklist have been checked and found OK

Permit Receiver:

Site Engineer (Sub- Contractor):	Site Safety Officer (Sub-Contractor):
Signature:	Signature:
Name: Designation:	Name: Designation:

Permit Issuer:

Engineer of Concerned Execution Department (BHEL):	Site Safety Officer (BHEL):
Signature:	Signature:
Name: Designation:	Name: Designation:
Package-in-charge (BHEL):	
Signature:	
Name: Designation:	

Verified by Customer Representative (if applicable), Name: _____ Sign: _____ Date: _____ Time: _____

(* Permit valid for 7 days, subject to daily renewal, and extension as per overleaf instructions / record formats)

Daily Work Area Condition Endorsement

Sl. No.	Date	Signature with Date & Time		Remarks
		Agency Safety	BHEL Safety	
Day 2				
Day 3				
Day 4				
Day 5				
Day 6				
Day 7				

Permit Extension Beyond Initially Requested Hours

Sl. No.	Extension Period		Remarks	Signature with Date & Time			
	From..... (Date & Time)	To..... (Date & Time)		Agency Site Engineer	Agency Safety Officer	BHEL Site Engineer (PIA)	BHEL Safety Officer
1.							
2.							
3.							
4.							
5.							
6							

TO BE SIGNED BY THE BHEL HSE & EXECUTION AFTER THE WORK IS OVER

Permit is here by returned after completing the job & ensuring safe removal of men and material.

Site Engineer, BHEL		Site HSE Engineer, BHEL	
Signature:		Signature:	
Name:		Name:	

General Instructions:

1	This Permit is required for all maintenance and erection activities with danger of electrocution from Live Electric Power
2	This permit must be available at the work site all the times of the work.
3	Location and description of the work, and terms applicable must be clearly indicated by the permittee.
4	This permit shall be endorsed each day after checking all the compliance jointly by the contractor and BHEL safety.
5	Permit shall be issued for not more than 7 days including the issue date.
6	Permit shall be returned to the HSE Department of BHEL after completion of the job.
7	Before engaging anybody to work, competency and fitness to be ensured.
8	All safety precautions to be taken as per work site HSE plan.
9	Distribution of copy: Original- Permittee, Duplicate –Department HOS, Contractor, Triplicate - Site HSE Dept.



POWER SECTOR

Inspection of First Aid Box

FORMAT NO: HSEP:14-F01

REV NO.: 00

PAGE NO. 01 OF 02

Name of Site :	
Name of Sub-Contractor:	
Inspected by :	
Date of Inspection:	

Number of employees in the site: - _____

Sl. No.	Item	No. Available	Remarks
1	No. of small sterilized dressings		
2	No of medium sized sterilized dressings		
3	No of large sized sterilized dressings.		
4	No of large sized sterilized burn dressings		
5	No of (15 grams) packets sterilized cotton wool		
6	No of pieces of sterilized eye pads in separate sealed packets.		
7	No of roller bandages 10 cm wide.		
8	No of roller bandages 5 cm wide.		
9	Whether tourniquet available		
10	Whether supply of suitable splints available.		
11	No of packets of safety pins.		
12	Whether kidney tray available		
13	Whether sufficient number of eye wash bottles, filled with distilled water or suitable liquid, clearly indicated by a distinctive sign which shall be visible at all times, available.		
14	Whether 4%-xylocaine eye drops, and boric acid eye drops and soda by carbonate eye drops available.		
15	Whether (60ml) bottle containing a two percent alcoholic solution of iodine available		
16	Whether (two hundred ml) bottle of mercurochrome (2 per cent) solution in water available.		
17	Whether 120ml bottle containing Sal volatile having the dose and mode of administration indicated on the label,		
18	Whether roll of adhesive plaster (6 cm X 1 meter) available		



POWER SECTOR

Inspection of First Aid Box

FORMAT NO: HSEP:14-F01

REV NO.: 00

PAGE NO. 01 OF 02

Sl. No.	Item	No. Available	Remarks
19	No of rolls of adhesive plaster (2 cm X 1 meter)		
20	Whether snake bite lancet available.		
21	Whether (30 grams) bottle of potassium permanganate crystals available.		
22	Whether a pair scissors available		
23	Whether copy of the First-Aid leaflet issued by the Director-General, Factory Advice service and labor Institutes, Government of India available.		
24	Whether bottle containing 100 tablets (each of 5 grains) of aspirin available		
25	Whether Ointment for burns available		
26	Whether bottle of a suitable surgical anti-septic solution available		
27	Whether List of Contents pasted on First Aid Box along with respective expiry dates		

Signature of Subcontractor's Site I/C

Date:



POWER SECTOR

FORMAT NO: HSEP:14-F02

REV NO.: 00

PAGE NO. 01 OF 02

Health Check-Up

Name of Site :	
Name of Sub-Contractor:	
Name of Employee :	
Age:	

History Of Past Illness	H/O Epilepsy:	
	H/O Drug Allergy:	
	H/O Diabetics/ Hypertension:	
	H/O Unconsciousness:	
Personal History		

EXAMINATION		OBSERVATION	
General Physical Examination			
Height			
Weight			
BMI			
Built And nourishment			
Pallor			
Temperature			
Chest Expansion	Inspiration	Expansion	
Lymph Node Enlargement			
Upper Limbs Strength & Function			
Lower Limbs Strength & function			
Spine Adequately flexible for the job concerned (Yes/No)			
Mental alertness and stability with good eye, hand and foot co-ordination.			
Ear, Nose, Throat			
Ear / Hearing			
Nose			
Throat			
Vision			
	Left Eye	Right Eye	



POWER SECTOR

Health Check-Up

FORMAT NO: HSEP:14-F02

REV NO.: 00

PAGE NO. 02 OF 02

EXAMINATION		OBSERVATION	
<u>Cardiovascular System Examination</u>			
Inspection			
Palpation	Pulse	BP	
Auscultation (Heart Sounds)			
<u>Respiratory System</u>			
Inspection	Respiratory Rate		
Palpation:			
Percussion			
Auscultation (Breath Sounds)			
<u>Examination of Abdomen</u>			
Inspection			
Palpation			
Auscultation (Bowel Sounds)			
Any Other			
Clinical Impression			

Signature of the examining doctor

Date:

	POWER SECTOR	FORMAT NO: HSEP:14-F05
	Monthly Site HSE Report	REV NO.: 00 Page 01 of 6

Name of subcontractor:	Report Month:

A) Accidents/Incidents Details: -

a	Lost time in Accidents	No. of incidents	Man Hours Lost	No. of People Involved	No. of person reported to Govt.	
	For the Month					
	Cumulative					
b	Minor Injuries					
	For the Month					
	Cumulative					
c	Fires	No. of Near-Misses	No. of First- Aid cases	No. of persons injured	No. of equipment damaged	No. of Fire reported Outside
	For the Month					
	Cumulative					
d	Other mishaps not covered in a, b, c.	No. of Near-Misses	No. of First- Aid cases	No. of persons injured	No. of equipment damaged	Total near misses and First-Aid
	For the Month					
	Cumulative					

B) Data for Man-hours worked:

Details	Value	Remarks if any
No. of people		
Man Hours worked		
O.T. Hours		
Total Man Hours		
Grand Total of man hours worked during the month(A+B)		
Cumulative man-hours (from _____ to _____): (Since commencing of operations)		

Signature of Subcontractor Site In-charge

Signature of Subcontractor HSE Officer



POWER SECTOR

Monthly Site HSE Report

FORMAT NO: HSEP:14-F05

REV NO.: 00

Page 02 of 6

C) Status of Deployment of Work force, Safety Officers/Supervisors & Construction Medical Officer(s) & Electricians:

Description	Name	Qualification & Experience
Safety Officers		
Safety Supervisors		
Construction Medical Officer		
Nursing Staff.		
Electricians		
Scaffolding Inspectors		
T&P Inspectors		

D) Status of deployment of manpower for critical HSE activities:

(All height work and other hazardous activities to be actively supervised by trained personnel. Area to be divided in manageable sections to ensure effective supervision at all times. For example, multiple elevations in a structure can be divided among multiple supervisors)

Activity	Location	Shift Timings	Personnel deployed	Remarks
Height Work	Boiler Unit- (Level 1-3)			
	Boiler Unit- (Level 4-6)			
	ESP			
Housekeeping	Boiler Unit-			
	ESP Unit			
Others				

Signature of Subcontractor Site In-charge

Signature of Subcontractor HSE Officer

	POWER SECTOR	FORMAT NO: HSEP:14-F05
	Monthly Site HSE Report	REV NO.: 00 Page 03 of 6

E) Lifting Tools, Tackles, Equipment and Pressure Vessels:

Item	Nos. Deployed	Nos. Tested by competent person	Identification Nos. (Comma separated) (A)	Validities of Test Certificates (Comma separated – corresponding to column A)	Whether internal testing using Color Coding or similar system done
Winches					
Chain Blocks					
Wire Rope Slings					
Man Cages					
D-Shackles					
Air Compressors					
Crawler Cranes					
Mobile Cranes					
Hydra Cranes					
Hydraulic Jack					
Others					

F) Reverse Horns in Construction Vehicles:

Item	Nos. Deployed with serial numbers (Comma separated) (A)	Nos. Having Functional reverse horns	Inspection Dates (Comma separated corresponding to column A)
Transit Mixers			
Hydra Cranes			
Dumpers/Trippers			
Backhoes			
Other Vehicles			

G) ELCBs:

No. Of ELCBs provided with Serial Nos. (Comma separated) (A)	Nos. Functional	When They were last Tested (Comma separated corresponding to column A)

H) Electrical Earthing:

No. Of Earth resources with serial numbers and locations (Comma separated) (A)	Whether Double Earthing provided to all equipment	When they were last tested (Comma separated corresponding to column A)

Signature of Subcontractor Site In-charge

Signature of Subcontractor HSE Officer

	POWER SECTOR	FORMAT NO: HSEP:14-F05
	Monthly Site HSE Report	REV NO.: 00 Page 04 of 6

I) Fire Extinguishers

Name & designation of person responsible for maintenance of Extinguishers at different locations :(Individual subcontractor's Safety Officers).

A. FIRE EXTINGUISHERS AT ERECTION SITE:

Type (Add more rows if required)	Sizes	Qty + Serial numbers (Comma separated) (A)	Healthiness – Last checked dates (Comma separated corresponding to column A)	Locations (Comma separated corresponding to column A)
FOAM TYPE				
SODA TYPE				
DRY TYPE (DCP)				
CO2 TYPE				

B. FIRE EXTINGUISHERS AT SITE OFFICES & STORES:

Type	Size (Add more rows if required)	Qty + Serial numbers (Comma separated) (A)	Healthiness – Last checked dates (Comma separated corresponding to column A)	Locations (Comma separated corresponding to column A)
FOAM TYPE				
SODA TYPE				
DRY TYPE (DCP)				
CO2 TYPE				

J) Tie-Ups with Emergency Services

Service (Add more rows if required)	Name, location & distance from site	Emergency contact details	Remarks
Hospital with ICU and facilities for orthopedic, neurological etc. trauma			
Fire services			
Others:			

Signature of Subcontractor Site In-charge

Signature of Subcontractor HSE Officer



POWER SECTOR

Monthly Site HSE Report

FORMAT NO: HSEP:14-F05

REV NO.: 00

Page 05 of 6

K) Implementation of Checklist, Work Permits:

Item	Numbers During the Month	Major Deviations

Note:- Please attach photocopies of all filled Checklists & Work permits for that month.

L) Personal Protective Equipment Issued (Extend table for each subcontractor):

Item	Issued this Month	Nos. Issued up to the Month	Percentage of usage at Site (as per physical verification)
Name of subcontractor:			
Safety Helmet			
Safety Shoes			
Full Body Harness			
Fall Arrestor			
Safety Nets			
Hand Gloves			
Face shield			
Welder shield			
Nose Mask			
Reflective Jacket			
Other PPEs.			

M) Safety Observations by Subcontractor Executives- Observations package wise:

Topic	Date Of Programme	No. Of Participants	Level Of Participants

• Tool-Box talks on Safety:

Date	Tool Box Talk - No of Participants	Topic	Remarks

• Safety Induction Trainings:

Date	Safety Induction No. of Participants	Topic	Remarks

Signature of Subcontractor Site In-charge

Signature of Subcontractor HSE Officer

	POWER SECTOR	FORMAT NO: HSEP:14-F05 REV NO.: 00 Page 06 of 6
	Monthly Site HSE Report	

N) Progress of Management Programmes at Site

SL	Description Of MPs	Annual Plan	Achievement In This Month	Cumulative Achievement
A. Environment Improvement Programme				
1	Plantation of Trees			
2	Installation of Scrap Bins			
3	Chemical Storage & Handling system			
B. Improvement of Working Environment				
4	Increasing LTI free days			
5	Air Quality Monitoring			
6	Water Quality Monitoring			
7	Illumination level Monitoring			

O) HR Information:

Designation	Total No. Inducted	Total no. of Induction Balance	Total no. of Gate Pass Issued	Total no. of Gate Pass Balance	Total no. of Gate Pass Cancelled	Medical Checkup Completed	Medical Checkup Balance

P) Rewards on Account of Good Safety Performance

Serial Number	Reward Issued to	Details of Reward Issued (Amount etc.)	Brief Reason

Note: Photos of Reward Functions to be attached

Q) Other Safety initiatives / Safety Activities conducted (with photos, if any):

Signature of Subcontractor Site In-charge

Signature of Subcontractor HSE Officer

**POWER SECTOR****Personal Protective Equipment Inspection**

FORMAT NO: HSEP:14-F06

REV NO.: 00

PAGE NO. 01 OF 01

Name of Site :	
Name of Sub-Contractor :	
Inspected by :	
Date of Inspection:	

Item	Total Checked	Numbers Found in Order	Remarks
Safety Helmet			
Safety Shoes			
Full Body Harness			
Fall Arrestor			
Safety Nets			
Hand Gloves			
Face shield			
Welder shield			
Nose Mask			
Reflective Jacket			
Other PPEs (Specify)			

Signature of Site I/C of Subcontractor:

Date:

	POWER SECTOR	FORMAT NO: HSEP:14-F07 REV NO.: 00 PAGE NO. 01 OF 01
	Inspection Of T&Ps	

Name of Site :	
Name of Sub-Contractor :	
Date of Inspection :	

Sl.No.	Description	Remarks
1.0	Name of equipment	
2.0	Basic Information of equipment	
2.1	Specification	
2.2	Sr. No. of equipment	
2.3	Make	
2.4	Year of manufacture	
3.0	Major repairs / overhauls(Furnish details of work carried out)	Date(s) of major repair/overhaul
3.1		
3.2		
3.3	Repairs carried out at site	
4.0	Any performance test conducted	Yes/No
5.0	Document Submitted	Yes/No
6.0	Manufacturer's test / guarantee certificate	Available/ Not available
7.0	Performance test	Done/ Not Done
8.0	Acceptance Norms	
9.0	Committee Observations	
10.0	Date of next review (if accepted)	
Signature-Subcontractor HSE Officer		Signature-Subcontractor Site In-charge



POWER SECTOR

Inspection Of Cranes

FORMAT NO: HSEP:14-F08

REV NO.: 00

PAGE NO. 01 OF 01

Name of Site :	
Name of Sub-Contractor :	
Inspected by :	
Date of Inspection:	

Crane Reg. No (Make/Model) _____

Name of Driver/Operator _____

Sl.no.	Description	Observation	Measures
1	Valid Driving license		
2	Hook & Hook Latch		
3	Over Hoist limit switch		
4	Boom limit switch		
5	Boom Angle Indicator		
6	Boom limit cutoff switch		
7	Condition of Boom		
8	Condition of ropes		
9	Number of load lines		
10	Size and condition of the slings		
11	Stability of the cranes		
12	Soil Condition		
13	Swing Break And Lock		
14	Proper Break And Lock		
15	Hoist Break And Lock		
16	Boom Break And Lock		
17	Main Clutch		
18	Leakage in Hydraulic Cylinders		
19	Out riggers fully extendable		
20	Tyre pressure		
21	Condition of Battery And Lamps		
22	Guards of moving and rotating parts		
23	Load chart provided		
24	Number and position of pedant ropes		
25	Reverse Horn		
26	Load Test Details		
27	Operator's fitness		
28	Pollution under control certificate		
29	Fire extinguisher of appropriate type.		
30	Training of the operator		

Signature of Site I/C of Subcontractor:

Date:



POWER SECTOR

Inspection Of Winches

FORMAT NO: HSEP:14-F09

REV NO.: 00

PAGE NO. 01 OF 01

Name of Site :	
Name of Sub-Contractor :	
Inspected by :	
Date of Inspection:	

Winch Reg. No (Make/Model) _____

Name of Operator _____

Sl. No.	Description	YES	NO	NA	Remarks
1	Has the copy of Third Party Inspection certificate been provided in winch machine shed?				
2	Is safe operating instructions displayed near winch?				
3	Is winch machine operator experienced enough to operate the winch machine?				
4	Is the winch machine operated by someone other than the winch machine operator?				
5	Is there guard provided in all moving parts like wheel and motor's shaft?				
6	Will it protect against unforeseen operational contingencies?				
7	Are brakes, clutch and locking arrangement working properly?				
8	Has it been ensured that the guard does not constitute a hazard by itself?				
9	Are the cranks and the connecting rods protected by guardrails?				
10	Is there provision for fully covered shed with wooden plank roof?				
11	Is wire rope free from any kind of damage or wear and tear?				
12	Is split pin provided for the protection of clutch and brake locking arrangement?				
13	Is pulley inspected by competent person and certified before use?				
14	Is pulley free from any wear and tear visually?				
15	Is winch rope barricaded with clipsheet for the protection of rope and person?				
16	Is the wire rope lubricated by cardium oil?				
17	Is there any friction in wire rope which may damage the wire rope rather than the rolling parts?				
18	Is there any oil leakage in the hydraulic system of the winch machine?				
19	Has it been ensured that the guard will not cause discomfort or inconvenience to operator?				
Total NO					
Total NA					
		% Compliance			

Signature of Site I/C of Subcontractor:

Date:



POWER SECTOR

Inspection of Height Working

FORMAT NO: HSEP:14-F10

REV NO.: 00

PAGE NO. 01 OF 2

Name of Site :	
Name of Sub-Contractor :	
Inspected by :	
Date of Inspection:	

Sl. No.	Descriptions	Observation (Yes/No)	Remarks
A. General			
1	All the workers have been explained safe work method?		
2	Adequate illumination has been ensured.		
3	Work area inspected prior to the start of the work.		
4	Is the work area barricaded to prevent fall and platforms are of adequate strength (bamboo, jute / plastic ropes not to be used).		
5	The temporary work platforms & structures for height work including those used in Boiler structures, water walls, ESP, Powerhouse are fully barricaded with railings (as per IS 3696)		
6	Fabricated makeshift arrangements are checked for quality and type of material welding, anchoring etc.		
7	Are floor gaps, permanently covered and barricaded		
8	Area below the work place barricaded, particularly below hot work.		
9	Workers provided with bags /box to carry bolts, nuts and hand tools		
10	Arrangement for fastening hand tools made.		
11	All work platforms ensured to be of adequate strength and ergonomically suitable.		
12	Work at more than one elevation at the same segment is restricted.		
13	An established communication system has been established and explained to the workers.		
B. Access/Egress			
1	Walkways provided with handrail, mid-rail and toe guard?		
2	All checkered plates, gratings properly welded/ bolted?		
3	Are ladders inspected and they are in good condition?		
4	Are ladders spliced?		
5	Are ladders properly secured to prevent slipping, sliding or falling?		
6	Stairs erected above and below 1 tier column for safe access?		
7	Do side rails extend 36" above top landing?		



POWER SECTOR

Inspection of Height Working

FORMAT NO: HSEP:14-F10

REV NO.: 00

PAGE NO. 02 OF 2

Sl. No.	Descriptions	Observation (Yes/No)	Remarks
8	Are built up ladders constructed of sound materials?		
9	Are rugs and cleats not over 12" on center?		
10	Metal ladders not used around electrical hazards.		
11	Proper maintenance and storage.		
12	Ladders placed at right slope.		
13	Ladders / staircases welded/ bolted properly.		
14	Any obstruction in the stairs.		
15	Are landing provided with handrails, knee rails, toe boards etc.?		
16	Whether ramp is provided with proper slope.		
17	Proper hand rails / guards provided in ramps.		
C. Housekeeping			
1	Walkways, aisles & all overhead workplaces cleared of loose material.		
2	Is any nut bolt/scrap left on beam/column?		
3	Flammable materials, if any, are cleared.		
4	All the de shuttering materials are removed after de shuttering is done.		
5	Platforms and walkways free from oil/grease or other slippery material.		
6	Collected scrap are brought down or lowered down and not dropped from height.		
D. PPE And Safety Devices			
1	Use of safety helmet, safety belts ensured for all workers		
2	Anchoring points provided at all places of work.		
3	Common lifeline provided wherever linear movement at height is required.		
4	Safety nets are use wherever required.		
5	Proper fall arrest system is deployed at critical workplaces.		
6	Crawler boards/Safety system or works on fragile roof are used.		
7	Is man-lift being used for personnel lifting?		
8	Does man basket / personnel lift system has an independent lifeline and all occupants safety harnesses connected to it with rope grab?		

Signature of Site I/C of Subcontractor:

Date:



POWER SECTOR

FORMAT NO: HSEP:14-F11

REV NO.: 00

PAGE NO. 01 OF 02

Inspection of Welding and Gas Cutting

Name of Site :	
Name of Sub-Contractor :	
Inspected by :	
Date of Inspection :	

Welding				
Sl.no.	Description	Y e s	N o	Remarks
1	Is electric connection given through 30 mA ELCB/RCCB to welding m/c?			
2	Is welding machine more than 10 years old?			
3	Is there provision of fuse and is it bypassed?			
4	Is electric cable fitted properly in junction box on m/c?			
5	Is electrical cable free from joints?			
6	Are the joints attached firmly & insulated with tape?			
7	Is double earthing given to body of m/c?			
8	Is the physical condition of the m/c good?			
9	Is ON/OFF switch connected to the m/c is working and in good condition?			
10	Are indication lamps on m/c working?			
11	Is the electrode holder in good condition?			
12	Are the cables of the welding m/c lugged & tight properly?			
13	Is cable to welding machine terminal joint lose / burnt / glowing?			
14	Are return lead connected properly (Rod, Angle, Channels shall not be used)			
	Total No of NO			
	Total No of YES			

Signature of Site I/C of Subcontractor:

Date:



POWER SECTOR

Inspection of Welding and Gas Cutting

FORMAT NO: HSEP:14-F11

REV NO.: 00

PAGE NO. 02 OF 02

Gas Cutting

Sl.no	Description	Yes	No	Remarks
1	Are Cylinders kept on trolleys?			
2	Physical condition of Gas cylinders Good?			
3	Is there Oil/Grease on valve of the cylinder?			
4	Are pressure regulators in good condition?			
5	Condition of hose pipe OK?			
6	Are hose pipe clamped with hose clip?			
7	Is flash back arrestor & NRV fitted on torch both for O2 and LPG cylinder?			
8	Is nozzle of the torch cleaned?			
	Total Number of NO			
	Total No of YES			
	% Compliance			

Signature of Site I/C of Subcontractor:

Date:



POWER SECTOR

Inspection Of Electrical Installation

FORMAT NO: HSEP:14-F12

REV NO.: 00

PAGE NO. 01 OF 02

Name of Site :	
Name of Sub-Contractor :	
Inspected by :	
Date of Inspection :	

Sr. No.	Contents	Yes/No	Remarks
A	Cable		
1.	Whether the condition of cable is checked?		
2.	Are cables received from other sites checked for insulation resistance before putting them into use?		
3.	Are all main cables taken either underground / overhead?		
4.	Are welding cables routed properly above the ground?		
5.	Are welding and electrical cables overlapping?		
6.	Is any improper joining of cables/wires prevailing at site?		
B	DBs/SDBs		
1.	Is earth conductor continued up to DB / SDB?		
2.	Whether DBs and extension boards are protected from rain / water?		
3.	Whether DB and extension board have separate MCB/ELCB		
4.	Is there any overloading of DBs / SDBs?		
5.	Are correct / proper fuses & CBs provided at main boards and sub-boards?		
6.	Is energized wiring in junction boxes, CB panels & similar places covered all times?		
C	ELCB		
1.	Whether the connections to all equipment are routed through individual ELCBs?		
2.	Is sensitivity of each ELCB maintained at 30 mA?		

**POWER SECTOR****INSPECTION OF ELECTRICAL INSTALLATION**

FORMAT NO: HSEP:14-F12

REV NO.: 00

PAGE NO. 02 OF 02

Sr. No.	Contents	Yes/No	Remarks
3.	Are the ELCB numbered and tested periodically & test results recorded in a logbook countersigned by a competent person?		
D	Grounding		
1.	Is natural earthing ensured at the source of power (main DB at Generator or Transformer)?		
2.	Whether the continuity and tightness of the earth conductor are checked?		
3.	Mention the gauge of the earth conductor used at the site.		
4.	Mention the value of Earth Resistance.		
E	Electrically operated Machines or Accessories.		
1.	Whether the plug top is provided everywhere.		
2.	Are all metal parts of electrical equipment and light fittings / accessories grounded / double earthed?		
3.	Is there any shed or cover for welding machines?		
4.	Are halogen lamps fixed at proper places?		
5.	Are portable power tools maintained as per norms?		
6.	Any other information:		

Signature of Site I/C of Subcontractor:

Date:

	POWER SECTOR	FORMAT NO: HSEP:14-F13 REV NO.: 00 PAGE NO. 01 OF 01
	Inspection of Elevator	

Name of Site :	
Name of Sub-Contractor :	
Inspected by :	
Date of Inspection :	

Sr. No.	Description	Remarks
1.0	Name of equipment	
2.0	Basic Information of equipment	
2.1	Specification	
2.2	Sr. No. of equipment	
2.3	Make	
2.4	Year of manufacture	
3.0	Major repairs/overhauls(Furnish details of work carried out)	Date(s) of major repair/overhaul
3.1		
3.2		
3.3	Repairs carried out at site	
4.0	Any performance test conducted	Yes/No
5.0	Document Submitted	Yes/No
6.0	Manufacturer's test / guarantee certificate	Available/ Not available
7.0	Performance test	Done/ Not Done
8.0	Acceptance Norms	
9.0	Committee Observations	
10.0	Date of next review (if accepted)	

Signature-Subcontractor/ Subcontractor's Safety Officer

Signature-Site Safety Officer (BHEL)

	POWER SECTOR	FORMAT NO: HSEP:14-F14 REV NO.: 00 PAGE NO. 01 OF 2
	HSE Penalty Format	

Sub: MEMO for Penalty for non-compliances in Safety and Fabrication Quality requirement

Following lapse (tick marked) was observed and penalty is imposed as stated at the bottom of this memo. It is requested that such occurrences may please be avoided in future.

S. No	Nature of Non - Compliance	Penalty (in Rs.)	Remarks
A. PPEs			
1.	Not wearing safety helmet / wearing without chin straps	500	Per Person/ day
2.	Not Wearing safety shoes	500	Per Person/ day
3.	Not wearing gloves, nose masks where required	350	Per Person/ day
4.	Not using grinding goggles while doing grinding operations	500	Per Person/ day
B. Height Work			
1.	Not providing Lifelines for height work	1000	Per location per day
2.	Not ensuring barricading of working platforms	1000	Per location per day
3.	Not using temporary platform during work at height	1000	Per case per day
4.	Not wearing safety belt while working at height (> 2 meters) or not anchoring to lifeline	2000	Per Person/ day
5.	Not providing proper barricades (caution tape at 2 elevations)	500	Per location per day
	Use of mobile phones by Height worker / Crane / Hydra Operator	1000	Per case per day
C. Electrical			
1.	Not using 24 V supply for lighting in confined spaces	500	Per case per day
2.	Lack of Electrical Earthing	2000	Per case per day
3.	Improper earthing of welding & Other electrical Machines. Earth resistance not OK	500	Per Machine per incidence
4.	Electrical plug not used for connection/ hand machines	500	Per connection per incidence
5.	Unsafe electrical practice like not installing ELCB/ RCCB	500	Per case per day
6.	Using frayed/ broken welding cables	500	Per machine per week
D. Lifting			
1.	Use of lifting equipment without having valid Third Party Test certificate	5000	Per equipment per seven days
2.	Lifting hooks without latches	500	Per hook per day
3.	Using damaged slings or not slinging properly	2000	Per event Per T&P
4.	Lifting cylinders without cage or rolling of cylinders	500	Per Event per incidence
5.	Non removal of scrap from platforms	1000	Per Event Per location per 7 days
E. Hot Work / Cylinder Handling			
20.	Gas cutting without flash back arrestor	2000	Per machine per incidence
21.	Gas cutting at height without sheet below	500	Per event
22.	Not keeping gas cylinders vertically / in trolley on ground	500	Per event
23.	Gas cutting with damaged hose pipes	500	Per event
	Not covering welding cylinder with top cover	500	Per event
F. Construction Vehicles			
24.	Not having valid driving license for the type of vehicle/ T&P	2000	Per driver per event
25.	Two wheeler entry in construction area	500	Per vehicle
26.	Using Hydra for material movement at site in unsafe manner	1000	Per case
27.	Using Two Hydra in Tandem for material movement	2000	Per case
28.	Vehicles, Hydras, Cranes, Dumpers and Earth Movers not having automatic back horns linked to gear	1000	Per Equipment per day
29.	Not using guide rope while moving material using Hydra or Crane	1000	Per event
30.	Violating speed limit during vehicle movement	1000	Per event

	POWER SECTOR	FORMAT NO: HSEP:14-F14 REV NO.: 00 PAGE NO. 02 OF 2
	HSE Penalty Format	

	Nature of Non - Compliance	Penalty in Rs.)	Remarks
Engineering / Administrative Controls / General			
31.	Major Accident – Victim not reporting for work within 48 hours – resulting in partial loss in earning capacity & termination / demotion in employment	200000	
32.	Fatal Accident/Accidents Resulting in total Loss in Earning Capacity #	500000	Per victim#
33.	Unsafe Act in violation of standards / clauses of this document	500-5000	Per case
34.	Activity carried out without safety work permit where applicable	2000	Per person per event
35.	Using untrained / unqualified personnel for hazardous work	2000	Per event
36.	Not maintaining proper hygiene in canteen as per BOCW	1000	Per event

or as deducted by customer, whichever is higher.

For repeated **major and** fatal incidents under the same subcontractor for the same package in the same Unit, the subcontractor will pay 2 times the penalty compared to previously paid

Details (if any) related to non- compliance (Name of persons, Nature of deficiency, etc.)

Penalty imposed:

1, Rate as per above chart _____

2. No. of Persons/ machine/ event/ labor _____

3. Total Penalty= 1. X 2. = _____

BHEL Personnel:

Signatures:

Name _____

Attachments: Photographs & Documentary proof (if available) for violation

Distribution: 1 Copy: to Sub- contractor Site In-charge,
1 Copy to Site Construction Manager (BHEL)

**POWER SECTOR****Format for Inspection of Labor Colony**

FORMAT NO: HSEP:14-F16

REV NO.: 00

PAGE NO. 01 OF 1

Name of Site :	
Name of Sub-Contractor :	
Inspected by :	
Date of Inspection :	

S. No	Particulars	No	Yes	Comments
1	Sufficient living space ensured for each occupant with Kitchen area			
2	Area cleanliness ensured through regular cleaning			
3	Toilet facility sufficient for all occupants available, in order with adequate lighting, cleaned regularly and in hygienic condition			
4	Washing facilities available with adequate water supply			
5	Availability of sufficient drinking water in protected tanks with weekly tank cleaning and source tested annually as per IS10500 ensured			
6	Adequate drainage to remove waste and rain water, no flooding			
7	"Unsafe for Drinking" posted near accessible non-potable water and sources; posted in language of occupants or universal symbol			
8	Prevention of mosquitoes, flies, and rodents in immediate housing area through insecticide sprays if required			
9	Electricity provided & electrical connections safety ensured			
10	Fans, Coolers / Quilts, Heaters provided as required to cater to weather conditions along with adequate electricity supply			
11	Houses Walls and roof tight and solid; floors rigid and durable, with smooth, cleanable finish in good repair			
12	Availability of nominal rate ration / common use items shop within / nearby the colony			
13	Emergency medical plan developed: (A) Potential injuries determined (B) Local EMS response determined (C) Qualified first-aid person on site, if required			
14	Emergency plans posted where employees gather			
15	Transportation to nearest suitable facility			

Any other checks:

Remarks:				
		Name & Sign. Of Subcontractor HSE Officer		

**POWER SECTOR**
**Format for Maintaining Records of E-waste
Handled / Generated**

FORMAT NO: HSEP:14-F18

REV NO.: 00

PAGE NO. 01 OF 1

(Generated Quantity in Metric Tons (MT) per year)

Site		
Subcontractor		
Date		
Types & Quantity of e-waste handled/generated**	Category	Quantity
	Item Description	
Types & Quantity of e-waste stored	Category	Quantity
	Item Description	
Types & Quantity of e-waste sent to collection center authorized by producer/dismantler/recycler/refurbisher or authorized dismantler/ recycler or refurbisher **	Category	Quantity
	Item Description	
Types & Quantity of e-waste transported*	Category	Quantity
	Item Description	
Name, address and contact details of the destination		
Types & Quantity of e-waste refurbished*	Category	Quantity
	Item Description	
Name, address and contact details of the destination of refurbished materials		
Types & Quantity of e-waste dismantled*	Category	Quantity
	Item Description	
Name, address and contact details of the destination		
Types & Quantity of e-waste recycled*	Category	Quantity
	Item Description	
Types & Quantity of materials recovered	Item Description	
	Quantity	
Name, address and contact details of the destination		
Types & Quantity of e-waste sent to recyclers by dismantlers	Category	Quantity
	Item Description	
Name, address and contact details of the destination		
Types and Quantity of other waste sent to respective recyclers by dismantlers / recyclers of e-waste	Category	Quantity
	Item Description	
Name, address and contact details of the destination		
Types and Quantity of e-waste treated & disposed	Category	Quantity
	Item Description	
Name, address and contact details of the destination		

Signature of Subcontractor Site In-charge:

Date

**POWER SECTOR****Format for Maintaining Records of Hazardous Waste at the Facility**

FORMAT NO: HSEP:14-F19

REV NO.: 00

PAGE NO. 01 OF 1

1. Name of Site:
2. Name of the Subcontractor:
3. Date:
4. Description of hazardous waste:

Physical form with description	Chemical form	Total volume and weight (in kg.)

5. Description of storage and treatment of hazardous waste:

Date	Method of storage of hazardous wastes	Date	Method of treatment of hazardous wastes

6. Details of transportation of hazardous waste:

Name & address of consignee of package	Mode of packing/of the waste for transportation	Mode of transportation to site of disposal	Date of transportation

7. Details of disposal of hazardous waste:

Date of disposal	Concentration of hazardous material in the final waste form	Site of disposal (identify the location on the relevant layout drawing for reference)	Method of disposal	Persons involved in disposal

8. Data of environmental surveillance:

Date of measurement	Analysis of ground water			Analysis of soil samples			Analysis of air sampling			Analysis of any other samples (give details)
	Location of sampling	Depth of sampling	Data	Location of sampling	Depth of sampling	Data	Location of sampling	Data		

9. Details of the hazardous wastes reused and recycled:

Date	Total quantity of hazardous waste generated	Details of hazardous waste minimization activity	Material received	Final quantity of waste generated	Net reduction in waste generation quantity and percentage

Signature of Subcontractor Site In-charge:

Date:

**POWER SECTOR****HSE Audit / Inspection Checklist-cum-Compliance Report**

FORMAT NO: HSEP:14-F20

REV NO.: 00

PAGE NO. 01 OF 3

PROJECT: _____

CONTRACTOR: _____

DATE: _____

OWNER : _____

INSPECTION BY: _____

Note : write 'NA' wherever the items is not applicable

Item	Y e s	N o	Remarks	Action
HOUSEKEEPING				
Waste containers provided and used				
Passageways and walkways clear				
General neatness of working area				
Other				
PERSONNEL PROTECTIVE EQUIPMENT				
Goggles; shields				
Face protection				
Hearing protection				
Respiratory masks etc.				
Safety belts				
Other				
EXCAVATIONS / OPENINGS				
Openings properly covered or barricaded				
Excavations shored				
Excavations barricaded				
Overnight lighting provided				
Other				
WELDING, CUTTING				
Gas cylinders chained upright				
Cable and hoses not obstructing				
Fire extinguisher (s) accessible				
Others				
SCAFFOLDING				
Fully decked platforms				
Guard and intermediate rails in place				
Toe boards in place				
Adequate shoring				
Adequate access				
Others				
LADDER				
Extension side rails 1 m above				
Top of landing				
Properly secured				
Angle + 70° from horizontal				
Other				

**POWER SECTOR****HSE Checklist-cum-Compliance Report**

FORMAT NO: HSEP:14-F20

REV NO.: 00

PAGE NO. 02 OF 3

HOISTS, CRANES AND DERRICKS				
Condition of cables and sheaf OK				
Condition of slings, chains, hooks OK				
Inspection & maintenance log maintained				
Outriggers used				
Signals observed and understood				
Qualified operators				
Others				
MACHINERY, TOOLS & EQUIPMENT				
Proper instruction				
Safety devices				
Proper cords				
Inspection and maintenance				
Other				
VEHICLE AND TRAFFIC				
Rules and regulations observed				
Inspection and maintenance				
Licensed drivers				
Other				
TEMPORARY FACILITIES				
Emergency instructions posted				
Fire extinguishers provided				
Fire-aid equipment available				
General neatness				
Others				
FIRE PREVENTION				
Personnel instructed				
Fire extinguishers checked				
No smoking in prohibited areas.				
Hydrants				
Clearance				
Others				
ELECTRICAL				
Proper wiring				
ELCB's provided				
Ground fault circuit interrupters				
Protection against damage				
Prevention of tripping hazards				
Other				
HANDLING & STORAGE OF MATERIALS				
Properly stored or stacked				
Passageways clear				
Other				
FLAMMABLE GASES AND LIQUIDS				
Containers clearly identified				
Proper storage				
Fire extinguisher nearby				
Other				

**POWER SECTOR****HSE Checklist-cum-Compliance Report**

FORMAT NO: HSEP:14-F20

REV NO.: 00

PAGE NO. 03 OF 3

WORKING AT HEIGHT				
Safety nets				
Safety belts				
Safety helmets				
Anchoring of safety belt to the life line rope				
ENVIRONMENT				
Lubricant waste/engine oils properly dispose.				
Waste from Canteen, offices, sanitation etc. disposed properly.				
Disposal of surplus earth, stripping materials, expired batteries, oily rags and combustible materials done properly.				
HEALTH CHECKS				
Hygienic conditions at labor camps O.K.				
Availability of first-aid facilities				
Proper sanitation at site, office & labor camps.				
Arrangement of medical facilities.				
Measures for dealing with illness.				
Availability of potable drinking water for workmen & staff.				
Provision of crèches for children.				

Signature of Subcontractor Site In-charge:

Date:



POWER SECTOR

Format for Inspection of Illumination / Lux Levels

FORMAT NO: HSEP:14-F21

REV NO.: 00

PAGE NO. 01 OF 1

Name of Site :					
Name of Sub-Contractor :					
Inspected by :					
Date of Inspection :					
Details of Lux Meter Used for Illumination Checking					
Serial Number		Last inspection Date		Inspection Due Date	

S. No	Location	Applicable Lux Value	Measured Lux Value	Comments
1				
2				
3				
4				
5				
6				
7				
8				
9				
10				
11				
12				
13				
14				
15				

Any other checks:

Remarks:	
	Name & Sign. Of Subcontractor HSE Officer

	POWER SECTOR	FORMAT NO: HSEP:14-F22 REV NO.: 00 PAGE NO. 01 OF 2
	Format for Incident Reporting	

Type of incident: Fatal/Major//Fire/Property damage (Tick what is applicable)

1	Name Of Site		3	Activity Area	
2	Scope Of Work		4	Name Of Contractor	
			5	NAME & DESIGNATION OF BHEL ACTIVITY I/C	
6	Date & Time Of Accident		7	Date Resumed	
8	No. Of Work-Days Lost by Victim (If Duty Not Resumed, Give Estimated Figure)				
9	No. Of Man-hours Lost By Others				
10	Personal Details Of Injured and/or Details Of Materials/Equipment/ Property Damaged				
Name			Name Of Material / Equipment / Property		
Period Of Employment					
Age	Yrs.	Sex	Male/Female	Estimated Cost	Actual Cost
Marital Status		Single/ Married			
Occupation			Nature Of Damage		
Part Of Body Injured					
Nature Of Injury					
Agency (Object / Equipment / Substance) Most Responsible For Causing Accident / Injury / Damage					
12	Person (Name & Designation) With Most Control Over Agency (Object / Equipment / Substance) Causing Accident Injury / Damage				
13	Describe Clearly How the Accident Occurred (Use Additional Sheet, If Required)				

**POWER SECTOR****Format for Incident Reporting**

FORMAT NO: HSEP:14-F22

REV NO.: 00

PAGE NO. 02 OF 2

Analysis

14	What Acts and/or Conditions Contributed Most Directly to This Accident	
15	What Are the Basic Reason for The Existence of These Acts and/or Condition?	
16	What Corrective Actions Have Been Taken to Prevent Accident Recurrence?	
	Date:	Signature Of Site HSE Coordinator
17	Comments of Head/Sox	
	Date:	Signature Of Head/SOX

SECTION-B

Special Requirements

(Applicable to this Contract Only)

 POWER SECTOR	HEALTH, SAFETY AND ENVIRONMENT PLAN FOR SITE OPERATIONS (SECTION-B)	Doc. No.: HSEP:14-ER Rev.: 00
		Date: 25.04.19
		Page 1 of 162

1. Establishment of Common Facilities for whole Project – cost to be borne in full by subcontractor.

Table 1.1

S. No.	Item	Details as per Clause No. of this Section	Applicable / Not Applicable with Remarks	Package
1	Construction of Medical Centre	a	Applicable	Civil
2	Construction of Worker Training Centre (A part of safety park)	b	Applicable	Civil
3	Construction of Vertigo Test Structure (A part of safety park)	c	Applicable	Civil
4	Deployment of Specialists	d	Applicable	By concerned agencies
5	HSE Equipment	e	Applicable	By concerned agencies
6	HSE measurement devices	f	Applicable	By concerned agencies
7	Urinals in under-construction structures	g	Applicable	By concerned agencies
8	Safety Park	h	Applicable	Civil

a. MEDICAL CENTRE

- i. A medical center shall be setup at site with basic facilities for handling medical emergencies
- ii. Deployment of Medical Professional:
 1. **A qualified medical professional shall be deployed at site at all times.**
 2. **When total employee & worker strength at site crosses 500, medical professional with MBBS Degree from recognized institute shall necessarily be deployed**
- iii. Ambulance shall be deployed along with a trained driver and accessories as per Schedule V of BOCW Central Rules, 1998. Ambulance shall be utilized exclusively for transporting the accident victim. Ambulance drivers shall be regularly trained in First Aid.
- iv. Non deployment of Ambulance and First Aider as above shall invite a penalty of Rs. 30000 pm and Rs10000 PM respectively
- v. Medical waste shall be disposed as per prevailing legislation (Bio-Medical Waste – Management and Handling Rules, 1998).
- vi. Above are bare minimum requirements. Any legal requirements over and above these specifications shall supersede the above requirements



POWER
SECTOR

HEALTH, SAFETY AND ENVIRONMENT PLAN
FOR
SITE OPERATIONS
(SECTION-B)

Doc. No.: HSEP:14-ER

Rev.: 00

Date: 25.04.19

Page 2 of 162

b. WORKER TRAINING CENTRE

- i. Indoor Worker Training Center to be developed at site with seating capacity of at least 50 trainees
- ii. Projector with following minimum specifications:

Native Resolution	XGA, 1024x768
Brightness (ANSI lumens)	3300
Contrast Ratio	13000:1
Display Color	30 Bits
Aspect Ratio	4:3

- iii. A Laptop or Desktop PC with following minimum specifications:

Processor	Intel Celeron Dual Core
Memory (RAM)	2 GB
Graphics Card	2GB Video Memory
Hard Disk Capacity	60 GB
Monitor Size	14 inches
Keyboard	
Mouse	

- iv. Stereo speakers with minimum 50W RMS sound output
- v. PA system for Addressing Workers
- vi. Seating arrangement

c. Development of Vertigo Test Structure:

Vertigo test Structure to be developed as per **Annexure 04**

d. Specialists:

Following specialists shall be deployed by the subcontractor, who shall cater to whole project as per BHEL requirements / instructions

- I. **Qualified T&P Inspector: subcontractor** shall engage one qualified T&P inspector having undergone a certification course in the discipline.
- II. **Qualified Scaffolding Erector and Inspector:** Subcontractor shall deploy one qualified Scaffolding Supervisor and Inspector having undergone a certification course in the discipline



POWER
SECTOR

HEALTH, SAFETY AND ENVIRONMENT PLAN
FOR
SITE OPERATIONS
(SECTION-B)

Doc. No.: HSEP:14-ER

Rev.: 00

Date: 25.04.19

Page 3 of 162

- e. **Tools & Equipment:** Following equipment conforming to relevant IS Codes for the job shall be ensured by subcontractor:

S. No.	Item
1	Lifelines
2	Retractable Fall Arrestors
3	Safety Nets (10m X 5m)
4	Sky Climbers
5	Fire Blanket
6	Honey Bee Removal Suit & Kit
7	Flashback Arrestors
8	Barricading Tape
9	Binoculars
10	Walkie-Talkies
11	LOTO kit
12	24-Volt light
13	Sand Buckets
14	Hard barricading planks
15	Standby Fire kits

S. No.	Item	Type of Job / Purpose	Remarks
1	Lifelines (Steel Rope) and posts	Height work	
2	Retractable Fall Arrestors	Height Work	
3	Safety Nets (for fall protection; railings also to be covered)	Height Work	
4	Sky Climbers	Height Work	
5	Fire Blanket, Spark/ slag collector	Hot Work	
6	Honey Bee Removal Suit & Kit	General	
7	Flashback Arrestors	Hot work	
8	Barricading –Hard (Scaffolding Pipes & Clamps or fabricated using structural/round	Height Work, Excavation, General Barricading	
9	Binoculars	HSE Inspection	
10	Walkie-Talkies	Lifting	
11	LOTO kit	Working on charged line	
12	24-Volt light	Confined Space/ temp work	
13	Sand and Water Buckets	Hot work/Electrical work	
15	Standby Fire kits Fire extinguisher stands	Hot work/Electrical work	



POWER
SECTOR

HEALTH, SAFETY AND ENVIRONMENT PLAN
FOR
SITE OPERATIONS
(SECTION-B)

Doc. No.: HSEP:14-ER

Rev.: 00

Date: 25.04.19

Page 4 of 162

Above equipment are bare minimum to be essentially maintained at all times. Additional numbers to be deployed as and when required in order to ensure fulfillment of all Safety requirements

f. HSE Measurement Equipment & Tools

S. No	Device
1	ELCB Tester
2	Multi meter (Light cables)
3	Earth Resistance Meter
4	Lux Meter
5	Decibel Meter
6	Anemometer
7	Breath Analyzer (Alcohol)
8	Multi-gas analyzer
9	Gas leakage detector / alarm
10	Gas monitor (confined space)
11	Radiation meter & Badges
12	Blood pressure monitor
13	Fire detectors
14	Dust Particle Detector

g. Urinals in Under-construction structures:

Urinals for in under-construction structures for easy access eg. In case of Boiler elevations etc.

2. **Shared Facilities** – where part of operating cost is borne by subcontractor in proportion to contract value

The subcontractor shall bear running expenses of above facilities on a 'proportional to contract value sharing basis as finalized by BHEL.

S. No.	Facility
1.	Operation of Ambulance, Nurses, Medical Consumables
2.	Construction, Maintenance & Upkeep of Latrines and Urinals in Common spaces
3.	Drinking Water Provision in Common Spaces
4.	Dust Control / Water Sprinkling, Pest Control, Fumigation at Site



POWER
SECTOR

HEALTH, SAFETY AND ENVIRONMENT PLAN
FOR
SITE OPERATIONS
(SECTION-B)

Doc. No.: HSEP:14-ER

Rev.: 00

Date: 25.04.19

Page 5 of 162

LIST OF REFERENCES

S. No	Code Name	Title
1	IS: 818-1888 (Reaffirmed 2003)	Code of Practice for Safety and Health requirements in Electric and Gas Welding and Cutting operations.
2	IS: 1179-1967 (Reaffirmed 2003)	Specification for Equipment for Eye & Face protection during welding.
3	IS: 1989 (Part 2):1986 (Reaffirmed 1997)	Specification for Leather Safety Boots & Shoes
4	IS:2925 – 1984 (Reaffirmed 2010)	Specification for Industrial Safety Helmets
5	IS:3521: 1999 (Reaffirmed 2002)	Industrial Safety Belts & Harnesses-Specification
6	IS:3646(Part II) – 1966(Reaffirmed 2003)	Code of Practice for Interior Illumination
7	IS:3696 (Part I) – 1987 (Reaffirmed 2002)	Safety Code for Scaffolds and Ladders
8	IS: 3696(Part 2) : 1991 (Reaffirmed 2002)	Scaffolds and Ladders-Code of Safety
9	IS: 3764:1992	Excavation Work – Code of Safety
10	IS:3786 – 1983 (Reaffirmed 2002)	Method for Computation of Frequency and Severity Rates for Industrial Injuries and Classification of Industrial Accidents
11	IS.4014.2.1967	Steel tubular Scaffolding
12	IS:4770: 1991 (Reaffirmed 2006)	Rubber Gloves Specification (Electricals Purposes)
13	IS:4912: 1978 (Reaffirmed 2002)	Safety Requirements for Floor and Wall Openings, Railings and Toe Boards
14	IS: 5557 – 1969	Industrial and Safety rubber knee boots.
15	IS: 5983 – 1980 (Reaffirmed 2002)	Specification for Eye-Protectors
16	IS:6519 – 1971 (Reaffirmed 1997)	Code of Practice for Selection, Care and Repair of Safety Footwear
17	IS.6549.1972	Glossary of terms used for Lifting tackles
18	IS:6994(Part I)-1973 (Re affirmed 1996)	Specification for Industrial Safety Gloves Leather and Cotton Gloves
19	IS.7215.1974	Steel Structure Fabrication
20	IS.7969.1975	Handling and storage of building material



POWER
SECTOR

HEALTH, SAFETY AND ENVIRONMENT PLAN
FOR
SITE OPERATIONS
(SECTION-B)

Doc. No.: HSEP:14-ER

Rev.: 00

Date: 25.04.19

Page 6 of 162

21	IS:8519 – 1977 (Reaffirmed 1983)	Guide for Selection of Industrial Safety Equipment for Body Protection.
22	IS:8520 – 1977 (Reaffirmed 2002)	Guide for Selection of Industrial Safety Equipment for Eye, Face and Ear Protection.
23	IS:9167:1979	Specification for Ear-Protectors
24	IS:9473:2002	Respiratory Protective Devices-Filtering Half Masks to protect against Particles-Specification.
25	IS: 9944:1992 (Reaffirmed 2003)	Natural and Man-made Fiber Rope Slings- Recommendations on Safe working loads.
26	IS 11006 : 2011	Flash Back(Flame) Arrestor Specification
27	IS: 11226 – 1985	Leather Safety footwear having direct molding sole.
28	IS:11057 – 1884 (Reaffirmed 2001)	Specification for Industrial Safety Nets
29	IS: 12254:1993 (Reaffirmed 2002)	Polyvinyl Chloride (PVC) Industrial Boots Specification
30	IS:13367(Part 1):1992 (Reaffirmed 2003)	Safe Use of Cranes-Code of Practice
31	IS: 14166:1994 (Reaffirmed 2002)	Respiratory Protective Devices-Full Face Masks Specification
32	IS:14746: 1999 (Reaffirmed 2003)	Respiratory Protective Devices-Half Masks and Quarter Masks - Specification
33	IS: 15397 :2003 (Reaffirmed 2008)	Portable Extinguisher Mechanical Foam Type(Stored Pressure)-Specification
34	IS: 19011:2002	Guidelines for Quality and/or Environmental Management Systems Auditing

	HEALTH, SAFETY AND ENVIRONMENT PLAN FOR SITE OPERATIONS (SECTION-B)	Doc. No.: HSEP:14
		Rev.: 01
		Date: Page 1 of 162

As per Contract Labor (Regulation & Abolition Act), Central Rules, 1971,

- (1) The first-aid box shall be distinctively marked with a Red Cross on a white background and shall contain the following items, namely:

(a) For establishments in which the number of contract laborers employed does not exceed fifty, each first aid box shall contain the following equipment:

(i)	6 small sterilized dressings
(ii)	3 medium size sterilized dressings
(iii)	3 large size sterilized dressings
(iv)	6 pieces of sterilized eye pads in separate sealed packets.
(v)	6 roller bandages 10 cm wide.
(vi)	6 roller bandages 5 cm wide.
(vii)	One tourniquet
(viii)	A supply of suitable splints
(ix)	Three packets of safety pins.
(x)	Kidney tray.
(xi)	3 large sterilized burn dressings.
(xii)	1 (30ml) bottle containing a two percent alcoholic solution of iodine
(xiii)	1 (30 ml) bottle containing Sal volatile having the dose and mode of administration indicated on the label
(xiv)	1 snake bite lancet
(xv)	1 (30gms) bottle of potassium permanganate crystals.
(xvi)	1 pair scissors
(xvii)	1 copy of the First-Aid leaflet issued by the Director General, Factory Advice Service and Labor Institutes, Government of India.
(xviii)	A bottle containing 100 tablets (each of 5 grains) of aspirin
(xix)	Ointment for burns
(xx)	A bottle of suitable surgical anti-septic solution

**HSEP:14 - ANNEXURE 03**

Details and Contents of First Aid Box

(b) For establishment in which the number of contract laborers exceeds fifty each first-aid box shall contain the following equipment:

(i)	12 small sterilized dressings
(ii)	6 medium size sterilized dressings
(iii)	6 large size sterilized dressings.
(iv)	6 large size sterilized burn dressings
(v)	6 (15 grams) packets sterilized cotton wool
(vi)	12 pieces of sterilized eye pads in separate sealed packets.
(vii)	12 roller bandages 10 cm wide.
(viii)	12 roller bandages 5 cm wide.
(ix)	One tourniquet.
(x)	A supply of suitable splints.
(xi)	Three packets of safety pins.
(xii)	Kidney tray.
(xiii)	Sufficient number of eye washes bottles filled with distilled water or suitable liquid clearly indicated by a distinctive sign which shall be visible at all times.
(xiv)	4 per cent Xylocaine eye drops, and boric acid eye drops and soda by carbonate eye drops.
(xv)	1 (60ml) bottle containing a two percent alcoholic solution of iodine
(xvi)	One (two hundred ml) bottle of mercurochrome (2 per cent) solution in water.
(xvii)	1 (120ml) bottle containing Sal volatile having the dose and mode of administration indicated on the label.
(xviii)	1 roll of adhesive plaster (6 cmX1 meter)
(xix)	2 rolls of adhesive plaster (2 cmX1 meter)
(xx)	A snake bite lancet.
(xxi)	1 (30 grams) bottle of potassium permanganate crystals.
(xxii)	1 pair scissors
(xxiii)	1 copy of the First-Aid leaflet issued by the Director-General, Factory Advice service and labor Institutes, Government of India.
(xxiv)	a bottle containing 100 tablets (each of 5 grains) of aspirin
(xxv)	Ointment for burns
(xxvi)	A bottle of a suitable surgical anti septic solution.

(2) Adequate arrangement shall be made for immediate recoument of the equipment when necessary.

 <p>POWER SECTOR</p>	<p>HEALTH, SAFETY AND ENVIRONMENT PLAN FOR SITE OPERATIONS (SECTION-B)</p>	Doc. No.: HSEP:14
		Rev.: 01
		Date:
		Page 1 of 162

Table 1	
S. No.	Topic
1	Vertigo / Height working Test Structure Layout
2, 3	Structure Layout Sketch
3	Actual Photo of a typical structure
4	Bill of Materials
5	Guidelines for Conducting the Test



Note:

- All dimensions are in mm
- Drawing is not to scale
- Inside boundary area to be filled with sand to level with road (external)
- Details of F1 and F2 are shown below

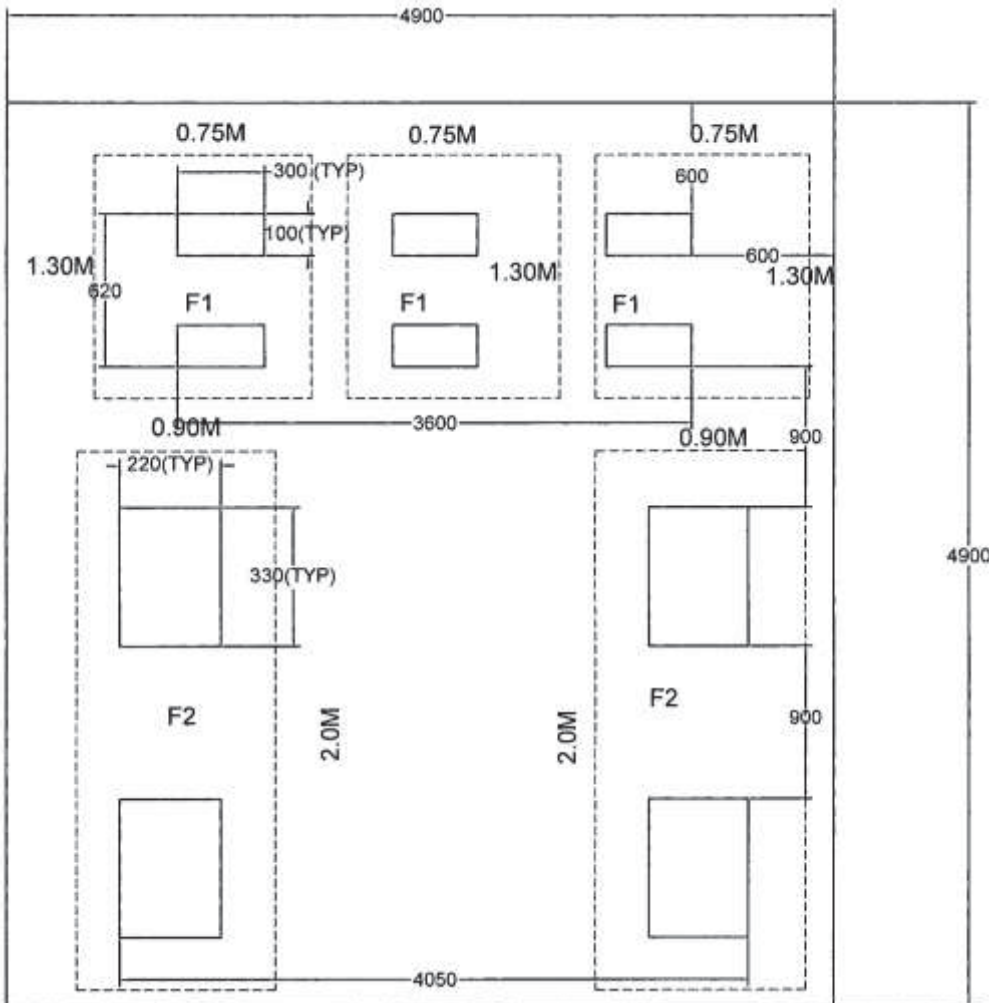
Figure 1: Vertigo / Height Work Test Structure Layout



Vertigo Test Structure Specifications

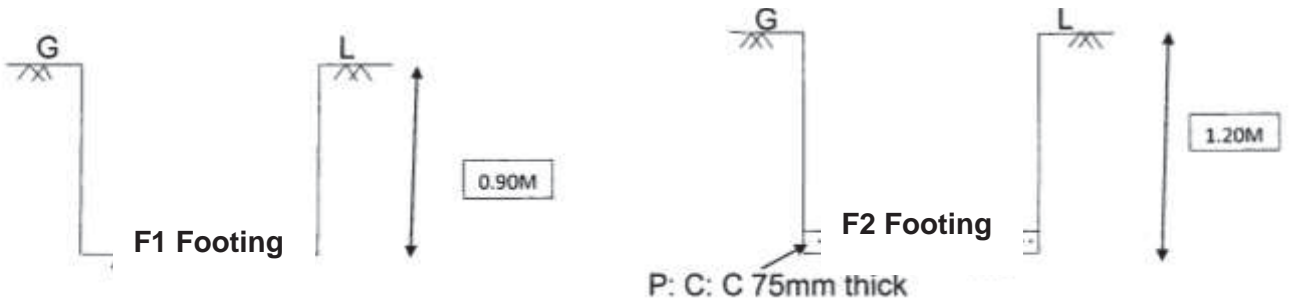

Note:

- Concrete Grade is M15
- Drawing is not to scale
- TOC is at Road Level
- G L refers to Ground Level

Figure 2



Vertigo Test Structure Specifications

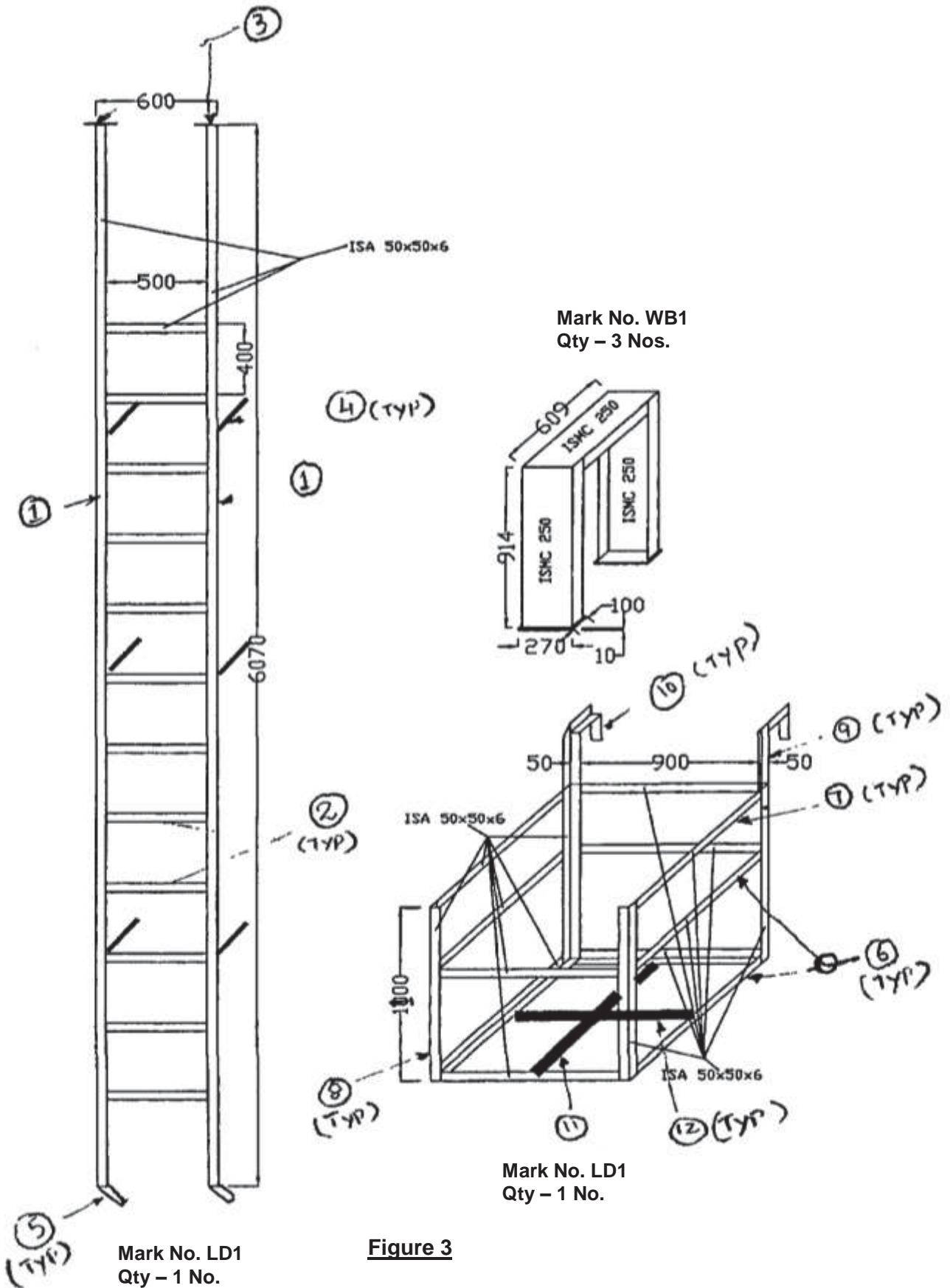
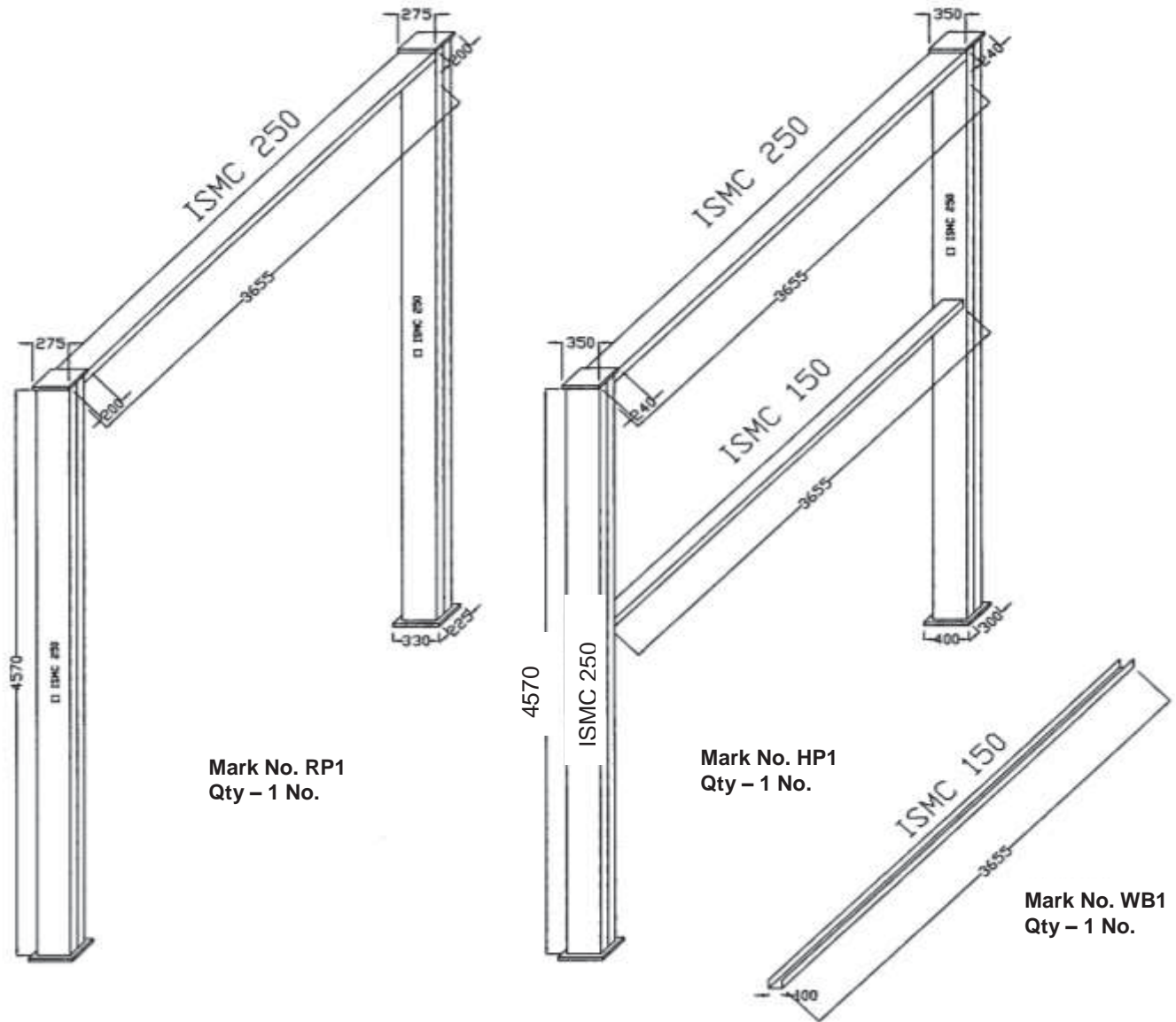

Figure 3



Vertigo Test Structure Specifications

Figure 4



**Vertigo Test Structure Specifications****Table 2: BOM FOR HEIGHT WORK INDUCTION TRAINING MODULE**

Sl. No.	Description	Width (mm)	Length (mm)	Qty (No's)	Unit Wt (Kgs)	Total Wt. (Kgs)
MKD NO. WB1						
1	ISMC250		609	3	34.20	62.483
2	ISMC250		914	6	34.20	187.553
3	ISMC100		3655	1	9.56	34.942
4	PL10	100	270	6	78.50	12.717
			Total Weight (Kgs)			297.695
MKD NO. RP1						
1	ISMC250		4570	4	34.20	625.176
2	ISMC250		3655	1	34.20	125.001
3	PL25	225	330	2	196.25	29.143
4	PL25	200	275	2	196.25	21.588
			Total Weight (Kgs)			800.908
MKD NO. HP1						
1	ISMC250		4570	4	34.20	625.176
2	ISMC250		3655	1	34.20	125.001
3	ISMC150		3655	1	16.80	61.404
4	PL25	300	400	2	196.25	47.100
5	PL25	240	350	2	196.25	32.970
			Total Weight (Kgs)			891.651
MKD NO. LD1						
1	ISA50X50X6		6070	2	4.50	54.630
2	ISA50X50X6		500	12	4.50	27.000
3	PL12	75	75	2	94.20	1.060
4	ISA50X50X6		300	6	4.50	8.100
5	ISA50X50X6		255	2	4.50	2.295
6	ISA50X50X6		1000	8	4.50	36.000
7	ISA50X50X6		910	3	4.50	12.285
8	ISA50X50X6		1100	4	4.50	19.800
9	ISA50X50X6		650	2	4.50	5.850
10	ISA50X50X6		350	2	4.50	3.150
11	PL8	75	900	1	62.80	4.239
12	PL8	75	410	2	62.80	3.862
			Weight (Kgs)			178.271
			Total Weight (Kgs)			2168.525

**Vertigo Test Structure Specifications****A. Test Procedure / Guidelines**

Fear of height may be physiological or psychological. Therefore, to rule out any possibility of physiological factor, detailed medical check-up of workers is carried out before vertigo test. Medical check-up of workers includes the following:

history of past illnesses (like epilepsy, drug allergy, diabetics/ hypertension, unconsciousness etc.), general physical examination (like height, weight, BMI, build and nourishment etc.), measurement of pulse rate, Blood Pressure, respiratory rate.

After this check-up, those who are found suitable for height work by examining doctor, are allowed to undergo vertigo test.

During this health check-up, psychology of workers is also studied. If any worker finds it extremely difficult/ frightening to climb the monkey ladder & walk on the beam, during/after performing vertigo test or even before performing, then he is treated as disqualified.

As per standard, during vertigo test, worker is allowed to climb on a foundation through monkey ladder, walk on a beam, then steps down at the other end of beam, through monkey ladder. Height of the beam should be at least six feet from ground level. All necessary safety precautions are taken during this test. Worker has to wear full body harness with double lanyard. A horizontal lifeline is run parallel to the beam and worker has to put his lanyards into the lifeline. Additionally, a safety net is also put below the beam for rescue of the victim in case of a fall from beam.

Following activities are generally carried during testing:

1. Walking Bench Training:

- a. Person should walk over the channel. He should maintain balance & walk without much problem.
- b. If the person has problem to balances himself on repeated chances, he may be having flat foot or some other problem. So, he may not be fit for height work.

2. Rope Climb Training:

Person should be able to climb the rope up to the top channel for ensuring that in case of fall, a person hanging on the safety harness, will be able to safely climb back to the platform within minimum time period before the safety harness start breaking down under the load.

3. Height Work Training:

Person should walk freely on the middle channel while holding the top channel with the help of safety harness.

4. Ladder for Vertical fall arrestor Training:

Vertical fall arrestor rope is fixed from top to bottom of the ladder. It will ensure:

- Usage of vertical fall arrestor.
- Usage of two lanyards of a safety harness.
- Ensure 3-point contact on the ladder while climb.

5. Chair for work at height Training:

- Climb though vertical ladder with two lanyard ropes.
- Hooking of two lanyard ropes to life line. With this safe arrangement, he can walk to chair.
- Sits in the chair safely, comes out & walks back to the vertical ladder & come down from vertical ladder. After completion of vertigo test, blood pressure of worker is again measured. If it is not within acceptable limits for any worker, concerned worker is denied height pass.

Only those who pass the above training are fit for height work.



POWER
SECTOR

TENDER NO: PSEER/SCT/BAR-C/1974-19
HEALTH, SAFETY AND ENVIRONMENT PLAN
FOR
SITE OPERATIONS
(SECTION-B)

Doc. No.: HSEP:14

Rev.: 01

Date:

Page 7 of 162

Safety Park Requirements

S.No	Training room(capacity 40 persons)	Qty.
1	Class room chair	25
2	Office Table	3
3	Rolling chair	3
4	Almirah	1
5	Visitor chair	10
6	Drawer	2
7	Single bed	1
8	Mattress	1
9	Projector	1
10	Projector screen	1
11	Sound speakers	1
12	Desktop Computer	3
13	Printer	1
14	White Board	1
15	Marker	5
16	Duster	1
17	Door Mat	9
18	Dustbin(Smaal + BIG)	7+1
19	Mannequin	1
20	Helmet	1
21	Face Shield	1
22	Safety Goggle	1
23	Welding sheild	1
24	Ear Muff	1
25	Ear Plug	1
26	Nose Mask	1
27	Breathing Apparatus	1
28	Hand Gloves(Cotton)	1
29	Hand Gloves for Electrician (Rubber)	1
30	Hand gloves Rubber	1
31	Hand Gloves Lather	1
32	Construction Safety Uniform(Boiler Suit)	1
33	Welding Apron	1
34	Safety Shoes	1
35	Leg Guard For Welder	1
36	Poster for Occupational Disease like Pneumoconosis,silicosis etc.	1
37	Gum Boot	1

38	Full Body Harness	1
39	8 MM Wire rope for life line. Length 20 Feet(FT).	1
40	Sfety Net for man & materials.Size 15 FT X 15FT.	1
41	MonkEy ladder 15 FT.	1
45	Fire Extingusher All types(DCP,CO2 & Foam)	1
46	Bed Sheet	1
47	Pillow	1
48	Curtain	12
49	curtain fittings	12
50	AC (1.5 TON)	3
51	AC (2 TON)	2
52	Rope pully.	1
53	PP Rope for pully 20 MTR.	
54	Ladder Clamps	6
55	Allumuniam ladder 6 MTR.	1
56	Carry Bag	
57	Scaffolding all Materilas for 5 Mtr. Height like.Sacffolding tubes,Sole plate,base plate,Right angle clamps,Swielclamps,beam clamps,Joint box/joint pin,toe guard/board,	



TENDER NO: PSER:SCT:BAR-C1971:19

Health, Safety & Environment, Power Sector Headquarters

Bharat Heavy Electricals Limited

Regd. Office: BHEL House, Siri Fort, New Delhi – 110049, India

Website: www.bhel.com