

TENDER DOCUMENT

TENDER SPECIFICATION No : **BAP : FES: PG TEST 2016-17/01**

NAME OF WORK:

Conducting Performance Guarantee Test in Electrostatic Precipitator (ESP) at various Power Plants as per laid down procedure. The objective is to determine the collection efficiency, pressure drop and auxiliary Power consumption of Electrostatic Precipitator. The collection efficiency to be calculated based on the dust concentrations at the inlet and outlet of precipitator. The scope of this work involves (A) Measurement of parameters like flue gas flow rate, flue gas temperature, dust concentration at the inlet & outlet of electrostatic precipitator, corona / auxiliary power measurements. (B) Providing of skilled man power for the above scope of work.

Issued to M/s. :

PART – I (TECHNICAL BID)



FES DEPARTMENT

BHARAT HEAVY ELECTRICALS LIMITED

(A Government of India Undertaking)

BOILER AUXILIARIES PLANT

INDIRA GANDHI INDUSTRIAL COMPLEX

RANIPET – 632 406

BHARAT HEAVY ELECTRICALS LIMITED
BOILER AUXILIARIES PLANT
RANIPET- 632406.

FES DEPARTMENT

TENDER SPECIFICATION NO. : **BAP : FES: PG TEST 2016-17/01**

CONTENTS				
S.No.	Description	Section / Appendix No.	No. of Pages	Page Nos.
A.	PART - I (TECHNICAL BID)			
01.	SPECIAL INSTRUCTIONS TO TENDERERS	---	01	3
02.	NOTICE INVITING TENDER	---	03	4 – 6
03.	PROCEDURE FOR SUBMISSION OF SEALED TENDERS	---	01	7
04.	PROJECT INFORMATION	---	01	8
05.	TECHNICAL SPECIFICATION	Appendix-I	07	9 – 15
06.	Un-Price Bid (To be submitted along with technical Bid)		03	16 - 18
07.	GENERAL CONDITIONS OF THE CONTRACT	Section-I & II	18	19 - 36
08.	SPECIAL CONDITIONS OF THE CONTRACT		03	37 – 39
09.	STATUTORY REQUIREMENTS OF CONTRACT – ES:F:009 INCLUDING - OFFER OF CONTRACTOR - FORMAT FOR FURNISHING DETAILS OF TAX REGISTRATION ETC. (Appendix-II) - E-PAYMENT ACCEPTANCE FORMAT (Appendix-III)	---	11	40 – 49
10	Copy of Sample Performance Test Procedure referred in Clause 1.1 of Technical Specification		23	50-65
B.	PART - II (PRICE BID)			
10.	SCHEDULE OF RATES AND QUANTITIES		03	66 - 68

**BHARAT HEAVY ELECTRICALS LIMITED
BOILER AUXILIARIES PLANT
RANIPET – 632 406**

FES DEPARTMENT

SPECIAL INSTRUCTIONS TO TENDERER

1. This Booklet consists of the scope and bill of quantities of the entire work etc.
2. The Tenderers are requested to go through the instructions contained in the documents attached fully and then quote in the Rate Schedule attached.
3. Tenderers are advised to go through the General conditions of contract, special conditions of the contract, tender specifications etc. and fully understand the scope of work before quoting. Any doubt in the documents should be got clarified from FES Department of BHEL, Ranipet before submitting their offer.
4. Tenderers shall note that all the required Instrument (duly calibrated) will be provided by BHEL.
5. **No advance payment towards mobilization of site operation** or for any other purpose will be made by BHEL. The payment for work will be made strictly as per payment terms in the tender specification.
6. **The Tender Documents should be submitted duly signed and stamped in all the pages** of the Tender Specification, General conditions, special conditions, Annexures etc. by the Tenderer.
7. **All the resources required for completion of work has to be mobilized within 5 days from the date of intimation given by FES/BHEL through email and the scope of work in Conducting of Test is to be completed within the specified period.**
8. The undersigned is not bound to accept the lowest or any Tender and will have the right to reject any or all the Tenders without assigning any reason whatsoever.
9. Approval, if any, required from statutory authorities like Labor Commissioner, Electricity Board, etc., should be obtained by the tenderer on his own cost and risk.
10. These Tender Documents are not transferable.
11. Tender with all the required documents should be submitted so as to reach as per schedule given in the notice inviting tender and duly addressed to :

**ADDL. GENERAL MANAGER,
FES DEPARTMENT,
BHARAT HEAVY ELECTRICALS LIMITED,
BOILER AUXILIARIES PLANT,
RANIPET – 632 406.**
Phone No.:04172 - 241242 / 284318
E-mail: srkrishna@bhelrpt.co.in

BHARAT HEAVY ELECTRICALS LIMITED
BOILER AUXILIARIES PLANT, RANIPET- 632406.
FES DEPARTMENT

NOTICE INVITING TENDER

Sealed Tenders in TWO PARTS are invited from experienced bidders meeting Qualification Requirements (QR) for the work mentioned below. Points relevant to the tender are mentioned below and are to be complied with.

-
- 1 TENDER SPECIFICATION NO. : **BAP : FES: PG TEST 2016-17/01 Dated 16-Sept-2016**
 - 2 **NAME OF THE WORK** : Conducting Performance Guarantee Test in Electrostatic Precipitator (ESP) at various Power Plants as per laid down procedure. The objective is to determine the collection efficiency, pressure drop and auxiliary Power consumption of Electrostatic Precipitator. The collection efficiency to be calculated based on the dust concentrations at the inlet and outlet of precipitator. The scope of this work involves (A) Measurement of parameters like flue gas flow rate, flue gas temperature, dust concentration at the inlet & outlet of electrostatic precipitator, corona / auxiliary power measurements. (B) Providing of skilled man power for the above scope of work.
 - 3 **EARNEST MONEY DEPOSIT** : **Rs. 1,68,560/-** (Rupees One Lakh sixty eight thousand five hundred and sixty only)
 - 4 Tender specification documents : Attached .
 - 5 DUE DATE AND TIME FOR SUBMISSION OF OFFER : **02.12.2016** at 14.00 Hrs.
 - 6 DATE & TIME OF OPENING OF TECHNICAL BID: **02.12.2016** at 14.30 Hrs.
-
- 7 **EARNEST MONEY DEPOSIT (EMD)** : EVERY TENDER MUST BE ACCOMPANIED BY THE PRESCRIBED AMOUNT OF EARNEST MONEY DEPOSIT. EARNEST MONEY DEPOSIT (EMD) **shall be remitted along with the tender in the form of pay order or DEMAND DRAFT only drawn in favour of BHARAT HEAVY ELECTRICALS LIMITED payable at RANIPET.** EMD in the form of bank guarantee / fixed deposit receipt or in any other form **will not be accepted**, except by cash as detailed in Cl. 1.4.1.2 (Page 20)
 - 8 **Tender that is not accompanied by the requisite EMD amount is liable to be summarily rejected.**
 - 9 Tenderers whose technical bids are found acceptable to BHEL shall be intimated separately about the status of their offers. Date of price bid opening shall be intimated to the qualified bidders only.
 - 10 BHEL will not take any responsibility for delay/loss of documents or correspondence sent by courier/post.
 - 11 Acceptance of any tender shall be subject to the approval by BHEL's Customer.
 - 12 BHEL reserves the right to accept or reject any or all tenders without assigning any reasons whatsoever.
 - 13 All corrigenda, addenda, amendments, clarifications etc. to tender specification will be intimated through email/ letter with sufficient time for incorporation.
 - 14 BHEL reserves the right to reject any tender on the basis of unsatisfactory performance of the bidder in any on going job or any similar job in the past.

- 15 **QUALIFICATION CRITERIA: Pl. Ref Clause 2.10 of the Technical Specification. Besides the Bidder must satisfy the following Qualification Criteria for participating in the Tender.**
- 15.1 Experience of having successfully completed **either of the following similar works** during last 7 years ending last day of month (ie. 31-August-2016) previous to the one in which tenders are invited.
- 15.1.1 One similar completed works costing not less than the amount equal to Rs:7,05,664
(OR)
- 15.1.2 Two similar completed works costing not less than the amount equal to Rs:4,41,040
(OR)
- 15.1.3 Three similar completed works costing not less than the amount equal to Rs:3,52,832
- Note: The acceptable similar works are detailed in Clause 2.10 of the **Technical Specification**
- 16 The bidder has to submit supporting documents as called for in **Clause 2.10.a of the Technical Specification**
- 17 The bidders to note that possession of provident Fund (PF) code is not a pre-condition for participation in the tender. However, the successful bidder should ensure to get the PF code for the employees engaged for this work.
- 18 **Supporting documents for QR:** The bidder has to submit supporting documents as called for in **Clause 2.10 of the Technical Specification.**
- 19 **Seeking clarification on Tender Specification:** Clarifications on tender specification if any may be sought by the bidders so as to reach this office at least 3 days before the last date for tender submission. BHEL shall not be responsible for receipt of queries after the due date for seeking of clarification due to postal delay.
- 20 BHEL may decide holding a pre-bid conference (PBC) with any /all intending bidders. On such communication from BHEL, the bidder shall ensure participation in the same at the appointed time, date and place as may be decided by BHEL. Any clarification/query received after the pre-bid conference shall not be entertained.
- 21 All the information as called for in the various clauses and annexure of tender specification should be furnished. Please refer to the check list. The details so furnished should be complete in all respects and as per the formats prescribed in the Tender specification (Statutory requirement of Contract). The bidder may have to produce original documents for verification, if so decided by BHEL.
- 22 Offers received with any deviation or without relevant information are liable to be rejected.
- 23 Price bids received in any form other than prescribed in Part-II (PRICE BID) are liable to be rejected.
- 24 The tender offer should be kept valid for 18 Months from the date of bid opening for acceptance by BHEL. No unsolicited revision in the tender offer shall be entertained after opening of tenders and till expiry of the validity period.
- 25 **LIQUIDATED DAMAGES / Penalty:** To claim compensation for losses sustained including BHEL's supervision charges and overheads for completion on termination of contract and to impose penalty for delay in

- a. Organizing the facilities including man-power within 5 days of date of notification sent through email. Any delay will attract a penalty of Rs. 10,000/- per DAY of delay or part thereof applicable for the unit for which testing is done
and
- b. Completion of the work at the rate of Rs. 10,000/- per DAY of delay or part thereof, if the delay is not attributed to tenderer.

The Total penalty (25a & 25b as above) is subject to a ceiling of 10% of total contracted rate value for the particular unit for which test is done.

26 Discrepancy in Quoted Rates :

- a. If, in the price structure quoted, there is a discrepancy between the Unit rate quoted and the Total Price (which is obtained by multiplying the unit price by the quantity) due to arithmetical errors, the Unit rate quoted will be considered valid and the Total price will be corrected accordingly, unless in the opinion of BHEL there is an obvious misplacement of decimal point in the unit price. In which case the total price as quoted shall govern and the unit price corrected accordingly.
- b. If there is an error in total corresponding to the addition or subtraction of subtotals, the subtotals shall prevail and the total shall be corrected.
- c. If there is a discrepancy between words and figures, the amount in words shall prevail, unless the amount expressed in words is related to an arithmetic error, in which case the amount in figures shall prevail subject to (a) and (b) above.
- d. If there is such discrepancy in an offer, the same shall be conveyed to the bidder with target date before which the bidder has to send their acceptance on the above lines. If the bidder does not agree to the decision of BHEL, the bid is liable to be ignored.

27 For the purpose of the tender, the metric system of units shall be used.

28 All entries in the tender shall either be typed or be written in ink. Erasers and overwriting are not permitted and may render such tenders liable to summary rejection. All cancellations and insertions shall be duly attested by the bidder.

BHARAT HEAVY ELECTRICALS LIMITED
BOILER AUXILIARIES PLANT
RANIPET- 632406.
FES DEPARTMENT

PROCEDURE FOR SUBMISSION OF SEALED TENDERS

THE TENDERER MUST SUBMIT THEIR TENDER IN TWO PARTS IN SEPARATE SEALED COVERS PROMINENTLY SUPERSCRIBED AS PART-I TECHNICAL BID AND PART-II PRICE BID AND ALSO INDICATING ON EACH OF THE COVERS THE TENDER SPECIFICATION NUMBER AND DUE DATE AND TIME OF SUBMISSION AS MENTIONED IN THE TENDER NOTICE..

PART-I (TECHNICAL BID) COVER-I :

Excepting Rate Schedule, all other documents , data sheets, EMD, Un-priced copy of the Price Bid and details (duly signed on all pages with seal) called for in the specification shall be enclosed in Part-I “Technical Bid”.

PART-II (PRICE BID) COVER-II :

All indications of price shall be given in this part-II “Price Bid” only.

THESE TWO COVERS I & II (PART-I AND PART-II) SHALL TOGETHER BE ENCLOSED IN A **THIRD ENVELOPE (COVER-III)** ALONG WITH REQUISITE EMD AS MENTIONED IN THE NOTICE INVITING TENDER AND THIS SEALED COVER SHALL BE SUPERSCRIBED AND SUBMITTED TO AGM/FES AT THE ADDRESS GIVEN IN “Special Instructions to Tenderers” ON OR BEFORE THE DUE DATE.

TENDER SPECIFICATION NO. : BAP : FES: PG TEST 2016-17/01

PROJECT INFORMATION

1	Name of The Power Plant	As per the list attached
2	Place of the Power Plant	
3	Environment	Normal Thermal Plant conditions
4	Remarks	Before offering his/her/their tender, the Tenderer has to thoroughly acquaint with the site conditions with reference to Operating procedures inside the plant, HSE rules prevailing in the plant, site interference problems, movement of cranes / derricks etc. in the store yard / work site during material handling, erection etc. No compensation or revision of rates will be entertained at a later date for not having proper knowledge of the site conditions.

Technical Specification for conducting Performance Guarantee tests in Electrostatic Precipitators (ESP) at various power plants.

1.1 Introduction

ESP Performance guarantee test is to be conducted In Electro Static Precipitators (ESP) in various Thermal Power Plants as listed in Annexure (Page 07 of 07). Procedure for conduct of test is approved by BHEL's customers for the respective projects. (Sample procedure is attached). The collection efficiency is calculated based on the dust concentrations at the inlet and outlet of precipitator.

The objective of the performance guarantee test is to determine the collection efficiency, pressure drop and auxiliary Power consumption of Electrostatic Precipitator as per procedure.

This work involves (A) measurement of parameters like flue gas flow rate, flue gas temperature, dust concentration at the inlet & outlet of electrostatic precipitator, corona / auxiliary power measurements. (B) Providing of skilled man power for the above work and (C) Co-coordinating with the project in charges in accomplishment of the work.

1.2 Scope:

- i. Measurement of gas flow, temperature, inlet and outlet dust concentrations for computing of efficiency of ESP.
- ii. Measurement of corona / auxiliary power.

A typical 500 / 600 /800 MW unit ESP consists of 4 individual passes with each pass having 2 inlet ducts & 2 outlet ducts. Tests are normally conducted in each ESP separately with 4 sets of instruments simultaneously for 500 / 600 / 660 sets (2 each at inlet and outlet).

Following are the brief steps involved in the performance guarantee test.

- a) Inspection of all test location for approach, cleaning of test pockets, power supply, lighting arrangements.
- b) Assembling of Pitot tubes, thermocouples, sampling probes and marking of points.
- c) Testing of instruments – Vacuum pumps, manometers, thermocouples, temperature indicators, and gas meters. Check all the hose connections and arrest leakages in the instruments.
- d) Initial weighing of thimbles (filters) in laboratory as indicated in the procedure booklet.
- e) Measurement of velocity, pressure and temperature using Pitot, Manometer & thermocouple at each of the test location (duct). Duct is divided into grid points as shown in the attached typical drawings. Typically the measurements should be done in 36 grid points in each location of inlet and outlet. Accurate measurement is essential to arrive at gas flow. All the readings are recorded in a prescribed log sheet in the presence of customer representative. Intermediate calculation will be done during the test for arriving at isokinetic sampling rates.
- f) Measurement of dust concentration: sampling probe along with Thimble Sampling trains are used to sample flue gas at each location in approximately 36 grid points for about 3 minutes in each point. Thimbles are fixed in the sampling probe to filter the dust present in the sampled gas.
- g) The test location is located approximately at 23-25 meter elevation. The testing locations are in the ducts which are in open atmosphere.
- h) Test may be required to be done by at night hours also and have to work up to 12-13 hrs., per day during the test period.
- i) Typical inlet parameters is given below:

Rating	Gas flow in m ³ /Sec.,	Flue gas temperature in Deg C.	Dust concentration in gm/Nm ³ .
500 MW	800-900	120 -150	35-65
600 MW	900-1000	120 -150	45-50
700 MW	1000-1100	120 -150	50-55
800 MW	1000-1200	120 -150	50-55

Ambient temperature range: 27 Deg C to 45 Deg C

Technical Specification**j) Test duration:**

Approximate duration is given below:

Sl.	Activity	Appx. Duration	
		500 MW & above (Non-NTPC)	500 MW & above (NTPC)
1.	Assembly of test kits & checking, test pocket opening etc.,	2 days	2 days
2.	Preparation of thimbles, heating in oven, weighing etc.,	1 day	2 days
3.	Trial test	2 days	3 days
4.	Test	4 days	5 days
5.	Weighing of thimbles, final minutes	1 day	1 days
Total		10 days	13 days

For NTPC projects the time taken may be considered as 13 days and for NON-NTPC project it is 10days.

The period indicated is based on past experience only. However there may be delay or early completion possibilities depending on the site conditions like unit availability, full load operation, outages, etc., hence, the service provider has to take care of the additional extended period of 2 days for Non-NTPC and 3 days for NTPC projects. Beyond 2 days and 3 days of delay for Non-NTPC and NTPC projects respectively, compensation is applicable as indicated in Cl. 2.4.

1.3 Skills / Manpower requirement:

- a) Qualification: Diploma or Degree in Mechanical / Electrical Engg., 4 persons required for a typical 500 MW unit and above. Manpower availability should be able to cater atleast two PG tests at different places simultaneously.
- b) Should have experience in handling test equipment for flow and temperature measurement.
- c) Should have experience to troubleshoot the kit issues like leakages, electrical connection etc.,
- d) Effective communication skill.

1.4 BHEL Scope:

- a) Unskilled workers.
- b) Test instruments and its calibration.
- c) Consumables.
- d) Report preparation

1.5 The test procedure and readings ascertained is the property of BHEL and should not be used or divulged in any form of whatsoever in nature to anybody.**II. Commercial terms and conditions:**

2.1 Project details: List of projects for which tests to be conducted is given in annexure B. Out of these 15 sites will be selected for testing of 500 MW and above ESPs in Non-NTPC and 7 sites in NTPC category. The contractor should be in a position to depute the teams within 5 days.

2.2 Price: The offer shall be submitted in two parts viz. 1. Technical and 2. Commercial. The price quoted should indicate split up { as Part-(a) & Part-(b) } as given below:

2.2.1. Part (a): Manpower cost may be considered for 10 days for PG test at Non-NTPC projects and 13 days for NTPC projects at site excluding journey days. The charges should also include boarding, lodging, local conveyance and other incidentals for the test crew.

2.2.2 Part (b): It shall include all the charges for train / bus travel to & fro per trip, conveyance to reach destination, insurance, etc. that may be incurred by contractor and this cost should remain fixed irrespective of number days spent and project location. The rate has to be considered per trip only. If more than one unit has to be tested in the same site in single trip, the charges will be allowed per trip only and not based on number of units tested and accordingly payment will be processed. In case if more trips are required due to reasons not attributable to the contractor, payment will be made for such additional trips.

Technical Specification

- 2.3 PAYMENT TERMS:** All payments for the works completed shall be paid based on bills raised by the contractor as payment terms and certified by Engineer-in-Charge of BHEL. **Payment will be made within a period of 30 days from the date of submission of bills along with all the enclosures as called for by BHEL. Payment will be only through e-payment** (through electronic fund transfer (EFT) / RTGS) only after deducting Bank charges as per BHEL terms of payment indicated below.
- 2.4 Billing and payment:** The payment will be processed as given below:
- 80% charges after completion of test and balance 20 % after verification of all log sheets and documents for report preparation.
 - Income tax will be recovered as per rules.
 - Service tax will be reimbursed on producing proof of payment of Service Tax.
 - In case of stay at site is delayed beyond 2 days for Non NTPC projects, for reasons not attributable to the contractor, additional payment is admissible at pro-rata basis for the period from 13th day as per Clause II 2.2.1 Part (a) only, i.e. $(\text{Contracted rate}/10) \times \text{No. of days beyond } 12^{\text{th}} \text{ day}$.
In case of stay at site is delayed beyond 3 days for NTPC projects, for reasons not attributable to the contractor, additional payment is admissible at pro-rata basis for the period from 17th day as per Clause II 2.2.1 Part (a) only, i.e. $(\text{Contracted rate}/13) \times \text{No. of days beyond } 16^{\text{th}} \text{ day}$.
 - For Non-NTPC PG Tests: In case of completion of the test in the time period of 7 days to 10 days, the Contracted value will be paid without any deduction. And if the test is completed in less than 7 days, the payment will be made on pro-rata basis as $= (\text{WO-rate} / 10) \times (N + 3)$, where N = No. of days in which the work is completed.
 - For NTPC PG Tests: In case of completion of the test in the time period of 10 days to 13 days, the Contracted value will be paid without any deduction. And if the test is completed in less than 10 days, the payment will be made on pro-rata basis as $= (\text{WO-rate} / 13) \times (N + 3)$, where N = No. of days in which the work is completed.
 - Processing of bill will be admissible per unit basis for part (a) and per trip basis for part (b) in case of number of units tested is more than one in any single trip.
 - If the test is completed in more than one trip due to reasons not attributable to the contractor, part (a) payment will be based on cumulative days at site as per 2.4 d, e & f.
However the delay shall not be attributable to the contractor such as: Unit not running, sudden outage, Coal shortage, heavy rains delaying the tests, any other law and order issue, and customer constraints etc., the same shall be certified by BHEL engineer. Decision of BHEL will be binding on this.
- 2.5 Penalty:** Intimation regarding requirement of team will be communicated with notice period of 5 days through email. The contractor has to mobilize the requisite personnel at site. In case the contractor failed to mobilize it will attract a penalty of Rs. 10,000/- per day of delay (as per Cl.25 pg.5&6).
- 2.6 HEALTH, ENVIRONMENT AND SAFETY:** The tenderer shall acquire knowledge of prevailing rules and regulations pertaining to Health, Environment and Safety (HSE) procedures of respective power plants, project site rules, prevailing labour laws enforced by local authorities, labour regulations, movement of labour / vehicles inside the plant area, time keeping systems etc., in force and other local political conditions before submission of offer.
- 2.7** The contractor shall comply with all State/Central Laws, Statutory Rules, Regulations etc. inclusive of those regarding Labour and Industrial Laws which are applicable from time to time and shall comply with the provision of the same Labour Legislation, Rules and Regulations framed under the provision of Employees' Provident Fund and Miscellaneous Provision Act 1952, ESI registration, Labour License etc..
- 2.8** The tenderer shall specify the **Provident Fund Code / ESI Number** allotted to their firm by the Provident Fund authorities for engagement of labour for this tendered **work or otherwise shall obtain PF Code/ESI No. from respective Authorities** before finalization of the tender.

Technical Specification

2.9 The contractor also has to ensure that their personnel are adhering to local pre-cautions and do not cause any harmful to the plant.

2.10 Qualification requirement to participate in the tender including their experience in similar works includes:

- The parties should have experience in conducting of ESP or Boiler or Turbine or coal mills PG Tests in 2 coal based power plants.

Or

- Should have experience in carrying out particulate emission test at Chimneys or at ESP outlets confirming to EPA-17 or CPCB standards..

Or

- Should have working knowledge of ESPs and should have worked in the area of operation / commissioning / trouble shooting/ CFD analysis/ Flow modeling and testing of ESP for a minimum period of 2 years.

Or

- They should have worked in the fields controls and instrumentation/ electrical packages in power plants with BHEL sites

Important Note: Tenderer shall not be involved in design, manufacture and supply of ESP and should give undertaking for the same. If the tenderer is found to be involved in such activities later, BHEL has the right to reject them.

2.10. a. Supporting Documents for meeting qualification requirement:

- The copy of the PO bagged (within 7 Years) for the scope of work covered in clause 2.10 above
- Certificate/ Proof like protocol, MOM etc., for successful completion of the PG test.
- Proof for having worked in ESP/ thermal power plant controls and instrumentation/ electrical in a power plant for not less than 2 years.

BHEL will assess the qualification requirement and has the right to reject or admit any offer from contractor after evaluation.

2.11 Validity: The parties to quote for rate Schedules with a validity of 18 Months on Firm Price basis (no escalation is allowed). BHEL reserves the right to negotiate with L1 offered. In case the Bharat Heavy Electricals Limited calls for negotiations such negotiations shall not amount to cancellation or withdrawal of the original offer, which shall be binding on the bidders.

2.12 FIRM PRICE: The Contractor has to keep his quoted rates firm for the entire contractual period including total extended period, if any, and no claim for revision of rates or price escalation is allowed under any circumstances.

2.13 VARIATION IN QUANTUM OF WORK : The details of quantum of work are indicated in the rate schedule which is only approximate and is likely to vary to the extent required for the completion of the scope of work

2.14 BID EVALUATION: The offer submitted by bidders who meet the requisite Qualifying Requirements will be evaluated in two stages, namely Technical- Bid Evaluation and Price Bid Evaluation.

2.15 Bidders whose technical bids are found acceptable to BHEL shall be intimated separately about the status of their offers. Date of price bid opening shall be intimated to the qualified bidders only.

2.16 PRICE BID EVALUATION CRITERIA : The tender specifies 5 different Rate Schedules(R.S.). The successful bid shall be based only on the quoted value for the individual Rate Schedule in the sealed "Price bid" or RA, as applicable. The offers will be evaluated separately for each rate schedule and the L1 cases will be considered for evaluation independently for each case (5 different cases).

2.17 SPLITTING OF THE TENDER QTY:

1. The tendered qty. will be split among TWO bidders in the ratio of 3:1 for R.S. 1, 3:1 for R.S. 2, 3:2 for R.S. 3, 2:1 for R.S. 4, 4:2 for R.S. 5 to L1 and L2 (or other lower ranked bidder, in the order of ranking, who accept to the negotiated L1-rates).

2.18 EPF registration: Bidders should furnish the EPF code and registration details along with the bid. Bidders who have not registered and do not possess EPF code, if awarded the work, should immediately register and obtain the code.

Technical Specification

- 2.19** The offers of the bidders who are on the banned list as also the offer of the bidders, who engage the services of the banned firms, shall be rejected. The list of banned firms is available on BHEL web site “www.bhel.com”.
- 2.20** **TAXES AND DUTIES** : Rates quoted shall include all royalties, taxes, terminal taxes, Octroi, duties, Sales Tax on Works Contract, Entry Tax, Central or Provincial Excise Tax and other taxes (**except Service Tax**) leviable under the state and the central Government Rules. BHEL will not entertain any claim whatsoever in this respect. No reimbursement on account of increase in rate of existing levies shall be made.
- 2.21** The Bidder shall not include Service Tax in their Quoted rates; but the Bidder has to separately indicate the Service Tax Rate, Amount and the Workings thereof in the Price Bid schedule included in the bid documents. If the Service Tax amount is not indicated separately, in the price bid schedule, included in the bid-documents, it will be presumed that the quoted rate is inclusive of the applicable Service Tax and bids will be evaluated accordingly. The successful bidder shall register themselves with the service tax authority and pay separately the Service Tax as applicable to this contract during execution of the work and get it reimbursed at actuals by BHEL by submitting necessary invoices / documentary proof as required by BHEL.
- 2.22** **Pure Service not involving any supply of material by contractor:** Bidders have to quote the applicable Service Tax payable in the Price-bid Format included in the bid document which shall be considered for evaluation. The same shall be considered for reimbursement against valid documentary evidence to successful bidders.
- 2.23** **The following documents shall be submitted while claiming service tax:**
1. Copy of Service Tax Registration certificate
 2. Copies of Challan for deposit of Service Tax
 3. A certificate from the service provider that tax collected from BHEL has been remitted to tax authorities.
- 2.24** **Procedure for reimbursement of Service Tax:** The service tax claimed in the first Running Account Service Invoice will be paid by BHEL. For subsequent invoices, Service Tax amounts will be paid only on production of proof for having remitted the previous service tax amounts paid by BHEL.
- 2.25** **The tenderer has to furnish information called for in the APPENDIX-I & II attached with this booklet.** The details pertaining to the Bank Accounts where proceeds will be transferred through BHEL's Banker is to be furnished.
- 2.26** Copies of EPF remittance challans, ESI / Insurance remittances, Wage register, attendance register etc of the workers pertaining to the site of work and period applicable shall be attached to every bill submitted, failing which bills will not be processed. Copies of half yearly and annual EPF returns for the workers have also to be submitted, if required.
- 2.27** **RIGHTS OF BHEL IN CASE OF POOR PROGRESS OF WORK:** To get the work done through other agencies at the risk and cost of the contractor, in the event of contractor's poor progress or inability to execute work, persistent disregard to instructions of BHEL, assignment transfer, subletting of contract without the permission of BHEL, non-fulfillment of any contractual obligation etc., and to recover compensation for such losses from the contractor including BHEL's supervision charges and overheads from the security deposit / other dues.
- 2.28** The manpower provided shall be capable of carrying out the assigned work to the satisfaction of BHEL. BHEL reserves the right to decide on the suitability of the personnel deployed and insist on removal of any employee found unsuitable for the work assigned. The contractor shall forthwith arrange for replacement.
- 2.29** THE CONTRACTOR SHALL STRICTLY ABIDE BY THE STATE AND CENTRAL LAWS, STATUTORY RULES, REGULATIONS ETC. AS INDICATED IN THE GCC AND OTHER SECTIONS OF THE SPECIAL CONDITIONS OF CONTRACT. IN ADDITION THE CONTRACTOR SHALL HAVE TO COMPLY WITH PROFESSIONAL TAX / AND PF /ESI/ LABOUR LICENCE REGULATIONS FOR ALL HIS EMPLOYEES / WORKMAN AS PER THE LOCAL AUTHORITIES / GOVERNING BODIES INSTRUCTIONS.

Technical Specification

- 2.30 Benefits to Micro, Small & Medium Enterprises (MSE) :** Guidelines of the Govt. of India shall be followed to provide benefits to MSE. MSE suppliers can avail the intended benefits only if they submit along with offer, attested copies of either EM-II certificate having deemed validity (Two years from the date of issue of acknowledgement in EM-II) or valid NSIC certificate or EM-II certificate along with CA certificate (Format enclosed as per Appendix – IV) applicable for the year, certifying quantum of investment in plant and machinery within the permissible limit as per the act for relevant status (Micro or small) where the deemed validity of EM-II is over. Date to be reckoned for determining the deemed validity will be the last date of technical bid submission. Non submission of such documents will lead to consideration of their bids at par with other bidders and MSE status of such suppliers shall be shifted to Non MSE supplier till the supplier submits these documents
- 2.31 ORDER OF PRECEDENCE:** In the event of any ambiguity or conflict between the clauses / statements in Tender Documents, the order of precedence shall be in the order below.
- a. Amendments / clarifications / corrigenda / errata etc. issued.
 - b. Notice Inviting Tender (NIT)
 - c. Price Bid
 - d. Technical Specification & scope of work
 - e. Special Conditions of Contract
 - f. General Conditions of Contract
 - g. Forms & Procedures
- 2.32** In the event of any conflict between requirements of a clause/s of this specification /documents/drawings/data sheets etc. and different standards / codes specified, the same is to be brought to the notice of BHEL before submission of offer, else BHEL's interpretation shall prevail.
- 2.33** Typographical error/missing pages/other errors in the tender documents noticed, must be brought to the knowledge of BHEL in writing before submission of offer, else BHEL's interpretation shall prevail.

List of Units, where the PG Test is to be conducted:

<p style="text-align: center;"><u>Cluster-I (Non-NTPC)</u></p> <p>1.Lalitpur-(2 units) 2.JP Nigrie-(2 units) 3.Anpara D-(2 units) 4. Bara</p> <p style="text-align: center;"><u>Cluster-I (NTPC)</u></p> <p>1.Vindhyaachal-(3 units) 2.Rihand-(3 units) 3.Jhajar-(3 units)</p>	<p style="text-align: center;"><u>Cluster-II (Non-NTPC)</u></p> <p>1.Derang-(2 units) 2.DB Power-(2 units) 3.Bokaro 4.Marwa-(2 units) 5.JPL, Raigarh 6.Sree Singajee, Malwa-(2 units) 7.Chandrapur-(2 units) 8. Sholapur-(2 units) 9. Sagardighi</p> <p style="text-align: center;"><u>Cluster-II 8(NTPC)</u></p> <p>1.Barh-(2 units) 2.Kahalgaon 3.Mauda-(2 units) 4.Talcher Kaniha R&M-(2 units) 5.Lara-(2 units) 6.Darlipalli-(2 units)</p>
<p style="text-align: center;"><u>Cluster-III (Non-NTPC)</u></p> <p>1.Krishnapatnam 2.Kakatiya 3.Bellary 4.Yermaras-(2 units) 5.Tuticorin-(2 units) 6.HNPCL, Vizag-(2 units) 7.SCCL, Singereni-(2 units) 8.Rayalaseema RTPP 9. IB Valley-(2 units)</p>	

TENDER DOCUMENT (TENDER SPECN No : BAP : FES: PG TEST 2016-17/01)**Un-price-Bid** to be submitted along with Part-I ie. Technical Bid

(The Rate of Service Tax alone is to be filled in this copy)

Name Of Work : (For Detailed Scope Of Work Please Refer The Tender Specification.)

NAME OF WORK: Conducting Performance Guarantee Test in Electrostatic Precipitator (ESP) at various Power Plants as per laid down procedure. The objective is to determine the collection efficiency, pressure drop and auxiliary Power consumption of Electrostatic Precipitator. The collection efficiency to be calculated based on the dust concentrations at the inlet and outlet of precipitator. The scope of this work involves (A) Measurement of parameters like flue gas flow rate, flue gas temperature, dust concentration at the inlet & outlet of electrostatic precipitator, corona / auxiliary power measurements. (B) Providing of skilled man power for the above scope of work.

Rate Sch. No.	RS Description	Qty	Unit	Rate In Rs.	Total rate in Rs.
1A (Part-A)	Man Power Cost as detailed in Cl. 2.2.1 (page 10) for Conducting of PG Tests at a Non-NTPC Unit (Having 4 ESPs) of 500MW rating and above in Cluster-I.	4	Rate as per part (A)	Quoted	Quoted
1B (Part-B)*	To & Fro Conveyance as detailed in Cl.2.2.2 (page 10) for Conducting of PG Tests at a Non-NTPC Unit (Having 4 ESPs) of 500MW rating and above in Cluster-I.	4	Rate as per part (B)	Quoted	Quoted
	Total (1A + 1B) in Cluster-I	4	(A)+(B)	Quoted	Quoted
	% of Service Tax Payable extra If any for Part-A+B in Cluster-I	%		Quoted	Quoted
	Total (1A + 1B) inclusive of Service Tax for A in Cluster-I	4		Quoted	Quoted

Rate Sch. No.	RS Description	Qty	Unit	Rate In Rs.	Total rate in Rs.
2A (Part-A)	Man Power Cost as detailed in Cl. 2.2.1 (page 10) for Conducting of PG Tests at a NTPC Unit (Having 4 ESPs) of 500MW rating and above in Cluster-I.	4	Rate as per part (A)	Quoted	Quoted
2B (Part-B)*	To & Fro Conveyance as detailed in Cl.2.2.2 (page 10) for Conducting of PG Tests at a NTPC Unit (Having 4 ESPs) of 500MW rating and above in Cluster-I.	4	Rate as per part (B)	Quoted	Quoted
	Total (2A +2B) in Cluster-I	4	(A)+(B)	Quoted	Quoted
	% of Service Tax Payable extra If any for Part-A+B in Cluster-I	%		Quoted	Quoted
	Total (2A + 2B) inclusive of Service Tax for A in Cluster-I	4		Quoted	Quoted

Note: * Part-B includes fixed To and fro charges only and is expected to be same for both NTPC and Non-NTPC projects for each cluster.

**SIGNATURE OF THE
CONTRACTOR WITH SEAL**

TENDER DOCUMENT (TENDER SPECN No : BAP : FES: PG TEST 2016-17/01)**Un-price-Bid** to be submitted along with Part-I ie. Technical Bid

(The Rate of Service Tax alone is to be filled in this copy)

Name Of Work : (For Detailed Scope Of Work Please Refer The Tender Specification.)

NAME OF WORK: Conducting Performance Guarantee Test in Electrostatic Precipitator (ESP) at various Power Plants as per laid down procedure. The objective is to determine the collection efficiency, pressure drop and auxiliary Power consumption of Electrostatic Precipitator. The collection efficiency to be calculated based on the dust concentrations at the inlet and outlet of precipitator. The scope of this work involves (A) Measurement of parameters like flue gas flow rate, flue gas temperature, dust concentration at the inlet & outlet of electrostatic precipitator, corona / auxiliary power measurements. (B) Providing of skilled man power for the above scope of work.

Rate Sch. No.	RS Description	Qty	Unit	Rate In Rs.	Total rate in Rs.
3A (Part-A)	Man Power Cost as detailed in Cl. 2.2.1 (page 10) for Conducting of PG Tests at a Non-NTPC Unit (Having 4 ESPs) of 500MW rating and above in Cluster-II.	5	Rate as per part (A)	Quoted	Quoted
3B (Part-B)*	To & Fro Conveyance as detailed in Cl.2.2.2 (page 10) for Conducting of PG Tests at a Non-NTPC Unit (Having 4 ESPs) of 500MW rating and above in Cluster-II.	5	Rate as per part (B)	Quoted	Quoted
	Total (3A + 3B) in Cluster-II	5	(A)+(B)	Quoted	Quoted
	% of Service Tax Payable extra If any for Part-A+B in Cluster-II	%		Quoted	Quoted
	Total (3A + 3B) inclusive of Service Tax for A in Cluster-II	5		Quoted	Quoted

Rate Sch. No.	RS Description	Qty	Unit	Rate In Rs.	Total rate in Rs.
4A (Part-A)	Man Power Cost as detailed in Cl. 2.2.1 (page 10) for Conducting of PG Tests at a NTPC Unit (Having 4 ESPs) of 500MW rating and above in Cluster-II	3	Rate as per part (A)	Quoted	Quoted
4B (Part-B)*	To & Fro Conveyance as detailed in Cl.2.2.2 (page 10) for Conducting of PG Tests at a NTPC Unit (Having 4 ESPs) of 500MW rating and above in Cluster-II	3	Rate as per part (B)	Quoted	Quoted
	Total (4A + 4B) in Cluster-II	3	(A)+(B)	Quoted	Quoted
	% of Service Tax Payable extra If any for Part-A+B in Cluster-II	%		Quoted	Quoted
	Total (4A + 4B) inclusive of Service Tax for A in Cluster-II	3		Quoted	Quoted

Note: * Part-B includes fixed To and fro charges only and is expected to be same for both NTPC and Non-NTPC projects for each cluster.

**SIGNATURE OF THE
CONTRACTOR WITH SEAL**

TENDER DOCUMENT (TENDER SPECN No : BAP : FES: PG TEST 2016-17/01)**Un-price-Bid** to be submitted along with Part-I ie. Technical Bid

(The Rate of Service Tax alone is to be filled in this copy)

Name Of Work : (For Detailed Scope Of Work Please Refer The Tender Specification.)

NAME OF WORK: Conducting Performance Guarantee Test in Electrostatic Precipitator (ESP) at various Power Plants as per laid down procedure. The objective is to determine the collection efficiency, pressure drop and auxiliary Power consumption of Electrostatic Precipitator. The collection efficiency to be calculated based on the dust concentrations at the inlet and outlet of precipitator. The scope of this work involves (A) Measurement of parameters like flue gas flow rate, flue gas temperature, dust concentration at the inlet & outlet of electrostatic precipitator, corona / auxiliary power measurements. (B) Providing of skilled man power for the above scope of work.

Rate Sch. No.	RS Description	Qty	Unit	Rate In Rs.	Total rate in Rs.
5A (Part-A)	Man Power Cost as detailed in Cl. 2.2.1 (page 10) for Conducting of PG Tests at a Non-NTPC Unit (Having 4 ESPs) of 500MW rating and above in Cluster-III.	6	Rate as per part (A)	Quoted	Quoted
5B (Part-B)*	To & Fro Conveyance as detailed in Cl.2.2.2 (page 10) for Conducting of PG Tests at a Non-NTPC Unit (Having 4 ESPs) of 500MW rating and above in Cluster-III.	6	Rate as per part (B)	Quoted	Quoted
	Total (5A + 5B) in Cluster-III.	6	(A)+(B)	Quoted	Quoted
	% of Service Tax Payable extra If any for Part-A+B in Cluster-III.	%		Quoted	Quoted
	Total (5A + 5B) inclusive of Service Tax for A in Cluster-III.	6		Quoted	Quoted

Note: * Part-B includes fixed To and fro charges only and is expected to be same for both NTPC and Non-NTPC projects for each cluster.

**SIGNATURE OF THE
CONTRACTOR WITH SEAL**



Bharat Heavy Electricals Limited
Boiler Auxiliaries Plant, Ranipet –632 406
FIELD ENGG. SERVICES DEPARTMENT

GENERAL CONDITIONS OF CONTRACT
ES : F : 010

Page No.: 01 of 18

GENERAL CONDITIONS OF CONTRACT

FOR

WORKS

(SECTION – I & II)

ES : F : 010



FIELD ENGG. SERVICES DEPARTMENT

BHARAT HEAVY ELECTRICALS LIMITED

(A Government of India Undertaking)

BOILER AUXILIARIES PLANT

INDIRA GANDHI INDUSTRIAL COMPLEX

RANIPET – 632 406

 Ranipet	Bharat Heavy Electricals Limited Boiler Auxiliaries Plant, Ranipet –632 406 FIELD ENGG. SERVICES DEPARTMENT	GENERAL CONDITIONS OF CONTRACT ES : F : 010
Page No.: 02 of 18		
SECTION –I		
<p>1. GENERAL INSTRUCTIONS TO BIDDERS</p> <p>1.1. DESPATCH INSTRUCTIONS:</p> <p>1.1.1. This tender specification as a whole, duly furnishing all the details required and other documents as required in the following pages, shall be duly signed and sent in a sealed cover duly super scribing the name of work as given in the tender notice.</p> <p>1.1.2. The tender shall be addressed to Officer inviting tender as indicated in the tender notice.</p> <p>1.1.3. Tenders submitted by post shall be sent by “REGISTERED POST WITH ACKNOWLEDGEMENT DUE” and shall be posted with the due allowance for any postal delay. The tenders received after the due date and time of opening are liable to be rejected. Telegraphic offers and offers received by telex may not be considered.</p> <p>1.1.4. Tenders shall be opened by authorized officer of BHEL at his office at the time and date as specified in the tender notice in the presence of such of those bidders or their authorized representatives who may be present.</p> <p>1.1.5. The Tenders shall closely pursue all the clauses, specifications and drawings indicated in the tender documents before quoting. Should the bidder have any doubt in the meanings of any portion of the tender specification or find discrepancies or omission in the drawings or the tender documents issued are in complete or shall require clarification on any of the technical aspect, scope of work etc., he shall at once contact the authority inviting the tender for clarification before the submission of the tender.</p> <p>1.1.6. Before tendering, the bidders are advised to inspect the site of work and the environments and be well acquainted with the actual working and other prevalent conditions, facilities available, position of material and labour. No claim will be entertained later, on the ground of lack of knowledge.</p> <p>1.1.7. Bidder must fill up all the schedules and furnish all the required information as per the instructions given in various sections of the tender specification. Each and every page of the Tender Specification must be signed and submitted along with the offers by the bidder in token of complete acceptance thereof. The information furnished shall be complete by itself.</p> <p>1.1.8. The bidders shall quote the rates in English language and international numerals. These rates shall be entered in figures as well as in words.</p> <p>1.1.9. Discrepancy in Quoted Rates :</p> <p>1.1.9.1. If, in the price structure quoted, there is a discrepancy between the Unit rate quoted and the Total Price (which is obtained by multiplying the unit price by the quantity) due to arithmetical errors, the Unit rate quoted will be considered valid and the Total price will be corrected accordingly, unless in the opinion of BHEL there is an obvious misplacement of decimal point in the unit price. In which case the total price as quoted shall govern and the unit price corrected accordingly.</p> <p>1.1.9.2. If there is an error in total corresponding to the addition or subtraction of subtotals, the subtotals shall prevail and the total shall be corrected.</p> <p>1.1.9.3. If there is a discrepancy between words and figures, the amount in words shall prevail, unless the amount expressed in words is related to an arithmetic error, in which case the amount in figures shall prevail subject to (a) and (b) above.</p> <p>1.1.9.4. If there is such discrepancy in an offer, the same shall be conveyed to the bidder with target date before which the bidder has to send their acceptance on the above lines. If the bidder does not agree to the decision of BHEL, the bid is liable to be ignored.</p> <p>1.1.10. For the purpose of the tender, the metric system of units shall be used.</p> <p>1.1.11. All entries in the tender shall either be typed or be written in ink. Erasers and overwriting are not permitted and may render such tenders liable to summary rejection. All cancellations and insertions shall be duly attested by the bidder.</p> <p>1.2. QUALIFICATION OF BIDDERS: Only bidders who have previous experience in the work of this nature and description detailed in this tender specification are expected to quote for this work duly submitting details of experience along with the offer. Offers from bidders who do not have proven and established experience in the field are not likely to be considered.</p>		

 Ranipet	Bharat Heavy Electricals Limited Boiler Auxiliaries Plant, Ranipet –632 406 FIELD ENGG. SERVICES DEPARTMENT	GENERAL CONDITIONS OF CONTRACT
		ES : F : 010
		Page No.: 03 of 18
SECTION –I		
<p>1.3. DATA TO BE ENCLOSED: Full information shall be given by the bidder in respect of the following. Non- submission of these information may lead to rejection of the offer.</p> <p>1.3.1. FINANCIAL STATUS: A certificate from Scheduled Bank to prove his financial capacity to undertake the work duly indicating financial limits the bidder enjoys or solvency certificate from the concerned Government authority. Informations required in Annexure A (pl.ref. Page 09 of 11 of statutory Requirement); shall be furnished by the bidder along with the offer.</p> <p>1.3.2. INCOME TAX CERTIFICATE: A certificate of Income Tax clearance (A copy of the audited Balance Sheet, Profit and Loss Account & Income Tax return -filed for the last Three years to be submitted) from the appropriate authority in the forms prescribed there for indicating annual turnover and the Sales Tax clearance certificate from the appropriate authorities as prescribed by the concerned state government, if any. These certificates shall be valid for one year from the date of issue or for the period prescribed therein for all tenders submitted during the period.</p> <p>1.3.3. PREVIOUS EXPERIENCE: A statement giving particulars duly supported by documentary evidence of the various services rendered for each similar work by the bidder indicating the particulars, value of each work, the site location, the duration, date of completion, a list of site locations and particulars and value of various services that are under progress. Information required in Annexure –BI & BII shall be furnished by the bidders along with the offer.</p> <p>1.3.4. ORGANISATION CHART: The Organisation pattern that is presently available with the bidder and that will be employed by the bidder for this work shall be furnished.</p> <p>1.3.5. An attested copy of the Power of Attorney, in case the tender is signed by an individual other than the sole proprietor, shall also be attached. (If it is a Company or Firm, etc., Director/Managing Partner as the case may be is required to sign)</p> <p>1.3.6. IN CASE OF AN INDIVIDUAL: His full name, address and place and nature of business shall be indicated.</p> <p>1.3.7. IN CASE OF PARTNERSHIP FIRMS: The names of all the partners and their addresses be furnished along with a copy of the partnership deed/instrument of partnership duly certified by Notary Public shall be enclosed.</p> <p>1.3.8. IN CASE OF COMPANIES: Date and place of registration including date of commencement certificate in case of public companies (certified copies of Memorandum and Articles of Association are also to be furnished) are to be furnished.</p> <p>1.3.9. Nature of business carried on by the Company and the provisions of the Memorandum relating there of shall be furnished.</p> <p>1.3.10 Names and particulars including addresses of the Directors and their previous experiences shall be furnished.</p> <p>1.3.11 A list of tools and tackles that the bidder is having and those that will be used on this job shall be furnished.</p> <p>1.3.12 In addition to the above, the particulars required in various annexure shall also be furnished.</p> <p>EARNEST MONEY DEPOSIT:</p> <p>1.4.1. Every tender must be accompanied by the prescribed amount of Earnest Money Deposit in any one of the following forms.</p> <p>1.4.1.1. EMD shall be deposited in cash (as permissible under income tax act), Payorder or Demand Draft (payable at Ranipet in favour of “Bharat Heavy Electricals Ltd.,”) only. No other form of EMD remittance shall be acceptable to BHEL.</p>		

 Ranipet	Bharat Heavy Electricals Limited Boiler Auxiliaries Plant, Ranipet –632 406 FIELD ENGG. SERVICES DEPARTMENT	GENERAL CONDITIONS OF CONTRACT ES : F : 010 Page No.: 04 of 18
SECTION –I		
<p>1.4.1.2. In case of payment of EMD in the form of Cash, as admissible under Income tax act, the amount should be remitted by the bidder to the Cash Office of Bharat Heavy Electricals Limited, BAP,Ranipet-632 406 during it's working hours and cash receipt issued shall be enclosed along with the tender.</p> <p>1.4.2. Tenders received without Earnest Money in full in the manner prescribed above are liable to be rejected.</p> <p>1.4.3. The Earnest Money Deposit of the successful tenders may be retained towards part of Security Deposit.</p> <p>1.4.4. In the case of unsuccessful bidders, the Earnest Money will be refunded to them within a reasonable time after finalisation of the tender.</p> <p>1.4.5. Earnest Money Deposit by the bidder will be forfeited as per tender documents if the bidder:</p> <p>1.4.5.1. Fails to communicate unqualified acceptance of Letter of Intent within 15 days of date of Letter of Intent.</p> <p>1.4.5.2. Does not commence the work within the period as per LOI/Contract. In case the LOI/Contract is silent in this regard then within fifteen days after award of contract.</p> <p>1.4.5.3. After opening of Tender, revokes/withdraws his tender within the validity period or revises/alters his earlier quoted rates/conditions.</p> <p>1.4.5.4. Fails to submit SD as indicated in the Letter of Intent.</p> <p>1.4.6. Earnest Money deposit shall not carry any interest.</p> <p>1.5. AUTHORISATION AND ATTESTATION:</p> <p>1.5.1. Tenders shall be signed by persons duly authorized /empowered to do so. Certified copies of such authority and relevant documents shall be submitted along with the tenders.</p> <p>1.6. VALIDITY OF OFFER: The rates in the Tender shall be kept open for acceptance for a minimum period of 18 months from the date of opening of tenders. In case the Bharat Heavy Electricals Limited calls for negotiations such negotiations shall not amount to cancellation or withdrawal of the original offer , which shall be binding on the bidders.</p> <p>1.7. EXECUTION OF CONTRACT: The successful bidder's responsibility under this contract commences from the date of issue of the Letter of Intent by Bharat Heavy Electricals Limited. The successful bidder shall be required to execute an agreement in the prescribed form (Annexure-D) with BHEL within a reasonable time after the acceptance of his tender and in any case before submitting the first bill for payment. The expenses for completion, stamping and registration of the agreement with prescribed authority, if necessary, shall be borne by the Contractor.</p> <p>1.8. SECURITY DEPOSIT:</p> <p>1.8.1. Upon acceptance of tender, the successful bidder within the time specified in the letter of intent must deposit the required amount of Security Deposit for satisfactory execution of work and shall not commence work under this contract before remitting security deposit except as directed by BHEL. The total amount of Security Deposit will be 5% of the contract value. EMD of the successful tenderer shall be converted and adjusted towards the required amount of Security Deposit.</p> <p>1.8.2. The Security Deposit may be furnished in any one of the following forms:-</p> <p>i) Cash (as permissible under the extant Income Tax Act)</p> <p>ii) Local cheques of Scheduled Banks (subject to realization)/ Pay Order/ Demand Draft/ Electronic Fund Transfer in favour of BHEL</p> <p>iii) Bank Guarantee from Scheduled Banks/ Public Financial Institutions as defined in the Companies Act. The Bank Guarantee format should have the approval of BHEL (Annexure-E). The Bank Guarantee furnished towards Security Deposit should be kept valid by proper renewal till the expiry of 6 Months after the said work is actually completed.</p> <p>iv) Fixed Deposit Receipt issued by Scheduled Banks/ Public Financial Institutions as defined in the Companies Act (FDR should be in the name of the Contractor, a/c BHEL)</p> <p>v) Securities available from Indian Post offices such as National Savings Certificates, Kisan Vikas Patras etc. (held in the name of Contractor furnishing the security and duly endorsed/ hypothecated/ pledged, as applicable, in favour of BHEL)</p> <p>(Note: BHEL will not be liable or responsible in any manner for the collection of interest or renewal of the documents or in any other matter connected therewith)</p>		

 Ranipet	Bharat Heavy Electricals Limited Boiler Auxiliaries Plant, Ranipet –632 406 FIELD ENGG. SERVICES DEPARTMENT	GENERAL CONDITIONS OF CONTRACT ES : F : 010
		Page No.: 05 of 18
SECTION –I		
<p>1.8.2.1. Security deposit can also be recovered at the rate of 10% from the running bills. However in such cases atleast 50% of the security deposit should be remitted before start of the work and balance 50% may be recovered from the running bills till the full Security Deposit is made up.</p> <p>1.8.2.2. EMD of the successful bidder may be converted and adjusted against the security deposit on specific request by the contractor.</p> <p>1.8.2.3. Acceptance of security deposit will be subject to hypothecation or endorsement on the documents in favour of BHEL. However, BHEL will not be liable or responsible in any manner for the collection of interest or renewal of the documents or in any other matter connected therewith.</p> <p>1.8.4. If the value of the work done at any time exceeds the accepted agreement value, the security Deposit shall be correspondingly enhanced and the extra Security Deposit shall be immediately deposited by the Contractor or recovered from payments due to him.</p> <p>1.8.5 Failure to deposit the Security Deposit within the stipulated time, may lead to forfeiture of Earnest Money and cancellation of the award of work.</p> <p>1.8.6 If any part of Security Deposit of the Contractor is held in the form of approved securities it shall be kept transferred in the name of Bharat Heavy Electricals Limited, Ranipet, in such a manner that the same can be realized fully without referring to the Contractor, BHEL shall not be responsible for any depreciation in the value of the Security while in BHEL's custody or for any loss of interest thereon.</p> <p>1.8.7 BHEL reserves the right to forfeiture of Security Deposit in addition to the other claims and penalties in the event of the Contractor's failure to fulfill any of the Contractual obligation including liquidation or bankruptcy of the contractor, non-payment of money payable by means of arbitration award in favour of BHEL or in the event of termination of Contract as per terms and conditions of Contract. BHEL reserves the right to set off the Security Deposit, against any claims of any other contracts with BHEL.</p> <p>1.8.8 RETURN OF SECURITY DEPOSIT: If the Contractor performs and completes the work in all respects to the entire satisfaction of BHEL and presents an absolute "No Demand Certificate" in the prescribed form (Annexure-F) and returns properties belonging to BHEL handed over, lent or hired by him for carrying out the said works, Security Deposit will be released to the Contractor after deducting all cost of expenses or other amounts that are to be paid to BHEL under this or other contracts entered into with the Contractor. It may be noted that in no case the Security Deposit shall be refunded/released prior to passing of final bill.</p>		
<p>1.9. REJECTION OF TENDER AND OTHER CONDITIONS</p>		
<p>1.9.1. The acceptance of Tender will rest solely with BHEL which does not bind itself to accept the lowest tender or any tender and reserves to itself full rights for the following without assigning any reasons whatsoever.</p> <p>1.9.1.1. To reject any or all of the bidders.</p> <p>1.9.1.2. To split up the work amongst two or more Bidders.</p> <p>1.9.1.3. To award the work in part.</p> <p>1.9.1.4. Either of the contingencies stated in (1.9.1.2) and (1.9.1.3) above to modify the time for completion suitably.</p>		

 Ranipet	Bharat Heavy Electricals Limited Boiler Auxiliaries Plant, Ranipet –632 406 FIELD ENGG. SERVICES DEPARTMENT	GENERAL CONDITIONS OF CONTRACT ES : F : 010 Page No.: 06 of 18
SECTION –I		
<p>1.9.1. Conditional and Unwitnessed tenders, tenders containing absurd or unworkable rates and amounts and tenders which are incomplete and otherwise considered defective and tenders not in accordance with the tender conditions, specifications, etc., are liable to be rejected.</p> <p>1.9.2. If a bidder expires after the submission of his/her tender or after the acceptance of his/her tender, BHEL may at their discretion cancel such tender. If a partner of a firm expires the submission of the tender or after the acceptance of the tender, BHEL may cancel such tender at their discretion unless the firm retains its character.</p> <p>1.9.3. BHEL will not be bound by any power of Attorney granted by the bidder or by changes in the composition of the firm made subsequent to the execution of the Contract. They may, however recognize such power of Attorney and changes after obtaining proper legal advice, the cost of which will be chargeable to the contractor concerned.</p> <p>1.9.4. If the bidder deliberately gives wrong information in his tender, BHEL reserves the right to reject such tender at any stage or cancel the contract, if awarded. The Earnest Money/Security Deposit /any other money due shall also be forfeited.</p> <p>1.9.5. Canvassing in any form in connection with the tender is strictly prohibited and the tenders submitted by the contractors who resort to canvassing in any form are liable to rejection.</p> <p>1.9.6. Should a bidder or contractor or in the case of a firm or company of contractors one or more of its partners/share holders/Directors have a relation or relations employed in BHEL, the authority inviting tender shall be informed of the fact along with the offer, failing this BHEL may, at its sole discretion reject the tender or cancel the contract and forfeit the Earnest Money/Security Deposit.</p> <p>1.9.7. The successful bidder should not sub-contract the part or complete work detailed in the tender specification undertaken by him without written permission of BHEL. The bidder is solely responsible to BHEL for the work awarded to him.</p> <p>1.9.8. No deviation from the tender specification shall be acceptable to BHEL. Bidders shall confirm their unqualified acceptance of the terms and conditions by giving an undertaking to this effect in a separate letter as specified by BHEL.</p> <p>1.10. NO INTEREST shall be payable by BHEL on Earnest Money or Security Deposit, if applicable, or any money due to the Contractor by BHEL.</p> <p style="text-align: center;">-----</p>		

 Ranipet	Bharat Heavy Electricals Limited Boiler Auxiliaries Plant, Ranipet –632 406 FIELD ENGG. SERVICES DEPARTMENT	GENERAL CONDITIONS OF CONTRACT ES : F : 010
		Page No.: 07 of 18
SECTION –II		
<p>2.1. DEFINITION: The following terms shall have the meaning hereby assigned to them except where the context otherwise requires.</p> <p>2.1.1. BHEL or (B.H.E.L Ltd) shall mean Bharat Heavy Electricals Limited a Company registered under Indian Companies Act 1956, with its Registered Office at BHEL House, Siri fort, New Delhi 110 049 or its Authorised Officers or its Resident Engineer or other employees authorized to deal with any matters with which these persons are concerned on its behalf.</p> <p>2.1.2. “GENERAL MANAGER” shall mean the Officer in Administrative charges of contracting unit of BHEL.</p> <p>2.1.3. “ENGINEER” or “ENGINEER IN CHARGE” shall mean Engineer who is in-charge for the works referred in Erection Services. The term also includes PROJECT MANAGER, “RESIDENT MANAGER” “SITE ENGINEER “ “ RESIDENT MANAGER” and “ASSISTANT SITE ENGINEER “ of BHEL at the site as well as the Officers in-charge at Head Office.</p> <p>2.1.4. “SITE” shall mean the place or places at which the plants/equipments are to be erected and services are to be performed as per the specification of this contract.</p> <p>2.1.5. “CLIENTS OF BHEL” or “CUSTOMER” shall mean the project authorities to whom BHEL is supplying the equipments.</p> <p>2.1.6. “CONTRACTOR” shall mean the individual, firm or company who enters in to this contract with BHEL and shall include their executors, administrators, successor and permitted assignees.</p> <p>2.1.7. “CONTRACT” or “CONTRACT DOCUMENT” shall mean/and include the agreement or work order, the accepted appendices of rates, schedules, quantities, if any and general conditions of contract, the special conditions of contract, instructions to the bidders, the drawings, the technical specifications, the special specifications, if any, the tender documents and the Letter of Intent/Acceptance Letter issued by BHEL. Any conditions or terms stipulated by the contractor in the tender document or subsequent letters shall not form part of the contract unless specially accepted in writing by BHEL, in the Letter of intent and incorporated in the agreement.</p> <p>2.1.8. “GENERAL AND SPECIAL CONDITIONS OF CONTRACT” shall mean the “Instructions to Bidders and General and Special Conditions of Contract” pertaining to the work for which the bidders are called for.</p> <p>2.1.9. “TENDER SPECIFICATIONS” shall mean the “SPECIFIC CONDITIONS, Technical specifications, appendices, site informations and drawings” pertaining to the work in which the bidders are required to submit their offer, Individual specification number will be assigned to each tender specification..</p> <p>2.1.10. “TENDER DOCUMENTS” shall mean the General and Special Conditions of Contract(2.1.8) and tender specification(2.1.9).</p> <p>2.1.11. “LETTER OF INTENT” shall mean the intimation by a letter to the bidder that the tender has been accepted in accordance with provisions contained in that letter. The responsibility of the contractor commences from the date of issue of this letter and all the terms and conditions of contract are applicable from this date.</p> <p>2.1.12. “COMPLETION TIME” Shall mean the period by date specified in the acceptance of tender or date mutually agreed upon for handing over of the erected equipment/plant which are found acceptable by the Engineer being of required standard and conforming to the specifications of the contract.</p> <p>2.1.13. “PLANT” shall mean and cannot the entire assembly of the plant and equipments covered by the contract.</p> <p>2.1.14. “EQUIPMENT” shall mean all equipments, machinery, materials, structural, Electricals and other components of the plant covered by the contract.</p> <p>2.1.15. “TESTS” shall mean and include such test or tests to be carried out on the part of the contractor as are prescribed in the contract or considered necessary by BHEL in order to ascertain the quality, workmanship, performance and efficiency of the contract work or part thereof.</p> <p>2.1.16. “APPROVED” “DIRECTED” or “INSTRUCTED” shall mean approved, directed or instructed by BHEL.</p>		

 <p>Ranipet</p>	<p>Bharat Heavy Electricals Limited Boiler Auxiliaries Plant, Ranipet –632 406 FIELD ENGG. SERVICES DEPARTMENT</p>	<p>GENERAL CONDITIONS OF CONTRACT ES : F : 010</p> <hr/> <p>Page No.: 08 of 18</p>
<p>SECTION –II</p>		
<p>2.1.17. “WORK OR CONTRACT WORK” shall mean and include supply of all categories of labour specified consumables, tools and tackles required for complete and satisfactory site transportation handling, stocking, storing, erecting, testing, and commissioning of the equipments to the entire satisfaction of BHEL.</p> <p>2.1.18. “SINGULAR AND PLURAL ETC” works carrying singular number shall also include plural and vice versa, where the context so required. Words importing the masculine gender shall be taken to include the feminine gender and words imparting persons shall include any company or association or body of individuals, whether incorporated or not.</p> <p>2.1.19. “HEADINGS” The headings in these general conditions are solely for the purpose of facilitating reference and shall not be deemed to be part thereof or be taken into consideration in the interpretation or construction thereof or of the contract.</p> <p>2.1.20. “MONTH” shall mean calendar month, unless specified otherwise in the tender.</p> <p>2.1.21. “WRITING” shall include any manuscript typewritten or printed statement under the signature of BHEL.</p> <p>2.2. LAW GOVERNING THE CONTRACT AND COURT JURISDICTION The contract shall be governed by the Law for the time being in force in the Republic of India, and shall be subject to the Jurisdiction of the courts having Jurisdiction over RANIPET (VELLORE Dist, Tamil Nadu).</p> <p>2.3. ISSUE OF NOTICE: The Contractor shall furnish to the BHEL ENGINEER the name, designation and address of his authorized agent and all complaints, notices, communication and reference shall be deemed to have been duly given to the contractor or his authorized agent or left or posted to the address of either the contractor or of his representative and shall be deemed to have been so give in the case of posting on the day on which they would have reached such address in the ordinary course of post or on which they were so delivered of / or left.</p> <p>2.4. USE OF LAND: No land belonging to BHEL or their customer under temporary possession of BHEL shall be occupied by the Contractor without the written permission of BHEL.</p> <p>2.5. COMMENCEMENT OF WORKS:</p> <p>2.5.1. The Contractor shall commence the works within the time indicated in the Letter of Intent from BHEL and shall proceed with the same with due expedition without delay.</p> <p>2.5.2. If the successful bidder fails to start the work within the stipulated time, BHEL, at his sole discretion will have the right to cancel the contract. His earnest money and/or Security Deposit with BHEL will stand forfeited without any further reference to him without prejudice to any and all of BHEL’s other rights and remedies in this regard.</p> <p>2.5.3. All the works shall be carried out under the direction and to the satisfaction of BHEL.</p> <p>2.5.4. The erected/constructed plant or work performed under this contract shall be taken over when it has been completed in all respects and/or satisfactorily put in to operation at site.</p> <p>2.6. MODE OF PAYMENT AND MEASUREMENT OF THE WORK COMPLETED:</p> <p>2.6.1. All payments due to the contract shall be paid through E-PAYMENT (EFT / RTGS) only. The contractor has to furnish acceptance for e-payment, duly indicating the bank account details in the prescribed format.</p> <p>2.6.2. For Progress running bill payment: The contractor shall present detailed measurement working sheets, in quadruplicate, duly indicating all relevant details based on technical documents and connected drawings for work done during the month/period under various categories in line with terms of payment as per letter of intent. The basis of arriving at the quantities/weight shall be the relevant documents and drawings released by BHEL.</p>		

 Ranipet	Bharat Heavy Electricals Limited Boiler Auxiliaries Plant, Ranipet –632 406 FIELD ENGG. SERVICES DEPARTMENT	GENERAL CONDITIONS OF CONTRACT ES : F : 010 Page No.: 09 of 18
SECTION –II		
<p>2.6.3. These measurement working sheets will be checked and vetted by BHEL Engineers and quantities and percentage eligible for payment under various groups shall be decided by BHEL engineers. The abstract of quantities and percentage so arrived based on the terms of payment shall be entered in Measurement Book and signed by both the parties.</p> <p>2.6.4. Based on the above quantity, contractor shall prepare the bills in prescribed pro-forma and work out the financial value. These will be entered in Measurement Book and signed by both the parties and paid duly effecting recoveries due.</p> <p>2.6.5. All recoveries due from the contractor for the month/period shall be effected in full from the corresponding running bills unless specific approval from the competent authorities is obtained otherwise.</p> <p>2.6.6. Measurement shall be restricted to that for which it is required to ascertain the financial liability of BHEL under this contract.</p> <p>2.6.7. The measurement shall be taken jointly by persons duly authorized on the part of BHEL and by the contractor.</p> <p>2.6.8. The contractor shall bear the expenditure involved, if any, in making the measurement. The contractor shall, without extra charges provide all the assistance with appliances and other things necessary for measurement.</p> <p>2.6.9. If, at any time due to any reason, whatsoever, it becomes necessary to re-measure the work done in full or in part, the expenses towards such re-measurements shall be borne by the contractor.</p> <p>2.6.10. Passing of measurement as per bills does not amount to acceptance of the completion of the work mentioned. Any left out work has to be completed if pointed out at a later date by BHEL.</p> <p>2.6.11. Final measurement bill shall be prepared in the final bill pro-forma prescribed for the purpose based on the certificate issued by BHEL Engineer that entire work as stipulated in the tender specification has been completed in all respects to the entire satisfaction of BHEL. Contractors shall give unqualified 'No Due' and 'No Demand' certificate. All the tools and tackles loaned to them should be returned in condition satisfactory to BHEL. Quantities/Weight erected shall be prepared and paid, within a reasonable time after completion of work. After payment of final bill, only guarantee obligation percentage shall remain unpaid which shall be released in accordance with clause 2.13. The final bill quantities and financial value shall also be entered in Measurement Book and signed by both the parties to the contract.</p> <p>2.7 RIGHTS OF BHEL</p> <p>BHEL reserves the following rights in respect of this contract without entitling the contractor for any compensation.</p> <p>2.7.1. To get the work done through other agency at the risk and cost of the Contractor, in the event of Contractor's poor progress, or inability to progress the work, persistent disregard in instruction of BHEL, assignment transfer, subletting of the contract without permission of BHEL, non fulfillment of any contractual obligation etc., and to recover compensation for such losses from the contractor including BHEL's supervision charges and overheads from Security Deposit / other dues.</p> <p>2.7.2. To withdraw any portion of work and/or to restrict/alter quantum of work as indicated and get it done through other agency and/or with departmental labor to suit BHEL's commitment to its customer or in case BHEL decides to advance the date of completion due to other emergency reasons/BHEL's obligation to its customer.</p> <p>2.7.3. To terminate the contract after due notice to cause forfeiting of Security Deposit and recover the loss sustained in getting the balance work done through other agencies in addition to liquidated damages in the event of :</p> <p>2.7.3.1. Contractor's continued poor progress.</p> <p>2.7.3.2. Withdrawal from or abandonment of the work before completion of the work.</p>		

 Ranipet	Bharat Heavy Electricals Limited Boiler Auxiliaries Plant, Ranipet –632 406 FIELD ENGG. SERVICES DEPARTMENT	GENERAL CONDITIONS OF CONTRACT ES : F : 010
		Page No.: 10 of 18

SECTION –II

- 2.7.3.3.** Corrupt act of contractor.
- 2.7.3.4.** Insolvency of the contractor.
- 2.7.3.5.** Persistent disregards to the instructions of BHEL.
- 2.7.3.6.** Assignment transfer, sub-letting of the contract without BHEL's permission.
- 2.7.3.7.** Non-fulfillment of any contractual obligations.
- 2.7.4.** To recover any money due from the contractor from any money due to the contractor under this contract or any other contract or from the Security Deposit.
- 2.7.5.** To claim compensation for losses sustained including BHEL's supervision charges and overheads for completion on termination of contract and to impose penalty for delay in completion of the work at the rate of ½% of the contract value per week of delay or part thereof subject to a ceiling of 10% of contract value.
- 2.7.6.** To terminate the contract or to restrict the quantum of work and pay for the portion of work executed in case BHEL's contracts with their customers are terminated for any reason.
- 2.7.7.** To effect recovery from any amount due to the contractor under this or any other contractor in any other form the moneys BHEL is forced to pay to anybody, due to contractor's failure to fulfill any of his obligation.
- 2.7.8.** To restrict or increase the quantity and nature of work to suit the site requirements since the tender specification is based on preliminary documents and quantities furnished there in are indicative and approximate and the rates quoted shall not be subject to revision.
- 2.7.9.** To deploy BHEL's fitters, welders, operators and technicians in case of emergency/poor progress/deficiency in skill on the part of employees of contractor and to recover the expenditure on account of the same from contractor's bills.
- 2.7.10.** While every endeavor will be made by BHEL they cannot guarantee un-interrupted work to the contractor due to conditions beyond their control. Contractor will not be entitled for any compensation extra payment on his account.
- 2.7.11.** In the event of any dispute of any nature, the decision of BHEL shall be final and binding on the contractor.
- 2.7.12. Cancellation of contract in part or full for contractor's default:**
- If the contractor:
- Makes default in commencing the work within a reasonable time from the date of handing over of the site and continue in that state after a reasonable notice from Engineer-in-charge.
- OR
- in the opinion of the Engineer-in-charge at any time whether before or after the date / extended date for completion, make default in proceeding with the work, with due diligence and continue in that state after a notice of seven days from Engineer-in-charge
- OR
- fails to comply with any of the terms and conditions of the contract or after 7 days notice in writing with orders properly issued there under
- OR
- fails to complete the work order and items of work as per individual dates for completion and clear the site on or before the date of completion or fails to achieve the progress set out in accordance with the provisions of contract.

 Ranipet	Bharat Heavy Electricals Limited Boiler Auxiliaries Plant, Ranipet –632 406 FIELD ENGG. SERVICES DEPARTMENT	GENERAL CONDITIONS OF CONTRACT
		ES : F : 010
		Page No.: 11 of 18
SECTION –II		
<p>The Accepting Officer may, without prejudice to any other right or remedy which shall have accrued or shall accrue to BHEL, cancel the contract as a whole or in part thereof or only such work order items of work in default from the contract. Whenever the Accepting officer exercises his authority to cancel the contract as a whole or in part under this condition he may complete the work at the contractor's risk and cost , provided always that in the event of the cost of completion (as certified by Engineer-in-charge, which is final and conclusive) being less than the contract cost the advantage shall accrue to the BHEL. If the cost of completion exceeds, the money due to the contractor under this contract the contractor shall either pay the excess amount ordered by General Manager or the same shall be recovered from the contractor by other means. Engineer-in-charge will have power to take possession of site and materials, constructional plant, implements, stores etc there on.</p>		
<p>In case BHEL completes the work or any part thereof under the provisions of the contract conditions, then such completion is to be taken in to account in determining the excess cost to be charged to the contractor under this condition and shall consist of the cost of materials purchased and / or labour provided by BHEL, with an addition of such percentage to cover superintendence and establishment charges as may be decided by the General Manager, whose decision shall be final and conclusive.</p>		
<p>2.7.13. If the contractor fails to pay the excess sum within a period of 30 days the Engineer-in-charge shall have the right to sell any or of the contractor's unused materials, construction plant, implements, temporary buildings etc., and apply the proceeds of sale thereof towards the satisfaction of any sum due from the contractor under the contract and if there after be any balance out standing from the contractor, it shall be recovered in accordance with the provisions of the contract.</p>		
<p>2.7.14. BHEL shall have the right to recover any money due from the contractor from any money due to the contractor under this contract or any other contract or from the Security Deposit.</p>		
<p>2.8. RESPONSIBILITIES OF THE CONTRACTOR IN RESPECT OF LOCAL LAWS, EMPLOYMENT OF WORKERS Etc.</p>		
<p>The following are the responsibilities of the Contractor in respect of observation of local laws, employment of personnel, payment of taxes etc.</p>		
<p>2.8.1. As far as possible unskilled workers shall be engaged from the local areas in which the work is being executed.</p>		
<p>2.8.2. The contractor at all times during the continuance of this contract shall, in all his dealings with local labour for the time being employed on or in connection with the work, have due regard to all local festivals, religious and other customs.</p>		
<p>2.8.3. The contractor shall comply with all state and Centrals Laws, Statutory Rules, Regulations etc., inclusive of those regarding labour and industrial laws which are applicable from time to time and they shall comply with the provisions of the said labour legislations, rules and regulations framed under the provisions of Employees Provident Fund and Miscellaneous Provisions Act 1952 shall be strictly followed.</p>		
<p>2.8.4. The contractor shall pay all taxes, including sales Tax on works contract if any fees, license, charges, deposits duties, tool royalty commissions or other charges which may be leviable on account of any of his operations in execution of the contract in case BHEL is forced to pay any of such taxes. BHEL shall have the right to recover the same from the contractor either from his bills or other wise as deemed fit.</p>		
<p>2.8.5. While BHEL would pay the inspection fees, of the Boiler Inspectorate, all other arrangements for the visits periodically by Boiler Inspector to site, Inspection Certificate etc., will have to be made by the contractor. However BHEL will not make any payment to Boiler Inspector in connection with contractor's welders qualification/requalification tests etc.</p>		
<p>2.8.6. The contractor shall be responsible for provision of health and sanitary arrangements (more particularly described in Contract Labour Regulation & Abolition Act) safety precautions etc., as may be required for safe and satisfactory execution of the contract.</p>		
<p>2.8.7. The contractor shall be responsible for providing proper accommodation including adequate medical facilities for the personnel employed by him.</p>		
<p>2.8.8. The contractor shall be responsible for the proper behavior and observance of all regulations by the staff employed by him.</p>		

 <p>Ranipet</p>	<p>Bharat Heavy Electricals Limited Boiler Auxiliaries Plant, Ranipet –632 406 FIELD ENGG. SERVICES DEPARTMENT</p>	<p>GENERAL CONDITIONS OF CONTRACT ES : F : 010</p> <hr/> <p>Page No.: 12 of 18</p>
<p>SECTION –II</p>		
<p>2.8.9. The contractor shall ensure that no damage is caused to any person/property of other parties working at site. If any such damage is caused it is the responsibility of the contractor to make good the losses or compensate for the same.</p> <p>2.8.10. All the properties/equipments/components of BHEL their client loaned with or without deposit to the contractor in connection with contract shall remain the properties of BHEL/their client. The contractor shall use such properties for purpose of execution of this contract, all such properties/equipments/components shall be deemed to be in good condition when received by the Contractors unless he notifies within 48 hours to the contrary. The Contractor shall return them in good condition as and when required by BHEL/their client. In case of non-return, loss, damage, repairs etc, the cost thereof, as may be fixed by the site Engineer, will be recovered from the Contractor.</p> <p>2.8.11. It is not obligatory on the part of BHEL to supply any tools and tackles or other materials other than those specifically agreed to do so by BHEL. However, depending upon the availability/possibility BHEL's customer's handing equipment and other plants may be made available to the contractor on payment of the hire charges/free of charges, as fixed subject to the conditions laid down by BHEL/Customer from time to time. Unless paid in advance such hire charges if applicable shall be recovered from contractors bills/security deposit in one installment.</p> <p>2.8.12. The Contractor shall fully indemnify BHEL against all claims of whatsoever nature arising during the course of erection/construction/performing work under the contract.</p> <p>2.8.13. In case the Contractor is required to undertake any work outside the scope of this contract the rate payable shall be those mutually agreed upon.</p> <p>2.8.14. Any delay in completion of works/non-achievement of periodical targets, due to reasons attributable to the contractor, the same will have to be compensated by the Contractor either by increasing manpower and resources or by working extra hours and/or by working more than one shift. All these are to be carried out by the contractor at no extra cost.</p> <p>2.8.15. The contractor shall arrange and co-ordinate his work in such a manner as to cause no hindrance to other agencies working in the same premises.</p> <p>2.8.16. All safety rules and codes applied by the client/BHEL at site shall be observed by the contractor without exception. The contractor shall be responsible for the safety of the equipment/material and works to be performed by him and shall maintain all light, fencing guards signs etc, or other protection necessary for the purpose. Contractor shall also take such additional precautions as may be indicated from time to time by the Engineer with a view prevent pilferage, accidents, fire hazards and due precautions shall be taken against fire hazards and atmospheric conditions. Suitable number of clerical staff, watch and ward, store keepers to take care of equipment, materials and construction tools and tackles shall be posted at site by the contractor till the completion of the work under this contract. The contractor shall arrange for such safety devices as are necessary for such type of work and carry out the requisite site tests of handling equipments, lifting tools, tackles, etc., as per prescribed standards and practices.</p> <p>2.8.17. The contractor will be directly responsible for payment of wages to his workmen. A pay roll sheet giving all the type payments given to the workers and duly signed by the contractor's representative should be furnished to BHEL Site office on or before 15th of every succeeding month.</p> <p>2.8.18. In case of any class of work for which there is no such specification as laid down in the contract, such work shall be carried out in accordance with the instructions and requirements of the Engineer.</p> <p>2.8.19. No levy of payment or charge made or imposed shall be impeached by reason of any clerical error or by reason of any mistake in the amount levied or demanded or charged.</p> <p>2.8.20. Also no idle labour charges will be admissible in the event of any stoppage caused in the work resulting contractor's labour being rendered idle due to any cause at any time.</p> <p>2.8.21. The contractor shall take all reasonable care to protect the materials and work till such time the plant/equipment has been taken over by BHEL/their client.</p> <p>2.8.22. Contractor shall not stop the work or abandon the site for whatsoever reason or dispute, excepting for force major conditions. All such problems/dispute, shall be separately discussed and settled without affecting the progress of work. Such stoppage or abandonment shall be treated as breach of contract and dealt with accordingly.</p>		

 Ranipet	Bharat Heavy Electricals Limited Boiler Auxiliaries Plant, Ranipet –632 406 FIELD ENGG. SERVICES DEPARTMENT	GENERAL CONDITIONS OF CONTRACT
		ES : F : 010
		Page No.: 13 of 18
SECTION –II		
2.9. CONSEQUENCES OF CANCELLATION:		
<p>Whenever BHEL exercises its authority to terminate the contract/withdraw a portion of work under the clause 2.7 they may complete the work by any means. In the event of the cost of completion as certified by the site Engineer which is final and conclusive being less than the contract cost, the advantage shall accrue to BHEL and that if the cost of completion exceeds the moneys due to the contractor under the contract, the contractor shall either pay the excess amount ordered by BHEL or the same shall be recovered from the contractor by any other means. This will be in addition to the forfeiture of Security Deposit and recovery of liquidated damages as per the relevant clauses.</p>		
<p>2.9.1. In case BHEL completes the work under the provision of this condition, the cost of such completion to be taken into account in determining the excess cost to be charged to the contract under this condition, shall consist of materials purchased and/or labour provided by BHEL with an addition of such percentage to cover supervision and establishment charges as may be decided by BHEL.</p>		
2.10 INSURANCE:		
<p>2.10.1. BHEL/their customer shall arrange for insuring the materials/properties of BHEL / customer covering the risks during transit, storage, erection and commissioning.</p>		
<p>2.10.2. It is sole responsibility of the contractor to insure his workmen against accidents and injury while at work as required by relevant Rules and to pay compensation, if any, to workmen as per workmen's Compensation Act. The work will be carried out in a protected area and all the rules and regulations of the client/BHEL in the area of project which are in force from time to time will have to be followed by contractor.</p>		
<p>2.10.3. If due to negligence and/or non-observance of safety and other precautions, any accident/injury occurs to any other persons/public, the contractor shall have to pay necessary compensation and other expenses if so decided by the appropriate authorities.</p>		
<p>2.10.4. If due to contractor's carelessness's, negligence of non-observance of safety precautions damage to BHEL's /customer's property and personnel should occur and if BHEL is unable to recover in full cost from the insurance company, the same will be recovered from the contractor.</p>		
<p>2.10.5. It shall be the responsibility of the contractor to provide security arrangement for the equipment/ materials belonging to BHEL and handed over to the contractor for erection/transportation till the same are taken over by BHEL after erection/returned to BHEL stores.</p>		
2.11. STRIKES & LOCKOUTS:		
<p>2.11.1. The contractor will be fully responsible for the entire dispute and other issues connected with his labour. In the event of the contract labour resorting to strike or the contract resorting to lock-out and if the strike or lock-out declared is not settled within a period of one month, BHEL, shall have the right to get the erection work executed employing its won labour or through any agencies or both and the cost so incurred by BHEL be deducted from the contractor's bills.</p>		
<p>2.11.2. For any purpose whatsoever the employees of the contractor shall not be deemed to be in the employment of BHEL.</p>		
2.12. FORCE MAJEURE:		
<p>2.12.1 The following shall amount to FORCE MAJEURE:</p>		
<p>Act of God or of any Government, War, Sabotage, Riots, Civil commotion, Police action revolution, Flood, Fire, Cyclones, Earth quake and epidemic and other similar causes over which the contractor has no control.</p>		
<p>2.12.2. If the contractor suffers delay in the due execution of the contractual obligation due to delays caused by FORCE MAJEURE as defined above, the agreed time of completion of the job covered by this contract or the obligation of contractor shall be extended by a period of time equal to the period of delay provided that on the occurrence of any such contingency the contractor immediately reports to BHEL in writing the causes of delay and the contractor shall not be eligible for any compensation.</p>		

 Ranipet	Bharat Heavy Electricals Limited Boiler Auxiliaries Plant, Ranipet –632 406 FIELD ENGG. SERVICES DEPARTMENT	GENERAL CONDITIONS OF CONTRACT ES : F : 010
		Page No.: 14 of 18
SECTION –II		
2.13. GUARANTEE:	<p>Even though the work will be carried out under the supervision of BHEL Engineers the contractor will be responsible for the quality of the workmanship and shall guarantee the work done for a period of twelve months from the date of completion of work as certified by the Engineer for good workmanship and shall rectify free of cost all defects due to faulty erection, detected during the guarantee period starting from the date of the completion of rectification. In the event of the contractor failing to repair the defective works within the time specified by the Engineer, BHEL may proceed to undertake the repairs of such defective works at the contractor's risk and cost, without prejudice to any other rights and recover the same from Security Deposit/other dues or by other legal means.</p>	
2.14. ARBITRATION:	<p>Except where otherwise provided for in the contract all questions and disputes relating to the meaning of the specifications, designs, drawings and instructions herein before mentioned and as to the quality of workmanship or materials used on the work or as to any other question, claim, right, matter or thing whatsoever in anyway arising out of or relating to the contract, designs, drawings, specifications, estimates, instructions, orders or these conditions or otherwise concerning the work or failure to execute the same whether arising during the progress of the work or after the completion or abandonment thereof shall be referred to the sole arbitration. The parties agree that the sole arbitrator shall be appointed by BHEL.</p> <p>The cases referred to arbitration shall be other than those for which the decision of the Accepting Officer, or Engineer-in-charge as the case may be is expressed in the contract to be final and conclusive.</p> <p>Subject as aforesaid the provision of the Arbitration and Conciliation Act 1996 or any statutory modification or reenactment thereof and the rules made there under and for the time being in force shall apply to the arbitration proceeding under this clause.</p> <p>It is a term of the contract that the party involving arbitration shall specify the dispute or dispute to be referred to arbitration under this clause together with the amount or amounts claimed in respect of each such dispute.</p> <p>The arbitrator shall be deemed to have entered on the reference on the date he issues notice to both the parties fixing the date of first hearing.</p> <p>The arbitrator shall give a separate award in respect of each dispute or difference referred to him.</p> <p>The place of arbitration shall be Ranipet. However the arbitrator may hold the proceedings at any venue as per discretion. The award of the Arbitrator shall be final conclusive and binding on all parties to this contracts.</p> <p>In the event of disputes or differences arising between one public sector and a Government Department or between two public sector enterprises the above stipulations shall not apply, the provisions of BPE Office memorandum No.BPE/CL/001/76 MAN/2(1.10)76-BPE(GM-1)dated 1st January 1976 or its amendments for arbitration shall be applied.</p>	
+		

 Ranipet	Bharat Heavy Electricals Limited Boiler Auxiliaries Plant, Ranipet –632 406 FIELD ENGG. SERVICES DEPARTMENT	GENERAL CONDITIONS OF CONTRACT ES : F : 010
		Page No.: 15 of 18
CONTRACT AGREEMENT		
AGREEMENT NO: BAP : ERN : BHE :		
DATE:		
Name of work :		
Name of the contractor with full address :		
Amount of tender accepted :		
Letter of Intent No. :		
Time allotted for completing the work : (date of completion)		
(Officer authorized to sign the agreement)		
CONTRACTOR		

 Ranipet	Bharat Heavy Electricals Limited Boiler Auxiliaries Plant, Ranipet –632 406 FIELD ENGG. SERVICES DEPARTMENT	GENERAL CONDITIONS OF CONTRACT ES : F : 010
		Page No.: 16 of 18

ANNEXURE –‘D’ CONTRACT AGREEMENT

AGREEMENT No: BAP: ERN : BHE :

DATE:

- This agreement made this day, the _____ of _____ between the Bharat Heavy Electricals Limited, Ranipet having its Registered Office at 'BHEL House' , Siri Fort, New Delhi 110 049 (herein after called the FIRST PARTY) of one part and Messrs. (herein after called the ("CONTRACTOR") of the SECOND PARTY.
- WHEREAS the first party is desirous of executing the work of _____ more particularly described in the appendices including drawings and specifications attached herewith.
- WHEREAS IN PURSUANCE of the said Contractor's Tender having been accepted, the first party has decided to give the above said work to Contractor, and WHEREAS the contract between the parties was concluded by virtue of a letter of intent issued by the First Party under reference _____ Dt. _____.
- WHEREAS the said Contractor has agreed to do the aforesaid work of the first party subject to the conditions herein contained in the presents, instructions to bidders, general conditions and special conditions, schedules, appendices, letter of intent and specifications (hereinafter referred as the said contract schedule) at the approved rates (herein referred as the said contract rate).
- AND WHEREAS the said contractor has furnished a Bank Guarantee for a sum of Rs. _____ Valid up to _____ towards initial 50% security Deposit and has further agreed for balance 50% Security Deposit being recovered at 10% of value of each running bill till the full Security Deposit is made up for the satisfactory completion and performance of the work and whereas the validity of the said Bank Guarantee has to be extended by the Contractor, if so required before for the balance period of contract period and in the event of his failure to do so, the contractor shall pay or accept recovery of this amount of Rs. _____ (Rupees _____ only), from the bills forthwith in one installment and it has further been agreed that the failure to extend the validity of Bank Guarantee or failure to pay the aforesaid amount the manner specified above shall constitute the breach of contract, and first party reserved the right to take easy legal action deemed fit for recovering the said sum of Rs. _____ (Rupees _____ only). This amount of Rs. _____ Will be refunded (and Bank Guarantee will be returned) to the Contractor on satisfactory completion of the work as specified in the Contract documents.
- Now THESE PRESENTS WITNESS that in consideration of the said contract schedule and said contract rate as also of agreement of good and faithful services to be rendered and performed by the contractor in the execution of the said work, subject to the stipulation hereinafter expressed.
- That the said contractor will perform the aforesaid work subject to the conditions contained in these presents, instructions to bidder, general and special conditions of contract and the contract documents attached herewith including the said schedules, specifications, appendices, letter of intent, drawings attached and also such other drawings and instructions as may from time to time be given by the first party. And that the said contractor shall be deemed to have carefully examined the specifications and conditions of contract, appendices, schedules, letter of intent , drawings etc., as aforesaid and also to have satisfied himself as to the nature and character of work to be executed.
- That the said contractor shall carry out and complete the execution of the said work to the entire satisfaction of the Engineer within the agreed time schedule.
- That the first party after proper scrutiny of the bills submitted by the said contractor will pay to him during progress of the said work, at said contract rates and agreed terms of payment, a sum as determined by the first party in respect of the work executed by the contractor.
- That the contract shall come into force with retrospective effect from the date on which the letter accepting the tender (Letter of Intent) has been issued to the said contractor.
- That whatever under this contract or otherwise, any sum of money shall be recoverable from or payable by the Contractor, the same may be deducted in the manner as set out in the conditions of contract as aforesaid.
- That all charges on account of Octroi, terminal and sales-tax or other duties on materials obtained for the work shall be borne by the said contractor.
- That is agreed between the parties that the non-exercise of any of the powers conferred on the authorities of the first party will not in any manner constitute waiver of the conditions thereto contained in these presents and the liability of the said contractor either of past or further compensation shall remain unaffected.
- That the expression BHEL wherever occurring means THE BHARAT HEAVY ELECTRICALS LIMITED, RANIPET.
- The contract is subject to RANIPET(TamilNadu) jurisdiction.
- The document hereto attached viz. shall also form part of this agreement.
- General Conditions of Contract attached to the Notice inviting tender shall form part of this contract in so far as any thing is not provided specifically in this agreement.
- In witness hereof the parties have respectively set their signatures in the presence of :

WITNESSES:

(with full address)

1.

2.

Date:

Signature of the Contractor (to be signed by a Person holding valid power of Attorney of the Company)

WITNESSES:

(with full address)

1.

2.

Date:

For and on behalf Bharat Heavy Electricals Limited.

 <p>Ranipet</p>	<p>Bharat Heavy Electricals Limited Boiler Auxiliaries Plant, Ranipet –632 406 FIELD ENGG. SERVICES DEPARTMENT</p>	<p>GENERAL CONDITIONS OF CONTRACT ES : F : 010</p> <p>Page No.: 17 of 18</p>
<p>ANNEXURE 'E' PROFORMA FOR SECURITY DEPOSIT</p>		
<p>THIS DEED OF GUARANTEE made this day of _____ by Messrs. _____ (hereinafter called the Bank) in favour of Messrs. <u>BHARAT HEAVY ELECTRICALS LIMITED, RANIPET</u> having its Registered Office at New Delhi (hereinafter called the Principal)</p>		
<p>WHEREAS Messrs. _____ (hereinafter called the Contractor) has entered in to a Contract with Bharat Heavy Electricals Ltd., Ranipet arising out of Letter of Intent No. _____ Dt. _____ addressed by the Principal to the Contractor (hereinafter called the said agreement) for</p>		
<p>AND WHEREAS the said Agreement provides that the contractor shall pay a sum of Rs. _____ (Rupees _____ only) towards 50% of full Security Deposit to be made in the form and manner therein specified.</p>		
<p>AND WHEREAS the Contractor have approached the Bank and at their request and in consideration of the agreement arrived at between the said contractor and the Bank, the Bank has agreed to give such guarantee as hereinafter mentioned to the Principal.</p>		
<p>NOW, therefore, these present witness that we the Bank by the hand Mr. _____ its lawfully and duly constituted attorney, do hereby undertake to pay to the principal a sum of Rs. _____ (Rupees _____ only) without demur on demand being made by the principal and to keep the principal indemnified to the extent of Rs. _____ by</p>		
<p>virtue of this guarantee against any loss or damage caused to or suffered by the principal by reason of any breach by the aforesaid contract of any of the terms and or conditions, stipulations or undertakings of any one of them contained in the said Agreement and the tender documents attached thereto and for the payment of any money or moneys payable by the said contractor to the principal under the terms and conditions of the said Agreements (the decisions regarding the breach, loss damage or payment due being solely in the discretion of the Principal).</p>		
<p>We further undertake to pay without demur the aforesaid amount in a lump sum on demand or such part thereof as the Principal may demand from time to time irrespective of the fact whether the said contractor admits or denies such claim or questions its correctness in any Court Tribunal or Arbitration Proceedings or before any authority. The aforesaid guarantee will remain in force and we shall be liable under the same irrespective of any concession or time being granted by the principal, to the Contractor in or fulfilling the said agreement between contractor and the principal and the guarantee will remain in full force irrespective of any change of terms, conditions or stipulation or any variation in the terms of the said agreement irrespective of whether notice of such change or/variation is given to us or not and claim to receive such notice of any change/and or variation of the terms and or variation of the terms and or/conditions of the said agreement is hereby specifically waived by us. Further we shall not be release from this guarantee by any forbearance of the exercise or non-exercise of any of the powers or rights under the said agreement by the principal against the contractor irrespective of whether notice of such forbearance enforcement or non-enforcement of any powers or rights, modifications or change made in the said agreement or concessions shown to contractor by the principal is given to us or not.</p>		
<p>The guarantee herein contained shall not be determined or affected by the liquidation or winding up or insolvency of or change in the constitution of the contractor but shall in all respects and for all purposes be binding and operative until all payments of all moneys due or that may hereafter become due to the principal in respect of any liability or obligations of the contractor under the said agreement.</p>		
<p>We, the Bank further agree that the guarantee herein contained shall remain in full force and effect during the period that would be taken for the performance of the said agreement and that it shall continue to be enforceable till all the dues of the principal under or by virtue of the said agreement have been fully paid and its claims satisfied or discharged or till the principal certifies that the terms and conditions of the said Agreement have been fully and properly carried out by the said contractor and accordingly discharges the guarantee subject to however that the principal shall have no rights under this guarantee after the expiry of six months from the date of completion of the contract (the date of completion shall be as certified by the Principal) unless this guarantee is extended by agreement.</p>		
<p>Any claim or dispute arising under the terms of this contract shall only be enforced or settled in the Court having jurisdiction over RANIPET (VELLORE Dist, Tamil Nadu)</p>		
<p>And lastly the Bank undertakes not to revoke this guarantee during its currency except with the previous consent of the principal in writing.</p>		
<p>The bank hereby declares that it has power to issue this guarantee under that Bank's Memorandum and Articles of Association and the undersigned has power to do so on its behalf under the power of Attorney granted to him by the proper Authorities of the Bank.</p>		
<p>Date:</p>	<p>(Name of the Bank & Place)</p>	
<p>Seal:</p>	<p>DESIGNATION OF THE AUTHORISED PERSON SIGNING THE GUARANTEE</p>	

 Ranipet	Bharat Heavy Electricals Limited Boiler Auxiliaries Plant, Ranipet –632 406 FIELD ENGG. SERVICES DEPARTMENT	GENERAL CONDITIONS OF CONTRACT ES : F : 010
		Page No.: 18 of 18
ANNEXURE –'F' NO DEMAND CERTIFICATE		
<p>1) Name of work :</p> <p>2) Agreement Date :</p> <p>3) I/We certify that</p> <p>a) I/We have completed the above work to the entire satisfaction of BHEL.</p> <p>b) I/We have handed over all the balance materials, components, tools and tackles, machinery and other equipment of BHEL.</p> <p>c) I/We have received the final payment from BHEL for the above work.</p> <p>d) I/We have no further demand whatsoever from BHEL.</p> <p>I/We, therefore request you to refund to me/us the security deposit of</p> <p>Rs. _____.</p> <p>(Rupees _____ only)</p> <p>and the Bank guarantee No.: _____ dt. _____.</p> <p>Rs. _____.</p> <p>After deducting all cost of expenses or other amounts that are to be paid by me/us to BHEL under this contractor other contract entered into by me/us with BHEL.</p>		
SIGNATURE OF THE CONTRACTOR WITH SEAL		
Place:		
Date:		
Witness	1)	
	2)	
	3)	

SPECIAL CONDITIONS OF CONTRACT

FOR

PG Test

BAP:FES :SPN :PG TEST



FES DEPARTMENT

BHARAT HEAVY ELECTRICALS LIMITED

(A Government of India Undertaking)

BOILER AUXILIARIES PLANT

INDIRA GANDHI INDUSTRIAL COMPLEX

RANIPET – 632 406

SPECIAL CONDITIONS OF CONTRACT

8.0 GENERAL TERMS AND CONDITIONS OF REVERSE AUCTION

- 8.1 For the proposed reverse auction, technically and commercially acceptable bidders only shall be eligible to participate.
- 8.2 BHEL will engage the services of a service provider who will provide all necessary training and assistance before commencement of on line bidding on Internet.
- 8.3 BHEL will inform the vendor in writing, in case of reverse auction, the details of service provider to enable them to contact and get trained.
- 8.4 Business rules like event date, time, start price, bid decrement, extensions, etc. also will be communicated through service provider for compliance.
- 8.5 Vendors have to fax the compliance form in the prescribed format (provided by service provider) before start of Reverse auction. Without this the vendor will not be eligible to participate in the event.
- 8.6 BHEL will provide the rate schedule (e.g. EXCEL sheet) for the vendor to enable them to fill-in the price and keep it ready for keying in during the auction. In the event of discrepancy in rate and amount against any item of work, the least of the two will be taken for bid price. In case of discrepancy between the total price indicated in price bid and the arithmetic sum arrived based on rate quoted, then also the least of the two will be taken for the bid price. The bids are compared on the total price quoted and NOT on individual ITEM of works.
- 8.7 Reverse auction will be conducted on scheduled date & time.
- 8.8 At the end of reverse auction event, the lowest bidder value will be known on the network.
- 8.9 The lowest bidder has to fax the duly signed filled-in prescribed format as provided on case-to-case basis to BHEL through Service provider within 24 hours of auction without fail.
- 8.10 Opening bid in reverse Auction: The opening bid (in the reverse Auction) of the bidders shall be same as that quoted in their final sealed price submitted to BHEL(along with Technical offer). The bidder shall confirm in writing to BHEL that their opening bid (in reverse auction) shall be same as that quoted in their final sealed price bids submitted to BHEL against this NIT along with Technical Bid (Patr-1).**If any bidder offered a unsolicited discount or rebate, in separate cover etc. in any place other than the sealed price bid, then the opening price bid in reverse auction, by such a bidder in Reverse Auction, shall be the price offered in final sealed price bid submitted (against this NIT) minus discount offered in any place other than the sealed price bid.**

- 8.11 BHEL reserves the right to cancel Reverse Auction (RA) without assigning any reasons and resort to considering the sealed bids submitted by vendor for processing and finalizing the tender.
- 8.12 In case the process of reverse auction is found unsuccessful by BHEL, then BHEL at its discretion may decide to call the L1 bidder of reverse auction for further negotiation.
- 8.13 Any variation between the on-line bid value and signed document will be considered as sabotaging the tender process and will invite disqualification of vendor to conduct business with BHEL as per prevailing procedure.
- 8.14 In case BHEL decides not to go for Reverse auction procedure for this tender enquiry, the Price Bids and price impacts, if any already submitted and available with BHEL shall be opened as per BHEL's standard practice.
- 8.15 Only those vendors, who participate in the Online Initial Opening Bid, will be eligible to participate in the subsequent Online English Reverse Auction.
- 8.16 Price bids offered by the bidders during reverse auction process is considered as an offer to execute the work. Bids once made by a bidder cannot be cancelled/withdrawn and bidders shall be bound to execute the work at the final bid price. BHEL shall take appropriate action if the bidder fails to do so.
-



Ranipet

Bharat Heavy Electricals Limited
Boiler Auxiliaries Plant, Ranipet –632 406
FES DEPARTMENT

STATUTORY REQUIREMENT OF CONTRACT
ES : F : 009

Page No.: 01 of 11

STATUTORY REQUIREMENT

OF

CONTRACT

(FORMATS & PROCEDURES)

ES : F : 009



R 05- 275

FIELD ENGG. SERVICES DEPARTMENT

BHARAT HEAVY ELECTRICALS LIMITED

(A Government of India Undertaking)

BOILER AUXILIARIES PLANT

INDIRA GANDHI INDUSTRIAL COMPLEX

RANIPET – 632 406

 Ranipet	Bharat Heavy Electricals Limited Boiler Auxiliaries Plant, Ranipet –632 406 FES DEPARTMENT	STATUTORY REQUIREMENT OF CONTRACT ES : F : 009
		Page No.: 03 of 11

OFFER OF THE BIDDER

(FORMAT - To be typed written in LETTER HEAD and submitted along with offer)

To

The Addl. General Manager
FES & ES Dept,
Bharat Heavy Electricals Limited,
Boiler Auxiliaries Plant,
Indira Gandhi Industrial Complex,
RANIPET –632 406. (TAMIL NADU).

Sir,

I / We hereby offer to carry out the work detailed in the Tender Specification No. _____ issued by M/s. Bharat Heavy Electricals Limited, Boiler Auxiliaries Plant, Ranipet in accordance with the terms and conditions thereof:

I/ we have carefully pursued the following documents connected with the above work and agree to abide by the same. We herewith confirm that we have visited the site _____.

- a. General terms and conditions of work (ES: F:010)
- b. Statutory requirement of Contract (ES: F:009)
- d. Tender Specification no. (_____.)
- e. Special Instructions to Bidder
- f. General terms and conditions of Reverse Auction.

I/We have deposited / forwarded herewith the Earnest Money Deposit in the form prescribed and as stipulated in Clause No.1.4. of the General Conditions of Contract for Works towards the Earnest Money Deposit for a sum of **Rs.**

(Rupees. _____ .only)

vide Pay Order No.....Dt..... 2015 /

Demand Draft No..... Dt..... 2015 which shall be refunded

should our offer not be accepted. Should our offer be accepted, I/We further agree to deposit such additional sum, within the stipulated time as may be indicated by BHEL, which along with the sum of **Rs.**

(Rupees. _____ .only)

shall make up the Security Deposit for the work as provided for in clause 1.8.2 of the General Conditions of Contract for Works.

I/We further agree to execute all the works referred to in the said documents upon the terms and conditions contained or referred to therein and as indicated in the Annexure enclosed thereto.

SIGNATURE OF BIDDER:		
Place:		ADDRESS:
Date:		

WITNESSES WITH FULL ADDRESS

	SIGNATURE	NAME	ADDRESS
1			
2			
3			

 Bharat Heavy Electricals Limited Boiler Auxiliaries Plant, Ranipet –632 406 FES DEPARTMENT Ranipet	STATUTORY REQUIREMENT OF CONTRACT ES : F : 009		
	Page No.: 04 of 11		
APPENDIX – II (To be filled by Tenderer and submitted along with Tender document)			
S.No.	PARTICULARS	YES	NO
01	SERVICE TAX		
a.	Service Tax Registration No. of Tenderer (copy to be enclosed)		
b.	Issue of Service Tax Invoice as per Rule 9 of Cen vat Credit rules2004		
c.	Whether Tenderer is taking Service Tax Credit for their Inputs		
d.	Under which Service Head is Service provided		
e.	If Service Tax is Exempted , furnish reasons		
f.	BHEL Service Tax Registration No. (To indicate in your Invoice) : AAACB/4146/PST/008		
02	INCOME TAX		
a.	PAN No. of Tenderer		
b.	If Exempted , furnish exemption Certificate		
c.	PAN No. of BHEL : AAACB/4146/P		
03	WC ST		
a.	CST Registration No.		
b.	VAT Registration No.		
c.	Whether Tenderer is availing VAT Credit		
d.	If Exempted , furnish Reasons		
	NOTE :		
	1. Rates Quoted shall be clearly indicated that they are INCLUSIVE of all Taxes & Duties except service tax. The Contractor has to issue invoice accordingly. Also refer clause 15.0 of Tender specification regarding Taxes & Duties		
	2. Payment will be made only through e-payment to your account. Payment through Cheque / DD payment will not be made by BHEL.		
Tenderer has to submit Banker's Certificate as per format specified in APPENDIX- IV.			
Agreed to the Above Conditions			
Signature of the Tenderer :			

 Bharat Heavy Electricals Limited Boiler Auxiliaries Plant, Ranipet –632 406 FES DEPARTMENT Ranipet	STATUTORY REQUIREMENT OF CONTRACT ES : F : 009

APPENDIX - III
ACCEPTANCE FOR ELECTRONIC FUND TRANSFER / RTGS TRANSFER

01	NAME & ADDRESS OF THE SUPPLIER / VENDOR MOBILE, PHONE NO. WITH STD CODE	
	PAN NO.	
02	VENDOR CODE (as in Purchase Order)	
03	Details of Bank Account:	
A)	NAME & ADDRESS OF THE BANK (WITH PIN CODE)	
B)	BANK TELEPHONE NUMBER (WITH STD CODE)	
C)	BANK BRANCH CODE	
D)	MICR CODE	
E)	ACCOUNT NUMBER	
F)	TYPE OF ACCOUNT	CURRENT A/C / OD / CASH CREDIT
G)	Vendor name as per Bank records	
H)	BANK BRANCH RTGS IFSC CODE	
I)	BANK BRANCH NEFT IFSC CODE	
J)	VENDOR'S EMAIL ID (give two ids)	
1		
2		
K)	NAME OF AUTHORISED SIGNATORY	

CERTIFICATE

I / We hereby agree to receive the payments due from BHARAT HEAVY ELECTRICALS LIMITED, RANIPET by the National Electronic Funds Transfer and/or RTGS Transfer mode by credit to my / our above mentioned Bank Account. I / We also agree that payments made to the above mentioned Account is a valid discharge of the liability of Bharat Heavy Electricals Limited, Ranipet. I / We also agree to bear the applicable Bank Charges for the above mode of transfer.

AUTHORISED SIGNATORY OF VENDOR WITH SEAL

Banker's Certification

We confirm that we are enabled for receiving RTGS and NEFT credits and we further confirm that the account number of _____ (name of account holder), the signature of the authorized signatory and the MICR and IFSC codes of our Branch mentioned above are correct.

PLACE:

DATE:

 (Manager / Officer's signature Under Bank stamp)
 Authorization No. _____

Note: This EFT Form is to be submitted duly filled in manually in all fields and duly signed by Authorised Signatory and certified by Banker.

 <p>Ranipet</p>	<p>Bharat Heavy Electricals Limited Boiler Auxiliaries Plant, Ranipet –632 406 FES DEPARTMENT</p>	<p>STATUTORY REQUIREMENT OF CONTRACT ES : F : 009</p> <hr/> <p>Page No.: 06 of 11</p>
<p style="text-align: center;"><u>APPENDIX – IV</u></p> <p style="text-align: center;"><u>Certified by Chartered Accountant on letter head</u></p> <p>This is certify that M/s, (hereinafter referred to as ‘company’) having its registered office at is registered under MSMED Act 2006, (Entrepreneur Memorandum No (part-II) dtd. :..... Category:.....(Micro/Small)).(Copy enclosed).</p> <p>Further verified from the Books of Accounts that the investment of the company as on date as per MSMED Act 2006 is as follows:</p> <ol style="list-style-type: none"> For Manufacturing Enterprises: Investment in plant and machinery (i.e. original cost excluding land and building and the items specified by the Ministry of Small Scale Industries vide its notification No.S.O.1722(E) dated 5, 2006 : Rs..... Lakhs For Services Enterprises: Investment in equipment (original cost excluding land and building and furniture, fittings and other items not directly related to the service rendered or as may be notified under the MSMED Act, 2006: Rs..... Lakhs <p>The above investment of Rs..... Lakhs is within permissible limit of Rs..... Lakhs for Micro/Small (Strike off which is not applicable) Category under MSMED Act 2006.</p> <p>Date: (Signature) Name – Membership Number – Seal of Chartered Accountant</p>		

 Bharat Heavy Electricals Limited Boiler Auxiliaries Plant, Ranipet –632 406 FES DEPARTMENT Ranipet	STATUTORY REQUIREMENT OF CONTRACT ES : F : 009

CERTIFICATE OF NO DEVIATION

(FORMAT - To be typed written in LETTER HEAD and submitted along with offer)

I / Weof M/s
 hereby certify that there is no deviation from the Tender conditions either technical or commercial and I am / We are agreeing to all the terms and conditions mentioned in the Tender Specification (No. : **BAP : FES: PG TEST 2016-17/01**).

Date :

SIGNATURE OF THE BIDDER

 Bharat Heavy Electricals Limited Boiler Auxiliaries Plant, Ranipet –632 406 FES DEPARTMENT Ranipet	STATUTORY REQUIREMENT OF CONTRACT ES : F : 009

DECLARATION SHEET

(FORMAT - To be typed written in LETTER HEAD and submitted along with offer)

I,
 hereby certify that all the information and data furnished by me with regard to this Tender Specification No. **BAP : FES: PG TEST 2016-17/01** are true and complete to the best of my knowledge. I have gone through the specification, conditions and stipulations in detail and agree to comply with the requirements and intent of specifications. Further certify that I am duly authorized representative of the under mentioned Bidder and a valid power of Attorney to this effect is also enclosed.

BIDDER'S NAME AND ADDRESS:

AUTHORISED REPRESENTATIVE'S
 SIGNATURE
 WITH NAME
 AND ADDRESS

 Ranipet	Bharat Heavy Electricals Limited Boiler Auxiliaries Plant, Ranipet - 632 406 FES DEPARTMENT		STATUTORY REQUIREMENT OF CONTRACT ES : F : 009	
			Page No.: 09 of 11	
<u>FINANCIAL VIABILITY (Annexure-A)</u>				
Sl	Aspects		Rs.	To be filled-up
1	Owner's Capital in the business (In case of Partnership please Mention percentage of shares and Amount)		Rs.	
2	Quantum of business done during Last three financial years.	Year 20 __ - __	Rs.	
		Year 20 __ - __		
		Year 20 __ - __		
		(Year 20__ - __)		
3	Value of Fixed Assets of the business in last three years	Year 20 __ - __	Rs.	
		Year 20 __ - __		
		Year 20 __ - __		
		(Year 20__ - __)		
4	Guarantee limits (if any) Enjoyed by the firm		Rs.	
5	Overdraft limits (if any) Enjoyed by the firm		Rs.	
6	Income Tax paid during the last three Years	Year 20 __ - __	Rs.	
		Year 20 __ - __		
		Year 20 __ - __		
		(Year 20__ - __)		
7	Please state whether audited profit and Loss Account and Balance Sheet for last 3 Years and Solvency Certificate are Enclosed.			Yes / No
Note: All the above documents should be duly certified by auditors/bank as may be applicable.				
Signature of the Bidder				

 Ranipet	Bharat Heavy Electricals Limited Boiler Auxiliaries Plant, Ranipet –632 406 FES DEPARTMENT		STATUTORY REQUIREMENT OF CONTRACT ES : F : 009
			Page No.: 11 of 11
ANALYSIS OF UNIT RATE QUOTED (Only Percentages to be Quoted)			
SI-No	Description	Percentage of the rate quoted	Remarks, If any
1	Fixed expenses towards a. b. c. etc		
2	Salary & wages for staff and workers		
3	Overheads		
4	Extra work incidental to Testing		
NOTE: All Bidders are requested to take care that the rates quoted by them are not disclosed in any way while furnishing the above details.			
Date :		SIGNATURE OF THE BIDDER	

ENVIRONMENTAL PROTECTION AGENCY

**PERFORMANCE TEST PROCEDURE
OF
ELECTROSTATIC PRECIPITATOR**



©

The copy right of all documents, drawings and other instruments are the property of Bharat Heavy Electricals Limited. This shall not be used without their express written permission in any form or part thereof for any other purposes than for which this publication is sent to the receiver.

1999

Publication No. BAP 0003 – 01

Issued by

TECHNICAL SERVICES
ENGINEERING AND DEVELOPMENT CENTRE
BHARAT HEAVY ELECTRICALS LIMITED
RANIPET - INDIA



4.3 PARTICULATE SAMPLING EQUIPMENT

A Thimble sampling Train (TST) is used for this purpose. The main function of TST is sampling a portion of the particulate laden flue gas at iso-kinetic sampling rate to separate and retain the particulate for weighing and to measure the quantity of gas sampled. The Fig 11.1 shows the scheme of Thimble Sampling Train used for the test. The main parts of the sampling equipment are briefly described in the following pages.

4.3.1 FILTER HOLDER WITH SAMPLING PROBE

The Fig 11.2 shows details of the probe, filter holder and probe holder. The filters are made of borosilica quartz or glass fibre and can withstand temperatures upto 300° C. The filters are in the form of thimbles of size 30mm diameter and length 77mm approximately. The parts of the probe and holder are made of acid resistant steel. The length of the sampling tube can be adapted to the duct dimensions.

The standard probe including the tube parts may reach a length of 3200mm and can be extended further by using extension tubes. The filter holder is used to house the nozzles with inside diameters of 5 mm to 12 mm. Each nozzle is designed in such a way that a static pressure recovery is obtained before the inside pressure connection in order to compensate the flow losses through the nozzles.

The inlet diameter of the nozzle to be selected for sampling is dependent upon the volume capacity of the sampling train.

4.3.2 VACUUM PUMP

The main function of the pump is to extract flue gas at the iso-kinetic rate through the probe. The pump used for this purpose is a 4 cylinder diaphragm pump of Neuberger make.



Bharat Heavy Electricals Limited

4.3.3 INSTRUMENT CASE

The Fig. 11.3 and Fig 11.4 show the measuring functions of the instrument case as well as the controls.

At the inlet of the case, there is a gas cooler from which the condensate flows down into the condensate bottle. The remaining water content of the gas i.e. water at gas meter is determined by measuring the dry bulb and wet bulb temperatures at gas meter.

In order to avoid humidity in the gas meter, the gas is reheated by flushing the gas meter section in the TST case with hot air from a power controlled hot-air fan. A thermostat has been provided to control the temperature which is normally set at 50° C. The digital temperature indicator provided also shows the temperature at the outlet of the gas meter, wet bulb and dry bulb. The wet bulb temperature is obtained via a gas flushed thermocouple provided with a wet sock which is moistened continuously from the water reservoir. All the thermocouples used are of chromel – alumel (K type).

The gas meter used is of Elster make and type G-4 and indicates the rate of flue gas sampled. The maximum capacity of gas meter is 3 to 6 m³/hr.

The flow is mainly controlled by means of coarse control and fine control valves. The fine control valve is used for small gas flow and to avoid high suction between the main control valve and the vacuum pump.

4.4 CALIBRATION REQUIREMENT

The instruments like pitot tubes, and gas meters, thermocouples and digital temperature indicators are calibrated at periodic intervals to check for the accuracy at BHEL/ R&D and other reputed institutions in India.



9.0 TEST PROCEDURE

On arrival at the plant, the test team should check that all the preparations are done and ensure that the best operating conditions are prevailing for conducting the test. The instruments for the measurement should be located at the correct places and checked for their operational soundness before start of the test. The testing procedure is discussed in detail as follows.

9.1 PREPARATION OF FILTER

The filters together with the glass jars are marked for identification. They are placed in oven without lid on the jars and dried for about 2 hours approximately at the same temperature as that in the flue gas duct where the measurements are to be taken, but not less than a temperature of 110° C. The filters are then allowed to cool in a desiccator with lid on the jar for about 30 min. The desiccator should be placed close to the balance to avoid temperature difference. The lid of the jar should be lifted momentarily to equalise the pressure difference immediately before weighing. The thimble weighing period is recommended to be as short as possible. All weights shall be recorded on a suitable test sheet.

9.2 GAS FLOW MEASUREMENT

A traversing is made with pitot tube at the sampling cross section. The number of points over the measurement cross section depends of geometry and dimensions of the duct. It is important that the pitot tube is distinctly marked so that the measurements are always made at the same point each time a traversing is performed.

The dynamic pressure is read from a micro-manometer. It is then converted into velocity at each sampling point and total gas flow in the duct is calculated.

To measure the temperature of the gas, a thermocouple is fastened to the pitot tube and readings of both temperature and dynamic pressure are recorded in a traverse log sheet.



9.3 SELECTION OF PROBE NOZZLE DIAMETER

The diameter of the probe nozzle is chosen considering the capacity of the measuring equipment and the highest velocity measured during the pitot traverse. The maximum capacity of the equipment is around 50 lit/min at the gas meter. However, there may be variations due to the type of the pump and the penetration of the dust into the measuring filter.

The nozzle diameter is selected based on the assumed gas flow rate and moisture content in the flue gas. The biggest possible sampling constant, Kn is calculated as follows.

$$Kn = \frac{q}{v\sqrt{\gamma_t} \times (\sqrt{\gamma_t})/\gamma_o \times \sqrt{(760/Bp)}}$$

Where

- Kn = Biggest possible sampling constant (proportional to nozzle area)
- q = Assumed gas flow rate through the gas meter, lit/min.
- $v\sqrt{\gamma_t}$ = as defined in 4.2 (for maximum measured)
- $(\sqrt{\gamma_t})/\gamma_o$ = obtained from the table 15.1 to 15.16
- γ_t = Assumed density of gas at test condition, kg/ m³.
- γ_o = Assumed density of gas at standard condition 760 mmHg and 0° C.
- $\sqrt{(760/Bp)}$ = Correction for barometric pressure.
- Bp = Barometric pressure in mmHg.

Based on the sampling constant, the assumed moisture content in the flue gas and the gas meter temperature, the nozzle diameter is obtained from the table 14.1 to 14.7. Nozzles of diameter smaller than 5 mm are not recommended except for special conditions such as high gas velocities. Based on our experience, it is recommended to use nozzle of diameter 5 mm.



SCHEME OF THIMBLE SAMPLING TRAIN

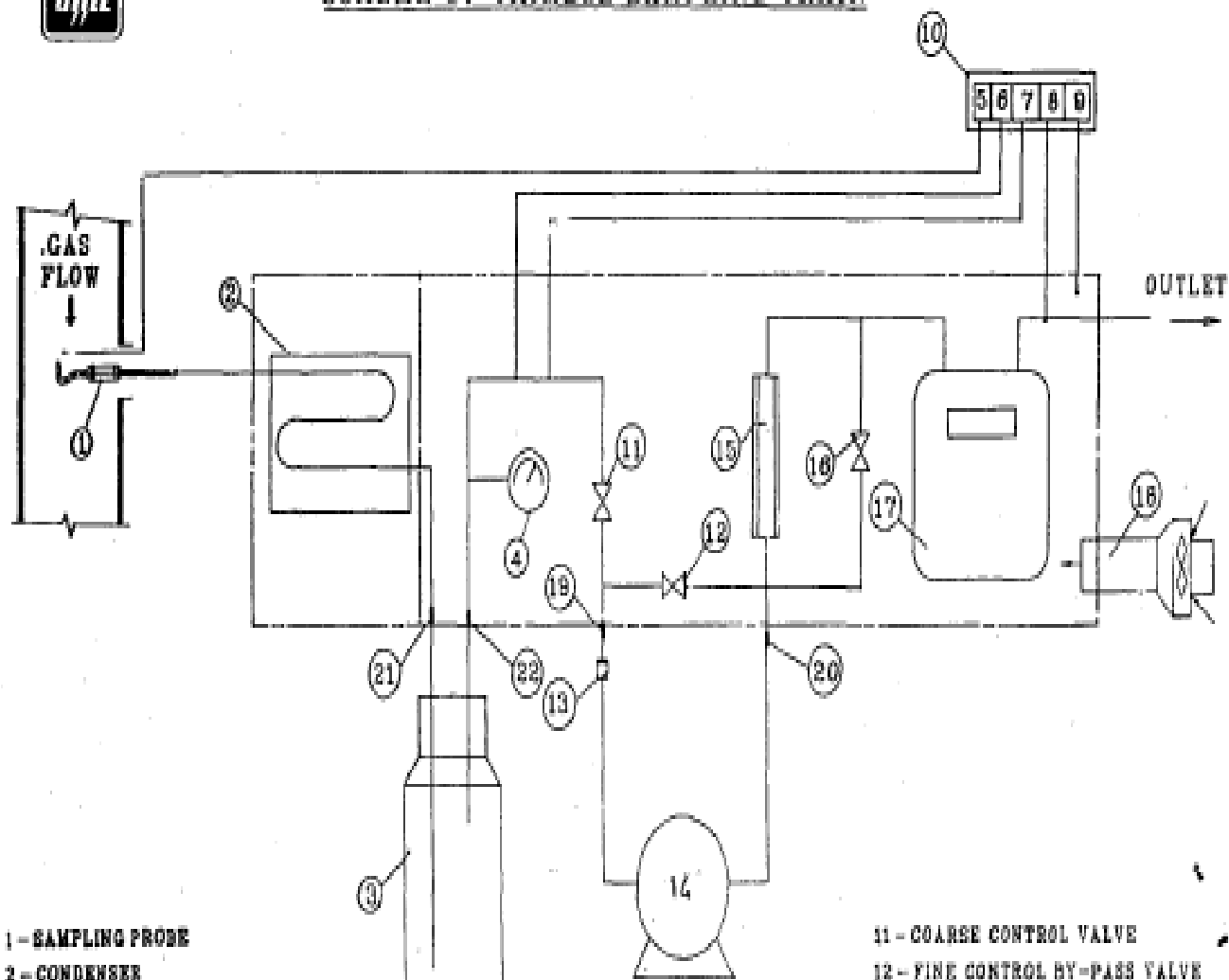

- 1 - SAMPLING PROBE
- 2 - CONDENSER
- 3 - CONDENSER BOTTLE
- 4 - VACUUM GAUGE
- 5 - FLUE GAS TEMPERATURE
- 6 - DRY BULB TEMPERATURE
- 7 - WET BULB TEMPERATURE
- 8 - GAS METER TEMPERATURE
- 9 - INSTRUMENT CASE TEMPERATURE
- 10 - DIGITAL TEMPERATURE INDICATOR

- 11 - COARSE CONTROL VALVE
- 12 - FINE CONTROL BY-PASS VALVE
- 13 - PROTECTIVE FILTER
- 14 - VACUUM PUMP
- 15 - FLOW INDICATOR
- 16 - FLOW INDICATOR BY-PASS VALVE
- 17 - GAS METER
- 18 - HEATER
- 19 - 22 CONNECTIONS



SAMPLING PROBE

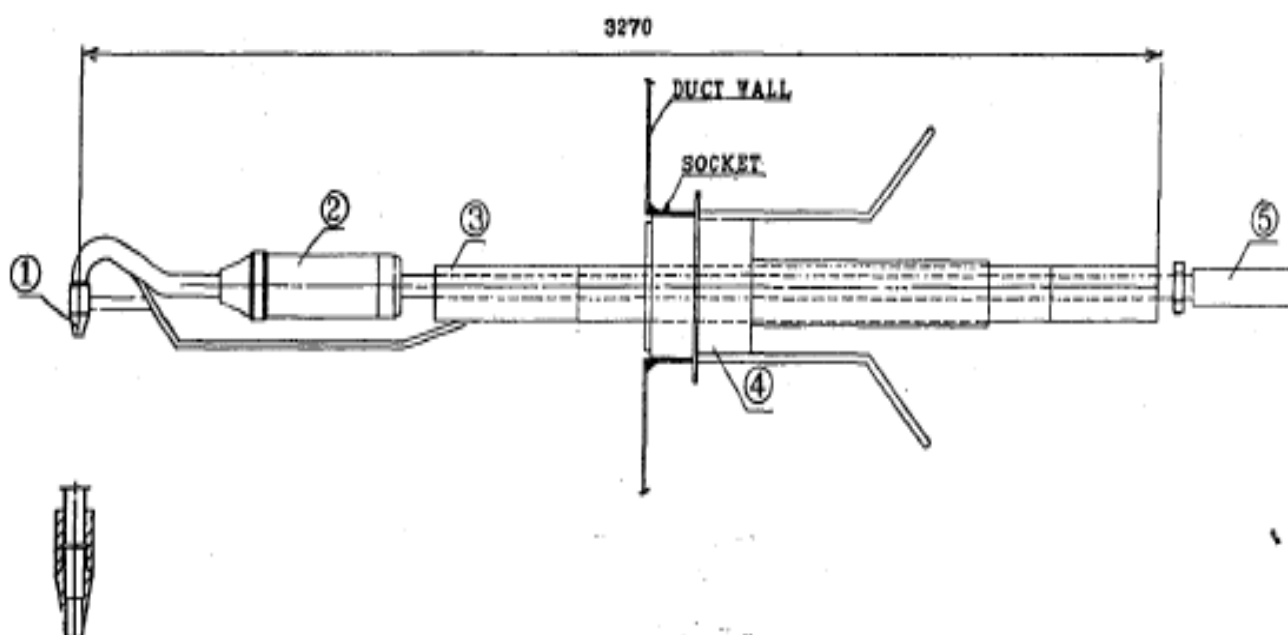

1. NOZZLE TIP
2. FILTER HOLDER
3. SAMPLING TUBES
4. PROBE HOLDER
5. RUBBER HOSE

FIG 11.2

THIMBLE SAMPLING TRAIN - FRONT VIEW

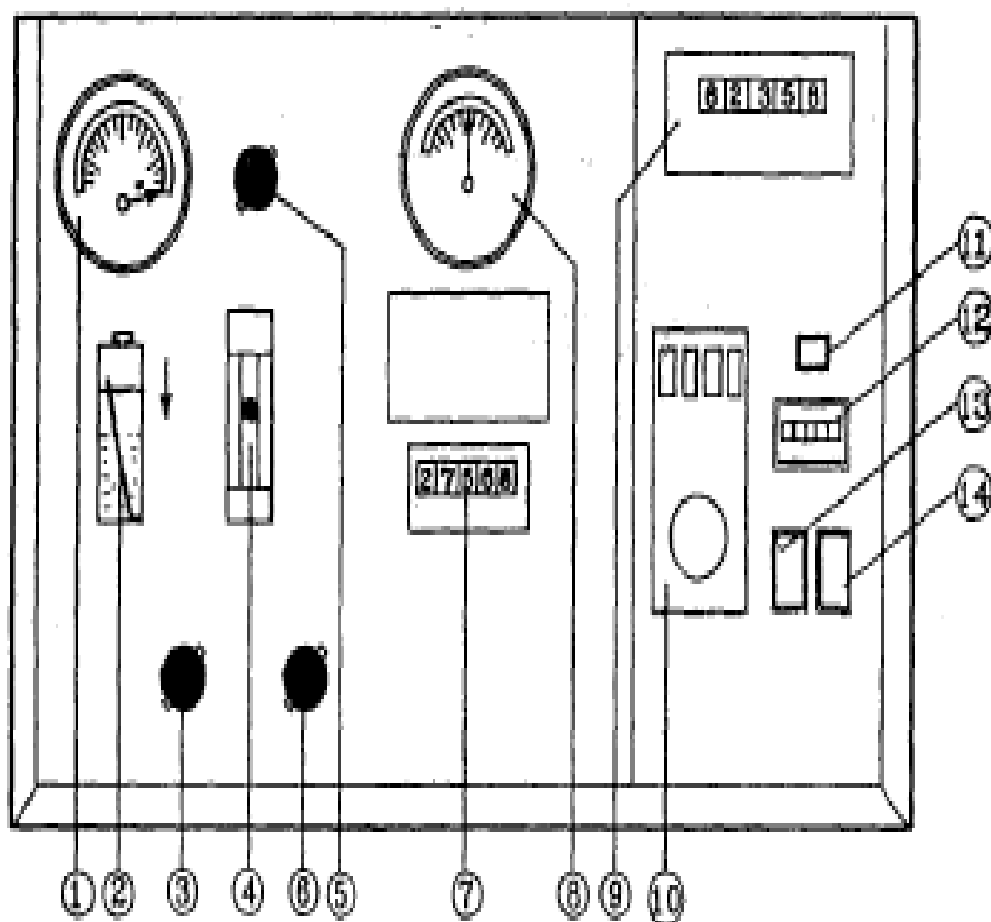

- | | |
|--------------------------------|--|
| 1. VACUUM METER | 8. DIFFERENTIAL PRESSURE GAUGE |
| 2. WET TEMPERATURE RESERVOIR | 9. DIGITAL TEMPERATURE INDICATOR |
| 3. FLOW INDICATOR BYPASS VALVE | 10. REGULATOR - HEATING OF INSTRUMENT CASE |
| 4. ROTAMETER | 11. INDICATING LAMP |
| 5. COARSE CONTROL VALVE | 12. OPERATING TIMER |
| 6. FINE CONTROL VALVE | 13. MAIN SWITCH |
| 7. GAS METER | 14. PUMP SWITCH |

FIG. 11.3

THIMBLE SAMPLING TRAIN - REAR VIEW

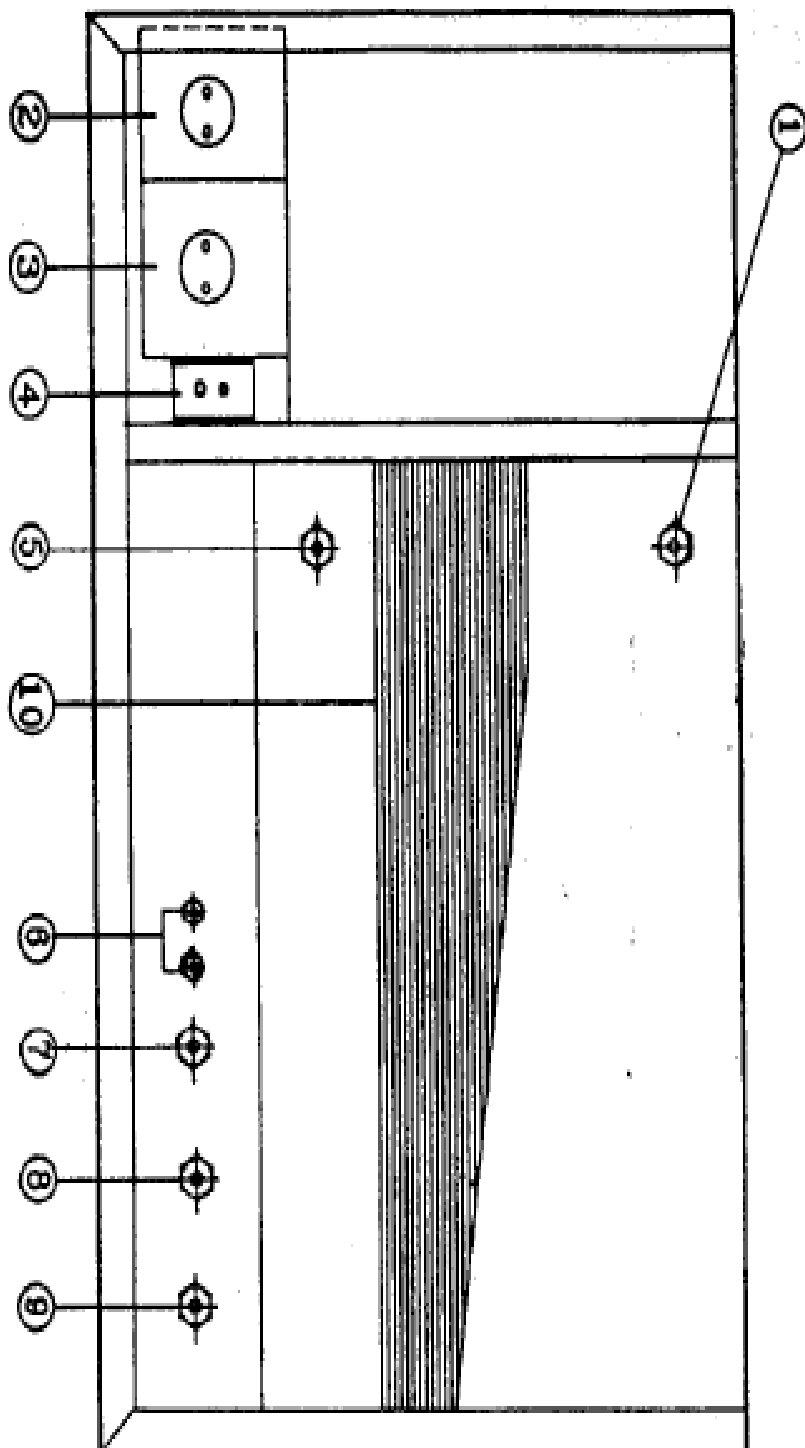

- | | |
|---|--|
| <ol style="list-style-type: none"> 1. CONNECTION FROM PROBE 2. POWER SUPPLY - PUMP 3. POWER SUPPLY - AUX. 4. THERMOCOUPLE CONNECTION 5. CONDENSER OUTLET TO BOTTLE | <ol style="list-style-type: none"> 6. PRESSURE CONNECTIONS FROM PROBE 7. OUTLET TO PUMP 8. INLET TO PUMP 9. FROM CONDENSER BOTTLE 10. DRYER |
|---|--|

TEST DATA SHEET 12.1

AQCS : PT :
PAGE NO. :

Project :	Unit No. :	Date :
Gas patch : Location :	Test No. :	Time :
Assumed density (γ_a) : Kg/Nm ³	Duct area : m ²	
Assumed moisture content : % vol	Ambient temperature : °C	
Sampling time/point : min.	Total Sampling time : min.	
Nozzle diameter : mm	Barometric pressure : mmHg	
PITOT TUBE NO. :	Static Pressure : mmWc	
Calibration constant (Kp) :	FLUE GAS ANALYSIS BY VOLUME	
GAS METER No. :	CO ₂ : %	O ₂ : %
Calibration constant (Kg) :	Sampling rate calculation	
GAS METER READING	$= K_{Tot} \times \frac{1}{Kg} \times K_p \sqrt{\gamma t}$ $= \quad \quad \quad \times K_p \sqrt{\gamma t}$ $= \quad \quad \quad \times K_p \sqrt{\gamma t} \text{ lit/min.}$	
Stop : m ³	$K_{BAR} = \sqrt{\frac{760}{B_p}}$	
Start : m ³	* From tables	
Sampled volume : m ³	$K_{Tot} = \frac{\sqrt{\gamma t}}{\gamma_o} \times K_{BAR} \times K_{UTS}$	
Jar / Thimble No. :		
Gross weight (gms) :		
Tare weight (gms) :		
Dust weight (gms) :		
Average flue gas temp. : °C	Average dry bulb temp. : °C	
Average gas meter temp. : °C	Average Kp V ft :	
Average wet bulb temp. : °C	Condensate measured : gms	
REMARKS		
BHEL :: RANIPET	BHEL :: SITE	CUSTOMER



BOILER CONTROL ROOM DATA
Readings are to be recorded every 30 minutes

PROJECT :		UNIT :	TEST NO :	DATE :				
TEST TIME		Hrs.						
01.	BOILER LOAD	MW						
02.	MAIN STEAM FLOW	T/hr.						
03.	MAIN STEAM TEMP.	°C						
04.	ECO. INLET TEMP.	°C						
05.	ECO. OUTLET TEMP.	°C						
06.	HP HEATERS IN SERVICE							
07.	NO. OF COAL MILLS							
08.	NO. OF OIL BURNERS							
09.	COAL FLOW	T/hr.						
10.	TOTAL AIR FLOW	T/hr.						
11.	FLUE GAS TEMP. AT APH INLET, °C	LEFT						
		RIGHT						
12.	FLUE GAS TEMP. AT APH OUTLET, °C	LEFT						
		RIGHT						
13.	PA TEMP. AT APH OUTLET, °C	LEFT						
		RIGHT						
14.	SA TEMP. AT APH OUTLET, °C	LEFT						
		RIGHT						
15.	FD FAN CURRENT amps.	LEFT						
		RIGHT						
16.	ID FAN CURRENT amps.	1						
		2						
		3						
BHEL/RANIPET		BHEL/SITE		CUSTOMER				

Typical layout of test pocket location for 500 / 600 MW

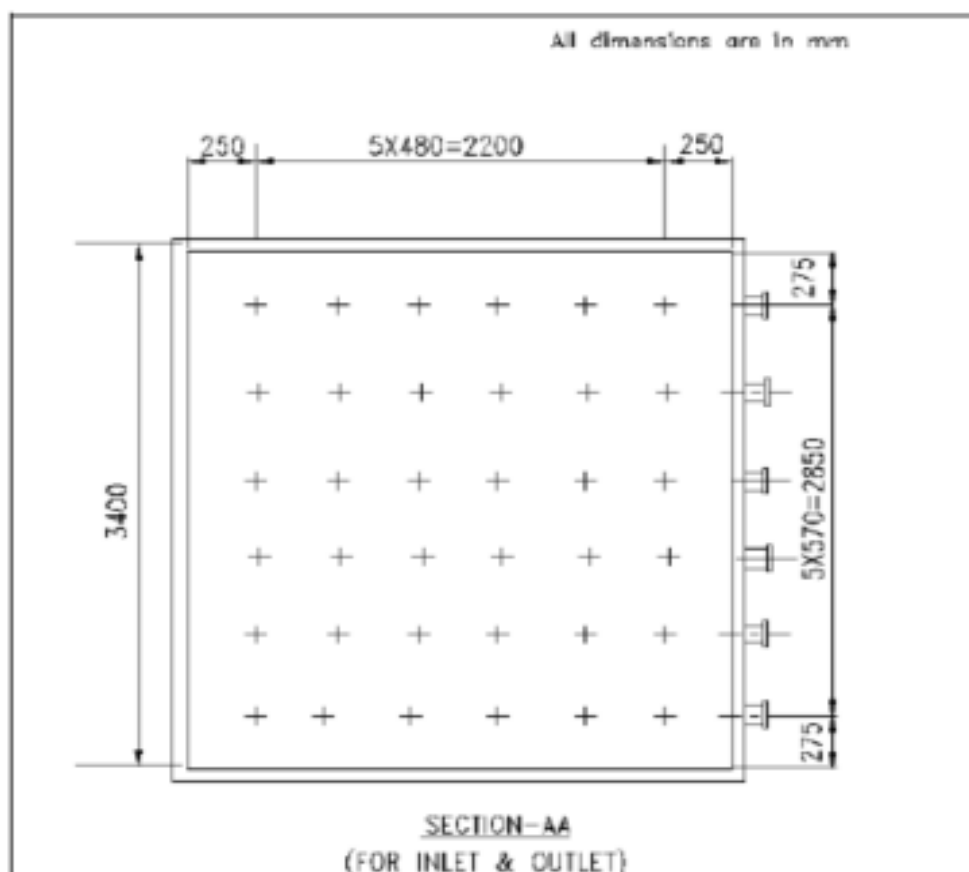
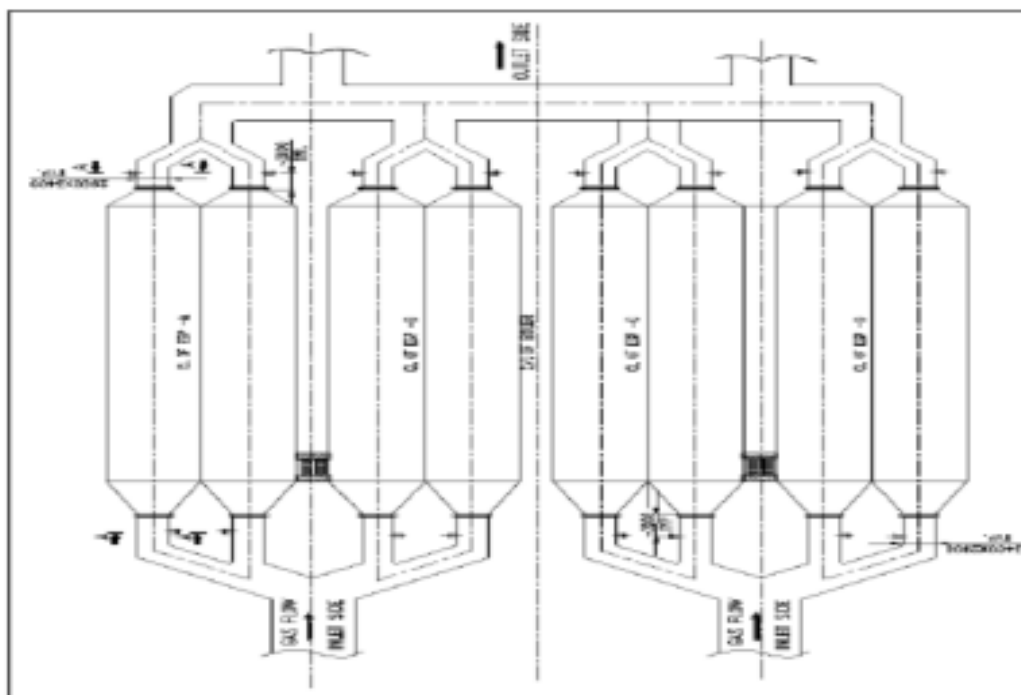

Typical layout of test pocket location for 200 / 210 MW

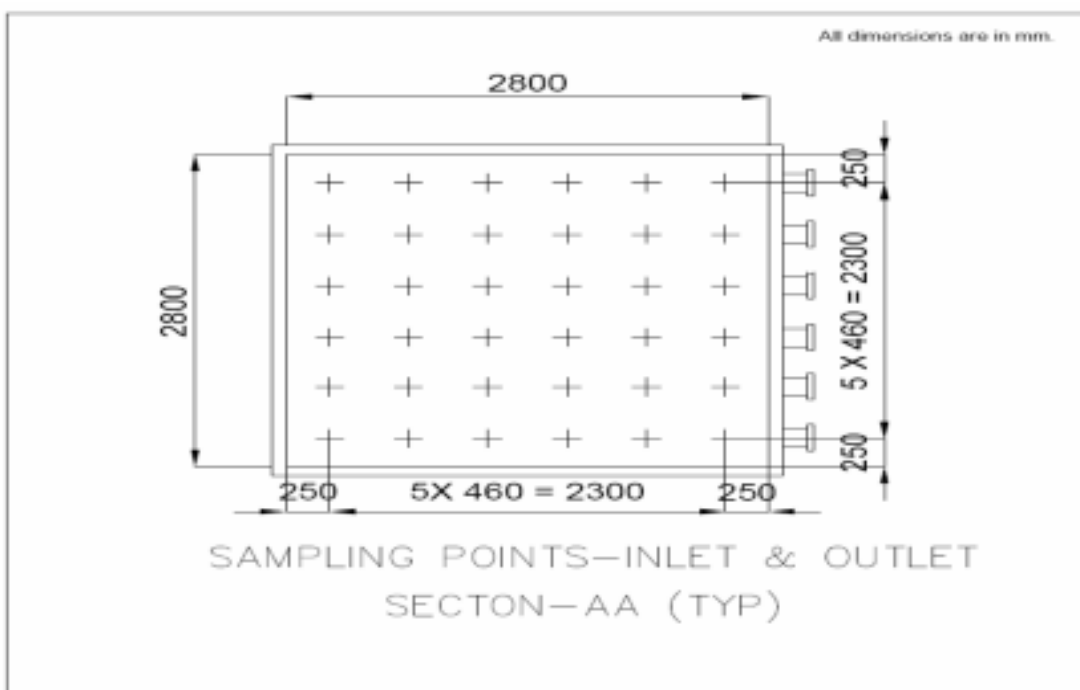
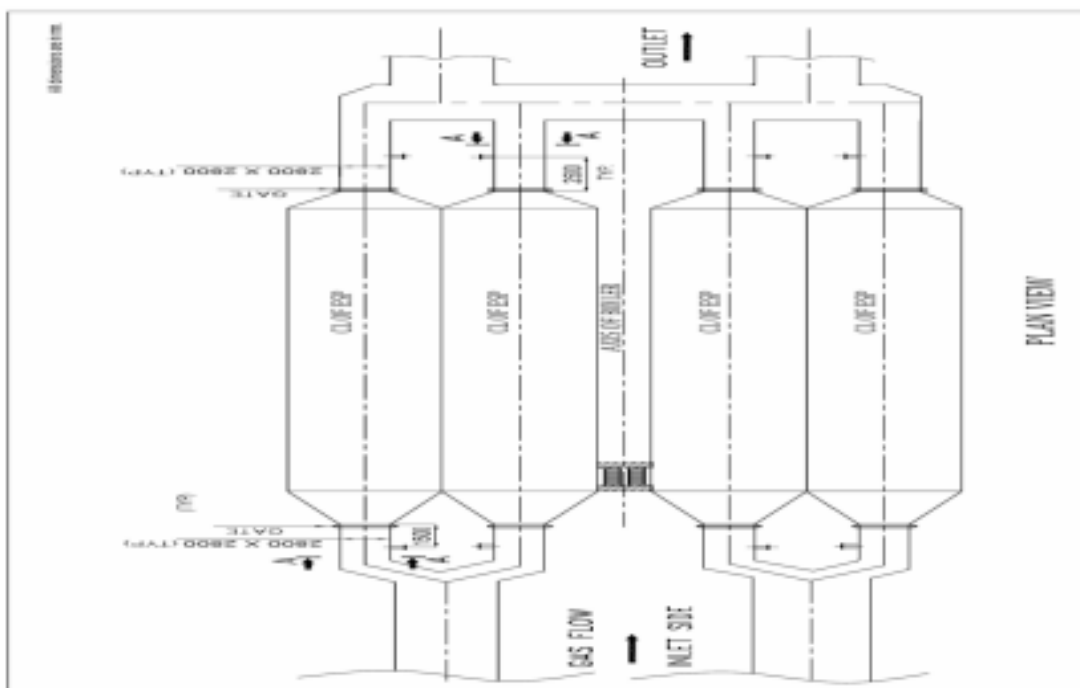

TENDER DOCUMENT (TENDER SPECN No : BAP : FES: PG TEST 2016-17/01)**Price-Bid** to be submitted along with Part-II ie. Price Bid

Name Of Work : (For Detailed Scope Of Work Please Refer The Tender Specification.)

NAME OF WORK: Conducting Performance Guarantee Test in Electrostatic Precipitator (ESP) at various Power Plants as per laid down procedure. The objective is to determine the collection efficiency, pressure drop and auxiliary Power consumption of Electrostatic Precipitator. The collection efficiency to be calculated based on the dust concentrations at the inlet and outlet of precipitator. The scope of this work involves (A) Measurement of parameters like flue gas flow rate, flue gas temperature, dust concentration at the inlet & outlet of electrostatic precipitator, corona / auxiliary power measurements. (B) Providing of skilled man power for the above scope of work.

Rate Sch. No.	RS-1 Description Cluster-I - Non-NTPC	Qty	Unit	Rate In Rs.	Total rate in Rs.
1A (Part-A)	Man Power Cost as detailed in Cl. 2.2.1 (page 10) for Conducting of PG Tests at a Non-NTPC Unit (Having 4 ESPs) of 500MW rating and above in Cluster-I.	4	Rate as per part (A)		
1B (Part-B)*	To & Fro Conveyance as detailed in Cl.2.2.2 (page 10) for Conducting of PG Tests at a Non-NTPC Unit (Having 4 ESPs) of 500MW rating and above in Cluster-I.	4	Rate as per part (B)		
	Total (1A + 1B) in Cluster-I	4	(A)+(B)		
	% of Service Tax Payable extra If any for Part-A+B in Cluster-I	%			
	Total (1A + 1B) inclusive of Service Tax for A in Cluster-I	4			

Rate Sch. No.	RS-2 Description Cluster-I - NTPC	Qty	Unit	Rate In Rs.	Total rate in Rs.
2A (Part-A)	Man Power Cost as detailed in Cl. 2.2.1 (page 10) for Conducting of PG Tests at a NTPC Unit (Having 4 ESPs) of 500MW rating and above in Cluster-I.	4	Rate as per part (A)		
2B (Part-B)*	To & Fro Conveyance as detailed in Cl.2.2.2 (page 10) for Conducting of PG Tests at a NTPC Unit (Having 4 ESPs) of 500MW rating and above in Cluster-I.	4	Rate as per part (B)		
	Total (2A +2B) in Cluster-I	4	(A)+(B)		
	% of Service Tax Payable extra If any for Part-A+B in Cluster-I	%			
	Total (2A + 2B) inclusive of Service Tax for A in Cluster-I	4			

Note: * Part-B includes fixed To and fro charges only and is expected to be same for both NTPC and Non-NTPC projects for each cluster.

**SIGNATURE OF THE
CONTRACTOR WITH SEAL**

TENDER DOCUMENT (TENDER SPECN No : BAP : FES: PG TEST 2016-17/01)**Price-Bid** to be submitted along with Part-II ie. Price Bid

Name Of Work : (For Detailed Scope Of Work Please Refer The Tender Specification.)

NAME OF WORK: Conducting Performance Guarantee Test in Electrostatic Precipitator (ESP) at various Power Plants as per laid down procedure. The objective is to determine the collection efficiency, pressure drop and auxiliary Power consumption of Electrostatic Precipitator. The collection efficiency to be calculated based on the dust concentrations at the inlet and outlet of precipitator. The scope of this work involves (A) Measurement of parameters like flue gas flow rate, flue gas temperature, dust concentration at the inlet & outlet of electrostatic precipitator, corona / auxiliary power measurements. (B) Providing of skilled man power for the above scope of work.

Rate Sch. No.	RS-3 Description Cluster-II - Non-NTPC	Qty	Unit	Rate In Rs.	Total rate in Rs.
3A (Part-A)	Man Power Cost as detailed in Cl. 2.2.1 (page 10) for Conducting of PG Tests at a Non-NTPC Unit (Having 4 ESPs) of 500MW rating and above in Cluster-II.	5	Rate as per part (A)		
3B (Part-B)*	To & Fro Conveyance as detailed in Cl.2.2.2 (page 10) for Conducting of PG Tests at a Non-NTPC Unit (Having 4 ESPs) of 500MW rating and above in Cluster-II.	5	Rate as per part (B)		
	Total (3A + 3B) in Cluster-II	5	(A)+(B)		
	% of Service Tax Payable extra If any for Part-A+B in Cluster-II	%			
	Total (3A + 3B) inclusive of Service Tax for A in Cluster-II	5			

Rate Sch. No.	RS-4 Description Cluster-II - NTPC	Qty	Unit	Rate In Rs.	Total rate in Rs.
4A (Part-A)	Man Power Cost as detailed in Cl. 2.2.1 (page 10) for Conducting of PG Tests at a NTPC Unit (Having 4 ESPs) of 500MW rating and above in Cluster-II	3	Rate as per part (A)		
4B (Part-B)*	To & Fro Conveyance as detailed in Cl.2.2.2 (page 10) for Conducting of PG Tests at a NTPC Unit (Having 4 ESPs) of 500MW rating and above in Cluster-II	3	Rate as per part (B)		
	Total (4A + 4B) in Cluster-II	3	(A)+(B)		
	% of Service Tax Payable extra If any for Part-A+B in Cluster-II	%			
	Total (4A + 4B) inclusive of Service Tax for A in Cluster-II	3			

Note: * Part-B includes fixed To and fro charges only and is expected to be same for both NTPC and Non-NTPC projects for each cluster.

**SIGNATURE OF THE
CONTRACTOR WITH SEAL**

TENDER DOCUMENT (TENDER SPECN No : BAP : FES: PG TEST 2016-17/01)**Price-Bid** to be submitted along with Part-II ie. Price Bid

Name Of Work : (For Detailed Scope Of Work Please Refer The Tender Specification.)

NAME OF WORK: Conducting Performance Guarantee Test in Electrostatic Precipitator (ESP) at various Power Plants as per laid down procedure. The objective is to determine the collection efficiency, pressure drop and auxiliary Power consumption of Electrostatic Precipitator. The collection efficiency to be calculated based on the dust concentrations at the inlet and outlet of precipitator. The scope of this work involves (A) Measurement of parameters like flue gas flow rate, flue gas temperature, dust concentration at the inlet & outlet of electrostatic precipitator, corona / auxiliary power measurements. (B) Providing of skilled man power for the above scope of work.

Rate Sch. No.	RS-5 Description Cluster-III - Non-NTPC	Qty	Unit	Rate In Rs.	Total rate in Rs.
5A (Part-A)	Man Power Cost as detailed in Cl. 2.2.1 (page 10) for Conducting of PG Tests at a Non-NTPC Unit (Having 4 ESPs) of 500MW rating and above in Cluster-III.	6	Rate as per part (A)		
5B (Part-B)*	To & Fro Conveyance as detailed in Cl.2.2.2 (page 10) for Conducting of PG Tests at a Non-NTPC Unit (Having 4 ESPs) of 500MW rating and above in Cluster-III.	6	Rate as per part (B)		
	Total (5A + 5B) in Cluster-III.	6	(A)+(B)		
	% of Service Tax Payable extra If any for Part-A+B in Cluster-III.	%			
	Total (5A + 5B) inclusive of Service Tax for A in Cluster-III.	6			

Note: * Part-B includes fixed To and fro charges only and is expected to be same for both NTPC and Non-NTPC projects for each cluster.

**SIGNATURE OF THE
CONTRACTOR WITH SEAL**