







Revises पर प्रमाण SIGN & DATE		<b>उत्पाद मानक</b> <b>STEAM TURBINE ENGINEERING</b> <b>PRODUCT STANDARD</b>		<b>ST 29005</b>	
				पृष्ठ 23 का 1 Page 1 of 23	
SUPERSEDES INVENTORY NO.					BASED ON! BHEL EXPERIENCE
सभी सूची संख्या में अतिरिक्त संख्या में					
<b>COPYRIGHT AND CONFIDENTIAL</b> The information on this document is the property of Bharat Heavy Electrical Limited. It must not be used directly or indirectly in any way detrimental to the interest of the company.					
<b>SPECIFICATION FOR          THERMAL INSULATION</b>					
<b>FOR T.G. INTEGRAL          PIPING SYSTEM</b>					
<b>स्वत्वधिकार एवं गोपनीय</b> इस दस्तावेज़ में प्रदान किये गये विवरण/सूचना की सुरक्षा के अर्थ में सुरक्षा प्रदान की जा सकती है। इस दस्तावेज़ को बिना अनुमति के किसी भी प्रकार का प्रयोग, प्रतिलिपि बनाना, प्रसारित करना, या किसी भी प्रकार का उपयोग करना वर्जित है।					
सभी सूची संख्या INVENTORY NO.	सभी सूची संख्या में अतिरिक्त संख्या में				
Revises पर प्रमाण SIGN & DATE	1-12-03				
INVENTORY NO. P-5788	सहमत विभाग AGREED DEPTT.	नाम NAME	दिनांक एवं हस्ताक्षर DATE & SIGNATURE	अनुवादक TRANSLATED BY	कार्यकर्ता WORKED BY
	TSX	S.S. CHAUHAN		S.K. GUPTA	 12-11-03
	TSX	KISHAN LAL	 27-11-03	S.K. GUPTA	 12-11-03
	SUPERVISED BY	V.K. GUPTA	 12-11-03		
APPROVED : (B.K. BHALLA) AGM (STE)					ST 8.20
REV. NO. 04 Dt. 04-02-05	PREPARED : STE		ISSUED : STE (TL)	DATE : 1-6-89	

प्रमाणित करने के लिए SIGN & DATE  11/11/03	<b>उत्पाद मानक</b> <b>PRODUCT STANDARD</b> <b>STEAM TURBINE ENGINEERING</b>		<b>ST29005</b> पृष्ठ 23 का 02 Page 02 of 23	
SUPERSEDES INVENTORY NO.	<b>1.0 INTRODUCTION</b> <p>In a thermal power station, thermal insulation of all piping carrying hot fluids is essential for heat economy and protection of operating personnel. In any pipe which is at a temperature higher than its surroundings will loose heat and the amount of heat lost will depend upon the temperature of the fluid conveyed and the thermal conductivity of the piping material. The heat lost through bare pipes increases with:</p> <p>(a) Increase in the temperature of fluid conveyed.</p> <p>(b) Air velocity of the surroundings.</p> <p>Providing proper and adequate insulation on to the facilities and equipments controls heat transfer and maintain the required skin temperatue. The use of high quality insulation can return 20% or more per year on the investment.</p>			
जारी की जाने वाली अधिकतम संख्या	<b>2.0 SCOPE</b> <p>This specifications covers the design, technical requirements and essential particulars for the supply, application &amp; finishing of the thermal insulation complete with all auxillary materials for the integral piping systems for thermal power stations. Thermal insulation will be applied over integral steam piping having a rated operated temperature of above 60°C for the protection of the operating person &amp; for energy conservation.</p> <p>2.1 The scope of supply shall be defined in data sheet of the project.</p> <p>(a) The description of the components to be insulated.</p> <p>(b) Maximum continuous operating temperature of the components.</p> <p>(c) Design ambient temperature.</p> <p>(d) Type of insulation ordered.</p> <p>(e) Cold face temperature of the insulation above ambient.</p> <p>(f) Other instruction and notes concerning the design, manufacture and supply of insulation.</p> <p>2.2 Attachment, devices &amp; accessories shall form the part of the scope of supply.</p> <p>2.3 Application of the insulation shall be done at site after consultation with or at the request of the chief of the erection group of BHEL at site.</p> <p>2.4 in case the requirements specified in the data sheet for a particular project are different than what is given in this specification, the data sheet requirements shall be considered as final and binding for that project.</p> <p>2.5 The pipe lengths given in data of the insulation schedule are inclusive of the equivalent length of tees/stub and reducer. The vertical / near vertical runs of piping are included in the pipe length given in the data of insulation schedule. Additional supporting arrangements are required for insulation on vertical / near vertical piping. The bidder should include the charges for these supporting arrangements in the contract cost based on his experience. No breakup of vertical and horizontal runs are to be furnished to the bidder.</p>			
COPYRIGHT AND CONFIDENTIAL The information on this document is the property of Bharat Heavy Electrical Limited. It must not be used directly or indirectly in any way detrimental to the interest of the company.	<b>स्वाधिकार एवं गोपनीय</b> इस प्रलेख में दी गई सूचना भारत भारी वल्टीज लिमिटेड की संपत्ति है। इसका प्रयोग एवं प्रसारण केवल ही लिखित की आज्ञा के बिना नहीं किया जा सकता।			
जारी की जाने वाली INVENTORY NO. P-5788	REV. NO. 04	निर्माणांक WORKED BY S.K.G.		12-11-03
		जांचकर्ता CHECKED BY V.K.G.		12-11-03

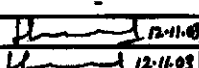
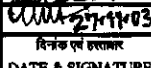
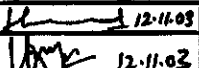
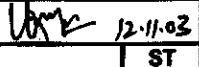
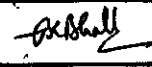
Review by SIGN & DATE		<b>उत्पाद मानक</b>  <b>STEAM TURBINE ENGINEERING PRODUCT STANDARD</b>	<b>ST29005</b>  पृष्ठ 23 का 3  Page 3 of 23								
SUPERSEDES INVENTORY NO.  जारी की गयी वन संख्या का क्रम	<p>2.6 Data furnished for the items to be insulated is based on pipe erection drawings. No physical measurement of insulation work will be done. The conversion factors for the valve and fittings will be taken from IS:14164.</p> <p>3.0 <b>DESIGN AND PERFORMANCE REQUIREMENTS</b></p> <p>3.1 For the design of the insulation shall be assumed that the surface temperature of the equipment is taken equal to the temperature of the steam. Heat loss at the surface of insulation shall not exceed 180 Kcal / m<sup>2</sup>h unless specified in data sheet.</p> <p>3.2 In principal all the equipments operating above 60°C shall be insulated. However the contractor shall be guided by BHEL regarding the scope as per clause No.2.</p> <p>3.3 If the ambient temperature is not specified in the data sheet, the same shall be assumed as 40°C.</p> <p>3.4 Insulation thickness shall be completed based on the design parameters given in data sheet of the project. The thickness given in insulation schedule shall be reviewed by the bidder.</p> <p>3.5 Insulation shall be supplied in thickness 25, 40, 50, 65 and 75mm. Higher thickness shall be made up in multiple layers from them. The breakup of thickness of multiple layers is given under the column insulation thickness in the insulation schedule.</p> <p>4.0 <b>MATERIALS</b></p> <p>4.1 <b>INSULATING MATERIALS</b></p> <p>The insulating materials and protective covering shall be new and fresh, incombustible, non-hygroscopic and shall be guaranteed to withstand continuously and without deterioration the maximum temperature to which they will be subjected under the specified application. The insulation material and any component of the finished insulation job shall not react chemically by itself or in combination with water or moisture to form the substances which are more actively corrosive to the applied surfaces than water or moisture alone. The material shall not offer substance to fungus or vermin and must not pose a health hazard. The bidder shall submit with the bid the details of application of protective coatings or other methods he proposes to use for corrosion protection of insulated surface.</p>										
<b>COPYRIGHT AND CONFIDENTIAL</b>  The information on this document is the property of Bharat Heavy Electrical Limited. It must not be used directly or indirectly in any way detrimental to the interest of the company											
<b>स्वत्वाधिकार एवं गोपनीय</b>  यह दस्तावेज की सभी सूचनाएं भारत भारती इलेक्ट्रिकल्स की संपत्ति हैं। इनका प्रयोग केवल भारत भारती इलेक्ट्रिकल्स के लिए ही किया जा सकता है। अन्य किसी भी उद्देश्य के लिए इन सूचनाओं का प्रयोग करना गैर कानूनी है।											
जारी की गयी SIGN & DATE  14.8.04											
जारी की गयी INVENTORY NO.  P-5788	REV. NO.  04		<table border="1"> <tr> <td>निर्माणकर्ता WORKED BY</td> <td>S.K.G.</td> <td><i>Handwritten Signature</i></td> <td>7/7/04</td> </tr> <tr> <td>जांचकर्ता CHECKED BY</td> <td>V.K.G.</td> <td><i>Handwritten Signature</i></td> <td>7.7.04</td> </tr> </table>	निर्माणकर्ता WORKED BY	S.K.G.	<i>Handwritten Signature</i>	7/7/04	जांचकर्ता CHECKED BY	V.K.G.	<i>Handwritten Signature</i>	7.7.04
निर्माणकर्ता WORKED BY	S.K.G.	<i>Handwritten Signature</i>	7/7/04								
जांचकर्ता CHECKED BY	V.K.G.	<i>Handwritten Signature</i>	7.7.04								

SIGN & DATE		PRODUCT STANDARD		ST 29005
		STEAM TURBINE ENGINEERING		PAGE 4 OF 23
SUPERSEDES INVENTORY No.	<p>The material of insulation used for mattress shall be bonded mineral (rock) as per IS8703.</p> <p>If prefabricated pipe sections are used, it shall be as per IS9842.</p>			
COPYRIGHT AND CONFIDENTIAL The information on this document is the property of BHARAT HEAVY ELECTRICALS LIMITED. It must not be used directly or indirectly in any way detrimental to the interest of the company.	<p><b>4.2 SHEATHING MATERIAL</b></p> <p>The sheathing material for all insulated piping &amp; equipment shall be aluminium sheet conforming to IS 737. Unless otherwise specified in Data sheet, the thickness of aluminium sheathing to be used shall be as follows:</p> <p>a) Pipes of 450 mm (18 inch.) and above; over outside diameter of insulation :- 1.219 mm (18 SWG).</p> <p>b) Pipes of 150 mm (6inch) and above; over outside diameter of insulation :- 0.914 mm (20 SWG).</p> <p>c) Pipes less than 150 mm (6inch); over outside diameter of insulation :- 0.711 mm (22SWG)</p>			
	<p><b>4.3 BINDING &amp; LACING WIRE</b></p> <p>Binding &amp; lacing wire shall be 20 SWG galvanized steel wire. Where interface temperature is 400°C or more, the binding wire shall be 20 SWG stainless steel wire.</p>			
<p><b>4.4 STRAPS &amp; BANDS</b></p> <p>All straps &amp; bands shall be galvanized steel. For securing aluminium sheathing material, stainless steel or anodized aluminium bands shall be used. Bands shall be 20 mm wide &amp; 0.6 mm thick.</p>				
<p><b>4.5 SCREWS</b></p> <p>Screws shall be of self tapping type &amp; shall be cadmium/zinc plated.</p>				
SIGN & DATE	<p><b>5.0 APPLICATION OF INSULATION</b></p>			
INVENTORY No.	<p><b>5.1 GENERAL</b></p> <p>The application of thermal insulation is highly skilled job contrary to the general belief. Badly fitted/laid insulation can lead to greater heat loss or surface</p>			
P. 5788	REV. NO. 04	WORKED BY:— <i>Rigam</i>		CHECKED BY:— <i>Shinde</i>

22/6/89

SIGN & DATE	SIGN & DATE	INVENTORY No.	INVENTORY No.		<b>PRODUCT STANDARD</b> <b>STEAM TURBINE ENGINEERING</b>	ST 29005
						PAGE 5 OF 23
SUPERSEDES INVENTORY No.				temperature than that estimated & also to constant maintenance. Ample provision shall be made for maximum possible thermal movement & the insulation shall be applied in a manner which will avoid breaking or telescoping due to alternate periods of expansion & contraction. A single layer of insulation shall not be more than 75 mm thick. The following are some of the points to be considered in the application of insulation		
COPYRIGHT AND CONFIDENTIAL The information on this document is the property of BHARAT HEAVY ELECTRICALS LIMITED. It must not be used directly or indirectly in any way detrimental to the interest of the company.				a) Surfaces must be clean, dry, & free from grease, loose scale, moisture etc. before application of insulation. b) Insulation thickness on flanges & valves should be equal to that of the adjacent/associated pipes. c) Where contamination by chemicals or oil spillage is possible, it is important that precaution be taken to avoid contamination of insulation. d) Pipe hangers & supports and any penetrations should be covered in such a way that moisture cannot penetrate. e) The bare insulation must be stored in a proper place (indoor) to avoid contamination which will lead to change in weight & thermal conductivity values. f) Rigid sections should have staggered joints where more than one layer is involved & they must be held in close contact with pipe & fitting face by means of wire or bands.		
SIGN & DATE 27/1/89				<b>5.2 PIPING :-</b>		
INVENTORY No. P. 5788				<b>5.2.1</b> For insulation of piping with preformed pipe sections the same shall be applied over the pipe and finally insulation shall be held in position with 15 mm wide aluminium band at not greater than 400 mm spacing.		
REV. No. 04				<b>5.2.2</b> For insulation of piping with mattresses having backing GI wire or SS wire netting, the required lengths & shapes are cut from the blankets & wrapped on the piping with edges pulled together tightly at the longitudinal joint and secured by lacing wire & this joint shall be at lower side. If the interface temperature is 400°C or more the wire netting shall be from 20 SWG stainless steel wire and having hexagonal opening of 25 mm size. Otherwise each layer of mattress shall have GI wire netting from 20 SWG & having hexagonal opening of 25 mm size. The ends of all wire loops shall be firmly twisted together with pliers, bent over & carefully pressed into the surface of the insulation. Preformed insulation & mattress insulation on vertical or near vertical piping must be supported in position by means of metal rings & at intervals as per enclosed sketches. GI band/Aluminium bands are to be used for tightly securing the different layers of insulation.		
WORKED BY:— <i>Rizam</i>				CHECKED BY:— <i>Shankar</i>		

SIGN & DATE		PRODUCT STANDARD		ST 29005
		STEAM TURBINE ENGINEERING		PAGE 6 OF 23
SUPERSEDES INVENTORY No.		<p>should be cut lobster back finish and wired or strapped into position.</p> <p>5.2.4 All insulation shall be protected by an outer covering of aluminium sheathing. All insulation sheathing joints shall be sealed and made effectively weather &amp; waterproof. All flat surfaces shall be adequately sloped to prevent pools of water collecting. The sheathing shall be protected internally with two coats of anti corrosive paint as per IS 158. The jackets shall be installed with the longitudinal lap joint at 45° below the horizontal for horizontal pipes and the joints sealed with sealing compound. Arrangements for securing the metal finish over the insulation shall ensure that direct metal contact between the insulated surface and outer metal cladding is avoided. 4 mm thick asbestos board packing shall be used as interfaces to thermally isolate the metal covering from supporting arrangements. There shall be over lapping of 50 mm on both longitudinal &amp; circumferential joints. The screws shall be provided at not greater than 150 mm spacing. Sealing compound is to be applied at all sheathing joints. The overlapping in outer casing should always be at the bottom for horizontal piping so that no rain water enters into the insulation through the joints &amp; the lapping must be done so that water will have a natural drainage. In case of vertical &amp; inclined piping, circumferential overlapping is made such that no rain water enters into the insulation through the joints by proper lapping sequence.</p> <p>5.2.5 All joints in the insulation shall be staggered. For multiple layers of insulation the different layers shall be applied so that the butt joints of one layer do not coincide with those of the other layer.</p> <p>6.0 VALVES &amp; FLANGES INSULATION</p> <p>-----</p> <p>The insulation on all valves &amp; flanged joints shall be enclosed in a removable jacketing so that it may be removed without disturbing the concerned equipment or piping. The thickness of insulation shall be same as that of the pipe line in which these valves and fittings are located. A typical arrangements shown in drawing at sheet no 15.</p> <p>7.0 GENERAL INSTRUCTIONS FOR ERECTION OF INSULATION</p> <p>-----</p> <p>a) Persons doing the actual job can alter the method of fixing of sheet metal as and when necessary, only after consulting the concerned field engineer.</p> <p>b) Care shall be taken to see that the flexible insulation mattresses are not unduly compressed.</p> <p>c) The day to day insulation works are covered by sheathing or with suitable protective materials to prevent the rain water entry.</p>		
COPYRIGHT AND CONFIDENTIAL				
The information on this document is the property of BHARAT HEAVY ELECTRICALS LIMITED. It must not be used directly or indirectly in any way detrimental to the interest of the company.				
SIGN & DATE				
INVENTORY No.				
P-5788				
REV. NO. 04				
		WORKED BY:— <i>Rizwan</i>		CHECKED BY:— <i>Shankar</i>

SIGN & DATE		PRODUCT STANDARD		ST 29005																																													
		STEAM TURBINE ENGINEERING		PAGE 7 OF 23																																													
SUPERSEDES INVENTORY No.	<p>d) The indicated insulation thickness are minimum requirements which should be maintained, and are based on LRB mattresses. If the bidder desires to use pipe section or combination of pipe section &amp; LRB mattresses, the same should be done after prior approval of design engineer.</p> <p>e) Where junctions between bodies of different diameter occur and difference of insulation thickness is specified, the greater thickness is to be continued for a length equal to one diameter of the smaller body and then smoothly tapered to the required smaller thickness over a length equal to two diameters of the smaller body.</p> <p>f) Once the insulation is laid walking on the insulated pipe should be avoided. Suitable scaffoldings are to be used. Similarly slinging of pipes over the insulation should be avoided.</p> <p>g) The layers** of wool mattresses to be adopted, to obtain the specified insulation thickness, are as per table below unless otherwise specified</p>																																																
COPYRIGHT AND CONFIDENTIAL The information on this document is the property of BHARAT HEAVY ELECTRICALS LIMITED. It must not be used directly or indirectly in any way detrimental to the interest of the company.	<table border="1"> <thead> <tr> <th>Thickness of insulation(mm)</th> <th>Ist layer</th> <th>IIInd layer</th> <th>IIIrd layer</th> <th>IVth layer</th> </tr> </thead> <tbody> <tr> <td>80</td> <td>40</td> <td>40</td> <td>--</td> <td>--</td> </tr> <tr> <td>100</td> <td>50</td> <td>50</td> <td>--</td> <td>--</td> </tr> <tr> <td>110</td> <td>65</td> <td>50</td> <td>--</td> <td>--</td> </tr> <tr> <td>120</td> <td>75</td> <td>50</td> <td>--</td> <td>--</td> </tr> <tr> <td>130</td> <td>65</td> <td>40</td> <td>25</td> <td>--</td> </tr> <tr> <td>140</td> <td>75</td> <td>65</td> <td>--</td> <td>--</td> </tr> <tr> <td>150</td> <td>75</td> <td>75</td> <td>--</td> <td>--</td> </tr> <tr> <td>200</td> <td>75</td> <td>75</td> <td>50</td> <td>--</td> </tr> </tbody> </table>				Thickness of insulation(mm)	Ist layer	IIInd layer	IIIrd layer	IVth layer	80	40	40	--	--	100	50	50	--	--	110	65	50	--	--	120	75	50	--	--	130	65	40	25	--	140	75	65	--	--	150	75	75	--	--	200	75	75	50	--
	Thickness of insulation(mm)	Ist layer	IIInd layer	IIIrd layer	IVth layer																																												
80	40	40	--	--																																													
100	50	50	--	--																																													
110	65	50	--	--																																													
120	75	50	--	--																																													
130	65	40	25	--																																													
140	75	65	--	--																																													
150	75	75	--	--																																													
200	75	75	50	--																																													
SIGN & DATE	<p>**If the mattress thickness combination are indicated in the insulation schedule, the above instruction is to be ignored. The necessary guide lines of fixing arrangement for pipe section &amp; mattresses are given in the drawings at sheet nos 10 &amp; 11.</p>																																																
INVENTORY No.	<p>h) Insulation Fixing Arrangements:- Typical fixing arrangements for insulation of pipes &amp; pipe fittings are shown vide drawings listed below;</p>																																																
REV. No.	<p>i) Fixing arrangement pipe section and lightly bonded mattresses/ mattresses at sheet nos. 10, 12 &amp; 13.</p>																																																
P.5788	WORKED BY: - <i>Rigan</i>		CHECKED BY: - <i>gandh</i>																																														



## PRODUCT STANDARD

ST 29005

## STEAM TURBINE ENGINEERING

PAGE 8 OF 23

SIGN &amp; DATE

SUPERSEDES  
INVENTORY No.

COPYRIGHT AND CONFIDENTIAL

The information on this document is the property of BHARAT HEAVY ELECTRICALS LIMITED. It must not be used directly or indirectly in any way detrimental to the interest of the company.

SIGN &amp; DATE

INVENTORY No.

REV.  
NO.  
04

- ii) Fixing arrangements for lightly banded mattress at sheet nos 11, 12 & 13.
- iii) Lugs at sheet no 14.
- iv) Flats at sheet no. 15.
- v) Fixing of insulation on valves at sheet no. 16.
- vi) Insulation of tee at sheet no. 17.
- vii) Insulation of elbow at sheet no. 18.
- viii) Pipe clamp carbon steel at sheet no. 19.
- ix) Pipe clamp alloy steel at sheet no. 20.

## 8.0 PROTECTION OF MATERIALS DURING STORAGE

The supplier shall protect the insulation materials from weather at all times from delivery to finish. Decking & covering tarpaulins alone are not adequate for any length of time & shall not be allowed except in extreme emergencies and only for short periods. Stacking of insulating materials directly on ground shall not be done.

## 9.0 GUARANTEES

The supplier shall guarantee that if the specified maximum surface temperatures are exceeded on actual measurement, the supplier shall either replace the insulation with a superior material or provide additional insulation thickness at the BHEL'S/ site engineers discretion at no extra cost to the BHEL.

The supplier shall also guarantee the quality of the materials used & workmanship for a period of 18 months from the date of commissioning. Any defects arising from faulty materials or workmanship during this period shall be rectified by the supplier at no extra cost to BHEL.

## 10.0 INSPECTION &amp; TESTING

## 10.1 Thermal insulating material :-

Supplier shall arrange for carrying out all the tests for establishing thermal conductivity values, physical & chemical properties as required by relevant IS & or BS codes and standards. The tests shall be done on representative samples drawn from each lot of insulation material to be supplied under this specification & prior intimation shall be given so that BHEL can depute their representative to witness any or all the tests. For thermal conductivity values, test certificates from independent authorized testing agency (subject to BHEL'S approval) shall be furnished to BHEL for approval.

## 10.2 Other materials :-

For other materials i.e. cladding sheet, wire netting, binding wires, stitching & lacing wires etc., manufacturers correlated test certificates as per relevant codes & standards shall be furnished. In case correlating test certificates are not available, the supplier shall arrange to carry out necessary tests in presence of BHEL'S representative.

WORKED BY: - *Rigam*CHECKED BY: - *Rigam*



PRODUCT STANDARD

ST 29005

STEAM TURBINE ENGINEERING

PAGE 10 OF 23



SUPERSEDES INVENTORY No. SIGN & DATE

INVENTORY No. SIGN & DATE

COPYRIGHT AND CONFIDENTIAL  
The information on this document is the property of BHARAT HEAVY ELECTRICALS LIMITED, it must not be used directly or indirectly in any way detrimental to the interest of the company.

INVENTORY No. SIGN & DATE

P-5788 22/6/89

REV. NO 04

WORKED BY:- *Rigam*

CHECKED BY:- *Shukla*

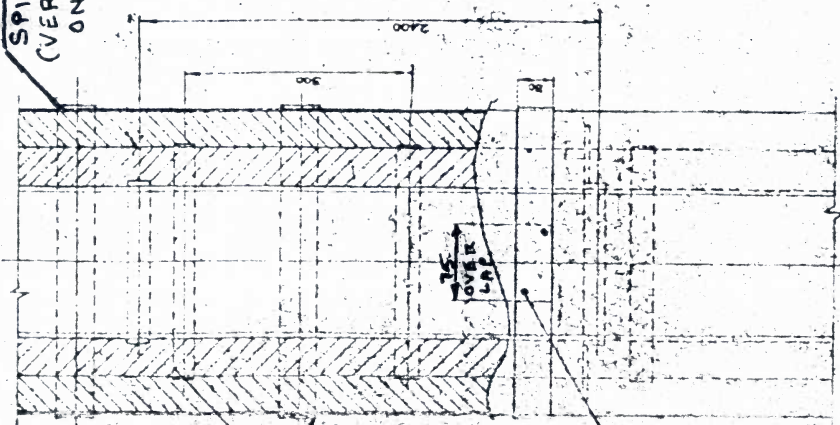
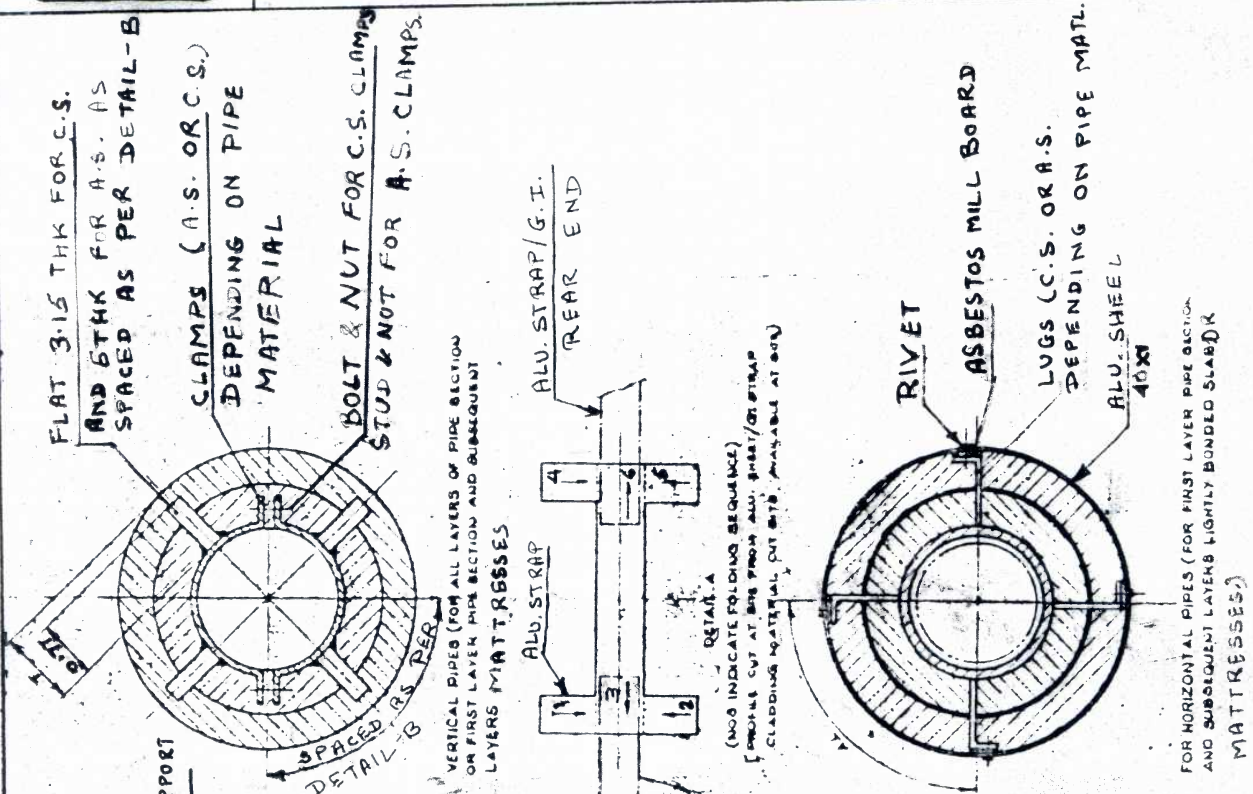

GI BAND 30X0.71  
 SECURED TIGHTLY ON  
 FINAL LAYER AS PER  
 DETAIL-A AND FASTENED  
 WITH TWO NOS OF SELF  
 TAPPING SCREWS  
 SELF TAPPING SCREWS  
 2 Nos.

PRODUCT STANDARD

ST 29005

STEAM TURBINE ENGINEERING

PAGE 11 OF 23



SIGN & DATE

SUPERSEDES INVENTORY No.

COPYRIGHT AND CONFIDENTIAL  
The information on this document is the property of BHARAT HEAVY ELECTRICALS LIMITED. It must not be used directly or indirectly in any way detrimental to the interest of the company.

SIGN & DATE

24/1/89

INVENTORY No.

P-5788

REV. NO.  
04

WORKED BY:- Rigan

CHECKED BY:- Sanku

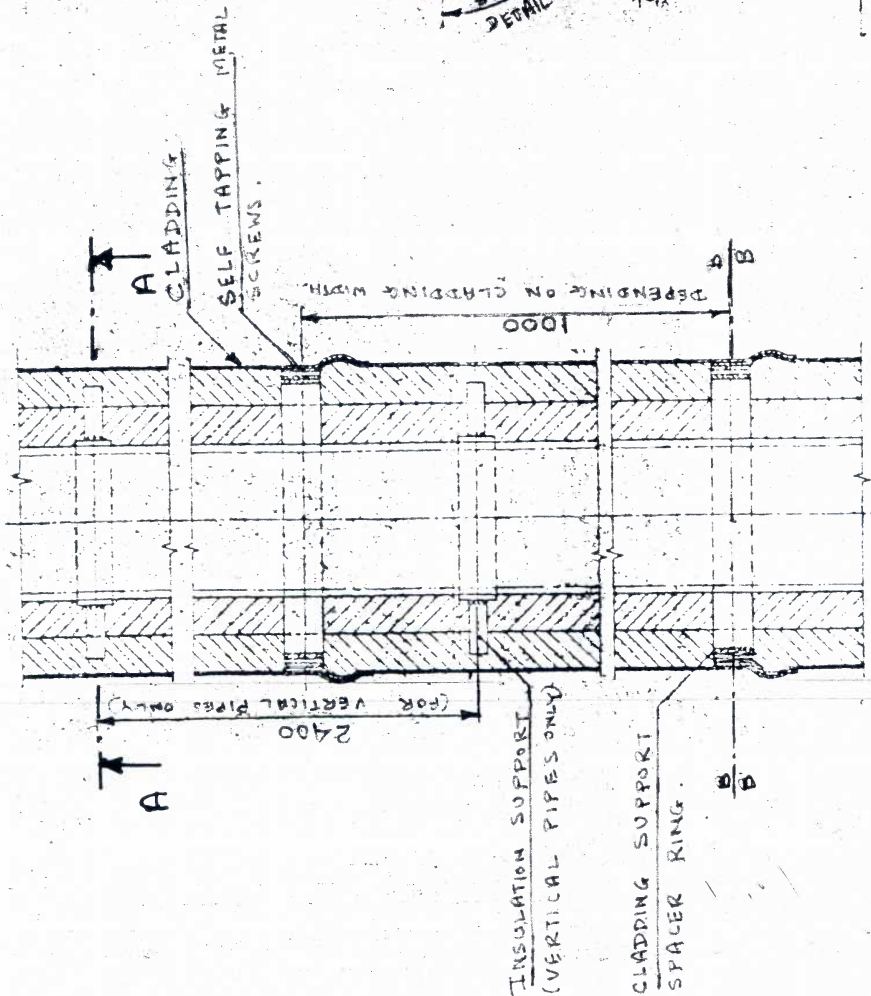
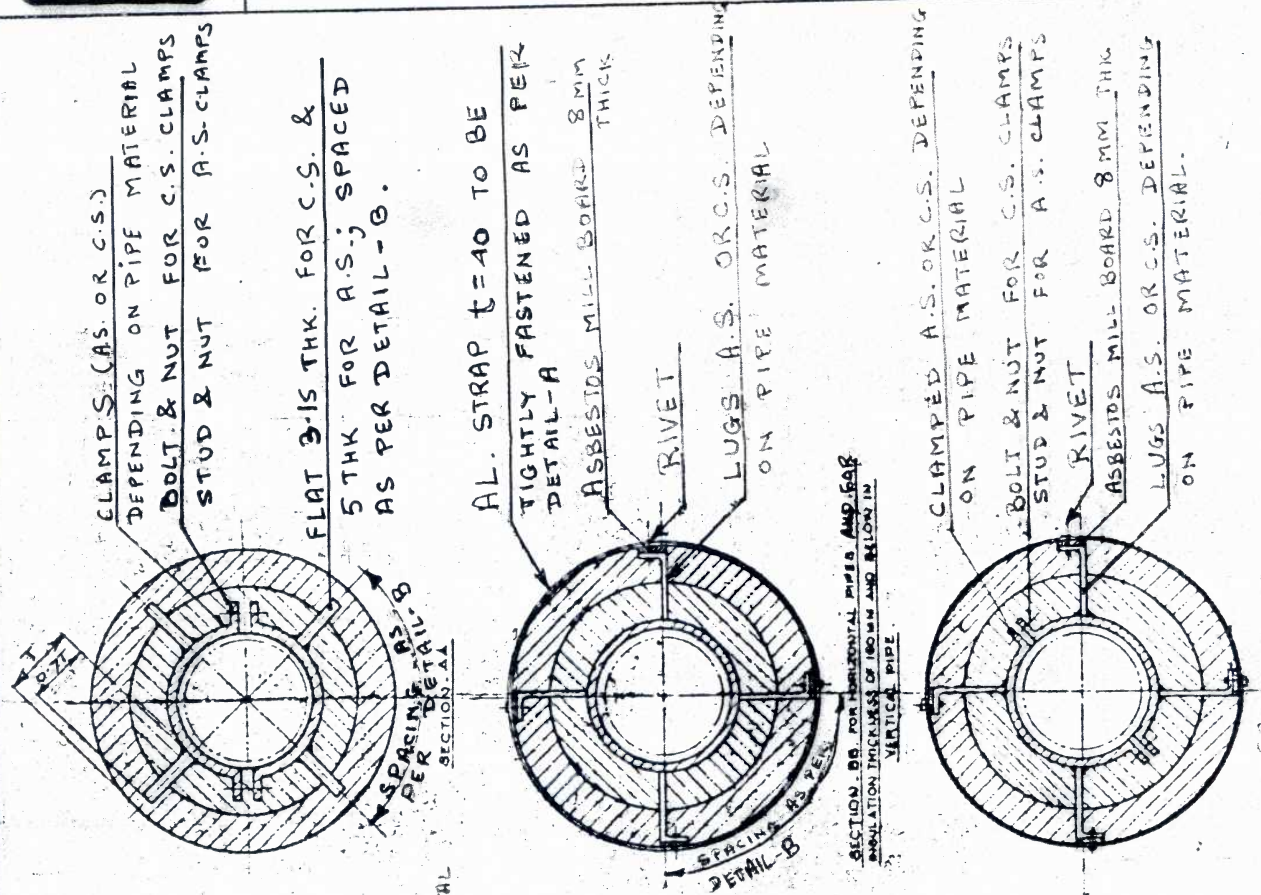



**PRODUCT STANDARD**  
**STEAM TURBINE ENGINEERING**

ST 29005

PAGE 12 OF 23

**NOTES ON ERECTION :-****A. (ONLY PIPE SECTION)**

1. Fix support spider on vertical pipes. Bottom most spider at tangent point of bend/tee.
2. Commence insulation of all layers except last layers of insulation, from support spider level in vertical pipes.
3. Fit each layer of insulation and secure with 30 x 0.71 GI bands at spacing as shown. Secure it tightly by cutting the alu. sheet as per detail-A.
4. Secure last layer of insulation and fasten it at a GI band 30 x 0.71 (as detail-A).
5. Fix cladding sheet and apply sealant.
6. For horizontal pipes use GI bands 30 x 0.71 and secure it as per detail-A.

**B. FIRST LAYER PIPE SECTION AND SUBSEQUENT LAYERS LRB****MATTRESSES OR MATTRESSES.**

1. For horizontal pipes secure tightly the first layer of pipe section using 30 x 0.71 GI bands and as per detail-A.
2. Insert lugs for horizontal pipes and secure it tightly using alu. sheet 40 x 1 as per detail-A.
3. Fit in asbestos mill board and rivet.
4. Insert the LRB mattresses or mattresses with field cut slots from edge in felt and wire netting to clear lugs.
5. Fix cladding sheet and apply sealant.
6. For fixing of insulation in vertical pipes follow the same as the one for pipe section.

**C. GENERAL**

- a) After proper folding (as per detail-A) the ends are to be properly fastened by using two nos. self tapping screws per band.
- b) Lugs/flats are issued in standard length running meters. They are to be cut at site depending on insulation thickness.

**D. NOTES ON APPLICATION**

1. Fix insulation support spiders on vertical pipes. Bottom most spider at tangent point of bend/tee at bottom.
2. Fix cladding support spacer ring at specified intervals by using aluminium strap tightly (as per detail-A).
3. Commence insulation on all layers of insulation except last layer from support spider level in vertical pipes.
4. Insert insulation at support spacer rings locations with field cut slots from edge in felt and wire netting to clean lugs/projection.
5. Stitch wire netting together at all edges and field cuts.

REV.  
NO.

04

WORKED BY: - *Rigam*CHECKED BY: - *Shinde*

SIGN &amp; DATE

SUPERSEDES  
INVENTORY No.

COPYRIGHT AND CONFIDENTIAL







The information on this document is the property of BHARAT HEAVY ELECTRICALS LIMITED. It must not be used directly or indirectly in any way detrimental to the interest of the company.

SIGN &amp; DATE

INVENTORY No.

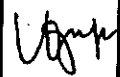
20/6/89

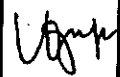
P-5788

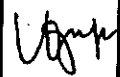
Review of drawing SIGN & DATE		<b>उत्पाद मानक</b> <b>STEAM TURBINE ENGINEERING</b> <b>PRODUCT STANDARD</b>	<b>ST29005</b>								
SUPERSEDES INVENTORY NO.			पृष्ठ 23 का 13								
<b>COPYRIGHT AND CONFIDENTIAL.</b> The information on this document is the property of Bharat Heavy Electrical Limited. It must not be used directly or indirectly in any way detrimental to the interest of the company.		<ol style="list-style-type: none"> <li>6. Adjacent layers of insulation to be disposed to result in 50 mm overlap.</li> <li>7. Fit last layer of insulation.</li> <li>8. All gaps in insulation to be filled with cuttings &amp; finished.</li> <li>9. Provide and fix cladding with sealing compound.</li> <li>10. Lugs and flats are issued for standard height. It has to be cut at site depending on insulation thickness ( refer insulation schedule for the thickness of insulation ).</li> <li>11. This is applicable for LRB mattresses or mattresses ( both for horizontal and vertical piping ).</li> </ol> <p style="text-align: center;"><b>DETAIL-B</b></p> <table border="1" style="width: 100%; border-collapse: collapse;"> <thead> <tr> <th style="text-align: left;">OUTER DIA. OF PIPE</th> <th style="text-align: left;">NO.OFF</th> </tr> </thead> <tbody> <tr> <td>Upto 219</td> <td style="text-align: center;">4</td> </tr> <tr> <td>273 to 406</td> <td style="text-align: center;">6</td> </tr> <tr> <td>Above 406</td> <td style="text-align: center;">8</td> </tr> </tbody> </table> <p>E. Inspection at site during and after application of insulation shall be carried out as stipulated in the enclosed field quality plan.</p> <p>F. <b>CROSS REFERRED STANDARDS :-</b></p> <p>IS:737</p> <p>IS:8183</p> <p>IS:9842</p> <p>IS:14164</p>	OUTER DIA. OF PIPE	NO.OFF	Upto 219	4	273 to 406	6	Above 406	8	Page 13 of 23
OUTER DIA. OF PIPE	NO.OFF										
Upto 219	4										
273 to 406	6										
Above 406	8										
<b>स्वतंत्रतापूर्वक एवं गोपनीय</b> इस दस्तावेज में दी गई जानकारी का उपयोग केवल केवल केवल के लिए ही किया जाना चाहिए। अन्यथा इससे किसी भी प्रकार का नुकसान हो सकता है।											
Review of drawing SIGN & DATE 14.8.04											
INVENTORY NO. <b>P-5788</b>	REV. NO. <b>04</b>		<table border="1" style="width: 100%; border-collapse: collapse;"> <tr> <td style="width: 20%;">निर्माणाकर्ता WORKED BY</td> <td style="width: 20%;">S.K.G.</td> <td style="width: 20%; text-align: center;"></td> <td style="width: 40%; text-align: center;">7/7/04</td> </tr> <tr> <td>जाँचकर्ता CHECKED BY</td> <td>V.K.G.</td> <td style="text-align: center;"></td> <td style="text-align: center;">7.7.04</td> </tr> </table>	निर्माणाकर्ता WORKED BY	S.K.G.		7/7/04	जाँचकर्ता CHECKED BY	V.K.G.		7.7.04
निर्माणाकर्ता WORKED BY	S.K.G.		7/7/04								
जाँचकर्ता CHECKED BY	V.K.G.		7.7.04								



**PRODUCT STANDARD**  
**STEAM TURBINE ENGINEERING**

ST 29005

PAGE 14 OF 23

SIGN & DATE

SUPERSEDES  
INVENTORY No.

**COPYRIGHT AND CONFIDENTIAL**  
The information on this document is the property of BHARAT HEAVY ELECTRICALS LIMITED. It must not be used directly or indirectly in any way detrimental to the interest of the company.

SIGN & DATE

INVENTORY No.

22/6/89

P-5788

REV. NO. 04

WORKED BY: - *Rigam*

CHECKED BY: - *[Signature]*

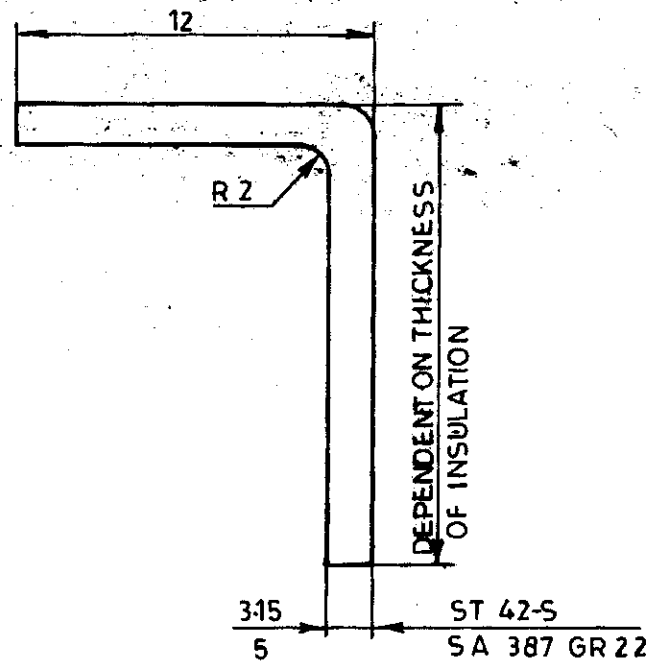

LUGS



PRODUCT STANDARD

ST 29005

STEAM TURBINE ENGINEERING

PAGE 15 OF 23

SIGN & DATE

SUPERSEDES  
INVENTORY No.

COPYRIGHT AND CONFIDENTIAL  
The information on this document is the property of BHARAT HEAVY ELECTRICALS LIMITED. It must not be used directly or indirectly in any way detrimental to the interest of the company.

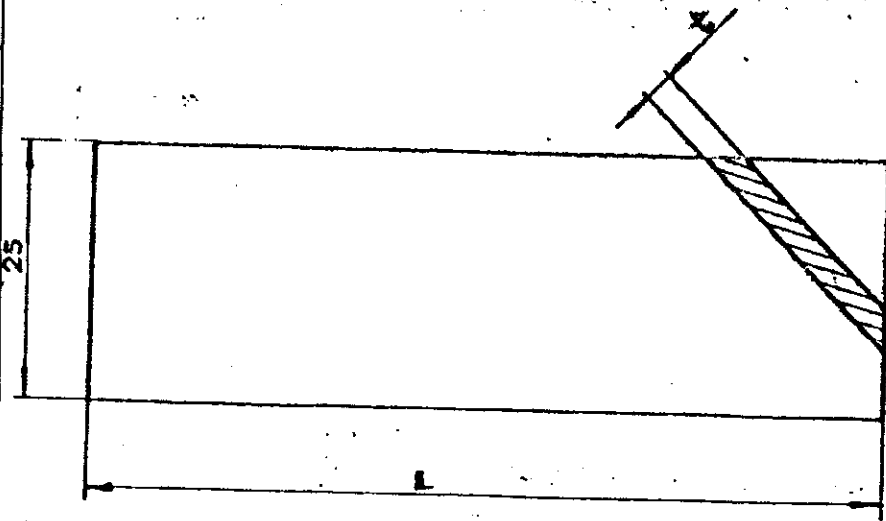

NOTE :-

1.  $\delta$  = 0.7 x INSULATION THICKNESS
2.  $\delta$  = 3.15 THK FOR CARBON STEEL (VAR.01)  
5 THK FOR ALLOY STEEL (VAR.02)

02	PLATE-5mm Thk.	IS 962 255			
		SA 307 GR22			1
01	PLATE-3.15mm-Thk	IS 962 255			
		ST A2-S			1
VARIANT	DESCRIPTION	MATL CODE	A	UNIT	UNIT WT
		MATL SPEC	C		QTY.

FLAT

SIGN & DATE

22/6/88

INVENTORY No.

P-5788

REV. NO.

04

WORKED BY:- *Rigam*

CHECKED BY:- *Shinde*

INVENTORY No. P-5788	SIGN & DATE 28/6/89	COPYRIGHT AND CONFIDENTIAL The information on this document is the property of BHARAT HEAVY ELECTRICALS LIMITED. It must not be used directly or indirectly in any way detrimental to the interest of the company.	SIGN & DATE	SUPERSEDES INVENTORY No.	SIGN & DATE	FORM ST 29005 PAGE 16 OF 23	PRODUCT STANDARD STEAM TURBINE ENGINEERING
-------------------------	------------------------	---	-------------	--------------------------	-------------	-----------------------------------	---

**DETAILS OF INSULATION OF VALVES**

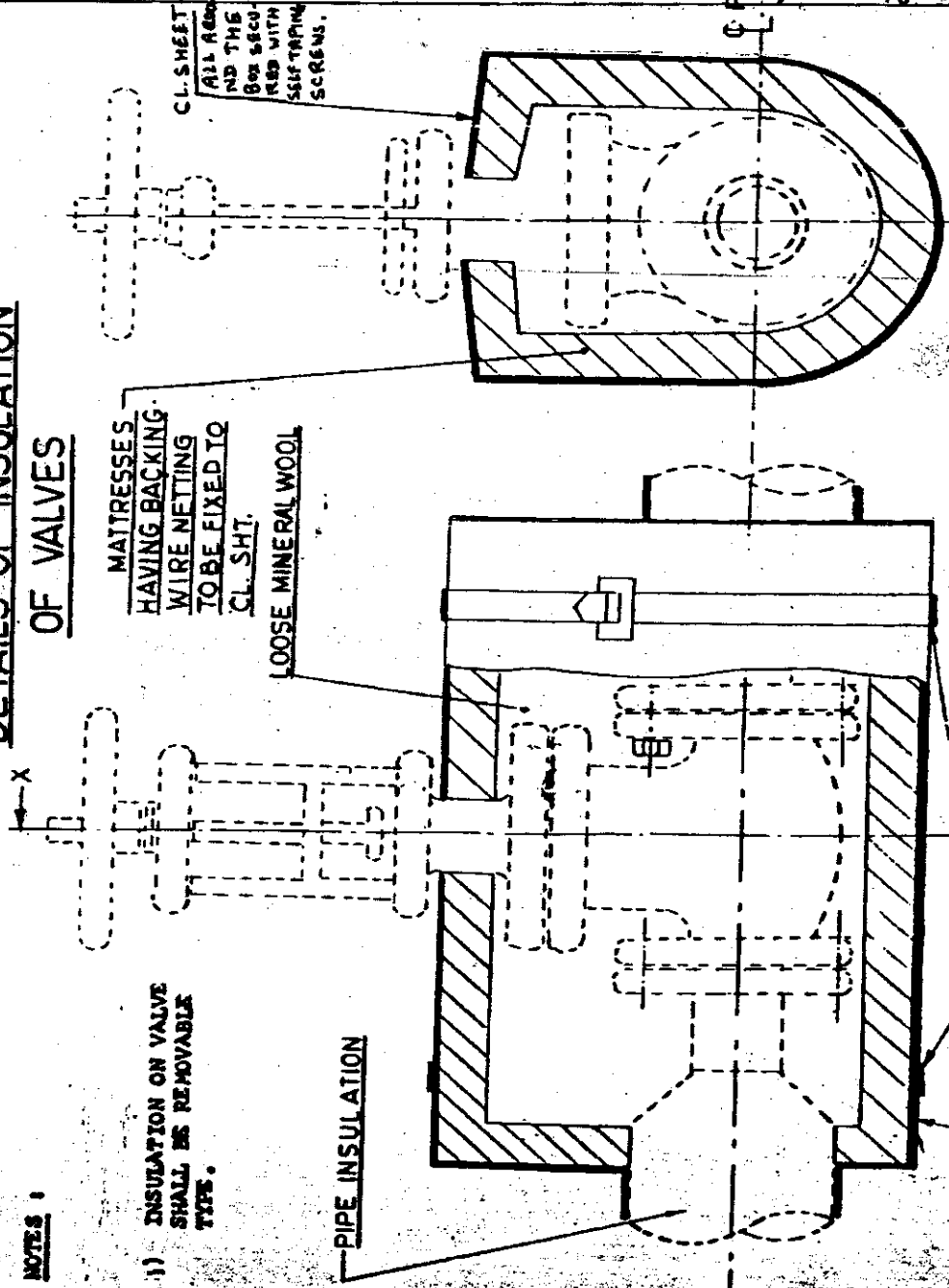

NOTES :

- 1) INSULATION ON VALVE SHALL BE REMOVABLE TYPE.

CL. SHEET  
ALL ABOVE AND THE BOX SECT. ARE TO BE FIXED WITH SELF TAPPING SCREWS.

SEC. X-X

CL. SHEET STRAPS MADE FROM CL. SHEET

DESIGNED BY: [Signature] CHECKED BY: [Signature]



PRODUCT STANDARD  
STEAM TURBINE ENGINEERING

ST 29005

PAGE 17 OF 23

SIGN & DATE

SUPERSEDES  
INVENTORY No.

COPYRIGHT AND CONFIDENTIAL  
The information on this document is the property of BHARAT HEAVY ELECTRICALS LIMITED. It must not be used directly or indirectly in any way detrimental to the interest of the company.

SIGN & DATE  
vsk/69

INVENTORY No.  
P.5788

FIXING OF INSULATION ON TEES

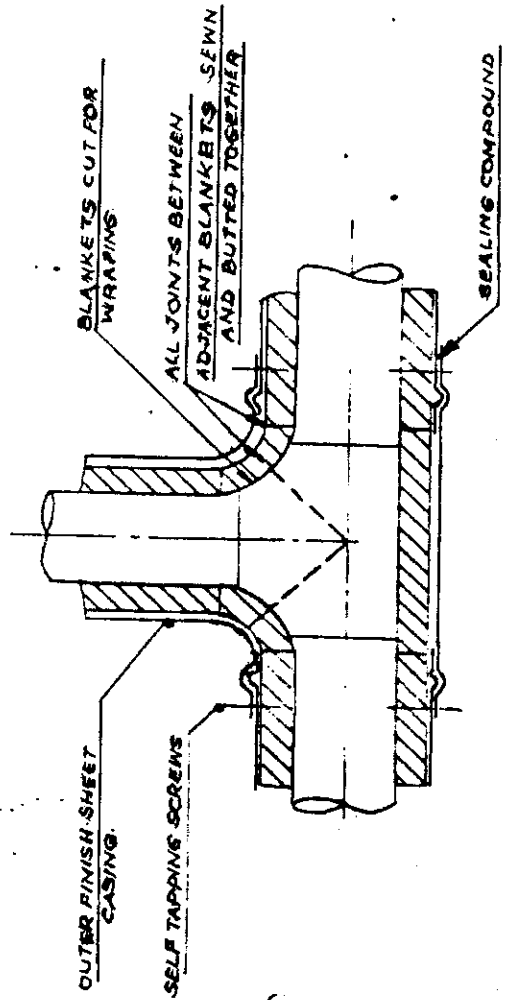

TEE INSULATION  
(WITH MATTRESS INSULATION)

WORKED BY:- *Rigan*

CHECKED BY:- *[Signature]*

REV. NO.  
04



PRODUCT STANDARD  
STEAM TURBINE ENGINEERING

ST 29005

PAGE 18 OF 23

SIGN & DATE

SUPERSEDES  
INVENTORY No.

COPYRIGHT AND CONFIDENTIAL  
The information on this document is the property of BHARAT HEAVY ELECTRICALS LIMITED.  
It must not be used directly or indirectly in any way detrimental to the interest of the company.

SIGN & DATE

20-11-99

INVENTORY No.

P-5788

REV.  
NO.  
04

**FIXING OF INSULATION  
ON BENDS / ELBOWS**

SHEET METAL CLADDING

ALL JOINTS BETWEEN ADJACENT  
BLANKETS SEWN & BUTTED  
TOGETHER.

SEALING COMPOUND TO BE  
APPLIED ON SHEET.

CASING JOINTS  
BLANKETS CUT FOR  
BEING WRAPPED  
AROUND THE ELBOW  
BEND.

ALL METAL SHEETS  
AT JOINTS TO OVERLAP  
BY 40 mm.

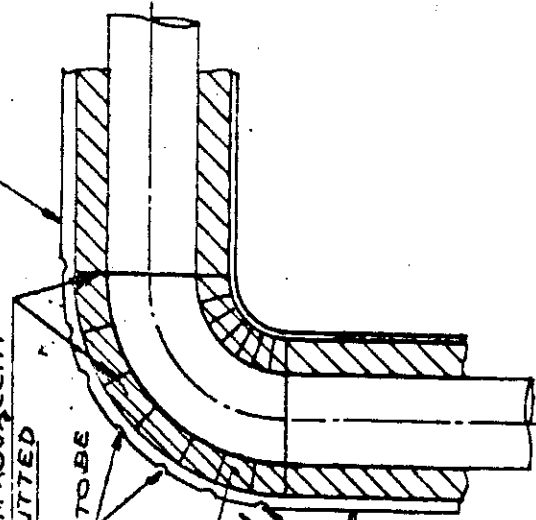

WITH MATTRESS

WORKED BY: - *Rigan*

CHECKED BY: - *[Signature]*



**PRODUCT STANDARD  
STEAM TURBINE ENGINEERING**

**ST 29005**

PAGE 19 OF 23

**PIPE CLAMPS (CARBON STEEL)**

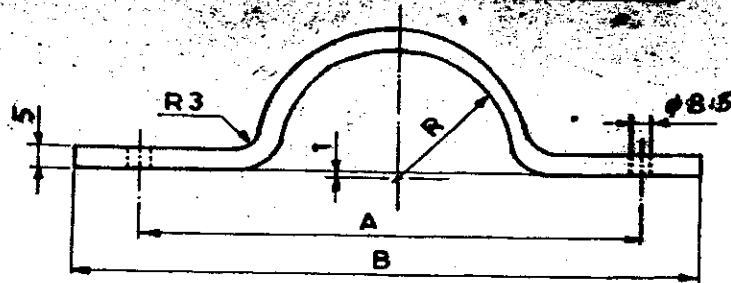

VAR.	A	B	R	NB	DESCRIPTION	UNITL SPCN.	UNIT WT.
01	76	91	30	50	PL. 5X50X120	ST 42-S/15226	0.240
02	88	103	37	65	PL. 5X50X142		0.280
03	104	119	44	80	PL. 5X50X166		0.320
04	129	144	57	100	PL. 5X50X210		0.45
05	183	198	84	150	PL. 5X50X288		0.570
06	234	249	110	200	PL. 5X50X371		0.730
07	288	303	137	250	PL. 5X50X455		0.900
08	339	354	162	300	PL. 5X50X534		1.050
09	377	386	178	350	PL. 5X50X584		1.150
10	421	436	203	400	PL. 5X50X663		1.300
11	473	488	229	450	PL. 5X50X746		1.400
12	523	538	254	500	PL. 5X50X820		1.620
13	123	138	54	100	PL. 5X50X200		0.400
14	174	189	80	150	PL. 5X50X282		0.550
15	579	594	280	550	PL. 5X50X910		1.800
16	756	771	70	125	PL. 5X50X248	ST 42-S/15226	0.480

SUPERSEDES  
INVENTORY NO.

SIGN & DATE

COPYRIGHT AND CONFIDENTIAL

The information on this document is the property of BHARAT HEAVY ELECTRICALS LIMITED. It must not be used directly or indirectly in any way detrimental to the interest of the company.

INVENTORY NO. SIGN & DATE

P. 5788 22/6/89

REV. 36

04 WORKED BY: - *Riga*

CHECKED BY: - *Sharma*



**PRODUCT STANDARD**  
**STEAM TURBINE ENGINEERING**

ST 29005

PAGE 20 OF 23

SIGN & DATE

SUPERSIDES  
INVENTORY No.

COPYRIGHT AND CONFIDENTIAL

The information on this document is the property of BHARAT HEAVY ELECTRICALS LIMITED. It must not be used directly or indirectly in any way detrimental to the interest of the company.

SIGN & DATE

INVENTORY NO.

22/6/88

REV. NO. 04

**PIPE CLAMPS (ALLOY STEEL)**

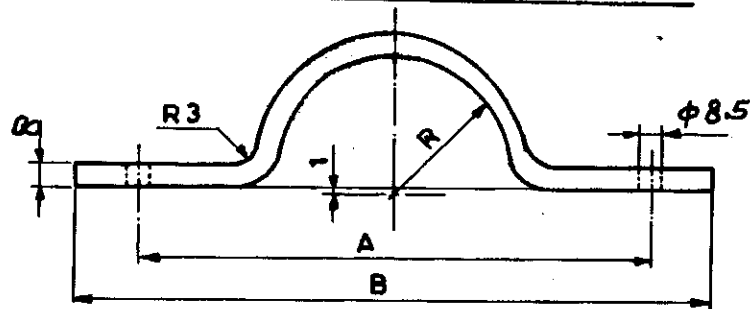

VAR	A	B	R	NB	DESCRIPTION	MATL.SPCN.	UNIT WT.
01	76	91	30	50	PL. 8X50X125	13Cv M044	0.400
02	88	103	37	65	PL. 8X50X 150		0.480
03	183	198	84	150	PL. 8X50X 295		0.920
04	234	249	110	200	PL. 8X50X 380		1.200
05	288	303	137	250	PL. 8X50X 460		1.450
06	371	306	178	350	PL. 8X50X 590		1.850
07	421	436	203	400	PL. 8X50X 670		2.100
08	473	488	229	450	PL. 8X50X 752		2.400
09	523	538	254	500	PL. 8X50X 824		2.600
10	626	644	305	600	PL. 8X50X 990		3.000
11	123	138	54	100	PL. 8X50X 200		0.630
12	129	144	57	100	PL. 8X50X 210		0.660
13	174	189	80	150	PL. 8X50X 282		0.800
14	339	354	162	300	PL. 8X50X 540		1.700
15	365	380	175	350	PL. 8X50X 580		1.820
16	569	584	280	550	PL. 8X50X 910		2.860
17	104	119	44	80	PL. 8X50X 166		0.520
18	156	171	70	125	PL. 8X50X 248		0.78
19	730	745	356	700	PL. 8X50X 1150	13Cv M044	3.310

WORKED BY:- *Rizwan*

CHECKED BY:- *[Signature]*



**PRODUCT STANDARD**  
**STEAM TURBINE ENGINEERING**

ST 29005

PAGE 21 OF 23

SIGN &amp; DATE

SUPERSEDES  
INVENTORY No.

**COPYRIGHT AND CONFIDENTIAL**

The information on this document is the property of BHARAT HEAVY ELECTRICALS LIMITED. It must not be used directly or indirectly in any way detrimental to the interest of the company.

FIELD QUALITY PLAN :

SL NO	COMPONENT/ OPERATION	CHARACTERISTIC CHECKED	CAT	TYPE/ METHOD OF CHECK	EXTENT OF CHECK	REFERENCE DOCUMENT	ACCEPTANCE NORM	FORMAT OF RECORD	REMARKS
01	STORAGE AND HANDLING	Damage in transit and handling	MA	Visual	100%	Specif. & IS 10556	Specif. & IS 10556	Log Sheet	No breakage and damage of insulating materials. No distortion or tearing off the packing.
		Storage location	MA	-do-	-do-	-do-	-do-	-do-	Stacked under covered shed.
		Storage space and surroundings.	MA	-do-	-do-	-do-	-do-	-do-	Free from damp, oil, fume and sulphur bearing gases.
		Stacking height	MA	-do-	-do-	-do-	-do-	-do-	2 M. for pipe sections and 3 M. for mattresses.
		Platform	MA	-do-	-do-	-do-	-do-	-do-	Concrete or wooden.

Contd. on page 22

SIGN &amp; DATE

22/6/89

INVENTORY No.

P-5788

WORKED BY :- *Rizwan*CHECKED BY :- *Rizwan*

REV. No. 0A



**PRODUCT STANDARD**  
**STEAM TURBINE ENGINEERING**

ST 29005

PAGE 22 OF 23

SIGN &amp; DATE

SUPERSEDES  
INVENTORY No.FIELD QUALITY PLAN :-

**COPYRIGHT AND CONFIDENTIAL**  
The information on this document is the property of BHARAT HEAVY ELECTRICALS LIMITED.  
It must not be used directly or indirectly in any way detrimental to the interest of the company.

SIGN &amp; DATE

INVENTORY No.

2-16-89  
P-5788

SL NO	COMPONENT/ OPERATION	CHARACTERISTIC CHECKED	CAT	TYPE/ METHOD OF CHECK	EXTENT OF CHECK	REFERENCE DOCUMENT	ACCEPTANCE NORM	FORMAT OF RECORD	REMARKS
02	APPLICATION	Surface cleanliness	MA	Visual	Random	Specification	Specification	Log Sheet	Surface shall be free from dirt, rust, scale, oil etc. and dried.
		Insulation material appearance.	MA	-do-	-do-	-do-	-do-	-do-	Material shall be uniform and free from cracks, voids etc.
		Binding wires/ Bands spacing	MA	-do-	-do-	Appd. drg & specif.	Appd. drg & specif.	-do-	
		Wire netting dimensions and location.	MA	-do-	-do-	-do-	-do-	-do-	
		Wire ends	MA	-do-	-do-	-do-	-do-	-do-	Wire ends shall be twisted and bent inside.
		Supports arrangements & spacing	MA	-do-	-do-	-do-	-do-	-do-	
		Expansion joints spacing.	MA	-do-	-do-	-do-	-do-	-do-	
		Insulation thickness test	MA	Physical	10%	IS 7413 & Specf.	IS 7413 & Specf.	-do-	
		Uniformity of thickness	MA	-do-	-do-	-do-	-do-	-do-	
		Bulk density test	MA	-do-	-do-	-do-	-do-	-do-	

Contd. on page 23

WORKED BY: - *Raj*REV. NO.  
04CHECKED BY: *Raj*



**PRODUCT STANDARD**  
**STEAM TURBINE ENGINEERING**

ST 29005

PAGE 23 OF 23

SIGN & DATE

SUPERSEDES  
INVENTORY No.

**COPYRIGHT AND CONFIDENTIAL**  
The information on this document is the property of BHARAT HEAVY ELECTRICALS LIMITED. It must not be used directly or indirectly in any way detrimental to the interest of the company.

FIELD QUALITY PLAN

SL NO	COMPONENT/ OPERATION	CHARACTERISTIC CHECKED	CAT	TYPE/ METHOD OF CHECK	EXTENT OF CHECK	REFERENCE DOCUMENT	ACCEPTANCE NORM	FORMAT OF RECORD	REMARKS
03	FINISHING	Cladding material thickness	MA	Visual	Random	Appd. Drg & Specif.	Appd. Drg & Specif.	Log Sheet	Surfaces shall be uniform & free from cracks, dents etc.
		ST Screws	MA	-do-	-do-	-do-	-do-	-do-	
		Grooving/ overlapping	MA	-do-	-do-	-do-	-do-	-do-	
		Joints Sealing	MA	-do-	-do-	-do-	-do-	-do-	
		Appearance	MA	-do-	-do-	-do-	-do-	-do-	
04	PERFORMANCE TESTING This shall be conducted after commissioning the plant.	Ambient temperat.	MA	Physical	10%	Specif.	Specif.	Log sheet	Shall be measured at a distance of 1 M from the insulation surface
		Ambient air velocity	MA	-do-	-do-	-do-	-do-	-do-	-do-
		Cold face temperature	MA	-do-	-do-	-do-	-do-	-do-	Shall be measured at insulation cladding surface. This shall not be more than the specified value at the specified design conditions.

SIGN & DATE

INVENTORY No.

24/6/89

P-5788

REV. NO.  
04

WORKED BY: - *Rigan*

CHECKED BY: - *[Signature]*

DRG.NO.412114U3000  
REV.NO. 00  
DATE: 05/06/13

### THERMAL INSULATION SCHEDULE FOR TG INTEGRAL PIPING

PROJECT: 700 MW

PROJECT STAGE: CONTRACT

SPEC.NO. ST29005

#### DESIGN PARAMETERS:

COLD FACE TEMPERATURE: 60 DEG C

AMBIENT TEMPERATURE: 30 DEG C

EMISSIVITY OF AL. SHEET: 0.2

WIND VELOCITY: 0M/S



#### MATERIALS:

INSULATION MATERIAL: LIGHTLY RESIN BONDED ROCKWOOL  
AS PER IS: 8183

DENSITY: 1. 100 KG/M3 FOR HOT FACE TEMP. UPTO 400°C  
2. 150 KG/M3 FOR HOT FACE TEMP. ABOVE 400°C

CLADDING MATERIAL: ALUMINIUM SHEET

DESIGN HEAT LOSS AT  
CLADDING SURFACE: 180 KCAL/SQM hr

Prepared by	Approved by
	
Navneet Chakrapani Engr- PED	S K Gupta SDGM/PED

PIPING CODE	APPROX LENGTH (M)	TEMPERATURE (DEG C)	PIPE OD (MM)	ELBOW	TEE	REDUCER	FLANGES	VALVES	BENDS
/LBC41BR001	8.5	383	168.3	3				1	
/LBC41BR002	1.0	383	273.1						2
/MAM10BR001	5.0	525	48.3						5
/MAM10BR002	17.0	525	48.3						10
/MAM10BR003	32.5	525	48.3						10
/MAM10BR004	5.5	525	48.3						5
/MAM10BR005	18.0	525	26.7						10
/MAM10BR008	14.5	525	60.3		2				5
/MAM10BR010	12.5	525	60.3		2				4
/MAM20BR001	4.0	304	33.4						6
/MAM20BR002	4.0	304	33.4						4
/MAM20BR003	10.5	411	48.3						5
/MAM20BR005	8.5	304	88.9	3					1
/MAM20BR006	5.5	525	48.3						6
/MAM20BR007	5.0	525	48.3						5
/MAM20BR008	12.0	525	114.3	2	4				
/MAM20BR009	5.0	505	48.3						6
/MAM20BR010	5.5	505	48.3						5
/MAM30BR001	6.0	587	42.2						7
/MAM30BR002	30.0	587	42.2						15
/MAM30BR003	44.5	587	42.2						14
/MAM30BR004	6.5	587	42.2						5
/MAM30BR008	18.5	587	42.2						9
/MAM30BR010	10.0	587	60.3		2				5
/MAW10BR001	2.0	310	219.1	1	1			1	
/MAW10BR101	1.0	310	114.3		1			1	
/MAW10BR103	1.5	310	114.3	1		1		1	
/MAW10BR104	2.0	310	219.1						

# HOT FACE TEMPERATURES CORRESPOND TO LONG TERM TEMPERATURES OF RESPECTIVE PIPING BOMS.

\*THIS BOM MAY VARY BY +/- 5%.

\*TEEs and Reducers are not included in pipe length and are to be considered separately for Thermal Insulation as per the above table. This supercedes Clause 2.5 of ST29005 in this regard.

PIPING CODE	APPROX LENGTH (M)	TEMPERATURE (DEG C)	PIPE OD (MM)	ELBOW	TEE	REDUCER	FLANGES	VALVES	BENDS
/MAW20BR001	4.5	470	273.1	2	2	1	1		
/MAW20BR002	3.5	470	323.8		2	1			
/MAW20BR003	10.5	340	273.1	2	2		1		
/MAW20BR004	0.5	340	88.9				1		
/MAW20BR005	5.5	340	33.4	2		2		2	1
/MAW21BR001	5.5	470	114.3				2		4
/MAW21BR002	7.0	470	114.3				2		4
/MAW21BR003	3.5	470	168.3		1	1			6
/MAW22BR001	6.5	470	168.3	2	1	1			4
/MAW22BR002	4.0	470	114.3				2		4
/MAW22BR003	3.5	470	114.3				2		3
/MAW23BR001	5.0	470	114.3	3			2		1
/MAW23BR002	5.0	470	114.3				2		1
/MAW23BR003	7.5	470	168.3	2	1	1			2
/MAW24BR001	3.5	470	141.3			1			1
/MAW24BR002	3.5	470	141.3			1			1
/MAW24BR003	6.0	470	168.3		1	1			1
/MAW24BR004	1.5	470	114.3				2		2
/MAW24BR005	1.5	470	114.3				2		2
/MAW25BR001	7.5	340	114.3				2		2
/MAW26BR001	7.5	340	114.3				2		2
/MAW50BR001	12.5	540	508	1	1	1		1	
/MAW50BR002	10.0	540	508	10	1	1		1	
/MAW50BR003	0.5	540	168.3				1		
/MAW50BR103	2.0	540	508					1	
/MAW50BR104	1.5	540	508	1					
/MAW60BR001	4.0	473	114.3	2					
/MAW60BR002	4.0	473	114.3	2					

# HOT FACE TEMPERATURES CORRESPOND TO LONG TERM TEMPERATURES OF RESPECTIVE PIPING BOMS.

\*THIS BOM MAY VARY BY +/- 5%.

\*TEEs and Reducers are not included in pipe length and are to be considered separately for Thermal Insulation as per the above table. This supercedes Clause 2.5 of ST29005 in this regard.

DATE: 27.08.2013

BOM FOR THERMAL INSULATION OF TIP : 700 MW  
 Seal Steam Piping System

DOCUMENT NUMBER: 412114U3001  
 REVISION NUMBER: 00

PIPING CODE	APPROX LENGTH (M)	TEMPERATURE (DEG C)	PIPE OD (MM)	ELBOW	TEE	REDUCER	FLANGES	VALVES	BENDS
/MAW60BR003	4.5	473	168.3	2	2				
/MAW60BR004	5.5	473	114.3	5					
/MAW60BR005	5.5	473	114.3	5					
/MAW60BR006	3.0	473	168.3	2	2				
/MAW60BR007	16.5	473	219.1	9	2				
/MAW60BR008	0.5	473	114.3						
/MAW80BR001	41.0	310	323.8	10	5	1			
/MAW80BR002	6.5	310	273.1		1	1			
/MAW80BR003	2.5	310	219.1		2				
/MAW80BR004	4.5	310	273.1	6					
/MAW80BR005	3.0	310	33.4	5	1	2			
/MAW80BR006	3.5	310	33.4	5	1	2			
/MAW80BR007	7.5	100	168.3	3					
/MAW80BR008	1.0	100	168.3	3	1		2	1	
/MAW80BR009	1.0	100	168.3	1			2	1	
/MAW80BR010	0.5	100	219.1			1	1		
/MAW80BR011	0.5	100	219.1			1	1		
/MAW80BR012	15.5	100	219.1	2			3	1	
/MAW80BR013	48.5	100	219.1	11	1		3	1	
/MAW80BR014	2.0	310	300				2		
/MAW81BR001	4.0	310	114.3	2					1
/MAW81BR002	4.0	310	114.3	3					
/MAW81BR003	7.5	310	168.3	2	1	1	2	1	
/MAW82BR001	4.0	310	114.3	3					
/MAW82BR002	4.0	310	114.3	4					
/MAW82BR003	8.0	310	168.3	4	1	1	2	1	
/MAW83BR001	14.0	310	114.3	6			2	1	
/MAW84BR001	9.0	310	141.3	2		1	2	1	
/MAW84BR002	2.0	310	114.3						

# HOT FACE TEMPERATURES CORRESPOND TO LONG TERM TEMPERATURES OF RESPECTIVE PIPING BOMS.

\* THIS BOM MAY VARY BY +/- 5%.  
 \* TEES and Reducers are not included in pipe length and are to be considered separately for Thermal Insulation as per the above table. This supercedes Clause 2.5 of ST29005 in this regard.

PIPING CODE	APPROX LENGTH (M)	TEMPERATURE (DEG C)	PIPE OD (MM)	ELBOW	TEE	REDUCER	FLANGES	VALVES	BENDS
/MAW855BR001	3.5	310	88.9	4			2	1	
/MAW866BR001	3.5	310	88.9	4			2	1	
/MAW866BR001	3.0	190	88.9						
/MAW866BR002	2.0	190	141.3						
/MAW87BR001	3.0	190	88.9						
/MAW87BR002	2.0	190	141.3						
/MAW88BR001	3.0	190	88.9						
/MAW88BR002	2.0	190	141.3	2		1	2	1	

# HOT FACE TEMPERATURES CORRESPOND TO LONG TERM TEMPERATURES OF RESPECTIVE PIPING BOMS.

\*THIS BOM MAY VARY BY +/- 5%.

\*TEEs and Reducers are not included in piping length and are to be considered separately for Thermal Insulation as per the above table. This supercedes Clause 2.5 of ST29005 in this regard.

DATE: 27.08.2013

BOM FOR THERMAL INSULATION OF TIP : 700 MW  
Drainage Piping System

DOCUMENT NUMBER: 412114U3001  
REVISION NUMBER: 00

PIPING CODE	APPROX LENGTH (M)	TEMPERATURE (DEG C)	PIPE OD (MM)	ELBOW	TEE	REDUCER	FLANGES	VALVES	BENDS
/MAG10BR100	8.0	450	114.3	1			1		
/MAG10BR100	7.0	450	101.6						
/MAG10BR101	6.0	450	323.8						
/MAG10BR101	4.5	450	323.8						
/MAG10BR110	9.0	450	114.3	1			1		
/MAG10BR110	7.5	450	101.6						
/MAG10BR111	6.0	450	323.8	2					
/MAG10BR111	5.5	450	323.9						
/MAL01BR001	2.5	593	323.8	1					
/MAL02BR001	2.0	593	323.8						
/MAL03BR001	1.5	593	323.8	2					
/MAL04BR001	3.5	593	323.9	2					
/MAL11BR001	17.0	565	60.3	14	1			1	
/MAL11BR001	0.5	565	73.1						
/MAL12BR001	12.0	565	60.3	10	1			1	1
/MAL12BR001	0.5	565	73.1						
/MAL14BR001	24.0	486	48.3	9	1			1	
/MAL14BR001	0.5	486	60.3						2
/MAL19BR001	16.0	565	60.3	14	1			1	
/MAL19BR001	0.5	565	73.1						
/MAL20BR001	19.0	539	60.3	9	1			1	
/MAL20BR001	0.5	539	114.3			1			
/MAL22BR001	14.0	505	60.3	8	1	1		1	
/MAL22BR001	7.5	505	48.3	9					5
/MAL22BR001	0.5	505	114.3						
/MAL23BR001	16.0	593	60.3	12	1			1	
/MAL23BR001	2.0	593	33.4	3				1	
/MAL24BR001	23.5	593	60.3	12	1			1	
/MAL24BR001	2.0	593	33.4	3				1	
/MAL25BR001	15.0	439	48.3	10	1			1	

# HOT FACE TEMPERATURES CORRESPOND TO LONG TERM TEMPERATURES OF RESPECTIVE PIPING BOMS.

\* THIS BOM MAY VARY BY +/- 5%.

\* TEES and Reducers are not included in pipe length and are to be considered separately for Thermal Insulation as per the above table. This supercedes Clause 2.5 of ST29005 in this regard.

## Drainage Piping System

PIPING CODE	APPROX LENGTH (M)	TEMPERATURE (DEG C)	PIPE OD (MM)	ELBOW	TEE	REDUCER	FLANGES	VALVES	BENDS
/MAL25BR001	0.5	439	60.3						
/MAL26BR001	12.5	593	60.3	22	1			1	
/MAL26BR001	0.5	593	73.1						
/MAL27BR001	18.5	593	60.3	9	1			1	
/MAL27BR001	0.5	593	73.1						
/MAL31BR001	10.5	593	60.3	10	1	1		1	
/MAL31BR001	20.5	593	33.4	9					
/MAL41BR001	5.5	410	60.3	7	1			1	
/MAL23BR001	0.5	593	73.1						
/MAL24BR001	0.5	593	73.1						
/MAL41BR001	0.5	410	73.1	1					
/MAL45BR001	18.0	492	60.3	8	1			1	
/MAL45BR001	0.5	492	73.1						
/MAL47BR001	6.0	431	60.3	10	1			1	
/MAL47BR001	0.5	432	73.1						
/MAL51BR001	4.5	313	60.3	4	1			1	
/MAL51BR001	20.0	313	33.7		1				9
/MAL51BR001	0.5	313	73.1	5					
/MAL54BR001	17.5	180	88.9	7	1			1	
/MAL54BR001	0.5	180	219.1						
/MAL55BR001	22.0	125	88.9	5	1			1	
/MAL55BR001	0.5	125	114						
/MAL65BR001	16.0	369	60.3	11	1			1	
/MAL65BR001	0.5	369	73						
/MAL81BR001	25.0	540	33.7		3			2	12
/MAL81BR001	0.5	540	48.3	1					

# HOT FACE TEMPERATURES CORRESPOND TO LONG TERM TEMPERATURES OF RESPECTIVE PIPING BOMS.

\*THIS BOM MAY VARY BY +/- 5%.

\*TEEs and Reducers are not included in piping length and are to be considered separately for Thermal Insulation as per the above table. This supercedes Clause 2.5 of ST29005 in this regard.

DATE: 27.08.2013

BOM FOR THERMAL INSULATION OF TIP : 700 MW  
Overload Piping System

DOCUMENT NUMBER: 412114U3001  
REVISION NUMBER: 00

PIPING CODE	APPROX LENGTH (M)	TEMPERATURE (DEG C)	PIPE OD (MM)	ELBOW	TEE	REDUCER	FLANGES	VALVES	BENDS
MAA14BR001	16.0	543	141.3	7					
MAA14BR002	23.0	543	168.3	13					
MAA14BR003	26.0	565	219.1						10

PREPARED BY:

NAVNEET

*Navneet*  
27.08.2013

CHECKED BY: S.K. GUPTA

*S.K. Gupta*  
27/8/13

# HOT FACE TEMPERATURES CORRESPOND TO LONG TERM TEMPERATURES OF RESPECTIVE PIPING BOMS.

\*THIS BOM MAY VARY BY +/- 5%.

\*TEES and Reducers are not included in pipe length and are to be considered separately for Thermal Insulation as per the above table. This supercedes Clause 2.5 of ST29005 in this regard.



# QUALITY PLAN

### LEGENDS:

- P-PERFORMED BY 1-BHEL REP.
- W-WITNESS BY 2-VENDOR
- V-VERIFIED BY 3-SUB-VENDOR

DESCRIPTION: THERMAL INSULATION FOR TURBINE INTEGRAL PIPING

QPNO : QA/BE/QP/316

REV.NO. : 02

SPECNO: ST 29005

REV.NO. : 04

DRG : As Per PO

REV.NO. : -

SL. NO.	COMPONENT/ OPERATION	CHARACTERISTICS	CLASS	TYPE OF CHECK	QUANTUM OF CHECK	REFERENCE DOCUMENT	ACCEPTANCE NORMS	FORMAT OF RECORDS	AGENCY P W V	REMARKS
1	2	3	4	5	6	7	8	9	10 11 12	13

1.0	Material									
1.0	Bonded Mineral/ Rockwool Mattresses									
1.1	Routine Tests									
1.1.1	Chemical Composition	Major	Analysis	1 Sample/Lot	Vendor's Std	Vendor's Std		Test Report*	2 - -	
1.1.2	Bulk Density	Major	Physical	Sample As Per IS 8183	IS 3144	IS 8183		Test Report*	2 1 -	
1.1.3	Recovery After Compression	Major	Physical	-do-	IS 8183	IS 8183		Test Report*	2 1 -	
1.1.4	Shot Content	Major	Chemical	-do-	IS 3144	IS 8183		Test Report*	2 1 -	
1.1.5	Moisture Content and Moisture Absorption	Major	Physical	-do-	IS 3144	IS 8183		Test Report*	2 1 -	
1.1.6	Incombustibility	Major	Thermal	-do-	IS 3144	IS 8183		Test Report*	2 1 -	
1.1.7	Thermal Conductivity or K-Value	Major	Thermal	Sample As Per IS 3144	IS 3346	IS 8183		Test Report*	2 1 -	See note 2
1.1.8	Sulphur Content	Major	Chemical	Sample As Per IS 8183	IS 3144	IS 8183		Test Report*	2 1 -	
1.1.9	Dimensional Check	Major	Measurement	-do-	IS 3144	IS 8183		Inspection Report*	2 1 -	
1.1.10	Fibre Diameter	Major	Measurement	-do-	IS 3144	IS 8183		Inspection Report*	2 1 -	
1.1.11	Resistance to Micro - organism	Major	Physical	-do-	IS 3144	IS 8183		Test Report*	2 - 1	If Applicable See note - 3
1.1.12	Odour Emission	Major	Thermal	-do-	IS 3144	IS 8183		Test Report*	2 - 1	If Applicable See note - 3
1.1.13	Resistance to Vibration	Major	Physical	-do-	IS 3144	IS 8183		Test Report*	2 - 1	See note - 3
1.1.14	Resistance to Jolting	Major	Physical	-do-	IS 3144	IS 8183		Test Report*	2 - 1	See note - 3
1.1.15	Heat Resistance	Major	Thermal	-do-	IS 3144	IS 8183		Test Report*	2 - 1	See note - 3
1.1.16	Alkalinity	Major	Chemical	-do-	IS 8183	IS 8183		Test Report*	2 - 1	See note - 3

*Jal Bahadur*  
*C.S.K. Chavhan*



# QUALITY PLAN

QPNO : QAIBE/QP/316

REV.NO. : 02 THERMAL INSULATION FOR TURBINE INTEGRAL PIPING

SPECNO: ST 29005

REV.NO. : 04

DRG : As Per PO

REV.NO. : -

### LEGENDS:

P-PERFORMED BY I-BHEL REP.

W-WITNESS BY 2-VENDOR

V-VERIFIED BY 3-SUB-VENDOR

SL. NO.	COMPONENT/ OPERATION	CHARACTERISTICS	CLASS	TYPE OF CHECK	QUANTUM OF CHECK	REFERENCE DOCUMENT	ACCEPTANCE NORMS	FORMAT OF RECORDS	AGENCY			REMARKS
									P	W	V	
1	2	3	4	5	6	7	8	9	10	11	12	13

1.1.1.17 Corrosive Attack/ Chloride Content Major Chemical -do- IS 3144 IS 8183 Test Report\* 2 - 1 See note - 3

2.0 Sheathing Material - Aluminium Sheet ( Gr. 19000)

2.1 Chemical Analysis Major Analysis Sample As Per IS 737 IS 737 TC\* 2 - 1

2.2 Tensile Test & Elongation Major Physical -do- IS 737 IS 737 TC\* 2 - 1

2.3 Bend Test Major Physical -do- IS 737 IS 737 TC\* 2 - 1

2.4 Gauging / Thickness Major Measurement -do- ST 29004 ST 29004/ Appd BOM Inspection report\* 2 - 1

3.0 Galvanised Steel / Stainless Steel Wire For Netting, Binding, Stitching & Lacing

3.1 Chemical Composition Major Analysis Sample As Per IS 6528/ IS 280 IS 6528/ IS 280 TC\* 2 - 1

3.2 Dimensions ( Size of netting & Dia / Gauge of Wire ) Major Measurement -do- ST 29004 ST 29004/ Appd BOM Inspection Report\* 2 - 1

3.3 Tensile Test & Elongation Major Physical -do- IS 6528/ IS 280 IS 6528/ IS 280 TC\* 2 - 1

3.4 Wrapping Test Major Physical -do- IS 6528/ IS 280 IS 6528/ IS 280 TC\* 2 - 1

3.5 Bend Test Major Physical -do- IS 6528/ IS 280 IS 6528/ IS 280 TC\* 2 - 1

3.6 Mass of Coating for GI Wire Major Measurement -do- IS 4826 IS 4826 TC\* 2 - 1

4.0 Straps, Bands & Screws

4.1 Dimensional Major Measurement - ST 29005 ST 29005 COC\* 2 -

4.2 Visual Major Physical - ST 29005 ST 29005 COC\* 2 -

5.0 Packing / Marking & Storage

5.1 Identification & Marking Major Visual 100% ST 29005 ST 29005 Internal Records 2 - -

*(S.V. Chaudhary)*

Page 3 of 3

**QUALITY PLAN**

QPNO : QABEIQP/316

SPECNO: ST 29005

DRG : As Per PO

REV.NO. : 02

REV.NO. : 04

REV.NO. : -

DESCRIPTION: THERMAL INSULATION FOR TURBINE INTEGRAL PIPING

SL. NO.	COMPONENT/ OPERATION	CHARACTERISTICS	CLASS	TYPE OF CHECK	QUANTUM OF CHECK	REFERENCE DOCUMENT	ACCEPTANCE NORMS	FORMAT OF RECORDS	AGENCY P W V	REMARKS
1	2	3	4	5	6	7	8	9	10 11 12	13
5.2	Packing & Despatch		Major	Visual	100%	ST 29005	ST29805	Internal Records	2 - -	

**LEGENDS:**

- P-PERFORMED BY 1-BHEL REP.
- W-WITNESS BY 2-VENDOR
- V-VERIFIED BY 3-SUB-VENDOR

**NOTE:-**

1. Records as marked \* shall essentially be submitted by vendor as QA documentation package.
2. Thermal Conductivity or 'K' Value test report on the samples identified and tested in last SIX MONTHS shall be reviewed by BHEL / BHEL nominated agency during inspection. However samples for Thermal Conductivity or 'K' Value test shall be identified by BHEL / BHEL nominated agency from EACH LOT and test shall be conducted at CBRI ROORKEE / IIT CHENNAI / PIBCO, NEW DELHI / M/s ISOLLOYD ENGINEERING TECHNOLOGIES LIMITED, BADDI. The test report of the same shall be submitted to BHEL for review and acceptance.
3. These tests shall be witnessed by BHEL / BHEL nominated agency ONCE IN A YEAR at vendor's works and during inspection tests conducted in last ONE YEAR shall be reviewed by inspecting agency.

*S.K. Chauhan*

**सतीश कुमार चौहान/S.K. CHAUHAN**  
 उप प्रबन्धक/ Dy. Manager (QAX)  
 बी.एच.ई.एल., हरिद्वार/BHEL, HARIDWAR