

VOLUME-IB

SPECIAL CONDITIONS OF

CONTRACT (SCC)

ELECTRICAL AND C&I WORKS (30.03.2022, REV 00)

BHARAT HEAVY ELECTRICALS LIMITED

CONTENTS

SI No	DESCRIPTION	Chapter	No. of Pages
1	General Intent of the Specifications	Chapter-I	
2	General Services to be rendered by the Bidder	Chapter-II	
3	General Technical Requirements (Codes and Standards)	Chapter-III	
4	Obligations of Contractor (In respect of Tools, Tackles, Consumables, etc. employment of supervisory staff and workmen)	Chapter-IV	
5	Responsibilities of Contractor (In respect of employment of Labour, Supervisory staff, etc.)	Chapter-V	
6	Material Handling, Storage, Preservation, etc	Chapter-VI	
7	Drawings and Documents	Chapter-VII	
8	Inspection and Quality	Chapter-VIII	
9	HSE Obligations	Chapter-IX	
10	RA Bill Payment	Chapter-X	

SPECIAL CONDITIONS OF CONTRACT (SCC)-Electrical and C&I

Chapter - I : General Intent of Specifications

1.0	INTENT OF THE SPECIFICATION
1.1	<p>The intent of this erection specification is to provide services for execution of the project according to most modern and proven techniques and codes. The omission of specific reference to any method, equipment or material necessary for the proper and efficient services towards installation of the plant shall not relieve the contractor of the responsibility of providing such services / facilities to complete the work or portion of work awarded to him. The quoted / accepted rates / price shall deem to be inclusive of all such contingencies.</p>
1.2	<p>The work shall conform to dimensions and tolerances given in various drawings and documents that will be provided during erection. If any portion of works is found to be defective in workmanship and not conforming to drawings / documents or other stipulations, the contractor shall dismantle and re-do the work duly replacing the defective materials at their own cost, failing which recoveries, as determined by BHEL, shall be effected from contractor's bills.</p>
1.3	<p>It is not the intent of this specification to specify herein all the details of erection and commissioning. However, the system shall conform in all respects to high standards of quality and workmanship for performing the required duties in a manner acceptable to purchaser who will interpret the meaning of drawings and specifications and shall be entitled to reject any work or material, which in his judgments is not in full accordance herewith.</p>
1.4	<p>The omission of specific reference to any fabrication / erection or other method, equipment or material necessary for proper and efficient working of the plant shall not relieve the tenderer of the responsibility of providing such facilities to complete the work at quoted rates. Any mismatch/ defect found due to mistake in fabrication / erection shall have to be rectified by the vendor free of cost. Inspection by BHEL/Customer does not relieve vendor of his responsibility of executing quality erection.</p>
1.5	<p>The work covered under this specification is of highly sophisticated nature, requiring the best quality workmanship, supervision, engineering and construction management. The contractor should ensure proper planning and successful and timely completion of the work to meet the overall project schedule. The contractor must deploy adequate quantity of tools & plants, modern / latest construction aids etc. He must also deploy adequate trained, qualified and experienced supervisory staff and skilled personnel.</p>

SPECIAL CONDITIONS OF CONTRACT (SCC)-Electrical and C&I

Chapter - I : General Intent of Specifications

1.6	Contractor shall erect and commission all the equipments and auxiliaries as per the sequence & methodology prescribed by BHEL depending upon the technical requirements. Availability of materials and fronts will decide this. BHEL Engineer's decision regarding correctness of the work and method of working shall be final and binding on the contractor. No claims for extra payment from the contractor will be entertained on the ground of deviation from the methods / sequence adopted in erection of similar sets elsewhere.
1.7	Following shall be the minimum responsibility of contractor and have to be provided within finally accepted rates / prices:
1.7.1	Provision as required of all types of labour, supervisors, engineers, watch and ward, tools & tackles, calibrated MMEs (Monitoring and Measuring Equipment) as specified and otherwise required for the work, consumables for erection, testing and commissioning including material handling
1.7.2	Achieving Proper out-turn / Turn-over as per BHEL plan and commitment.
1.7.3	Completion of work as per BHEL Schedule
1.7.4	Good quality and accurate workmanship for proper performance of the equipment
1.7.5	Repair and rectification
1.7.6	Preservation / Re-conservation of all components during storage / erection / commissioning till Commercial Operation Declaration (COD) / Trial Run Operation whichever is later.

SPECIAL CONDITIONS OF CONTRACT (SCC)-Electrical and C&I
Chapter - II : General Services to be rendered by the Bidder

2.0	GENERAL SERVICES TO BE RENDERED BY THE BIDDER
2.1	Services for construction, fabrication, equipment erection testing as well as trial run & commissioning of various equipment and accessories under the contract shall include but not be limited to the following:
2.2	Issuing materials from store / open yard from time to time for erection as per the construction programme. The Contractor shall be the custodian of all the materials issued after complete erection till the plant/equipment is officially taken over by the owner / OR up to COD / Trial operation whichever is later.
2.3	Transport of material to their respective places of erection and erection of the complete plant & equipment as supplied under this specification.
2.4	Trial run and commissioning of individual equipment / sub-systems to the satisfaction of Owner / BHEL.
2.5	<p>Deployment of all skilled and unskilled manpower required for erection, supervision of erection, watch & ward, commissioning and other services to be rendered under this specification. Brief experience details of skilled and unskilled manpower are as under. **(Quantity as mentioned below is for reference purpose only and can be determined at sites as per project milestone requirements)</p> <ol style="list-style-type: none"> 1. Project Manager - 5 Years' Experience in Industrial / Construction Project Site. 2. Experienced E&C Engineers - For commissioning & erection work. Contractor must depute engineer with at least 03 Years' Experience in similar Project. Fresh engineers with less than 03 Years or no experience, if deployed by contractor at sites will not be counted as working manpower. It will be assumed that fresher staff are deployed only for training purpose at the risk of contractor itself. Contractor to submit the experience details of deployed manpower to BHEL site package in charge for approval. 3. Experienced Instrument Calibration technician for C&I Lab 4. Experienced Foreman / Supervisors (05 Years' Experience) 5. Planning & Billing Engineer 6. Stores, Gate Pass 7. IBR welder deployment should be included in the scope of C&I Contractor for exclusively for welding of High-Pressure Impulse Lines. Schedule and duration for the same to be mutually decided. 8. Accounts & Administration 9. Quality Control Engineer (03 Years' Experience)

SPECIAL CONDITIONS OF CONTRACT (SCC)-Electrical and C&I
Chapter - III : General Technical Requirements
(Codes and Standards)

	10. Safety Engineer (03 Years' Experience) 11. Security Guards (Round The Clock) As per requirement.
2.6	Deployment of all erection tools & tackle, construction machinery, transportation vehicles and all other implements in adequate number and size, appropriate for the erection work to be handled under scope of this specification except otherwise specified.
2.7	Supply of all consumables, e.g. welding electrodes, cleaning agents, diesel oil, lubricant etc. as well as materials required for temporary supports, scaffolding etc. as necessary for such erection work, unless specified otherwise.
2.8	Providing support services for the contractor's erection staff e.g. construction of site offices, temporary stores, residential accommodation and transport to work site for erection personnel, watch and ward for security and safety of the materials under the Contractor's custody etc. as required.
2.9	Maintaining proper documentation of all the site activities undertaken by the Contractor as per the Proforma mutually agreed with BHEL, Submission of monthly progress reports and any such document as and when desired by BHEL / owner, taking approval of all statutory authorities i.e. Electrical Inspector, Factory Inspector, Inspector of Explosives etc. as applicable for respective portions of work fall under the jurisdiction of such statutes of laws.
2.10	Any other service, although not specifically called for but required for a contract of the size and nature indicated in the specification.

SPECIAL CONDITIONS OF CONTRACT (SCC)-Electrical and C&I
Chapter - III : General Technical Requirements
(Codes and Standards)

3.0	GENERAL TECHNICAL REQUIREMENTS (CODES AND STANDARDS)
3.1	Except where otherwise specified, the plant/equipment shall comply with the appropriate Indian Standard or an agreed internationally accepted Standard Specification as mentioned elsewhere in contract specifications, each incorporating the latest revisions at the time of tendering. Where no internationally accepted standard is applicable, the Bidder shall give all particulars and details as necessary, to enable BHEL to identify all of the plant/equipment in the same detail as would be possible had there been a Standard Specification.
3.2	Where the Bidder proposes alternative codes or standards he shall include in his tender one copy (in English) of each Standard Specification to which materials offered shall comply. In such case, the adopted alternative standard shall be equivalent or superior to the standards mentioned in the specification.
3.3	In the event of any conflict between the codes and standards referred above, and the requirements of this specification, the requirements which are more stringent shall govern.
3.4	Tools used during erection and commissioning shall not be accepted except with the specific approval of the Engineer.

SPECIAL CONDITIONS OF CONTRACT (SCC)-Electrical and C&I
Chapter - IV : Obligations of Contractor

4.0	OBLIGATIONS OF CONTRACTOR
4.1	CONSUMABLES & OTHER ITEMS
4.1.1	The contractor shall provide within finally accepted price / rates, all consumables (excepting those indicated in BHEL scope) like welding electrodes (including alloy steel and stainless steel), filler wires, TIG filler wires (over & above as supplied by the unit along with the plant materials, which will be given free of cost to bidder), gases (inert, welding, cutting), soldering material, dye penetrants, radiography films, etc. Other erection consumables such as tapes, jointing compound (As applicable), grease, mobile oil, M-seal, Araldite, petrol, CTC / other cleaning agents, grinding and cutting wheels are to be provided by the contractor. Steel, packers (<10 mm), wooden planks, scaffolding materials hardware items etc. required for temporary works such as supports, scaffoldings are to be arranged by the contractor. Sealing compounds, gaskets, gland packing, wooden/concrete sleepers, for temporary work, required for completion of work except those which are specifically supplied by manufacturing unit are also to be arranged by the contractor.
4.1.2	All the gaskets and packing, which go finally as part of plant equipment, shall be supplied by BHEL free of cost.
4.1.3	It shall be the responsibility of the contractor to plan the activities and store sufficient quantity of consumables. Non-availability of any consumable materials or equivalent suggested by BHEL cannot be considered as reason for not attaining the required progress or for additional claim.
4.1.4	It shall be the responsibility of the contractor to obtain prior approval of BHEL, regarding suppliers, type of electrodes etc. before procurement of welding electrodes. On receipt of electrodes at site these shall be subjected to inspection and approval by BHEL. The contractor shall inform BHEL details regarding type of electrodes, batch number, date of expiry etc. and produce test certificate for each lot / batch with correlation of batch / lot number with respective test certificate. No electrode without a valid test certificate will be used.
4.1.5	BHEL reserves the right to reject the use of any consumable including electrodes, gases, lubricants / special consumables if it is not found to be of the required standard / make / purity or when shelf life has expired. Contractor shall ensure display of shelf life on consumable wherever required and records maintained.

SPECIAL CONDITIONS OF CONTRACT (SCC)-Electrical and C&I
Chapter - IV : Obligations of Contractor

4.1.6	Storage of all consumables including welding electrodes shall be done as per requirement / instruction of the Engineer by the contractor at his cost.
4.1.7	In case of improper arrangement for procurement of any consumable, BHEL reserves the right to procure the same from any source and recover the cost from the Contractor's first subsequent bill at market value plus the departmental charges of BHEL from time to time. Postponement of such recovery is normally not permitted. The decision of Engineer in this regard shall be final and binding on the Contractor.
4.1.8	All the consumables viz. Cleaning Agents, PVC Tapes, Welding Electrodes, Ferrules, Lugs below 4 Sqmm etc. Required for pre-commissioning, commissioning, testing, preservation for trial runs of the equipment shall be supplied by Vendor without any cost implication on BHEL. All services including labour and T&P will be provided by the contractor for handling, filling, emptying, refilling etc. Surplus material if any (Issued from BHEL / Customer Store) shall be properly stacked / tagged and returned to BHEL / CUSTOMER stores at no extra cost to BHEL. BHEL reserves the right to recover costs for wastage by the contractor.
4.1.9	Transportation of oil drums, from stores, filling of oil for filtration, first filling, subsequent changeover if any, topping/making up till the unit is fully commissioned and handed over to customer is included in scope of this contract. The contractor shall have to return all the empty drums to BHEL / BHEL's client store at no extra cost. Any loss / damage to above drums shall be to contractor's account.
4.1.10	It is the responsibility of contractor to take work permit before attending the defects or carrying out troubleshooting or painting work in commissioned systems and equipment's.
4.2	TOOLS AND PLANTS / MONITORING AND MEASURING EQUIPMENT (MMEs)
4.2.1	T&Ps and MMEs to be provided by Contractor
4.2.1.1	All T&Ps and MMEs excepting those specifically indicated in BHEL scope are to be provided by the Contractor. Record of availability of T&Ps and MMEs with Valid Fitness/Calibration Certificate of T&P & MME's need to be submitted on monthly basis by contractor to site package in charge. Contractor has to make his own arrangement at his cost for completing the formalities (including arrangement of Road permits, if any) if required with GST authorities, for bringing their

SPECIAL CONDITIONS OF CONTRACT (SCC)-Electrical and C&I
Chapter - IV : Obligations of Contractor

	materials, plants and equipments at site for the execution of work under this contract.
4.2.1.2	All suitable cranes, lifting and transport equipments for material handling at stores/yard/siding of BHEL/Customer are included in scope. BHEL's cranes will not be available for this purpose unless otherwise specifically permitted as per contract conditions
4.2.1.3	All T&Ps to be deployed by the contractor shall have the approval of BHEL Engineer with regard to brand, quality and specification.
4.2.1.4	Indicative list of Major T&Ps in the scope of Contractor are given in the Technical Conditions of Contract. Bidders to note that these are only indicative and as such all other T&P necessary for timely and satisfactory completion of work in scope shall be mobilized by Contractor
4.2.1.5	Timely deployment of adequate T&Ps / MMEs is the responsibility of the contractor. The contractor shall be prepared to augment the T&P / MMEs at short notice to match the planned programme and to achieve the milestones.
4.2.1.6	Contractor shall maintain and operate his tools and plants in such a way that major breakdowns are avoided. In the event of major breakdown, contractor shall make alternative arrangements expeditiously so that the progress of work is not hampered.
4.2.1.7	In the event of contractor failing to arrange the required tools, plants, machinery, equipment, material or non-availability of the same owing to breakdown, BHEL will make alternative arrangement and recover the cost incurred for the same along with 5% overheads . Decision of BHEL shall be final and binding on the contractor. It is not obligatory on the part of BHEL to provide any tools and tackles or other materials other than those specifically agreed to do so by BHEL. However, depending upon the availability, BHEL / BHEL's Customer handling equipment and other plants may be made available to the contractor on payment of hire charges as fixed, subject to the conditions laid down by BHEL/ Customer from time to time. Unless paid in advance, such hire charges, if applicable, shall be recovered from contractor's bill / security deposit or any other due payment in one instalment.
4.2.1.8	The T&P to be arranged by the contractor shall be in proper working condition and their operation shall not lead to unsafe condition. The movements of cranes, and other equipment should be such that no damage / breakage occurs to foundations, other equipments, material,

SPECIAL CONDITIONS OF CONTRACT (SCC)-Electrical and C&I
Chapter - IV : Obligations of Contractor

	property and men. All arrangements for the movement of the T&P etc. shall be the contractor's responsibility.
4.2.1.9	Use of welding generators / rectifiers only shall be permitted for welding. Use of welding transformers will be subject to specific approval of BHEL engineer.
4.2.1.10	The contractor at his cost shall carry out periodical testing of his construction equipment. Test and calibration certificates shall be furnished to BHEL.
4.2.1.11	Contractor shall ensure deployment of serviced and healthy T&Ps including cranes, lifting tackles, wire ropes, manila ropes, winches and slings etc. History card and maintenance records for major T&Ps will be maintained by the contractor and will be submitted to BHEL Engineer for inspection on monthly basis. Fitness certificate / Test Certificates of T&P shall have to be submitted before it is put in use. Identification for such T&Ps will be done as per BHEL Engineer's advice.
4.2.1.12	Contractor shall ensure deployment of reliable and calibrated MMEs (Inspection measuring and Monitoring equipment). The MMEs shall have test / calibration certificates from authorized / Government approved / accredited agencies traceable to National / International standards. Each MME shall have a label indicating calibration status i.e. date of calibration, calibration agency and due date for calibration. A list of such instruments deployed by contractor at site with its calibration status is to be submitted to BHEL Engineer on monthly basis in prescribed format for control.
4.2.1.13	Re-testing / re-calibration shall also be arranged at regular intervals during the period of use as advised by BHEL Engineer within the contract price. The contractor will also have alternate arrangements for such MME so that work does not suffer when the particular instrument is sent for calibration. If any MMEs not found fit for use, BHEL shall have the right to stop the use of such item. It will be necessary for the contractor to deploy proper item. Any readings taken by the defective instrument will be recalled and repeat the readings taken by that instrument with a proper one. In case he fails to do so, BHEL may deploy MMEs and retake the readings at contractor's cost.
4.2.1.14	BHEL shall have lien on all T&P, MMEs and other equipment of the contractor brought to the site for the purpose of work awarded by BHEL. BHEL shall continue to hold the lien on all such items throughout the period of contract / extended period. The contractor and / or his sub-contractors, without the prior written approval of the Engineer, shall remove no material brought to the site for the purpose of work awarded by BHEL.

SPECIAL CONDITIONS OF CONTRACT (SCC)-Electrical and C&I

Chapter - IV : Obligations of Contractor

4.2.1.15	The month wise T&P deployment plan to execute the work is to be submitted as per relevant format as per the instruction of BHEL. It shall be the contractor's responsibility to deploy the required T&P, for timely and successful completion of the job, to any extent.
4.2.1.16	Contractor shall provide all the Measuring Monitoring Equipment (MMEs) required for completion of the work satisfactorily. These MMEs shall be of reputed brand, quality and accuracy specified by BHEL Engineer and should have necessary calibration and other certificates as per the requirement of BHEL Engineer. Decision of BHEL Engineer regarding acceptance or otherwise of the measuring instruments/gauges/tools for the work under this specification, is final and binding on the contractor. BHEL may give an indicative list of MMEs required for this work and to be made available by the contractor. The list will be reviewed by BHEL and the contractor shall meet any augmentation needed wherever required.
4.2.1.17	It is the responsibility of the contractor to prove the accuracy of the testing/measuring/calibrating equipment's brought by him based on the periodicity of calibration as called for in the BHEL's quality assurance standards/BHEL Engineer's instructions. The monthly status of calibration and availability record of MMEs is to be submitted by contractor as per relevant format to BHEL Package in charge.
4.2.2	Obligations in respect of T&Ps and MMEs provided by BHEL
4.2.2.1	T&P / MMEs being provided by BHEL to sub-contractor free of hire charges shall be shared by other subcontractors working for BHEL at site and the allotment done by BHEL Engineer shall be final and binding.
4.2.2.2	BHEL T&P will be issued in basic assembled condition. Additional loose components / sub-assemblies / attachments as and when necessary, will be issued by BHEL. Assembly of such additional loose components / sub-assemblies / attachments is in contractor's scope.
4.2.2.3	In case of non-availability of the T&Ps to be provided by BHEL due to breakdown, major overhauls, distribution pattern or any other reason, the contractor shall plan / amend / alter his activities to meet erection / commissioning targets in consultation with BHEL.
4.2.2.4	The contractor shall engage trained and experienced operators for the operation of BHEL's T&Ps. Their skill / performance will be checked by BHEL Engineer before they are allowed to operate the same. However, checking of skills by BHEL does not absolve the contractor of his responsibilities for proper and safe handling of equipment, consistent good performance of operators and regular performance evaluation of operators.

SPECIAL CONDITIONS OF CONTRACT (SCC)-Electrical and C&I
Chapter - IV : Obligations of Contractor

4.2.2.5	The day to day operation and maintenance of BHEL's T&Ps (other than cranes) shall be carried out by contractor as per manufacturer's / BHEL's maintenance schedule at his cost. The contractor shall arrange, at his own cost, trained operators, fuel and other consumables for their operation. The contractor has to arrange for fixing of the spares; supervision in specialized cases will be provided by BHEL. For upkeep of all other T&Ps supplied by BHEL, (As per TCC). BHEL supplied T&Ps shall be maintained in good working condition during the entire period of use. T&Ps in defective / damaged condition shall be rectified promptly to the full satisfaction of BHEL engineer. Contractor shall maintain records for maintenance of major T&Ps. These shall be made available for inspection whenever required. In case of any lapses on the part of the contractor, BHEL at its own discretion shall get the servicing / repair of equipment done and recover the cost incurred for the same along with 5% overheads . Further, if there are breakdowns / damages due to negligence of the contractor, the complete service / repair charges and cost of all the spares damaged with BHEL overheads shall be recovered from contractor's RA bills.
4.2.2.6	Increasing / shortening of the crane boom to suit work requirements shall have to be arranged by the indenting contractor at his cost including restoration to a state as directed by BHEL. All necessary manpower tools, support, consumables, illumination etc. will have to be arranged by contractor at his cost. If required, contractor has to return the crane with original boom.
4.2.2.7	The area and infrastructure development of the area to be carried out by the customer. However, in construction projects of this magnitude it is possible that all the areas / approaches may not be ready. In such cases backfilling of approaches where ever necessary, consolidation of ground and arrangement of sleepers / sand bag filling etc. for safe operation / movement of equipment including cranes / trailers etc. shall be the responsibility of the contractor at his cost. No compensation on this account shall be payable.
4.2.2.8	In the event of contractor not using and maintaining BHEL T&Ps according to BHEL's instructions. BHEL will have the right to withdraw such item without any notice and no claim in this regard shall be entertained and contractor shall be responsible for delay in execution on this account.
4.2.2.9	The contractor shall furnish regular utilization report of the BHEL T&Ps, as per requirement of BHEL.

SPECIAL CONDITIONS OF CONTRACT (SCC)-Electrical and C&I
Chapter - IV : Obligations of Contractor

4.2.2.10	Any loss / damage to any part of BHEL T&Ps and MMEs shall be to the contractor's account and any expenditure on these accounts by BHEL will be recovered from the contractor's bill in case the contractor fails to make good the loss.
4.2.2.11	It shall be responsibility of the contractor to take delivery of T&Ps and MMEs from stores or place of use by other contractor at project site, transport the same to site and return the same to BHEL store / place as intimated by Engineer in project site in good working conditions after use.
4.2.2.12	The contractor shall return BHEL T&Ps and MMEs issued to him in good working condition as and when desired by BHEL (on completion or reduction of workload). If contractor delays return of T&P and MME, hire charges as applicable shall be levied by BHEL from time, it was requisitioned till the time of actual return. T&Ps and MMEs returned in damaged / unserviceable condition shall be got repaired by BHEL at its own discretion and entire cost of repair with BHEL overheads shall be recovered from the contractor.
4.2.2.13	Replacement cost including BHEL overheads in respect of irreparable / completely damaged / non-return of T&Ps and MMEs shall be recovered from the contractor's running / final bills
4.2.2.14	Obligations in respect of Cranes provided by BHEL
a)	BHEL will make available the cranes (as per Technical Conditions of Contract) free of charge to the contractor on sharing basis mainly for the purposes enumerated/ indicated therein. BHEL cranes have to be shared with other agencies / contractors of BHEL. The allocation of cranes shall be the discretion of BHEL engineer, which shall be binding on the contractor.
b)	In case BHEL cranes / EOT (Electrically operated trolley) are covered under AMC awarded by BHEL, then the day-to-day upkeep and running maintenance as described above are excluded from scope. However, any additional helpers if any required during Preventive / Breakdown Maintenance, Assembly / disassembly shall be provided by contractor at no extra cost. BHEL may also provide cranes through crane hiring agencies in which case the day-to-day upkeep and running maintenance shall be excluded from scope of contractor.
c)	Minor consumables like cotton cloth, cotton waste, etc. is to be supplied by Contractor. All spares and lubricants / grease are excluded from scope. Contractor to give the requirements of these items well in advance in case the cranes provided by BHEL are BHEL owned cranes.

SPECIAL CONDITIONS OF CONTRACT (SCC)-Electrical and C&I
Chapter - IV : Obligations of Contractor

d)	Unless otherwise specified, trained operators for BHEL owned cranes shall be provided by the contractor. These operators should possess valid license for heavy vehicle.
e)	BHEL cranes/EOT (Electrically Operated Trolley) will be withdrawn for regular and capital maintenance as per the respective schedule of maintenance. As far as possible such schedules will be intimated to the contractor in advance and may be adjusted depending on the work requirements at site. However, no claim whatsoever will be entertained on account of non-availability of cranes.
f)	Where the services of the cranes provided by BHEL are to be shared by other agencies / contractors of BHEL, the contractor's responsibilities defined above will also be apportioned accordingly to the beneficiary agency. Working arrangements in this regard will be done at site by BHEL engineer and in any case his decision shall be final and binding.
g)	Major breakdowns will be attended to by BHEL. However, in case of breakdowns or damages due to negligence of the contractor, the complete service / repair charges including cost of spares shall be to the account of the contractor, along with BHEL overheads.

SPECIAL CONDITIONS OF CONTRACT (SCC)-Electrical and C&I
Chapter - V : Responsibilities of Contractor in respect of
Labour, Supervisory Staff, etc.

5.0	RESPONSIBILITIES OF CONTRACTOR IN RESPECT OF LABOUR, SUPERVISORY STAFF, ETC.
5.1	Refer relevant clauses of General Conditions of Contract (GCC) also in this regard.
5.2	The contractor shall deploy all the necessary skilled / semi-skilled / unskilled labour including highly skilled workmen etc. These workmen should have previous experience on similar job. They shall hold valid certificates wherever necessary. Commissioning staff deputed at site must have at least 3 years of experience of similar type of job. BHEL reserves the right to insist on removal of any employee of the contractor at any time if he is found to be unsuitable and the contractor shall forthwith remove him.
5.3	Contractor shall also comply with the requirements of local authorities / project authorities calling for police verification of antecedents of the workmen, staff etc.
5.4	It is the responsibility of the contractor to engage his workmen in shifts and or on overtime basis for achieving the targets set by BHEL. This target may be set to suit BHEL's commitments to its customer or to advance date of completion of events or due to other reasons. Prior Information will be communicated by BHEL to contractor for arrangement of required manpower and T&Ps / MMEs at no extra cost to BHEL. The decision of BHEL in regard to setting the erection and commissioning targets will be final and binding on the contractor.
5.5	Contractor shall provide at different elevation suitable arrangement for urinal and drinking water facility with necessary plumbing & disposal arrangement including construction of septic tank. These installations shall be maintained in hygienic condition at all times.
5.6	The Contractor in the event of engaging 20 or more workmen, shall obtain Independent license under the Contract labour (Regulation and Abolition) Act 1970 from the concerned authorities based on Form-V issued by the Principal Employer / Customer. In order to issue Form-V by Customer, Contractor shall fulfill all Statutory requirements like Insurance Policy, PF Code / PF Account number etc. as per the requirement of BHEL / Customer.
5.7	Contractor shall deduct the necessary amount towards Provident Fund and contribute equal amount as per Government of India laws. This amount will be deposited regularly to the provident Fund Commissioner. BHEL / Customer may insist for submission of the account code duly certified by PF Commissioner.
5.8	Contractor may also be required to comply with provisions of ESI Act in vogue if applicable and submit evidence to BHEL.

SPECIAL CONDITIONS OF CONTRACT (SCC)-Electrical and C&I
Chapter - V : Responsibilities of Contractor in respect of
Labour, Supervisory Staff, etc.

5.9	BHEL / customer may insist for witnessing the regular payment to the labour. They may also like to verify the relevant records for compliance with statutory requirements. Contractor shall enable such facilities to BHEL / Customer. Documentary proof of Labour wage payment with bank seal and sign should be submitted every month with RA Bill. All Labours should be provided with Labour ID Card as per format prescribed by Labour department.
5.10	Contractor shall deploy only qualified and experienced engineers / supervisors. They shall have professional approach in executing the work. Refer Clause No. 2.5.
5.11	The contractor's supervisory staff shall execute the work in the most professional manner in the stipulated time. Accuracy of work and aesthetic finish are essential part of this contract. They shall be responsible to ensure that the assembly and workmanship conform to dimensions and tolerances given in the drawings/instructions given by BHEL engineer from time to time.
5.12	The supervisory staff employed by the contractor shall ensure proper outturn of work and discipline on the part of the labour put on the job by the contractor. Also, in general they should see that the works are carried out in a safe and proper manner and in coordination with other labour and staff employed directly by BHEL or other contractors of BHEL or BHEL's client.
5.13	It is the responsibility of the contractor to arrange gate pass for all his employees, T&P etc. for entering the project premises. Necessary coordination with customer officials is the responsibility of the contractor. Contractor to follow all the procedures laid down by the customer for making gate passes. Where permitted, by customer / BHEL, to work beyond normal working hours, the contractor shall arrange necessary work permits for working beyond normal working hours.
5.14	The actual deployment will of Labour and Engineer / supervision staff shall be so as to satisfy the erection and commissioning targets set by BHEL. If at any time, it is found that the contractor is not in a position to deploy the required engineers / supervisors / workmen due to any reason, BHEL shall have the option to make alternate arrangements. The expenditure incurred along with BHEL overheads thereon shall be recovered from the contractor.
5.15	Contractor shall not deploy women labour at night.

SPECIAL CONDITIONS OF CONTRACT (SCC)-Electrical and C&I
Chapter - V : Responsibilities of Contractor in respect of
Labour, Supervisory Staff, etc.

5.16	<p>Contractor shall arrange and ensure availability of transportable adequate nos. of first aid kits to take to site in case of emergencies. The first-aid materials shall be easily accessible for the first-aid providers for whose use they are intended.</p> <p>It is the responsibility of contractor to maintain the materials in first aid kits and replaced any item on expiration. Further contractors to follow the HSE Plan for subcontractors as per BHEL HSE Document Ref No.HSEP14_HSE_Plan_for_Subcontractors_Rev01 (HSEP:14 Dated.20/01/2020)</p>
5.17	<p>It is recommended that laminated paper IDs with photograph to be worn visibly on site by all the skilled and unskilled staff of contractor. Contractor shall issue ID to site staff as per extant site practice.</p>
5.18	<p>Contractor shall provide personal protective equipment to all Contractor's personnel working on Site which are required to use according to BHEL's /Customer's Site HSE regulations but shall at least provide hard helmets, safety boots and safety goggles.</p>

SPECIAL CONDITIONS OF CONTRACT (SCC)-Electrical and C&I
Chapter - VI : Material Handling, Storage & Preservation

6.0	MATERIAL HANDLING, STORAGE AND PRESERVATION ETC
6.1	MATERIAL HANDLING AND STORAGE
6.1.1	All the equipments/materials furnished under this contract shall be received from the project stores, sheds / storage yards and transported to pre-assembly area / erection site and stored in the storage spaces in a manner so that they are easily retrievable till the contractor erects them. While drawing/lifting material from BHEL / customer stores, the contractor shall ensure that the balance / other materials are stacked back immediately. No claim is admissible on this account
6.1.2	While BHEL will endeavor to store / stack / identify materials properly in their open / close / semi closed / tarpaulins covered storage yard / shed, it shall be contractor's responsibility to assist BHEL in identifying materials well in time for erection. They should take the delivery of the same, following the procedure indicated by BHEL, and transport the material safely to pre-assembly yard / erection site in time, according to program.
	In case of control and instrumentation, material storage should be done at site in containers/ closed shed only. Prior to mobilization of Manpower and T&P/MME's/Calibration Equipments, BHEL along with contractor will define no. of Storage containers / closed sheds to be deployed at site to cater the site requirements. Also, for Calibration of instruments separate containers with calibration Test Bench / Desktop PC with operator for Calibration Records to be included in the scope of Contractor.
6.1.3	The contractor shall take delivery of components, equipment / consumables from storage area after getting the approval of BHEL Engineer on standard indent forms.
6.1.4	The contractor shall identify and deploy necessary Engineers / supervisors / workmen for the above work in sufficient number as may be needed by BHEL, for areas covering their scope.
6.1.5	All the equipment shall be handled very carefully to prevent any damage or loss. No untested wire ropes / slings etc. shall be used for unloading / handling. Valid fitness/load test certificate need to be submitted before execution of erection/lifting/handling work. The equipment shall be properly protected to prevent damage either to the equipment or to the floor where they are stored. The equipment from the stores shall be moved to the actual location at the appropriate time so as to avoid damage of such equipment at site.

SPECIAL CONDITIONS OF CONTRACT (SCC)-Electrical and C&I

Chapter - VI : Material Handling, Storage & Preservation

6.1.6	Contractor shall ensure that while lifting slings shall be put over the points indicated on the equipment or as indicated in the manufacturer's drawings. Slings / shackles of proper size shall be used for all lifting and rigging purposes. All care shall be taken to safe guard the equipment against any damage. Dragging of piping / valves should be avoided. In case of any damage the cost shall be covered from the contractor, for those equipment's which are issued, stored, erected & commissioned by contractor.
6.1.7	Approach road conditions from the stores / yards to the erection site may not be equipped and ideal for smooth transportation of the equipment. Contractor may have to be adequately prepared to transport the materials under the above circumstances without any extra cost. The contractor may familiar himself with soil conditions at site.
6.1.8	Contractor shall be responsible for examining all the plant and materials issued to him and notify the Engineer immediately of any damage, shortage, discrepancy etc. before they are moved out of the stores / storage area. The contractor shall be solely responsible for any shortages or damages in transit, handling, storage, theft and erection of the equipment once received by him. Materials once taken over will be deemed to have been received in good condition and in correct quantities except for intrinsic defects which cannot be observed by visual and dimensional inspection and weighing. As the erection work will be spread in different areas / locations of the project, contractor has to arrange sufficient number of watch / ward personal to avoid any pilferage of materials erected by the contractor.
6.1.9	The contractor shall maintain an accurate and exhaustive record-detailing out the list of all equipment received by him for the purpose of erection and keep such record open for the inspection of the engineer at any time.
6.1.10	All the material in the custody of contractor and stored in the open or dusty locations must be covered with suitable weather proof / fire retardant covering material wherever applicable and shall be blocked up on raised level above ground. All covering materials including blocks and sleeper shall be arranged by the contractor at his cost.
6.1.11	If the material belonging to the contractor are stored in area other than those earmarked for his operation the engineer will have the right to get it moved to the area earmarked for the contractor and recover the cost incurred for the same along with 5% overheads.

SPECIAL CONDITIONS OF CONTRACT (SCC)-Electrical and C&I

Chapter - VI : Material Handling, Storage & Preservation

6.1.12	The contractor shall be responsible for making suitable indoor storage facilities to store all equipment (drawn by the contractor from BHEL / customer stores), which require indoor storage till the time of their installation. The Engineer will direct the contractor in this regard, which item in his opinion will require indoor storage, and the contractor shall comply with Engineer's decision.
6.1.13	All materials issued by BHEL shall be utilized as directed by Engineer-in-Charge or most economically in the absence of such direction. The contractor shall ensure that all surplus / damaged / scrap / unused material, packing wood / containers/ special transporting frames etc. are returned to BHEL at a place in project area identified by the Engineer. The contractor will maintain an account for all items received and returned to BHEL. Any shortage in returning such items shall be chargeable to the contractor except allowable wastage for packing wood only.
6.1.14	The contractor shall hand over all parts / materials remaining extra over the normal requirement with proper identification tags to the stores as directed by the concerned BHEL engineer.
6.1.15	The contractor shall ensure that all the packing materials and protective devices installed on equipment during transit and storage are removed before installation.
6.1.16	It shall be the responsibility of the contractor to keep the work / storage areas in neat, tidy and working conditions. All surplus/unusable packing and other materials shall be removed and deposited at location(s) specified by BHEL within the project premises. If required weighing of the same within the project premises will have to be carried out.
6.2	PRESERVATION OF COMPONENTS
6.2.1	After taking delivery from BHEL / customer's stores, plant materials storage shall be subjected to the following protection besides other provisions indicated in these specifications elsewhere.
6.2.1.1	Items stored outdoors shall be stacked up at least six inches (6") off the ground. Items should not be stored in a low-lying area where water logging is a possibility. Contractor should have sufficient numbers of wooden / concrete / steel sleepers for the job.
6.2.1.2	Motors, valves, electrical equipment, control equipment and instruments etc. shall be stored indoors in warehouse safe keeping, watch and ward at site.

SPECIAL CONDITIONS OF CONTRACT (SCC)-Electrical and C&I

Chapter - VI : Material Handling, Storage & Preservation

6.2.2	It shall be the responsibility of the contractor to apply preservatives / touch up paints (primer) on equipment handled and erected by him till such time of final painting. It shall be contractor's responsibility to arrange for required paints (primer), thinners, labour, scaffolding materials, cleaning materials like wire brush, emery sheets, etc. cleaning of surface and provide one coat of preservatives / paints (primer) from time to time as decided by BHEL engineer. The accepted rate shall include this work also. It is to be noted that such painting may have to be done as and when required till such time the final painting is carried out, as prescribed in technical conditions of contract.
6.2.3	The contractor shall effectively protect the finished work from action of weather and from damage or defacement and shall cover the finished parts then and there for their protection.
6.2.4	Any failure on the part of contractor to carry out works according to above clauses will entail BHEL to carry out the job from any other party and recover the cost from contractor.
6.2.5	The loose items supplied for the main equipment falls into various categories like tools, modules, prefabricated cables, console inserts, recorders, modules and display units, printers, sensors and transducers, PCs, monitors, cable glands, cable ducts, frames etc. are to be categorized and stored separately.

SPECIAL CONDITIONS OF CONTRACT (SCC)-Electrical and C&I
Chapter - VII : Drawings and Documents

7.0	DRAWINGS AND DOCUMENTS
7.1	The detailed drawings/revised drawings / documents, specifications available with BHEL engineers will be made available to the contractor during execution of work at site. The contractor will also ensure availability of all drawings / documents at work place. Contractor to ensure that hard/soft copies of the drawings not be forwarded and transmitted in any form detrimental to the interest of BHEL.
7.2	Necessary drawings to carry out the erection work will be furnished to the contractor by BHEL on loan, which shall be returned to BHEL Engineer at site after completion of work. Contractor shall ensure safe storage and quick retrieval of these documents.
7.3	The contractor shall maintain a record of all drawings and documents available with him in a register as per format given by BHEL Engineer. Contractor shall ensure use of pertinent drawings / data / documents and removal of obsolete ones from work place and returning to BHEL.
7.4	The data furnished in various annexure enclosed with this tender specification are only approximate and for guidance. However, the change in the design and in the quantity may occur as is usual in any such large scale of work. The contractors quoted rates shall be inclusive of the above factor.
7.5	Should any error or ambiguity be discovered in the specification or information the contractor shall forthwith bring the same to the notice of BHEL before commencement of work. BHEL's interpretation in such cases shall be final and binding on the contractor.
7.6	Deviation from design dimensions should not exceed permissible limit. The contractor shall not correct or alter any dimension / details, without specific approval of BHEL.

SPECIAL CONDITIONS OF CONTRACT (SCC)-Electrical and C&I
Chapter - VIII : Inspection and Quality

8.0	INSPECTION AND QUALITY
8.1	Inspection, Quality Assurance, Quality Control
8.1.1	Preparation of quality assurance log sheets and protocols with customer / consultants / statutory authority, welding logs, NDE records, testing & calibration records and other quality control and quality assurance documentation as per BHEL engineer's instructions, is within the scope of work / specification. These records shall be submitted to BHEL / customer for approval from time to time.
8.1.2	The protocols between contractor and customer / BHEL shall be made prior to installation for correctness of foundations, materials, procedures, at each stage of installation, generally as per the requirement of customer / BHEL. This is necessary to ensure elimination of errors or keeping them within tolerable limits and to avoid accumulation and multiplication of errors.
8.1.3	A daily log book should be maintained by every supervisor / engineer of contractor on the job in duplicate (one for BHEL and one for contractor) for detailing and incorporating alignment/clearance / centering / leveling readings and inspection details of various equipments etc. Welding details like serial number of weld joints, welders name, date of welding, details of repair etc. will be documented in welding log as per BHEL Engineer's instructions. Record of heat treatments performed shall be maintained as prescribed by BHEL.
8.1.4	The performance of welders will be reviewed from time to time as per the BHEL standards. Welders' performance record shall be furnished periodically furnished for scrutiny of BHEL's Engineer. Corrective action as informed by BHEL shall be taken in respect of those welders not conforming to these standards. This may include removal/ discontinuance of concerned welder(s). Contractor shall arrange for the alternate welders immediately
8.1.5	All the welders shall carry identity cards as per the Proforma prescribed by BHEL / Customer / Consultant. Only welders duly authorized by BHEL / customer / consultant shall be engaged on the work.
8.1.6	Any re-laying or re-termination of cables / re-erection of instruments / recalibration of instruments etc. required due to contractor's mistake/negligence found at any stage inspection, shall be carried out by the contractor at no extra cost.

SPECIAL CONDITIONS OF CONTRACT (SCC)-Electrical and C&I
Chapter - VIII : Inspection and Quality

8.1.7	BHEL, Power Sector Regions (PSNR / PSER / PSWR / PSSR) have already been accredited with ISO 9001 certification and as such this work is subject to various audits to meet ISO 9001 requirements. One particular aspect which needs special mention is about arrangement of calibration of instruments by the contractor. Contractor shall ensure deployment of reliable and calibrated MMEs (Measuring and Monitoring Equipments). The MMEs shall have test / calibration certificates from authorized / Government approved / Accredited agencies traceable to National / International Standards. Re-testing / re-calibration shall also be arranged at regular intervals during the period of use as advised by BHEL Engineer within the contract price. The contractor will also have alternate arrangements for such MMEs so that work does not suffer when the particular equipment / instrument is sent for calibration. Also, if any MMEs not found fit for use, BHEL shall have the right to stop the use of such item and instruct the contractor to deploy proper item and recall i.e. repeat the readings taken by that instrument, failing which BHEL may deploy MME and retake the readings at Contractor's cost.
8.1.8	Re-work necessitated on account of use of invalid MMEs shall be entirely to the contractor's account. He shall be responsible to take all corrective actions, including resource augmentation if any, as specified by BHEL to make-up for the loss of time.
8.1.9	In the courses of erection, it may become necessary to carry repeated checks of the work with instruments recently calibrated, re-calibrated. BHEL may counter / finally check the measurements with their own MMEs. Contractor shall render all assistance in conduct of such counter / final measurements.
8.1.10	Total Quality is the watchword of the work and Contractor shall strive to achieve the Quality Standards, procedures laid down by BHEL. He shall follow all the instructions as per BHEL drawings and Quality Standards.
8.2	Stage Inspection by FES / QA Engineers
8.2.1	Apart from day-to-day inspection by BHEL Engineers stationed at Site and Customer's Engineers, stage inspection of equipments under erection and commissioning at various stages shall also be conducted by teams of Engineers from Field Engineering Services of BHEL's Manufacturing Units, Quality Assurance teams from Field Quality Assurance, Unit/Factory Quality Assurance and Commissioning Engineers from Technical Services etc. Contractor shall arrange all labour, tools and tackles etc. along with proper access for such stage inspections free of cost.

SPECIAL CONDITIONS OF CONTRACT (SCC)-Electrical and C&I
Chapter - VIII : Inspection and Quality

8.2.2	Any modifications suggested by BHEL FES and QA Engineers' team shall be carried out. Claims of contractor, if any, shall be dealt as per Section 13, and provided such modifications have not arisen for reasons attributable to the contractor.
8.3	Statutory Inspection of Work
8.3.1	<p>The work to be executed under these specifications has to be offered for inspection, at appropriate stages of work completion, to various statutory authorities for compliance with applicable regulations.</p> <p>The work-related statutory inspections, though not limited to, are as under:</p> <ol style="list-style-type: none">1. Electrical Inspector2. Factory Inspector, Labour Commissioner, PF Commissioner and other authority connected to this project work <p>The scope includes getting the approvals from the statutory authorities, which includes arranging for inspection visits of statutory authority periodically as per BHEL Engineer's instructions, arranging materials for ground inspection, taking rub outs for the pressure parts to be offered for inspection, submitting co-related inspection reports, documents, radiographs etc. and following up the matter with them. Contractor shall also make all arrangements for offering the Products / Systems for inspection at location, as applicable, to the concerned authority.</p>
8.4	<p>The Quality Management System of BHEL, Power Sector Regions (PSNR / PSER / PSWR / PSSR) have already been certified and accredited under ISO 9002 standards in this regard. The basic philosophy of the Quality Management System is to define the organizational responsibility, work as per documented procedures, verify the output with respect to acceptance norms, identify the non-conforming product / procedure and take corrective action for removal of non-conformance specifying the steps for avoiding recurrence of such non-conformities, & maintain the relevant quality records. The non-conformities are to be identified through the conduct of periodical audit of implementation of quality systems at various locations/stages of work. Suppliers / vendors of various products / services contributing in the work are also considered as part of the quality management system. .as such the contractor is expected not only to conform to the quality management system of BHEL but also it is desirable that they themselves are accredited under any quality management system standard.</p>

SPECIAL CONDITIONS OF CONTRACT (SCC)-Electrical and C&I
Chapter - VIII : Inspection and Quality

8.5	Field Quality Assurance
8.5.1	Contractor shall carry out all activities conforming to the approved Field Quality Plan (FQP) as revised from time to time. Total quality shall be the watchword of the work and contractor shall strive to achieve the quality standards, procedures laid down by BHEL. He shall follow all the instructions as per BHEL drawings and quality standards. Contractor shall provide the services of quality assurance engineer as per the relevant clauses.

SPECIAL CONDITIONS OF CONTRACT (SCC)-Electrical and C&I
Chapter - IX : Health, Safety & Environment Obligations

9.0	OCCUPATIONAL HEALTH, SAFETY & ENVIRONMENT MANAGEMENT / QUALITY ASSURANCE PROGRAMME: BHEL, Power Sector Regions (PSNR / ER / WR / SR) are each certified for ISO 9001. Quality of work to customer's satisfaction and fulfillment of system requirements are the essence of ISO 9001 certification. BHEL, PS Regions have HSE certification (ISO 14001:2015 & ISO 45001:2018) and therefore Contractor also shall organize / plan/ perform all their activities to meet with the applicable requirements of these standards.
9.1	HSE (Health, safety & Environment): Contractor will comply with HSE (Health, Safety & Environment) requirements of BHEL as per the "HSE Plan for Site Operations by Subcontractor" (Document No. HSEP: 14 Rev02) or equivalent document issued by BHEL PS Regions along with tender. In case of any ambiguity between these two documents, document issued by PS-Region will be followed.

SPECIAL CONDITIONS OF CONTRACT (SCC)-Electrical and C&I
Chapter - X : RA Bill Payment

10.0	RA Bill Payments
10.1	The contractor shall submit his monthly RA bills with all the details required by BHEL on specified date every month covering progress of work in all respects and areas for the previous calendar month.
10.2	Mode of payment and measurement of work completed shall be as per relevant clauses of General Conditions of Contract
10.3	Release of payment in each running bill including PVC Bills where ever applicable will be admitted as per stages of progressive pro rata payments.
10.4	VOID
10.5	<p>The payment for running bills will normally be released within 30 days of submission of running bill complete in all respects with all documents. It is the responsibility of the contractor to make his own arrangements for making timely payments towards labour wages, statutory payments, outstanding dues etc. and other dues in the meanwhile.</p> <p>60% of RA Bills complete and correct in all respects and certified by BHEL Engineer, shall be paid within 15 days of receipt. Balance payment shall be within 30 days.</p>
10.6	<p>BHEL shall release payment through Electronic Fund Transfer (EFT)/RTGS. In order to implement this system, Contractor to furnish details pertaining to his Bank Accounts where proceeds will be transferred through BHEL's banker, as per prescribed formats:</p> <p>Note: BHEL may also choose to release payment by other alternative modes as applicable</p>
10.7	Paying Authority shall be the Construction Manager of the Site. Any change in the paying Authority shall be intimated to the Contactor accordingly.

General Conditions of Contract

(Common for Power Sector Regions)

2021

TABLE OF CONTENTS

1. **Chapter-1**: General Instructions to Tenderers
 - 1.1. Despatch Instructions
 - 1.2. Submission of Tenders
 - 1.3. Language
 - 1.4. Price Discrepancy
 - 1.5. Qualification of Tenderers
 - 1.6. Evaluation of Bids
 - 1.7. Data to be enclosed
 - 1.8. Authorization and Attestation
 - 1.9. Earnest Money Deposit
 - 1.10. Security Deposit
 - 1.11. Return of Security Deposit
 - 1.12. Bank Guarantee
 - 1.13. Validity of offer
 - 1.14. Execution of Contract Agreement
 - 1.15. Rejection of Tender and other Conditions
 - 1.16. Intimation of change of name/re-constitution of the Organization
2. **Chapter-2**
 - 2.1. Definitions
 - 2.2. Law Governing Contract and Court Jurisdiction
 - 2.3. Issue of Notice
 - 2.4. Use of Land
 - 2.5. Commencement of Work
 - 2.6. Measurement of Work and Mode of Payment
 - 2.7. Rights of BHEL

- 2.8. Responsibilities of Contractor in respect of Local Laws, Employment of Workers etc
- 2.9. Execution Plan, Progress Monitoring, Monthly Review and Performance Evaluation
- 2.10. Time of Completion
- 2.11. Extension of Time for Completion
- 2.12. Over Run Compensation
- 2.13. Secured Recoverable Advances
- 2.14. Quantity Variation
- 2.15. Extra Works
- 2.16. Supplementary Items
- 2.17. Price Variation Compensation
- 2.18. Insurance
- 2.19. Strikes & Lockout
- 2.20. Force Majeure
- 2.21. Arbitration and Conciliation
- 2.22. Retention Amount
- 2.23. Payments
- 2.24. Performance Guarantee for Workmanship
- 2.25. Closing of Contracts
- 2.26. Suspension of Business Dealings
- 2.27. Limitation on Liability
- 2.28. Other Issues

CHAPTER -1

1. GENERAL INSTRUCTION TO TENDERERS

1.1. DESPATCH INSTRUCTION

- i) The General Conditions of Contract form part of the Tender specifications. **All pages of the tender documents shall be duly signed, stamped and submitted along with the offer in token of complete acceptance thereof. (For E-Tender, bidders shall use electronic Signature viz Digital Signature Certificate while uploading on the e-procurement portal.** The information furnished shall be complete by itself. The tenderer is required to furnish all the details and other documents as required in the following pages.
- ii) Tenderers are advised to study all the tender documents carefully. Any submission of tender by the tenderer shall be deemed to have been done after careful study and examination of the tender documents and with the full understanding of the implications thereof. Should the tenderers have any doubt about the meaning of any portion of the Tender Specification or find discrepancies or omissions in the drawings or the tender documents issued are incomplete or shall require clarification on any of the technical aspect, the scope of work etc., he shall at once, contact the authority inviting the tender well in time (so as not to affect last date of submission) for clarification before the submission of the tender. Tenderer's request for clarifications shall be with reference to Sections and Clause numbers given in the tender documents. The specifications and terms and conditions shall be deemed to have been accepted by the tenderer in his offer. Non-compliance with any of the requirements and instructions of the tender enquiry may result in the rejection of the tender.
- iii) Integrity pact (IP) shall be applicable for all tenders / contracts if indicated in NIT. This integrity pact shall be issued as part of the Tender documents and shall be submitted by the bidder along with Techno-commercial bid duly filled, signed and stamped by the authorized signatory who signs the bid. Only those vendors / bidders who have entered into such an IP with BHEL shall be considered qualified to participate in the bidding. Entering into this pact shall be a preliminary qualification.

1.2. SUBMISSION OF TENDERS

- 1.2.1 The tenderers must submit their tenders to Officer inviting tender as per instructions in the NIT.
- 1.2.2 Tenders submitted by post (i.e. by 'REGISTERED POST / by COURIER') shall be sent with due allowance for any postal/courier delays. BHEL takes no responsibility for delay, loss or non-receipt of tenders sent by post/courier. **The tenders received after the specified time of their submission are treated as 'Late Tenders' and shall not be considered under any circumstances.** Offers received by Email shall be considered as per terms of NIT. E-Tenders shall be submitted through E-Procurement portal as per instruction in NIT. Tenderers to upload offers well in advance in order to avoid last minute congestion in e-procurement website. However, after submission of the tender, the tenderer can re-submit revised tender but before due date and time of submission of tender as notified.
- 1.2.3 Tenders shall be opened by Officer of BHEL at the time and date as specified in the NIT, in the presence of such of those tenderers or their authorized representatives who would like to be present (In case of Manual Tenders). BHEL reserves the right to go ahead with opening of the

Tender even in case of no representative is present on the specified date and time. For e-tenders, bidders may mark their presence online through provisions available in e-procurement portal.

- 1.2.4 Tenderers whose bids are found techno commercially qualified shall be informed about the date and time of opening of the Price Bids and such Tenderers may depute their representatives to witness the opening of the price bids (In case of Manual Tenders). BHEL's decision in this regard shall be final and binding.
- 1.2.5 Before submission of Offer, the tenderers are advised to inspect the site of work and the environments and be well acquainted with the actual working and other prevalent conditions, facilities available, position of material and labour, means of transport and access to Site, accommodation etc. No claim will be entertained later on the grounds of lack of knowledge of any of these conditions.

The tenderer may get aware about weather conditions, contingencies & other circumstances which may influence or affect their tender prices. Invariable of inspection by the tenderer, the tenderer shall be considered deemed acquainted with all site conditions such as rain patterns, hazardous conditions, soil patterns, local factors etc. Tenderer to have satisfied himself in all respect before quoting his rates and no claim will be entertained later on the grounds of lack of knowledge of any of these conditions.

1.3. **LANGUAGE**

- 1.3.1 The tenderer shall quote the rates in English language and international numerals. These rates shall be entered in figures as well as in words. Tenderers are requested to refer the clauses of NIT/ Vol-II "Price Bid" for more details. For the purpose of the tenders, the metric system of units shall be used.
- 1.3.2 All entries in the tender shall either be typed or written legibly in ink. Erasing and over-writing is not permitted and may render such tenders liable for rejection. All cancellations and insertions shall be duly attested by the tenderer.

1.4 **PRICE DISCREPANCY:**

- 1.4.1 **Price Bid opening:** During opening of price bids (submitted through conventional method or through E-Procurement system), if there is any difference between the amount in figures and in words, the amount quoted by the bidder in words shall be taken as correct.
- 1.4.2 **Reverse Auction:** In case of Reverse Auction, the successful bidder shall undertake to execute the work as per overall price offered by him during the Reverse Auction process. (Guidelines as available on www.bhel.com on "**supplier registration page**").

1.5 **QUALIFICATION OF TENDERERS**

- i) Only tenderers who have previous experience in the work of the nature and description detailed in the Notice Inviting Tender and/or tender specification are expected to quote for this work duly detailing their experience along with offer.
- ii) Offers from tenderers who do not have proven and established experience in the field shall not be considered.
- iii) The offers of the bidders who are on the banned/ hold list and also the offer of the bidders, who engage the services of the banned/ hold firms, shall be rejected. The list of **banned/ hold firms** is available on BHEL web site www.bhel.com. (Refer clause 28.0 of NIT)
- iv) Offers from tenderers who do not comply with the latest guidelines of Ministry/Commissions of Govt. of India shall not be considered.

1.6. EVALUATION OF BIDS

- i) Technical Bids submitted by the tenderer will be opened first and evaluated for fulfilling the Pre-Qualification criteria and other conditions in NIT/Tender documents, based on documentary evidences submitted along with the offer
- ii) In case the same qualifying experience is claimed by more than one agency, then:
 - a. The agency who has executed the work as per documentary evidence submitted shall only be qualified. Scope of qualifying work should be totally with the agency who has executed and in case it is only labour and consumables without T&P, then the credentials of execution is assigned to the first agency and not to the agency who has executed only as labour supply contractor. Further, BHEL reserves the right to ask for any other proof for the said job.
 - b. However, if the same is on account of subletting part of scope by one agency to another agency in a project of BHEL, experience of both the agencies may be considered for the sublet portion of the work provided subletting has been done with the approval of BHEL.
- iii) In case the qualifying experience is claimed by private organizations (sub-agency) based on 'Work Order' and 'Experience Certificates' from a non-BHEL organization (main agency), then it shall be the responsibility of sub-agency to submit (in addition to the experience certificate from main agency) relevant certificate regarding qualifying experience from the end Customer or the Turnkey-Contractor (if any) who has awarded the work to main agency, as a proof for having executed subject qualifying work. BHEL reserves the right to ask for any other proof for the said job.
- iv) Assessing Bidder's Capacity for executing the current tender shall be as per Notice Inviting Tender.
- v) Price Bids of shortlisted bidders shall only be opened either through the conventional/electronic price bid opening with/without Reverse Auction, at the discretion of BHEL. Unless specified otherwise in the tender, the L1 bidder amongst all the shortlisted bidders shall be considered for award. However, the L1 bidder shall have no claim on the award & BHEL reserves the right to award the tender at its sole discretion.
- vi) Price Bids of unqualified bidders shall not be opened. Reasons for rejection shall be intimated in due course after issue of LOI/LOA to successful bidder either through system generated e-mail or through letter/e-mail.
- vii) Bidders are advised to also refer to clause no 2.9.4 regarding evaluation of their performance in ongoing projects for the current tender.

1.7. DATA TO BE ENCLOSED

Full information shall be given by the tenderer in respect of the following. Non-submission of this information may lead to rejection of the offer.

- i) **INCOME TAX PERMANENT ACCOUNT NUMBER**
Certified copies of Permanent Account Numbers as allotted by Income Tax Department for the Company/Firm/Individual Partners etc. shall be furnished along with tender.
- ii) **ORGANIZATION CHART**
The organization chart of the tenderer's organization, including the names, addresses and contact information of the Directors/Partners shall be furnished along with the offer.
- iii) An attested copy of the Power of Attorney, in case the tender is signed by an individual other than the sole proprietor.
- iv) **IN CASE OF INDIVIDUAL TENDERER:**
His / her full name, address, PAN and place & nature of business.
- v) **IN CASE OF PARTNERSHIP FIRM:**
The names of all the partners and their addresses, A copy of the partnership deed/instrument of partnership duly certified by the Notary Public shall be enclosed.
- vi) **IN CASE OF COMPANIES:**
 - a) Date and place of registration including date of commencement certificate in case of Public

- Companies (certified copies of Memorandum and articles of Association are also to be furnished).
- b) Nature of business carried on by the Company and the provisions of the Memorandum relating thereof.

1.8 AUTHORIZATION AND ATTESTATION

Tenders shall be signed by a person duly authorized/empowered to do so, for which a Power of Attorney is to be submitted along with the tender offer. For company, a Power of Attorney (as per format in Volume-I D) shall be submitted.

1.9 EARNEST MONEY DEPOSIT

- 1.9.1 Every tender must be accompanied by the prescribed amount of Earnest Money Deposit (EMD) in the manner described herein.
- i) EMD shall be furnished before tender opening / along with the offer in full as per the amount indicated in the NIT.
- ii) The EMD is to be paid only in the following forms:
- a) Cash deposit as permissible under the extant Income Tax Act (before tender opening).
- b) Electronic Fund Transfer credited in BHEL account (before tender opening).
- c) Banker's cheque / Pay order / Demand draft, in favour of 'Bharat Heavy Electricals Limited' and payable at Regional HQ issuing the tender (along with offer).
- d) Fixed Deposit Receipt (FDR) issued by Scheduled Banks/ Public Financial Institutions as defined in the Companies Act (FDR should be in the name of the Contractor, a/c BHEL) (along with offer). The Fixed Deposit in such cases shall be valid for at least six months from the due date of tender submission.
- e) **Insurance Surety Bonds**
- In case EMD amount is more than Rs. Two Lakhs, Tenderer has the option to submit Rs. Two lakhs in the forms described above in clause no. 1.9.1. (a) to (d) and the remaining amount over and above Rs. Two Lakhs in the form of Bank Guarantee from Scheduled Bank (along with the Offer). The Bank Guarantee in such cases shall be valid for at least six months from the due date of tender submission. The Bank Guarantee format for EMD shall be in the prescribed formats.
- iii) No other form of EMD remittance shall be acceptable to BHEL.
- 1.9.2 EMD by the Tenderer will be forfeited as per NIT conditions, if:
- i) After opening the tender and within the offer validity period, the tenderer revokes his tender or makes any modification in his tender which is not acceptable to BHEL.
- ii) The Contractor fails to deposit the required Security deposit or commence the work within the period as per LOI/ LOA/ Contract.
EMD by the tenderer shall be withheld in case any action on the tenderer is envisaged under the provisions of extant "Guidelines on Suspension of business dealings with suppliers/ contractors" and forfeited/ released based on the action as determined under these guidelines.
- 1.9.3 EMD shall not carry any interest.
- 1.9.4 EMD given by all unsuccessful tenderers shall be refunded normally within fifteen days of award of work.
- 1.9.5 Cash portion of EMD of successful tenderer will be retained as part of Security Deposit. EMD submitted in the form of Bank Guarantee/ FDR shall be retained by BHEL until the receipt of the Security Deposit.

1.10 SECURITY DEPOSIT (5% of the Contract Value)

1.10.1 Upon acceptance of Tender, the successful Tenderer should deposit the required amount of Security Deposit towards fulfilment of any obligations in terms of the provisions of the contract. The total amount of Security Deposit will be 5% of the contract value.

1.10.2 The security Deposit should be furnished before start of the work by the contractor.

Note: In case of small value contracts not exceeding Rs. 20 lakhs, work can be started before the required Security Deposit is collected. However, payment can be released only after collection/ recovery of Security Deposit.

1.10.3 The balance amount to make up the required Security Deposit of 5% of the contract value may be accepted in the following forms.

- i) Cash (as permissible under the extant Income Tax Act).
- ii) Local cheques of Scheduled Banks (subject to realization)/ Pay Order/ Demand Draft/ Electronic Fund Transfer in favour of BHEL.
- iii) Securities available from Indian Post offices such as National Savings Certificates, Kisan Vikas Patras etc. (held in the name of Contractor furnishing the security and duly endorsed/ hypothecated/ pledged, as applicable, in favour of BHEL).
- iv) Bank Guarantee from Scheduled Banks/ Public Financial Institutions as defined in the Companies Act. The Bank Guarantee format for Security Deposit shall be in the prescribed formats.
- v) Fixed Deposit Receipt issued by Scheduled Banks/ Public Financial Institutions as defined in the Companies Act (FDR should be in the name of the Contractor, a/c BHEL).
- vi) **Insurance Surety Bonds**

Note:

1) BHEL will not be liable or responsible in any manner for the collection of interest or renewal of the documents or in any other matter connected therewith.

2) **In case of delay in submission of security deposit, enhanced security deposit which would include interest (Repo rate +4%) for the delayed period, shall be submitted by the bidder.**

1.10.4 The Security Deposit shall not carry any interest.

1.10.5 In case the value of work exceeds the awarded / accepted value, the Security Deposit shall be correspondingly enhanced as given below:

- i) The enhanced part of the Security Deposit shall be immediately deposited by the Contractor or adjusted against payments due to the Contractor.
- ii) Contract value for the purpose of operating the increased value of Security Deposit due to Quantity Variation, shall be exclusive of Price Variation Clause, Over Run Compensation and Extra works done on manday rates.
- iii) The recoveries made from running bills (cash deduction towards balance SD amount) can be released against submission of equivalent Bank Guarantee in acceptable form, but only once, before completion of work, with the approval of competent authority of BHEL.

1.10.6 The validity of Bank Guarantees towards Security Deposit shall be initially up to the completion period as stipulated in the Letter of Intent/ Award + Guarantee Period + 3 months, and the same

shall be kept valid by proper renewal by the contractor till the acceptance of Final Bills of the Contractor by BHEL.

- 1.10.7 BHEL reserves the right of forfeiture of Security Deposit in addition to other claims and penalties in the event of the Contractor's failure to fulfill any of the contractual obligations or in the event of termination of contract as per terms and conditions of contract. BHEL reserves the right to set off the Security Deposit against any claims of other contracts with BHEL.

1.11 RETURN OF SECURITY DEPOSIT

Security Deposit shall be released to the contractor upon fulfillment of contractual obligations as per terms of the contract including completion of Guarantee Period after deducting all expenses / other amounts due to BHEL under the contract / other contracts entered into with them by BHEL.

1.12 BANK GUARANTEES

Where ever Bank Guarantees are to be furnished/submitted by the contractor, the following shall be complied with

- i) Bank Guarantees shall be from Scheduled Banks / Public Financial Institutions as defined in the Companies Act. Bank Guarantees issued by Co-Operative Banks/ Financial Institutions shall not be accepted.
- ii) The Bank Guarantees shall be as per prescribed formats.
- iii) It is the responsibility of the bidder to get the Bank Guarantees revalidated/extended for the required period as per the advice of BHEL Site Engineer / Construction Manager. BHEL shall not be liable for issue of any reminders regarding expiry of the Bank Guarantees.
- iv) In case extension/further extensions of any Bank Guarantees are not required, the bidders shall ensure that the same is explicitly endorsed by the Construction Manager and submitted to the Regional HQ issuing the LOI/LOA.
- v) In case the Bank Guarantees are not extended before the expiry date, BHEL reserves the right to invoke the same by informing the concerned Bank in writing, without any advance notice/communication to the concerned bidder.
- vi) Bidders to note that any corrections to Bank Guarantees shall be done by the issuing Bank, only through an amendment in an appropriate non judicial stamp paper.
- vii) The Original Bank Guarantee shall be submitted to Subcontracting Department of the respective Region of BHEL.

1.13 VALIDITY OF OFFER

The rates in the Tender shall be kept open for acceptance for a minimum period of **SIX MONTHS** from latest due date of offer submission (including extension, if any). In case BHEL (Bharat Heavy Electricals Ltd) calls for negotiations, such negotiations shall not amount to cancellation or withdrawal of the original offer which shall be binding on the tenderers.

1.14 EXECUTION OF CONTRACT AGREEMENT

The successful tenderer's responsibility under this contract commences from the date of issue of the Letter of Intent/ Award by Bharat Heavy Electricals Limited.

The successful tenderer shall be required to execute an agreement in the prescribed form, with BHEL, within a reasonable time after the acceptance of the Letter of Intent/Award, and in any case before releasing the first running bill. The contract agreement shall be signed by a person duly authorized/empowered by the tenderer. The expenses for preparation of agreement document shall be borne by BHEL.

1.15 REJECTION OF TENDER AND OTHER CONDITIONS

- 1.15.1 The acceptance of tender will rest with BHEL which does not bind itself to accept the lowest tender or any tender and reserves to itself full rights for the following without assigning any reasons whatsoever: -
- a. To reject any or all of the tenders.
 - b. To split up the work amongst two or more tenderers as per NIT.
 - c. To award the work in part if specified in NIT.
 - d. In case of either of the contingencies stated in (b) and (c) above, the time for completion as stipulated in the tender shall be applicable.
- 1.15.2 Conditional tenders, unsolicited tenders, tenders which are incomplete or not in the form specified or defective or have been materially altered or not in accordance with the tender conditions, specifications etc. are liable to be rejected.
- 1.15.3 Tenders are liable to be rejected in case of unsatisfactory performance of the tenderer with BHEL or tenderer under suspension (hold/banning) by any unit / region / division of BHEL or tenderers who do not comply with the latest guidelines of Ministry/Commissions of Govt of India. BHEL reserves the right to not consider a bidder for further processing of tender in case it is observed that they are overloaded and may not be in a position to execute this job as per the required schedule in line with clause no. 9.0 of the 'NIT'. The decision of BHEL will be final in this regard.
- 1.15.4 If a tenderer who is a proprietor expires after the submission of his tender or after the acceptance of his tender, BHEL may at their discretion, cancel such tender. If a partner of a firm expires after the submission of tender or after the acceptance of the tender, BHEL may then cancel such tender at their discretion, unless the firm retains its character.
- 1.15.5 BHEL will not be bound by any Power of Attorney granted by changes in the composition of the firm made subsequent to the execution of the contract. BHEL may, however, recognize such power of Attorney and changes after obtaining proper legal advice, the cost of which will be chargeable to the contractor concerned.
- 1.15.6 If the tenderer deliberately gives wrong information in his tender, BHEL reserves the right to reject such tender at any stage or to cancel the contract if awarded and forfeit the Earnest Money/Security Deposit/any other money due.
- 1.15.7 Canvassing in any form in connection with the tenders submitted by the Tenderer shall make his offer liable to rejection.
- 1.15.8 In case the Proprietor, Partner or Director of the Company/Firm submitting the Tender, has any relative or relation employed in BHEL, the authority inviting the Tender shall be informed of the fact as per specified format, along with the Offer. Failing to do so, BHEL may, at its sole discretion, reject the tender or cancel the contract and forfeit the Earnest Money/Security Deposit.
- 1.15.9 [The successful tenderer \(Contractor\) should not sub-contract any portion of work detailed in the tender specification undertaken by him without prior written permission of BHEL's Construction Manager/ Site In-Charge. BHEL, at its discretion, may consider the written request from the Contractor and permit subletting of part scope. However, the Contractor is solely responsible to BHEL for the work awarded to him.](#)

1.15.10 The Tender submitted by a techno commercially qualified tenderer shall become the property of BHEL who shall be under no obligation to return the same to the bidder. However unopened price bids and late tenders shall be returned to the bidders, in case of Conventional/ Paper bid.

1.15.11 Unsolicited discount received after the due date and time of Bid Submission shall not be considered for evaluation. However, if the party who has submitted the unsolicited discount/rebate becomes the L-1 party, then the awarded price i.e. contract value shall be worked out after considering the discount so offered.

1.15.12 BHEL shall not be liable for any expenses incurred by the bidder in the preparation of the tender irrespective of whether the tender is accepted or not.

1.16 INTIMATION OF CHANGE OF NAME/RE-CONSTITUTION OF THE ORGANIZATION

In the event of the organization (Proprietorship/Partnership/Company) undergoing any change of name or reconstitution, prior intimation of the same shall be given to BHEL. Upon such changes coming into effect, the same is to be intimated to BHEL immediately with supporting documents as applicable.

Further, the new entity has to intimate BHEL in writing that they will honor all the earlier commitments in respect of the subject contract.

CHAPTER-2

2.1 **DEFINITION:** The following terms shall have the meaning hereby assigned to them except where the context otherwise requires

- i) BHEL shall mean Bharat Heavy Electricals Limited (of the respective Power Sector Region inviting the Tender), a company registered under Indian Companies Act 1956, with its Registered Office at BHEL HOUSE, SIRI FORT, NEW DELHI – 110 049, or its Power Sector Regional Offices or its Authorized Officers or its Site Engineers or other employees authorized to deal with any matters with which these persons are concerned on its behalf.
- ii) “EXECUTIVE DIRECTOR” or “GENERAL MANAGER (In- charge)” or “GENERAL MANAGER” shall mean the Officer in Administrative charge of the respective Power Sector Region.
- iii) “COMPETENT AUTHORITY” shall mean BHEL Officers who are empowered to act on behalf of BHEL.
- iv) “ENGINEER” or “ENGINEER IN CHARGE” shall mean an Officer of BHEL as may be duly appointed and authorized by BHEL to act as “Engineer” on his behalf for the purpose of the Contract, to perform the duty set forth in this General Conditions of Contract and other Contract documents. The term also includes ‘CONSTRUCTION MANAGER’ or ‘SITE INCHARGE’ as well as Officers at Site or at the Headquarters of the respective Power Sector Regions.
- v) “SITE” shall mean the places or place at which the plants/equipments are to be erected and services are to be performed as per the specification of this Tender.
- vi) “CLIENT OF BHEL” or “CUSTOMER” shall mean the project authorities with whom BHEL has entered into a contract for supply of equipments or provision of services.
- vii) “CONTRACTOR” shall mean the successful Bidder/Tenderer who is awarded the Contract and shall include the Contractor’s successors, heirs, executors, administrators and permitted assigns.
- viii) “CONTRACT” or “CONTRACT DOCUMENT” shall mean and include the Agreement of Work Order, the accepted appendices of Rates, Schedules, Quantities if any, Offer submitted by contractor including acceptance to General Conditions of Contract, Special Conditions of Contract, Instructions to the Tenderers, Drawings, Technical Specifications, the Special Specifications if any, the Tender documents, subsequent amendments /corrigendum to Tender mutually agreed upon and the Letter of Intent/Award/Acceptance issued by BHEL. Any conditions or terms stipulated by the contractor in the tender documents or subsequent letters shall not form part of the contract unless, specifically accepted in writing by BHEL in the Letter of Intent/Award and incorporated in the agreement or amendment thereof.
- ix) “GENERAL CONDITIONS OF CONTRACT” shall mean the ‘Instructions to Tenderers’ and ‘General Conditions of Contract’ pertaining to the work for which above tenders have been called for.

x)	“TENDER SPECIFICATION” or “TENDER” or “TENDER DOCUMENTS” shall mean General Conditions, Common Conditions, Special Conditions, Price Bid, Rate Schedule, Technical Specifications, Appendices, Annexures, Corrigendums, Amendments, Forms, Procedures, Site information etc. and drawings/documents pertaining to the work for which the tenderers are required to submit their offers. Individual specification number will be assigned to each Tender Specification.
xi)	“LETTER OF INTENT/ AWARD” shall mean the intimation by a Letter/Fax/email to the tenderer that the tender has been accepted in accordance with provisions contained in the letter. The responsibility of the contractor commences from the date of issue of this letter and all terms and conditions of the contract are applicable from this date.
xii)	“COMPLETION TIME” shall mean the period by ‘date/month’ specified in the ‘Letter of Intent/Award’ or date mutually agreed upon for handing over of the intended scope of work, the erected equipment/plant which are found acceptable by the Engineer, being of required standard and conforming to the specifications of the Contract.
xiii)	“PLANT” shall mean and connote the entire assembly of the plant and equipments covered by the contract.
xiv)	“EQUIPMENT” shall mean equipment, machineries, materials, structural, electricals and other components of the plant covered by the contract.
xv)	“TESTS” shall mean and include such test or tests to be carried out on the part of the contractor as are prescribed in the contract or considered necessary by BHEL in order to ascertain the quality, workmanship, performance and efficiency of the contractor or part thereof.
xvi)	“APPROVED”, “DIRECTED” or “INSTRUCTED” shall mean approved, directed or instructed by BHEL.
xvii)	“WORK or CONTRACT WORK” shall mean and include supply of all categories of labour, specified consumables, tools and tackles and Plants required for complete and satisfactory site transportation, handling, stacking, storing, erecting, testing and commissioning of the equipments to the entire satisfaction of BHEL.
xviii)	“SINGULAR AND PLURALS ETC” words carrying singular number shall also include plural and vice versa, where the context so requires. Words imparting the masculine Gender shall be taken to include the feminine Gender and words imparting persons shall include any Company or Associations or Body of Individuals, whether incorporated or not.
xix)	“HEADING” – The heading in these General Conditions are solely for the purpose of facilitating reference and shall not be deemed to be part thereof or be taken as instructions thereof or of the contract.
xx)	“MONTH” shall mean calendar month unless otherwise specified in the Tender.
xxi)	‘Day’ or ‘Days’ unless herein otherwise expressly defined shall mean calendar day or days of twenty-four (24) hours each. A Week shall mean continuous period of seven (7) days.

xxii)	“COMMISSIONING” shall mean the synchronization testing and achieving functional operation of the Equipment with associated system after all initial adjustments, trials, cleaning, re-assembly required at site if any, have been completed and Equipment with associated system is ready for taking into service.
xxiii)	“WRITING” shall include any manuscript type written or hand written or printed statement or electronically transmitted messages, under the signature or seal or transmittal of BHEL.
xxiv)	“TEMPORARY WORK” shall mean all temporary works for every kind required in or for the execution, completion, maintenance of the work.
xxv)	‘CONTRACT PRICE’ or ‘CONTRACT VALUE’ shall mean the sum mentioned in the LOI/LOA/Contract Agreement subject to such additions thereto or deductions there from as may be made under provisions hereinafter contained.
xxvi)	‘EXECUTED CONTRACT VALUE’ shall mean actual value of works executed by the contractor and certified by BHEL. This value shall not include PVC, ORC, Extra Works and Taxes.
xxvii)	“COMMENCEMENT DATE” or “START DATE” shall mean the commencement/start of work at Site as per terms defined in the Tender.
xxviii)	“SHORT CLOSING” or “FORE CLOSING” of Contract shall mean the premature closing of Contract, for reasons not attributable to the contractor and mutually agreed between BHEL and the contractor.
xxix)	“TERMINATION” of Contract shall mean the pre mature closing of contract due to reasons as mentioned in the contract.
xxx)	“DE MOBILIZATION” shall mean the temporary winding up of Site establishment by Contractor leading to suspension of works temporarily for reasons not attributable to the contractor.
xxxi)	“RE MOBILIZATION” shall mean the resumption of work with all resources required for the work after demobilization.
2.2	LAW GOVERNING THE CONTRACT AND COURT JURISDICTION The contract shall be governed by the Law for the time being in force in the Republic of India. Subject to clause 2.21.1.1 of this contract, the Civil Court having original Civil Jurisdiction at Delhi for PSNR, at Kolkata for PSER, at Nagpur for PSWR and at Chennai for PSSR, shall alone have exclusive jurisdiction in regard to all matters in respect of the Contract.
2.3	ISSUE OF NOTICE
2.3.1	<u>Service of notice on Contractor</u> Any notice to be given to the Contractor under the terms of the contract shall be served by sending the same by Registered Post/Speed Post to or leaving the same at the Contractor’s last known address of the principal place of business (or in the event of the contractor being a company, to or at its Registered Office). In case of change of address, the notice shall be served at changed address as notified in writing by the Contractor to BHEL. Such posting or leaving of the notice shall be deemed to be good service of such notice and the time mentioned to the condition for doing any act after notice shall be reckoned from the date so mentioned in such notice.

2.3.2 Service of notice on BHEL

Any notice to be given to BHEL in-charge/Region under the terms of the Contract shall be served by sending the same by post to or leaving the same at BHEL address or changed address as notified in writing by BHEL to the Contractor.

2.4 USE OF LAND

No land belonging to BHEL or their Customer under temporary possession of BHEL shall be occupied by the contractor without written permission of BHEL.

2.5 COMMENCEMENT OF WORK

2.5.1 The contractor shall commence the work as per the time indicated in the Letter of Intent/Award from BHEL and shall proceed with the same with due expedition without delay.

2.5.2 If the contractor fails to start the work within stipulated time as per LOI/ LOA or as intimated by BHEL, then BHEL at its sole discretion will have the right to cancel the contract. The Earnest Money and/or Security Deposit with BHEL will stand forfeited without any further reference to him without prejudice to any and all of BHEL's other rights and remedies in this regard.

2.5.3 All the work shall be carried out under the direction and to the satisfaction of BHEL.

2.6 MEASUREMENT OF WORK AND MODE OF PAYMENT:

2.6.1 All payments due to the contractors shall be made by e mode only, unless otherwise found operationally difficult for reasons to be recorded in writing.

2.6.2 For progress running bill payments: - The Contractor shall present detailed measurement sheets in triplicate, duly indicating all relevant details based on technical documents and connected drawings for work done during the month/period under various categories in line with terms of payment as per contract. The basis of arriving at the quantities, weights shall be relevant documents and drawings released by BHEL. These measurement sheets shall be prepared jointly with BHEL Engineers and signed by both the parties.

2.6.3 These measurement sheets will be checked by BHEL Engineer and quantities and percentage eligible for payment under various groups shall be decided by BHEL Engineer. The abstract of quantities and percentage so arrived at based on the terms of payment shall be entered in Measurement Book and signed by both the parties.

2.6.4 Based on the above quantities, contractor shall prepare the bills, along with statutory documents, in prescribed format and work out the financial value. These will be entered in Measurement Book and signed by both the parties. Payment shall be made by BHEL after effecting the recoveries due from the contractor.

2.6.5 All recoveries due from the contractor for the month/period shall be effected in full from the corresponding running bills unless specific approval from the competent authorities is obtained to the contrary.

2.6.6 Measurement shall be restricted to that portion of work for which it is required to ascertain the financial liability of BHEL under this contract.

- 2.6.7** The measurement shall be taken jointly by persons duly authorized on the part of BHEL and by the Contractor.
- 2.6.8** The Contractor shall bear the expenditure involved if any, in making the measurements and testing of materials to be used/ used in the work. The contractor shall, without extra charges, provide all the assistance with appliances and other things necessary for measurement.
- 2.6.9** If at any time due to any reason whatsoever, it becomes necessary to re-measure the work done in full or in part, the expenses towards such re measurements shall be borne by the contractor unless such re measurements are warranted solely for reasons not attributable to contractor.
- 2.6.10** Passing of bills covered by such measurements does not amount to acceptance of the completion of the work measured. Any left out work has to be completed, if pointed out at a later date by BHEL.
- 2.6.11** Final measurement bill shall be prepared in the final bill format prescribed for the purpose based on the certificate issued by BHEL Engineer that entire works as stipulated in tender specification has been completed in all respects to the entire satisfaction of BHEL. Contractor shall give unqualified "No Claim" Certificate. All the tools and tackles loaned to him should be returned in satisfactory condition to BHEL. The abstract of final quantities and financial values shall also be entered in the Measurement Books and signed by both parties to the contract. The Final Bill shall be prepared and paid within a reasonable time after completion of work.
- 2.7 RIGHTS OF BHEL**
BHEL reserves the following rights in respect of this contract during the original contract period or its extensions if any, as per the provisions of the contract, without entitling the contractor for any compensation.
- 2.7.1** To withdraw any portion of work and/or to restrict/alter quantum of work as indicated in the contract during the progress of work and get it done through other agencies to suit BHEL's commitment to its customer or in case BHEL decides to advance the date of completion due to other emergent reasons/ BHEL's obligation to its customer.
In case of inadequate manpower deployed by the contractor, BHEL reserves the right to deploy additional manpower through any other agency for expediting activities in the interest of the project. Supplied manpower shall be put on job by the contractor and payments and other statutory compliances related to manpower shall be the contractor's responsibility. In case of contractor's failure to fulfill his obligations in respect of such manpower, BHEL reserves the right to take necessary action as per contract conditions.
- 2.7.2 Breach of Contract, Remedies and Termination**
- 2.7.2.1** BHEL shall terminate the contract after due notice of a period of 14 days' in any of the following cases, **which if not rectified/ improved within the time period mentioned in the notice, then, 'Breach of Contract' will be considered to have been established:**
- i. Contractor's poor progress of the work vis-à-vis execution timeline as stipulated in the Contract, backlog attributable to contractor including unexecuted portion of work does not appear to be executable within balance available period considering its performance of execution.
 - ii. Withdrawal from or abandonment of the work by contractor before completion of the work as per contract.
 - iii. Non-completion of work by the Contractor within scheduled completion period as per Contract or as

- extended from time to time, for the reasons attributable to the contractor.
- iv. Repeated failure of contractor in deploying the required resources, to comply the statutory requirements etc. even after given by BHEL in writing.
 - v. Strike or Lockout declared is not settled within a period of two weeks.
 - vi. Termination of Contract on account of any other reason (s) attributable to Contractor.
 - vii. Assignment, transfer, subletting of Contract without BHEL's written permission.
 - viii. Non-compliance to any contractual condition or any other default attributable to Contractor.

LD against delay in executed work in case of Termination/Closure of Contract:

LD against delay in executed work shall be calculated in line with LD clause no. 2.7.9 of GCC, for the delay attributable to contractor. For limiting the maximum value of LD, contract value shall be taken as Executed Value of work till termination/closure of contract.

Method for calculation of "LD against delay in executed work in case of termination of contract" is given below.

- i. Let the time period from scheduled date of start of work till termination of contract excluding the period of Hold (if any) not attributable to contractor = T1
- ii. Let the value of executed work till the time of termination of contract = X
- iii. Let the Total Executable Value of work for which inputs/fronts were made available to contractor and were planned for execution till termination of contract = Y
- iv. Delay in executed work attributable to contractor i.e. $T2 = [1 - (X/Y)] \times T1$
- v. LD shall be calculated in line with LD clause (clause 2.7.9) of the Contract for the delay attributable to contractor taking "X" as Contract Value and "T2" as period of delay attributable to contractor.

2.7.2.2 Remedies in case of Breach of Contract is established

In case 'Breach of Contract' is established, Security Deposit and Retention Amount shall be encashed/ forfeited. This is without prejudice to BHEL's right to levy of liquidated damages, debarment etc. which shall be applied as per the provisions of the contract. Sequence of recovery to be made in case of breach of contract is established, is as below

- a) Dues available in the form of Bills payable to contractor against the same contract.
- b) Demand notice for deposit of balance recovery amount shall be sent to contractor, if funds are insufficient to effect complete recovery against dues indicated in (a) above.
- c) If contractor fails to deposit the balance amount to be recovered within the period as prescribed in demand notice, following action shall be taken for balance recovery:
 - i. Dues payable to contractor against other contracts in the same Region shall be considered for recovery.
 - ii. If recovery cannot be made out of dues payable to the contractor as above, balance amount to be recovered, shall be informed to other Regions/Units for making recovery from the Unpaid Bills/Running Bills/SD/BGs/Final Bills of contractor.
 - iii. In-case recoveries are not possible with any of the above available options, Legal action shall be initiated for recovery against contractor.

2.7.3 In case Contractor fails to deploy the resources as per requirement informed by BHEL in writing to expedite the work, BHEL can deploy own/hired/otherwise arranged resources and recover the expenses incurred from the dues payable to contractor. Recoveries shall be actual expenses incurred plus 5% overheads or as defined in TCC.

2.7.4 To terminate the contract or to restrict the quantum of work and pay for the portion of work executed in case BHEL's contract with their customer are terminated for any reason, as per mutual agreement.

2.7.5 To effect recovery from any amounts due to the contractor under this or any other contract or in any other form, the moneys BHEL is statutorily forced to pay to anybody, due to contractor's failure to fulfill any of his obligations. BHEL shall levy overheads of 5% on all such payments along with interest as defined elsewhere in the GCC.

2.7.6 While every endeavor will be made by BHEL to this end, they (BHEL) cannot guarantee uninterrupted work due to conditions beyond their control. The Contractor will not be normally entitled for any compensation/extra payment on this account unless otherwise specified elsewhere in the contract.

2.7.7 BHEL may permit or direct contractor to demobilize and remobilize at a future date as intimated by BHEL in case of following situations for reasons other than Force majeure conditions and not attributable to contractor:

- i) suspension of work(s) at a Project either by BHEL or Customer,
or
- ii) where work comes to a complete halt or reaches a stage wherein worthwhile works cannot be executed and there is no possibility of commencement of work for a period of not less than three months

In such cases, charges towards demobilization and remobilization shall be as decided by BHEL after successful remobilization by contractor at site, and decision of BHEL shall be final and binding on the contractor. After remobilization, all conditions as per contract shall become applicable. In case Contractor does not remobilize with adequate resources or does not start the work within the period as intimated, then BHEL reserves the right to **terminate the contract and effect remedies under Clause 2.7.2.2**. Duration of the contract/time extension shall be revised suitably. In case of any conflict, BHEL decision in this regard shall be final and binding on the contractor.

2.7.8 In the unforeseen event of inordinate delay in receipt of materials, drawings, fronts etc. due to which inordinate discontinuity of work is anticipated, BHEL on its own or contractor's request at its discretion may consider to short close the contract in any of the following cases:

- a) The balance works (including but not limited to Trial Operation, PG Test etc.) are minor vis a vis the scope of work envisaged as per the contract.
- b) There has been no significant work in past 6 months OR no significant work is expected in next 6 months (example in Hydro projects or in projects where work has stopped due to reasons beyond the control of BHEL).
- c) The balance works cannot be done within a reasonable period of time as they are dependent on unit shut down or on other facilities of customer or any other such reasons not attributable to the contractor.

At the point of requesting for short closure, contractor shall establish that he has completed all works possible of completion and he is not able to proceed with the balance works due to constraints beyond his control. In such a case, the estimated value of the unexecuted portion of work (or estimated value of services to be provided for carrying out milestone/stage payments like Trial Operation/PG Test etc.) as decided by BHEL, shall however be reduced from the final contract

value.

Note: The Contractor shall not be eligible for any compensation on account of Quantity Variation arising out of short-closure of contract as per clause no. 2.7.8 (b) above.

2.7.9 LIQUIDATED DAMAGES/PENALTY

At the end of total work completion as certified by BHEL Engineer, and upon analysis of the total delay, the portion of time extensions attributable to (i) Contractor alone, (ii) Force majeure conditions, and (iii) BHEL, shall be worked out. The total period of time extensions shall be the sum of (i), (ii) and (iii) above and shall be equal to period between the scheduled date of completion and the actual date of completion of contract. LD shall be imposed/levied for the portion of time extensions solely attributable to contractor and recoverable from the dues payable to the contractor.

If the contractor fails to maintain the required progress of work which results in delay in the completion of the work as per the contractual completion period, BHEL shall have the right to impose Liquidated Damage/Penalty at the rate of 0.5% of the contract value, per week of delay or part thereof subject to a maximum of 10% of the contract value. For this purpose, the period for which LD is applicable shall be worked out based on portion of time extension granted solely attributable to contractor at the end of the contract. Contract Value for this purpose, shall be the final executed value exclusive of ORC, Extra Works executed on Manday rate basis, Supplementary/ Additional Items and PVC.

~~In case of LD recovery, the applicable GST shall also be recovered from contractor.~~

2.8 RESPONSIBILITIES OF THE CONTRACTOR IN RESPECT OF LOCAL LAWS, EMPLOYMENT OF WORKERS ETC.

The following are the responsibilities of the contractor in respect of observance of local laws, employment of personnel, payment of taxes etc. The subcontractor shall fully indemnify BHEL against any claims of whatsoever nature arising due to the failure of the contractor in discharging any of his responsibilities hereunder:

- 2.8.1** As far as possible, Unskilled Workers shall be engaged from the local areas in which the work is being executed.
- 2.8.2** The contractor at all times during the continuance of this contract shall, in all his dealings with local labour for the time being employed on or in connection with the work, have due regard to all local festivals and religious and other customs.
- 2.8.3** The contractor shall comply with all applicable State and Central Laws, Statutory Rules, Regulations, Notifications etc. such as Payment of Wages Act, Minimum Wages Act, Workmen Compensation Act, Employer's Liability Act, Industrial Disputes Act, Employers Provident Act, Employees State Insurance Scheme, Contract Labour (Regulation and Abolition) Act, 1970, Payment of Bonus & Gratuity Act, Building and Other Construction Workers (Regulation of Employment and Conditions of Service) Act 1996, The Building and Other Construction Workers' Welfare Cess Act 1996 and other Acts, Rules, and Regulations for labour/workers as applicable and as may be enacted by the State Government and Central Govt. during the tenure of the Contract and having force or jurisdiction at Site. The Contractor shall also comply with provisions of and give all such notices to the local Governing Body, Police and other relevant Authorities as may be required by the Law.

- 2.8.4** The Contractor shall obtain independent License under the Contract Labour (Regulations and Abolition) Act, 1970 for engaging contract labour as required from the concerned Authorities based on the certificate (Form- V or as applicable) issued by the Principal Employer/Customer.
- 2.8.5** The contractor shall pay and bear all taxes, fees, license charges, Cess, duties, deposits, tolls, royalties, commission or other charges which may be leviable on account of his operations in executing the contract.
- 2.8.6** While BHEL would pay the inspection fees and Registration fees of Boiler/Electrical Inspectorate, all other arrangements for site visits periodically by the Inspectorate to site, Inspection certificate etc. will have to be made by contractor. However, BHEL will not make any payment to the Inspectorate in connection with contractor's Welders/Electricians qualification tests etc.
- 2.8.7** Contractor shall be responsible for provision of Health and Sanitary arrangements (more particularly described in Contract Labour Regulation & Abolition Act), Safety precautions etc. as may be required for safe and satisfactory execution of contract.
- 2.8.8** The contractor shall be responsible for proper accommodation including adequate medical facilities for personnel employed by him.
- 2.8.9** The contractor shall be responsible for the proper behavior and observance of all regulations by the staff employed by him.
- 2.8.10** The contractor shall ensure that no damage is caused to any person/property of other parties working at site. If any such damage is caused, it is responsibility of the contractor to make good the losses or compensate for the same.
- 2.8.11** All the properties/equipments/components of BHEL/their Client loaned with or without deposit to the contractor in connection with the contract shall remain properties of BHEL/their Client.
- 2.8.12** The contractor shall use such properties for the purpose of execution of this contract. All such properties/equipments/components shall be deemed to be in good condition when received by the contractor unless he notifies within 48 hours to the contrary. The contractor shall return them in good condition as and when required by BHEL/their Client. In case of non-return, loss, damage, repairs etc. the cost thereof as may be fixed by BHEL Engineer will be recovered from the contractor.
- 2.8.13** In case the contractor is required to undertake any work outside the scope of this contract, the rates payable shall be those mutually agreed upon if the item rates are not mentioned in existing contract.
- 2.8.14** Any delay in completion of works/or non-achievement of periodical targets due to the reasons attributable to the contractor, the same may have to be compensated by the contractor either by increasing manpower and resources or by working extra hours and/or by working more than one shift. All these are to be carried out by the contractor at no extra cost.
- 2.8.15** The contractor shall arrange, coordinate his work in such a manner as to cause no hindrance to other agencies working in the same premises.

2.8.16 All safety rules and codes applied by the Client/BHEL at site shall be observed by the contractor without exception. The contractor shall be responsible for the safety of the equipment/material and works to be performed by him and shall maintain all light, fencing guards, slings etc. or other protection necessary for the purpose. Contractor shall also take such additional precautions as may be indicated from time to time by the Engineer with a view to prevent pilferage, accidents, fire hazards. Due precautions shall be taken against fire hazards and atmospheric conditions. Suitable number of Clerical staff, watch and ward, store keepers to take care of equipment/materials and construction tools and tackles shall be posted at site by the contractor till the completion of work under this contract.

The contractor shall arrange for such safety devices as are necessary for such type of work and carry out the requisite site tests of handling equipment, lifting tools, tackles etc. as per prescribed standards and practices.

Contractor has to ensure the implementation of Health, Safety and Environment (HSE) requirements as per directions given by BHEL/Customer. The contractor has to assist in HSE audit by BHEL/Customer and submit compliance Report. The contractor has to generate and submit record/reports as per HSE plan/activities as per instruction of BHEL/Customer.

2.8.17 The contractor will be directly responsible for payment of wages to his workmen. A pay roll sheet giving all the payments given to the workers and duly signed by the contractor's representative should be furnished to BHEL site for record purpose, if so called for.

Contractor shall create awareness amongst their workforce by helping & encouraging in opening bank accounts and to encourage them to adopt digital mode of transactions. While releasing wages/ salary to their workers/ supervisors/ staff, Contractor shall comply with the GOI's guidelines for maximizing such transactions through Non-Cash / digital means.

2.8.18 In case of any class of work for which there is no such specification as laid down in the contract, such work shall be carried out in accordance with the instructions and requirements of the Engineer.

2.8.19 Also, no idle charges will be admissible in the event of any stoppage caused in the work resulting in contractor's labour and Tools & Plants being rendered idle due to any reason at any time.

2.8.20 The contractor shall take all reasonable care to protect the materials and work till such time the plant/equipment has been taken over by BHEL or their Client whichever is earlier.

2.8.21 The contractor shall not stop the work or abandon the site for whatsoever reason of dispute, excepting force majeure conditions. All such problems/disputes shall be separately discussed and settled without affecting the progress of work. Such stoppage or abandonment shall be treated as breach of contract and dealt with accordingly.

2.8.22 The contractor shall keep the area of work clean and shall remove the debris etc. while executing day-to-day work. Upon completion of work, the contractor shall remove from the vicinity of work, all scrap, packing materials, rubbish, unused and other materials and deposit them in places specified by the Engineer. The contractor will also demolish all the hutments, sheds, offices etc. constructed and used by him and shall clean the debris. In the event of his failure to do so, the same will be arranged to be done by the Engineer and the expenses recovered from the contractor.

2.8.23 The contractor shall execute the work in the most substantial and workman like manner in the stipulated time. Accuracy of work and timely execution shall be the essence of this contract. The contractor shall be responsible to ensure that the quality, assembly and workmanship conform to the dimensions and clearance given in the drawings and/ or as per the instructions of the Engineer.

2.8.24 The Contractor to note that some of BHEL's T&Ps/MMDs may not be insured. The Contractor will take necessary precautions and due care to protect the same while in his custody from any damage/ loss till the same is handed over back to BHEL. In case the damage / loss is due to carelessness/ negligence on the part of the contractor, the Contractor is liable to get them repair/ replaced immediately and in case of his failure to do so within a reasonable time, BHEL will reserve the right to recover the loss from the contractor.

2.8.25 For all works having contract value of Rs. 5,00,000/- or above, BHEL shall recover the amount of compensation paid to victim(s) by BHEL towards loss of life/ permanent disability due to an accident which is attributable to the negligence of contractor, agency or firm or any of its employees as detailed below.

a) Victim: Any person who suffers permanent disablement or dies in an accident as defined below.

b) Accident: Any death or permanent disability resulting solely and directly from any unintended and unforeseen injurious occurrence caused during the manufacturing/ operation and works incidental thereto at BHEL factories/ offices and precincts thereof, project execution, erection and commissioning, services, repairs and maintenance, trouble shooting, serving, overhaul, renovation and retrofitting, trial operation, performance guarantee testing undertaken by the company or during any works/ during working at BHEL Units/ Offices/ townships and premises/ Project Sites.

c) Compensation in respect of each of the victims:

i. In the event of death or permanent disability resulting from Loss of both limbs:

Rs. 10,00,000/- (Rs. Ten Lakh).

ii. In the event of other permanent disability: Rs.7,00,000/- (Rs. Seven Lakh)

d) Permanent Disablement: A disablement that is classified as a permanent total disablement under the proviso to section 2 (I) of the Employee's Compensation Act, 1923.

2.8.26 Contractor shall be fully responsible for their T&Ps and other material mobilized at site. In any case, BHEL shall not be liable for any damage/loss/misuse of any item(s) belong to the contractor.

2.9 EXECUTION PLAN, PROGRESS MONITORING, MONTHLY REVIEW AND PERFORMANCE EVALUATION

2.9.1 A tentative plan/ programme for completion of the contractual scope of work as per the time schedule given in the contract shall be made jointly by BHEL and Contractor, before commencement of work. The above programme shall be supported by month wise deployment of resources viz Manpower, T&P, Consumables, etc. Progress will be reviewed periodically (Daily/Weekly/Monthly) vis-à-vis this jointly agreed programme.

Subsequently, every month, quarterly rolling plan will be made by BHEL based on budgeted targets.

Monthly plan in F-14 format shall be drawn from this Quarterly plan. Monthly plan shall necessarily include activities required for achieving targets/ milestones unless inputs/ fronts are not available. While planning and arriving on asking rate all available inputs shall be taken into consideration.

Vendor will be required to execute the monthly plan in that month in addition to make full efforts to minimize the cumulative shortfall attributable to him up to the month.

BHEL may require monthly work plan up to one and half times of average monthly value and demand matching manpower.

Where, Average Monthly Value = Total Contract Value (as per latest revision) / Period of Contract (in months)

Provided, this requirement is reflected in the rolling quarterly plan two months in advance.

If the Contractor refuses to sign the F-14 format, those F-14 formats requiring Contractor's signature shall be deemed to have been signed and accepted by the Contractor, if communicated to the Contractor through email or any other mode as stated in clause 2.3.1.

The Contractor shall submit periodical progress reports (Daily/Weekly/Monthly) and other reports/information including manpower, consumables, T&P mobilization etc. as desired by BHEL.

2.9.2 Monthly progress review between BHEL and Contractor shall be based on the agreed programme as above, availability of inputs/fronts etc., and constraints if any, as per prescribed formats (i.e. Form F-14). Manpower, T&P and consumable reports as per prescribed formats shall be submitted by contractor every month. Release of RA Bills shall be contingent upon certification by BHEL Site Engineer of the availability of the above prescribed formats duly filled in and signed.

2.9.3 The burden of proof that the causes leading to any shortfall is not due to any reasons attributable to the contractor is on the contractor himself. The monthly progress review shall record shortfalls attributable to (i) Contractor, (ii) Force Majeure Conditions, and (iii) BHEL

2.9.4 Performance of the Contractor shall be assessed as per prescribed formats and shall form the basis for 'Assessment of Capacity of Bidder' for Tenders where the Contractor is a bidder. BHEL reserves the right to revise the evaluation formats during the course of execution of the works.

2.10 TIME OF COMPLETION

2.10.1 The time schedule shall be as prescribed in the Contract. The time for completion shall be reckoned from the date of commencement of work at Site as certified by BHEL Engineers.

2.10.2 Time being the essence of the contract, the entire work shall be completed by the contractor within the time schedule or within such extended periods of time as may be allowed by BHEL under clause 2.11.

2.11 EXTENSION OF TIME FOR COMPLETION

2.11.1 If the completion of work as detailed in the scope of work gets delayed beyond the contract period, the contractor shall request for an extension of the contract and BHEL at its discretion may extend the Contract.

2.11.2 Based on the F-14 formats, the works balance at the end of original contract period less the

backlog attributable to the contractor shall be quantified, and the number of months of 'Time extension' required for completion of the same shall be jointly worked out. Within this period of 'Time extension', the contractor is bound to complete the portion of backlog attributable to the contractor. Any further 'Time extension' or 'Time extensions' at the end of the previous extension shall be worked out similarly.

2.11.3 However, if any 'Time extension' is granted to the contractor to facilitate continuation of work and completion of contract, due to backlog attributable to the contractor alone, then it shall be without prejudice to the rights of BHEL to impose penalty/LD for the delays attributable to the contractor, in addition to any other actions BHEL may wish to take under clause 2.7.2 of GCC i.e. "Breach of Contract, Remedies and Termination"

2.11.4 Planning, progress monitoring, monthly review and performance monitoring shall be carried out as per Clause 2.9 of GCC.

2.12 OVERRUN COMPENSATION

2.12.1 ORC during original contract period: No ORC shall be applicable during the original contract period.

2.12.2 ORC during extended period for the reasons solely attributable to contractor: No ORC shall be applicable during the extended period granted for the reasons solely attributable to contractor and work executed during this period shall be paid as per original contract rates.

2.12.3 ORC during extended period for the reasons not attributable to contractor: ORC shall be payable as per following procedure:

2.12.3.1 For initial period of twelve months of extended period, ORC rate applicable over executed value shall be 5%. For every subsequent period of twelve months, ORC rate shall be further increased by 5% over the previous rate. For example, ORC rates applicable for initial period of 12 months and subsequent period of 12 months are given below.

Sl. No.	Extended Period for the reasons attributable to BHEL	ORC rate applicable over executed value
1	First 12 months	5%
2	13 th -24 th month and so on	10.25% $\{[(1.05 \times 1.05) - 1] \times 100\}$

This process of increasing ORC rate for each subsequent period of 12 months shall continue till applicability of ORC.

2.12.3.2 On completion of original contract period as well as on completion of each subsequent period of twelve months i.e. at the time of change in applicable ORC rate, Delay Analysis shall be carried out and percentage shortfall attributable to both BHEL & Contractor shall be calculated.

2.12.3.3 For the purpose of calculation of ORC, executed value of work in the month shall be divided in Part-1 and Part-2 in proportion of percentage shortfall attributable to BHEL and contractor respectively, based on the last delay analysis as worked out in 2.12.3.2.

ORC shall be payable only on Part-1 and no ORC shall be payable on Part-2.

Value of Part-1 shall be further limited to the value of actual inputs provided by BHEL i.e. "Plan - Shortfall attributable to BHEL" for the month, as per Form-14 for calculation of ORC.

2.12.3.4 Payment of ORC amount shall be further regulated as follows:

- (i) 50% of the ORC is allocated for deployment of matching resources (with weightages) agreed as per the joint programme drawn vide 2.11.4. ORC Payment against resources shall be calculated

in proportion to percentage of resources actually deployed w.r.t. planned resources, as per Form-14.

- (ii) 50% of ORC is allocated for achieving of planned progress agreed as per the joint programme drawn vide 2.11.4. ORC Payment shall be reduced in proportion to percentage shortfall attributable to contractor w.r.t.-“Plan - Shortfall attributable to BHEL” for the month, as per Form-14.

2.12.3.5 The maximum amount of ORC payable for the month shall be limited to **Rs. 10,00,000/-**.

2.12.3.6 In case, there is no shortfall attributable to contractor for the month and also contractor has deployed the resources as agreed in Form-14 but ORC amount payable for the month worked out as per procedure mentioned in clause 2.12.3.3, 2.12.3.4 and 2.12.3.5, is less than Rs.1,00,000/-, then ORC amount payable for the month shall be Rs.1,00,000/- otherwise ORC amount payable for the month shall remain same.

2.12.3.7 In case execution is on **HOLD** (Other than Force Majeure), ORC shall be payable as per following:

- i). Contractor has not been permitted by BHEL to de-mobilize
- a) ORC amount of Rs. 1,00,000/- per month shall be applicable during the period of HOLD provided resources as planned are deployed (not demobilised) during the period of hold.
- b) Subsequent to lifting of HOLD, Period of HOLD shall not be excluded in calculation of period for deciding applicable ORC rate as per clause 2.12.3.1.
- ii). Contractor has been permitted to demobilize and to remobilize after lifting of HOLD
- a) No ORC shall be payable to contractor for the period of HOLD.
- b) Subsequent to lifting of HOLD, Period of HOLD shall not be excluded in calculation of period for deciding applicable ORC rate as per clause 2.12.3.1.

2.12.3.8 In case **Force Majeure** is invoked:

- i). No ORC shall be applicable during the period of Force Majeure.
- ii). Subsequent to revocation of Force Majeure, period of Force Majeure shall be excluded in calculation of period for deciding applicable ORC rate as per clause 2.12.3.1.

2.12.4 Applicability of ORC: ORC shall not be applicable for following activities.

- i). Area cleaning, removal of temporary structures and return of scrap.
- ii). Punch list points / pending points liquidation pending due to reasons attributable to contractor
- iii). Submission of “As built Drawing”
- iv). Material Reconciliation
- v). Completion of Contract Closure formalities like HR Clearance/ No dues from various dept./ Statutory Authorities etc.

2.12.5 Total Over Run Compensation shall be limited to 10% of the cumulatively executed contract value till the month (excluding Taxes and Duties if payable extra). For this purpose, executed contract value excludes PVC, ORC and Extra/Supplementary Works.

2.13 SECURED RECOVERABLE ADVANCES:

2.13.1 INTEREST FREE MOBILIZATION ADVANCE: Competent Authority of BHEL may approve proposals for payment of Interest Free Secured Mobilization Advance (limited to a maximum of 5% of the Contract Value) only in Installation Works in Power Plants under exceptional circumstances.

Interest Free Mobilization Advance shall be disbursed in specifically mentioned stages of major resource mobilization in the beginning of the contract, as specified in the TCC, in three or more instalments with the value of any instalment not more than 2.5% of the Contract Value. The next instalment will be due only on completion of the activities linked to the previous instalment.

Each such instalment is to be secured through BG of 100% of the instalment amount.

Recovery of Interest Free Secured Advance shall be made @ 10% of Running Bill Amount. As and when the total recovered amount exceeds any of the BG value submitted against the advance, that BG shall be returned.

In any case, Interest Free Advance shall be fully recovered by the time the contract reaches 50% of the original contract period either from Running Bills or by the Contractor directly depositing the amount. If the Contractor fails to deposit the total amount by the stipulated date, the recovery shall be made by encashing BGs/ Securities available with BHEL for the balance amount.

2.13.2 INTEREST BEARING ADVANCE:

2.13.2.1 INTEREST BEARING MOBILIZATION ADVANCE: Competent authority may also approve need based Interest Bearing Mobilization advance after a certification from the Contractor for having achieved a financial progress of 10% of the original contract price. However, the total mobilization advance (including Interest Free Mobilization Advance) shall not exceed 10% of the Contract Value. Bank Guarantee towards 'Interest Bearing Recoverable Advance' shall be 110% of the advance so as to enable recovery of not only principle amount but also the interest portion, if so required.

2.13.2.2 INTEREST BEARING SECURED ADDITIONAL INTERIM ADVANCE: In exceptional circumstances, with due justification, Competent Authority of BHEL may approve proposals for payment of additional interim interest bearing advance against Bank Guarantee, for resource augmentation towards expediting work for project implementation. Contractor shall establish the utilization of advance drawn in the form of Utilization Certificate before the release of next installment.

Bank Guarantee shall be 110% of the advance so as to enable recovery of not only principle amount but also the interest portion, if so required. Unadjusted amount of advances (including Interest Free Mobilization Advance) paid shall not exceed 10% of the total contract value at any point of time.

NOTES for INTEREST BEARING ADVANCE:

- (a) Recovery of Interest Bearing Advances shall be made from the Running Bills progressively. Recovery rate per month for Interest Bearing Advances shall be the sum of:
 - i) Not less than 10% of Running Bill amount
 - ii) Simple interest up to the date of RA Bill on the outstanding Principle amount/amounts

- (b) In any case, Interest Bearing Advance shall be fully recovered by the time the contractor's billing reaches 90% of contract value either from Running Bills or by the Contractor directly depositing the amount. If the Contractor fails to deposit the total amount by the stipulated date, the recovery shall be made by encashing BGs/ Securities available with BHEL for the balance amount along with interest.
- (c) Payment and recovery of any of the above advance(s) shall be at the sole discretion of BHEL and shall not be a subject matter of arbitration.
- (d) The rate of interest applicable for the above advances shall be the repo rate prevailing on the date of release of advance plus 4%, and such rate will remain fixed till the total advance amount is recovered.
- (e) Contractor to submit Bank Guarantee as per prescribed formats for each of the advance and shall be valid for at least one year or the recovery duration whichever is earlier. In case the recovery of dues does not get completed within the aforesaid BG period, the contractor shall renew the BG or submit fresh BG for the outstanding amount, valid for at least one year or the remaining recovery duration whichever is earlier. For each advance, the Contractor will be allowed to submit more than one BG so that the BGs can be returned progressively based on recovered amount. In case, the Contractor prefers to submit single BG against an advance, the amount of BG may be progressively reduced by the amount repaid by the Contractor.
- (f) BHEL is entitled to make recovery of the entire outstanding amount in case the contractor fails to comply with the BG requirement.

2.13.3 SECURED ADVANCE AGAINST MATERIAL BROUGHT TO SITE:

Secured advance on the security of materials (which are not combustible, fragile or perishable in nature) brought to the site but not yet incorporated in the works will be made up to 75% of Invoice value, or the 75% of the corresponding value of the materials determined on the basis of BOQ rates, whichever is less, subject to the condition that their quantities are not excessive and shall be used within a period of 90 days and subject to the stipulations, as mentioned below:

- (i) Contractor shall obtain prior permission of Engineer-in-charge before procurement of materials against which advance is being sought. Engineer-in-charge shall ensure formal approval of Construction Manager before communicating the permission to Contractor.
- (ii) Secured advance shall not be allowed/ payable for materials procured by Contractor before the date of such permission.
- (iii) Secured Advance shall be allowed only once against a single invoice. Multiple Secured Advance against single invoice is not allowed.
- (iv) Secured advance against materials shall be paid only against non-perishable items. Engineer-in-charge to ensure that such items are adequately covered under insurance cover (to be taken by

the Contractor if not covered under BHEL Insurance Policy).

- (v) At any point of time, the unadjusted secured payments against material brought to site shall not be more than 5% of the Contract Value.
- (vi) The advance will be repaid from each succeeding Running bill(s) to the extent materials for which advance has been previously paid have been incorporated into the works. In any case, such advance payment shall be fully recovered maximum from 3-4 subsequent RA bills whether the material is consumed in the work or not. In absence of sufficient value of RA bills for making the required recovery, the Contractor shall deposit the balance amount. If the Contractor fails to deposit the total amount by the stipulated date, the recovery shall be made by encashing the Securities available with BHEL for the balance amount.
- (vii) Contractor has to give a formal deed of hypothecation, drawn up on non-judicial stamp paper under which the BHEL secures a lien on the materials and is safeguarded against losses, due to the contractor postponing the execution of the work or due to the shortage or misuse of materials and against the expenses incurred on their watch and safe custody.

2.14 QUANTITY VARIATION

2.14.1 Variation in Final Executed Contract Value

The quantities given in the contract are tentative and may change to any extent (both in plus side and minus side). No compensation becomes payable in case the variation of the final executed contract value is within the limits of Minus (-) 15% of awarded contract value. Also, no compensation becomes payable in case the contract gets partially executed/ short closed/ terminated/ work withdrawn under Rights of BHEL mentioned in Clause 2.7 of GCC. In case of work terminated / short closed under clause 2.7.4 of GCC, compensation may be considered only if BHEL receives compensation from customer.

Compensation due to variation of final executed contract value in excess of the limits defined in clause above, shall be as follows:

- i) In case the finally executed contract value reduces below the lower limit of awarded Contract Value due to quantity variation specified above, the Contractor will be eligible for compensation @ 15% of the difference between the lower limit of the awarded contract value and the actual executed contract value.
- ii) In case the finally executed contract value increases above the awarded Contract Value due to quantity variation, the Contractor is not eligible for any compensation

2.14.2 Variation in Individual Quantities of BOQ Item(s)

The quantities given in the contract are tentative and may change to any extent (both in plus side and minus side). No compensation becomes payable in case the variation of the quantity of individual BOQ item(s) is within the limits of Plus (+) 100% of the quantity in the original price schedule.

In case executed quantity for a particular BOQ item(s) exceeds two times the quantity in the original price schedule (100% increase), then the revision in rates for such BOQ item(s) for the quantity in excess of two times the quantity in the original price schedule including any subsequent increase in quantity, may be considered based on request from the Contractor, however, BHEL decision in this regard shall be final. Revised rates for subject BOQ item (s) shall be worked out on the basis of prevailing market rates mutually agreed between BHEL and Contractor. PVC/ ORC will not be applicable for these revised rates.

BHEL, however, retains the right to arrange the excess quantity through any other source for expediting activities in the interest of the Project.

- Note: (a) Revision in rates under clause 2.14.2 will remain admissible in those cases also, where, the Contractor is eligible for compensation under clause 2.14.1 i).
(b) The value of work executed at revised rates due to variation in Individual Quantities of BOQ Item(s) shall be included while calculating the finally executed contract value in clause no. 2.14.1 above.

2.15 EXTRA WORKS

- 2.15.1** All rectifications/modifications, revamping and reworks required for any reasons not due to the fault of the contractor, or needed due to any change in deviation from drawings and design of equipments, operation/maintenance requirements, mismatching or due to damages in transit, storage and erection/commissioning and other allied works which are not very specifically indicated in the drawings, but are found essential for satisfactory completion of the work, will be considered as extra works.
- 2.15.2** Extra works arising on account of the contractor's fault, irrespective of time consumed in rectification of the damage/loss, will have to be carried out by the contractor free of cost. Under such circumstances, any material and consumable required for this purpose will also have to be arranged by the contractor at his cost.
- 2.15.3** All the extra work should be carried out by a separately identifiable gang, without affecting routine activities. Daily log sheets in the pro-forma prescribed by BHEL should be maintained and shall be signed by the contractor's representative and BHEL engineer. No claim for extra work will be considered/entertained in the absence of the said supporting documents i.e. daily log sheets. Signing of log sheets by BHEL engineer does not necessarily mean the acceptance of such works as extra works.
- 2.15.4** BHEL retains the right to award or not to award any of the major repair/rework/modification/rectification/fabrication works to the contractor, at their discretion without assigning any reason for the same.
- 2.15.5** After eligibility of extra works is established and finally accepted by BHEL engineer/ designer, payment will be released on competent authority's approval at the following rate.
- MAN-HOUR RATE FOR ELIGIBLE EXTRA WORKS:** Single composite average labour man-hour rate, including overtime if any, supervision, use of tools and tackles and other site expenses and incidentals, consumables for carrying out any major rework/ repairs/ rectification/ modification/ fabrication as certified by site as may arise during the course of erection, testing, commissioning or extra works arising out of transit, storage and erection damages, payment, if found due will be at Rs 139/- per man hour.
- 2.15.6** The above composite labour man hour rate towards extra works shall remain firm and not subject to any variation during execution of the work. PVC will not be applicable for extra works. Rate revision, Over Run Charges/compensation etc. will not be applicable due to on extra works.
- 2.15.7** **Extra Works for Civil Packages** shall be regulated as follows –

- i) Rates for Extra Works arising due to (1) non availability of BOQ (Rate Schedule), OR (2) change in Specifications of materials/works (3) rectification/modification/dismantling & re-erecting etc. due to no fault of Contractor, shall be in the order of the following:
 - a) Item rates are to be derived from similar nature of items in the BOQ (Rate Schedule) with applicable escalation derived from All India Consumer Price Index for Whole Sale Commodities.
 - b) As per latest edition of CPWD-DSR with applicable escalation derived from All India Consumer Price Index for Whole Sale Commodities OR Notification issued by the office of CPWD for 'Cost Index' in that Region where the project is being executed with applicable escalation derived from All India Consumer Price Index for Whole Sale Commodities, whichever is less.
 - c) Item rates are to be worked out on the basis of market rates prevailing on the date of execution mutually agreed between BHEL and Contractor.
- ii) PVC and ORC will not be applicable for (i) above.

2.16 SUPPLEMENTARY ITEMS

2.16.1 For NON Civil Works

Supplementary items are items/works required for completion of entire work but not specified in the scope of work. Subject to certification of such items/works as supplementary items by BHEL Engineer, rates shall be derived on the basis of any one of the following on mutual agreement:

- i) Based on percentage breakup/rates indicated for similar/nearby items.
- ii) In case (i) above does not exist, then BHEL/site may derive the percentage breakup/rates to suit the type of work.

2.16.2 For Civil Works

- i) Rates for Supplementary Works/Additional Works arising out due to additions/alterations in the original scope of works as per contract subject to certification of BHEL Engineer shall be worked out as under:
 - a) Item rates which are available in existing BOQ (Rate Schedule) shall be operated with applicable escalation derived from All India Consumer Price Index for Whole Sale Commodities
 - b) Items of works which are not available in existing BOQ shall be operated as an 'Extra Works' and rate shall be derived as per clause no 2.15.7
- ii) Execution of Supplementary Works/Additional Works through the Contractor shall be at the sole discretion of BHEL, and shall be considered as part of executed contract value for the purpose of Quantity Variation as per clause 2.14
- iii) BHEL Engineer's decision regarding fixing the rate as above is final and binding on the contractor.
- iv) PVC and ORC will not be applicable for (i) above.

2.17 PRICE VARIATION COMPENSATION

- 2.17.1 In order to take care of variation in cost of execution of work on either side, due to variation in the index of LABOUR, HIGH SPEED DIESEL OIL, WELDING ROD, CEMENT, STEEL, MATERIALS, Price Variation Formula as described herein shall be applicable
- 2.17.2 85% component of Contract Value shall be considered for PVC calculations and remaining 15% shall be treated as fixed component. The basis for calculation of price variation in each category, their component, Base Index, shall be as under:

SL NO.	CATEGORY	INDEX/ AVERAGE MINIMUM WAGE	PERCENTAGE COMPONENT ('K')				
			CIVIL PACKAGES (See Note A/B/C)			MECHANICAL PACKAGES	Electrical , C&I Material Management/ Handling and other labour oriented packages
			A	B	C		
i)	LABOUR (ALL CATEGORIES)	(a) 'MONTHLY ALL-INDIA AVERAGE CONSUMER PRICE INDEX NUMBERS FOR INDUSTRIAL WORKERS' published by Labour Bureau, Ministry of Labour and Employment, Government of India. (50% weightage out of component 'K') (Website: labourbureau.nic.in) (b) Arithmetical average of minimum wages of Unskilled, Semi-skilled, Skilled and Highly skilled workers as applicable at project site location (50% weightage out of component 'K')	40	25	30	65	80
ii)	HIGH SPEED DIESEL OIL	Name of Commodity: HSD Commodity Code: 1202000005 (See Note E)	5	3	5	5	5
iii)	WELDING ROD	Name of Commodity: MANUFACTURE OF BASIC METALS Commodity Code: 1314000000 (See Note E)				15	
iv)	CEMENT	Name of Commodity: ORDINARY PORTLAND CEMENT Commodity Code: 1313050003 (See Note E)		20	30		
v)	STEEL (Structural and Reinforcement Steel)	Name of Commodity: MILD STEEL: LONG PRODUCTS Commodity Code: 1314040000 (See Note E)		25			
vi)	ALL OTHER MATERIALS (Other than Cement & Steel)	Name of Commodity: ALL COMMODITIES Commodity Code: 1000000000 (See Note E)	40	12	20		

Note: A) Cement & Steel: Free Issue (BHEL Scope)

B) Cement & Steel: In Contractor Scope

C) Cement in Contractor Scope, and Steel is Free Issue (BHEL Scope)

D) For Composite packages (i.e. Civil+Mechanical+Electrical and/or C&I or Civil+Mechanical or Mechanical+Electrical and/or C&I), the COMPONENT ('K') for various categories shall be as per respective packages as above.

E) As per the 'MONTHLY WHOLE SALE PRICE INDEX' for the respective Commodity and Type, published by Office of Economic Adviser, Ministry of Commerce and Industry, Government of India. (Website: eaindustry.nic.in). Revisions in the index or commodity will be re-adjusted accordingly.

2.17.3 #

2.17.4 Payment/recovery due to variation in index shall be determined on the basis of the following notional formula in respect of the identified COMPONENT ('K') viz LABOUR, HIGH SPEED DIESEL OIL, WELDING ROD, CEMENT, STEEL, MATERIALS.

$$P = K \times R \times \frac{(X_N - X_0)}{X_0}$$

Where,

- P = Amount to be paid/recovered due to variation in the Index for Labour, High Speed Diesel Oil, Welding Rod, Cement, Steel and Materials
- K = Percentage COMPONENT ('K') applicable for Labour, High Speed Diesel Oil, Welding Rod, Cement, Steel and Materials
- R = Value of work done for the billing month (Excluding Taxes and Duties if payable extra)
- X_N = Revised Index for Labour, Revised Average Minimum Wages for Labour, Revised Index for High Speed Diesel Oil, Welding Rod, Cement, Steel and Materials for the billing month under consideration
- X₀ = Index for Labour, Average Minimum Wages for Labour, Index for High Speed Diesel Oil, Welding Rod, Cement, Steel and Materials as on the Base date

2.17.5 PVC shall not be payable for the ORC amount, Supplementary/Additional Items, Extra works. However, PVC will be payable for items executed under quantity variation of BOQ items under originally awarded contract.

2.17.6 Base date shall be calendar month of the 'last date of submission of Tender'.

2.17.7 The contractor shall furnish necessary monthly bulletins in support of the requisite indices from the relevant websites along with his Bills.

2.17.8 The contractor will be required to raise the bills for price variation payments on a monthly basis along with the running bills irrespective of the fact whether any increase/decrease in the index for relevant categories has taken place or not. In case there is delay in publication of bulletins (final figure), the provisional values as published can be considered for payments and arrears shall be paid/recovered on getting the final values.

2.17.9 PVC shall be applicable for the entire original contract period plus the extended period, i.e. for the complete execution period, as follows:

For PVC computation of the nth month:

Let the cumulative delay attributable to the Contractor is D_n in the nth month as per Form-14.

Considering R_n as the billing value for the nth month, PVC for the nth month shall be calculated as follows:

- a) PVC for the portion of R_n for an amount of D_(n-1) shall be payable as per indices for the (n-1)th month.
- b) PVC for the balance portion of R_n shall be payable as per indices for the nth month

In case D_(n-1) is greater than R_n, then entire R_n shall be payable as per indices for the (n-1)th month and the balance portion of D_(n-1) shall be adjusted from R_(n+1) of the (n+1)th month and will be

payable as per indices for the (n-1)th month. The above process shall be continued for subsequent month(s) also till full $D_{(n-1)}$ is consumed.

- i) For milestones mentioned in the contract, PVC shall be applicable as per average of the indices from the month of base date till the month of execution of milestone.
- ii) PVC shall not be applicable for time extension provided for the delays solely attributable to the contractor. No PVC is payable during the period of Provisional Time Extension till grant of final time extension. Applicability of PVC will be decided at the time of grant of final time extension.
- iii) The total amount of PVC shall not exceed 15% of the cumulatively executed contract value. Executed contract value for this purpose is exclusive of PVC, ORC, Supplementary/Additional Items and Extra works except items due to quantity variation.

Note: Work Planning in F-14 format to be meticulously done as per Clause 2.9 of this GCC

2.18 INSURANCE

- 2.18.1 BHEL/their customer shall arrange for insuring the materials/properties of BHEL/customer covering the risks during transit, storage, erection and commissioning.
- 2.18.2 It is the sole responsibility of the contractor to insure his materials, equipment, workmen etc. against accidents and injury while at work and to pay compensation, if any, to workmen as per Workmen's compensation Act. The work will be carried out in a protected area and all the rules and regulations of the client /BHEL in the area of project which are in force from time to time will have to be followed by the contractor.
- 2.18.3 If due to negligence and or non-observation of safety and other precautions by the contractors, any accident/injury occurs to the property / manpower belong to third party, the contractor shall have to pay necessary compensation and other expense, if so decided by the appropriate authorities.
- 2.18.4 The contractor will take necessary precautions and due care to protect the material, while in his custody from any damage/ loss due to theft or otherwise till the same is taken over by BHEL or customer. For lodging / processing of insurance claim, the contractor will submit necessary documents. BHEL will recover the loss including the deductible franchise from the contractor, in case the damage / loss is due to carelessness / negligence on the part of the contractor. In case of any theft of material under contractor's custody, matter shall be reported to Police by the contractor immediately and copy of FIR and subsequently police investigation report shall be submitted to BHEL for taking up with insurance. However, this will not relieve the contractor of his contractual obligation for the material in his custody.

2.19 STRIKES & LOCKOUT

- 2.19.1 The contractor will be fully responsible for all disputes and other issues connected with his labour. In the event of the contractor's labour resorting to strike or the Contractor resorting to lockout and if the strike or lockout declared is not settled within a period of **two weeks**, **it may be considered as 'Breach of Contract' under Clause 2.7 and the remedies under Clause 2.7.2.2 may be executed, at the discretion of BHEL**
- 2.19.2 For all purposes whatsoever, the employees of the contractor shall not be deemed to be in the employment of BHEL.

2.20 FORCE MAJEURE

- 2.20.1 "Force Majeure" shall mean circumstance which is: a) beyond a party's control, b) The party could not reasonably have provided against before entering into the contract, c) Having arisen, such party could not reasonably have avoided or overcome, and d) Is not substantially attributable to the other party. Such circumstances include but not limited to
- i) Exceptionally adverse climatic conditions at the site which are unforeseeable having regard to climate data available or published in the country for the geographical location of the site.
 - ii) War, hostilities (whether war be declared or not), invasion, act of foreign enemies.
 - iii) Rebellion, terrorism, revolution, insurrection, military or usurped power, or civil war.
 - iv) Riot, commotion or disorder by persons other than the contractor's personnel and other employees of the contractor and sub-contractors.
 - v) Strike or lockout not solely involving the contractor's personnel and other employees of the contractor and sub-contractors.
 - vi) Encountering munitions of war, explosive materials, ionizing radiation or contamination by radio-activity, except as may be attributable to the contractor's use of such munitions, explosives, radiation or radio- activity.
 - vii) Natural catastrophes such as earthquake, tsunami, volcanic activity, hurricane or typhoon, flood, fire, cyclones etc.
- 2.20.2 The following events are explicitly excluded from Force Majeure and are solely the responsibilities of the non-performing party: a) any strike, work-to-rule action, go-slow or similar labour difficulty (b) late delivery of equipment or material (unless caused by Force Majeure event) and (c) economic hardship.
- 2.20.3 If either party is prevented, hindered or delayed from or in performing any of its obligations under the Contract by an event of Force Majeure, then it shall notify the other in writing of the occurrence of such event and the circumstances thereof within 15 (fifteen) days after the occurrence of such event.
- 2.20.4 The party who has given such notice shall be excused from the performance or punctual performance of its obligations under the Contract for so long as the relevant event of Force Majeure continues and to the extent that such party's performance is prevented, hindered or delayed. The Time for Completion shall be extended by a period of time equal to period of delay caused due to such Force Majeure event.
- 2.20.5 Delay or non-performance by either party hereto caused by the occurrence of any event of Force Majeure shall not
- i) Constitute a default or breach of the Contract.
 - ii) Give rise to any claim for damages or additional cost expense occasioned thereby, if and to the extent that such delay or non-performance is caused by the occurrence of an event of Force Majeure.
- 2.20.6 BHEL at its discretion may consider short closure of contract after 1 year of imposition of Force Majeure in line with extant guidelines. In any case, Contractor cannot consider deemed short-closure after 1 year of imposition of Force Majeure.

2.21 ARBITRATION & CONCILIATION

2.21.1 ARBITRATION:

- 2.21.1.1 Except as provided elsewhere in this Contract, in case Parties are unable to reach amicable

settlement (whether by Conciliation to be conducted as provided in Clause 2.21.2 herein below or otherwise) in respect of any dispute or difference; arising out of the formation, breach, termination, validity or execution of the Contract; or, the respective rights and liabilities of the Parties; or, in relation to interpretation of any provision of the Contract; or, in any manner touching upon the Contract (hereinafter referred to as the 'Dispute'), then, either Party may, commence arbitration in respect of such Dispute by issuance of a notice in terms of section 21 of the Arbitration & Conciliation Act, 1996 (hereinafter referred to as the 'Notice'). The Notice shall be addressed to the Head of the Power Sector Region issuing the Contract and shall contain the particulars of all claims to be referred to arbitration in sufficient detail and shall also indicate the monetary amount of such claim. Within 60 days of receipt of the complete Notice, the Head of the BHEL Power Sector Region issuing the Contract shall offer names of three proposed Arbitrators to the invoking Party advising to choose any one of the three names to be appointed as Sole Arbitrator. On getting confirmation from the invoking Party regarding the Arbitrator chosen from among the names so offered, the Head of the BHEL Power Sector Region issuing the Contract, shall appoint such chosen person as the Sole Arbitrator for conducting the arbitration. The language of arbitration shall be English.

The Arbitrator shall pass a reasoned award.

Subject as aforesaid, the provisions of Arbitration and Conciliation Act 1996 (India) or statutory modifications or re-enactments thereof and the rules made thereunder as in force from time to time shall apply to the arbitration proceedings under this clause. The seat of arbitration shall be _____ (the place from where the contract is Issued). The Contract shall be governed by and be construed as per provisions of the laws of India. Subject to this provision 2.21.1.1 regarding ARBITRATION, the principal civil court exercising ordinary civil jurisdiction over the area where the seat of arbitration is located shall have exclusive jurisdiction over any DISPUTE to the exclusion of any other court.

2.21.1.2 In case of Contract with Public Sector Enterprise (PSE) or a Government Department, the following shall be applicable:

In the event of any dispute or difference relating to the interpretation and application of the provisions of commercial contract(s) between Central Public Sector Enterprises (CPSEs)/ Port Trusts inter se and also between CPSEs and Government Departments/Organizations (excluding disputes concerning Railways, Income Tax, Customs & Excise Departments), such dispute or difference shall be taken up by either party for resolution through AMRCD (Administrative Mechanism for Resolution of CPSEs Disputes) as mentioned in DPE OM No. 4(1)/2013-DPE(GM)/FTS-1835 dated 22-05-2018 as amended from time to time.

2.21.1.3 The cost of arbitration shall initially be borne equally by the Parties subject to the final allocation thereof as per the award/order passed by the Arbitrator.

2.21.1.4 Notwithstanding the existence of any dispute or differences and/or reference for the arbitration, the Contractor shall proceed with and continue without hindrance the performance of its obligations under this Contract with due diligence and expedition in a professional manner unless the dispute inter-alia relates to cancellation, termination or short-closure of the Contract by BHEL.

2.21.2 CONCILIATION:

If at any time (whether before, during or after the arbitral or judicial proceedings), any Disputes (which term shall mean and include any dispute, difference, question or disagreement arising in

connection with construction, meaning, operation, effect, interpretation or breach of the agreement, contract), which the Parties are unable to settle mutually, arise inter-se the Parties, the same may, be referred by either party to Conciliation to be conducted through Independent Experts Committee (IEC) to be appointed by competent authority of BHEL from the BHEL Panel of Conciliators.

Notes:

1. No serving or a retired employee of BHEL/Administrative Ministry of BHEL shall be included in the BHEL Panel of Conciliators.
2. Any other person(s) can be appointed as Conciliator(s) who is/are mutually agreeable to both the parties from outside the BHEL Panel of Conciliators.

The proceedings of Conciliation shall broadly be governed by Part-III of the Arbitration and Conciliation Act 1996 or any statutory modification thereof and as provided in Procedure 2.3 to this GCC. The Procedure 2.3 together with its Formats will be treated as if the same is part and parcel hereof and shall be as effectual as if set out herein in this GCC.

The Contractor hereby agrees that BHEL may make any amendments or modifications to the provisions stipulated in the Procedure 2.3 to this GCC from time to time and confirms that it shall be bound by such amended or modified provisions of the Procedure 2.3 with effect from the date as intimated by BHEL to it.

2.21.3 **No Interest payable to Contractor**

Notwithstanding anything to the contrary contained in any other document comprising in the Contract, no interest shall be payable by BHEL to Contractor on any moneys or balances including but not limited to the Security Deposit, EMD, Retention Money, RA Bills or the Final Bill, or any amount withheld and/or appropriated by BHEL etc., which becomes or as the case may be, is adjudged to be due from BHEL to Contractor whether under the Contract or otherwise.

2.22 **RETENTION AMOUNT (5 % of the Contract Value)**

2.22.1 Retention Amount shall be 5% of the Contract Value and shall be furnished before first RA Bill becomes due for payment. The validity of Retention amount shall be initially for the contract period Plus 3 months & shall be extended, if so required, up to acceptance of final bill. In case of increase in contract value, additional 5% of differential amount shall be submitted by Contractor before payment of next RA Bill due.

The Retention amount of 5% of the contract value may be accepted in the following forms.

- i. Cash (as permissible under the extant Income Tax Act).
- ii. Local cheques of Scheduled Banks (subject to realization)/ Pay Order/ Demand Draft/ Electronic Fund Transfer in favour of BHEL.
- iii. Securities available from Indian Post offices such as National Savings Certificates, Kisan Vikas Patras etc. (held in the name of Contractor furnishing the security and duly endorsed/ hypothecated/ pledged, as applicable, in favour of BHEL).
- iv. Bank Guarantee from Scheduled Banks/ Public Financial Institutions as defined in the Companies Act. The Bank Guarantee format for Security Deposit shall be in the prescribed formats.
- v. Fixed Deposit Receipt issued by Scheduled Banks/ Public Financial Institutions as defined in the Companies Act (FDR should be in the name of the Contractor, a/c BHEL).

vi. **Insurance Surety Bonds**

Alternatively, on successful bidder's request, the Retention Amount can also be recovered at the rate of 10% of the gross amount, progressively, from each of the running bills of the contractor till the total amount of the required retention amount is collected.

In case, contractor opts cash deduction from RA bills in the beginning & subsequently submit 5% of the Contract Value as Retention amount in any form as mentioned above, then refund of deducted retention amount may be permitted to contractor.

Note:

- 1) BHEL will not be liable or responsible in any manner for the collection of interest or renewal of the documents or in any other matter connected therewith.

2.22.2 **Refund of retention amount shall be as follows:**

100% of Retention Amount shall be released along with Final Bill after deduction all expenses/ other amounts due to BHEL under the contract/ other contracts entered into with them (contractor) by BHEL.

2.23 PAYMENTS

Payments to Contractors are made in any one of the following forms: -

2.23.1 **Running Account Bills (RA Bills)**

- i) These are for interim payments when the contracts are in progress. The bills for such interim payments are to be prepared by Contractor in prescribed formats (RA Bill forms).
- ii) Payments shall be made according to the extent of work done as per measurements taken up to the end of the calendar month and in line with the terms of payments described in the Tender documents.
- iii) Recoveries on account of electricity, water, statutory deductions etc. are made as per terms of contract.
- iv) Full rates for the work done shall be allowed only if the quantum of work has been done as per the specifications stipulated in the contract. If the work is not executed as per the stipulated specifications, BHEL may ask the contractor to redo the work according to the required specifications, without any extra cost. However, where this is not considered necessary 'OR' where the part work is done due to factors like non-availability of material to be supplied by BHEL 'OR' non availability of fronts 'OR' non availability of drawings, fraction payment against full rate, as is considered reasonable, may be allowed with due regard for the work remaining to be done. BHEL decision in this regard will be final and binding on the contractor.
- v) In order to facilitate part payment, BHEL at its discretion may further split the contracted rates/percentages to suit site conditions, cash flow requirements according to the progress of work, subject to following:
 - a) Provided no 'part' payment is recommended till 25% of work in the item rate is executed.
 - b) Payment of item rate to be made in not more than three instalments, last stage payment to be not lower than 20% of the item rate.

2.23.2 **Final Bill**

'Final Bill' is used for final payment on closing of Running Account for works or for single payment after completion of works. 'Final Bill' shall be submitted as per prescribed format after completion of

works as per scope and upon material reconciliation, along with the following:

- i) 'No Claim Certificate' by Contractor
- ii) Clearance certificates where ever applicable viz. Clearance Certificates from Customer, various Statutory Authorities like Labour department, PF Authorities, Commercial Tax Department etc.
- iii) Indemnity Bond as per prescribed format.

BHEL shall settle the final bills after deducting all liabilities of Contractor to BHEL.

2.24 PERFORMANCE GUARANTEE FOR WORKMANSHIP

2.24.1 Even though the work will be carried out under the supervision of BHEL Engineers the Contractor will be responsible for the quality of the workmanship and shall guarantee the work done for a period of Twelve months from the date of commencement of guarantee period as defined in Technical Conditions of Contract, for good workmanship and shall rectify free of cost all defects due to faulty erection detected during the guarantee period. In the event of the Contractor failing to repair the defective works within the time specified by the Engineer, BHEL may proceed to undertake the repairs of such defective works **by itself**, without prejudice to any other rights and recover the **cost incurred for the same along with 5% overheads** from the Security Deposit.

2.24.2 BHEL shall release the Security Deposit subject to the following

- i) Contractor has submitted 'Final Bill'
- ii) Guarantee period as per contract has expired
- iii) Contractor has furnished 'No Claim Certificate' in specified format
- iv) BHEL Site Engineer/Construction Manager has furnished the 'No Demand Certificate' in specified format
- v) Contractor has carried out the works required to be carried out by him during the period of Guarantee and all expenses incurred by BHEL on carrying out such works is included for adjustment from the Security Deposit refundable.

2.25 CLOSING OF CONTRACTS

The Contract shall be considered completed and closed upon completion of contractual obligations and settlement of Final Bill or completion of Guarantee period whichever is later. Upon closing of Contract, BHEL shall issue a performance/ experience certificate as per standard format, based on specific request of Contractor as per extant BHEL guidelines.

2.26 SUSPENSION OF BUSINESS DEALINGS

BHEL reserves the right to take action against Contractors who either fail to perform or Tenderers/Contractor who indulge in malpractices, by suspending business dealings with them in line with BHEL guidelines issued from time to time.

2.27 LIMITATION ON LIABILITY:

Notwithstanding anything to the contrary in this Agreement or the Work Order or any other mutually agreed document between the parties, the maximum liability, for damages, of the contractor, its servants or agents, shall under no circumstances exceed an amount equal to the Price of the Agreement or the Work Order. The Supplier shall not in any case be liable for loss of profit or special, punitive, exemplary, indirect or consequential losses whatsoever. This shall not be applicable on the recoveries made by Customer from BHEL on account of Contractor, any other type of recoveries for workmanship, material, T&P etc. due from the contractor.

2.28 OTHER ISSUES

- 2.28.1 Value of Non judicial Stamp Paper for Bank Guarantees and for Contract Agreement shall be not less than Rs 100/- unless otherwise required under relevant statutes.
- 2.28.2 In case of any conflict between the General Conditions of Contract and Special Conditions of Contract, provisions contained in the Special Conditions of Contract shall prevail.
- 2.28.3 Unless otherwise specified in NIT, offers from consortium/ JVs shall not be considered.
- 2.28.4 BHEL may not insist for signing of Contract Agreements in respect of low value and short time period contracts like providing services for Hot water flushing, Chemical Cleaning, Transportation, Geo-Technical works, Hiring of T&Ps/ Vehicles/ Equipments etc. and work shall be executed as per the terms of LOI/LOA/Work Order. BHEL may not insist for signing of Contract Agreements in respect of works costing upto Rs. 2 lakhs (upto Rs. 5 lakhs in case scheduled completion period is not more than 3 months).

Rev 01

1st June

2012

VOLUME ID FORMS & PROCEDURES

(Document No. PS:MSX:F&P)

BHARAT HEAVY ELECTRICALS
LIMITED



FORMS & PROCEDURES

INDEX

SN	Description	Form No	Remarks
1.0	Forms		
1.1	Offer forwarding Letter/Submission of Tender	F-1 (Rev 00)	
1.2	Declaration by Authorised Signatory	F-2 (Rev 00)	
1.3	No Deviation Certificate	F-3 (Rev 00)	
1.4	Declaration confirming knowledge about Site Conditions	F-4 (Rev 00)	
1.5	Declaration for relation in BHEL	F-5 (Rev 00)	
1.6	Non Disclosure Certificate	F-6 (Rev 00)	
1.7	Bank Account Details for E-Payment	F-7 (Rev 00)	
1.8	Form for seeking clarifications	F-8 (Rev 00)	
1.9	Capacity Evaluation of Bidder for current Tender	F-9 (Rev 00)	
1.10	Contract Agreement	F-10 (Rev 00)	
1.11	Bank Guarantee Bond (in lieu of Security Deposit)	F-11 (WAM-22)	Revised
1.12	Bank Guarantee for Interest Bearing Refundable Advance	F-12 (Rev 00)	
1.13	Extension of Validity of Bank Guarantee	F-13 (Rev 00)	
1.14	Monthly Plan & Review with Contractors	F-14 (Rev 01)	Revised
1.15	Monthly Performance Evaluation of Contractor	F-15 (Rev 03)	Revised
1.16	Evaluation of Contractor Performance (Quarterly)	F-16 (Rev 00)	Deleted
1.17	Evaluation of Contractor Performance (Annual)	F-17 (Rev 01)	Under revision ##
1.18	Evaluation of Contractor Performance for the Contract (Overall)	F-18 (Rev 01)	Under revision ##

FORMS & PROCEDURES

SN	Description	Form No	Remarks
1.19	Milestone Completion Certificate	F-19 (Rev 00)	
1.20	Completion Certificate	F-20 (Rev 01)	Revised
1.21	Indemnity Bond	F-21 (Rev 00)	
1.22	Consortium Agreement	F-22 (Rev 00)	
1.23	Claim for Refund of Security Deposit	F-23 (WAM-10)	Revised
1.24	Refund of Guarantee Money	F-24 (Rev 00)	
1.25	Power of Attorney for Submission of Tender/Signing Contract Agreement	F-25 (Rev 00)	
1.26	Analysis of Unit Rates Quoted	F-26 (Rev 00)	
1.27	Running Account Bill	F-27 (WAM-06)	Revised
1.28	Final Bill	F-28 (WAM-07)	Revised
1.29	Bank Guarantee Bond Earnest Money (if applicable)	F-29 (WAM-23)	New
1.30	Statement of Claims/ Counter Claims to be submitted to the IEC by both the parties	F-30	
1.31	Format for Notice Invoking Conciliation clause by BHEL for referring the disputes to conciliation through IEC	F-31	
1.32	Format for Notice Invoking Conciliation clause by a stakeholder for referring the disputes to conciliation through IEC	F-32	
1.33	Format for intimation to the stakeholder about appointment of Conciliator/ IEC	F-33	
1.34		VOID	
1.35	PROFORMA OF BANK GUARANTEE (in lieu of RETENTION AMOUNT)	F-35	New
2.0	Procedures		
2.1	Procedure and Business Rules for Reverse Auction	As per Company Policy	
2.2	Integrity Pact	As per Company Policy	
2.3	Procedure for conduct of Conciliation Proceedings	As per BHEL Conciliation Scheme (New)	
3.0	Customer specific procedures		
3.1			

: will be released later

OFFER FORWARDING LETTER / TENDER SUBMISSION LETTER
(To be typed and submitted in the Letter Head of the Company/Firm of Bidder)

Offer Reference No:.....

Date:.....

To,

(Write Name & Address of Officer of BHEL inviting the Tender)

Dear Sir,

Sub : Submission of Offer against Tender Specification No:

I/We hereby offer to carry out the work detailed in the Tender Specification issued by Bharat Heavy Electricals Limited, Power Sector-....., in accordance with the terms and conditions thereof.

I/We have carefully perused the following listed documents connected with the above work and agree to abide by the same.

1. Amendments/Clarifications/Corrigenda/Errata/etc issued in respect of the Tender documents by BHEL
2. Notice Inviting Tender (NIT)
3. Price Bid
4. Technical Conditions of Contract
5. Special Conditions of Contract
6. General Conditions of Contract
7. Forms and Procedures

Should our Offer be accepted by BHEL for Award, I/we further agree to furnish 'Security Deposit' for the work as provided for in the Tender Conditions within the stipulated time as may be indicated by BHEL.

I/We further agree to execute all the works referred to in the said Tender documents upon the terms and conditions contained or referred to therein and as detailed in the appendices annexed thereto.

I/We have deposited/depositing herewith the requisite Earnest Money Deposit (EMD) as per details furnished in the Check List.

Authorised Representative of Bidder

Signature :

Name :

Address :

Place:

Date:

DECLARATION BY AUTHORISED SIGNATORY OF BIDDER

(To be typed and submitted in the Letter Head of the Company/Firm of Bidder)

To,

(Write Name & Address of Officer of BHEL inviting the Tender)

Dear Sir,

Sub : **Declaration by Authorised Signatory**

Ref : 1) NIT/Tender Specification No:,

2) All other pertinent issues till date

I/We, hereby certify that all the information and data furnished by me with regard to the above Tender Specification are true and complete to the best of my knowledge. I have gone through the specifications, conditions, stipulations and all other pertinent issues till date, and agree to comply with the requirements and Intent of the specification.

I further certify that I am authorised to represent on behalf of my Company/Firm for the above mentioned tender and a valid Power of Attorney to this effect is also enclosed.

Yours faithfully,

(Signature, Date & Seal of Authorized
Signatory of the Bidder)

Date:

Enclosed : Power of Attorney

NO DEVIATION CERTIFICATE

(To be typed and submitted in the Letter Head of the Company/Firm of Bidder)

To,

(Write Name & Address of Officer of BHEL inviting the Tender)

Dear Sir,

Sub : **No Deviation Certificate**

Ref : 1) NIT/Tender Specification No:,

2) All other pertinent issues till date

We hereby confirm that we have not changed/ modified/materially altered any of the tender documents as downloaded from the website/ issued by BHEL and in case of such observance at any stage, it shall be treated as null and void.

We also hereby confirm that we have neither set any Terms and Conditions and nor have we taken any deviation from the Tender conditions together with other references applicable for the above referred NIT/Tender Specification.

We further confirm our unqualified acceptance to all Terms and Conditions, unqualified compliance to Tender Conditions, Integrity Pact (if applicable) and acceptance to Reverse Auctioning process.

We confirm to have submitted offer in accordance with tender instructions and as per aforesaid references.

Thanking you,

Yours faithfully,

(Signature, date & seal of authorized representative of the bidder)

DECLARATION CONFIRMING KNOWLEDGE ABOUT SITE CONDITIONS

(To be typed and submitted in the Letter Head of the Company/Firm of Bidder)

To,

(Write Name & Address of Officer of BHEL inviting the Tender)

Dear Sir,

Sub : **Declaration confirming knowledge about Site conditions**

Ref : 1) NIT/Tender Specification No:,

2) All other pertinent issues till date

I/We, _____ hereby declare and confirm that we have visited the Project Site as referred in BHEL Tender Specifications and acquired full knowledge and information about the Site conditions including Wage structure, Industrial Climate, the Law & Order and other conditions prevalent at and around the Site. We further confirm that the above information is true and correct and we shall not raise any claim of any nature due to lack of knowledge of Site conditions.

I/We, hereby offer to carry out work as detailed in above mentioned Tender Specification, in accordance with Terms & Conditions thereof.

Yours faithfully,

(Signature, Date & Seal of Authorized
Representative of the Bidder)

Date :

Place:

DECLARATION FOR RELATION IN BHEL

(To be typed and submitted in the Letter Head of the Company/Firm of Bidder failing which the offer of Bidder is liable to be summarily rejected)

To,

(Write Name & Address of Officer of BHEL inviting the Tender)

Dear Sir,

Sub : **Declaration for relation in BHEL**

Ref : 1) NIT/Tender Specification No:

I/We hereby submit the following information pertaining to relation/relatives of Proprieter/Partner(s)/Director(s) employed in BHEL

Tick(✓) any one as applicable:

1. The Proprieter, Partner(s), Director(s) of our Company/Firm DO NOT have any relation or relatives employed in BHEL

OR

2. The Proprieter, Partner(s), or Director(s) of our Company/Firm HAVE relation/relatives employed in BHEL and their particulars are as below:

(i)

(ii)

Signature of the Authorised Signatory

Note:

1. Attach separate sheet, if necessary.
2. If BHEL Management comes to know at a later date that the information furnished by the Bidder is false, BHEL reserves the right to take suitable against the Bidder/Contractor.

NON DISCLOSURE CERTIFICATE

(To be typed and submitted in the Letter Head of the Company/Firm of Bidder)

NON DISCLOSURE CERTIFICATE

I/We understand that BHEL PS ___ is committed to Information Security Management System as per their Information Security Policy.

Hence, I/We M/s.....
who are submitting offer for providing services to BHEL PS ___ against Tender Specification No: _____,
hereby undertake to comply with the following in line with Information Security Policy of BHEL PS ____, _____

- To maintain confidentiality of documents & information which shall be used during the execution of the Contract.

- The documents & information shall not be revealed to or shared with third party which shall not be in the business interest of BHEL PS__.

(Signature, date & seal of Authorized Signatory of the bidder)

Date:

BANK ACCOUNT DETAILS FOR E-PAYMENT

(To be given on Letter head of the Company /Firm of Bidder, and **ENDORSED (SIGNED & STAMPED) BY THE BANK** to enable BHEL release payments through Electronic Fund Transfer (EFT/RTGS)

1. Beneficiary Name :
2. Beneficiary Account No. :
3. Bank Name & Branch :
4. City/Place :
5. 9 digit M ICR Code of Bank Branch :
6. IFSC Code of Bank Branch :
7. Beneficiary E-mail ID :
(for payment confirmation)

NOTE: In case Bank endorsed certificate regarding above has already been submitted earlier, Kindly submit photocopy of the same

FORMAT FOR SEEKING CLARIFICATION

(To be typed and submitted in the Letter Head of the Company/Firm of Bidder)

To,

(Write Name & Address of Officer of BHEL inviting the Tender)

Dear Sir,

Sub : **Request for Clarification**

Ref : 1) NIT/Tender Specification No:,

2) All other pertinent issues till date

Sl no	Reference clause of Tender Document	Existing provision	Bidder's query	BHEL's clarification
1				
2				
3				
4				
5				
6				

Yours faithfully,

(Signature, date & seal of Authorized Representative of the Bidder)

CAPACITY EVALUATION OF BIDDERS FOR CURRENT TENDER

SL NO.	DESCRIPTION OF WORK (Similar to Tendered Scope)	WORK ORDER REF & DATE	CONTRACT VALUE (Rs. LACS)	CUSTOMER NAME & ADDRESS	CURRENT STATUS OF THE JOB ALONG WITH LATEST MILE STONE COMPLETED	%AGE OF WORK COMPLETE D	VALUE OF BALANCE WORK (Rs. Lacs)
1							
2							
3							
4							
5							
6							
7							
8							
9							
10							

NOTES:

1. BIDDERS ARE REQUIRED TO FURNISH ALL THE JOBS OF SIMILAR NATURE WHICH THEY ARE EXECUTING (IN PROGRESS) AT THE TIME OF SUBMISSION OF TENDER, AS PER ABOVE FORMAT.
2. BIDDERS HEREBY UNDERTAKE THAT THEY HAVE FURNISHED THE DETAILS SOUGHT AS PER POINT NO. 1 IN TOTALITY AND THAT THE DETAILS FURNISHED IS COMPLETE IN ALL RESPECT.
3. BHEL WILL TAKE APPROPRIATE ACTION AS DEEMED FIT , IN CASE, IT IS FOUND AT A LATER DATE THAT THE CONTRACTOR HAD SUPPRESSED THE FACTS AND HAVE NOT FURNISHED THE CORRECT & COMPLETE INFORMATIONS.

DATE :
PLACE:

Signature

Name, Designation & Seal of Bidder

CONTRACT AGREEMENT

Form No: F-10 (Rev 00)

BHARAT HEAVY ELECTRICALS LIMITED

(A Government of India Undertaking)

Power Sector – Region

.....
.....

CONTRACT AGREEMENT

AGREEMENT NO. _____

NAME OF WORK	
NAME OF THE CONTRACTOR WITH FULL ADDRESS	
VALUE OF WORK AWARDED	
LETTER OF INTENT NO.	
TIME ALLOTTED FOR COMPLETING THE WORK (DATE OF COMPLETION)	

SIGNATURE OF CONTRACTOR

(SIGNATURE OF BHEL OFFICER)

CONTRACT AGREEMENT

Form No: F-10 (Rev 00)

CONTRACT AGREEMENT

THIS AGREEMENT MADE THIS _____ DAY OF _____ between BHARAT HEAVY ELECTRICALS LIMITED (A Government of India Enterprise) a Company incorporated under the Companies Act, 1956, having its Registered Office at BHEL House, Siri Fort New Delhi-110049 (herein after called BHEL) of the ONE PART.

AND

M/S _____
_____ (hereinafter called the `Contractor') of the
SECOND PART.

WHEREAS M/s -----state that they
have acquired and possess extensive experience in the field of -----

And Whereas in response to an Invitation to Tender No. ----- issued by BHEL for
execution of ----- the contractor submitted their offer
No.-----dated -----And whereas BHEL has accepted the
offer of the Contractor on terms and conditions specified in the Letter of Intent No.-----
-----dated -----read with the references cited therein.

THIS AGREEMENT WITNESSES AND it is hereby agreed by and between the parties as follows:

1. That the contractor shall execute the work of -----and more particularly described in Tender Specification No -----including Drawings and Specifications (hereinafter called the said works) in accordance with and subject to terms and conditions contained in these presents, instructions to Tenderers, General Conditions of Contract, Special Conditions, Annexures, Letter of Intent dated ----- and such other instructions, Drawings, Specifications given to him from time to time by BHEL.
2. The Contractor is required to furnish to BHEL Security deposit in the form of cash/ approved securities/ Bank Guarantee valid upto ----- for a sum of Rs.----- towards satisfactory performance and completion of the Contract.
3. The Contractor has furnished a Bank Guarantee bearing no.-----dated ----- for a sum of Rs.-----executed by ----- in favour of BHEL towards Security Deposit valid upto -----

OR

The Contractor has furnished to BHEL an initial Security Deposit of Rs.-----in the form of cash / approved Securities/ B.G No.----- dated ----- for Rs.-----executed by ----- in favour of BHEL valid upto ----- and has agreed for recovery of the balance security deposit by BHEL @ 10% of the value of work done from each running bill till the entire Security Deposit is recovered.

OR

The contractor has furnished to BHEL an initial Security Deposit of Rs.-----(Rs.-----vide Bank draft No.-----dated -----and by adjusting EMD of Rs.----- submitted vide Bank draft No.----- dt.-----) and has agreed for recovery of balance Security Deposit by BHEL @ 10% of the value of work done from each running bill till the entire security deposit is recovered.

CONTRACT AGREEMENT

Form No: F-10 (Rev 00)

4. The Contractor hereby agrees to extend the validity of the Bank Guarantee for such further period or periods as may be required by BHEL and if the Contractor fails to obtain such extension(s) from the Bank, the Contractor, shall pay forthwith or accept recovery of Rs.----- from the bills in one installment and the contractor further agrees that failure to extend the validity of the Bank Guarantee or failure to pay the aforesaid amount in the manner specified above shall constitute breach of contract. In addition to above, BHEL shall be entitled to take such action as deemed fit and proper for recovering the said sum of Rs.-----

OR

In case the contractor furnishes the bank guarantee at a later date the contractor hereby agrees to extend the validity of bank guarantee for such further period or periods as may be required by BHEL and if the contractor fails to obtain such extension(s) from the bank, the contractor shall pay forthwith or accept recovery of the amount of bank guarantee given in lieu of security deposit from the bills in one installment and the contractor further agrees that failure to extend the validity of bank guarantee or failure to pay the aforesaid amount in the manner specified above shall constitute breach of contract. In addition to above, BHEL shall be entitled to take such action as deemed fit and proper for recovering the said sum.

5. That in consideration of the payments to be made to the Contractor by BHEL in accordance with this Agreement the Contractor hereby covenants and undertakes with BHEL that they shall execute, construct, complete the works in conformity, in all respects, with the terms and conditions specified in this Agreement and the documents governing the same.
6. That the Contractor shall be deemed to have carefully examined this Agreement and the documents governing the same and also to have satisfied himself as to the nature and character of the Works to be executed by him.
7. That the Contractor shall carry out and complete the execution of the said works to the entire satisfaction of the Engineer or such other officer authorised by BHEL, within the agreed time schedule, the time of completion being the essence of the Contract.
8. That BHEL shall, after proper scrutiny of the bills submitted by the Contractor, pay to him during the progress of the said works such sum as determined by BHEL in accordance with this Agreement.
9. That this Agreement shall be deemed to have come into force from ----- the date on which the letter of intent has been issued to the Contractor.
10. That whenever under this contract or otherwise, any sum of money shall be recoverable from or payable by the Contractor, the same may be deducted in the manner as set out in the General Conditions of Contract or other conditions governing this Agreement.
11. That all charges on account of Octroi, Terminal and other taxes including sales tax or other duties on material obtained for execution of the said works shall be borne and paid by the Contractor.
12. That BHEL shall be entitled to deduct from the Contractor's running bills or otherwise Income Tax under Section 194 (C) of the Income Tax Act, 1961.
13. That BHEL shall be further entitled to recover from the running bills of the Contractor or otherwise such sum as may be determined by BHEL from time to time in respect of

CONTRACT AGREEMENT

Form No: F-10 (Rev 00)

consumables supplied by BHEL, hire charges for tools and plants issued (Where applicable) and any other dues owed by the Contractor.

14. That it is hereby agreed by and between the parties that non-exercise, forbearance or omission of any of the powers conferred on BHEL and /or any of its authorities will not in any manner constitute waiver of the conditions hereto contained in these presents and the liability of the Contractor with respect to compensation payable to BHEL or Contractor's obligations shall remain unaffected.

15. It is clearly understood by and between the parties that in the event of any conflict between the Letter of Intent and other documents governing this Agreement, the provisions in the Letter of Intent shall prevail.

16. The following documents

1. Invitation to Tender No-----
and the documents specified therein.

2. Contractor's Offer No-----
dated-----.

3. _____

4. _____

5. _____

6. Letter of Intent No _____ dated _____.

7. _____

shall also form part of and govern this Agreement.

IN WITNESS HEREOF, the parties hereto have respectively set their signatures in the presence of

WITNESS

1.

2.

(CONTRACTOR)
(to be signed by a person holding
a valid Power of Attorney)

WITNESS

1.

2.

(For and on behalf of BHEL)

**PROFORMA OF BANK GUARANTEE
(in lieu of SECURITY DEPOSIT)**

BANK GUARANTEE (in lieu of SECURITY DEPOSIT)

In consideration of Bharat Heavy Electricals Limited (hereinafter referred to as the 'Employer' which expression shall unless repugnant to the context or meaning thereof, include its successors and permitted assigns) incorporated under the Companies Act, 1956 and having its registered office at _____¹ through its Unit at.....(name of the Unit) having agreed to exempt (Name of the Vendor / Contractor / Supplier) with its registered office at _____² (hereinafter called the said "Contractor" which term includes supplier), from demand under the terms and conditions of the Contract reference No. _____ dated _____³ valued at Rs.⁴ (Rupees -)⁴ (hereinafter called the said Contract), of Security Deposit for the due fulfilment by the said Contractor of the terms and conditions contained in the said Contract, on production of a Bank Guarantee for Rs. _____⁵ (Rupees _____ only),

We _____ (indicate the name and address of the Bank) having its Head Office at _____ (address of the head Office) (hereinafter referred to as the Bank), at the request of _____ [Contractor(s)], being the Guarantor under this Guarantee, do hereby irrevocably and unconditionally undertake to forthwith and immediately pay to the Employer, an amount not exceeding Rs. _____ without any demur, immediately on demand from the Employer and without any reservation, protest, and recourse and without the Employer needing to prove or demonstrate reasons for its such demand

Any such demand made on the bank, shall be conclusive as regards the amount due and payable by the Bank under this guarantee. However, our liability under this guarantee shall be restricted to an amount not exceeding Rs. _____.

We undertake to pay to the Employer any money so demanded notwithstanding any dispute or disputes raised by the Contractor(s) in any suit or proceeding pending before any Court or Tribunal or Arbitrator or any other authority, our liability under this present being absolute and unequivocal.

The payment so made by us under this guarantee shall be a valid discharge of our liability for payment hereunder and the Contractor(s) shall have no claim against us for making such payment.

We, further agree that the guarantee herein contained shall remain in full force and effect during the period that would be taken for the performance of the said Contract and that it shall continue to be enforceable till all the dues of the Employer under or by virtue of the said Contract have been fully paid and its claims satisfied & the Employer certifies that the terms and conditions of the said Contract have been fully and properly carried out by the said contractor(s) or acceptance of the final bill or discharge of this guarantee by the Employer, whichever is earlier. This guarantee shall initially remain in force upto and including _____⁶ and shall be extended from time to time for such period as may be desired by the Employer. Unless a demand or claim under this guarantee is made on us in writing on or before the _____⁷, we shall be discharged from all the liability under this guarantee thereafter.

We, _____ (indicate the name of the Bank) further agree with the Employer that the Employer shall have the fullest liberty without our consent and without affecting in any manner our obligations hereunder to vary any of the terms and conditions of the said Contract or to extend time of performance by the said contractor(s) from time to time or to postpone for any time or from time to time any of the powers exercisable by the Employer against the said contractor(s) and to forbear or enforce any of the terms and conditions relating to the said Contract and we shall not be relieved from our liability by any reason of any such variation or extension being granted to the said contractor(s) or for any forbearance, act or omission on the part of the Employer or any indulgence by the Employer to the said contractor(s) or by any such matter or thing whatsoever which under the law relating to sureties would but for this provision have effect of so relieving us.

The Bank also agrees that the Employer at its option shall be entitled to enforce this Guarantee against the Bank as a principal debtor, in the first instance without proceeding against the Contractor and notwithstanding any security or other guarantee that the Employer may have in relation to the Contractor's liabilities.

This Guarantee shall not be determined or affected by liquidation or winding up, dissolution or change of constitution or insolvency of the Contractor but shall in all respects and for all purposes be binding and operative until payment of all money payable to the Employer in terms thereof. This guarantee will not be discharged due to the change in the constitution of the Bank or the Contractor(s).

We, BANK lastly undertake not to revoke this guarantee during its currency except with the previous consent of the Employer in writing.

Notwithstanding anything to the contrary contained hereinabove:

- a) The liability of the Bank under this Guarantee shall not exceed.....⁵

- b) This Guarantee shall be valid up to⁶

- c) Unless the Bank is served a written claim or demand on or before _____⁷ all rights under this guarantee shall be forfeited and the Bank

shall be relieved and discharged from all liabilities under this guarantee irrespective of whether or not the original bank guarantee is returned to the Bank.

We, _____ Bank, have power to issue this Guarantee under law and the undersigned as a duly authorized person has full powers to sign this Guarantee on behalf of the Bank.

Date _____ Day of _____
for _____ (indicate the name of the Bank) _____

(Signature of Authorised signatory)

- ¹ ADDRESS OF THE EMPLOYER. I.e Bharat Heavy Electricals Limited
- ² ADDRESS OF THE VENDOR /CONTRACTOR / SUPPLIER .
- ³ DETAILS ABOUT THE NOTICE OF AWARD/CONTRACT REFERENCE
- ⁴ CONTRACT VALUE
- ⁵ BG AMOUNT IN FIGURES AND WORDS
- ⁶ VALIDITY DATE
- ⁷ DATE OF EXPIRY OF CLAIM PERIOD

Note:

1. Units are advised that expiry of claim period may be kept 3-6 months after validity date. It may be ensured that the same is in line with the agreement/ contract entered with the Vendor.
 2. The BG should be on Non-Judicial Stamp paper/e-stamp paper of appropriate value as per Stamp Act prevailing in the State(s) where the BG is submitted or is to be acted upon or the rate prevailing in the State where the BG was executed, whichever is higher. The Stamp Paper/e-stamp paper shall be purchased in the name of Vendor/Contractor/Supplier /Bank issuing the guarantee.
 3. In line with the GCC, SCC or contractual terms, Unit may carry out minor modifications in the Standard BG Formats. If required, such modifications may be carried out after taking up appropriately with the Unit/Region's Law Deptt.
- 4. In Case of Bank Guarantees submitted by Foreign Vendors-**
- a. **From Nationalized/Public Sector / Private Sector/ Foreign Banks (BG issued by Branches in India)** can be accepted subject to the condition that the Bank Guarantee should be enforceable in the town/city or at nearest branch where the Unit is located i.e. Demand can be presented at the Branch located in the town/city or at nearest branch where the Unit is located.
 - b. **From Foreign Banks (wherein Foreign Vendors intend to provide BG from local branch of the Vendor country's Bank)**
 - b.1 In such cases, in the Tender Enquiry/ Contract itself, it may be clearly specified that Bank Guarantee issued by **any of the Consortium Banks only** will be accepted by BHEL. As such, Foreign Vendor needs to make necessary arrangements for issuance of Counter- Guarantee by Foreign Bank in favour of the Indian Bank's (BHEL's Consortium Bank) branch in India. It is advisable that all charges for issuance of Bank Guarantee/ counter- Guarantee should be borne by the Foreign Vendor. The tender stipulation should clearly specify these requirements.
 - b.2 In case, Foreign Vendors intend to provide BG from Overseas Branch of our Consortium Bank (e.g. if a BG is to be issued by SBI Frankfurt), the same is acceptable. However, the procedure at **sl.no. b.1** will required to be followed.
 - b.3 The BG issued may preferably be subject to Uniform Rules for Demand Guarantees (URDG) 758 (as amended from time to time). The BG Format provided to them should clearly specify the same.

BANK GUARANTEE FOR INTEREST BEARING REFUNDABLE ADVANCE

B.G. No.

Date

This deed of Guarantee made this _____ day of _____ two thousand _____ by < Name and Address of Bank > hereinafter called the "The Guarantor" (which expression shall unless repugnant to the context or meaning thereof be deemed to include its successors and assigns) in favour of M/S Bharat Heavy Electricals Limited a Company incorporated under the Companies Act, 1956, having its registered office at BHEL House, Siri Fort, New Delhi - 110049 through its unit at Bharat Heavy Electricals Limited, Power Sector Western Region, Shree Mohini Complex, 345 Kingsway, Nagpur 440 001, hereinafter called "The Company" (which expression shall unless repugnant to the context or meaning thereof be deemed to include its successors and assigns).

WHEREAS M/s. _____ (hereinafter referred to as the Contractor) have entered into a Contract arising out of Letter of Intent no. _____ dtd _____ (hereinafter referred to as "the Contract") for the < Name of work > with the Company.

AND WHEREAS the Contract inter-alia provides that the Company will pay to the Contractor interest bearing advance of Rs. _____ (Rupees _____ only) on certain terms and conditions specified in the Contract subject to the Contractor furnishing a Bank Guarantee for Rs. _____ (Rupees _____ only) in favour of the Company.

AND WHEREAS the Company has agreed to accept a Bank Guarantee from a Bank to cover the said advance.

AND WHEREAS the Contractor has approached the Guarantor and in consideration of the arrangement arrived at between the Contractor and the Guarantor, the Guarantor has agreed to give the Guarantee as hereinafter mentioned in favour of the Company.

NOW THIS DEED WITNESSES AS FOLLOWS:-

- (1) In consideration of the Company having agreed to advance a sum of Rs. _____ (Rupees _____ only) to the Contractor, the Guarantor do hereby guarantee the due recovery by the Company of the said advance with interest thereon as provided according to the terms and conditions of the Contract. If the said Contractor fails to utilise the said advance for the purpose of the Contract and /or the said advance together with interest as aforesaid is not fully recovered by the Company the Guarantor do hereby unconditionally and irrevocably undertake to pay to the Company without demur and merely on a demand, to the extent of the said sum of Rs. _____ (Rupees _____ only) any claim made by the Company on them for the loss or damage caused to or suffered by the Company by reasons of the Company not being able to recover in full the advance with interest as aforesaid.

BANK GUARANTEE FOR INTEREST BEARING REFUNDABLE ADVANCE

-
- (2) The decision of the Company whether the Contractor has failed to utilise the said advance or any part thereof for the purpose of the Contract and / or as to the extent of loss or damage caused to or suffered by the Company by reason of the Company not being able to recover in full the said sum of Rs. _____ with interest if any shall be final and binding on the Guarantor, irrespective of the fact whether the Contractor admits or denies the default or questions the correctness of any demand made by the Company in any Court Tribunal or Arbitration proceedings or before any other Authority.
- (3) The Company shall have the fullest liberty without affecting in any way the liability of the Guarantor under this Guarantee, from time to time to vary any of the terms and conditions of the Contract or extend time of performance by the Contractor or to postpone for any time and from time to time any of the powers exercisable by it against the Contractor and either enforce or forebear from enforcing any of the terms and conditions governing the Contract or securities available to the Company and the Guarantor shall not be released from its liability under these presents by any exercise by the Company of the liberty with reference to the matters aforesaid or by reasons of time being given to the Contractor or any other forbearance, act or commission on the part of the Company or any indulgence by the Company to the Contractor or of any other matter or thing whatsoever which under the law relating to sureties would, but for this provision have the effect of so releasing the Guarantor from its liability under this guarantee.
- (4) The Guarantor further agrees that the Guarantee herein contained shall remain in full force and effect during the period till the Company discharges this Guarantee, subject to however, that the Company shall have no claim under this Guarantee after _____ i.e. (the present date of validity of Bank Guarantee unless the date of validity of this Bank Guarantee is further extended from time to time, as the case may be) unless a notice of the claim under this Guarantee has been served on the Guarantor before the expiry of the said period in which case the same shall be enforceable against the Guarantor not withstanding the fact that the same is enforced after the expiry of the said period.
- (5) The Guarantor undertakes not to revoke this Guarantee during the period it is in force except with the previous consent of the Company in writing and agrees that any liquidation or winding up or insolvency or dissolution or any change in the constitution of the Contractor or the Guarantor shall not discharge the Guarantor's liability hereunder.
- (6) It shall not be necessary for the Company to proceed against the Contractor before proceeding against the Guarantor and the Guarantee herein contained shall be enforceable against them notwithstanding any security which the Company may have obtained or obtain from the Contractor shall at the time when proceedings are taken against the Guarantor hereunder be outstanding or unrealised.
- (7) Notwithstanding anything contained herein before, our liability under the Guarantee is restricted to Rs. _____ (Rupees _____). Our guarantee shall remain in force until _____, i.e. the present date of validity of Bank Guarantee unless the date of validity of this Bank Guarantee is further extended from time to time. Unless a claim or demand under this guarantee is made against us on or before-----, we shall be discharged from our liabilities under this Guarantee thereafter.

BANK GUARANTEE FOR INTEREST BEARING REFUNDABLE ADVANCE

(8) Any claim or dispute arising under the terms of this document shall only be enforced or settled in the courts at Nagpur only.

(9) The Guarantor hereby declares that it has power to execute this Guarantee under its Memorandum and Articles of Association and the executant has full powers to do so on its behalf under the Power of Attorney dated _____ (To be incorporated by the Bank) granted to him by the proper authorities of the Guarantor.

IN WITNESS whereof the _____(Bank) has hereunto set and subscribed its hand the day, month and year first, above written.

(Name of the Bank)

Signed for and on behalf of the Bank
(Designation of the Authorized Person Signing the Guarantee)

(Signatory No.-----)

DATED:

SEAL

=====
Notes :

1. The BG shall be executed on non-judicial stamp papers of adequate value procured in the name of the Bank in the State where the Bank is located.
2. The BG is required to be sent by the executing Bank directly to BHEL at the address where tender is submitted / accepted, under sealed cover.

FORM for EXTENSION OF VALIDITY OF BANK GUARANTEE

1. To be typed on non judicial Stamp Papers of value as applicable in the State of India from where the BG has been issued or the State of India where the BG shall be operated
2. The non judicial stamp papers shall be purchased in the name of the Party on whose behalf the BG is being issued or the BG issuing Bank

BANK GUARANTEE No:

Date:.....

To

(Write Designation and Address of Officer of BHEL inviting the Tender)

Dear Sir

Sub : Validity of Bank Guarantee No:..... Dated for
..... Rs in favour of yourself, expiry date
....., on account of M/s in respect of
Contract Number....., (herein after called the Original bank Guarantee)

At the request of M/s....., we Bank,
having its branch Office at and having Head office
at, do hereby extend our liability under the above mentioned Bank Guarantee
number..... dated for a further period ofMonths/years
from to expire on

Except as provided above, all other terms and conditions of the Original Bank Guarantee No
..... Dated..... shall remain unaltered and binding on us.

Kindly treat this extension as an integral part of the original Bank Guarantee to which it
would be attached.

Yours faithfully

Signature.....
Name & Designation.....
Power of Attorney/Signing Power No
Seal of Bank

INDEMNITY BOND

(To be executed on a Non Judicial Stamp Paper of the requisite value as per Stamp Duty prevalent in the respective State)

 This Indemnity Bond executed by <name of company> having their Registered Office at <xxxxxxxxxxx> in favour of M/s Bharat Heavy Electricals Limited, a Company incorporated under the Companies Act, 1956, having its Registered Office at BHEL House, Siri Fort, Asiad, New Delhi - 110049 through its Unit at Power Sector-_____ Region, _____, _____ State. (Hereinafter referred to as the Company)

And whereas the Company has entered into a Contract with M/s xxxxxxxxx, the executants of this Deed (hereinafter referred to as the Contractor) as its contractor in respect of the work of "XXXXXXXXXXXXXXXXXXXXXXXXXXXX".

AND WHEREAS under the provisions of GCC further stipulates that the Contractor shall indemnify the Company against all claims of whatever nature arising during the course of execution of Contract including defects liability period of <xx Months > i.e till <xx xx xxxx>

Now this deed witness that in case the Company is made liable by any Authority including Court to pay any claim or compensation etc. in respect of all labourers or other matters at any stage under or relating to the Contract with the Contractor, the Contractor hereby covenants and agrees with the Company that they shall indemnify and reimburse the Company to the extent of such payments and for any fee, including litigation charges, lawyers' fees, etc, penalty or damages claimed against the Company by reason of the Contractor falling to comply with Central/States Laws, Rules etc, or his failure to comply with Contract (including all expenses and charges incurred by the Company).

The Contractor further indemnifies the Company for the amount which the Company may be liable to pay by way of penalty for not making deductions from the Bills of the Contractor towards such amount and depositing the same in the Government Treasury.



PS-

MONTHLY PLAN & REVIEW WITH CONTRACTOR

Page 1 of 6

Name of Project		Contract No.	
Name of Work		Name of Contractor	

PART- A: PLAN/ REVIEW OF WORK FOR THE MONTH OF

Date of Plan/ Review.....

SN.	Description of Work	Unit of Measurement	Unit Rate	Planned		Cumulative Shortfall attributable to contractor upto last month (Refer Note 1)		Contractor Shortfall Planned for execution in current month (Out of B)		Achieved		Shortfall attributable to BHEL w.r.t Plan (as per Col. 3 of Part-D)		Cumulative Shortfall attributable to Contractor upto & including this month		REMARKS (Reasons for Shortfall attributable to Contractor. Supporting documents to be kept as record.)
				(QTY Planned for the month as per Part –C of last month)		B		b'		C		D		E=A+B-C-D		
(a)	(b)	(c)	(d)	A		B		b'		C		D		E=A+B-C-D		
				Phy.	Financial	Phy	Financial	Phy	Financial	Phy.	Financial	Phy.	Financial	Phy.	Financial	
	Value of Other Items not mentioned above but planned to be executed in this month															
Total					ΣA		ΣB		Σb'		ΣC		ΣD		ΣE	

Remark for planning 'Contractor Shortfall Planned for execution in current month(b')' lesser than 'Cumulative Shortfall attributable to contractor upto last month(B)'

- 1.....
- 2.....
- 3.....

BHEL
(Sign with name, designation and date)

CONTRACTOR
(Sign with name, designation and date)

 PS-	MONTHLY PLAN & REVIEW WITH CONTRACTOR	Page 2 of 6
---	---------------------------------------	-------------

Name of Project		Contract No.	
Name of Work		Name of Contractor	

PART- A: Contd.....

Note 1: In addition to the work planned as per Col. 'A', Contractor shall also make full efforts to minimize the 'Cumulative shortfall attributable to contractor upto the month' as mentioned in Col. 'B' by enhancing its resources, so as to achieve the completion of activities as per agreed schedule. In case contractor is not able to execute the entire shortfall, then BHEL 'Engineer in-charge', shall decide the priority of work to be executed and it shall be binding on the contractor.

Note 1a: In continuation to above, it may be noted that $\Sigma b'$ has been worked out based on the commitment of contractor to mobilise resources and liquidate the backlog attributable to them. This does not absolve the contractor of their responsibility to liquidate the entire backlog attributable to them.

Note 2: Percentage Shortfall attributable to contractor w.r.t. "Plan - Shortfall attributable to BHEL" for the month = $[(\Sigma E - \Sigma B) / (\Sigma A - \Sigma D)] \times 100$
 In case, $(\Sigma E - \Sigma B)$ is negative, then it shall be treated as zero percent."

Percentage achievement during the month w.r.t. "Plan + Contractor Shortfall Planned - Shortfall attributable to BHEL" for the month = $\frac{\Sigma C \times 100}{(\Sigma A + \Sigma b' - \Sigma D)}$

Note 3: Form 14 should include all items being planned in the current month, and all items against which shortfall was attributable to contractor till previous month. However, for practical reason, if it is not possible to mention some of the items in Form-14 being planned to be executed in this month, then also value of such items shall necessarily be included in calculation of Total Value.

Note 4: In case reason for shortfall attributable to contractor is w.r.t. T&P and Manpower, it should be in conformity with Part B1 and B2.

BHEL
 (Sign with name, designation and date)

CONTRACTOR
 (Sign with name, designation and date)



MONTHLY PLAN & REVIEW WITH CONTRACTOR

Page 3 of 6

PS-

Name of Project		Contract No.	
Name of Work		Name of Contractor	

PART – B-1: PLAN/REVIEW OF DEPLOYMENT OF MAJOR T&Ps FOR THE MONTH OF

Date of Plan/ Review.....

CONTRACTOR'S SCOPE: -

SN.	PLAN				DEPLOYMENT STATUS			
	Major T&P to be deployed as per work planned for the month	QTY	Deployment Period (in days)	Weightage assigned to planned T&P (in fraction such that $\Sigma C = 1$)	Actual Deployed Quantity	Actual Deployment Period (in days)	Weighted T&P Deployed	REMARKS (Works affected due to non-deployment of T&Ps)
		A	B	C	D	E	$F = (C \times D \times E) / (A \times B)$	

Note: In case, $E > B$, it shall be considered as $E = B$. Similarly, in case $D > A$, it shall be considered as $D = A$.Percentage of T&P Deployed = $\Sigma F \times 100$

BHEL SCOPE: -

SN.	PLAN			DEPLOYMENT STATUS		
	Major T&P to be deployed as per work planned for the month	QTY	Deployment Period (in days)	Actual Deployed Quantity	Actual Deployment Period (in days)	REMARKS (Works affected due to non-deployment of T&Ps)

BHEL

(Sign with name, designation and date)

CONTRACTOR

(Sign with name, designation and date)



PS-

MONTHLY PLAN & REVIEW WITH CONTRACTOR

Page 4 of 6

Name of Project		Contract No.	
Name of Work		Name of Contractor	

PART – B-2: PLAN/ REVIEW OF DEPLOYMENT OF MANPOWER FOR THE MONTH OF

Date of Plan/ Review.....

CONTRACTOR'S SCOPE: -

SN.	Area of Work	Category of Labour	No. of Labour required as per category	Deployment Period (in days)	No. of Labour actually deployed	Actual Deployment Period (in days)	REMARKS (Works affected due to non-availability of labour)
			A	B	C	D	

$$\text{Percentage of Manpower Deployed} = 100 \times \frac{\sum(C \times D)}{\sum(A \times B)}$$

BHEL

(Sign with name, designation and date)

CONTRACTOR

(Sign with name, designation and date)



PS-

MONTHLY PLAN & REVIEW WITH CONTRACTOR

Page 5 of 6

Name of Project		Contract No.	
Name of Work		Name of Contractor	

PART – C: PLAN(PHYSICAL) FOR THE NEXT MONTH i.e.

Date of Plan

SN.	Description of work	Original Planned Quantity	Planned Quantity (excluding shortfalls attributable to contractor till date)	Unit of Measurement	T&Ps Required				Manpower Required		REMARKS (Reasons for difference in Original Planned Quantity w.r.t. Planned quantity to be given)
					Contractor Scope		BHEL Scope		Category of Labour	No. of Labour required as per Category	
					Major T&P to be deployed as per work planned for the month	Quantity	Major T&P to be deployed as per work planned for the month	Quantity			

Note 1: Planned quantity should be based on available/ expected fronts/ inputs in the next month

Note 2: "Original Planned Quantity" shall be as per latest jointly agreed programme between BHEL and Contractor before commencement of work or at the time of latest Time Extension, as the case may be.

BHEL
(Sign with name, designation and date)

CONTRACTOR
(Sign with name, designation and date)



PS-

MONTHLY PLAN & REVIEW WITH CONTRACTOR

Page 6 of 6

Name of Project		Contract No.	
Name of Work		Name of Contractor	

PART – D: REASONS FOR SHORTFALL ATTRIBUTABLE TO BHEL IN RESPECT OF PLAN FOR THE MONTH.....

SN.	Description of Work (from Part-A)	Quantities Affected		Reasons for Shortfall attributable to BHEL	Agency responsible for reasons for Shortfall	Remarks (Supporting Documents in respect of agency responsible)
		(Physical Quantity)	Unit of Measu- rement			
1	2	3	4	5	6	7

Note1: Reasons for shortfall shall include non-availability of fronts/ drawings/ materials/ T&P (BHEL Scope)/ clearances etc. and other hindrances for which contractor is not responsible.

Note2: Agency responsible may be BHEL Site/ MUs/ Design Centre/ BHEL Customer/ other Contractors etc.

BHEL

(Sign with name, designation and date)

MONTHLY PERFORMANCE EVALUATION OF CONTRACTOR

Project		Vendor							Package/Unit:			
SL	Parameter for Measurement	Classification	Level of Achievement					Measurement Key/ Scheduled Date	Supporting Documents	Max Score	Score Obtained	
			0	1	2	3	4					5
1.0 QUALITY									10			
#1.01	Cumulative number of days in the month, the nominated Quality Officer or his authorised nominee was not available	QUALITY	≥ 1	NA	NA	NA	NA	0	Quality Officer or his authorised nominee should be available for all the days of working at site	Daily Log Book entry/ Incident Registers/ letter references	1.5	
#1.02	Percentage submission of test certificates for batches of welding electrodes, cement, sand, aggregate, consumable, Paints etc as applicable for this month OR In case of MM & MH package, monthly checks for Storage/Preservation of material.	QUALITY	< 100%	NA	NA	NA	NA	100%	Submission of 100% Test certificates for materials as per FQP is mandatory. MM & MH package: Storage/Preservation as per manual/procedure.	Daily Log Book entry/ Incident Registers/ letter references	2	
#1.03	Number of incidences of improper storage & preservation (not in accordance to the guidelines of BHEL MUs or approved FQP) of materials, consumables (viz. gases, welding electrodes & fluxes, fuel etc.) & bought-out items (paints, fasteners etc.) under the custody of the contractor	QUALITY	>5	5	4	3	2	≤1	Total number of non-compliances	Daily Log Book entry/ Incident Registers/ letter references	1.5	
#1.04	Delay in preparation & submission of signed protocols / log sheets / site register / NDT test reports as per approved FQP/ Qualified Welder List along with photocopies of Welder ID cards / Welder Performance Evaluation records etc in the month OR in case of MM / MH package reconciliation statement / verification report.	QUALITY	>5	5	4	3	2	≤1	Within 2 days of measurements taken or within first 3 working days of next month, as advised by BHEL Engineer	Daily Log Book entry/ Incident Registers/ letter references	1.5	
#1.05	Number of instances for Major equipment/product failure due to negligence/improper work/poor workmanship by contractor	QUALITY	≥ 1	NA	NA	NA	NA	0	No such event should happen	Daily Log Book entry/ Incident Registers/ letter references	1.5	
#1.06	% failure against any test conducted during the month leading to rework/ loss of time/ money.	QUALITY	>8%	>6% <=8%	>4% <=6%	>2% <=4%	>0 <=2%	0	Failures due to reasons attributable to contractor should be as minimum as possible.	Test reports	2	
2.0 PERFORMANCE									70			
#2.01	Percentage achievement for the month w.r.t. "Fresh Plan + Contractor Shortfall plan - Shortfall attributable to BHEL" as per Form-14.	PERFORMANCE	In proportion to % achievement (Ex. 50% achievement, score obtained=70*50/100=35)					As per Part-A of Form-14		Progress review formats	70	

MONTHLY PERFORMANCE EVALUATION OF CONTRACTOR

SL	Parameter for Measurement	Classificatio	Level of Achievement						Measurement Key/ Scheduled	Supporting Documents	Max	Score
3.0 RESOURCES & SITE MANAGEMENT										5		
#3.01	Cumulative number of days of delay in submission of signed Plan FOR THE MONTH supported by deployment plan of Major T&Ps and Manpower (as per Form F-14 all sections) alongwith all supporting documents viz drawings/ layout plans/ piping schedule and other relevant documents as applicable for individual packages.	PERFORMA NCE	>4	4	3	2	1	0	Number of days delayed from second working day of the month	Form 14/ letter references	1	
#3.02	Cumulative number of days of delay in submission of signed Review FOR PREVIOUS MONTH supported by deployment plan of Major T&Ps and Manpower (as per Form F-14 all sections) alongwith all supporting documents viz drawings/ layout plans/ piping schedule and other relevant documents as applicable for individual packages.	PERFORMA NCE	>4	4	3	2	1	0	Number of days delayed from 7th day of the month	Form 14/ letter references	1	
#3.03	Percentage of timely submission of Daily Reports for Progress of work, Resources, Consumables etc.	PERFORMA NCE	<60%	≥60% < 70%	≥70% < 80%	≥80% < 90%	≥90% < 95%	≥95%	Percentage of timely submission of daily reports/ Scheduled date is successive next day for each day	Daily Log Book entry/ Incident Registers/ letter references	0.5	
#3.04	Number of days delayed in submission of Running bills with complete supporting documents (including updated reconciliation statement of BHEL issued material) for the month, alongwith FQP log sheets / protocols / HR documents / Monthly Progress Reports for the work executed during the month under measurement	PERFORMA NCE	>5	5	4	3	2	≤1	Number of days delayed / Scheduled date is 7th day of next month	Bill submission/ Letter references	0.5	
#3.05	Percentage of Manpower Deployed w.r.t. Plan for the month as per Form-14.	RESOURCES	<50%	≥ 50% ≤60%	> 60% ≤ 70%	> 70% ≤ 80%	> 80% ≤ 90%	> 90%	As per Part-B2 of Form-14	Progress review formats/ Daily Log Book	1	
#3.06	Percentage of T&P Deployed w.r.t. Plan for the month as per Form-14.	RESOURCES	<50%	≥ 50% ≤60%	> 60% ≤ 70%	> 70% ≤ 80%	> 80% ≤ 90%	> 90%	As per Part-B1 of Form-14	Progress review formats/ Daily Log Book entry/Incident Registers/letter references	1	
4.0 SITE INFRASTRUCTURE & SERVICE										5		
#4.01	a) Number of non-compliances during the month for Statutory requirements like validity of Labour Licence, Insurance Policy, Labour Insurance, PF, BOCW Compliance etc and any other applicable laws/ Regulation, Electrical Licence, T&P fitness certificate, Contractors' All Risk Policy etc as applicable b) Number of days delayed in making labour payments for the last month by 7th of this month	SITE INFRASTRUC TURE & SERVICE	≥ 1	NA	NA	NA	NA	< 1	Total number of non-compliances	Daily Log Book entry/ Incident Registers/ letter references	5	

MONTHLY PERFORMANCE EVALUATION OF CONTRACTOR

SL	Parameter for Measurement	Classificatio	Level of Achievement						Measurement Key/ Scheduled	Supporting Documents	Max	Score
5.0 HSE										10		
#5.0	Performance against HSE Parameters (as per Annexure-AA of Form-15)	HSE									10	
Total										100		

Less Deduction in Score Due to Fatal Accidents attributable to the Contractor @ 20 points/ accident	
Less Deduction in Score Due to Major Accidents (Permanent Disability or bodily injury by which person injured is prevented to resume to work within 48 hours or more after accident, Major Damage to Equipment etc.) attributable to the contractor @ 15 points/ accident	
Less Deduction in Score Due to Minor Accidents attributable to the contractor @ 2 points/ accident	
Less Deduction in Score Due to not Maintaining of Labour Colony (if applicable) as per BHEL HSE policy @3 points in a month on verification any day	
Final Score	

Performance Score Summary for the Month	Total Score	Score Obtained
QUALITY	10	
PERFORMANCE	70	
RESOURCES & SITE MANAGEMENT	5	
SITE INFRASTRUCTURE & SERVICE	5	
HSE	10	
Total	100	

Monthly Safety Performance Evaluation of Contractor

SL	Parameter for Measurement	M/O	Mx	Supporting Documents
1a	Induction training for new workers conducted through audio-visual medium & documented?	M	2	Induction Training Records
1b	Tool box talk conducted regularly as per plan, and documented?	M	1	Toolbox Talk Records
1c	Contractor in charge and safety in charge attended safety meetings?	M	2	Minutes of Meeting
1d	Whether observations in safety meetings are complied before next meeting?	M	2	-do-
1e	Preparation and submission of Monthly HSE report within stipulated time	M	1	Report submission date
1f	Preparation and submission of Incident/near-miss report and RCA Report (as applicable) within stipulated time	M	1	Incident/ Near Miss Records
1g	Carrying out Inspections and submission of Inspection reports within stipulated time	M	1	Inspection Records
1h	Regular Job Specific Training ensured for High Risk Workers (through audio-visual medium) as per plan	M	1	Training & Attendance Records
2a	Whether the contractor is registered under BOCW		1	BOCW Registration Certificate
2b	Availability of Qualified safety officer (1 for every 500 labour)	M	2	Safety Officer qualification & experience records
2c	Availability of Qualified safety supervisor (1 for every 100 labour)		2	Safety Officer qualification & experience records
2d	All the workers are provided and using safety helmets and safety shoes/gum boots	M	2	PPE Issue Records, Inspection/ non-conformity records
2e	Housekeeping done on regular basis and scrap removal at site	M	1	Housekeeping records, Inspection/ non-conformity records
2f	Usage of Goggles/Face shields and Hand gloves for gas cutter and grinders		1	PPE Issue Records, Inspection/ non-conformity records
2g	Wall openings & floor openings are guarded?		1	Inspection/ non-conformity records
2h	Adequate illumination provided in all working area?		1	Inspection/ non-conformity records
2i	Safety posters, sign boards and emergency contact numbers in all prominent location are displayed?	M	1	Inspection/ non-conformity records
2j	Availability of automatic reverse horns, Main horn, hook latches for Vehicles, mobile cranes, Hydras		1	Inspection/ non-conformity records
2k	Ban of carrying mobile phones to work place is implemented for workers		1	Inspection/ non-conformity records
2l	Availability of Tags & Inspection Certificates for Cranes of all capacities		1	Master T&P List with internal & external test details
2l.2	Availability of Tags & Inspection Certificates for Winches of all capacities		1	Master T&P List with internal & external test details
2l.3	Availability of Tags & Inspection Certificates, color coding for Chain pulley blocks		1	Master T&P List with internal & external test details
2l.4	Availability of Tags & Inspection Certificates for Vehicles - Trailers, Dozers, Dumpers, Excavators. Mixers etc		1	Master T&P List with internal & external test details

SL	Parameter for Measurement	M/O	Mx	Supporting Documents
2l.5	Availability of Tags & Inspection Certificates for Welding machines, grinders, Drilling machines, etc		1	Master T&P List with internal & external test details
2l.6	Availability of Tags & Inspection Certificates, color coding for Wire rope slings etc		1	Master T&P List with internal & external test details
2l.7	Availability of Tags & Inspection Certificates for Batching plants		1	Master T&P List with internal & external test details
2m.1	Use of Lifting Permit as per requirement		1	Permit Records
2m.2	Use of Height Permit as per requirement		1	Permit Records
2m.3	Use of Hot Work Permit as per requirement		1	Permit Records
2m.4	Use of Excavation permit as per requirement		1	Permit Records
2m.5	Use of Confined space work permit as per requirement		1	Permit Records
2m.6	Use of Grating removal and safety net removal permit as per requirement		1	Permit Records
2m.7	Use of Lockout-Tagout permit as per requirement		1	Permit Records
2m.8	Use of Radiography permit as per requirement		1	Permit Records
2m.9	Use of Night/ Holiday Work Permit as per requirement		1	Permit Records
2m.10	Use of Any other Applicable Permit as per requirement		1	Permit Records
3a	Material safety data sheet (MSDS) available for all chemicals and displayed in usage and storage area?		1	Inspection/ non-conformity records
3b	Spillages of oil/concrete and other chemical is controlled and cleaned by proper method in case of spill?		1	Inspection/ non-conformity records
3c	Availability of adequate number of urinals in workplace and in elevations and maintained	M	1	
3d	Availability of rest rooms for workers at site or alternative arrangement	M	1	
3e	Availability of Drinking water facility at work spot		1	
3f	Hygienic Labour colony is provided for workers.		1	
4a	Is heavy/complex critical lifting permit obtained for heavy, complex materials before handling/erection activity?		1	Work Permit records
4b	Whether area below lifting activities barricaded		1	Inspection/ non-conformity records
4c	Availability of experienced rigging foreman		1	Experience details of rigging foreman
4d	Is agency is following proper storage and handling procedure as per manufacturer standard for all hazardous material?		1	Procedure for storage & handling
4e	Are oxygen and acetylene cylinders are transported to work place from storage area in trolleys		1	
5a	Whether all deep excavation has been protected by barrier		1	Inspection/ non-conformity records
5b	Sloping/benching & shoring provided for excavation as per requirement?		1	-do-
5c	Proper access and egress provided for excavations?		1	-do-
5d	Blasting is done in controlled manner?		2	-do-
6a	Whether Electrical booth is equipped with Co ₂ fire extinguishers and fire buckets filled with sand?		2	Inspection/ non-conformity records
6b	Availability of Illumination lamp in electric booth?		1	-do-
6c	whether Caution Boards have been displayed?		1	-do-
6d	Usage of Metal Plug top for all hand power tools?		1	-do-

SL	Parameter for Measurement	M/O	Mx	Supporting Documents
6e	Usage of Insulated welding cables.		1	-do-
6f	Electrical Booth/Distribution Board to be covered by proper Canopy.		1	-do-
6g	Availability of functional & individual 30ma ELCB / RCCB and MCB for protection and conducting periodical check-up?		1	-do-
6h	Double earthing for panel boards and all machinery & proper earth pit with regular inspection available?		1	-do-
6i	Whether Electrician is qualified and experienced		1	Qualification & Experience records of electrician
6j	Availability and usage of Rubber hand gloves by electrician?		1	Inspection/ non-conformity records
7a	Whether Scaffolding pipes made with steel or aluminium, are being used and checked periodically by experienced/ certified scaffolder?		2	Inspection/ non-conformity records
7b	8mm Stainless Steel wire rope with plastic cladding is provided for life line (Vertical / Horizontal) during height work?		2	-do-
7c	Availability of emergency lighting in case of power failure		1	-do-
7d	Whether all the openings are covered with Safety Nets made of fire proof Nylon?		1	-do-
7e	Whether MS pipe rails around staircases & platforms in usage are provided with top, middle rails and toe guard?		1	-do-
7f	Whether Ladder with vertical life line /Fall arrestor is available to climb?		1	-do-
7g	Whether all workers deployed for working at height have been issued height pass after undergoing vertigo test?		1	Height Pass records
7h	Whether all workers deployed for height work / climbing ladder are provided and using Double lanyard safety belt?		1	PPE Issue records, inspection/ non-conformity reports
7i	Is all hand tools/Small material used by height workers is tied firmly to prevent fall?		1	-do-
8a	Flash back arrestors for all gas cutting sets is available on Torch side and cylinder side		1	Inspection/ non-conformity records
8b	Oxygen/Acetylene/LPG cylinders not in use have caps in place and stored separately?		1	-do-
8c	Availability of Face screen, Hand gloves, and Apron, for welders		1	-do-
8d	Protection from falling hot molten metal during metal cutting / welding at height by providing GI sheet below the cutting area especially in fire prone areas		1	-do-
9a	Pre-employment medical check-up done for all workers and submitted?		1	Medical check records
9b	Availability of first aid centre, with MBBS doctor (Own or Sharing basis)	M	2	Attendance records
9c	Availability of Ambulance facility 24 hours (Own or sharing basis)	M	2	-do-
9d	Is First aid trained personnel are available and their names are displayed at site?	M	1	-do-
9e	Availability of Emergency vehicle at site		1	

SL	Parameter for Measurement	M/O	Mx	Supporting Documents
9f	Periodical medical check-up is conducted for all the workers and submitted?		1	Medical check records
9g	Availability of sufficient number of first aid box as per standard list and maintaining record		1	Inspection records
10a	Availability of Fire extinguishers, buckets at all vulnerable points		2	Fire extinguisher records
10b	Periodic fire mock drill conducted?		1	Fire, Mock drill records
10c	Are all flammable materials are stored separately?		1	
10d	Periodic grass cutting is done in material storage area?		1	
10e	Availability of 24V DC lighting in confined space work area		1	
10f	Availability of exhaust fan in confined space work area		1	

[Legend: **M**: Mandatory, **O**: Optional, **Mx**: Maximum Possible Score of the Parameter]

NOTE:

- Points other than mandatory can be excluded with appropriate justification (scope etc.) by BHEL. Score obtained in selected parameters divided by maximum possible score of selected parameters shall be multiplied by 10 for use in Sl. No. #6.0 as detailed on Page 4 of Form F15
- There shall be deduction of marks from overall score for Fatal/ Major/ Minor Accidents and for not maintaining labor colony as detailed on Page 4 of Form F15

INDEMNITY BOND

(To be executed on a Non Judicial Stamp Paper of the requisite value as per Stamp Duty prevalent in the respective State)

The Contractor further agree that the Company shall be entitled to with hold and adjust the Security Deposit and/or with hold and adjust payment of Bills of Contractor pertaining to this Contract against any payment which the Company has made or is required to make for which the Contractor is liable under the Contract and that such amount can be withheld, adjusted by the Company till satisfactory and final settlement of all pending matters and the Contractor hereby gives his consent for the same.

The Contractor further agrees that the terms of indemnity shall survive the termination or completion of this contract.

The contractor further agrees that the liability of the contractor shall be extended on actual basis notwithstanding the limitations of liability clause, in respect of :

1. breach of terms of contract by the contractor
2. breach of laws by the contractor
3. breach of Intellectual property rights by the contractor
4. breach of confidentiality by the contractor

Nothing contained in this deed, shall be construed as absolving or limiting the liability of the Contractor under said Contract between the Company and the Contractor. That this Indemnity Bond is irrevocable and the condition of the bond is that the Contractor shall duly and punctually comply with the terms and the conditions of this deed and contractual provisions to the satisfaction of the Company.

In witness where of M/s xxxxxxxxxxxxxx these presents on the day, month and year first, above written at xxxxxxxx by the hand of its signatory Mr. xxxxxxxxxxxx.

Signed for and on behalf of
M/s xxxxxxxxxxxxxxxxxxxx

Witness:

- 1
- 2

CONSORTIUM AGREEMENT

(To be executed on Rs. 50/- Non – Judicial Stamp Paper)

THIS AGREEMENT is made and executed on this _____ day of _____, by and between (1) M/s _____, (The First Party, i.e, the Bidder) a company incorporated under the Company's Act 1956, having its registered office at _____(herein after called the "Bidder", which expression shall include its' successors, administrators, executors and permitted assigns) and (2) M/s _____, (The Second Party, i.e, the associates), a company incorporated under the Company's Act 1956, having its registered office at _____ (herein after called the " Associates", which expression shall include its' successors, administrators, executors and permitted assigns).

WHEAEAS the Owner, Bharat Heavy Electricals Ltd, a Government of India Undertaking, proposes to issue / issued an NIT (herein after referred to as the said NIT) inviting bids from the individual Bidders for undertaking the work of _____, at _____ (herein after referred to as the said works).

WHEREAS the said NIT enables submission of a bid by a Consortium subject to fulfillment of the stipulations specified in the said NIT.

AND WHEREAS M/s _____ (The First Party, i.e, the Bidder) will submit its proposal in response to the aforesaid invitation to bid by the Owner for _____ as detailed in the Bid doc. no. < TENDER REF----->

AND WHEREAS M/s _____ (The First Party, i.e the Bidder) itself is meeting all the qualifying requirements except the qualifying requirements of _____ (as detailed in the NIT) and in order to fully meet the qualifying requirements of NIT, this tie-up agreement is being entered into with M/s _____ (The Second Party, the Associates) , who fully meet the balance part of the said works (_____).

WHEREAS the First Party and the Second Party are contractors engaged in the business of carrying out various items of works. WHEREAS the two parties have agreed to constitute themselves into a consortium for the purpose of carrying out the said works, and that the consortium will be continued till the completion of the works in all respects.

WHEREAS the parties have agreed to certain terms and conditions in this regard:

CONSORTIUM AGREEMENT

NOW THEREFORE THIS AGREEMENT WITNESSETH AS FOLLOWS :

1. First and Second parties hereby constitute themselves into a Consortium for the purpose of bidding and undertaking the said works pursuant to the said NIT as hereinafter stated.
2. The First Party will be the leader (Lead Partner) and will be responsible for the entire works.

CONSORTIUM AGREEMENT

3. The First Party shall undertake the following part(s) of work detailed in the NIT namely _____

4. The Second Party shall undertake the following part(s) of work detailed in the said NIT namely _____

5. The parties hereby declare and confirm that each of them will fulfill the required minimum qualifying requirements as prescribed in the said NIT for the works agreed to be undertaken by them as stated here-in-above.
6. It is also agreed between the parties hereto that all of them shall be individually and severally responsible for the completion of the said works as per the schedule. Further, if the Employer/Owner sustains any loss or damage on account of any breach of the Contracts, we the, Consortium partners individually and severally undertake to promptly indemnify and pay such losses / damages caused to the Employer/Owner on its written demand without any demur, reservation, contest or protest in any manner whatsoever.
7. The parties hereby agree and undertake that they shall provide adequate finances, suitable Tools, Plants, Tractors, Trailers, other transportation equipment, other Tools & Plants, Measuring & Monitoring Equipments (MMEs), Men and Machinery etc. for the proper and effective execution of the works to be undertaken by them as specified here-in-above.
8. It is agreed interse between the parties hereto that all the consequences liabilities etc., arising out of any default in the due execution of the said works shall be borne by the party in default, that is by party in whose area of works default has occurred, provided however, so far as M/s Bharat Heavy Electricals Limited is concerned, all the parties shall be liable jointly and severally.

CONSORTIUM AGREEMENT

IN WITNESS HEREOF the parties above named have signed this agreement on the day month and year first above written at _____(Place) .

WITNESS

For

- 1. NAME
- 2. OFFICIAL ADDRESS

(FIRST PARTY)

WITNESS

For

- 1. NAME
- 2. OFFICIAL ADDRESS

(SECOND PARTY)

[The successful bidder shall have to execute the " JOINT DEED OF UNDERTAKING " in the format to be made available by BHEL at the time of awarding].

Claim for Refund of Security Deposit

Ref No.:

Date:

- 1 Name and address of the contractor
- 2 Contract Agreement/Work Order No.
- 3 Date of contract agreement/work order
- 4 Name of the work undertaken
- 5 Date of commencement of the work
- 6 Date of completion of the work
- 7 Period of Maintenance
- 8 Date on which the final bill was paid
- 9 Last date of making good the defect, if any, during maintenance period
- 10 Expenditure incurred by BHEL during maintenance period, if any, recoverable
- 11 Date on which security deposit refund falls due as per contract
- 12 Amount deposited/recovered

Details	Mode	Amount

- 13 LESS amounts recoverable (with details)
 - (i) Amount spent by BHEL on maintenance:
 - (ii) Payments made on behalf of contractor :
 - (iii) Court dues / penalties / compensation :
 - (iv) Other recoveries for services etc. :
 - (v) Security deposit released with final bill (%):
- 14 Net amount recommended for release (12-13):

Details	Mode	Amount

Date:

Signature of Engineer in Charge

CERTIFICATE TO BE FURNISHED BY THE CONTRACTOR

I/We have no claim or demand outstanding against BHELfor the work done or for labor or material supplied or any other account arising out of or connected with the contract agreement/work order (No.....dated) and the payment of this bill shall be in full and final

Date:

Signature of Contractor

CERTIFICATE TO BE FURNISHED BY SENIOR ENGINEER

Certified that

- The payment recommended for release is in order and there are no demands other than those included in the claim outstanding from the contractor;
- The maintenance period as per the contract agreement is over and the contractor has carried out the works required to be carried out by him during the period of maintenance to our satisfaction, and all expenses incurred by the company on carrying out such works have been included for adjustment;
- All the objections raised so far have been settled;
- A note of refund of security deposit has been made in the measurement book and contract agreement/work order.

Date:

Signature of Senior Engineer

FOR USE IN FINANCE DEPARTMENT

Passed for

Rs.....(Rupees.....
.....only)

Accountant

Accounts Officer

REFUND OF GUARANTEE MONEY

**BHARAT HEAVY ELECTRICALS LIMITED
POWER SECTOR, _____ REGION**

Ref No:

Date:

1. Name and Address of Contractor :
2. Contract Agreement/LOI No :
3. Date of Contract Agreement/LOI :
4. Name of the Work undertaken :
5. Date of commencement of the Work :
6. Date of Completion of the Work :
7. Period of Maintenance :
(Guarantee Period)
8. Date on which the Final Bill was paid :
9. Last date of making good the defect :
during Maintenance Period
10. Expenditure incurred by BHEL during :
Maintenance Period, if any, recoverable
11. Date on which Guarantee Money refund:
falls due as per Contract
12. Amount of Guarantee Money to be refunded:
13. Less Amounts recoverable (with details)
 - a. Amount spent by BHEL on maintenance :
 - b. Payments made by BHEL on behalf of Contractor:
 - c. Court dues/penalties/compensation :
 - d. Other recoveries for Services, etc :
 - e. Total of 'a' to 'd' :
14. Net Amount recommended for release (12-13) :

Signature of BHEL Engineer

Date: _____

REFUND OF GUARANTEE MONEY

BHARAT HEAVY ELECTRICALS LIMITED
POWER SECTOR, _____ REGION

CERTIFICATE TO BE FURNISHED BY THE CONTRACTOR

I/We have no claim or demand outstanding against BHEL _____, for the work done or for labour or material supplied or any other account arising out of or connected with the Contract Agreement/LOI (No _____ dated _____) and the payment of this bill shall be in full and final settlement of all my/our claims and demands including the 'Deposits' of the Contract Agreement/LOI referred to.

Signature of Contractor

Date:

CERTIFICATE TO BE FURNISHED BY SENIOR ENGINEER/CONSTRUCTION MANAGER

1. Certified that
 - a. The payment recommended for release is in order and there are no demands other than those included in the claim outstanding from the Contractor
 - b. Maintenance period (Contract Guarantee period) is over and the Contractor has carried out the works required to be carried out by him during the period of maintenance (Guarantee) to our satisfaction, and all expenses incurred by the Company on carrying out such works have been included for adjustment
 - c. All objections raised so far have been settled
 - d. A note for refund of Guarantee Amount has been made in the Measurement Book and Contract Agreement/Work Order

Signature of BHEL Engineer

Construction Manager

Date:-----

FOR USE IN ACCOUNTS DEPARTMENT

Passed for Rs _____ (Rupees _____ only)

Accountant

Accounts Officer

ACKNOWLEDGE BY THE CONTRACTOR

Received Rs _____ in full and final settlement of my/our claim

Signature of Contractor

Date:

POWER OF ATTORNEY for SUBMISSION OF TENDER/SIGNING CONTRACT AGREEMENT

(To be typed on non judicial Stamp Papers of appropriate value as applicable and Notarised)

KNOW ALL MEN BY THESE PRESENTS, that I/We do hereby make, nominate, constitute and appoint Mr , whose signature given below herewith to be true and lawful Attorney of M/s..... hereinafter called 'Company', for submitting Tender/entering into Contract and inter alia, sign, execute all papers and to do necessary lawful acts on behalf of Company with M/s Bharat Heavy Electricals Ltd, Power Sector _____ Region, _____, in connection with
.....
..... vide Tender Specification No : _____, dated _____.

And the Company do hereby agree to ratify and confirm all acts, deeds, things or proceedings as may be lawfully done by the said attorney and by or on behalf of the company and in the name of the company, by virtue of the powers conferred herein and the same shall be binding on the company and shall have full force and effect.

IN WITNESS WHEREOF the common seal of the company has been hereunto affixed in the manner hereinafter appearing on the document.

Dated at _____, this _____ day of _____

Director/CMD/Partner/Proprietor

Signature of Mr.....(Attorney)

Attested by: Director/CMD/Partner/Proprietor

Witness

Notary Public

ANALYSIS OF UNIT RATES QUOTED

(To be typed and submitted in the Letter Head of the Company/Firm of Bidder)

Offer Reference No:.....

Date:.....

To,

(Write Name & Address of Officer of BHEL inviting the Tender)

Dear Sir,

Sub : Analysis of Unit Rates Quoted

Ref : Tender Specification No:

Analysis of Unit Rates quoted by us in respect of above Tender is as detailed

SN	DESCRIPTION	% OF QUOTED RATE	REMARKS
01	SITE FACILITIES VIZ., ELECTRICITY, WATER OTHER INFRASTRUCTURE		
02	SALARY AND WAGES + RETRENCHMENT BENEFITS		
03	CONSUMABLES		
04	T&P DEPRECIATION & MAINTENANCE		
05	ESTABLISHMENT & ADMINISTRATIVE EXPENSES		
06	OVERHEADS		
07	PROFIT		
	TOTAL	100%	

Yours faithfully,

(Signature, Date & Seal of Authorized Representative of the Bidder)

Form No: F-27 (WAM-06)

Running Account Bill

Name of the Contractor
 Name of the Work:
 Sanctioned Estimate:
 Code No.:
 Contract Agreement No.:

Dated:

Division
 Date of written order to commence the Work:
 Date of commencement of work:
 Due date of completion as per agreement
 Date of approval of Competent Authority for time extension as applicable (copy to be enclosed).

Departmental Bill No.
 Date:
 Sub-Division:
 Period of work covered in this bill:

I. ACCOUNT OF WORK EXECUTED

Adhoc payment for work not previously measured **			Item No. of work	Description of work	Quantity as per agreement	Quantity executed upto date	Rate	Unit	Payment on the basis of actual measurement upto date	Quantity executed since last RA bill	Payment on the basis of actual measurement since last running account bill	Remarks
Total as per last running account bill	Since last running account bill	Total upto date										
1	2	3	4	5	6	7	8	9	10	11	12	13

- ** 1. Whenever payment is made on adhoc basis without actual measurements the amount in whole rupees should be entered in columns 1 to 3 only and not in columns 7 to 12
 2. Whenever there is an entry in column 12 on the basis of actual measurement, the whole of the amount previously paid without detailed measurement should be adjusted by a minus entry in column 2 equivalent to the amount shown in column 1, so that the total upto date in column 3 may become nil.

Total value of work done upto date (A) -----
 Deduct value of work shown on the last Running Account Bill (B) -----
 Net value of work done since last Running Account Bill (C) -----

Rupees (in words) Only

Note :
 Wherever adhoc payments to contractors against running bills are made in accordance with the extant Works Policy, the amount so paid shall be adjusted.

II. MEMORANDUM OF PAYMENTS

(Contd.) Form No F-27
(WAM 06)

	I		II
1. Total value of work actually measured as per Account No. I, Column 10	(A)
2. Total upto date adhoc payment for work covered by approximate or plan measurements as per Account I, Col. 3	(B)
4. Total upto date payments [(A)+(B)]	(C)
5. Total amount of payments already made as per entry (D) of last Running Account Bill No. dated forwarded to the Accounts Department on	(D)
6. Balance [(C) - (D)]		
7. Payments now to be made:			
a) by cash / cheque		
b) by deduction for value of materials supplied by BHEL vide Annexure A attached		
c) by deduction for hire of tools and plant vide Annexure B attached		
d) by deduction for other charges vide Annexure C attached		
e) by deduction on account of security deposit		
f) by deduction on account of Income Tax	

Note: Amounts relating to items 4 to 6 above should be entered in column II and those relating to item 7 in column I. The amount shown against item 6 and the total of item 7 should agree with each other.

III. CERTIFICATE OF THE ENGINEER IN CHARGE

1	"The measurements on which the entries in column 7 to 12 of Part I of this Bill (Account of work executed) are based were made by and are recorded at pages of Measurement Book No." (Name and Designation)
2	Certified that the methods of measurement are correct and the work has been carried out in accordance with the terms and conditions, schedules, specifications and drawings etc. forming part of the contract agreement, subject to deviations included in the deviation statement (Annexure D)
3	Certified that in addition to and quite apart from the quantities of work actually executed as shown in column 10 of Part I, some work has actually been done in connection with several items and the value of the such work is, in no case, less than the adhoc payments as per column 3 of Part I, made or proposed to be made, for the convenience of the contractor in anticipation of, and subject to the results of, detailed measurement which will be made as soon as possible.
4	Certified that measurements by Engineer-incharge and test check of prescribed percentage of measurements by the concerned superior authorities has been carried out.
5	Certified that there are no pending recoveries from the contractor on account of chargeable items (e.g T&P, consumables, material, etc.) issued either by BHEL or by the customer and other recoveries like power, water, quarter, tax liability towards declaration forms etc.
6	Certified that with regard to the free issues, regular reconciliation is being done, completed upto ----- and there are no recoveries pending from the contractor on account of such issues in excess of requirement for execution of work as per contract.
7	Certified that there is no pending recovery for damaged material issued free of cost.
8	Certified that the contractor has fulfilled all the requirements as per contract with reference to statutory obligations (PF, ESI, Minimum Wages, BOCW, Insurance etc.), support services such as service manpower, computer system, T&P etc

Signature of Contractor

Date:

Signature of Engineer in Charge

Designation:

Date:

IV. CERTIFICATE OF THE SENIOR ENGINEER

(Contd.) Form No F-27
(WAM 06)

1	"Certified that the measurements have been check measured to the prescribed extent by at site and also by the undersigned and the relevant entries have been initialed in the Measurement Book. (vide pages)" (Name and Designation)
2	Certified that all the measurements recorded in the measurement book have been correctly billed for
3	Certified that all recoverable amounts in respect of materials tools and plant etc. and other charges have been correctly made vide annexures A to C attached.

Certified for payment * of Rs. (Rupees only)

* Here specify the net amount payable.

Date:

Signature of Senior Engineer

V. ENTRIES TO BE MADE IN THE FINANCE DEPARTMENT

Code No.:

Accounts Bill No..... dated

Entered in Journal Book vide entry No. dated

Passed for Rs.

Less Deductions Rs.....

Net amount payable Rs.....

(Rupees only)

Payable to Shri / M/s..... by cheque / cash

Entered in Contractors ledger No. Page

ALLOCATION

Estimate No :	Debit	Credit
Name of Work :	(Gross amount)	(Deductions)
Account code head		
Total		

**Assistant
Date:**

**Accountant
Date:**

**Finance Executive
Date:**

ANNEXURE A

(Contd.) Form No F-27
(WAM 06)

Statement showing details of materials issued to the contractor Shri / M/S..... in respect of Contract Agreement / Work Order No.....Dated..... and covered by the agreement

Sl.No.	Stores Issue Voucher No. and date	Issue voucher No. and date allotted by stores to the SIV	Description of material issued to the contractor	Quantity issued		Quantity actually incorporated in the work	Balance quantity with contractor		If recoverable from the contractor				
				Free	Chargeable		Free	Chargeable	Rate at which recoverable	Amount recoverable	Amount recovered upto previous bill	Balance now recovered	Remarks
1	2	3	4	5	6	7	8	9	10	11	12	13	14

Total

Certified that (balance quantity of free issue material as per Col. 8 above) is physically available with the Contractor.

Signature of Contractor

Signature of Engineer in Charge

Signature of Senior Engineer

Date:

Date:

Date:

ANNEXURE B

Statement showing tools and plant issued to the contractor Shri/M/s..... in respect of Contract Agreement No.....Dated.....

Sl. No.	Description of Tools and Plant Issued	Period for which issued	Rate at which recovery is to be made	Amount recoverable	Amount recovered upto previous bill	Balance Recovered now	Remarks
1	2	3	4	5	6	7	8

Total

Signature of Contractor

Signature of Engineer in Charge

Signature of Senior Engineer

Date:

Date:

Date:

ANNEXURE C

(Contd.) Form No F-27
(WAM 06)

Statement showing details of other recoveries to be made from the contractor Shri/M/s.in respect of contract Agreement No.Dated

S. No.	Particulars	Unit	Quantity	Rate	Amount recoverable	Amount recovered up to previous bill	Amount now recovered	Remarks
1	2	3	4	5	6	7	8	9
1.	Water charges							
2.	Electricity charges							
3.	Seignorage charges							
4.	Medical charges							
5.	Cost of empty gunny bags and empty containers not returned							
6.								
7.								
8.								

Total

--	--	--

Signature of Contractor

Signature of Engineer in Charge

Signature of Senior Engineer

Date:

Date:

Date:

**ANNEXURE D
DEVIATION STATEMENT**

Name of the Contractor:

Contract Agreement No

Name of Work:

Date:

S. No.	Description of Item	Unit	Quantity as per agreement	Quantity as executed	Quantity further anticipated	Total quantity anticipated on completion	Rate as per agreement	Rate as executed	Amount as per agreement	Amount as executed	Amount further anticipated	Total Amount anticipated on completion	Difference		Reason for deviation with authority, if any
													Excess	Savings	
1	2	3	4	5	6	7	8	9	10	11	12	13	14	15	16

Signature of Engineer in Charge

Signature of Senior Engineer

Date :

Date:

Final Bill

Departmental Bill No:

Date:

Name of the Contractor:

Division:

Sub-Division:

Name of the Work:

Date of Written order to commence the work:

Sanctioned Estimate:

Date of commencement of the Work:

Contract Agreement/ Work Order No:

Dated:

Due date of completion as per Agreement:

Date of actual completion of the work:

I. ACCOUNT OF WORK EXECUTED

Adhoc payment for work not previously measured **			Item no. of the agreement / work order	Description of work	Quantity as per agreement	Quantity executed upto date	Rate	Unit	Payment on the basis of actual measurement upto date	Quantity since last running account bill	Payment on the basis of actual measurement since last running account bill	Remarks
Total as per last running account bill	Since last running account bill	Total upto date										
1	2	3	4	5	6	7	8	9	10	11	12	13

** Whenever there is an entry in column 12 on the basis of actual measurement, the whole of the amount previously paid without detailed measurement should be adjusted by a minus entry in column 2 equivalent to the amount shown in column 1, so that the total upto date in column 3 may become nil.

Total value of work done upto date	(A)
Deduct value of work shown on the last Running Account Bill	(B)
Net value of work done since last Running Account Bill	(C)

II. MEMORANDUM OF PAYMENTS

(Contd.) Form No F-28 (WAM 07)

1	Total value of work actually measured as per Account No. I column 10	(A)
2	Deduct amount of payments already made as per last running account bill No. dated	(B)
3	Payment now to be made [(A) - (B)]	(C)
4	Deduct amounts recoverable from the contractor on account of :		
	a) Materials supplied by BHEL vide Annexure A attached	
	b) Hire of tools and plant vide Annexure B attached	
	c) Other charges vide Annexure C attached	
	d) Income Tax	
	Total Deductions	
		
5	Balance	
6	Refunds of Security Deposit	
7	Net amount to be paid to the contractor	
	Net value Rupees (in words) Only

I/ We hereby certify that I/We have performed the work as per the terms and conditions of Contract Agreement/Work Order No.....Dated.....for which payment is claimed as above and that I/We have no further claim under this agreement/work order.

Signature of the Contractor
Date:

III CERTIFICATE OF THE ENGINEER IN CHARGE

"1. The measurements based on which the entries in columns 7 to 11 of Part I of this bill (Account of work executed) were made by
.....
(Name and Designation)
and are recorded at pages.....of measurement book No.....
2. A statement showing the quantities of stores issued to the contractor (whether free or on recovery basis) and their disposal is attached."

Date:

Signature of Engineer incharge
Designation:

IV CERTIFICATE OF THE SENIOR ENGINEER

(Contd.) Form No F-28 (WAM 07)

- "1. Certified that I have personally inspected the work and that the work has been physically completed on the due date in accordance with the terms and conditions, schedules, specifications and drawings etc., forming part of the contract agreement, subject to the deviations noted in Deviation Statement (Annexure D).
- 2. Certified that the measurements have been check measured to the prescribed extent by.....
 and by the undersigned at site and the relevant entries have been
 (Name and Designation)
 initiated in the measurement book (vide pages.....)
- 3. Certified that the methods of measurement are correct.
- 4. Certified that the measurements have been technically checked with reference to contract drawings, deviations etc.
- 5. Certified that the measurements recorded in the measurement book have been correctly billed for at the contract rates or approved rates.
- 6. Certified that all recoverable amounts in respect of stores, tools and plant, water, electricity charges etc. have been correctly made vide Annexures A to C and that there are no other demands outstanding against the contractor on this contract.
- 7. Certified that the issues of all stores as per statement attached (whether charged to the contractor or direct to the work) have been technically checked and represent fair and reasonable issues for the items of work executed vide Annexure E.
- 8. Certified that all statutory requirements including PF, ESI, Minimum wages, Insurance, GST, BOCW, etc. are complied with by the Contractor. This should be duly backed by the relevant documents."

Certified for payment of * Rs.....(Rupees.....only).

***Here specify the net amount payable**

Signature of Senior Engineer

Date

IV ENTRIES TO BE MADE IN THE FINANCE DEPARTMENT

Passed for.....Rs.....
Less Deductions.....Rs.....
Net Amount Payable.....Rs.....
(Rupees.....only)

Account code head	Debit	Credit
	(Gross Amount)	(Deductions)
TOTAL		

Assistant
Date:

Accountant
Date:

Finance Executive
Date:

ANNEXURE A Part I

(Contd.) Form No F- 28 (WAM 07)

Statement showing details of materials issued to the contractor Shri / M/S.....in respect of Contract Agreement / Work Order No.....Dated..... and covered by the agreement

Sl. No.	Stores Issue Voucher No. and date	Issue voucher No. and date allotted by stores to the SIV	Description of material issued to the contractor	Quantity issued	Quantity actually incorporated in the work	Whether recoverable contractor or supplied free	If recoverable from the Contractor				Remarks
							Rate at which recoverable	Amount recoverable	Amount recovered upto previous bill	Balance now recovered	
1	2	3	4	5	6	7	8	9	10	11	12
Signature of Contractor						Total			Signature of Senior Engineer		

Date:

Date:

Date:

ANNEXURE A Part II

Statement showing details of materials issued to the contractor Shri / M/S..... in respect of Contract Agreement / Work Order No.....Dated..... and not covered by the agreement

Sl. No.	Stores Issue Voucher No. and date	Issue voucher No. and date allotted by stores to the SIV	Description of material issued to the contractor	Quantity issued	Quantity actually incorporated in the work	Issue Rate	Amount recoverable	Amount recovered upto previous bill	Balance now recovered	Remarks
1	2	3	4	5	6	7	8	9	10	11

TOTAL
Add Departmental Charges
Add GST (Wherever applicable)
GRAND TOTAL

Signature of Contractor

Signature of Engineer in Charge

Signature of Senior Engineer

Date:

Date:

Date:

Note: Cost of materials recovered in this bill should be shown against item 4 (a) of the memorandum of payments. The amounts of taxes and departmental charges recovered in this bill should be incorporated in Annexure C.

(Contd.) Form No F-28 (WAM 07)

ANNEXURE B

(Contd.) Form No F-28 (WAM 07)

Statement showing tools and plant issued to the contractor Shri /M/S.....in respect of contract Agreement / Work Order No.....Dated.....

Sl. No.	Description of Tools and Plant Issued	Period for which issued	Rate at which recovery is to be made	Amount recoverable	Amount recovered upto previous bill	Balance now recovered	Remarks
1	2	3	4	5	6	7	8
			TOTAL				

Signature of Contractor

Date:

Signature of Engineer in Charge

Date:

Signature of Senior Engineer

Date:

ANNEXURE C

Statement showing details of other recoveries to be made from the contractor Shri/M/s..... in respect of Contract Agreement / Work Order No.....Dated.....

Sl. No.	Particulars	Unit	Quantity	Rate	Amount recoverable	Amount recovered upto previous bill	Amount now recovered	Remarks
1	2	3	4	5	6	7	8	9
1	Water charges							
2	Electricity charges							
3	Medical charges							
4	Cost of empty gunny bags and empty containers not returned							
5								
6								
7								
				TOTAL				

Signature of Contractor

Date:

Signature of Engineer in Charge

Date:

Signature of Senior Engineer

Date:

ANNEXURE F

(Contd.) Form No F-28 (WAM 07)

Statement showing details of materials issued to the contractor Shri/M/s..... in respect of Contract Agreement / Work Order No.....dated.....

Name of the Work:

FREE OF COST

Sl. No.	Stores Issue Voucher No.	Description of material	Unit	Quantity issued	Quantity required as per data	Quantity consumed in the work	Balance (if any)	Nature of disposal for the balance	Rate chargeable for material not returned	Amount recoverable for material not returned	Remarks
1	2	3	4	5	6	7	8	9	10	11	12

Signature of Contractor

Date:

Signature of Engineer in Charge

Date:

Signature of Senior Engineer

Date:

ANNEXURE G

**QUESTIONNAIRE TO BE ANSWERED BY THE ENGINEER IN CHARGE AND SENIOR ENGINEER
(Correct particulars and answers to be recorded)**

1. Name of the Work:
2. Name of the Contractor:
3. Date of commencement of the Work:
4. Contract agreement /Work Order No. and date:
5. Reference to the supplementary Agreement No. if any:
6. Whether administrative approval and technical sanction has been accorded by the competent authority? If so, cite reference?
7. Whether sanction of the competent authority and financial concurrence of the Finance Department for award of the work has been accorded? If so, cite reference.
8. Whether the work has been completed in time? If not whether penalty has been levied or sanction of the competent authority for extension of time granted and communicated to the Finance Department with reasons for grant of extension? (Due and actual date of completion of the work and reference to letter No. and date granting the extension of time should be given).
9. (a) Whether the rates allowed in the bill have been checked with the contract agreement?
(b) Whether the rates for extra/supplemental items have been approved by the competent authority and the sanction communicated to the Finance Department together with rate analysis? If so, cite reference
10. Whether deviations have been approved by the competent authority? If yes, give reference to the approval; if not, give reasons.
11. Whether the rates of recovery of stores issued to the contractor which are not provided for in the contract agreement have been settled in consultation with Finance?
12. Whether discrepancies pointed out by the Finance department in the stores statement have been reconciled and accepted by the Finance Department?
13. Whether materials issued to the contractor in excess of the theoretical requirements have been returned to the Stores department and the No. and date of such returned stores vouchers have been shown in Stores statement? If not, whether the cost of such excess materials has been recovered at the prescribed rate? Whether consumption statements in respect of materials chargeable to the work have been attached to the bill?
14. Whether consumption of materials shown has been technically checked by Senior Engineer?
15. Whether materials issued and used in the work is not less than that required for consumption in work according to our specifications? If consumption is less, whether necessary recovery has been made in the bill?
16. Whether measurements have been checked by the Engineer Incharge and Senior Engineer to the extent required and certificates of check recorded in the measurement books?
17. Whether contractor has signed the bill and the measurement books without reservations? If not, whether reasons have been intimated to the Finance Department?
18. Whether arithmetical calculations have been checked and certificate recorded in the measurement books by a person other than the one who calculated initially?
19. Whether any work was done at the risk and cost of the contractor and whether such cost has been recovered from him? Give particulars.
20. Whether all advance payments on running accounts have been recovered?
21. Whether all the recoveries due for services given to the contractor like rent of accommodation, water charges, electricity charges have been recovered and whether payments made by the company on behalf of the contractor have been adjusted?
22. Whether the files containing abstracts from measurement books/standard measurement books have been completed/updated?
23. Whether hire charges for tools & plant have been recovered and the statement of hire charges with full details attached?
24. Whether the certificate of workmanship and completion of work according to specifications, drawings etc. is recorded by Engineer Incharge/ Senior Engineer and whether recoveries have been made for defective works, if any?
25. Whether all corrections in the bill/measurement books etc. have been neatly made and attested and there are no overwriting?
26. Whether final measurements have been taken as soon as possible after completion of the work and the certificate of completion issued? If not, whether reasons for delay have been recorded and communicated to finance department ?
27. In respect of quantities reduced in the final bill as compared to the running payment, whether adequate reasons have been recorded and communicated to finance department ?
28. Whether the expenditure has been classified correctly according to heads of account recorded in the sanctioned estimate?
29. Whether the work has been completed within the estimated cost? If not, what is the percentage of excess over the sanctioned estimate/administrative approval? In case the excess is beyond the competency of the Senior Engineer, what action has been taken for obtaining the approval of the authority competent to sanction the excess?
30. (a) If the contractor has furnished bank guarantee in lieu of cash security deposit towards proper execution of works and guarantee against defects during the maintenance period, whether the period of currency of the bank guarantee covers the entire maintenance period?
(b) If not whether security deposit has been proposed to be recovered from the final bill?
31. Whether all the previous audit objections raised on running account bills have been settled? If so, cite references.

Signature of Engineer in Charge

Date:

Signature of Senior Engineer

Date:

**PROFORMA OF BANK GUARANTEE
(in lieu of EARNEST MONEY)**

**BANK GUARANTEE (in lieu of EARNEST MONEY)
(On non-Judicial stamp paper of appropriate value)**

Bank Guarantee No.....

Date.....

To
(Employer's Name and Address)

.....

Dear Sirs,

In accordance with the terms and conditions of Invitation for Bids/Notice Inviting Tender No.....1(Tender Conditions), M/s. having its registered office at2 (hereinafter referred to as the 'Tenderer'), is submitting its bid for the work of.....3 invited by4.(name of the Employer) through its Unit at(

The Tender Conditions provide that the Tenderer shall pay a sum of Rs as Earnest Money Deposit in the form therein mentioned. The form of payment of Earnest Money Deposit includes Bank Guarantee executed by a Scheduled Bank.

In lieu of the stipulations contained in the aforesaid Tender Conditions that an irrevocable and unconditional Bank Guarantee against Earnest Money Deposit for an amount of5 is required to be submitted by the Tenderer as a condition precedent for participation in the said Tender and the Tenderer having approached us for giving the said Guarantee,

we, the[Name & address of the Bank] having our Registered Office at(hereinafter referred to as the Bank) being the Guarantor under this Guarantee, hereby irrevocably and unconditionally undertake to forthwith and immediately pay to the Employer without any demur, merely on your first demand any sum or sums of Rs. 5(in words Rupees.....) without any reservation, protest, and recourse and without the beneficiary needing to prove or demonstrate reasons for its such demand.

Any such demand made on the Bank shall be conclusive as regards the amount due and payable by the Bank under this guarantee. However, our liability under this guarantee shall be restricted to an amount not exceeding Rs. _____.

We undertake to pay to the Employer any money so demanded notwithstanding any dispute or disputes raised by the Vendor/Contractor/Supplier in any suit or proceeding pending before any Court or Tribunal, Arbitrator or any other authority, our liability under this present being absolute and unequivocal.

The payment so made by us under this Guarantee shall be a valid discharge of our liability for payment hereunder and the Tenderer shall have no claim against us for making such payment.

We Bank further agree that the Employer shall have the fullest liberty without our consent and without affecting in any manner our obligations hereunder to vary any of the terms and conditions of the said Tender or to extend the time of submission of from time to time or to postpone for any time or from time to time any of the powers exercisable by the Employer against the said Tenderer and we shall not be relieved from our liability by reason of any such variation, or extension being granted to the said Tenderer or for any forbearance, act or omission on the part of the Employer or any indulgence by the Employer to the said Tenderer or by any such matter or thing whatsoever which under the law relating to sureties would but for this provision have effect of so relieving us.

The Bank also agrees that the Employer at its option shall be entitled to enforce this Guarantee against the Bank as a principal debtor, in the first instance without proceeding against the Tenderer and notwithstanding any security or other guarantee that the Employer may have in relation to the Tenderer's liabilities.

This Guarantee shall be irrevocable and shall remain in force upto and including.....6 and shall be extended from time to time for such period as may be desired by the Employer.

This Guarantee shall not be determined or affected by liquidation or winding up, dissolution or change of constitution or insolvency of the Tenderer but shall in all respects and for all purposes be binding and operative until payment of all money payable to the Employer in terms hereof. However, unless a demand or claim under this Guarantee is made on us in writing on or before the 7 we shall be discharged from all liabilities under this Guarantee.

We, Bank lastly undertake not to revoke this guarantee during its currency except with the previous consent of the Employer in writing.

Notwithstanding anything to the contrary contained hereinabove:

- a) The liability of the Bank under this Guarantee shall not exceed.....5.....
- b) This Guarantee shall be valid up to6
- c) Unless the Bank is served a written claim or demand on or before _____7 all rights under this guarantee shall be forfeited and the Bank shall be relieved and discharged from all liabilities under this guarantee irrespective of whether or not the original bank guarantee is returned to the Bank

We, _____ Bank, have power to issue this Guarantee under law and the undersigned as a duly authorized person has full powers to sign this Guarantee on behalf of the Bank.

For and on behalf of
(Name of the Bank)

Date.....

Place of Issue.....

- 1 Details of the Invitation to Bid/Notice Inviting Tender
- 2 Name and Address of the Tenderer
- 3 Details of the Work
- 4 Name of the Employer
- 5 BG Amount in words and Figures
- 6 Validity Date
- 7 Date of Expiry of Claim Period

Note:

- 1. Units are advised that expiry of claim period may be kept 3-6 months after validity date. It may be ensured that the same is in line with the agreement/ contract entered with the Vendor.
- 2. The BG should be on Non-Judicial Stamp paper/e-stamp paper of appropriate value as per Stamp Act prevailing in the State(s) where the BG is submitted or is to be acted upon or the rate prevailing in the State where the BG was executed, whichever is higher. The Stamp Paper/e-stamp paper shall be purchased in the name of Vendor/Contractor/Supplier /Bank issuing the guarantee.
- 3. In line with the GCC, SCC or contractual terms, Unit may carry out minor modifications in the Standard BG Formats. If required, such modifications may be carried out after taking up appropriately with the Unit/Region's Law Deptt.

4. In Case of Bank Guarantees submitted by Foreign Vendors-

- a. From Nationalized / Public Sector / Private Sector/ Foreign Banks (BG issued by Branches in India)** can be accepted subject to the condition that the Bank Guarantee should be enforceable in the town/city or at nearest branch where the Unit is located i.e. Demand can be presented at the Branch located in the town/city or at nearest branch where the Unit is located.
- b. From Foreign Banks (wherein Foreign Vendors intend to provide BG from local branch of the Vendor country's Bank)**
 - b.1** In such cases, in the Tender Enquiry/ Contract itself, it may be clearly specified that Bank Guarantee issued by **any of the Consortium Banks only** will be accepted by BHEL. As such, Foreign Vendor needs to make necessary arrangements for issuance of Counter- Guarantee by Foreign Bank in favour of the Indian Bank's (BHEL's Consortium Bank) branch in India. It is advisable that all charges for issuance of Bank Guarantee/ counter- Guarantee should be borne by the Foreign Vendor. The tender stipulation should clearly specify these requirements.
 - b.2** In case, **Foreign Vendors intend to provide BG from** Overseas Branch of our Consortium Bank (e.g. if a BG is to be issued by SBI Frankfurt), the same is acceptable. However, the procedure at **sl.no. b.1** will required to be followed.
 - b.3** The BG issued may preferably be subject to Uniform Rules for Demand Guarantees (URDG) 758 (as amended from time to time). The BG Format provided to them should clearly specify the same.

STATEMENT OF CLAIMS/COUNTER CLAIMS TO BE SUBMITTED TO THE IEC BY BOTH THE PARTIES

1. Chronology of the Disputes
2. Brief of the Contract/MoU/Agreement/LOI/LOA
3. Brief history of the Disputes:
4. Issues:
5. Details of Clam(s)/Counter Claim(s):

Sl. No.	Description of claim(s)/Counter Claim	Amount (in INR)Or currency applicable in the contract	Relevant contract clause

6. Basis/Ground of claim(s)/counter claim(s) (along with relevant clause of contract)

Note– *The Statement of Claims/Counter Claims may ideally be restricted to maximum limit of 20 pages. Relevant documents may be compiled and submitted along with the statement of Claims/Counter Claims. The statement of Claims/Counter Claims is to be submitted to all IEC members and to the other party by post as well as by email.*

FORMAT FOR NOTICE INVOKING CONCILIATION CLAUSE BY BHEL FOR REFERRING THE DISPUTES TO CONCILIATION THROUGH IEC

To,

M/s. (Stakeholder's name)

Subject: **NOTICE FOR INVOCATION OF THE CONCILIATION CLAUSE OF THE CONTRACT BY BHEL**

Ref: Contract No../MoU/Agreement/LOI/LOA& date _____.

Dear Sir/Madam,

As you are aware, with reference to above referred Contract/MoU/Agreement/LOI/LOA, certain disputes have arisen, which, in spite of several rounds of mutual discussions and various correspondences have remained unresolved. The brief particulars of our claims which arise out of the above-referred Contract/MoU/Agreement/LOI/LOA are reproduced hereunder:

Sl. No.	Claim description	Amount involved

As you are aware, there is a provision in the captioned Contract/MoU/Agreement/LOI/ LOA for referring disputes to conciliation.

In terms of Clause -----of Procedure i.e., Annexure ----- to the Contract/MoU /Agreement / LOI / LOA, we hereby seek your consent to refer the matter to Conciliation by Independent Experts Committee to be appointed by BHEL. You are invited to provide your consent in writing to proceed with conciliation into the above mentioned disputes within a period of 30 days from the date of this letter along with details of counter-claims, if any, which you might have with regard to the subject Contract/ MoU/ Agreement/ LOI/ LOA.

Please note that upon receipt of your consent in writing within 30 days of the date of receipt of this letter by you, BHEL shall appoint suitable person(s) from the BHEL Panel of Conciliators.

This letter is being issued without prejudice to our rights and contentions available under the contract and law.

Thanking you
Yours faithfully

Representative of BHEL

Note: The Format may be suitably modified, as required, based on facts and circumstances of the case.

FORMAT FOR NOTICE INVOKING CONCILIATION CLAUSE BY A STAKEHOLDER FOR REFERRING THE DISPUTES TO CONCILIATION THROUGH IEC

To,
BHEL (Head of the Unit/Division/Region/Business Group)

Subject: **NOTICE FOR INVOCATION OF THE CONCILIATION CLAUSE OF THE CONTRACT BY A STAKEHOLDER**

Ref: Contract No../MoU/Agreement/LOI/LOA& date _____.

Dear Sir/Madam,

As you are aware, with reference to above referred Contract/MoU/Agreement/LOI/LOA, certain disputes have arisen, which, in spite of several rounds of mutual discussions and various correspondences have remained unresolved. The brief particulars of our claims which have arisen out of the above- referred Contract/MoU/Agreement/LOI/LOA are enumerated hereunder:

Sl. No.	Claim description	Amount involved

As you are aware, there is a provision in the captioned Contract/MoU/Agreement/LOI/ LOA for referring inter-se disputes of the Parties to conciliation.

We wish to refer the above-said disputes to Conciliation as per the said Clause of the captioned Contract/MoU/Agreement/LOI/ LOA. In terms of Clause -----of Procedure i.e., Annexure ----- to the Contract/MoU /Agreement / LOI / LOA, we hereby invite BHEL to provide its consent in writing to proceed with conciliation into the above mentioned disputes within a period of 30 days from the date of this letter along with details of counter-claims, if any, which it might have with regard to the subject Contract/ MoU/ Agreement/ LOI/ LOA and to appoint suitable person(s) as Conciliator(s) from the BHEL Panel of Conciliators.

This letter is being issued without prejudice to our rights and contentions available under the contract and law.

Thanking you
Yours faithfully

Representative of the Stakeholder

Note: The Format may be suitably modified, as required, based on facts and circumstances of the case.

FORMAT FOR INTIMATION TO THE STAKEHOLDER ABOUT APPOINTMENT OF CONCILIATOR/IEC

To,

M/s. (Stakeholder's name)

Subject: **INTIMATION BY BHEL TO THE STAKEHOLDER AND CONCILIATOR(S) ABOUT APPOINTMENT OF CONCILIATOR/IEC**

Ref: Contract No../MoU/Agreement/LOI/LOA& date _____.

Sir,

This is with reference to letter dated ----- regarding reference of the disputes arising in connection with the subject Contract No/MoU/Agreement/LOI/LOA to conciliation and appointment of Conciliator(s).

In pursuance of the said letter, the said disputes are assigned to conciliation and the following persons are nominated as Conciliator(s) for conciliating and assisting the Parties to amicably resolve the disputes in terms of the Arbitration & Conciliation Act, 1996 and the Procedure --- to the subject Contract/MoU/Agreement/LOI/LOA, if possible.

Name and contact details of Conciliator(s)

- a)
- b)
- c)

You are requested to submit the Statement of Claims or Counter-Claims (strike off whichever is inapplicable) before the Conciliator(s) in Format 30 (enclosed herewith) as per the time limit as prescribed by the Conciliator(s).

Yours faithfully,

Representative of BHEL

CC: To Conciliator(s)... for Kind Information please.

Encl: As above

Note: The Format may be suitably modified, as required, based on facts and circumstances of the case.

PROFORMA OF BANK GUARANTEE (in lieu of RETENTION AMOUNT) F-35

B.G. NO.

Date

In consideration of Bharat Heavy Electricals Limited (hereinafter referred to as the 'Employer' which expression shall unless repugnant to the context or meaning thereof, include its successors and permitted assigns) incorporated under the Companies Act, 1956 and having its registered office at _____¹ through its Unit at.....(name of the Unit) having agreed to exempt (Name of the Vendor / Contractor / Supplier) with its registered office at _____² (hereinafter called the said "Contractor" which term includes supplier), from demand under the terms and conditions of the Contract reference No. _____ dated _____³ valued at Rs.....⁴ (Rupees -----)⁴ (hereinafter called the said Contract), of Retention Amount for the due fulfilment by the said Contractor of the terms and conditions contained in the said Contract, on production of a Bank Guarantee for Rs. _____ 5 (Rupees _____ only),

We ____ (indicate the name and address of the Bank) having its Head Office at _____ (address of the head Office) (hereinafter referred to as the Bank), at the request of _____ [Contractor(s)], being the Guarantor under this Guarantee, do hereby irrevocably and unconditionally undertake to forthwith and immediately pay to the Employer, an amount not exceeding Rs. _____ without any demur, immediately on demand from the Employer and without any reservation, protest, and recourse and without the Employer needing to prove or demonstrate reasons for its such demand.

Any such demand made on the bank, shall be conclusive as regards the amount due and payable by the Bank under this guarantee. However, our liability under this guarantee shall be restricted to an amount not exceeding Rs. _____.

We undertake to pay to the Employer any money so demanded notwithstanding any dispute or disputes raised by the Contractor(s) in any suit or proceeding pending before any Court or Tribunal or Arbitrator or any other authority, our liability under this present being absolute and unequivocal.

The payment so made by us under this guarantee shall be a valid discharge of our liability for payment hereunder and the Contractor(s) shall have no claim against us for making such payment.

We, further agree that the guarantee herein contained shall remain in full force and effect during the period that would be taken for the performance of the said Contract and that it shall continue to be enforceable till all the dues of the Employer under or by virtue of the said Contract have been fully paid and its claims satisfied & the Employer certifies that the terms and conditions of the said Contract have been fully and properly carried out by the said contractor(s) or acceptance of the final bill or discharge of this guarantee by the Employer, whichever is earlier. This guarantee shall initially remain in force upto and including _____⁶ and shall be extended from time to time for such period as may be desired by the Employer. Unless a demand or claim under this guarantee is made on us in writing on or before the _____⁷, we shall be discharged from all the liability under this guarantee thereafter.

PROFORMA OF BANK GUARANTEE (in lieu of RETENTION AMOUNT) F-35

We, _____(indicate the name of the Bank)_____ further agree with the Employer that the Employer shall have the fullest liberty without our consent and without affecting in any manner our obligations hereunder to vary any of the terms and conditions of the said Contract or to extend time of performance by the said contractor(s) from time to time or to postpone for any time or from time to time any of the powers exercisable by the Employer against the said contractor(s) and to forbear or enforce any of the terms and conditions relating to the said Contract and we shall not be relieved from our liability by any reason of any such variation or extension being granted to the said contractor(s) or for any forbearance, act or omission on the part of the Employer or any indulgence by the Employer to the said contractor(s) or by any such matter or thing whatsoever which under the law relating to sureties would but for this provision have effect of so relieving us.

The Bank also agrees that the Employer at its option shall be entitled to enforce this Guarantee against the Bank as a principal debtor, in the first instance without proceeding against the Contractor and notwithstanding any security or other guarantee that the Employer may have in relation to the Contractor's liabilities.

This Guarantee shall not be determined or affected by liquidation or winding up, dissolution or change of constitution or insolvency of the Contractor but shall in all respects and for all purposes be binding and operative until payment of all money payable to the Employer in terms thereof. This guarantee will not be discharged due to the change in the constitution of the Bank or the Contractor(s).

We..... BANK lastly undertake not to revoke this guarantee during its currency except with the previous consent of the Employer in writing.

Notwithstanding anything to the contrary contained hereinabove:

- a) The liability of the Bank under this Guarantee shall not exceed.....⁵
- b) This Guarantee shall be valid up to⁶
- c) Unless the Bank is served a written claim or demand on or before⁷ all rights under this guarantee shall be forfeited and the Bank shall be relieved and discharged from all liabilities under this guarantee irrespective of whether or not the original bank guarantee is returned to the Bank.

We, _____ Bank, have power to issue this Guarantee under law and the undersigned as a duly authorized person has full powers to sign this Guarantee on behalf of the Bank.

Date _____ Day of _____

for_____(indicate the name of the Bank)___

(Signature of Authorized signatory)

- ¹ ADDRESS OF THE EMPLOYER. i.e. Bharat Heavy Electricals Limited
- ² ADDRESS OF THE VENDOR /CONTRACTOR / SUPPLIER.
- ³ DETAILS ABOUT THE NOTICE OF AWARD/CONTRACT REFERENCE
- ⁴ CONTRACT VALUE
- ⁵ BG AMOUNT IN FIGURES AND WORDS
- ⁶ VALIDITY DATE
- ⁷ DATE OF EXPIRY OF CLAIM PERIOD

Note:

1. Units are advised that expiry of claim period may be kept 3-6 months after validity date. It may be ensured that the same is in line with the agreement/ contract entered with the Vendor.

2. The BG should be on Non-Judicial Stamp paper/e-stamp paper of appropriate value as per Stamp Act prevailing in the State(s) where the BG is submitted or is to be acted upon or the rate prevailing in the State where the BG was executed, whichever is higher. The Stamp Paper/e-stamp paper shall be purchased in the name of Vendor/Contractor/Supplier /Bank issuing the guarantee.

3. In line with the GCC, SCC or contractual terms, Unit may carry out minor modifications in the Standard BG Formats. If required, such modifications may be carried out after taking up appropriately with the Unit/Region's Law Deptt.

4. In Case of Bank Guarantees submitted by Foreign Vendors-

a. From Nationalized/Public Sector / Private Sector/ Foreign Banks (BG issued by Branches in India) can be accepted subject to the condition that the Bank Guarantee should be enforceable in the town/city or at nearest branch where the Unit is located i.e. Demand can be presented at the Branch located in the town/city or at nearest branch where the Unit is located.

b. From Foreign Banks (wherein Foreign Vendors intend to provide BG from local branch of the Vendor Country's Bank)

b.1 In such cases, in the Tender Enquiry/ Contract itself, it may be clearly specified that Bank Guarantee issued by **any of the Consortium Banks only** will be accepted by BHEL. As such, Foreign Vendor needs to make necessary arrangements for issuance of Counter- Guarantee by Foreign Bank in favour of the Indian Bank's (BHEL's Consortium Bank) branch in India. It is advisable that all charges for issuance of Bank Guarantee/ counter- Guarantee should be borne by the Foreign Vendor. The tender stipulation should clearly specify these requirements.

b.2 In case, Foreign Vendors intend to provide BG from Overseas Branch of our Consortium Bank (e.g. if a BG is to be issued by SBI Frankfurt), the same is acceptable. However, the procedure at **sl.no. b.1** will required to be followed.

b.3 The BG issued may preferably be subject to Uniform Rules for Demand Guarantees (URDG) 758 (as amended from time to time). The BG Format provided to them should clearly specify the same.

PROCEDURE FOR CONDUCT OF CONCILIATION PROCEEDINGS

1. The proceedings of Conciliation shall broadly be governed by Part-III of the Arbitration and Conciliation Act 1996 or any statutory modification thereof and as provided herein:
2. The party desirous of resorting to Conciliation shall send an invitation/notice in writing to the other party to conciliate specifying all points of Disputes with details of the amount claimed. The party concerned shall not raise any new issue thereafter. Parties shall also not claim any interest on claims/counter-claims from the date of notice invoking Conciliation till the conclusion of the Conciliation proceedings. If BHEL is to initiate Conciliation, then, the invitation to Conciliate shall be extended to the concerned Stakeholder in **Format 31** hereto. Where the stakeholder is to initiate the Conciliation, the notice for initiation of Conciliation shall be sent in **Format-32** hereto.
3. The party receiving the invitation/notice for Conciliation shall within 30 days of receipt of the notice of Conciliation intimate its consent for Conciliation along with its counter-claims, if any.
4. The Conciliation in a matter involving claim or counter-claim (whichever is higher) up to Rs 5 crores shall be carried out by sole Conciliator nominated by BHEL while in a matter involving claim or counter-claim (whichever is higher) of more than Rs 5 crores Conciliation shall be carried out by 3 Conciliators nominated by BHEL. The appointment of Conciliator(s) shall be completed and communicated by the concerned Department/Group of BHEL Unit/Division/Region/Business Group to the other party and the Conciliator(s) within 30 days from the date of acceptance of the invitation to conciliate by the concerned party in the **Format-33**. The details of the Claim, and counter-claim, if any, shall be intimated to the Conciliator(s) simultaneously in **Format-30**.
5. The Parties shall be represented by only their duly authorized in-house executives/officers and neither Party shall be represented by a Lawyer.
6. The first meeting of the IEC shall be convened by the IEC by sending appropriate communication/notice to both the parties as soon as possible but not later than 30 days from the date of his/their appointment. The hearings in the Conciliation proceeding shall ordinarily be concluded within two (2) months and, in exceptional cases where parties have expressed willingness to settle the matter or there exists possibility of settlement in the matter, the proceedings may be extended by the IEC by a maximum of further 2 months with the consent of the Parties subject to cogent reasons being recorded in writing.
7. The IEC shall thereafter formulate recommendations for settlement of the Disputes supported by reasons at the earliest but in any case within 15 days from the date of conclusion of the last hearing. The recommendations so formulated along with the reasons shall be furnished by the IEC to both the Parties at the earliest but in any case within 1 month from the date of conclusion of the last hearing.
8. Response/modifications/suggestions of the Parties on the recommendations of the IEC are to be submitted to the IEC within time limit stipulated by the IEC but not more than 15 days from the date of receipt of the recommendations from the IEC.

9. In the event, upon consideration, further review of the recommendations is considered necessary, whether by BHEL or by the other Party, then, the matter can be remitted back to the IEC with request to reconsider the same in light of the issues projected by either/both the Parties and to submit its recommendations thereon within the following 15 days from the date of remitting of the case by either of the Parties.
10. Upon the recommendations by the Parties, with or without modifications, as considered necessary, the IEC shall be called upon to draw up the Draft Settlement Agreement in terms of the recommendations.
11. When a consensus can be arrived at between the parties only in regard to any one or some of the issues referred for Conciliation the draft Settlement Agreement shall be accordingly formulated in regard to the said Issue(s), and the said Settlement Agreement, if signed, by the parties, shall be valid only for the said issues. As regards the balance issues not settled, the parties may seek to resolve them further as per terms and conditions provided in the contract.
12. In case no settlement can be reached between the parties, the IEC shall by a written declaration, pronounce that the Conciliation between the parties has failed and is accordingly terminated.
13. Unless the Conciliation proceedings are terminated in terms of para 22 (b), (c) & (d) herein below, the IEC shall forward his/its recommendations as to possible terms of settlement within one (1) month from the date of last hearing. The date of first hearing of Conciliation shall be the starting date for calculating the period of 2 months.
14. In case of 3 members IEC, 2 members of IEC present will constitute a valid quorum for IEC and meeting can take place to proceed in the matter after seeking consent from the member who is not available. If necessary, videoconferencing may be arranged for facilitating participation of the members. However, the IEC recommendations will be signed by all members. Where there is more than one (1) Conciliator, as a general rule they shall act jointly. In the event of differences between the Members of IEC, the decision/recommendations of the majority of the Members of IEC shall prevail and be construed as the recommendation of the IEC.
15. The Draft Settlement Agreement prepared by the IEC in terms of the consensus arrived at during the Conciliation proceedings between the Parties shall be given by the IEC to both the parties for putting up for approval of their respective Competent Authority.
16. Before submitting the draft settlement agreement to BHEL's Competent Authority viz. the Board Level Committee on Alternative Dispute Resolution (BLCADR) for approval, concurrence of the other party's Competent Authority to the draft settlement agreement shall be obtained by the other party and informed to BHEL within 15 days of receipt of the final draft settlement agreement by it. Upon approval by the Competent Authority, the Settlement Agreement would thereafter be signed by the authorized representatives of both the Parties and authenticated by the members of the IEC.
17. In case the Draft Settlement Agreement is rejected by the Competent Authority of BHEL or the other Party, the Conciliation proceedings would stand terminated.

18. A Settlement Agreement shall contain a statement to the effect that each of the person(s) signing thereto (i) is fully authorized by the respective Party(ies) he/she represents, (ii) has fully understood the contents of the same and (iii) is signing on the same out of complete freewill and consent, without any pressure, undue influence.
19. The Settlement Agreement shall thereafter have the same legal status and effect as an arbitration award on agreed terms on the substance of the dispute rendered by an arbitral tribunal passed under section 30 of the Arbitration and Conciliation Act, 1996.
20. Acceptance of the Draft Settlement Agreement/recommendations of the Conciliator and/or signing of the Settlement Agreement by BHEL shall however, be subject to withdrawal/closure of any arbitral and/or judicial proceedings initiated by the concerned Party in regard to such settled issues.
21. Unless otherwise provided for in the agreement, contract or the Memorandum of Understanding, as the case may be, in the event of likelihood of prolonged absence of the Conciliator or any member of IEC, for any reason/incapacity, the Competent Authority/Head of Unit/Division/Region/Business Group of BHEL may substitute the Conciliator or such member at any stage of the proceedings. Upon appointment of the substitute Conciliator(s), such reconstituted IEC may, with the consent of the Parties, proceed with further Conciliation into the matter either de-novo or from the stage already reached by the previous IEC before the substitution.
22. The proceedings of Conciliation under this Scheme may be terminated as follows:
- On the date of signing of the Settlement agreement by the Parties; or,
 - By a written declaration of the IEC, after consultation with the parties, to the effect that further efforts at conciliation are no longer justified, on the date of the declaration; or,
 - By a written declaration of the Parties addressed to the IEC to the effect that the Conciliation proceedings are terminated, on the date of the declaration; or,
 - By a written declaration of a Party to the other Party and the IEC, if appointed, to the effect that the Conciliation proceedings are terminated, on the date of the declaration; or,
 - On rejection of the Draft Settlement Agreement by the Competent Authority of BHEL or the other Party.
23. The Conciliator(s) shall be entitled to following fees and facilities:

SI No	Particulars	Amount
1	Sitting fees	Each Member shall be paid a Lump Sum fee of Rs 75,000/- for the whole case payable in terms of paragraph No. 27 herein below.
2	Towards drafting of settlement agreement	In cases involving claim and/or counter-claim of up to Rs 5crores. Rs 50,000/- (Sole Conciliator)

SI No	Particulars	Amount
		<p>In cases involving claim and/or counter-claim of exceeding Rs 5 crores but less than Rs 10 crores. Rs 75,000 (per Conciliator)</p> <p>In cases involving claim and/or counter-claim of more than Rs 10 crores. Rs 1,00,000/- (per Conciliator)</p> <p>Note: The aforesaid fees for the drafting of the Settlement Agreement shall be paid on the, Signing of the Settlement Agreement after approval of the Competent Authority or Rejection of the proposed Settlement Agreement by the Competent Authority of BHEL.</p>
3	Secretarial expenses	<p>Rs 10,000/- (one time) for the whole case for Conciliation by a Sole Member IEC.</p> <p>Where Conciliation is by multi member Conciliators – Rs 30,000/- (one time)- to be paid to the IEC</p>
4	<p>Travel and transportation and stay at outstation Retired Senior Officials of other Public Sector Undertakings (pay scale wise equivalent to or more than E-8 level of BHEL)</p> <p>Others</p>	<p>As per entitlement of the equivalent officer (pay scale wise) in BHEL.</p> <p>As per the extant entitlement of whole time Functional Directors in BHEL.</p> <p>Ordinarily, the IEC Member(s) would be entitled to travel by air Economy Class.</p>
5	Venue for meeting	<p>Unless otherwise agreed in the agreement, contract or the Memorandum of Understanding, as the case may be, the venue/seat of proceedings shall be the location of the concerned Unit / Division / Region / Business Group of BHEL. Without prejudice to the seat/venue of the Conciliation being at the location of concerned BHEL Unit / Division / Region / Business Group, the IEC after consulting the Parties may decide to hold the proceedings at any other place/venue to facilitate the proceedings. Unless, Parties agree to conduct Conciliation at BHEL premises, the venue is to be arranged by either Party alternately.</p>

SI No	Particulars	Amount

24. The parties will bear their own costs including cost of presenting their cases/evidence/witness(es)/expert(s) on their behalf. The parties agree to rely upon documentary evidence in support of their claims and not to bring any oral evidence in IEC proceedings.
25. If any witness(es) or expert(s) is/are, with the consent of the parties, called upon to appear at the instance of the IEC in connection with the matter, then, the costs towards such witness(es)/expert(s) shall be determined by the IEC with the consent of the Parties and the cost so determined shall be borne equally by the Parties.
26. The other expenditures/costs in connection with the Conciliation proceedings as well as the IEC's fees and expenses shall be shared by the Parties equally.
27. Out of the lump sum fees of Rs 75,000/- for Sitting Fees, 50% shall be payable after the first meeting of the IEC and the remaining 50% of the Sitting Fees shall be payable only after termination of the conciliation proceedings in terms of para 22 hereinabove.
28. The travelling, transportation and stay at outstation shall be arranged by concerned Unit as per entitlements as per Serial No. 4 of the Table at para 23 above, and in case such arrangements are not made by the BHEL Unit, the same shall be reimbursed to the IEC on actuals limited to their entitlement as per Serial No. 4 of the Table at Para 23 above against supporting documents. The IEC Member(s) shall submit necessary invoice for claiming the fees/reimbursements.
29. The Parties shall keep confidential all matters relating to the conciliation proceedings. Confidentiality shall extend also to the settlement agreement, except where its disclosure is necessary for purposes of its implementation and enforcement or as required by or under a law or as per directions of a Court/Governmental authority/ regulatory body, as the case may be.
30. The Parties shall not rely upon or introduce as evidence in any further arbitral or judicial proceedings, whether or not such proceedings relate to the Disputes that is the subject of the Conciliation proceedings:
 - a. Views expressed or suggestions made by the other party in respect of a possible settlement of the Disputes;
 - b. admissions made by the other party in the course of the Conciliator proceedings;
 - c. proposals made by the Conciliator;
 - d. The fact that the other Party had indicated his willingness to accept a proposal for settlement made by the Conciliator.
31. The Parties shall not present the Conciliator(s) as witness in any Alternative Dispute Resolution or Judicial proceedings in respect of a Disputes that is/was the subject of that particular Conciliation proceeding.

- 32.** None of the Conciliators shall act as an arbitrator or as a representative or counsel of a Party in any arbitral or judicial proceeding in respect of a Disputes that is/was the subject of that particular Conciliation proceeding.
- 33.** The Parties shall not initiate, during the Conciliation proceedings, any arbitral or judicial proceedings in respect of a Disputes that is the subject matter of the Conciliation proceedings except that a Party may initiate arbitral or judicial proceedings where, in his opinion, such proceedings are necessary for preserving his rights including for preventing expiry of period of limitation. Unless terminated as per the provisions of this Scheme, the Conciliation proceedings shall continue notwithstanding the commencement of the arbitral or judicial proceedings and the arbitral or judicial proceedings shall be primarily for the purpose of preserving rights including preventing expiry of period of limitation.
- 34.** The official language of Conciliation proceedings under this Scheme shall be English unless the Parties agree to some other language.



HSEP14

Health, Safety & Environment Plan for Site Operations by Subcontractors

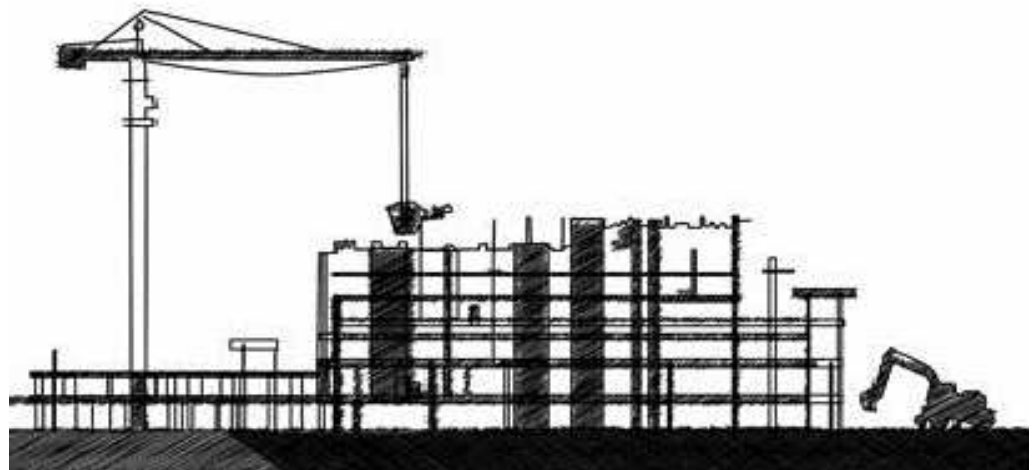

INDEX OF CONTENTS

SN	Description	Page No.
SECTION A: CRITICAL RESOURCES FOR HSE IMPLEMENTATION		
1	SHARING OF OPERATING COSTS OF FACILITIES	5
2	RESOURCES TO BE SOLELY PROVIDED BY CONCERNED SUBCONTRACTOR	5
3	ESTABLISHMENT OF COMMON FACILITIES	5
4	CRITICAL REQUIREMENTS W.R.T. EQUIPMENT & PPES	6
5	HSE PERSONNEL TO BE SOLELY PROVIDED BY THE SUBCONTRACTOR	8
6	COMPETENCY OF OPERATORS/ DRIVERS OF CRANE, WINCH, LIFTING/ CONSTRUCTION EQUIPMENT ETC.	11
7	STRINGENT REQUIREMENT OF BHEL'S CUSTOMER	11
8	REFERENCES	11
9	BHEL POWER SECTOR HSE MANAGEMENT SYSTEM	12
10	CLEARANCE OF MONTHLY RUNNING BILLS SUBJECT TO SAFETY COMPLIANCE	13
11	HSE PERFORMANCE EVALUATION	13
12	HSE PENALTIES	13
13	PUNITIVE ACTIONS ON WORKERS FOR CRITICAL SAFETY VIOLATIONS	16
14	LEGAL IMPLICATIONS	17
15	HSE REVIEW MEETING	17
16	OTHER REQUIREMENTS	18
17	MEMORANDUM OF UNDERSTANDING	19
SECTION B: OPERATIONAL REQUIREMENTS		
1	PURPOSE	22
2	SCOPE	22
3	OBJECTIVES AND TARGETS	22
4	BHEL HEALTH, SAFETY & ENVIRONMENT POLICY	23
5	ILLUSTRATIVE HSE RESPONSIBILITIES OF VARIOUS SUBCONTRACTOR OFFICIALS	24
6	HSE PLANNING BY SUBCONTRACTOR	27
7	MOBILIZATION OF MACHINERY/EQUIPMENT/TOOLS BY SUBCONTRACTOR	28
8	MOBILIZATION OF MANPOWER BY SUBCONTRACTOR	28
9	PROVISION OF PERSONAL PROTECTIVE EQUIPMENT (PPES)	29
10	ARRANGEMENT OF INFRASTRUCTURE	31
11	HSE TRAINING & AWARENESS	35
12	HSE COMMUNICATION AND PARTICIPATION	39
13	SAFETY DURING WORK EXECUTION	

14	ENVIRONMENTAL CONTROL & SOCIAL RESPONSIBILITY	43
15	HOUSEKEEPING	44
16	WASTE MANAGEMENT	44
17	TRAFFIC MANAGEMENT SYSTEM	45
18	EMERGENCY PREPAREDNESS AND RESPONSE	48
19	HSE INSPECTION	49
20	TERMS AND DEFINITIONS	52
	ANNEXURES	
A	ANNEXURE A: Specification of Ambulance	
A.1	ANNEXURE A.1: Typical calculation for sharing of operational cost of common facilities	
B	ANNEXURE B: Specifications of HSE Displays	
C	ANNEXURE C: HSE Tools, Equipment and Devices to be Provided by the Subcontractor	
D	ANNEXURE D: Specifications of Rest Sheds	
E	ANNEXURE E: Minimum Requirements of Labor Accommodation/ Colony	
F	ANNEXURE F: Specifications & Availability for Toilets at Site	
G	ANNEXURE G: Specifications for Numbers and Types of Fire Extinguishers	
H	ANNEXURE H: HSE Compliance Certificate Sample	
I	ANNEXURE I: Detailed Safety Requirements/ Precautions for Various Hazardous Activities/ Conditions	
J	ANNEXURE J: Details & Contents of First-Aid Box	
K	ANNEXURE K: Vertigo Test Procedure	

SECTION A

CRITICAL RESOURCES FOR HSE IMPLEMENTATION

1. SHARING OF OPERATING COSTS OF FACILITIES

TABLE A.1

SN	FACILITY
1	Ambulance with 24 hr. First Aid Trained Driver (Specs in Annexure A)
2	Operation of Medical center, Nurses, Medical Consumables etc. (Specs in Annexure A)
3	Training Center Consumables
4	Water sprinkling for dust suppression
	(Others:)

Note:

- i. Responsibility of operation of above facilities shall rest with BHEL
- ii. Operating cost of the above shall be deducted from subcontractors on 'proportional to contract' value basis. Sample deduction table enclosed as Annexure A.1
- iii. "Contract value" defined above & subsequently in the document shall be considered as "Awarded contract value".
- iv. No overhead cost/ enabling cost of BHEL shall be levied on the contractors for common facilities.
- v. These running costs shall be recovered from all the available subcontractors at site for the complete operational duration of the site
- vi. No overheads shall be charged on shared operating costs

2. RESOURCES TO BE PROVIDED SOLELY BY THE SUBCONTRACTOR

TABLE A.2

SN	ITEM	SPECIFICATIONS
1.	HSE DISPLAYS, Posters and signage	Annexure B
2.	HSE Tools/ Equipment/ Devices	Annexure C
3.	Rest Sheds for Workers	Annexure D
4.	Labor Colony	Annexure E
5.	Toilets (Latrines & Urinals) - in Site and Labor Colony	Annexure F
6.	Fire Extinguishers	Annexure G

Note:

In case subcontractor fails to provide the required resources, same will be procured and deployed by BHEL with applicable overhead on total procurement cost

3. ESTABLISHMENT OF COMMON FACILITIES

In green field projects BHEL shall arrange and provide the following facilities which shall be used by all subcontractors for their employees and workers. These shall be

- i. Medical Centre
- ii. Safety park with facilities of audio-visual training & vertigo test center.
- iii. No cost shall be deducted from the subcontractors for the structure part only.
- iv. The running cost with basic inputs already mentioned at Point 1 above shall be shared by all contractors.
- v. The sub-contractors shall be required to ensure participation in trainings, medical checkup and vertigo test as per the guidelines laid in this document and required as per statutory HSE requirements.

- vi. However, in projects where in these facilities are not provided by BHEL, subcontractors shall ensure the training, medical/ vertigo test of all workers at site in consultation and guidance of BHEL HSE team at site in line with provisions of this document.
- vii. The overall onus of compliance to HSE practices pertaining to training, medical checkup including vertigo test shall lie on the subcontractor only.

4. CRITICAL REQUIREMENTS W.R.T. EQUIPMENT & PPES

- i. Conventional Hydra crane with carriage in front shall not be permitted. Pick & carry tyre mounted Front Cabin mobile crane (FX or TRX/ NextGen series of 'ESCORT' or equivalent make) shall only be permitted.
- ii. Any Heavy equipment (cranes, winch machines, etc.) shall be deployed only after pre-safety Inspection by safety dept. Valid AMCs/ Fitness/ other statutory clearances as per local rules shall be required to be submitted before mobilizing the equipment at site.
- iii. All other Hand tools and power tools should not be older than 5 years.
- iv. For Chimney passenger lift, winch to have double drum rope for passenger and double safety devices must be used. Winch should not more than 3 years old and winch rope must be inspected with valid certificate from competent authority within 6 months and should meet the IS standard 9507 provision of OLR and push back button arrangement or dead man switch.
- v. Gate pass for all the lifting T&Ps and construction machinery/ equipment shall be made after obtaining written acceptance (Pre-entry Safety Clearance) from BHEL Site Safety Department after physical verification and checking all requisite documents/ compliance to Safety norms
- vi. All motor vehicles should have valid registration certificate, insurance, Pollution under control (PUC) and fitness certificate as per Motor Vehicle Act 2020. The certificates should be pasted in the glass from inside.
- vii. PPEs shall be from reputed manufactures viz. 3M, Udyogi, Karam, Frontier, Freedom, Honeywell, Liberty, Bata, Nomex, Acme, Unicare, Life Gear or equivalent. In case Subcontractor recommends any other name the same can be approved at site level by the Construction manager & Site HSE
- viii. For height work, where fall could result in death or disability, a secondary means of fall protection (Safety Net, Retractable Fall Arrestor etc.) shall be mandatorily provided by the subcontractor, failing which, a penalty of INR 10000 per case will be imposed. In addition, there should be constant supervision for such critical height work. Any non-erection activities at height eg. Housekeeping etc. shall also fall under the category of height work
- ix. **Scaffold Tagging**

Scaffolds being erected, modified or dismantled must be tagged as suitable for use. Tagging shall be done with standard tag holder. Scaffolding tag should be certified by scaffolding inspector having valid certificate.

- **GREEN** scaffold tag- shall be fixed when scaffold is complete and safe for use, signed and dated by the scaffolding competent person daily.
- **RED** scaffold tag – to be fixed if scaffold is in some way defective and cannot be used or is still under erection.
- **YELLOW** scaffold tag – to be fixed if scaffold is in under construction/ maintenance.



FIG. A.4.1 SAMPLE SCAFFOLD TAGS AND TAG HOLDER

x. **T&P Color Coding:**

- a. Inspections and tests shall be documented by means of color coding which shall verify that inspections or testing are current and that all receptacles, portable Power tools, Lifting Tools & Tackles have been inspected and tested as required. The color codes used on the project shall be:

GREEN	BLUE	YELLOW	PURPLE
January	April	July	October
February	May	August	November
March	June	September	December

TABLE. A.4.2: T&P COLOR CODES

- b. The cycle of colors shall be Quarterly as a minimum or as decided by BHEL. The color code tape / Sticker shall be clearly visible to designate the period for which the inspections and tests were conducted.
- c. Following the initial inspection, the equipment must be color-coded quarterly as per color-coding instructions that will be issued by the subcontractor.
- d. Fire extinguisher with the current month color-coding inspection sticker must be provided and secured in the platform.
- e. All slings shall be regularly inspected in accordance with the requirement of the project for frequent and periodic inspections and discard immediately if they fail to meet the minimum requirements of the project.
- f. The Subcontractor’s HSE Officer shall ensure that all PPE is inspected prior to its issue. He is to ensure all subcontractor personnel are using safe and proper PPE equipment.

inspections on the PPE shall be carried out and personnel not adhering to those inspections shall be removed immediately from the site.

- g. A Ten (10) day interval period shall be given into each monthly color code change. During this Ten (10) day period either color shall be acceptable.

xi. **T&P Tagging:**

All deployed Wire Rope Slings, Chain Pulley Blocks, Hooks, slings etc. shall be Tagged using aluminum or any other metal tag with punching.

5. HSE PERSONNEL TO BE PROVIDED SOLELY BY THE SUBCONTRACTOR

5.1. NUMBERS OF HSE PERSONNEL (APPLICABLE FOR EACH WORK SHIFT)

Number of HSE Officers and Supervisors shall be in proportion to number of workers as per Table A.6 below

TABLE A.5

No. of Workers	No. of HSE Supervisors	No. of HSE Officers
Up to 100	1	1
101 to 250	2	1
251 to 500	4	1
501 to 1000	6	2
1000 to 2000	6+ One additional supervisor up to every additional 250 workers	3
2000-3000	10+ One additional supervisor up to every additional 250 workers	4
3000-4000	14+ One additional supervisor up to every additional 250 workers	5

5.1.1. DEPLOYMENT PLAN

- i. Above requirement is for every shift for each unit.
- ii. The dynamic deployment plan of Safety manpower at various locations containing names, areas, time periods, shifts etc. shall be submitted to BHEL for approval by subcontractor
- iii. BHEL may modify the deployment plan based on nature and volume of jobs, Risks and hazards associated etc.
- iv. For less than 20 workers HSE Officer is not mandatory. In case the number of workers exceed 20 for 3 consecutive months, HSE Officer is to be engaged. The HSE Officer shall be deployed for a minimum period of 6 months even if the number of workers fall below 20 in any month subsequent to deployment. If within that 6-month period, the number of workers is more than 20 for at least 3 months, the deployment duration of HSE Officer will extend further 6 months after completion of previous 6-month period.
- v. For Site Material Management/ Handling (Loading/ Unloading) contracts, 1 no. HSE Officer shall be required irrespective of the total manpower deployed.
- vi. HSE Officers/Supervisors of all the vendors may be required to report directly to BHEL HSE Officer at site & shall comprise as a total team for handling all HSE issues. However, each safety officer/ agency shall be individually responsible for the safe execution of work in their respective areas.



5.2. QUALIFICATION & EXPERIENCE REQUIREMENTS OF HSE PERSONNEL

5.2.1. HSE OFFICER

First HSE Officer to be mandatorily as per Option I as under and shall be designated Senior HSE Officer. In case of non-availability of HSE Officers with Option I configuration, the subsequent HSE Officers can be as per Option II below with recorded reasons and approval of Site Construction Manager of BHEL. All these deviations should be reported to Region HSE and PSHQ HSE.

A. Option I

- i. possesses a recognized degree in any branch of engineering or technology or architecture and had a practical experience of working in a building or other construction work in a supervisory capacity for a period of not less than two years or possesses a recognized diploma in any branch of engineering or technology and has had practical experience of building or other construction work in a supervisory capacity for a period of not less than five years;
- ii. possesses a recognized degree or diploma in industrial safety with at least one paper in construction safety (as an elective subject/ part thereof);
- iii. has adequate knowledge of the language spoken by majority of building workers from the construction site in which he is to be appointed.

B. Option II:

Graduation Degree in Science with Physics & Chemistry and degree or diploma in Industrial Safety (All Degrees/ Diploma from any Indian institutes recognized by AICTE or State Council of Technical Education of any Indian State) with practical experience of working in a building, plant or other construction works (as HSE Officer, in line with Indian Factories Act, 1958 or BOCW Act, 1996) for a period of not less than five years

Note:

- i. HSE Officer as per Option II shall be valid only on availability of Senior HSE Officer as per Option I at site.
- ii. In case of resignation of the Senior HSE Officer, the same has to be replaced within 15 days else all subsequent HSE Officers as per Option II (in case of multiple HSE Officers with a single agency) shall not be considered as valid.
- iii. The penalty shall be deducted considering non-availability of any HSE Officer at site.

5.2.2. HSE SUPERVISOR: EITHER OF X OR Y BELOW

X. Recognized Degree in any branch of Engineering OR Diploma in any branch of engineering with at least one-year construction experience

OR

Y. A recognized graduation Degree in Science (with Physics & Chemistry) or a recognized diploma in Engg. or Tech.

Additional requirements for option (Y) above

Bharat Heavy Electricals Limited, Power Sector

Regd. Office: BHEL House, Siri Fort, New Delhi-110049



- i. Trained in fire-fighting as well as in safety / occupational health related subjects, with:
- ii. Minimum Two years of practical experience in construction work environment or in the field of safety and

Note:

- i. Option a above is by default, b is under special approval from Site HSE & Construction manager
- ii. In both cases the candidate should possess requisite skills to deal with construction & fire safety related day-to-day issues.

5.3. HSE IN-CHARGE

In case there is more than one HSE Officer with any subcontractor, one of them, who is senior most by experience & meets qualification as per option 1 as mentioned in clause 2.1 A above (in HSE discipline), may be designated as HSE In-charge who will be the nodal point of contact on HSE matters.

5.4. SUPPORTING STAFF TO HSE TEAM

- i. Supporting Staff shall include scaffolders, scaffolding inspectors, riggers, skilled and unskilled manpower
- ii. Subcontractor shall provide adequate number of workers as and when required, in order to attend and comply to Safety observations raised by BHEL/ Customer.

5.5. AVAILABILITY AND PENALTY FOR NON-DEPLOYMENT

- i. The subcontractor shall submit the certificates of qualification & experience of HSE manpower before deployment for BHEL to assess suitability as per requirement detailed in this document
- ii. In case of rejection, subcontractor shall arrange additional candidates and submit resume to BHEL. Penalties will be applicable during the period of non-deployment in such cases as well.
- iii. Subcontractor shall ensure physical availability of safety personnel at the place of specific work locations.
- iv. The Subcontractor shall deploy the HSE Officers as per the site's requirement. Non-deployment shall lead to stoppage of the work and final decision shall rest with Site HSE & Construction manager.
- v. The Subcontractor shall prepare an organization chart identifying the areas of operations, responsibilities and reporting structure of all safety personnel for each shift and submit the same to BHEL.
- vi. The subcontractor shall deploy sufficient HSE Officers, supervisors, as per numbers & qualifications mandated in this Section since mobilization of first batch of manpower and add more in proportion to the added strength in work force. Any delay in deployment will attract a penalty at following rates:

Non-deployment of HSE Officer –	Rs. 75,000 per man-month
Non-deployment of HSE Supervisor –	Rs. 50,000 per man-month

- vii. Penalty shall be collected for the period of non-availability of safety personnel after allowing a grace period of 15 days for finding a replacement. The same shall be deducted on pro-rata basis till the required manpower is deployed.
- viii. In case of abnormal delay & frequent rejections of candidates proposed by the subcontractor, BHEL shall exercise the right to deploy the safety manpower & deduct the amount from subcontractor's running bill with applicable overheads. In such cases also, the provision of logistics, transportation, food and other logistical support to the HSE personnel shall be in the scope of subcontractor in addition to the salary. After deployment of manpower by BHEL, the penalty for non-deployment specified above shall not be applicable.

6. COMPETENCY OF OPERATORS/ DRIVERS OF CRANE, WINCH, LIFTING/ CONSTRUCTION EQUIPMENT ETC.

- i. The Operators/ Drivers of crane, winch, construction/ lifting equipment etc. shall be experienced and have valid driving license for the class of vehicle / machinery as applicable (like Crane/ Forklift/ Rig, Construction equipment driving license etc.).
- ii. Minimum HMV driving license is required for all heavy equipment/ heavy vehicle (trailer/ Hyva /dumper /TM) operators at site.
- iii. The subcontractor shall certify competence of these persons in writing as and when they are posted at site.
- iv. Crane, Winch, Construction & lifting equipment operator should have certificate on subject course or experience certificate in employer letterhead.
- v. Where state is providing license for operating crane, tractor and other construction vehicles, same to be ensured.

Note: In case the statutory requirements i.e. State or Central Acts and / or Rules as applicable like the Building and Other Construction Workers' Regulation of Employment and Conditions of Service- Act,1996 or State Rules (wherever notified), the Factories Act, 1948 or Rules (wherever notified), etc. are more stringent than above, the same shall be followed.

7. In case of any stringent requirement of BHEL's customer over and above the specifications mentioned in current document, the same shall also be required to be complied at site by subcontractor.

8. REFERENCES

The Safety Rules for Construction & Erection as outlined hereunder, while setting out a broad parameter of safety norms, are not exhaustive. The subcontractor and his agencies are advised to refer to the following statutory provisions as amended from time to time for details and strict compliance therewith.

8.1. FOR GREENFIELD PROJECTS

- a) Building and Other Construction Workers (regulation of employment and conditions of service) Act, 1996 (briefly referred to as BOCW Act),
- b) Building and other construction workers (regulation of employment and conditions of service) Central Rules, 1998 (briefly referred to as BOCW Rules) as adopted by the various State Governments,

8.2. FOR EXPANSION, MODIFICATION, ALTERATION AND, OR CONSTRUCTION ACTIVITY WITHIN AN EXISTING PLANT OPERATING AS PER APPROVED SITE PLAN UNDER THE FACTORIES ACT

- a) Factories Act, 1948,
- b) Factories Rules, as adopted by the various State Governments
- c) BOCW Act
- d) BOCW Rules
- e) In case a new act/ statutory guideline/ modification/ consolidation of acts is implemented the same shall be required to be adhered by the subcontractor.
- f) The latest amendment of the above-mentioned acts/ rules shall be followed at site.

9. BHEL POWER SECTOR HSE MANAGEMENT SYSTEM

The Systems and procedures of BHEL Power Sector HSE Management System shall be implemented by the subcontractor, including:

- HSE PROCEDURE FOR REGISTER OF OHS HAZARDS AND RISKS
- HSE PROCEDURE FOR REGISTER OF ENVIRONMENTAL ASPECTS AND IMPACTS
- HSE PROCEDURE FOR REGISTER OF REGULATIONS
- HSE PROCEDURE FOR TRAINING AND AWARENESS
- HSE PROCEDURE FOR EMERGENCY PREPAREDNESS AND RESPONSE PLAN
- HSE PROCEDURE FOR PERMIT TO WORK
- HSE INSPECTION AND OTHER FORMATS

Note:

- i. BHEL reserves the right to revise/ update these systems and procedure as per requirement to address any changing HSE needs
- ii. BHEL will provide hard / soft copies of applicable HSE Procedures, Work Permits, Operational Control Procedures, Inspection/ Other Formats etc. that are necessary for ensuring safe work to the successful bidder at Site. It is the responsibility of the subcontractor to ensure availability of these documents before commencing work at site.
- iii. The subcontractor can get soft copies of these documents from respective Region SCT/ HSE for reference. The signed hard copies of the same shall not be required to be submitted along with tender document
- iv. Subcontractor shall use the Digital (Web & App-Based) HSE management Software Systems provided by BHEL whenever provided. In case not provided, hard copy systems will continue to be used. All information technology resources (Computers, mobile phones, mobile data, internet access etc.) for the use of such systems shall be ensured by the subcontractor.

10. CLEARANCE OF MONTHLY RUNNING BILLS SUBJECT TO SAFETY COMPLIANCE

- i. The monthly running Bills of the subcontractor shall be released subject to compliance to HSE requirements as per checklist in Annexure H
- ii. BHEL site HSE Head and Package In-charge shall be authorized to issue the clearance
- iii. Site Construction Manager of BHEL shall be the final authority on the matter.

11. HSE PERFORMANCE EVALUATION

- i. Subcontractor shall be assessed on monthly basis for HSE Compliance by BHEL Safety In-charge at site.
- ii. The HSE evaluation shall be based on HSE Performance Evaluation System of BHEL covering the contractual, statutory and regulatory requirements of HSE.
- iii. BHEL shall reserve the right to use these performance scores for evaluating bidder's capacity for future tenders
- iv. If safety record of the subcontractor in execution of the awarded job is to the satisfaction of safety department of BHEL, issue of an appropriate certificate to recognize the safety performance of the subcontractor may be considered by BHEL after completion of the job, provided the execution performance is satisfactory.

12. HSE PENALTIES

- i. Nonconformity of safety rules and safety appliances will be viewed seriously and BHEL has right to impose fines on the subcontractor for every instance of violation noticed.
- ii. As per contractual provision HSE penalties shall be imposed on subcontractors for non-compliance on HSE requirement as per following format.
- iii. Following are the applicable penalties for various Safety violations:

Sub: MEMO for Penalty for non-compliances in Safety

Following lapse (tick marked) was observed and penalty (in Rs.) is imposed as stated at the bottom of this memo. It is requested that such occurrences be please avoided in future.

S. No	Nature of Non - Compliance	Penalty (in INR)	Remarks
A. System Violations			
1	Working without valid Work Permit/ HIRA/ Method Statement / JSA	2000	Per case
2	Controls as per Work Permit/ HIRA/MS/JSA not ensured	2000	Per case
3	Reported Safety Violations Not Closed within Stipulated Time	1000-10000	Per case
4	Absence of required Subcontractor Officials (Site Head, HS Head) in Safety Reviews/Meetings	5000	Per case
5	Not providing required PPEs (Safety Harness, Lifeline, Safety Net, Fall arrestor, Safety Helmet, Gloves, Shoes etc.) for the work by subcontractor	2000	Per case
B. Competency/ Training/ Induction Violations			

1	Incompetent personnel deployed for specialized jobs like height work, hot work, rigging, vehicle operation etc. (without valid license/ certificate etc.)	3000	Per case
2	Work without induction training & medical check	2000	Per case
3	Height Work without Vertigo Test and height work training	2000	Per case
C. PPE Violations – Height Work			
1	Not wearing/ hooking Double Lanyard Safety Harness while working at height (> 1.2 meters) or not anchoring to lifeline	1000	Per case
2	Not Providing Lifeline for height work	3000	
3	Unsafe platforms – without Top, Mid Rails and Toe-Guards for Height Work	3000	
4	Not providing secondary means of fall protection for height work (Safety Nets, Retractable Fall Arrestors etc.)	3000	Per case
D. PPE Violations – General			
1	Not wearing safety helmet	1000	Per case
2	Wearing of helmets without chin straps	1000	Per case
3	Not Wearing safety shoes	500	Per case
4	Not wearing gloves	500	Per case
6	Not using grinding goggles/ face shield during grinding/ cutting	2000	Per case
E. Electrical Safety Violations			
1	Broken/ exposed wires/ cables	2000	Per case per day
2	Electrical plug not used for connection/ hand machines	1000	Per case per day
3	Not using proper ELCBs for electrical equipment	2000	Per case per day
4	Improper earthing of welding & Other electrical machines (Lack of double earthing, improper/ untested earth pit etc.)	2000	Per case per day
5	Not using 24 V supply for lighting in confined spaces	2000	Per case
6	Cables haphazard/ blocking way/ not organized properly	1000	Per case per day
F. Lifting & Rigging Violations			
1	Using Sling/ Chain Pulley Block and other Small T&Ps without proper, traceable Tag and Test Certificate	2000	Per T&P per day
2	Using damaged slings or not slinging properly	2000	Per T&P per day
3	Use of lifting equipment without having valid Test certificate	5000	Per equipment per seven days
4	Lifting hooks used without latches	2000	Per hook per day
5	Not effectively barricading area below lifting activity	5000	Per case
6	Using untrained/ unqualified rigger	5000	Per case
G. Housekeeping			
1	Non-removal of scrap from platforms	5000	Per Event Per location per 7 days
2	Not conducting scheduled housekeeping drives	5000	Per drive
H. Hot Work Safety Violations			
1	Gas cutting without flash back arrestor at both ends	5000	Per machine per incidence
2	Gas cutting at height without fire blanket	2000	Per event

3	Not keeping gas cylinders vertically	2000	Per event
4	Lifting cylinders without cage or rolling of cylinders	2000	Per incidence
5	Leakage in gas cylinder	2000	Per incidence
I. Vehicle Safety/ Operation			
1	Not having valid driving license for the type of vehicle/ T&P	2000	Per driver per incidence
2	Two-wheeler entry in construction area	2000	Per vehicle
3	Using Hydra for material movement at site in unsafe manner	2000	Per case
4	Using Two Hydra in Tandem for material movement without proper precautions as per OCP	2000	Per case
5	Vehicles, Hydras, Cranes, Dumpers and Earth Movers not having automatic back horns linked to gear	2000	Per Equipment per day
6	Not providing proper hard barricades around excavations/ unpermitted areas	5000	Per location per day
7	Not using guide rope while transporting material using Hydra or Cranes	2000	Per event
8	Over speeding	5000	Per case
9	Using Conventional Hydra crane	50000	Per day /crane
J. Accidents/ Incidents/ Near Misses			
1	Non-reporting of Near Miss/ Incident	20000	Per case
2	Major Accident – Worker unable to resume work within 48 hrs	100000	Per incident
3	Fatal Accident	500000	Per incident
K. Miscellaneous			
1.	Not providing the facility (drinking water, rest shed, labor colony etc. as per the specifications/ requirement)	5000	Per month per violation
2.	Not nominating the required number of workers for training as per plan	5000	Per incidence
3.	Lack of proper arrangement for disposal of sewage/ waste water/ effluents etc.	10000	Per incidence

Details (if any) related to non- compliance (Name of persons, Nature of deficiency, etc.):

Penalty Amount:

1. Rate as per above chart
2. No. of Persons/ machine/ event/ labor
3. No. of times the same error is repeated: Repetition factor
4. Total Penalty= 1. X 2. X 3. =

Witnessed by:

(Sub- Subcontractor representative)
representative)

(BHEL

Signature

Name

- Distribution: 1 Copy: to Sub- subcontractor Site In-charge,
 1 Copy to Site Construction Manager (BHEL)
 1 Copy to Site Finance

Note:

- i. In case the amount of penalty imposed by BHEL’s Client on BHEL for Safety violation/ incident due to or in the area of the subcontractor is more than those indicated above, same shall be imposed back-to-back on the subcontractor. However, in case such an amount is less than the specified above, penalty amount indicated above shall be imposed on the subcontractor.
- ii. For same violation only one penalty (higher of the two mentioned below) shall be applicable
 - a. Penalty imposed by BHEL’s Customer over BHEL.
 - b. Penalty as indicated in current document.
- iii. For repeated violation for the same equipment/ location, the penalty would be double of the previous penalty. Date of “Repeated violation” will be counted from subsequent days.
- iv. For repeated fatal incident in the same Unit incremental penalty shall be imposed: The subcontractor will pay 2 times the previously paid penalty in case there is repeated major/ fatal incident under the same subcontractor for the same package in the same unit.
- v. Any other non-conformity noticed not listed above will also be fined as deemed fit by BHEL. The decision of BHEL engineer is final on the above.
- vi. If principal customer/statutory and regulatory bodies impose some penalty on HSE due to the non-compliance of the subcontractor the same shall be passed on to them.
- vii. The penalty amount shall be recovered by BHEL Finance department from subcontractors from the RA/Final bill.

13. PUNITIVE ACTIONS FOR “CRITICAL SAFETY VIOLATIONS”:

“Critical Safety Violations” include:

- i. Not wearing required PPEs when provided and not following safe work procedure
- ii. Taking unnecessary risks especially in height work, hot work, radiation work, lifting activity
- iii. Coming to work under influence of sedatives like alcohol, drugs etc.
- iv. Coming to work without ID Card/ Gate Pass (if provided)
- v. Intimidating/ threatening at work
- vi. Using cell phones during height work, hot work, lifting activity, driving.

In case any worker carries out any of the critical safety violations as above, BHEL reserves the right to enforce punitive action in following manner:

First Offence:	1 Punch on Gate Pass/ Induction Card/ ID Card etc. and 1-hour HSE Training. With one day off from duty
Second Offence:	2 Punches and 2-hours HSE Training with one day off from duty

Third Offence:	3 Punches and the worker will be dismissed. Gate pass to be confiscated
-----------------------	---

In case any employee of subcontractor carries out any of the critical safety violations as above, subcontractor Site In-charge shall issue warning letter to concerned employee with copy to BHEL

Note:

- i. For above violations, guilt of the worker/ employee has to be established through appropriate evidences and records maintained.
- ii. If worker/ employee has not been given the required PPEs and safety equipment by the agency and/or not facilitated by the agency to follow safety rules, he/ she will not be considered liable but the agency will be penalized as per penalty provision in this document. In such cases, the subcontractor shall not pass the penalty over to the worker/ employee through wage deduction etc.
- iii. These critical safety violations and their consequences shall be shared with all workers and employees during induction and other training programs/ meetings, toolbox talks etc.
- iv. Gate Pass shall have provision of Tagging as indicated above
- v. The appellate authority (only for final dismissal) in this case shall be the BHEL Site In-charge whose decision shall be final on the matter and binding on all parties.

14. LEGAL IMPLICATIONS

Any legal Costs incurred by BHEL, on account of accidents taking place in the activities of the subcontractor, shall be debited to the subcontractor on actual cost basis.

For any accident occurring at site to any worker/ employee of the subcontractor leading to legal implications to BHEL Employee/ Management shall be safeguarded by BHEL legal department. All legal expenses incurred by BHEL on this account shall be recovered from the subcontractor. The accident also includes fire, loss of property or life at site.

15. HSE REVIEW MEETING

- i. Subcontractor Site In-charge and HSE In-charge shall attend the HSE Review Meeting as and when called by BHEL.

The indicative agenda points are given below:

- a) Implementation of earlier MOM points
- b) Compliance Status of HSE Observations
- c) Incidents & Near Misses, their Root Causes and Actions Taken
- d) HSE performance review
- e) HSE inspection findings
- f) HSE audit and CAPA
- g) HSE training
- h) Health check-up camp
- i) HSE planning for the erection and commissioning and installation activities in the coming month

- j) HSE reward and promotional activities
- ii. MOM on the discussion along with HSE observations will be circulated to the subcontractor for action.
- iii. The subcontractor shall close the observations to the satisfaction of BHEL within stipulated time frame

16. OTHER REQUIREMENTS

- i. If the subcontractor fails to improve the standards of safety in its operation to the satisfaction of BHEL after being given reasonable opportunity to do so and/or if the subcontractor fails to take appropriate safety precautions or to provide necessary safety devices and equipment or to carry out instruction regarding safety issued by BHEL, BHEL shall have the right to take corrective steps and the cost shall be debited to the subcontractor with applicable overheads.
- ii. If the subcontractor succeeds in carrying out its job in time without any fatal or disabling injury incident and without any damage to property BHEL may, at its sole discretion, favorably consider to reward the subcontractor suitably for the performance.
- iii. In case of any damage to property due to lapses by the subcontractor, BHEL shall have the right to recover the cost of such damages from the subcontractor after holding an appropriate enquiry.
- iv. The subcontractor shall take all measures at the sites of the work to protect all persons from incidents and shall be bound to bear the expenses of defense of every suit, action or other proceeding of law that may be brought by any persons for injury sustained or death owing to neglect of the above precautions and to pay any such persons such compensation or which may with the consent of the subcontractor be paid to compromise any claim by any such person, should such claim proceeding be filed against BHEL, the subcontractor hereby agrees to indemnify BHEL against the same.
- v. The subcontractor shall not employ men below the age of 18 years and women on the work of painting with products containing lead in any form. Wherever men above the age of 18 are employed on the work of lead painting, overalls shall be supplied by the subcontractor to the workmen and adequate facilities shall be provided to enable the working painters to wash during the cessation of work.
- vi. The subcontractor shall notify BHEL of his intention to bring to site any equipment or material which may create hazard.
- vii. BHEL shall have the right to prescribe the conditions under which such equipment or materials may be handled and the subcontractor shall adhere to such instructions.
- viii. BHEL may prohibit the use of any construction machinery, which according to the organization is unsafe. No claim for compensation due to such prohibition will be entertained by BHEL.

17. MEMORANDUM OF UNDERSTANDING:

After award of work, subcontractors are required to enter into a memorandum of understanding as given below:

Memorandum of Understanding

BHEL, Power Sector Region is committed to Health, Safety and Environment Policy (HSE Policy).

M/s.....do hereby also commit to comply with the same HSE Policy while executing the Contract Number _____

M/s.....have gone through and understood all the HSE requirements of the contract including HSE manpower, tools & equipment, systems & procedures, and agree to fulfill the same as a minimum. Any additional resources and support required for ensuring fulfillment of HSE Objectives shall be provided by subcontractor at no extra cost.

M/s..... agree that in case they fail to comply to the HSE requirements as stipulated in the contract, BHEL shall have the right to implement the same and the cost shall be recovered from the subcontractor with applicable overheads.

M/s..... shall ensure that safe work practices as per the HSE plan. Spirit and content therein shall be imbibed in all workers and supervisors for compliance.

In addition to this, M/s.....shall comply to all applicable statutory and regulatory requirements which are in force in the place of project and any special requirement specified in the contract document of the principal customer.

M/s.....shall co-operate in HSE audits/inspections conducted by BHEL /customer/ third party and ensure to close any non-conformity observed/reported within prescribed time limit.

M/s..... agree that the subcontractor shall seek HSE clearance as per BHEL format before each RA bill as mentioned in clause no. 9. The penalty amounts for not providing Safety manpower and various Safety violations have also been reviewed and agreed.

M/s..... agree to share the HSE Costs (running costs) of common facilities created by BHEL on proportional to contract value basis as calculated at Site by BHEL.

Signed by authorized representative of M/s -----

Name :

Place & Date:

SECTION B

OPERATIONAL REQUIREMENTS

1. PURPOSE:

- 1.1. The purpose of this HSE Plan is to provide for the systematic identification, evaluation, prevention and control of general workplace hazards, specific job hazards, potential hazards and environmental impacts that may arise from foreseeable conditions during installation and servicing of industrial projects and power plants.
- 1.2. This document shall be followed by BHEL's subcontractors at all installation and servicing sites. In case customer specific documents are to be implemented, this document will be followed in conjunction with customer specific documents in complementary manner.
- 1.3. Although every effort has been made to make the procedures and guidelines in line with statutory requirements, in case of any discrepancy wherein the relevant statutory guidelines supersedes this document, the same shall be followed.
- 1.4. In case there's any specific HSE requirement from BHEL's Client, not explicitly indicated in this document the same shall be required to be fulfilled as per the decision of BHEL Site construction manager.

2. SCOPE:

The document is applicable to BHEL's Subcontractors at all installation / servicing activities of BHEL Power Sector as per the relevant contractual obligations

3. OBJECTIVES AND TARGETS:

- i. To achieve "Zero Incident at Site"
- ii. 100% compliance to all legal/statutory requirements related to EHS.
- iii. 100% Health, Safety and Environmental Induction training attendance for all workers.
- iv. 100% High Risk activities to be carried out only after approved Method Statement, HIRA / Aspect-Impact / JSA / OCP and Permit to Work are implemented.
- v. 100% PPEs compliance in high and medium risk activities.
- vi. 100% incident reporting, recording and reviewing for corrective actions.
- vii. Regular Safety Reviews to assess HSE program compliance and closure of any recognized gaps to improve safety management and incident prevention
- viii. Prevent injury and ill health of all workers at site ('Workers' refers to all personnel including managerial, supervisory, professional, technical, clerical and other workers including contract laborers)
- ix. Prevent pollution to environment
- x. Ensure the Health and Safety of all persons at work site is not adversely affected by the work.
- xi. Ensure protection of environment of the work site.
- xii. Comply at all times with the relevant statutory and contractual HSE requirements.
- xiii. Provide trained, experienced and competent personnel. Ensure medically fit personnel only are engaged at work.
- xiv. Provide and maintain plant, places and systems of work that are safe and without risk to health and the environment.

- xv. Provide all personnel with adequate information, instruction, training and supervision on the safety aspect of their work.
- xvi. Effectively control, co-ordinate and monitor the activities of all personnel on the Project sites including subcontractors in respects of HSE.
- xvii. Establish effective communication on HSE matters with all relevant parties involved in the Project works.
- xviii. Ensure that all work planning considers all persons that may be affected by the work.
- xix. Ensure fitness testing of all T&Ps/Lifting appliances like cranes, chain pulley blocks etc. are to be certified by competent person.
- xx. Ensure timely provision of resources to facilitate effective implementation of HSE requirements.
- xxi. Ensure continual improvements in HSE performance.
- xxii. Ensure conservation of resources and reduction of wastage.
- xxiii. Capture the data of all incidents including near misses, process deviation etc. Investigate and analyze the same to find out the root cause.
- xxiv. Ensure timely implementation of correction, corrective action and preventive action.
The subcontractor shall also comply with HSE Targets stipulated by BHEL from time to time.

4. BHEL HEALTH, SAFETY & ENVIRONMENT POLICY:

In BHEL, Health, Safety and Environment (HSE) responsibilities are driven by our commitment to protect our employees and people we work with, community and environment. BHEL believes in zero tolerance for unsafe work/non-conformance to safety and in minimizing environmental footprint associated with all its business activities. We commit to continually improve our HSE performance by:

- ❖ Developing safety and sustainability culture through active leadership and by ensuring availability of required resources.
- ❖ Ensuring compliance with applicable legislation, regulations and BHEL systems.
- ❖ Taking up activities for conservation of resources and adopting sound waste management by following Reduce/Recycle/Reuse approach.
- ❖ Continually identifying, assessing and managing environmental impacts and Occupational Health & Safety risks of all activities, products and services adopting approach based on elimination/ substitution/reduction/control.
- ❖ Incorporating appropriate Occupational Health, Safety and Environment criteria into business decisions, design of products & systems and for selection of plants, technologies and services.
- ❖ Imparting appropriate structured training to all persons at workplace and promoting awareness amongst customers, subcontractors and suppliers on HSE issues.
- ❖ Reviewing periodically this policy and HSE Management Systems to ensure its relevance, appropriateness and effectiveness.
- ❖ Communicating this policy within BHEL and making it available to interested parties.

Chairman & Managing Director

Bharat Heavy Electricals Limited, Power Sector

Regd. Office: BHEL House, Siri Fort, New Delhi-110049



5. ILLUSTRATIVE RESPONSIBILITIES OF SUBCONTRACTOR EMPLOYEES

5.1 HSE - A LINE RESPONSIBILITY

- i. HSE is a "Line Responsibility".
- ii. The term "Line" includes management, Executives, Supervisors, Foremen, and Workers who are part of the workforce. Line is to be fully involved in HSE Planning & Implementation with the aid and advice of HSE organization.
- iii. "Line", having control of resources and manpower is responsible for overall implementation of HSE Systems and closure of HSE observations.

5.2 SITE IN -CHARGE:

- i. Shall sign Memorandum of Understanding (MoU)
- ii. Shall ensure availability of all necessary resources required for implementation of HSE at Site
- iii. Shall engage qualified HSE Officer(s) and supervisors (s)
- iv. Shall adhere to the rules and regulations mentioned in this code, practice very strictly in area of work in consultation with concerned engineer and the safety coordinator.
- v. Shall screen all workmen for health and competence requirement before engaging for the job and periodically thereafter as required.
- vi. Shall not engage any employee below 18 years.
- vii. Shall arrange for all necessary PPEs like safety helmets, belts, full body harness, shoes, face shield, hand gloves etc. before starting the job.
- viii. Shall ensure that all T&Ps engaged are tested for fitness and have valid certificates from competent person.
- ix. Shall ensure closure of all HSE non-conformities reported by BHEL or observed during internal inspection by providing appropriate resources in a timely manner.
- x. Shall ensure the implementation of provisions of applicable acts and rules pertaining to HSE.
- xi. Shall ensure availability of updated (Hazard Identification and Risk Assessment) Register for the area of activity
- xii. Shall ensure availability of Method Statements & Job Safety Analysis for all hazardous activities
- xiii. Shall ensure necessary controls to minimize risk in all applicable hazardous activities including Height Work, Hot Work, Lifting & Rigging, Confined Space, Maintenance, excavation, Radiography, Loading/ Unloading, Drilling/ Blasting etc.
- xiv. Shall ensure implementation of HSE requirements mentioned in this document and as specified in the BHEL HSE management System including training, inspection, awareness, reporting etc.
- xv. Shall ensure that person working above 2.0 meter should use Safety Harness tied to a life line/stable structure.
- xvi. Shall ensure a secondary means of fall protection (Safety Net, Retractable Fall Arrestor etc.) for preventing fall from height
- xvii. Shall ensure that materials are not thrown from height. Cautions to be exercised to prevent fall of material from height.

- xviii. Shall report all incidents (Fatal/Major/Minor/Near Miss) to the Site engineer /HSE officer of BHEL.
- xix. Shall ensure that Horseplay is strictly forbidden.
- xx. Shall ensure that adequate illumination is arranged during night work.
- xxi. Shall ensure that all personnel working under subcontractor are working safely and do not create any Hazard to self and to others.
- xxii. Shall ensure display of adequate signage/posters on HSE.
- xxiii. Shall ensure that mobile phone is not used by workers while working.
- xxiv. Shall ensure conductance of HSE audit, mock drill, medical camps, induction training and training on HSE at site.
- xxv. Shall ensure full co-operation during HSE audits.
- xxvi. Shall ensure submission of look-ahead plan for procurement of HSE equipment's and PPEs as per work schedule.
- xxvii. Shall ensure good housekeeping.
- xxviii. Shall ensure adequate valid fire extinguishers are provided at the work site.
- xxix. Shall ensure availability of sufficient number of toilets (preferably bio-toilets) /restrooms and adequate drinking water at work site and labor colony.
- xxx. Shall ensure adequate emergency preparedness.
- xxxi. Shall be member of site HSE committee and attend all meetings of the committee
- xxxii. Power source for hand lamps shall be maximum of 24 v.
- xxxiii. Temporary fencing should be done for open edges if Hand – railings and Toe-guards are not available
- xxxiv. To record all incidents including near miss and report to BHEL and to ensure analysis & corrective actions for the same
- xxxv. Shall conduct weekly Safety Walks in the work area and record the findings.
- xxxvi. Construction of Canteen at Site, Office Infrastructure: Printer, PC, Fire Extinguishers etc.
- xxxvii. Shall analysis HSE Performance regularly in work area and take steps to improve the same
- xxxviii. Shall ensure stoppage of work in case of unacceptable Safety hazards

5.3 HSE OFFICER:

- i. Carry out safety inspection of Work Area, Work Method, Men, Machine & Material, P&M and other tools and tackles.
- ii. Facilitate inclusion of safety elements into Work Method Statement and creation of Job Safety Analysis (JSA)
- iii. (HSE Head) To prepare deployment plan of HSE personnel for all shifts, so as to ensure constant supervision of all areas. The plan to be submitted to BHEL
- iv. Highlight the requirements of safety through Tool-box / other meetings.
- v. Help concerned HOS to prepare Job Specific instructions/ JSA for critical jobs.
- vi. Conduct investigation of all incident/dangerous occurrences & recommend appropriate safety measures.
- vii. Advice & co-ordinate for implementation of HSE Systems & Procedures.
- viii. To stop work in case of any critical safety violation until the violation is cleared
- ix. Convene HSE meeting & minute the proceeding for circulation & follow-up acti

- x. Plan procurement of PPE & Safety devices and inspect their healthiness.
- xi. Report to BHEL on all matters pertaining to status of safety and promotional program at site level.
- xii. Facilitate administration of First Aid
- xiii. Facilitate screening of workmen and safety induction.
- xiv. Conduct fire Drill and facilitate emergency preparedness
- xv. Design campaigns, competitions & other special emphasis programs to promote safety in the workplace.
- xvi. Apprise BHEL on safety related problems.
- xvii. Notify site personnel non-conformance to safety norms observed during site visits / site inspections.
- xviii. Recommend to Site In charge, immediate discontinuance of work until rectification, of such situations warranting immediate action in view of imminent danger to life or property or environment.
- xix. To decline acceptance of such PPE / safety equipment that do not conform to specified requirements.
- xx. Encourage raising Near Miss Report on safety along with, improvement initiatives on safety.
- xxi. Shall work as interface between various agencies such customer, package-in-charges, subcontractors on HSE matters.

5.4 HSE SUPERVISOR:

- i. All requirements as per 5.1
- ii. To monitor allotted area for Safety violations, take required action and inform the concerned Safety Supervisor / Officer
- iii. To assist HSE Officer

5.5 PACKAGE IN-CHARGES, ENGINEERS & ALL EMPLOYEES:

- i. To be aware of, get involved in and ensure implementation of all HSE related Systems and Procedures including but not limited to:
 - a. BHEL HSE Management System including HSE Procedures and OCPs, HIRA, JSA etc.
 - b. Work Permit System
 - c. Emergency Preparedness Response Plans
 - d. Contractual HSE requirements
 - e. Legal Requirements
 - f. Penalty System
 - g. Training requirements
- ii. To ensure that the persons engaged in respective area follow the safety rules like using appropriate PPEs.
- iii. To develop Method Statements and ensure availability of Job Safety Analysis for all activities in scope
- iv. To ensure that the reported HSE non-conformities in the work area are resolved immediately before resuming work
- v. To record all incidents including near miss and report to BHEL.

- vi. To adopt safe working practices at all times and act as role model for Safety
- vii. To take immediate corrective action actions in case any non-conformity is observed on product / process / system with respect to Occupational Health, Safety and Environment.
- viii. In case any particular activity / work has extremely high consequential risk or high environmental impact, same shall be brought to the notice of BHEL Package In-charge before starting the work.
- ix. To interfere/ stop work as & when identified unsafe.
- x. To maintain & promote improved level of house-keeping all the time at site.
- xi. To support/co-operate with audit team members as & when safety audits are carried out.
- xii. To involve in investigation, if any incident occurs in his work area.
- xiii. To participate in safety promotional programs
- xiv. To attend the safety committee meeting, if member/invitee
- xv. To ensure that only fit T&Ps and qualified persons are engaged for all activities.
- xvi. Shall ensure that person working above 2.0 meter should use Safety Harness tied to a life line/stable structure.
- xvii. Shall ensure that materials are not thrown from height. Cautions to be exercised to prevent fall of material from height.
- xviii. Shall ensure that all T&Ps engaged are tested for fitness and have valid certificates from competent authorities.

6. HSE PLANNING BY SUBCONTRACTOR:

6.1 HAZARD ANALYSIS & RISK ASSESSMENT (HIRA), METHOD STATEMENT (MS) & JOB SAFETY ANALYSIS (JSA):

- i. Subcontractor shall identify all OHS Hazards and Risks applicable to all activities in scope and plan & implement the required control measures. HIRA Register shall be maintained.
- ii. Subcontractor shall develop Method Statements & Job Safety Analysis documents for all hazardous activities in scope and ensure the required control measures. Job Safety Analysis is to be attached along with any Work Permit request

6.2 REGISTER OF REGULATIONS:

Subcontractor shall prepare a register of applicable rules and regulations in the scope and plan to ensure compliance.

HIRA Register, Method Statements, Job Safety Analysis and Register of Regulations are dynamic documents and shall be revised (as applicable):

- i. At fixed frequency of 3 months
- ii. Addition/ deletion/ modification of a process/ activity
- iii. After an accident/ incident
- iv. After any change in applicable rules/ regulations/ laws.

6.3 MONTHLY HSE PLAN COVERING THE FOLLOWING AS A MINIMUM SHALL BE PREPARED AND SUBMITTED TO BHEL FOR APPROVAL:

- i. HSE Trainings covering all activities/ hazards/ workers
- ii. HSE Inspection Plan covering all areas/ activities/ equipment/ hazards
- iii. HSE Activities: Safety walks, Awards, housekeeping, reviews etc.

Note: Online/ App-based system shall be used for HSE Planning and Implementation/ Update whenever provided by BHEL otherwise Hard-copy based system shall continue

6.4 MONTHLY HSE PLANNING & REVIEW OF HSE ACTIVITIES ALONG WITH BHEL:

Monthly planning and review of HSE activities shall be carried out by subcontractor as per provided **format** jointly along with BHEL

7. MOBILIZATION OF MACHINERY/EQUIPMENT/TOOLS BY SUBCONTRACTOR:

- i. Subcontractor shall notify the engineer, of his intention to bring on to site any equipment or any container, with liquid or gaseous fuel or other substance which may create a hazard. The Engineer shall have the right to prescribe the condition under which such equipment or container may be handled and used during the performance of the works and the subcontractor shall strictly adhere to such instructions. The Engineer shall have the right to inspect any construction tool and to forbid its use, if in his opinion it is unsafe. No claim due to such prohibition will be entertained.
- ii. As a measure to ensure that machinery, equipment and tools being mobilized to the construction site are fit for purpose and are maintained in safe operating condition and complies with legislative and owner requirement, inspection shall be arranged by in-house competent authority for acceptance as applicable. Inspection by Third Party competent person shall be arranged:
 - a. Before first time use at site
 - b. After carrying out any modification
 - c. After repairs subsequent to involvement in any accident/ incident
- iii. As a further measure to ensure that machinery, equipment and tools being mobilized to the construction site are fit for purpose and are maintained in safe operating condition and comply with legislative and owner requirement, inspection as per provided format shall be arranged by in-house expert / competent authority (preferable) for acceptance. The equipment considered for this purpose shall include all those in the T&P list in the tender document.

8. MOBILIZATION OF MANPOWER BY SUBCONTRACTOR:

- i. As a measure to ensure that manpower being mobilized to the construction site is fit and competent for safe working, screening arrangement shall be made by the sub-subcontractor to ensure competency and fitness through following measures:
 - a) **Medical Checkup:** Examination of medical fitness shall be conducted through qualified medical professional for all workers to be deployed as per provided **format**. For height workers, vertigo (height phobia) test to be carried out as qualification criteria as per Annexure K and recorded in provided **format**.

- b) **Induction Training:** Induction training of all workers to be ensured as per **provided procedure and format**. Training evaluation to be carried out and training to be repeated if not passed
- c) Only on successfully meeting above criteria, permanent gate passes to be issued
- ii. The subcontractor shall arrange induction and regular health check of their employees as per schedule VII of BOCW rules by a registered medical practitioner.
- iii. The subcontractor shall take special care of the employees affected with occupational diseases under rule 230 and schedule II of BOCW Rules. The employees not meeting the fitness requirement should not be engaged for such job.
- iv. Ensure that the regulatory requirements of excessive weight limit (to carry/lift/ move weights beyond prescribed limits) for male and female workers are complied with.
- v. Appropriate accommodation to be arranged for all workmen in hygienic condition.
- vi. Cost of contractual, statutory and regulatory requirements like Training, medical checks, PPEs etc. shall not be transferred to the workers and such activities shall be considered as part of the job.

9. PROVISION OF PERSONAL PROTECTIVE EQUIPMENT (PPEs):

- i. Personnel Protective Equipment (PPEs), shall be provided by the subcontractor to all workers as per requirement of the job.
- ii. The choice of PPEs to ensure multiple (at least more than 1) means of protection against any hazard. All applicable safety precautions for a job shall be ensured notwithstanding the duration or perceived importance of the task.
- iii. The applicability of PPEs shall be as per the concept of Hierarchy of controls, i.e.:
- iv. Elimination->Substitution->EngineeringControls->AdministrativeControls-PPEs
- v. Relying solely on PPEs without ensuring necessary controls to be strictly avoided.
- vi. The following matrix recommends usage of minimum PPEs against the respective job.

Activity	Type of Protection						Remarks, if any
	Hand	Eye	Ear	Body	Respiratory	Others	
Gas Welding & Cutting	LG	WG	-	LA	*SCBA/ OLBA	-	* for confined space
Electric Arc Welding	LG	HMWS	-	LA	*SCBA/ OLBA	-	* for confined space
Rigging	CG	SG	-				--
Working at Height	-	SG	-	DLFBH	-	*FAS	* for vertical columns
Grinding & Chipping	CG	FS / SG	-	LA	-	-	--
Working in High Noise	-	-	EP / EM	-	-	-	--
Handling of Cement Concrete	RG	SG	-	-	DM	-	

Blasting	CG	SG	EP*	-	-	-	* at noise area
Excavation	CG	SG	-	-	DM	-	*Gum boot in place of Safety shoe for foot
Chemical Handling	PVCG	CSG	-	PVCA	-	-	*Full body rubber suit with hood
Electrical and C&I	ERG*	SG	-	-	-	-	*For high voltages
Sand/shot blasting	CG	-	EP/ EM	CA	SAMH	-	

ABBREVIATIONS: FS: Face Shield, CSG: Chemical splash goggles, HMWS: Helmet mounted welder's shield, GB: gum boot, DLFBH: Double lanyard full body harness, SG: Safety goggles, DM: Dust mask, SAMH L Supplied air mask/hood, EP/EM: Ear plug/Ear Muff, CG: Cotton hand gloves, LG: Leather hand gloves, LA: Leather apron, RG: Rubber gloves, PVCG: PVC Gloves, PVCA: PVC Apron, SCBA: Self-contained breathing apparatus, WG: Welding goggles, ERG: Electrical Rubber Gloves. OLBA: Online breathing apparatus

The list is not exhaustive. Additional PPEs to ensure Safe Work may need to be deployed as per the requirement of the task at no additional cost.

- vii. The PPEs shall conform to the relevant standards as below (illustrative list) and bear ISI mark.

RELEVANT IS-CODES FOR PERSONAL PROTECTION

PPEs	IS Codes
Industrial Safety Helmets.	IS: 2925 – 1984
Rubber gloves for electrical purposes.	IS: 4770 – 1968
Industrial Safety Gloves (Leather & Cotton Gloves).	IS: 6994 – 1973 (Part-I)
Leather safety boots and shoes.	IS: 1989 – 1986 (Part-II)
Industrial and Safety rubber knee boots.	IS: 5557 – 1969
Code of practice for selections care and repair of Safety footwear.	IS: 6519 – 1971
Leather Safety footwear having direct molding sole.	IS: 11226 – 1985
Eye protectors.	IS: 5983 – 1978
Ear protectors.	IS: 9167 – 1979
Eye & Face protection during welding	IS: 1179-1967
Industrial Safety Belts and Harness	IS: 3521 – 1983
Guide for selection of industrial Safety equipment for body protection	IS:8519 -1977
Respiratory Protective Devices	IS:9473-2002,14166-1994,14746-1999

- viii. Where workers are employed in sewers and manholes, which are in use, the subcontractor shall ensure that the manhole covers are opened and ventilated at least for an hour before the workers are allowed to get into manhole, and the manholes so opened shall be cordoned off with suitable railing and provided with warning signals or boards to prevent incident to the public

- ix. All the personnel and visitors shall mandatorily use safety helmet (with company logo), safety shoe and reflective vests, in addition to any other PPEs as deemed appropriate for the area of work/ visit.
- x. Following Color scheme for Helmets shall be followed:
 - a. Workmen: Yellow
 - b. Safety staff: Green or white with green band
 - c. Electrician: Red
 - d. Others including visitors: White
 - e. For height workers, special marking on helmets besides indication on Gate Pass/ ID Card
- xi. The subcontractor shall maintain register for issue and receipt of PPEs.
- xii. All the PPEs shall be checked for quality before issue and the same shall be periodically re-checked. The users shall be advised to check the PPEs themselves for any defect before putting on. The defective ones shall be replaced.
- xiii. The Helmets shall have logo or name (abbreviation of agency name permitted) affixed or printed on the front.
- xiv. The body harnesses shall be serial numbered.

10. ARRANGEMENT OF INFRASTRUCTURE:

10.1 DRINKING WATER:

- i. Drinking water shall be provided and maintained at suitable places at different elevations such that minimum quantity of 5 liters is available for each worker during the day.
- ii. Drinking water tank shall be so installed so as to be available within 200 meters of each working area
- iii. Container should be labeled as “Drinking Water” in languages understood by the workers
- iv. Cleaning of the container shall be ensured at least once in a week. Mild cleaning detergents as used for cleaning vessels shall be applied and scrubbers (3M or equivalent) shall be used for removing scales and deposits on the inside surface. The tank shall be thoroughly cleaned with potable water only before it is refilled (also applicable to labor colony).
- v. Suitability of water source for drinking to be tested as per IS10500 at least once in six months.

10.2 WASHING FACILITIES:

- i. In every workplace, adequate and suitable facilities for washing shall be provided and maintained.
- ii. Separate and adequate cleaning facilities shall be provided for the use of male and female workers. Such facilities shall be conveniently accessible and shall be kept in clean and hygienic condition and dully illuminated for night use.
- iii. Water suitable for washing and not for drinking shall be clearly indicated as “Not for Drinking” in language understood by workers.
- iv. Overalls shall be supplied by the subcontractor to the workmen and adequate facilities shall be provided to enable the painters and other workers to wash during the cessation of work.

10.3 LATRINES AND URINALS:

- i. Latrines and urinals shall be provided in every work place as indicated in Section A
- ii. Urinals shall also be provided at different elevations.
- iii. They shall be adequately lighted and shall be maintained in a clean and sanitary condition at all times, by appointing designated person.
- iv. Separate facilities shall be provided for the use of male and female worker if any.

10.4 PROVISION OF REST SHEDS FOR WORKERS DURING REST PERIOD:

Proper Rest Shed (s) with shelter shall be provided for rest during break so as to accommodate all workers as indicated in Section A

10.5 MEDICAL FACILITIES:

10.5.1 GENERAL

- i. Provision of Medical Center, Ambulance etc. shall be as per Section A of this document
- ii. Medical waste shall be disposed as per prevailing legislation (Bio-Medical Waste – Management and Handling Rules, 1998)
- iii. Every injury shall be treated, recorded and reported.
- iv. All First Aid injuries shall be recorded as per provided Format
- v. List of qualified first aiders and their contact numbers to be displayed at conspicuous places.

10.5.2 FIRST AIDER/ FIRST AID BOX

- i. The first aider along with facilities should be available at a point nearest to the work location wherein majority of the workers are working.
- ii. The subcontractor shall provide necessary first aid facilities as per schedule III of BOCW. At every work place first aid facilities shall be provided and maintained.
- iii. The first aid box shall be kept by first aider who shall always be readily available during the working hours of the work place. His name and contact no to be displayed on the box.
- iv. The first aid boxes should be placed at various elevations so as to make them available within the reach and at the quickest possible time.
- v. The first aid box shall be distinctly marked with a Green Cross on white background.
- vi. Details of contents of first aid box is given in Annexure J
- vii. A slip of contents shall be pasted on the First Aid Box with following details
- viii. Monthly inspection of First Aid Box shall be carried out by the owner as per provided format
- ix. The subcontractor should conduct periodical first –aid classes to keep his supervisor and Engineers properly trained for attending to any emergency.

10.5.3 HEALTH CHECK UP

The persons engaged at the site shall undergo health check-up as per provided format before induction. In addition, the persons engaged in the following works shall undergo health check-up at least once in a year:

- i. Height workers
- ii. Drivers/crane operators/riggers
- iii. Confined space workers
- iv. Shot/sand blaster
- v. Welding and NDE personnel

10.5.4 HEIGHT PHOBIA/ VERTIGO TEST:

- i. The persons engaged in working at heights (above 2 meters) to be assessed for Vertigo and associated conditions and recorded as per provided format. Suggested Vertigo Test Procedure is given in Annexure K
- ii. Such workers are to be allowed only on successful completion of test, otherwise shall be allocated ground-based jobs.
- iii. IDs / Height passes shall be issued to such workers, besides special markings on helmets for easy identification.

10.5.5 PROVISION OF CANTEEN FACILITY:

- i. Canteen facilities shall be provided for the workmen of the project inside the project site where worker strength is 250 or more.
- ii. Proper cleaning and hygienic condition shall be maintained.
- iii. Proper care should be taken to prevent biological contamination.
- iv. Adequate drinking water should be available at canteen.
- v. Fire extinguisher shall be provided inside canteen.
- vi. Regular health check-up and medication to the canteen workers shall be ensured as per applicable regulations.
- vii. Canteen waste to be disposed of in hygienic manner

10.6 PROVISION OF ACCOMMODATION/LABOR COLONY FOR WORKFORCE:

- i. Proper accommodation for workforce to be provided in line with minimum requirements indicated in Section A
- ii. Labor colony shall be inspected each week by HSE Officer and report submitted to BHEL as per provided format

10.7 PEST CONTROL:

Regular pest control should be carried out at all offices, mainly laboratories, canteen, labor colony and stores.

10.8 SCRAPYARD:

- i. In consultation with customer, scrapyard shall be developed to store metal scrap, wooden scrap, waste, hazardous waste.
- ii. Scrap/Waste shall be segregated as Bio-degradable and non-bio-degradable and stored separately.

10.9 ILLUMINATION:

- i. The subcontractor shall arrange at his cost adequate lighting facilities e.g. flood lighting, hand lamps, area lighting etc. at various levels for safe and proper working operations at dark places and during night hours at the work spot as well as at the pre-assembly area.
- ii. Lamp (hand held) shall not be powered by mains supply but either by 24V or dry cells.
- iii. Lamps shall be protected by suitable guards where necessary to prevent danger, in case of breakage of lamp.
- iv. Emergency lighting provision for night work shall be made to minimize danger in case of main supply failure.
- v. Adequate and suitable light shall be provided at all work places & their approaches including passage ways as per IS: 3646 (Part-II).

SUITABLE ILLUMINATION LEVELS FOR VARIOUS AREAS SHALL BE DECIDED BASED ON BROAD GUIDELINES INDICATED BELOW:

S. No.	Location	Lux Level (lumens/sqm)
A. Construction Site		
1	Outdoor areas like store yards, entrance and exit roads	20
2	Platforms	50
3	Entrances, corridors and stairs	100
4	General illumination of work area	150
5	Rough work like fabrication, assembly of major items	150
6	Medium work like assembly of small machined parts	300
7	Fine work like precision assembly, precision measurements etc.	700
8	Sheet metal works	200
9	Electrical and instrument labs	450
B. Office		
1	Outdoor area like entrance and exit roads	20
2	Entrance halls	150
3	Corridors and lift cars	70
4	Lift landing	150
5	Stairs	100
6	Office rooms, conference rooms, library reading tables	300
7	Drawing table	450
8	Manual telephone exchange	200

- vi. Illuminations shall be inspected on weekly basis as per provided **format** using a calibrated lux meter.

11. HSE TRAINING & AWARENESS:

11.1 TRAINING PLAN:

- i. All training programs to be carried out in a planned manner. Monthly/ Annual Training Calendar to be submitted to BHEL for approval and shall cover HSE Training requirements of all activities, workers, hazards applicable to the area(s) of work.
- ii. Subcontractor shall nominate workers as per the schedule of specific training plan, failing which, penalty shall be imposed.
- iii. Training records of all workers along with attendance, signatures, faculty details etc. shall be maintained in soft/ hard copy as per provided **formats**.
- iv. Each labor should undergo at least 0.5% of total man-hours worked in HSE training.

11.2 HSE INDUCTION TRAINING

- i. All persons entering into project site shall be given HSE induction training by the HSE officer of BHEL /subcontractor before being assigned to work.
- ii. The induction training shall be imparted through audio-visual medium (Classroom specialized training), and shall be minimum of 1 Complete Day.
- iii. Evaluation to be carried out after training and training shall be repeated in case of failure.
- iv. Safety Induction Card shall be printed by Subcontractor and provided to all trained workers. A Safety induction book shall also be printed and issued to each worker after induction training (Format for the same may be provided by BHEL).
- v. Induction training subjects shall include but not limited to:
 - a. Briefing of the Project details.
 - b. Safety objectives and targets.
 - c. Site HSE rules.
 - d. Critical Safety Violations and consequences
 - e. Site HSE hazards and aspects.
 - f. First aid facility.
 - g. Emergency Contact No.
 - h. Incident & Near Miss reporting.
 - i. Fire prevention and emergency response.
 - j. Rules to be followed in the labor colony (if applicable)
 - k. Accident case studies
- vi. General:
 - a. Proper safety wear & gear must be issued to all the workers being registered for the induction (i.e., Shoes/Helmets/Goggles/Leg guard/Apron etc.)
 - b. They must arrive fully dressed in safety wear & gear to attend the induction.
 - c. Any one failing to conform to this safety wear& gear requirement shall not qualify to attend.

- d. On completing attending subcontractor’s in-house HSE induction, each employee shall sign an induction training form to declare that he had understood the content and shall abide to follow and comply with safe work practices.
- e. They may only then be qualified to be issued with a personal I.D. card, for access to the work site subject to clearing the medical fitness test.

SAFETY INDUCTED	
Name :	
Date :	
Sign By Trainer :	

ABOVE STICKER SHALL BE PASTED ON HELMET OF WORKERS AFTER SAFETY INDUCTION TRAINING

11.3 JOB-SPECIFIC SKILL BASED HSE TRAINING

The contracting agency shall also impart job specific skill-based safety training to all its employees (Minimum one day) on various related safety topics using internal/external safety professionals/consultants as per the matrix given below. Record of such trainings and attendance particulars shall be maintained in a register for ready reference to statutory authorities/engineer-in charge as per provided format.

TRAINING MATRIX

Name of topic	Executives	Supervisors	Skilled Workmen	Other Workers
Safety Induction	Y	Y	Y	Y
Accident_ Causes, factors, cost	Y	Y	Y	-
Industrial hazards & Accident Prevention	Y	Y	Y	-
Investigating, reporting, records	Y	Y	-	-
Personal Protective Equipment	-	Y	Y	Y
Construction Safety & Role of Supervisory personnel	-	Y	-	-
Permit to Work (PTW)	-	Y	Y	y
Statutory Provisions (BOCW Act/Rules, Factories Act 1948 etc.)	Y	Y	y	y
Material handling	-	y	Y	Y
Emergency Management	Y	Y	Y	-
Electrical Safety	-	Y	Y	-
Fire safety	Y	Y	Y	Y
First Aid & CPR (cardio pulmonary resuscitation)	-	Y	Y	Y (Selected)
Safety in Welding & Cutting	-	-	Y	-
Safety Audit	Y	Y	-	-
Safety in Lifting Tools & Tackles	-	Y	Y	y



Safety in Working at height	-	Y	Y	Y
Safety in Confined space work	-	Y	Y	Y
Defensive Driving	-	Y*	Y*	Y*

*for construction vehicle operators, helpers & crane operators

Y=YES

Note:

- i. Subcontractor shall prepare a training plan/ matrix covering all hazards and implement the same after approval of BHEL.
- ii. It is to be ensured that every worker undergoes Job-Specific training once every 3 months.
- iii. Records of training programmes along with attendance shall be maintained by the subcontractor
- iv. Each worker to be issued a Card indicating the types of trainings undergone.

11.4 HSE TOOL-BOX TALK:

- i. HSE tool Box talk shall be conducted by frontline foreman/supervisor of subcontractor to specific work groups prior to the start of work and shall be randomly attended by subcontractor engineers/ officials. The agenda shall consist of the following:
 - a. Details of the job being intended for immediate execution.
 - b. The relevant hazards and risks involved in executing the job and their control and mitigating measures.
 - c. Specific site condition to be considered while executing the job like high temperature, humidity, unfavorable weather etc.
 - d. Recent non-compliances observed.
 - e. Appreciation of good work done by any person.
 - f. Any doubt clearing session at the end.
- ii. Tool box talk to be conducted before start of work in every shift.
- iii. During toolbox talk, visual check-up of workers regarding health, any signs of fatigue, intoxication etc. shall be conducted and any suspected workers to be acted upon.
- iv. Record of Tool box talk shall be maintained as per provided **format**

11.5 TRAINING ON HEIGHT WORK:

- i. Training on height work shall be imparted to all workers working at height by in-house/external faculty at least once every 3 months.
- ii. For Height Workers Separate pass shall be provided by the subcontractor.
- iii. The training shall be of minimum 2-hour duration, through audio-visual medium and followed by evaluation. In case of poor scoring, training shall be repeated.
- iv. The training shall include following topics:
 - a. Proper use of PPEs – safety harness, lanyard, fall arrester, retractable fall arrester, life line, safety nets etc.
 - b. Provision of secondary means of fall protection



- c. Safe climbing through monkey ladders.
- d. Inspection of PPEs.
- e. Medical fitness requirements.
- f. Mock drill on rescue at height.
- g. Dos & Don'ts during height work.
- h. Accident case Studies

11.6 RE-INDUCTION TRAINING

The induction training shall be repeated for every worker after at least 1 year and shall be a pre-requisite for renewal of Gate Pass/ ID card.

11.7 PENALTY TRAINING

The personnel involved in Safety Violations/ Incidents shall mandatorily undertake penalty training pertaining to the violation/ incident. Penalty training shall be at least half-day duration.

11.8 HSE PROMOTION-SIGNAGE, POSTERS, COMPETITION, AWARDS ETC.:

- i. HSE Displays shall be installed as indicated in Section A
- ii. Contracting agencies shall arrange for display of safety hoardings depicting suitable safety cartoons/messages/ cautionary notices at appropriate places of project site to remind the workers to perform their duties safely.
- iii. Apart from safety hoardings, each agency should maintain a safety bulletin board at all their work locations. Such safety bulletin boards should depict the activities being planned for the day, good practices, permit details etc.
- iv. Safety suggestion boxes shall be kept at each subcontractor's office at site for obtaining safety suggestions from the workers. Best suggestions should be implemented and may be rewarded suitably to encourage the workers for safety.
- v. Safety awareness campaigns, competitions, plays, movie shows, songs etc. to be organized for workers at Site and Labor colony from time to time to enhance Safety Awareness

11.9 HSE REWARDS & INCENTIVE SCHEME

Subcontractor shall implement a reward & incentive scheme for workers & supervisors displaying adherence to safety principles. Such workers shall be felicitated in a monthly function, attended by Subcontractor top management and BHEL representatives. Suitable gift shall be given to such workers for encouragement.

11.10 HSE AWARENESS PROGRAM FOR OFFICIALS:

Subcontractor shall arrange monthly HSE awareness program on different topics including medical awareness for all engineers/ supervisors / officials working at site. This program can be part of progress/ safety review meetings.

12. HSE COMMUNICATION AND PARTICIPATION:

12.1 HSE INCIDENT REPORTING, INVESTIGATION & CORRECTIVE ACTION:

- i. All incidents (near misses, property damage, first-aid cases, minor, major and fatal incidents) shall be reported to BHEL as they happen immediately through SMS and Hard/Soft copy as per provided format
- ii. All incidents including near miss, minor, major and fatal incidents shall be recorded
- iii. All incidents shall be investigated for Root Causes and corrective actions ensured to prevent recurrence shall be implemented.
- iv. Work shall be put on hold in the area till corrective actions are verified by BHEL
- v. The Root Cause Analyses and Corrective actions taken shall be recorded

12.2 HSE EVENT REPORTING:

- i. Important HSE events like HSE training, Medical camp etc. organized at site shall be reported to BHEL site management in detail with photographs for publication in different in-house magazines
- ii. Celebration of important days like National Safety Day, World Environment Day etc. shall also be reported as mentioned above.

12.3 MONTHLY HSE REPORTING:

- i. All routine and non-routine HSE activities shall be reported to BHEL on monthly basis by the subcontractor as per provided format. The reporting medium can be hard/soft as per BHEL requirement.
- ii. The period of reporting shall be 25th of the preceding month to 24th of the present month and shall be submitted by the end of the calendar month.
- iii. Report shall include good quality images of HSE Activities

12.4 DAILY HSE ACTIVITY REPORTING:

Daily HSE activities shall be reported by subcontractor to BHEL as per provided format

12.5 HSE SUGGESTIONS:

All workers and employees shall be encouraged to provide suggestions for improvement in Health, Safety & Environment performance at site. The suggestions shall be recorded in a "Suggestions Register" as per provided format. Suggestions found suitable for implementation shall be implemented and recognition / reward to be given to the submitter.

Suggestion Register to be placed at Site and Labor Colony and shall be reviewed on periodic basis

12.6 CLIENT COMMUNICATION:

All HSE related communication from BHEL, customer / external statutory and regulatory agencies to be handled on priority. Same to be recorded and issues to be resolved in expeditious manner

13. SAFETY DURING WORK EXECUTION:

Safety during work execution shall be ensured by following appropriate Safety Rules, providing adequate resources, deploying competent and trained manpower, regular training & inspection and non-conformity resolution. Main aspects are indicated as under:

13.1 OPERATIONAL CONTROL PROCEDURES:

In order to reduce the risk associated with hazardous activities, applicable OCPs (Operational control procedures) will be followed by subcontractor as per BHEL instructions, outcomes of Hazard Analysis & other requirements. This will be done as part of normal scope of work. Illustrative list of reference OCPs is given below.

TABLE 13.1 ILLUSTRATIVE LIST OF REFERENCE OCPs

No.	Topic	No.	Topic	No.	Topic
0	General Safety	22	Steam blowing	44	Material preservation
1	Handling of chemicals	23	Working in confined area	45	Electro-resistance heating
2	Electrical safety	24	Operation of passenger lift, material hoists & cages	46	Blasting
3	Energy conservation	25	Vehicle/ Crane maintenance	47	Transformer charging
4	Welding and gas cutting operation	26	Radiography	48	Handling of battery system
5	Fire safety	27	Waste disposal	49	DG set
6	Use of hand tools	28	Handling & storage of mineral wool	50	Sanitary maintenance
7	First aid	29	Working at night	51	Piling rig operation
8	Food safety at canteen	30	Computer operation	52	Passivation
9	Use of cranes	31	Storage in open yard	53	EDTA Cleaning
10	Storage and handling of gas cylinders	32	Drilling, reaming and grinding(machining)	54	Chemical cleaning of Pre boiler system
11	Manual arc welding	33	Stress relieving	55	Boiler Light up
12	Use of helmets	34	Hydraulic test	56	Rolling and Synchronization
13	Good house keeping	35	Trial run of rotary equipment	57	Loading of Unit

14	Safe excavation	36	Batching	58	Air compressor
15	Working at height	37	Cable laying/tray work	59	Hydra Operation
16	Filling of hydrogen in cylinder	38	Spray insulation	60	Duct Pre-assembly
17	Illumination	39	Compressor operation	61	Resumption of construction activities after lockdown and prevention of coronavirus infection during site operations
18	Handling and erection of heavy metals	40	Gas distribution test		
19	Acid cleaning	41	Cleaning of Hot well / Deaerator		
20	Oil flushing	42	Electrical maintenance	61A	Prevention of Covid-19 infection in labour colony
21	Alkali boil out	43	O&M of control of AC plant & system	62	Truss/ Structure fit-up and alignment

- a. The reference OCPs shall be suitably modified by subcontractor as per specific requirements to control the hazards.
- b. In case any other OCP is found to be applicable during the execution of work at site, then subcontractor will prepare and follow those as well.

13.2 WORK PERMIT SYSTEM:

- i. The following activities shall be carried out by the subcontractor strictly after obtaining Permit to Work from BHEL
 - a) Height working
 - b) Hot working
 - c) Confined space Work
 - d) Excavation more than 2-meter depth
 - e) Radiography
 - f) Heavy / Complex / Critical Lifting Activity
 - g) Night / Holiday Work
 - h) Material Loading / Unloading
 - i) Grating, Safety Net, Safety Facility Removal
 - j) Live Electrical Maintenance etc. - Lockout / Tagout
 - k) Beam / truss/ duct/ structure alignment
- ii. The Work Permit Formats shall be provided by BHEL at Site. It is the responsibility of the subcontractor to ensure their availability
- iii. The above list is not exhaustive. BHEL reserves right to introduce additional Permits or modify requirements for usage of existing Permits. The conditions for using the Permit are specified in the Format (General Requirements).
- iv. Where customer is having separate Work Permit System the same shall be followed in conjunction / merged to ensure all activities and checks are covered in all systems.
- v. Details of working Group to be attached along with work permit request.

- vi. All the Permits along with JSA/HIRA must be initiated by Agency Execution Team
- vii. Permit applicant shall apply for work permit of particular work activity at particular location before starting of the work with Job Hazard Analysis.
- viii. All Permit signatories (including subcontractor's package in-charge and HSE Officer) shall physically visit the work area and check that all the safety control measures necessary for the activity are in place. Only then the permit shall be issued.
- ix. Signatory shall physically visit the area of work and ensure all required safeguards before signing the Permit
- x. Signatory shall periodically visit the area to confirm the availability of required safeguards throughout the currency of the permit
- xi. In case any Permit requirement is not available, work will be stopped till it is made available
- xii. Permit holder shall implement and maintain all control measures during the period of permit. The permit will be closed after completion of the work.
- xiii. Online Work Permit System shall be used whenever provided by BHEL, otherwise hard copy shall be used

13.3 ACTIVITY-SPECIFIC PRECAUTIONS/ CONTROLS

Detailed HSE precautions for various activities undertaken at Site by the subcontractors are specified in **Annexure I**. Same are to be ensured by the Sub-subcontractor while carrying out respective activities at Site

Index of **Annexure I** is given as under

SN	Description	Page No.
1.	General	2
2.	Work at height	2
2.1	Personnel fall protection system must include	3
2.2	Working Platform	4
2.3	Scaffolding	5
2.4	Ladder Safety	7
3.	Excavation & Civil Works	8
3.1	Excavation	8
3.2	Piling	9
3.3	Batching Plant Operation	9
3.4	Mobile Plant	10
3.5	Concrete Vibrators	11
3.6	Concrete Mixers	11
4.	Welding & Gas Cutting Safety (Hot Work)	11
5.	Lifting & Rigging Safety	13
5.1	Cranes & Hoisting Equipment	15
6.	Demolition Work	20
7.	T&Ps General	20
8.	Chemical Handling	20
9.	Electrical Safety	

10.	Use of Hand Tools and Power-Operated Tools	25
11.	Start Up, Commissioning and Testing:	27
12.	Fire Safety	27
13.	Painting	28
14.	Hazardous Energy” Control Procedure/ Lockout/Tagout (LOTO)	29
15.	Risk Assessment	36
16.	HSE Preparedness for Adverse Climates and Weather	37
16.1	Summer	37
16.2	Monsoon	38
16.3	Emergency Weather Conditions	40
16.4	Prevention of Covid-19 At Project Site & Labor Colony	41
16.5	Noise Mitigation	43

14. ENVIRONMENTAL CONTROL & SOCIAL RESPONSIBILITY

- i. Environment protection has always been given prime importance by BHEL. Environmental damage is a major concern of the principal subcontractor and every effort shall be made, to have effective control measures in place to avoid pollution of Air, Water and Land and associated life. Banned substances like asbestos and Chlorofluorocarbons such as carbon tetrachloride and trichloroethylene shall not be used. Waste disposal shall be done in accordance with the guidelines laid down in the project specification.
- ii. Any chemical including solvents and paints, required for construction shall be stored in designated bonded areas around the site as per Material Safety Data Sheet (MSDS).
- iii. In the event of any spillage, the principle is to recover as much material as possible before it enters drainage system and to take all possible action to prevent spilled materials from running off the site. The subcontractor shall use appropriate MSDS for clean-up technique
- iv. All subcontractors shall be responsible for the cleanliness of their own areas
- v. Regular dust suppression using sprinklers shall be carried out in respective area
- vi. The subcontractors shall ensure that noise levels generated by plant or machinery are as low as reasonably practicable. Where the subcontractor anticipates the generation of excessive noise levels from his operations the subcontractor shall inform to Construction Manager of BHEL accordingly so that reasonable & practicable precautions can be taken to protect other persons who may be affected.
- vii. It is imperative on the part of the subcontractor to join and effectively contribute in joint measures such as tree plantation, environment protection, contributing towards social upliftment, conversion of packing woods to school furniture, enhancing good relation with local populace etc.
- viii. The subcontractor shall carry out periodic air and water quality check and illumination level checking in his area of work place and take suitable control measure.

15. HOUSEKEEPING

- i. Keeping the work area and access roads clean/ free from debris, removed scaffoldings, scraps, insulation/sheeting wastage /cut pieces, temporary structures, packing woods etc. will be in the scope of the subcontractor. Such cleanings have to be done by subcontractor within quoted rate, on daily basis.
- ii. If such activity is not carried out by subcontractor / BHEL is not satisfied, then BHEL may get it done by other agency and actual cost along with BHEL overheads will be deducted from subcontractor's bill. Such decisions of BHEL shall be binding on the subcontractor
- iii. Dedicated Housekeeping gangs shall be deployed, who shall be provided all required PPEs and safety training
- iv. Mass housekeeping shall be carried out for half a day in a week
- v. Proper housekeeping to be maintained at work place and the following are to be taken care of on daily basis.
- vi. All surplus earth and debris are removed/disposed off from the working areas to identified locations.
- vii. Unused/Surplus cables, steel items and steel scrap lying scattered at different places/elevation within the working areas are removed to identified locations.
- viii. All wooden scrap, empty wooden cable drums and other combustible packing materials, shall be removed from workplace to identified locations.
- ix. Sufficient waste bins shall be provided at different work places for easy collection of scrap/waste. Scrap chute shall be installed to remove scrap from high locations.
- x. Access and egress (stair case, gangways, ladders etc.) path should be free from all scrap and other hindrances.
- xi. Workmen shall be educated through tool box talk about the importance of housekeeping and encourage not to litter.
- xii. Labor camp area shall be kept clear and materials like pipes, steel, sand, concrete, chips and bricks, etc. shall not be allowed in the camp to obstruct free movement of men and machineries.
- xiii. Fabricated steel structures, pipes & piping materials shall be stacked properly.
- xiv. No parking of trucks/trolleys, cranes and trailers etc. shall be allowed in the camp, which may obstruct the traffic movement as well as below LT/HT power line.
- xv. Utmost care shall be taken to ensure over all cleanliness and proper upkeep of the working areas.

16. WASTE MANAGEMENT

- i. Take suitable measures for waste management and environment related laws/legislation as a part of normal construction activities. Compliance with the legal requirements on storage/ disposal of paint drums (including the empty ones), Lubricant containers, Chemical Containers, and transportation and storage of hazardous chemicals will be strictly maintained.
- ii. Details of E-Waste, Hazardous Waste, biomedical waste etc. and their disposal plan, shall be submitted to BHEL every 6 months as per provided **formats**.

16.1 BINS AT WORK PLACE

- i. Sufficient rubbish bins shall be provided close to workplaces.
- ii. Bins should be painted yellow and numbered.
- iii. Sufficient nos. of drip trays shall be provided to collect oil and grease.
- iv. Sufficient qty. of broomsticks with handle shall be provided.
- v. Adequate strength of employees should be deployed to ensure daily monitoring and service for waste management.

16.2 STORAGE AND COLLECTION

- i. Different types of rubbish/waste should be collected and stored separately.
- ii. Paper, oily rags, smoking material, flammable, metal pieces should be collected in separate bins with close fitting lids.
- iii. Rubbish should not be left or allowed to accumulate on construction and other work places.
- iv. Do not burn construction rubbish near working site.

16.3 SEGREGATION

- i. Earmark the scrap area for different types of waste.
- ii. Store wastes away from building.
- iii. Oil spill absorbed by non-combustible absorbent should be kept in separate bin.
- iv. Clinical and first aid waste stored and incinerated separately.

16.4 DISPOSAL

- i. Sufficient containers and scrap disposal area should be allocated.
- ii. All scrap bin and containers should be conveniently located.
- iii. Provide self-closing containers for flammable/spontaneously combustible material.
- iv. Keep drainage channels free from choking.
- v. Make schedule for collection and disposal of waste.

16.5 WARNING AND SIGNS

- i. Appropriate sign to be displayed at scrap storage area
- ii. No toxic, corrosive or flammable substance to be discarded into public sewage system.
- iii. Waste disposal shall be in accordance with best practice.
- iv. Comply with all the requirements of Pollution Control Board (PCB) for storage and disposal of hazardous waste.

17. TRAFFIC MANAGEMENT SYSTEM

17.1 SAFE WORKPLACE TRANSPORT SYSTEM

- i. Traffic routes in a work place shall be suitable for the persons or vehicles using them. This shall be sufficient in number and of sufficient size. This shall reflect the suitability of traffic routes for vehicles and pedestrians.

- ii. Where vehicles and pedestrians use the same traffic routes there shall be sufficient space between them. Where necessary all traffic routes must be suitably indicated. Pedestrians or vehicles must be able to use traffic routes without endangering those at work. There must be sufficient separation of traffic routes from doors, gates and pedestrian traffic routes.
- iii. For internal traffic, lines marked on roads / access routes and between buildings shall clearly indicate where vehicles are to pass.
- iv. Temporary obstacles shall be brought to the attention of drivers by warning signs or hazard cones.
- v. Speed limits shall be clearly displayed for each kind of vehicle.
- vi. Speed ramps preceded by a warning signs or marker are necessary.
- vii. The traffic route should be wide enough to allow vehicles to pass and re-pass oncoming or parked traffic and it may be advisable to introduce on-way system or parking restrictions.
- viii. Safest route shall be provided between places where vehicles have to call or deliver.
- ix. Avoid vulnerable areas/items such as fuel or chemicals tanks or pipes, open or unprotected edges and structures likely to collapse
- x. Safe areas shall be provided for loading and unloading.
- xi. Avoid sharp or blind bends. If this is not possible hazards should be indicated e.g. blind corner.
- xii. Ensure road crossings are minimum and clearly signed.
- xiii. Entrance and gateways shall be wide enough to accommodate a second vehicle without causing obstruction.
- xiv. Set sensible speed limits which are clearly sign posted.
- xv. Where necessary ramps should be used to retard speed. This shall be preceded by a warning sign or mark on the road.
- xvi. Forklift trucks shall not pass over road hump unless of a type capable of doing so.
- xvii. Overhead electric cable, pipes containing flammable hazardous chemical shall be shielded by using goal posts height gauge posts or barriers.
- xviii. Road traffic signs shall be provided on prominent locations for prevention of incidents and hazards and for quick guidance and warning to employees and public. Safety signs shall be displayed as per the project working requirement and guideline of the state in which project is done. Vehicles hired or used shall not be parked within the 15m radius of any working area. Any vehicle, that is required to be at the immediate/near the vicinity, shall be approved by the person in-charge of the site.

17.2 TRAFFIC ROUTE FOR PEDESTRIANS

- i. Where traffic routes are used by both pedestrians and vehicles road shall be wide enough to allow vehicles and pedestrians safely.
- ii. Separate routes shall be provided for pedestrians to keep them away from vehicles. Provide suitable barriers/guard at entrances/exit and the corners or buildings.
- iii. Where pedestrian and vehicle routes cross, appropriate crossing shall be provided.

- iv. Where crowd is likely to use roadway e.g. at the end of shift, stop vehicles from using them at such times.
- v. Provide high visibility clothing for people permitted in delivery area.

17.3 WORK VEHICLE

Work vehicle shall be as safe stable efficient and roadworthy as private vehicles on public roads. Site management shall ensure that drivers are suitably trained. All vehicle e.g. heavy motor vehicle forklift trucks dump trucks mobile cranes shall ensure that the work equipment conforms to the following:

- i. A high level of stability.
- ii. A safe means of access/egress.
- iii. Suitable and effective service and parking brakes.
- iv. Windscreens with wipers and external mirrors giving optimum all round visibility.
- v. Provision of horn, vehicle lights, reflectors, reversing lights, reversing alarms.
- vi. Provision of seat belts.
- vii. Guards on dangerous parts.
- viii. Driver protection - to prevent injury from overturning and from falling objects/materials.
- ix. Driver protection from adverse weather.
- x. No vehicle shall be parked below HT/LT power lines.
- xi. Valid Pollution Under Control certification for all vehicles
- xii. Wheel stopper shall be use during the parking of vehicle
- xiii. Helper to be deployed in each vehicle as per site requirement.

17.4 DAILY CHECK BY DRIVER

- 1. There should also be daily safety checks containing below mentioned points by the driver before the vehicle is used.

Brakes	Mirrors	Warning signals
Tires	Windscreen waters	Specific safety systems i.e. controls & interlocks
Steering	Wipers	

- 2. Management should ensure that drivers carry out these checks.

17.5 TRANSPORTATION OF PERSONNEL AND MATERIALS BY VEHICLES

- i. All drivers shall hold a valid driving License for the class of vehicle to be driven and be registered as an authorized BHEL driver with the Administration Department.
- ii. Securing of the load shall be by established and approved methods, i.e. chains with patented tightening equipment for steel/heavy loads. Sharp corners on loads shall be avoided when employing ropes for securing.
- iii. All overhangs shall be made clearly visible and restricted to acceptable limits
- iv. Load shall be checked before moving off and after traveling a suitable distance.
- v. On no account is construction site to be blocked by parked vehicles Drivers of vehicles shall only stop or park in the areas designate by the stringing foreman.



- vi. Warning signs shall be displayed during transportation of material.
- vii. All vehicles used by BHEL shall be in worthy condition and in conformance to the Land Transport requirement.
- viii. Wheel stopper shall be use during the parking of vehicle
- ix. Helper to be deployed in each vehicle as per site requirement.

17.6 MAINTENANCE

All Vehicles used for transportation of man and material shall undergo scheduled inspections on frequent intervals to secure safe operation. Such inspections shall be conducted in particular for steering, brakes, lights, horn, doors etc. Site management shall ensure that work equipment is maintained in an efficient, working order and in good repair. Inspections and services carried out at regular intervals of time and or mileage. No maintenance shall be carried below HT/LT power lines.

18. EMERGENCY PREPAREDNESS AND RESPONSE

- i. Emergency preparedness and response capability of site shall be developed as per Emergency Preparedness and Response plan issued by BHEL
- ii. Availability of adequate number of first aiders and fire warden shall be ensured with BHEL and its subcontractors
- iii. All the subcontractor's supervisory personnel and sufficient number of workers shall be trained for fire protection systems. Enough number of such trained personnel must be available during the tenure of contract. Subcontractor should nominate his supervisor to coordinate and implement the safety measures.
- iv. Assembly point shall be earmarked and access to the same from different location shall be shown
- v. Fire exit shall be identified and pathway shall be clear for emergency escape.
- vi. Appropriate type and number of fire extinguisher shall be deployed as per Fire extinguisher deployment plan and validity shall be ensured periodically through inspection
- vii. Adequate number of first aid boxes shall be strategically placed at different work places to cater emergency need. Holder of the first aid box shall be identified on the box itself who will have the responsibility to maintain the same.
- viii. First aid center shall be developed at site with trained medical personnel and ambulance
- ix. Emergency contact numbers (format given in EPRP) of the site shall be displayed at prominent locations.
- x. Tie up with fire brigade shall be done in case customer is not having fire station.
- xi. Tie up with hospital shall be done in case customer is not having hospital.
- xii. Disaster Management group shall be formed at site
- xiii. Mock drill shall be arranged at regular intervals. Monthly report of the above to be given to BHEL HSE Officer as per prescribed BHEL formats
- xiv. Mock drill shall be conducted on different emergencies periodically to find out gaps in emergency preparedness and taking necessary corrective action

19. HSE INSPECTION

Inspection on HSE for different activities being carried out at site shall be done to ensure compliance to HSE requirements. The subcontractor shall maintain and ensure necessary safety measures as required for inspection and tests HV test, Pneumatic test, Hydraulic test, Spring test, Bend test as applicable, to enable inspection agency for performing Inspection. If any test equipment is found not complying with proper safety requirements then the Inspection Agency may withhold inspection, till such time the desired safety requirements are met.

Online/ App-based HSE Inspection system shall be used for inspection whenever provided by BHEL otherwise Hard-copy based system shall continue

	<input checked="" type="checkbox"/> OK	<input type="checkbox"/> NOT OK
Contractor Name:		
Equipment Identification No :		
Inspection Date :		
Next Inspection Date :		
Inspected By :		

Every Inspected Equipment shall display above sticker

19.1 INSPECTION PLAN

Subcontractor shall prepare an inspection plan covering all areas/ activities/ equipment/ hazards and implement the same after getting approval of BHEL. Responsibility to ensure coverage of all areas/ activities rests with the subcontractor.

All Inspections shall be witnessed by BHEL – only then they shall be considered as valid

19.2 INSPECTION REPORTS

Monthly inspection reports as per plan shall be submitted to BHEL HSE Head

19.3 NON-CONFORMANCES

Any non-conformances identified during inspection observed shall be addressed on priority.

The responsibility of resolution shall rest with the Subcontractor Site In-charge

In case immediate closure of non-conformities is not possible:

- a. work to be halted in the area
- b. non-conformance to be generated and submitted to responsible person and BHEL
- c. non-conformance to be resolved through responsible agency / person

Only after closure of non-conformances, work to be allowed to resume

19.4 DAILY HSE CHECKS

Both the Site Supervisors and HSE Officer of Subcontractor are to conduct daily site Safety inspection around work activities and premises to ensure that work methods and the sites

are maintained to an acceptable standard. The following are to form the common subjects of a daily safety inspection:

- i. Personal Safety wears & gear compliance.
- ii. Complying with site safety rules and permit-to-work (PTW).
- iii. Positions and postures of workers.
- iv. Use of tools and equipment etc. by the workers.

The inspection should be carried out just when work starts in beginning of the day, during peak activities period of the day and just before the day’s work ends.

19.5 INDICATIVE LIST OF INSPECTIONS AND PERIODICITIES

Indicative list & periodicity of Inspections is given as under. It is the responsibility of the subcontractor to develop an inspection plan covering all areas & activities in the scope.

SL. No.	Format Name	Frequency of check (if applicable)
01	Inspection of First Aid Box	Weekly
02	Inspection of PPE	Weekly
03	Inspection of T&Ps	Monthly
04	Inspection of Cranes	Monthly
05	Inspection of Winches	Monthly
06	Inspection on Height Working	Weekly
07	Inspection on Welding & Gas Cutting	Monthly
08	Inspection on Electrical Installation	Monthly
09	Inspection on Elevator	Weekly
10	Inspection of Excavation	Weekly
11	Inspection of Labor Colony	Monthly
12	Inspection of Illumination Levels	Weekly

The checklists shall be provided by BHEL at Site. It is the responsibility of the subcontractor to ensure their availability before start of work

19.5.1 INSPECTION OF PPE

- i. PPEs shall be inspected by HSE officer at random once in a week as per provided **format** for its compliance to standard and compliance to use and any adverse observation shall be recorded in the PPE register.
- ii. The applicable PPEs for carrying out particular activities are listed below.

19.5.2 INSPECTION OF TOOLS & PLANTS (T&Ps)

- i. A master list of T&Ps shall be maintained by each subcontractor in provided **format**.
- ii. All T&Ps being used at site shall be inspected by HSE officer once in a month as per provided **format** for its healthiness and maintenance.
- iii. The T&Ps which require third party inspection shall be checked for its validity during inspection. The third-party test certificate should be accompanied with a copy of the concerned competent person’s valid qualification record.

- iv. BHEL shall be given advance intimation of Third-Party Inspection. BHEL shall associate with Inspection as per discretion.
- v. The validity of T&P shall be monitored as per provided **format**

19.5.3 INSPECTION OF CRANES AND WINCHES

- i. Cranes and winches shall be inspected by the operator through a daily checklist for its safe condition (as provided by the equipment manufacturer) before first use of the day.
- ii. Cranes and Winches shall be inspected by HSE officer once in a month as per provided **format** for healthiness, maintenance and validity of third-party inspection.
- iii. The date of third-party inspection and next due date shall be painted on cranes and winches.
- iv. The operators/drivers shall be authorized by sub-subcontractor based on their competency and experience and shall carry the I-card.
- v. The operator should be above 18 years of age and should be in possession of driving license of HMV man & goods), vision test certificate and should have minimum qualification so that he can read the instructions and check list.

19.5.4 INSPECTION OF HEIGHT WORKING

- i. Any activity carried out at more than 2 m height is classified as height work.
- ii. Inspection of height working shall be conducted daily by Supervisors before start of work to ensure safe working condition including provision of
 - a. Fall arrestor
 - b. Lifelines – connected to rigid & independent structure
 - c. Safety nets deployed below all height work activities
 - d. Fencing and barricading
 - e. Warning signage
 - f. Covering of opening
 - g. Proper scaffolding with access and egress.
 - h. Illumination
- iii. For full duration of height work, constant supervision to be maintained by dedicated HSE personnel
- iv. Inspection on height working shall be conducted once in a week by HSE officer as per provided **format**.
- v. Medical fitness of height worker shall be ensured.
- vi. Height working shall not be allowed during adverse weather.

19.5.5 INSPECTION OF WELDING AND GAS CUTTING OPERATION

- i. Supervisor shall ensure that no flammable items are available in near vicinity during welding and gas cutting activity.
- ii. Gas cylinders shall be kept upright.
- iii. Use of Flash back arrestor shall be ensured at both ends.

- iv. Inspection during welding and gas cutting operations shall be carried out by HSE officer once a month as per provided **format**.
- v. Use of fire blanket to be ensured to avoid falling of splatters during welding or gas cutting operation at height.
- vi. Availability of fire extinguisher at vicinity shall be ensured.

19.5.6 INSPECTION OF ELECTRICAL INSTALLATION / APPLIANCES

- i. Ensure proper earthing in electrical installation
- ii. Use ELCB at electrical booth
- iii. Electrical installation shall be properly covered at top where required
- iv. Use appropriate PPEs while working
- v. Use portable electrical light < 24 V in confined space and potentially wet area.
- vi. Inspection shall be carried out as per provided **format**.

19.5.7 INSPECTION OF ELEVATOR

- i. Elevators shall be inspected by concerned supervisors once in a week as per provided **format**
- ii. All elevators shall be inspected by competent person and validity shall be ensured.
- iii. The date of third-party inspection and next due date shall be painted on elevator.

19.5.8 INSPECTION OF EXCAVATION

Excavation activities shall be inspected as per provided **format**

19.5.9 INTERNAL/ EXTERNAL HSE AUDITS/INSPECTIONS

- i. All non-conformities and observations on HSE identified during internal or external HSE audit shall be disposed of by site in a time bound manner and reported back the implementation status.
- ii. Corrective action and Preventive action on HSE issues raised by certification body issued by BHEL shall be implemented by site and reported to Site management.

20. TERMS AND DEFINITIONS:

1. Incident

Work- related or natural event(s) in which an injury, or ill health (regardless of severity), damage to property or fatality occurred, or could have occurred.

2. Near Miss:

An incident where no ill health, injury, damage or other loss occurs, but it had a potential to cause, is referred to as "Near-Miss".

3. Man-Hours Worked:

The total number of man hours worked by all employees including subcontractors working in the premises. It includes managerial, supervisory, professional, technical, clerical and other workers including contract labors. Man-hours worked shall be calculated from the payroll or time clock recorded including overtime. When this is not feasible, the same shall be estimated by multiplying the total man-days worked

period covered by the number of hours worked per day. The total number of workdays for a period is the sum of the number of men at work on each day of period. If the daily hours vary from department to department separate estimate shall be made for each department and the result added together.

4. First Aid Cases:

First aids are not essentially all reportable cases, where the injured person is given medical treatment and discharged immediately for reporting on duty, without counting any lost time.

5. Lost Time Injury:

Any work injury which renders the injured person unable to perform his regular job or an alternative restricted work assignment on the next scheduled work day after the day on which the injury occurred.

6. Medical Cases:

Medical cases come under non-reportable cases, where owing to illness or other reason the employee was absent from work and seeks Medical treatment.

7. Type of Incidents & Their Reporting:

The three categories of Incident are as follows:

8. Non-Reportable Cases:

An incident, where the injured person is given medical help and discharged for work without counting any lost time.

9. Reportable Cases:

In this case the injured person is disable for 48 hours or more and is not able to perform his duty.

10. Injury Cases:

These are covered under the heading of non-reportable cases. In these cases, the incident caused injury to the person, but he still continues his duty.

11. Total Reportable Frequency Rate

Frequency rate is the number of Reportable Lost Time Injury (LTI) per one Million Man hours worked. Mathematically, the formula read as:

Number of Reportable LTI x 1,000,000/ Total Man Hours Worked

12. Severity Rate:

Severity rate is the Number of days lost due to Lost Time Injury (LTI) per one Million Man hours worked. Mathematically, the formula reads as:

Days lost due to LTI x 1,000,000/ Total Man Hours Worked

13. Incidence Rate:

Incidence Rate is the Number of LTI per one thousand manpower deployed. Mathematically, the formula reads as:

Number of LTIx1000/Average number of manpower deployed

14. HIRA:

Hazard Identification and Risk Assessment (HIRA) is a process of identifying Hazards in work area and then assessing them properly

15. Method Statement:

A method statement is prepared by the Execution/ Engineering Department detailing the steps, equipment, competencies and safety precautions required for carrying out any activity

16. Job Safety Analysis:

A job safety analysis (JSA) is a procedure which helps integrate accepted safety and health principles and practices into a particular task or job operation. In a JSA, each basic step of the job is to identify potential hazards and to recommend the safest way to do the job. Other terms used to describe this procedure are job hazard analysis (JHA) and job hazard breakdown.

17. Safety Walk:

It's conducted periodically by an official - it's a walk through a portion or whole of a site as a HSE officer who notes down HSE observations, speak to concerned workmen and supervisor on observation, get the same corrected with personal follow up- this sends out a strong message on Management's commitment to safety.

18. Heavy & Complex Lifting:

A heavy and complex lifting activity includes:

1. Lifting above 20 Tons
2. Tandem Lifting using multiple cranes
Total load exceeding 75% of capacity of crane. Depending up the condition of cranes, hydra cranes, winch machines & other lifting accessories
3. Lift of unusual difficulty or geometry or rigging
4. Lift over operating units
5. Any other lift as decided by site HSE / Erection

19. Safety Committee:

As per the BOCW, Safety Committee shall be constituted if there are more than five hundred or more construction workers are employed at any site. As per the Factories Act, 1948 it is for 250 workers. It shall be represented by equal number of representatives of employer and construction workers.

20. Night Work:

Work conducted after sunset when only a fraction of total manpower is available





ANNEXURES



ANNEXURE A

Medical Centre & Ambulance

Rk

A. Medical Centre

1. Paramedical staff
 - a. When < 500 workers, 1 Trained Male Nurse (round the clock deployment)
 - b. When >=500 workers*:
 - i. Registered Medical Practitioner (Qualified MBBS) to be deployed for at least 8 hours in a day, 5 days per week
 - ii. 2 Trained Male Nurses (round the clock deployment)
 2. All articles as per Schedule IV of BOCW Central Rules, 1998 to be made available in the Medical Centre (given under for convenience)
 3. Basic Facilities/ Requirements to be provided as per location eg. Refrigerator, Air Conditioner, Anti Venom Serums etc.
 4. Tie-ups with speciality hospitals to be ensured for referring serious patients
- * In case the number of workers is envisaged to exceed 500, a medical practitioner is to be engaged.

SCHEDULE IV (BOCW CENTRAL RULES, 1998) ARTICLES FOR AMBULANCE ROOM [SEE RULE 226 (C)]

- i. A glazed sink with hot and cold water always available.
- ii. A table with a smooth top at least 180 cm x 105 cm.
- iii. Means for sterilising instruments.
- iv. A couch.
- v. Two stretchers.
- vi. Two buckets or containers with close fitting lids.
- vii. Two rubber hot water bags
- viii. A kettle and spirit stove or other suitable means of boiling water.
- ix. Twelve plain wooden splints 900 cm x 100 cm x 6 cm.
- x. Twelve plain wooden splints 350 cm x 75 cm x 6 cm.
- xi. Six plain wooden splints 250 cm x 50 cm x 12 cm.
- xii. Six woollen blankets.
- xiii. Three pairs of artery forceps.
- xiv. One bottle of spiritus annemia aremations (120 ml).
- xv. Smelling salt (60 gm).
- xvi. Two medium size sponges.
- xvii. Six hand towels.
- xviii. Four kidney trays.
- xix. Four cakes of toilet, preferably antiseptic soap.
- xx. Two glass tumblers and tow wine glasses.
- xxi. Two clinical thermometers.
- xxii. Two tea spoons.
- xxiii. Two graduated (120 ml) measuring glasses.
- xxiv. Two minimum measuring glasses.
- xxv. One wash bottle (1000 cc) for washing eyes.
- xxvi. one bottle (one litre) carbolic lotion 1 to 20.
- xxvii. Three chairs.
- xxviii. One screen.
- xxix. One electric hand torch.
- xxx. Four first-aid boxes or cupboards stocked to the standards prescribed in
- xxxi. An adequate supply of tetanus toxide.
- xxxii. Injections—morphia, pethidine, atrophine, adrenaline, coramine, novocaine (6 each).
- xxxiii. Cramine liquid (60 ml).
- xxxiv. Tablets—antihistaminic antispasmodic (25 each).
- xxxv. Syringes with needles—2 cc, 5 cc, 10 cc and 500 cc.

- xxxvi. Three surgical scissors.
- xxxvii. Two needle holders, big and small.
- xxxviii. Suturing needles and materials.
- xxxix. Three dissecting forceps
 - xl. Three dressing forceps
 - xli. Three scalpels.
 - xlii. One stethoscope and a B. P. apparatus.
- xliii. Rubber bandage—pressure bandage.
- xliv. Oxygen cylinder with necessary attachments.
- xlv. Atropine eye ointments.
- xlvi. I. V. Fluids and sets 10 nos.
- xlvii. Suitable, foot operated, covered, refuse containers.
- xlviii. Adequate number of sterilised, paired, latex hand gloves.

B. Ambulance

1. When number of workers is <500:
If the distance to a major hospital capable of handling critical injuries expected at Site is <= 50 KM from Site, then 1 BLS (Basic Life Support)/ Type B Ambulance otherwise ALS* (Advanced Life Support)/ Type D Ambulance
2. If no. of workers increases to >2000 workers one additional BLS Ambulance to be deployed
3. Minimum Articles as per Schedule V of BOCW Central Rules to be ensured in each Ambulance. (given under for convenience)

*Final call to be taken at Site in consultation with all the contractors

SCHEDULE V (BOCW CENTRAL RULES, 1998) CONTENTS OF AMBULANCE VAN OR CARRIAGE [SEE RULE 227]

The Ambulance Van shall have equipment prescribed as under:

- a) General—a portable stretcher with folding and adjusting devices with the Head of the stretcher capable of being tilted upward. Fixed suction unit with equipment. Fixed oxygen supply with equipment. Pillow with case, sheets, blankets, towels, emergency bag, bed pan, urinal glass.
- b) Safety Equipment—Flaros with life of three thousand minutes, floor lights, flash lights, fire extinguishers (dry power type), insulated guntlets.
- c) Emergency Care Equipment—
 - i. **Resuscitation**—Portable suction unit, portable oxygen unit, bag valve mask, hand operated artificial ventilation unit, airways, mouth gag tracheostomy adapters, short spine board, I.V. FLUIDS with administration unit, B. P. manometer cuff stethoscope.
 - ii. **Immobilisation**—Long and short padded boards, wire ladder splints, triangular bandage—long and short spine boards.
 - iii. **Dressing**—Gauze pads—100 m x 100 mm universal dressing 250 x 1000 mm, roll of aluminium foils—soft roller bandages 150 mm x 5 mm yards adhesive tape in 75 mm roll safety pins, bandage sheets, burn sheets.
 - iv. **Poisoning**—Syrup of Ipecac, activated charcoal pre packeted dose, snake bit kit, drinking water.
 - v. **Emergency Medicines**—As per requirement (under the advice of construction Medical Officer).



ANNEXURE A.1

Sample calculation for deduction of operational cost of facilities

Annexure A.1**Cost Calculation Methodology of Operation of Facilities (Data is indicative only)**

(Period of 48 months is considered - shall be on actual basis)

A. Project Info:

Total time of Project	48 months
Project cost	1000 Crore
No. of packages	10 (A1-A10)

B. Item-wise Calculation:

Item	Nos.	Rate	Unit	Amount
Ambulance with Driver	2		Monthly/Unit	170000
Nurse/First aider	2 X 2 shifts	15000	Per month	30000
Training center one time cost	1	100000	Once	100000
Medical center one time cost	1	200000	Once	200000
Medicines at medical center	1	10000	Monthly	10000
Dust supression water tank	2	2000	Monthly	4000
Doctor	1	70000	Monthly	70000
Cleaning staff	1	12000	Monthly	12000
Recurring monthly expenditure				296000
Total one-time expenditure				300000

C. Package-wise Deduction Plan for a period of 48 months

Period (In Months)	6	36	6
	For 1-6 months	For 7-42 months	For 43-48 months
Cost to be incurred from contractors	7%	81%	12%
	1.17% per month	2.25% per month	2.00% per month

D. Calculation For One-Time Running Cost

Packages/ Contracts	A1	A2	A3	A4	A5	A6	A7	A8	A9	A10				
Contract Values (in Thousands)	100000	250000	2000000	200000	500000	1500000	1000000	1000000	250000	200000	7000000			
Share of common facilities one time running cost (in Thousands)	4	11	86	9	21	64	43	43	11	9	Individual Pkg value X Total one time running cost / All Pkg award values			
Timeline of work	1-6	1-8	2-48	6-36	7-15	10-48	6-48	7-40	40-48	41-48				
Month Count of work	6	8	47	31	9	39	43	34	9	8				
Deduction per month (in Thousands)	1	1	2	0	2	2	1	1	1	1	Total of One time Running cost (in thousands)	% deduction share of one time running cost per month	Nos. of active packages in month	
Month No.														
1	1	1									2	1%	2	
2	1	1	2								4	1%	3	
3	1	1	2								4	1%	3	
4	1	1	2								4	1%	3	
5	1	1	2								4	1%	3	
6	1	1	2	0			1				5	2%	5	
7		1	2	0	2		1	1			8	3%	6	
8		1	2	0	2		1	1			8	3%	6	
9			2	0	2		1	1			7	2%	5	
10			2	0	2	2	1	1			8	3%	6	
11			2	0	2	2	1	1			8	3%	6	
12			2	0	2	2	1	1			8	3%	6	
13			2	0	2	2	1	1			8	3%	6	
14			2	0	2	2	1	1			8	3%	6	
15			2	0	2	2	1	1			8	3%	6	
16			2	0		2	1	1			6	2%	5	
17			2	0		2	1	1			6	2%	5	
18			2	0		2	1	1			6	2%	5	
19			2	0		2	1	1			6	2%	5	
20			2	0		2	1	1			6	2%	5	
21			2	0		2	1	1			6	2%	5	
22			2	0		2	1	1			6	2%	5	
23			2	0		2	1	1			6	2%	5	
24			2	0		2	1	1			6	2%	5	
25			2	0		2	1	1			6	2%	5	
26			2	0		2	1	1			6	2%	5	
27			2	0		2	1	1			6	2%	5	
28			2	0		2	1	1			6	2%	5	
29			2	0		2	1	1			6	2%	5	
30			2	0		2	1	1			6	2%	5	
31			2	0		2	1	1			6	2%	5	
32			2	0		2	1	1			6	2%	5	
33			2	0		2	1	1			6	2%	5	
34			2	0		2	1	1			6	2%	5	
35			2	0		2	1	1			6	2%	5	
36			2	0		2	1	1			6	2%	5	
37			2			2	1	1			6	2%	4	
38			2			2	1	1			6	2%	4	
39			2			2	1	1			6	2%	4	
40			2			2	1	1	1		7	2%	5	
41			2			2	1		1	1	7	2%	5	
42			2			2	1		1	1	7	2%	5	
43			2			2	1		1	1	7	2%	5	
44			2			2	1		1	1	7	2%	5	
45			2			2	1		1	1	7	2%	5	
46			2			2	1		1	1	7	2%	5	
47			2			2	1		1	1	7	2%	5	
48			2			2	1		1	1	7	2%	5	
Total	4	11	86	9	21	64	43	43	11	9	300	100%		

D. Calculation For Recurring Running Cost

Packages/ Contracts	A1	A2	A3	A4	A5	A6	A7	A8	A9	A10		
Contract Values (in Thousands)	100000	250000	2000000	200000	500000	1500000	1000000	1000000	250000	200000	7000000	
Timeline of work	1-6	1-8	2-48	6-36	7-15	10-48	6-48	7-40	40-48	41-48	Total of Recurring cost (in thousands)	Nos. of active packages in month
Month No.	6	8	47	31	9	39	43	34	9	8		
1	85	211									296	2
2	13	31	252								296	3
3	13	31	252								296	3
4	13	31	252								296	3
5	13	31	252								296	3
6	8	21	167	17			83				296	5
7		15	120	12	30		60	60			296	6
8		15	120	12	30		60	60			296	6
9			126	13	31		63	63			296	5
10			95	10	24	72	48	48			296	6
11			95	10	24	72	48	48			296	6
12			95	10	24	72	48	48			296	6
13			95	10	24	72	48	48			296	6
14			95	10	24	72	48	48			296	6
15			95	10	24	72	48	48			296	6
16			104	10		78	52	52			296	5
17			104	10		78	52	52			296	5
18			104	10		78	52	52			296	5
19			104	10		78	52	52			296	5
20			104	10		78	52	52			296	5
21			104	10		78	52	52			296	5
22			104	10		78	52	52			296	5
23			104	10		78	52	52			296	5
24			104	10		78	52	52			296	5
25			104	10		78	52	52			296	5
26			104	10		78	52	52			296	5
27			104	10		78	52	52			296	5
28			104	10		78	52	52			296	5
29			104	10		78	52	52			296	5
30			104	10		78	52	52			296	5
31			104	10		78	52	52			296	5
32			104	10		78	52	52			296	5
33			104	10		78	52	52			296	5
34			104	10		78	52	52			296	5
35			104	10		78	52	52			296	5
36			104	10		78	52	52			296	5
37			108			81	54	54			296	4
38			108			81	54	54			296	4
39			108			81	54	54			296	4
40			103			77	51	51	13		296	5
41			120			90	60		15	12	296	5
42			120			90	60		15	12	296	5
43			120			90	60		15	12	296	5
44			120			90	60		15	12	296	5
45			120			90	60		15	12	296	5
46			120			90	60		15	12	296	5
47			120			90	60		15	12	296	5
48			120			90	60		15	12	296	5
Total	143	388	5676	329	235	3102	2334	1772	132	96	14208	



ANNEXURE B

HSE Displays

Rk

A. Types of Displays**1. Based on Content**

SN	Type
1.	HSE Hazards & Precautions Height Work, Housekeeping, Fire Safety, PPEs, Hot Work, Lifting & Rigging Activity, Site-specific Hazards – eg. for Refineries, Nuclear plants etc.; COVID Precautions; Environment Protection etc.
2.	Other Displays, Signage etc. HSE Policy, ISO Certificate, Safety Statistics, Assembly Area Location/ Route, Emergency Contact Numbers, Site Safety Rules & Regulations, Speed Limit, Work in Progress, Lock-Out Tag-Out (LOTO) Boards etc.

2. Based on Mounting

[Type 1]	[Type 2]	[Type 3]
Flex Sign Boards of Wooden Frame – directly mounted on Structures (walls, stairs, railings etc.)	Flex Sign Boards with Wooden Frame – mounted on metallic/ wooden legs – preferably double-sided	Coloured weather-proof Paintings on Walls (after due concurrence of BHEL/ Customer – Type 1 in case of no concurrence/ space)

B. General Requirements:

- a. Displays should be weather-proof as per installation location, i.e. rain-proof, wind-proof and sun-proof.
- b. Installation location and size to ensure visibility for the intended viewers (workers and moving personnel)
- c. Displays to have at least 50% graphical elements preferably (as applicable). Language should be understandable by majority of the workers
- d. Displays to be relevant to the hazards in the area
- e. Proper installation to ensure boards don't obstruct activities and should not be prone to fall so as to pose danger
- f. In case of multiple elevations (eg. Boiler, Power-house etc.), each elevation to have displays for applicable hazards including Height-Work, Housekeeping
- g. For temporary work locations, posters/ boards may be erected and shifted after task is over
- h. Minimum size of displays should be A1 unless otherwise specified
- i. In case of damage, displays shall be reviewed and repaired/ replaced
- j. In areas where night work is envisaged, fluorescent displays shall be installed and these should comprise of at least 20-30% of total displays
- k. Total Number of displays to be not less than 1 per 10 workers and are to be dynamically updated based on number of workers

C. Area-wise Displays

Below is list of Area-wise displays that are to be installed at Sites (Numbers, locations may be adjusted for specific requirements)

SN	Area	Suggested Subjects	Minimum Size	Minimum Quantity	Locations
1	Walls/ Foundations/ Cement Structures etc. belonging to the package area	Safety Hazards Prevention and other HSE Awareness content	[Type 3]	As per BHEL assessment from time to time	
2	Site Interior Roads belonging to the package area	At least every 20 meters: 1. Speed Limit Indication, Safe Driving board 2. Boards for hazard awareness	1.As needed [Type 2] 2. A1 or equivalent each [Type 2]	As indicated	Sides of Roads; Height to ensure good visibility
3	Specific Package Areas	<p>A. Common At entry to respective Package/ Work Area, each contractor to put up daily updated board with following for each shift:</p> <ol style="list-style-type: none"> 1. Scope of work and start date 2. Emergency Contact Numbers 3. Emergency Assembly Location, Escape Plan 4. Locations and supervisors of various gangs in the area, 5. Current Work permit Details 6. Safety Supervisor Location assignments - Names, Mobile Nos., Assigned Locations 7. Details (Name, Contact No. etc.) of Package In-charge - Contractor & BHEL 8. Details (Name, Contact No. etc.) of Safety In-charge - Contractor & BHEL 9. LTI Free Man-days & details of last LTI also to be indicated <p>In addition, Area-Specific Displays as indicated in Table 1</p>	A0 [Type 2]	1 per Package Area	Entry/ Ground Level

Table 1
(Area/ Package-wise HSE Display Plan – As applicable)

Prepared By (Subcontractor)				
S. No.	Area	Suggested Minimum No. of Displays & Types	Type	Numbers Installed
1	Boiler	3 per working elevation	[Type 1]	
2	Powerhouse	5 per elevation	[Type 1]	
3	ESP	5 Per Pass	[Type 1]	
4	Buildings	5 per elevation	[Type 1]	
5	Cooling Tower (NDCT/ IDCT/ ACC)	20 per Structure	[Type 1]	
6	Chimney	20 per Structure	[Type 1]	
7	Fabrication Yard	10 per Yard	[Type 2]	
8	Batching Plant	5 per Plant	[Type 1]	
9	Material Storage Yard – Open	20 per Yard	[Type 2]	
10	Material Storage Shed – Semi-Closed/ Closed	10 per Shed	[Type 1]	
11	Electrical Booths	2 per booth + Line diagram, Emergency contact details	[Type 1]	
12	Medical & First Aid Centre	2 per Centre	[Type 1]	
13	Rest Shed	2 per Shed	[Type 1]	
14	Canteen	2 per Canteen	[Type 1]	
15	Drinking Water Area	1 Per Outlet	[Type 1]	
16	Washing Water Area	1 Per Outlet	[Type 1]	
17	Training Centre	10 per room	[Type 1/2]	
18	Assembly Area	5	[Type 1/2]	
19	Stairs	1 per landing elevation	[Type 1]	
20	Cylinder Storage Area	5 + Signage: Type of Gas, Empty, Filled etc.	[Type 1/2]	
21	Labor Colony	Electrical Safety with Distribution Plan/ Line Diagram - 1 COVID Precautions Posters – 5 Safety Awareness Posters – 10 Hygiene awareness posters - 2	[Type 1]	
22	Others	As per requirement	[Type 1/2]	

Date:

Sign (Contractor)

Sign (BHEL)





ANNEXURE C

HSE Tools/ Equipment/ Devices

Rk

Following equipment conforming to relevant IS/ISO/BS Codes/ Standards in indicated quantities shall be ensured by subcontractor. This list is tentative, not exhaustive. Quantity and date/ period of deployment shall be as per site requirement.

A. HSE Tools/ Equipment/ Devices

SN	Item
1	Lifelines
2	Retractable Fall Arrestors
3	Safety Nets (10m X 5m) fire proof double mesh
4	Sky Climbers
5	Fire Blanket
6	Honey Bee Removal Suit & Kit
7	Scaffolding Pipes
8	Flashback Arrestors
9	Barricading Tape
10	Binoculars
11	Walkie-Talkies
12	LOTO kit
13	24-Volt light
14	Sand Buckets
15	Hard barricading Pipes
16	Standby Fire kits
17	Hand-held Megaphone
18	Small Public Address System
19	Foldable Stretcher
20	Height Rescue Kit (Non-Motorized)
	(Others:)

B. Test & Measurement Devices

SN	Device
1	ELCB Tester
2	Multi meter (Light cables)
3	Earth Resistance Meter
4	Lux Meter
5	Sound Meter
6	Anemometer
7	Breath Analyzer (Alcohol)
8	Multi-gas dozi-meter/ detector
9	Gas leakage detector / alarm
10	Gas monitor (confined space)
11	Radiation meter & Badges
12	Blood Pressure Monitor
13	Fire detectors
14	Hand held signaling light
	(Others:)



ANNEXURE D

Rest Sheds

Rk

1. Determining the Number, Sizes and Locations of Rest Shelters

i. **Numbers:**

The number of rest shelters shall be determined based on maximum number of workers at any one time (across all shifts). Formula is:

W_{max} = Maximum number of workers at any time in the Site

Space per worker = 1.1 sq meter

Total space required, T_{space} = $W_{max} \times 1.1$

Based on total space requirement calculated above, the number of rest sheds can be decided according to availability of locations and concentration of workers – so as to ensure the required space.

ii. **Locations:**

The rest sheds should be so located so as to minimize the distance to be travelled by the workers from their locations of work considering all the practical constraints

iii. **Other:**

The Rest shelter should be fenced so that it cannot be used as parking area.

2. Design & Construction of Rest Sheds

a. **Permanent/ Long duration Rest Sheds**

- i. For locations where, permanent rest sheds can be constructed without possibility of removal for relatively long period of time, a semi-closed shed can be constructed covered with tin roof and supported with well-grouted beams. The floor of the shed to be preferably cemented/ solidified.
- ii. Adequate structural requirements suitable to the local weather (wind/ rain etc.) to be ensured.
- iii. The design of the rest shed to be approved by Civil Engineering Department of BHEL Site before commencing work

b. **Temporary/ Movable/ Portable Rest Sheds**

- i. For locations where, permanent rest sheds cannot be constructed either due to non-availability of permanent location or other reasons, temporary rest shed shall be constructed.
- ii. Temporary rest sheds shall comprise of Tent arrangement carried out by professional agencies

3. Amenities in Rest Sheds

a. **Essential Amenities**

Following amenities shall be essentially ensured in a rest shed:

- i. Hygienic environment with regular cleaning and housekeeping (with records)
- ii. Adequate illumination
- iii. Adequate ventilation/ heating as per weather conditions
- iv. Clean Drinking water source
- v. Hand Washing area
- vi. Toilets & Urinals
- vii. Benches/ mats for sitting/ lying
- viii. Any other essential requirement deemed necessary by the Site
- ix. Dust bins of sufficient quantity/ size that are vacated each day/ as per requirement

b. **Additional/ Optional Amenities**

Following amenities are optional but are recommended to enhance the level of satisfaction of work force:

- i. Hot/ Cold drinks (Tea, Coffee, Glucose etc.) as per requirement
- ii. Snacks
- iii. Fans/ Coolers/ Heating arrangements as per requirement and weather conditions
- iv. A nice, welcoming interior design, music etc.
- v. Water cooler

4. Health & Safety Requirements of Rest Sheds

Use of asbestos in construction is banned and shall not be used.

In addition, following essential Safety features shall be ensured in Rest sheds:

- i. Availability of Fire extinguishers (preferably CO2 type)
- ii. Display of Safety Posters
- iii. Pest/ reptile protection
- iv. Mosquito prevention measures

5. Note:

Any suitable closed spaces/ newly constructed buildings etc. available at project may also be used for the purpose of rest shed with due concurrence of BHEL



ANNEXURE E

Labor Colony

Rk

1. These Guidelines suggest minimum requirements. However, additional requirements based on feasibility and circumstances, while adhering to directions of GOI/District Administration/Local Authority guidelines to be considered
2. Norms for social distancing, training/ awareness, face masks, disinfection, sanitization, gate entry, quarantine, medical, action in case of suspect cases of COVID and other communicable diseases etc. to be followed as per Govt. and BHEL guidelines issued from time to time
3. Labor colony to be developed as close to the Site as possible to avoid lengthy commute
4. A "Suggestion Register" shall be made available at the labor colony for residents. The feedback shall be reviewed on weekly basis and acted upon by concerned Contractor. Same shall be reviewed periodically by authorized BHEL Site Official.
5. **Canteens, Latrines & Urinals, Washing Facilities, Creches, Residential Accommodation and other infrastructure/ facilities:**
Numbers/ Quantities and Features of these facilities shall be in line with the following as applicable:
 - a. BOCW Act & State Rules
 - b. The Inter-State Migrant Workmen (Regulation of Employment and Conditions of Service) Act & State Rules
 - c. Factories Act & State Rules
 - d. Other Relevant Acts & Rules
6. **Cleanliness & Hygiene/ Housekeeping:**
 - a. Regular cleaning of the labor colony to be ensured.
 - b. Daily cleaning of Sanitary facilities.
 - c. Proper drainage system to prevent water-logging
 - d. Regular fogging to prevent spread of mosquitoes
 - e. Prevention of foul smell through necessary interventions
 - f. Dust suppression as per requirement
 - g. Cutting of Grass at regular intervals and other necessary measures to prevent pests & reptiles
 - h. Stray animals to be banned from labor colony.
 - i. Outside every common facility, eg. Toilet, washroom, food hall/ canteen etc., provision of washbasin with flowing water and soap (preferably liquid soap) to be ensured
7. **Power Supply Layout:**
Electrical supply Layout of Labor Colony shall have the provision of Safety devices like MCBs, ELCBs etc. and to be clearly displayed
8. **Washing & Drinking Water Availability**
 - a. Adequate water to be provided in line with: "Estimation of Water Requirements for Drinking and Domestic Use (Source: National Building Code 2016, BIS)"
 - b. Drinking water tank to be cleaned every week and sticker for the same pasted on the tank
 - c. Drinking water source should be tested as per IS 10500
9. **Waste Disposal:** Separate bins for dry, wet and biomedical waste to be installed. These bins to be evacuated regularly
10. **Training & Awareness/ Displays**
 - a. **HSE Awareness Displays:** Posters/ banners/ boards to be displayed in labor colony. Subjects of displays shall be precautions for applicable hazards at work site.
 - b. **Emergency Contact Numbers** including that of Doctor, Hospital, Labor Colony Supervisor, HSE Officials to be displayed prominently

11. Doctor Visits:

Regular and need-based visits by Doctors to be ensured through tie-ups etc.

12. Inspection & Review: Regular inspection of labor accommodation to be carried out by the Contractor as per prescribed format. Last inspection date, inspector and next due date to be prominently indicated near main gate

13. Provision of a Fair Price shop in the premises to be ensured as per requirement

14. Adequate arrangements to be ensured in case of children/ families



ANNEXURE F

Toilets

Rk

Toilets (Latrines and urinals shall be ensured at Site and Labor Colony in accordance with the Inter-State Migrant Workmen Act, 1979 as given below:

LATRINES	URINALS
<p>1. Latrines shall be provided in every establishment on the following scale, namely: -</p> <p>a. Where females are employed, there shall be at least one latrine for every 25 females;</p> <p>b. Where males are employed, there shall be at least one latrine for every 25 males:</p> <p>Provided that where the number of males or females exceeds 190, it shall be sufficient if there is one latrine for 25 males or females, as the case may be, up to the first 100, and one for every 30 thereafter</p> <p>2. Every latrine shall be under cover and so partitioned off as to secure privacy, and shall have a proper door and fastenings.</p>	<p>1. There shall be at least one urinal for male workers up to fifty and one for female up to fifty employed at a time:</p> <p>Provided that where the number of male or female workmen, as the case may be, exceeds 500 it shall be sufficient if there is one urinal for every fifty females up to the first 500 and one for every 100 or part thereof thereafter.</p> <p>2. The urinals shall be designed and located so as to ensure privacy.</p>

Important:

- Where workers of both sexes are employed there shall be displayed outside each block of latrine and urinal a notice in the language understood by the majority of the workers '**For Men Only**', or '**For Women Only**', as the case may be.
- The notice shall also bear the figure of a man or of a woman, as the case may be.
- The latrines and urinals shall be conveniently situated and accessible to workers at all times at the establishment.
- The latrines and urinals shall be adequately lighted and shall be maintained in a clean and sanitary condition at all times.
- Latrines and urinals other than those connected with a flush sewage system shall comply with the requirements of the public health authorities.
- Water shall be provided by the means of tap or otherwise so as to be conveniently accessible in or near the latrines and urinals.
- At Site, on ground, **Modular Bio-toilets** as per industry standard specifications and regular professional cleaning shall be ensured. The toilets should be sufficient in number and easily accessible to workers from every work area
- At Site, in various elevations, suitable urinals with proper drainage to be ensured at each elevation in line with IS 2064 (1993). Same to be cleaned regularly



ANNEXURE G

Fire Extinguishers

Rk

SN	Type of Fire Risk (Class of Fire)	Extinguishing Medium & Relevant INDIAN STANDARD	Scale of Equipment (Minimum recommended)
1.	CLASS 'A' Fires involving ordinary combustible materials like wood, paper, textiles, rubber etc. (Ordinary hazard or low fire load)	WATER Soda acid type, water type (gas pressure) and water type (constant air pressure) IS: 934 -1976; IS: 940 -1976; IS: 6234 -1971	For every 600 square meter floor area or part, one 9-litre capacity. Minimum 4 numbers per floor or room; should not be required to travel more than 15 meter to reach any extinguisher.
2.	CLASS 'A' (Extra hazard & high fire load)	-do	-do – (Also, consult local fire authority).
3.	CLASS 'A' (Special hazards)	-do	-do – Extra provision For every 100 square meter floor area or part, one 4.5 Kg. CO ₂ ; minimum 2 numbers per room; should not be required to travel more than 10 meter to reach any extinguisher.
4.	CLASS 'B' (Fires in flammable liquids like oils, solvents, petroleum, products, varnishes, paints, etc. where blanketing effect is essential) (Storage and handling in small quantities)	FOAM / CARBON DIOXIDE / DRY CHEMICAL POWDER IS: 933 -1976; IS: 2878 1976; IS: 2171 1976; IS: 4308 -1982	For every 50 square meter floor area or part, 2 numbers 9 -liters foam or 5 kg dry powder; should not be required to travel more than 10 m in the area of storage to reach any extinguisher.
5.	CLASS 'B' (Bulk storage other than in tank form))	-do -	-do- (but minimum 3 numbers per room)
6.	CLASS 'C' (Fires involving gaseous substances under pressure where it is necessary to dilute the burning gas at a very fast rate with an inert gas or powder) (storage and handling of gas cylinders)	CARBON DIOXIDE / DRY CHEM. POWDER. The best way to extinguish such fire is by stopping the flow of fuel gas to the fire. Container is kept cool with water spray. IS: 2878 1976; IS: 2171 -1976; IS: 4308 -1982	For every 100 square meter floor area or part; 2 numbers, 10 kg powder extinguisher or 6 kg CO ₂ ; minimum 3 nos. per room; should not be required to travel more than 10 meter to reach any extinguisher.
7.	CLASS 'D' Fires involving metals like magnesium, aluminum, zinc, potassium etc. where the burning metal is reactive to water and which require special extinguishing media or technique	SPECIAL DRY POWDER IS: 2171 -1976 IS: 4861 -1968	For every 50 square meter floor area or part, 2 nos. 5 kg special dry powder; minimum 3 nos. per room; should not be required to travel more than 10 meter to reach any extinguisher.
8.	MIXED OCCUPANCY (electrical); Generators; Transformers; etc.	CARBON DIOXIDE DRY POWDER, IS: 2878 1976; IS: 2171 -1976	For every 100 square meter floor area or part one 10 kg CO ₂ . Minimum 2 numbers for every location should not be required to travel more than 10 meter to reach an extinguisher.

Note: Due to peculiarities of the power plant construction sites, there would be locations in the construction areas of Boiler, Turbine, Generator, Transformer, etc. where different types of fire risk (classes of fire) may co-exist. Special care shall be taken while selecting and installing portable fire extinguishers for such locations so that all types of fire risk that may co-exist, are adequately covered. Similar special care shall be taken for storage areas.

- a. All Electrical welding booths shall be equipped with appropriate Fire Extinguisher

- b. Appropriate Fire Extinguishers shall be made within easy reach of all welding operations
- c. Fire extinguishers shall be regularly tested and last checked date to be indicated on each. Master list shall be prepared with location and details
- d. Providing appropriate fire-fighting equipment at designated work place and nominate a fire officer/warden adequately trained for his job.
- e. Subcontractor shall provide enough fire protecting equipment of the types and numbers at his office, stores, temporary structure in labour colony etc. Such fire protection equipment shall be easy and kept open at all times.
- f. The fire extinguishers shall be properly refilled and kept ready which should be certified at periodic intervals. The date of changing should be marked on the Cylinders.
- g. All other fire safety measures as laid down in the “codes for fire safety at construction site” issued by safety coordinator of BHEL shall be followed.
- h. Non-compliance of the above requirement under fire protection shall in no way relieve the subcontractor of any of his responsibility and liabilities to fire incident occurring either to his materials or equipment or those of others.
- i. Emergency contacts nos. must be displayed at prominent locations
- j. Tarpaulin being inflammable should not be used (instead, only non-infusible covering materials shall be used) as protective cover while preheating, welding, stress relieving etc. at site.



ANNEXURE H
HSE Compliance Certificate

Rk

Bill Ref no: _____ Date: _____

NAME OF THE AGENCY: _____ Work-Area/Package: _____

Sl. No.	Description	Remarks
1	<u>HOUSE KEEPING:</u>	
1.1	All working areas at site (specific to the agency) are free from garbage's, scraps & any other undesired non-plant materials. There is no encroachment in safe passage of man, material & T&P to carry out activities safely	
1.2	All the plant materials under the custody of the agency are stacked & stored properly.	
2	<u>GENERAL ILLUMINATION:</u>	
2.1	ALL the working areas at site & office of the agency including passages are having proper & sufficient illumination.	
3	<u>STATUTORY & REGULATORY REQUIREMENT:</u>	
3.1	Sufficient water for drinking & other purposes and sanitation in work area and labour colony are available.	
3.2	Periodical Medical check-up of workers & staff done regularly & report submitted to BHEL	
3.3	Regular EYE testing is done for Crane operators/Welders and data's are available with agency	
3.4	All the T&P, Cranes etc used by the agency are having proper T.Cs & Fitness certificate available from competent authority.	
4	<u>SAFETY COMPLIANCE:</u>	
4.1	Number of Tool box meetings between Safety officers, erection staff & workers of the agency held in this month with location mentioned	
4.2	All precautions & Safety measures including PPE compliances are taken before working at HEIGHT	
4.3	Permit for working at Height is taken & complied accordingly	
4.4	ELCB is used in Construction Power Supply source by the agency & Proper Distribution board and electrical cabling has been used by the agency and regularly checked by electrician & safety officer of the agency	
4.5	Unsafe areas barricaded properly & unsafe opening closed properly	
4.6	Proper Platforms & Hand-rails used In areas earmarked earlier	
4.7	Proper safety signage's, Slogans & Emergency contact phone numbers including FIRE contact nos. are made available by the agency in locations mentioned	
5	Whether any penalty imposed by BHEL towards non-compliance of above points.	

<u>VENDOR'S SIGNATURE</u>	
Erection Engineer	
HSE Officer	
Site-in-Charge	

<u>BHEL'S SIGNATURE</u>	
Erection Engineer	
HSE Officer	
Package-in-Charge	



ANNEXURE I

Activity-Specific Safety Precautions/ Controls

Rk

INDEX OF CONTENTS

S. No.	Description	Page No.
1.	General	2
2.	Work at height	2
2.1	Personnel fall protection system must include	3
2.2	Working Platform	4
2.3	Scaffolding	5
2.4	Ladder Safety	7
3.	Excavation & Civil Works	8
3.1	Excavation	8
3.2	Piling	9
3.3	Batching Plant Operation	9
3.4	Mobile Plant	10
3.5	Concrete Vibrators	11
3.6	Concrete Mixers	11
4.	Welding & Gas Cutting Safety (Hot Work)	11
5.	Lifting & Rigging Safety	13
5.1	Cranes & Hoisting Equipment	15
6.	Demolition Work	20
7.	T&Ps General	21
8.	Chemical Handling	21
9.	Electrical Safety	21
10.	Use Of Hand Tools And Power-Operated Tools	25
11.	Start Up, Commissioning And Testing:	27
12.	Fire Safety	27
13.	Painting	28
14.	Hazardous Energy" Control Procedure/ Lockout/Tagout (LOTO)	30
15.	Risk Assessment	37
16.	HSE Preparedness For Adverse Climates And Weather	38
16.1	Summer	38
16.2	Monsoon	39
16.3	Emergency Weather Conditions	41
16.4	Prevention Of Covid-19 At Project Site & Labor Colony	42
16.5	Noise Mitigation	44

General

The philosophy of hierarchy of controls as below shall be followed



Fig. 1.1

It shall be ensured that there are multiple protections against any accident/ incident. For example, for height work there shall be safe platforms and walkways, Safety Nets and Lifelines for hooking double lanyard Safety harness by workers.

Monitoring and modifying worker behavior shall be part of ensuring safety. All personnel should be competent and trained for the job

Brief Safety guidelines for various hazardous activities are indicated below, besides the mandatory requirements based on Hazard Identification studies, HSE Procedures, Operational Control Procedures, Work Permits, applicable Indian Standard Codes and other provisions detailed in this document. Constant supervision at all times to be maintained by Execution & Safety Team to ensure implementation of these provisions.

1. WORK AT HEIGHT:

- a. All work at height above 2 meter above ground level without complete platforms, handrails and other related fall protection shall require a work permit in the prescribed form. This shall require approval by the competent authority. The HSE officer of sub-contractors shall follow the checklist religiously by physically verifying the condition of the work area before recommending for approval.
- b. Prior to the start of work at elevation, the HSE Officer involved with the work must meet the work supervisor to review the scope of work, and must review all the possible fall hazards and effective safety responses. The evaluation / analysis must be documented and kept on file and on site by the HSE Officer.
- c. Whenever a fall hazard or other exposure exists for working at heights more than 2.0m/6ft, the nature and scope of work will be evaluated for conditions and environmental factors before selecting the appropriate fall protection system (active, passive or a combination of measures, as appropriate).
- d. All Engineering and Administrative Controls including barricading, safe platform, Safety Nets etc. shall be made available at work location. Under no circumstances, there shall be total reliance on PPEs only
- e. **Safety Nets**
 - i. Contractor shall maintain sufficient stock of Safety Nets for deployment
 - ii. Safety Nets as per IS: 11057:1984 should be used extensively for prevention / arrest men and materials falling from height.
 - iii. The safety nets shall be fire resistant, duly tested and shall be of ISI marked.

- iv. Safety Nets shall be deployed below all platforms where height work is envisaged. Duration of work, delay shall be no excuses for non-installation of Safety Net
- f. Reaching beyond barricaded area without lifeline support, moving with support of bracings, walking on beams without support, jumping from one level to another, throwing objects and taking shortcut must be discouraged.
- g. Monkey Ladder shall be fitted with cages. Rope ladder should be discouraged.
- h. In case of pipe-rack, persons should not walk on pipes and walk on platforms only.
- i. In case of roof work, walking ladder/ platform should be provided along with lifeline and/ or fall arrestor.
- j. For chimney or structure painting, both hanging platform and men should be anchored separately to a firm structure along with separate fall arrestor.
- k. The procedures for the safety response to identified fall hazards developed and rescue plans must be reviewed with all individuals exposed to the hazards.
- l. The HSE Officer must establish an inspection process of fall protection systems. Some equipment requires documented inspections by its manufacture on a regular schedule. Such equipment must have evidence of the inspection and re-certification process on it. This information must be reviewed before the equipment is actually used. Individuals must visually inspect the fall protection equipment before each use. Failure to complete this inspection process could result in serious injury or death.
- m. Immediately remove from service any fall protection equipment that is identified as defective, damaged, or has been subjected to an impact. Damaged fall protective equipment must be destroyed to prevent re-use and not be discarded into trash containers, as the worn or damaged equipment could be unintentionally re-used.
- n. Aerial lifting devices, excluding scissor lifts require the use of full body harnesses and lanyards in any elevated position.
- o. Where Height related works are applicable then rescue team (consist of 5- 10 person) shall be identified and trained for potential rescue.

1.1 Personnel fall protection system must include:

a. Safety Harness

All height workers must use Full Body Safety harness with double lanyards with shock absorber (only). The primary lanyard is never unhooked until the secondary lanyard is secure. The design of the working platform should be such that under no circumstances, worker should have both lanyards unhooked while at height.

b. Lanyard

- i. The type of work and the environment conditions determine lanyard and lifeline selection. If welding, chemical cleaning that may damage lanyards, connectors or lifelines, sandblasting, etc., either protect the components or use more appropriate type of system.
- ii. Lanyards and lifelines must incorporate, or be used with, an appropriate deceleration (shock absorbing) device. Deceleration devices include rope grabs, rip-stitch lanyards, specially woven lanyards, tearing, or deforming lanyards, automatic self-retracting lifelines and lanyards which dissipate or limit the energy imposed on the employee during fall arrest.
- iii. Once in use, the system's effectiveness is to be monitored. In some cases, a program for cleaning and maintaining the system may be necessary. Lanyard and lifelines must use locking snap hooks only and under

no circumstances must two lanyard snap hooks be connected.

c. Lifeline

All lifelines in general are to be made of min 12mm dia. steel rope (plastic coated) and tied to columns with 3 clamps at each end. Wherever columns are not available to tie the lifelines, the vertical posts as per the design below are to be provided after carrying out drop load test initially. A load of 240kg to be dropped off the mid-point of lifeline in this test.

d. Lifeline Post

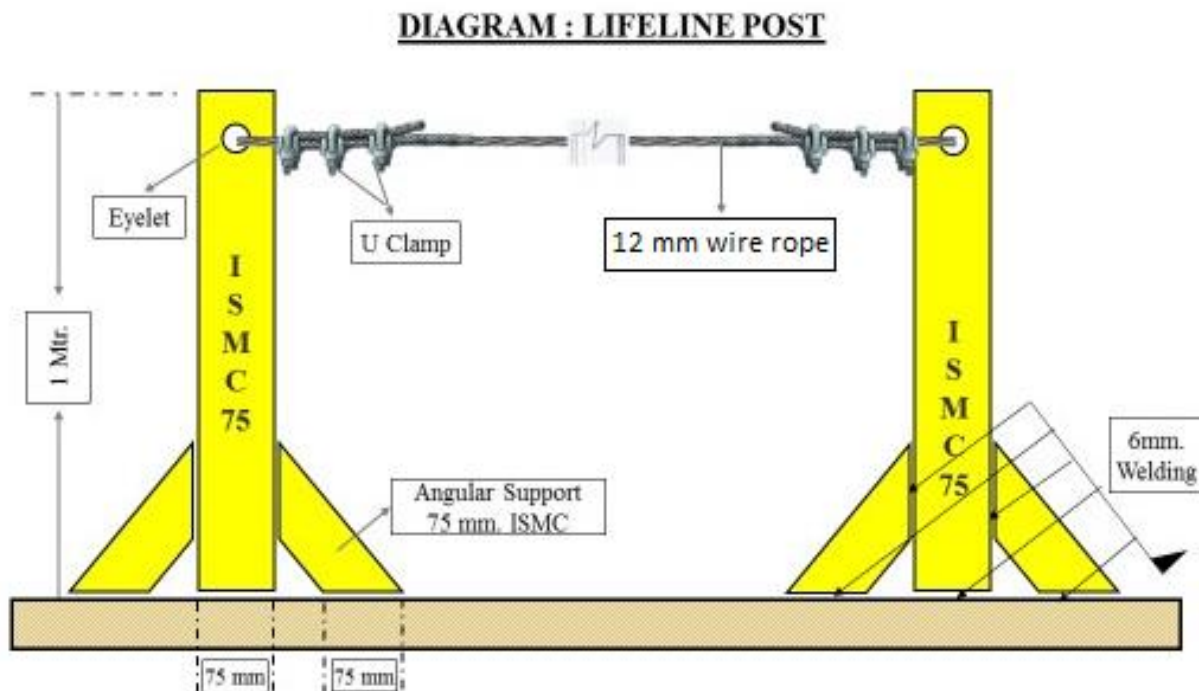

Fig. 2.1 Lifeline Post

- i. The support at vertical post shall be fixed at end-to-end (welded/ bolted). The maximum length of one end to another end shall be 6 meters
- ii. If the length of a lifeline is more than 6 meters, then intermediate vertical post(s) are to be used. Such intermediate post(s) will act as supports and the lifeline rope should simply pass through the eyelets (holes) of such supports without being anchored
- iii. The lifeline need not be wrapped / clamped to any intermediate post
- iv. Such intermediate posts must be used at an interval of every 6 meters
- v. The post(s) in which the original lifeline is to be installed should be capable of sustaining a tensile stress of 2268 Kgs.
- vi. In a horizontal lifeline installation, maximum allowable sagging is 500-600 mm
- vii. For a single spun lifeline, no more than 3(Three Nos.) persons are allowed to work; for more than two workers, another lifeline should be installed
- viii. Horizontal lifeline should be so installed that it does not impede safe movement of workers
- ix. All the installation work must be carried out by competent person with adequate knowledge

1.2 Working Platform

- a. Working platforms, gangways and stairways shall be so constructed that they do not sag unduly or unequally and if the height of the platform gangways provided is more than 3.6 m above ground level or

floor level, they shall be closely boarded and shall have adequate width, which shall not be less than 750 mm and be suitably fenced.

b. Precautions against the fall of Materials, Persons and Collapse of Structures:

- i. Every opening in the floor or a building or in a working platform shall be suitably barricaded to prevent the fall of persons by providing suitable fencing or railing whose minimum height shall be 90 cm.
- ii. Adequate precautions should be taken such as the provision of fencing, or barriers to protect any person who might be injured by the fall of materials, or tools or equipment being raised or lowered. Hard barricading shall be made at such places made of scaffolding pipe & clamps covered with reflective net. Cradle may be used for lifting materials - however this shall be made of MS angles and flats only and duly certified by the HSE officer. Operators may also use designed containers for lifting small tools.
- iii. Guardrails (including scaffolding) erected over/adjacent working areas must have the guardrails screened (opening < 0.5), to prevent material from falling outside the platform/decking.
- iv. Guardrails must be able to withstand a 200-pound force exerted in any one direction.
- v. Where necessary to prevent danger, guys, stays or supports should be used or other effective precautions should be taken to prevent the collapse of structures or parts of structures that are being erected, maintained, repaired, dismantled or demolished.
- vi. All openings through which workers are liable to fall should be kept effectively covered or fenced and indicated in the most appropriate manner.
- vii. Guardrails and toe-board/barricades and sound platform conforming to IS: 4912-1978 and other Indian laws and regulations as depicted below should be provided.

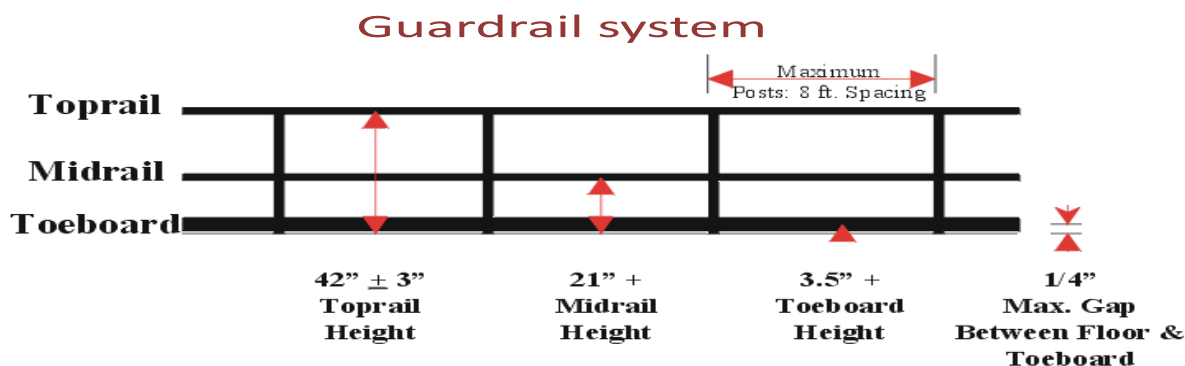

Fig. 2.2 Guard Rail System

- viii. Guardrails shall be provided to protect workers from falling from elevated work places. The rails are generally made of MS pipes of suitable dia. Rebar shall not be used for any handrails, ladder or cover purpose. Wherever the guard-rails and toe-boards cannot be provided:
 - a. adequate safety nets or safety sheets shall be erected and maintained; or
 - b. adequate safety harnesses shall be provided and used and / or
 - c. adequate fall arrestor shall be provided and used.

As mentioned under PPE clause, all these PPEs shall be defect free and regularly inspected for any defect.

The full body safety harness shall have double lanyard only with max 1.8m length.

- ix. The monkey ladders shall have sufficient fall arrestors. Adequate lifelines of 8mm steel wire rope shall be provided across the work area.
- x. The HSE officer shall recommend appropriate PPEs after analyzing hazards and risks involved.

1.3 Scaffolding

All scaffolds shall be conformant to the relevant standards including IS 3696 and IS 4014 as applicable. A sketch of the scaffolds proposed to be used shall be prepared and approval of the BHEL Engineer obtained prior to construction / use. Only cup lock type scaffoldings will be allowed in site. Where cup lock type scaffolding arrangement is not feasible by the virtue of the location, in that case only pipe and clamp type scaffolding will be allowed.

- a. The scaffolding work must be carried out by a competent person, who shall train the scaffold users on safety aspects
- b. All scaffolds shall be erected / dismantled by scaffolding crew under direct supervision of competent scaffolding supervisors.
- c. All scaffolds shall be capable of supporting 4 times maximum intended load and erected on sound, rigid footing, capable of carrying the maximum intended load without settling or displacement. Bamboo scaffolding is not permitted for use on site.
- d. Each employee on the scaffold shall use an approved safety harness attached to an independent lifeline. The lifeline is to be securely attached to substantial members of the structure (not the scaffold itself) or to securely rigged lines, which shall safely suspend a worker in event of a fall.
- e. Guard rails and toe boards shall be installed on all open sides and ends of platforms more than (2) meters above ground or floor
- f. Scaffold planks must be at least 5 cm x 25 cm (2" x 10") full thickness lumber scaffold grade or better.
- g. Scaffold planks shall not span distances greater than 2.5 meters (8 feet).
- h. Scaffold planks shall extend over end supports not less than 6 inches nor more than 12 inches and be secured to the scaffold. Scaffolding and accessories with defective parts shall be immediately repaired or replaced.
- i. All scaffolding must be a minimum of two planks wide. No one may work from a single plank.
- j. Scaffold planks must be inspected before use. Planks that have been damaged must be removed from the site.
- k. Access ladders must be provided for each scaffold. Climbing the end frames is prohibited unless the design incorporates an approved ladder.
- l. Adequate mudsills or other rigid footing capable of withstanding the maximum intended load must be provided.
- m. Scaffolds more the 6 meters (20 feet) in height must be tied to the building or structure at intervals which do not exceed 4 meters (13 feet) vertically and 6 meters (20 feet) horizontally.
- n. Do not overload scaffolds. Material should be brought up as needed. Scaffolding must not be loaded in excess of its rated capacity.
- o. Barrels, boxes, kegs, blocks or similar unstable object must never be used as work platforms or to support scaffold.
- p. Where persons must work under or pass under a scaffold then a 18 gauge wire mesh screen must be installed between the toe board and guard rail.
- q. Employees exposed to overhead hazards while working on a scaffold will be protected by 5 cm (2") thick planks.
- r. Wooden/bamboo ladders shall not be allowed at any cost. Ladder's rungs shall be fitted /welded

properly. Before every use the rungs should be checked for safe use.

- s. Wooden scaffolds shall not be used in areas where fire / fire products are expected
- t. Ropes made of jute / Plastic and other fire prone material shall not be used to tie up scaffolding components together
- u. The platform should have permanent hand rail and mid rail with Toe board without fail.
- v. All platforms are to be tightly planked for the full width of the scaffold, except as may be necessary for entrance openings. Platforms shall be secured in place.
- w. On suspension scaffolds designed for a working load of 500 pounds, no more than two workers are permitted to work on the scaffold simultaneously. On suspension scaffolds with a working load of 750 pounds, no more than three workers are permitted on the scaffold simultaneously.
- x. **Requirements for different types of Scaffolds:**

A. Suspended Scaffold

- i. Suspended scaffolds are platforms suspended by ropes, or other non-rigid means, from an overhead structure.
- ii. Requirements for use are to be preapproved by HSE Head, under a specific Permit to Work.

B. Rolling Scaffolds

- i. The height of rolling scaffolds shall not exceed three times the minimum base dimension.
- ii. The minimum base dimension of rolling scaffold will be 1.25 meters (4 feet).
- iii. Adequate help must be provided when moving a rolling scaffold.
- iv. Secure or remove all loose materials, equipment and tools before moving a rolling scaffold.
- v. No one is permitted to ride a rolling scaffold when it is being moved. Castor brakes must be locked-on when the scaffold is not being moved.

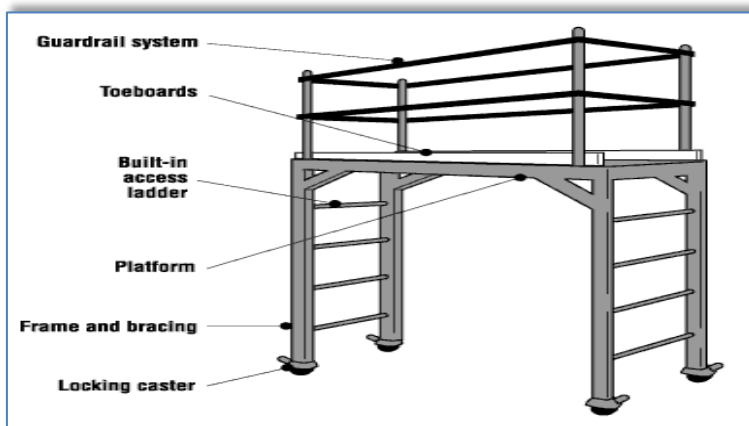

Rolling Scaffold

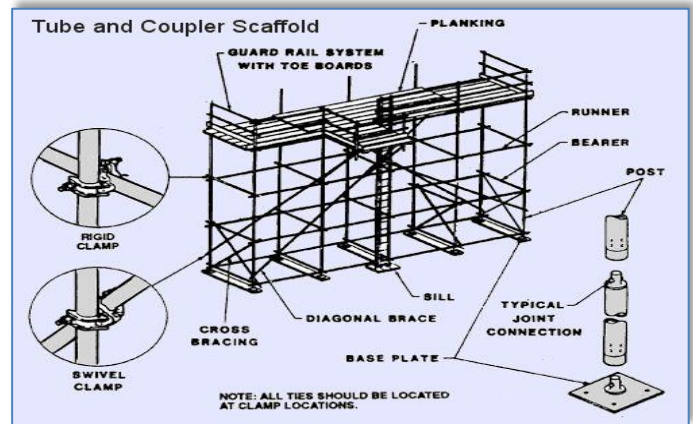

Tube & Coupler Scaffold

Fig. 2.3 Types of Scaffolds

1.4 Ladder Safety

A sketch of the ladders proposed to be used shall be prepared and approval of the BHEL Engineer obtained prior to construction / use

a. Safe Use of Ladders:

- i. Fall protection is required when working on a ladder above 2 meters and when climbing above nearby guardrails.

- ii. Ladders must be inspected prior to use and by a competent person quarterly, with documentation.
- iii. Use portable ladders for height up to 4 M only
- iv. Provide fixed ladders for height above 4 M
- v. Place the ladder at an angle of 75 degrees (approx.) from the horizontal (1:4)
- vi. Extend ladder at least 1 M above the top landing
- vii. Secure top and bottom of the ladder firmly to prevent displacement- anti skid lining at the bottom
- viii. Ensure that the width of the ladder is not less than 300 mm and distance between rungs is not more than 300 mm
- ix. Provide landings of minimum size 600 x 600 mm at intervals not more than 6 M for fixed ladders. Check the ladders daily for any defects
- x. Ensure that the areas around base and top of the ladder are clear. Getting on and off the ladder is more hazardous than using it. Use a mudsill if the ladder is to rest on soft, loose or rough soil
- xi. Do not use ladders of conducting material near power lines, and only use ladders near power line or other energize system with exposed parts if they are confirmed locked-out and de-energized.
- xii. Stand no higher than the fourth rung from the top for carrying out any job standing on a ladder.
- xiii. Never reach out from a ladder to perform work where your belt buckle protrudes past the ladder rung.
- xiv. Always face the ladder while climbing up or down
- xv. Maintain three-point contact while climbing up or down a ladder i.e. two hands and one foot or two feet and one hand on the ladder at all the times.
- xvi. Avoid climbing up or down a ladder while carrying anything in hands. Lift tools, equipment and materials with a rope.
- xvii. Work from portable and extension ladders near guardrail where fall expose exists over the guardrail regardless of height, and above 2.0 mtr. heights from the working/walking surface will require the use of personal fall arrest equipment

2. EXCAVATION & CIVIL WORKS

All safety precautions shall be taken for foundation and other excavation marks as per IS-3764.

2.1 Excavation

The following safety measures are to be ensured before and during excavation:

- a. All Excavation activities more than with depth of 1.22 meter or more shall require and Excavation Work Permit
- b. Check for underground utilities like electrical / telephone cables, sewage, water lines and proper care has to be exercised to protect and prevent damage to it.
- c. Electrical cables and service lines to be identified using cable detector/locator device before carrying out the excavation work
- d. Proper and adequate slope is maintained while excavating
- e. Adequate shoring or sheeting is done wherever require to prevent soil sliding
- f. Safe access through ladder or steps for exit & entry to excavation
- g. No material /excavated soil is kept within one meter from the edge
- h. Safe way is planned and provided for movement of HEM /transport equipment near excavation
- i. Safety helmet and shoes/gum boots are provided and worn by the workmen at excavation works

- j. Dewatering arrangement is made where water seepage is prevailed.
- k. Stop blocks are provided to avoid vehicles reversing into the excavated trenches
- l. Danger signs /Caution boards are displayed at work spot
- m. Hard Barricading is provided at excavated pits. It should be made of scaffolding pipe and clamp with reflective nets.
- n. All Excavated area of depth 3mtr or more is to be hard barricaded with pipe.

Soil Type	Height/Depth ratio	Slope Angle
Stable Rock	Vertical	90 deg.
Type A	¾ : 1	53 deg.
Type B	1 : 1	45 deg.
Type C	1½ : 1	34 deg.

Determining Soil Type		
Type	Description	Examples
A	Cohesive soils with an unconfined compressive strength of 1.5 tons per square foot or greater.	Clay, silty clay, sandy clay, clay loam and in some cases: silty clay loam and sandy clay loam.
B	Cohesive soils with unconfined compressive strength greater than 0.5 tsf but less than 1.5 tsf.	Angular gravel (similar to crushed rock), silt, silt loam, sandy loam and, in some cases silty clay loam and sandy clay loam.
C	Cohesive soils with unconfined compressive strength greater than 0.5 tsf or less.	Granular soils such as gravel, sand and loamy sand; submerged soil or soil from which water is freely seeping; submerged rock that is not stable.

Fig. 3.1 Excavation Reference

2.2 Piling

Ensure the following precautionary measures before starting piling works:

- a. Inspection of piling equipment by responsible person for its condition before initiating piling operation.
- b. Checklist and OCP for piling to be prepared using manufacturer's instructions and used
- c. Testing and its certification wire rope, slings, D-shackles, chain pulley blocks using in the process of piling work by competent person
- d. Adequate support and secured foundation of the piling equipment to avoid toppling
- e. Hoses should be lashed and adequately secured
- f. Proper work platform is to be provided on piling frame
- g. Safe work procedures and close supervision to prevent unsafe acts of operators/any unsafe conditions that may arise
- h. Only experienced and trained operators are engaged for the piling operation
- i. Provision of Personal Protective Equipment (PPE) like safety shoes/gumshoes/safety helmet/safety belt etc. and its use by their workmen.
- j. Special care and precautions If work is near electrical live cables/ electrical equipment
- k. Cordoning of work area to prevent un authorized entry
- l. Guarding of revolving parts
- m. Specific measures to prevent over turning of pile driver/missing of hammer/ hammer movement out of range

2.3 Batching Plant Operation

Following Safety considerations for batching plant are to be ensured:

1. Modern type batching plant should be used in which all the moving parts are protected and emergency

and safety features are incorporated.

2. Installation of external Electric moto-vibrators in the feeding hopper of all batching plants to reduce human intervention.
3. Installation of safety devices like pull-chord on both the sides of conveyor for stopping the conveyor in emergency
4. Workers carrying cement / sand to be given appropriate PPEs like respiratory masks & gloves.
5. Conveyor belt/rotating parts must be guarded properly.
6. Safety awareness shall be inculcated in workmen about the risk involved in rotating parts.
7. The agency shall ensure to erect the batching plant as per drawing including installation of all safety devices as provided by manufacturer and witnessed by BHEL Engineer in charge before starting of machine in future.
8. Safety audit to also focus on Batching plant.
9. The site shall impose penalty on the agency who has violated the safety norms as per contract.

2.4 Mobile Plant

Mobile plant includes tractors, trailers, dumpers, excavators, bulldozers, road rollers etc. for earthmoving purpose and concrete mixers, concrete transit mixtures, concrete pumps etc for concreting purpose. Due to the very nature of their function and movement in difficult terrains, congested areas, working in tandem with manual work and other operations the danger is inherent.

Automatic reverse camera with reverse horn connected with reverse gear is compulsory for all moving machineries.

Following Safety measures to be ensured for Mobile Plant:

- a. Where movement around site is involved, routes should be planned, obstruction free and well maintained
- b. Observe specified speed limits
- c. Operating personnel should be aware of associated risks and its preventive measures
- d. Only experienced, trained and authorized persons with valid license (wherever applicable) should operate the mobile equipment/vehicles
- e. Provide and use Warning lights and reverse horn for cautioning the people around
- f. Operation should be on level and stable ground with adequate working clearance.
- g. Loading of out riggers/stabilizers should be well within safe ground bearing capacity
- h. No person should be on equipment or vehicle during loading and unloading of material
- i. Operators should be protected by warning barriers or switching off power when working in close proximity of overhead power lines
- j. The equipment /vehicles should be well maintained and provided with effective brake system and other safety devices (wherever require)
- k. Rotating parts of equipment should be adequately guarded
- l. Provide necessary personal protective appliances and ensure its use by the operating personnel Ensure effective measures at source to control harmful emissions, dust, fumes contaminating atmosphere and cause health hazards to the operators and people in the vicinity.
- m. No overloading/over stressing of vehicles/plant is allowed
- n. Hoses, pipes, receivers, gauges and valves involved in carrying out hydraulic fluid/ compressed air should be checked for leaks and tested prior to operation.

- o. Adequate safe clearance for swing and movement is to be judged during operation of Concrete mixer
- p. Setting of machines on firm and level ground with wheel locked to prevent movement of machine
- q. Proper instructions and Special precautions are to be ensured to prevent entry in to the danger zone of projectile of bucket while dropping bucket
- r. Operator leaving work spot should ensure that the equipment/vehicle is kept in neutral position and place on firm and level ground.
- s. The hand brake should be kept in position and block road wheels as additional safety measure
- t. Blades/buckets should be kept low while moving
- u. The dozer blades should not be used as brakes except in emergency
- v. The ground should be examined for its bearing capacity and general safety especially when operating road roller at the edges of slopes, embankments.
- w. The roller should not be moved downhill with the engine out of gear
- x. If operating near excavations the following precautionary measures are to be ensured
- y. Barricading, edge protection to prevent fall of persons/vehicles over running while reversing etc.
- z. Suitable support system and adequate allowance to avoid the danger of side collapsing
- aa. Experienced signaler /attendant should be always accompanied with operator/driver for proper direction /signal and also to caution others in the working Zone during operation of mobile plant

2.5 Concrete Vibrators

- a. Revolving parts/belt drives should be adequately guarded and Vibrating unit shall be completely enclosed and have suitable overload relays and effectively earthed
- b. Ensure sufficient length of cable to the Vibrator.
- c. Ensure electric starters and other accessories are firmly fixed adequately supported
- d. Ensure locking of needle load while inserting needle in to the vibrator,
- e. Ensure periodical lubrication and maintenance

2.6 Concrete Mixers

- a. Setting of machines on firm and level ground with wheel locked to prevent movement of machine
- b. Proper instructions and Special precautions are to be ensured to prevent entry in to the danger zone of projectile of bucket while dropping bucket

3. WELDING & GAS CUTTING SAFETY (HOT WORK)

- a. All Hot Work shall require a Hot Work Permit
- b. Inbuilt Voltage Reduction Device (VRD) equipped arc welding machine will only be allowed for work.
- c. There shall be flash-back arrestors conforming to IS-11006 at both cylinder and burner ends. Damaged tube and regulators must be immediately replaced.
- d. All safety precautions shall be taken for welding and cutting operations as per IS-818.
- e. When possible, items to be welded, cut, heated, etc. shall be moved to a safe location free of combustible or flammable material. If this is not possible, then all combustibles/ flammables that can be removed from the area shall be removed within a 35-foot circumference and a positive means of confining arcs and sparks generated by the process shall be ensured and additional person(s) shall be stationed as fire-watch for the area(s) still exposed, along with obtaining the Hot Work Permit as applicable.
- f. Appropriate fire-fighting equipment is to be available in close proximity of any welding and gas cutting operations at all times suitable for the type of Fire.

- g. Drums, tanks, and similar containers that have contained flammable or toxic material shall not be welded, cut, or heated until they have been made safe by water filling, thorough cleansing or similar accepted practices. The container shall also be ventilated during the welding, cutting, or heating process.
- h. Proper ventilation is required for any welding or torch operations performed in a confined space.
- i. Any welding or gas cutting operations performed on metals of toxic compounds or coating such as zinc, stainless steel, lead, cadmium, chromium, and beryllium shall be properly ventilated and/or proper respiratory protection shall be worn by any person that could be exposed to fumes, vapors, and gasses created by the welding and gas cutting processes.
- j. Wherever it is practical, all arc welding operations shall be shielded to prevent direct light rays or sparks from contacting persons in the vicinity or from reaching areas normally used to travel through or into the vicinity. Where this is not practical, persons who shall be in the area are to use proper eye and skin protection. Other persons who are not participating in the welding or gas cutting operations are not to be allowed into the hazard zone.
- k. Welders and other employees who are exposed to arc welding radiation shall wear suitable clothing and protective apparel to prevent burns and other types of ultraviolet radiation damage to the skin.
- l. Arc welding machines shall be shut down when being moved or when they are not in continuous use. Electrode holders left unattended shall have electrodes removed and shall not be left where they might contact employees or conducting objects.
- m. Arc welding power supply cable shall be of proper rating and material, e.g. copper.
- n. Welders shall guard against allowing materials adjacent to or behind them to reflect radiation back toward them or towards others in the area. Reflected radiation can cause skin burns and eye flash burns.
- o. Valve caps shall be in place when cylinders are not in use. Valve caps shall never be used for lifting the cylinder vertically.
- p. Torches shall only be lit by approved strikers; never with matches, cigarette lighters, or hot-work.
- q. **Splatter / Slag Collector:**

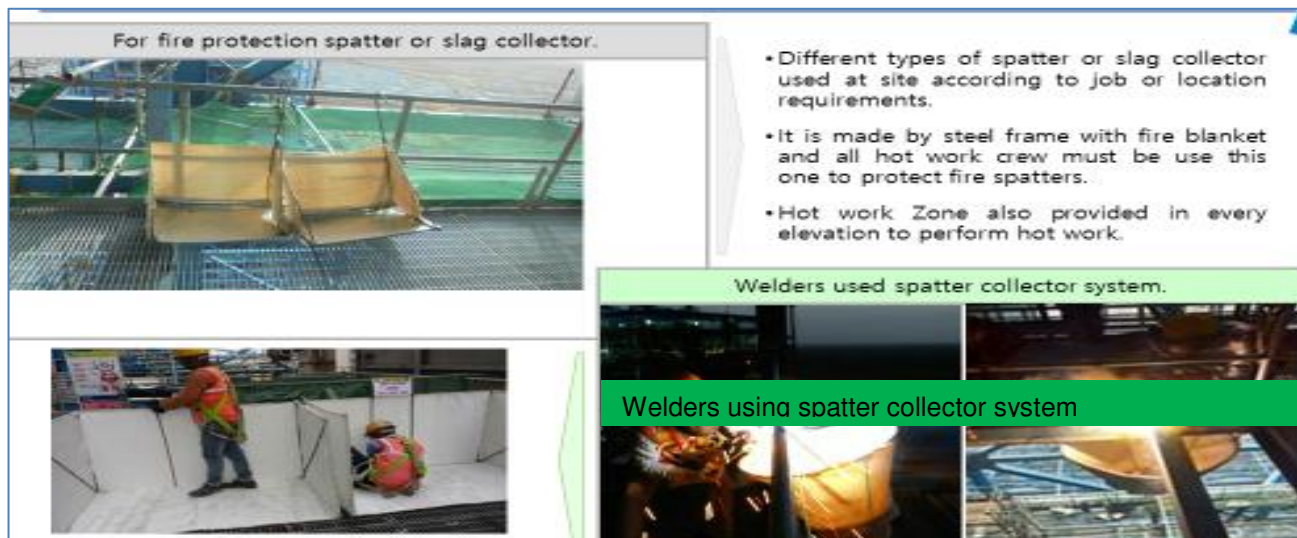

Fig. 4.1 Splatter / Slag Collector

While carrying out job at height, the sparks or molten slag shall be prevented from falling down by putting a fire-resistant (non-asbestos) sheet or pattrer/ slag collector or even MS Sheet. The passage of falling sparks

or molten slag shall be barricaded till ground floor and any cable/ tubes/ any other objects interfering in the passages shall either be removed or covered with Fire-resistant sheet or MS Sheet.

r. COMPRESSED GAS

- i. All cylinder valves shall be closed when any work is finished and when any Cylinders are empty or being moved. Valve protection caps shall be placed and secured properly before gas cylinders are transported, moved or stored.
- ii. Compressed gas cylinders shall be secured in an upright position with chain or appropriate means during storage & use. However, a trolley shall be used for transportation.
- iii. Compressed gas cylinders shall always be secured from tipping or falling, whether in use, in storage or in transit. The cylinders shall always be secured upright, except during times when actually being hoisted or carried.
- iv. When cylinders are transported by powered vehicle they shall be secured in a vertical position.
- v. Regulators shall be removed when cylinders are not in use or are in transit, unless the cylinder is firmly secured on a special carrier designed for this purpose.
- vi. Gas cylinders are not allowed to be used in man-basket when occupied.
- vii. Cylinders containing oxygen or fuel gasses shall not be taken into confined spaces.
- viii. Oxygen cylinders shall be stored a minimum of 6 meters from fuel gas cylinders or shall have an approved firewall between them.
- ix. All cylinders shall be kept at a safe distance from welding or cutting operations or shielded from arc/sparks / slag.
- x. All cylinders shall be placed where they cannot become part of the electrical circuit.
- xi. Oxygen and acetylene shall not be stored together. Oxygen must be separated from acetylene (or ANY fuel gas) or combustible material by at least 20ft or a barrier with a 30-minute fire resistance rating.
- xii. All Cylinders should be stored upright in a designated area with labels for the type of gas. All applicable precautions to be ensured during storage
- xiii. Oxygen and fuel gas regulators, hoses and associated equipment shall not be altered and shall be in proper working order while in use.
- xiv. Compressed air can be extremely dangerous if allowed to penetrate the skin. As such, the use of compressed air to clean off yourself or other workers shall be strictly prohibited.
- xv. All gas cylinders shall be stored in upright position. Suitable trolley shall be used for cylinder movement, the design of which shall be submitted to BHEL Engineer for approval.
- xvi. No of cylinders shall not exceed the specified quantity as per OCP
- xvii. Cylinders shall be moved by tilting and rolling them on their bottom edges. They shall not be intentionally dragged, struck or permitted to strike each other violently.
- xviii. All cylinder should be kept only in cylinder trolley.
- xix. Cylinder shall be transported in upright vertical position by suitable mean.

4. LIFTING & RIGGING SAFETY

- a. All Heavy / Complex Lifting operations as defined in Clause 6.12 shall require a Lifting Work Permit. A written rigging procedure and plan must be prepared for all individual heavy/ complex lifting operations.

- b. All the cranes and lifting tools & tackles shall be inspected on daily / weekly basis as well as monthly by expert as per applicable formats.
- c. In addition, inspection / certification as mandated by law shall be carried out wherein these shall be tested and certificates of fitness shall be obtained from 3rd party State Govt. approved competent agency before deploying at site and later periodically. BHEL shall be given advance intimation of any such inspections
- d. The last date of Third-Party Inspection and the next Due date shall be conspicuously displayed on all cranes. A copy of certificate shall be pasted on operator's cabin of all the lifting equipment.
- e. Specifically designed heavy steel plates lifting clamps shall be used for lifting heavy metal sheets. Manmade lifting clamp chapa shall not be used for lifting/shifting of plates.
- f. Following requirements shall be mandatorily followed, wherever applicable:
 - i. The manufacturer's instruction for maintenance shall also be followed. All safety measures shall be followed.
 - ii. All tools tackles, lifting appliances; material-handling equipment etc. used by the subcontractor shall be of safe design and construction.
 - iii. The operators, slingers and signalers shall be qualified as per IS 13367 (part-1):2003 "Safe use of cranes- code of practices".
 - iv. There shall be a person responsible for co-ordination among cranes where multiple cranes are used, and lifting over load chart of the crane to be avoided.
 - v. Mobile phone should be banned for crane operator and lifting operation. Only walkie talkie shall be allowed in rigging/Lifting purpose.
- g. Lifts/Movements between 5 Tons and 20 Tons:
 - i. Shall include a rigging plan, detailing schematic representation of the handling/lifting operations that must be included on the Method Statement.
 - ii. When performing similar lifts of identical items, only one rigging plan need be prepared, provided each of the lifts can be performed in accordance with the rigging plan.
- h. Lifts/Movements Less Than 5 Tons:
 - i. An equipment rigging plan is not required for lifts less than 5 tons, safety measures are covered in the JSA. This could change as per BHEL requirement

i. Personnel Lifts (Man-Basket / Jhoola):

The design of personnel man basket shall be submitted to BHEL Engineer for approval before use. Relevant permit (Height work & others as applicable) shall be completed prior to lifting any people, along with a rigging plan.

- i. A separate Lifeline / fall arrestor anchored to a fixed structure outside of Jhoola shall be provided for the workers inside the basket. All occupants of the basket shall have Safety Harnesses equipped with rope grabs, which are to be hooked to the vertical lifeline.
- ii. Man-basket shall be used where access through ladders or scaffolding is not feasible.
- iii. Man-baskets shall be designed and engineered by a manufacturer (job made man-baskets are not allowed, unless designed and tested by a certified engineer), and built robust with MS Angles and flats or plates or channels only.
- iv. Guard rails top and mid, must be in place and screened-in to avoid material from falling out of

- basket. The factor of safety shall be 200%.
- v. It shall have a door with double latches and shall open inside. Anchor points shall be identified within the man-basket.
 - vi. The man-basket shall be thoroughly inspected and load tested and a trial run performed without personnel before being put to job.
 - vii. It shall be treated as a lifting tool (T&P Item) and shall undergo same certification cycle and inspection as other lifting equipment.
 - viii. An additional sling of required lifting capacity shall be fixed the man-basket main lifting point and attached to the crane above the ball or block.
 - ix. While lifting man-basket, the crane shall maintain a uniform speed of lift without any swing.
 - x. Once man-basket reaches the destination, the lift brakes shall be locked as long as the basket
 - a. remains at that point. The same care shall be taken in its descent.
 - xi. As for hanging man-basket, the same shall be hung off a rigid structure with help U-shaped handle welded to man-basket. This shall be tested once in a year by a competent person.
 - xii. Use of Rebar steel for making and monkey-ladder must be avoided.

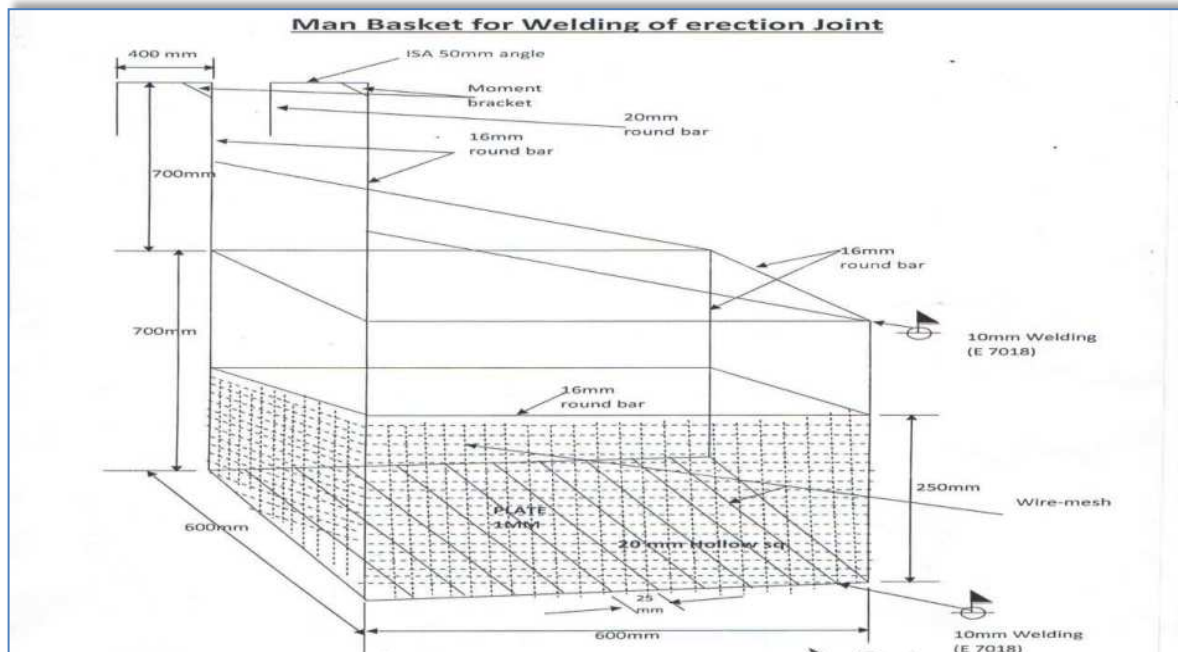

Fig. 5.1 Man Basket for Welding Erection Joint

4.1 Cranes & Hoisting Equipment:

This section provides the guidelines to ensure proper rigging and lifting activities are accomplished safely and in accordance with applicable specifications, codes, and regulations.

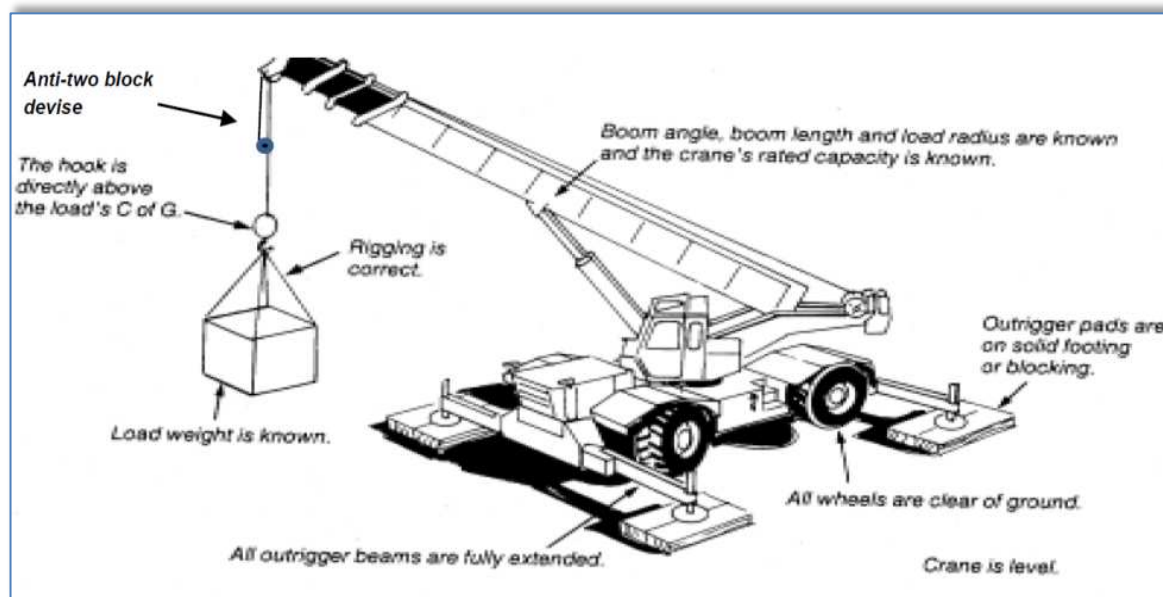

Fig. 5.2 Proper Crane Setup

- a. On every crane or piece of hoisting equipment notices of all rated load capacities, recommended operating speeds, and any hazard warnings or special instructions shall be conspicuously posted. All instructions and warning shall be visible from the equipment operator 's station.
- b. Cranes shall have an Anti-Two-block safety device installed
- c. All mobile cranes shall have overload and backup alarms, load angle indicators and limit switches
- d. All areas within swing radius of cranes that are potentially accessible by pedestrian, vehicular, or equipment movement shall be barricaded to prevent anyone or any vehicle or equipment from being struck by the crane or hoisting equipment, or its load(s).
- e. No part of the lifting equipment or its load shall be within the distance as specified in the Indian Electricity Act from an energized power line
- f. Cranes shall have annual certified third-party inspection and be inspected before use by the operator. Any defects shall be corrected before use. Logs of crane inspection shall be kept with the crane.
- g. Make certain that the rigging personnel, material, and equipment have the necessary capabilities for the job and are in safe condition.
- h. Communicate with person(s) directly responsible for accomplishing the work and / or work area to establish requirements/responsibilities and make certain that all preparatory work is complete.
- i. Mats/Pads must be used on all lifting equipment, equipped with out riggers.
- j. Pick and carry must have the load secured to the rig in front.
- k. Only BHEL Approved Plate Lifting Spreader Beam configuration shall be used (Sample in Fig. 11.3.5.3)
- l. Crane operators must follow the following:
 - i. Pass an annual Operator's Physical examination
 - ii. Carry a valid training certification card at all time while operating issued by the Govt. or other recognized institute.

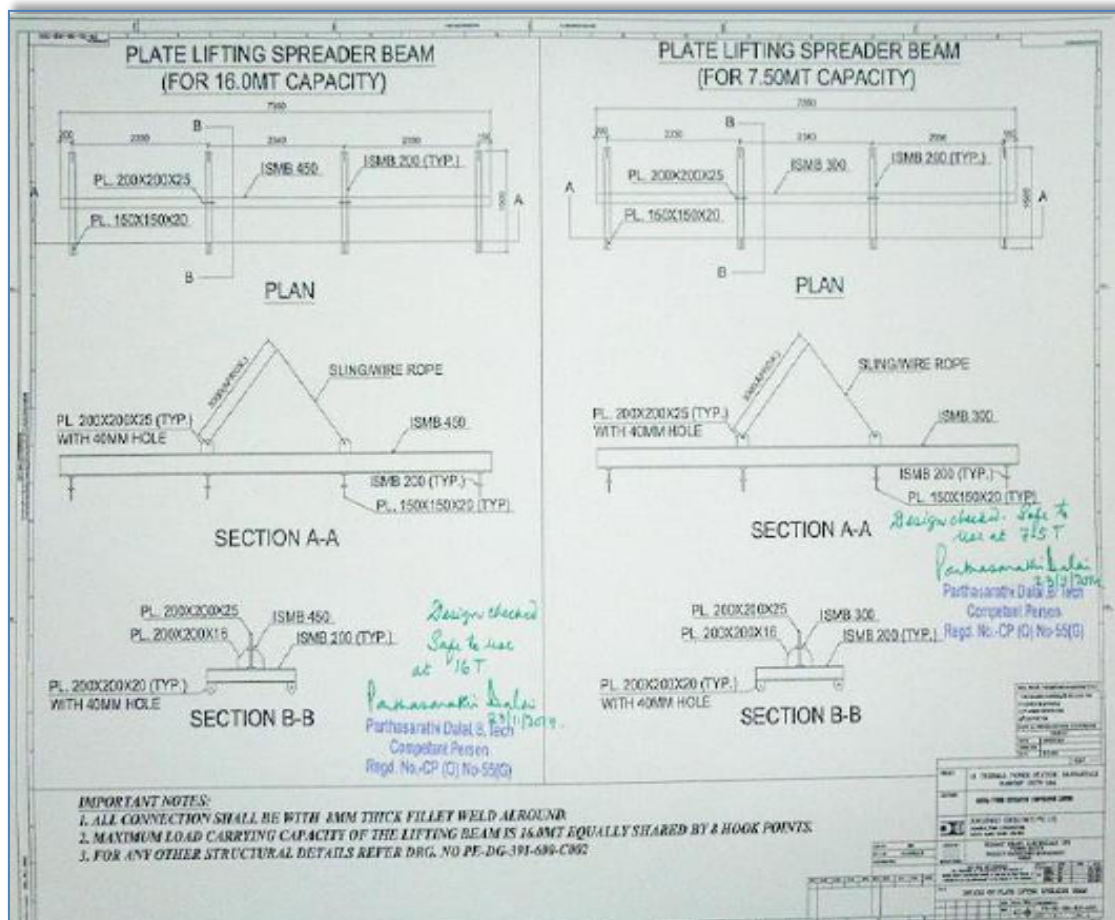

Fig. 5.3 Typical Plate Lifting Spreader Beam Configuration for 7.5 MT and 15 MT Loads

m. Safe Rigging Practices

- Review the planned operation and requirements with the operator and rigging crew.
- Ensure a pre-lift meeting is conducted with crane operator, tagline operator, signal personnel, and Safety Manager.
- Designate a qualified person from the rigging crew to observe clearance of the equipment and give timely warning for all operations where it is difficult for the operator to maintain the desired clearance by visual means.
- Clear the lift area of all unnecessary personnel.
- Hydras shall only be allowed for loading & unloading works & shall not be allowed to move with load

n. Rules for Safe Rigging

- Use loops, thimbles and corner pads to prevent damage to slings when used around corners or on cutting edges.
- Never allow wire rope to lie on the ground for any length of time or on rusty steel or near solvents, chemicals or corrosive substances.
- Slings must not be pulled from between or under loads with load resting on the sling.
- Keep all rope away from flame cutting or welding operations.
- Never use rope as sling material.
- Never wrap a wire rope completely around a hook.

- vii. Do not bend wire rope near any attached fitting.
- viii. The sling must be selected to suite the most heavily loaded leg rather than the total weight when using multi-legged sling to lift loads in which one end is heavier than the other.
- ix. When using 3 and 4-legged sling configurations, any two legs must be capable of supporting the entire load.
- x. Where possible, wire rope choker hitches must include a shackle with the eye around the shackle pin to prevent breaking wires of the choke. The choker hitch must be “snugged down” prior to lifting, not after tension is applied.
- xi. Unless authorized by the hook manufacturer when more than two rope eyes are placed over a hook, install a shackle, pin resting in the hook, and place the rope eyes in the bowl of the shackle.
- xii. Properly rig all loads to prevent dislodgment of any part.
- xiii. Use guide ropes or tag lines to prevent the rotation or uncontrolled motion of the load when necessary.
- xiv. Loads must be safely landed and properly blocked before being unhooked and unslung. Tag lines must not be used in situations that jeopardize the safety of the lift.
- xv. Lifting beams must be plainly marked with their weight and designed working load and must only be used in the manner for which they were designed.
- xvi. The hoist rope or chain must never be wrapped around the load. The load must be attached to the hook by slings or other rigging devices that are adequate for the load being lifted.
- xvii. Multiple part lines must not be twisted around each other.
- xviii. The hook must be brought over the center of gravity of load before the lift is started.
- xix. If there has been a slack rope condition, determine that the rope is properly seated on the drum and in the sheaves prior to lifting.
- xx. Keep hands away from pinch points as the slack is being taken up.
- xxi. Leather gloves are recommended when handling wire rope.
- xxii. Avoid impact loading caused by sudden jerking when lifting or lowering. Lift the load gradually until the slack is eliminated.
- xxiii. Never ride on a load that is suspended.
- xxiv. Avoid allowing the load to be carried over the heads of any personnel.
- xxv. Never work under a suspended load until the load has been adequately supported from the floor and all conditions have been approved by the supervisor in charge of the operation.
- xxvi. Never leave a load suspended unless emergency evacuation is required.
- xxvii. Never make temporary repairs to sling.
- xxviii. The capacity of a sling is determined by its angle, construction, type of hitch and size.
- xxix. Never lift loads with one leg of a multi-leg sling until the unused legs are made secure.
- xxx. Never point load a hook unless it is especially designed and rated for such use.
- xxxi. Make certain that the load is broken free before lifting and that all legs are taking the load.
- xxxii. When using two or more slings on a load make certain all slings are made from the same materials.
- xxxiii. Lower the loads on to adequate blocking to prevent damage to the slings.
- xxxiv. Materials and equipment being hoisted must be loaded and secured to prevent any movement which could create a hazard in transit.

- xxxv. The weight of the hook, load block and any material handling devices must be included when determining crane capacity.
- xxxvi. Calculated weights cannot exceed load chart without written approval.
- xxxvii. Personnel must be completely clear of loads being picked up or set down by crane. Tag lines will be used to control the loads. Loads must not be touched by hand while placing/ moving.

o. Slings

The following are rules for safe use of synthetic slings:

- i. Synthetic slings must be marked to show the rated capacity for each type of hitch and type of web material.
- ii. Nylon web slings must not be used where fumes, vapors, sprays or mists or liquids of acids or phenolic are present. Web slings with aluminum fittings must apply in this category.
- iii. **Synthetic web slings must be removed from service and destroyed if any of the following conditions are present:**
 - a. Acid or caustic burns
 - b. Melting or charring of any part of the sling surface
 - c. Snags, punctures, tears or cuts
 - d. Broken stitches
 - e. Distortion of fittings
 - f. Synthetic web slings of polyester or nylon must not be used at or come in contact with temperatures in excess of 82°C
 - g. Polypropylene web slings must not be used at or come in contact with temperatures in excess of 93°C
 - h. Insulated hooks must be tested yearly to ensure insulation integrity to at least manufacturer's specifications.

p. Wire Rope Slings must be removed from service and destroyed if any of the following conditions are present:

- i. In (10) randomly distributed wires broken in one (1) rope lay, or five (5) broken wires in one (1) strand in one (1) rope lay.
- ii. Wear or scraping of one-third the original diameter of outside wires.
- iii. Kinking, crushing, bird caging or any other damage resulting in distortion of the wire rope structure such as:
- iv. Evidence of heat damage.
- v. End attachments that are cracked, deformed worn.
- vi. Corrosion of the rope or end attachments.

q. Metal mesh slings must be immediately removed from service if any of the following conditions are present:

- i. A broken weld or broken brazed joint along the sling edge.
- ii. Reduction in wire diameter of 25 percent due to abrasion or 15 percent due to corrosion.
- iii. Lack of flexibility due to distortion or corrosion.

r. Requirements of Plate Clamps:

- i. The rated load of the plate clamp must be marked on the main structure.

- ii. Care must be taken to make certain the load is correctly distributed for the plate clamp being used.
- iii. Do not allow load or plate clamp to come into contact with any obstruction.
- iv. The plate clamp must not be used for side pulls or sliding the load.
- v. When lifting stainless steel or special alloys, ensure plate clamp is designed for use on the specific metal.

s. **Signaling Practices:**

- The "slinger" is responsible for attaching and detaching the load to and from the crane. He shall:
 - have received appropriate training on general safe lifting operations;
 - be capable of selecting lifting gears suitable for the loads;
 - liaise with the operator and direct the movement of the crane safely.
- The "signaller" is responsible for relaying the signal from the slinger to the crane operator. He shall:
 - have received appropriate training on general safe lifting operations;
 - be able to direct the movement of the crane and loads.

Suggested hand signals



Note: During the lifting operation, either the slinger or signaller shall communicate with the operator. Other communication methods (e.g., wireless walkie-talkies, telephones, etc.) may also be used.

Fig. 5.4 Recommended Signaling Practices

5. DEMOLITION WORK

Before any demolition work is commenced and also during the process of the work the following shall be ensured, besides using the Work Permit:

- a. All roads and open areas adjacent to the work site shall either be closed, suitably protected or restricted for movement
- b. No electric cable or apparatus which is liable to be a source of danger nor a cable or an apparatus used by the operator shall remain electrically charged.

- c. All practical steps shall be taken to prevent danger to persons employed from the risks of fire or explosion or flooding. No floor, roof or other part of the building shall be so overloaded with debris or materials as to render them unsafe.

6. T&PS GENERAL

- a. All T&Ps/ MMEs should be of reputed brand/appropriate quality & must have valid test /calibration certificates bearing endorsement from competent authority of BHEL.
- b. Subcontractor to also submit monthly reports of T&Ps deployed and validity test certificates to BHEL safety Officer as per the format/procedure of BHEL.
- c. Tagging and punching in all lifting tool is compulsory with SWL, sr. no. and due date.
- d. All T&Ps shall be inspected by authorized Third Party agency as per applicable frequency. BHEL shall be kept informed of any such scheduled inspection
- e. All T&Ps shall be internally inspected in each quarter and colour coded.

7. CHEMICAL HANDLING

- a. Displaying safe handling procedures & MSDS for all chemicals such as lube oil, acid, alkali, sealing compounds etc. at work place.
- b. Where it is necessary to provide and/or store petroleum products or petroleum mixture & explosives, the subcontractor shall be responsible for carrying out such provision / storage in accordance with the rules & regulations laid down in the relevant petroleum act, explosive act and petroleum and carbide of calcium manual, published by the chief inspector of explosives of India. All such storage shall have prior approval if necessary from the chief inspector of explosives or any other statutory authority. The subcontractor shall be responsible for obtaining the same.
- c. The used containers of chemicals shall be segregated and disposed of suitably
- d. In case the used containers need to be re-used, all traces of the chemical to be removed by thorough cleaning with detergents etc. under trained supervision

8. ELECTRICAL SAFETY

- a. Only electricians licensed by appropriate statutory authority shall be employed by the subcontractor to carry out all types of electrical works. The subcontractor shall maintain adequate number of qualified electricians to maintain his temporary electrical installations.
- b. No PDB or any other distribution board shall be more than 03 (three) years of purchase. Only modern PDB with industrial sockets as shown in layout below to be allowed to use at site.
- c. Power supply to all equipment at site to be routed through MCBs of appropriate rating. A 'Power Supply Distribution Plan' shall be prepared and submitted to BHEL Engineer for approval
- d. All power supplies through cables shall be underground or overhead with height > 3mtrs.
- e. All power distribution boxes shall be locked and the key controlled by site management of concerned subcontractor.
- f. All individual equipment & tools at site shall be powered through Earth Leakage Circuit Breakers of 30 mA sensitivity.
- g. These MCBs and ELCBs shall be regularly tested as per Clause 14
- h. All fuses and fuse wires shall be of standard size and rating.
- i. All electrical appliances used in the work shall be in good working condition and shall be properly double earthed other than armour earthing.

- j. All extension boards shall have separate switches for all sockets / connections.
- k. All portable electric tools used by the subcontractor shall have safe plugging system (industrial top & socket) to source of power and be appropriately earthed.
- l. Providing adequate no. of 24 V sources and ensure that no hand lamps are operating at voltage level above 24 Volts especially in confined spaces like inside water boxes, turbine casings, condensers etc.
- m. Electrical appliance shall have proper earthing and for appliances equal to & more than 415V shall have two separate earthing (as per IS-3043-1987)
- n. Portable Electric Lights**
 - i. Portable electric lights used in wet or potentially wet locations must be either low voltage type (24 volts or less) or protected by a GFI (ground fault interrupter).
 - ii. They must be visually checked before each use and periodically while in use to assure their original integrity is maintained.
 - iii. Cords with cuts, breaks, deep abrasions, etc. shall be taken out of service immediately.
 - iv. Repairs to extension cords shall only be performed by qualified/ licensed electricians.
 - v. Must not be allowed to lie in wet or potentially wet areas.
- o. Underground Cables:**
 - i. Every electric line or cable of unknown origin that is discovered or exposed during a digging, drilling, probing, or similar operation is to be considered as energized and life threatening.
 - ii. The senior company employee on the site will ensure that all necessary safety precautions are taken in order to isolate the line from all workers and the public.
 - iii. Such precautions may include halting the operation if appropriate.
 - iv. The senior company employee on the site is to then contact the proper authorities to have the line identified and either confirmed to be abandoned and/or made safe for continuing the work.
 - v. Any and all underground lines that are discovered or become severed must be considered energized on both sides, and be treated accordingly.
- p. Details of earth resource and their test date to be given to BHEL safety officer as per the prescribed formats of BHEL
- q. The subcontractor shall use only properly insulated and armoured cables and conform to the requirement of Indian Electricity Act and Rules for all wiring, electrical applications at site.
- r. BHEL reserves the right to replace any unsafe electrical installations, wiring, cabling etc. at the risk & cost of the subcontractor.
- s. No maintenance work shall be carried out on live equipment
- t. Adequate precautions shall be taken to prevent danger for electrical equipment. No materials on any of the sites of work shall be so stacked or placed as to cause danger or inconvenience to any person or the public
- u. The subcontractor shall carefully follow the safety requirement of BHEL/ the purchaser with the regard to voltages used in critical areas.
- v. Wiring and Branch Circuits Must be protected by a proper amperage over-current device such as a HRC fuse or circuit breaker. Such installations must be located so as to prevent physical damage to the wire conductors & panels.

w. The sub-contractor shall supply modern power distribution board of different combination (1-phase & 3-phase). All the distribution of power should be through modern PDB. Equipment drawing is mentioned below.

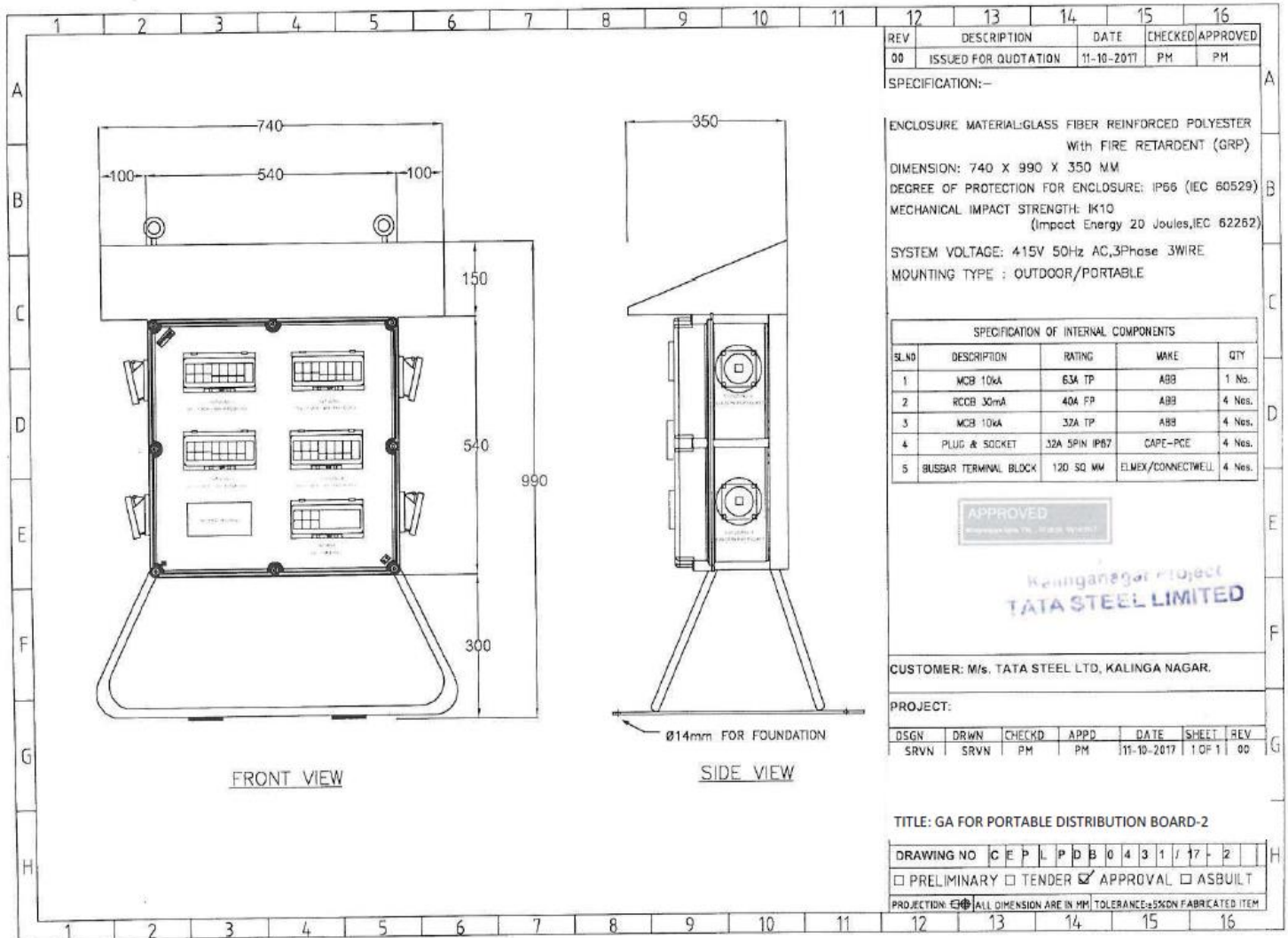

Fig. 9.1 Layout of a modern Power Distribution Board

x. General Electrical Safety

- i. In general, equipment or machinery being moved or transported must maintain minimum clearances of 25 ft. to all power lines.
- ii. TAG IN/ TAG OUT must be in force in Switch Room and all Distribution Boxes for live power line. The authorized person's name and contact no shall be displayed
- iii. Ensure "double insulated" three - core cables and three pin connectors are used and are properly ground "all insulated" types, all electrical tools and appliances must be manufactured for industrial use.
- iv. All connections shall be electrically and mechanically sound and properly insulated. Taped joints are not permitted. Connections to socket outlets must be made with proper plugs (industrial top and socket).
- v. Splices in electrical cords are not permitted. Repairs must be made at the socket connection and retain the same mechanical and dielectric condition of the original connection.

Rk

- vi. Damaged or defective electric tools, equipment and extension cords, etc. must not be used and shall be tagged out of service, removed from the work area and taken back to stores.
- vii. Only licensed electricians are authorized to repair and work on electrical equipment. Tampering with electric tools or equipment by others could result in termination.
- viii. Temporary electric cabling should be elevated 2.2 meters above the floor/ground or covered for protection. It must be kept clear of walkways and other locations where it may be exposed to damage or create a tripping hazard.
- ix. Energized wiring in junction boxes, circuit breaker panels and similar places must be covered and locked at all times.
- x. Areas with live high voltage wires or terminals must be barricaded against entry and warning signs posted Danger – High Voltage and Authorized Personnel Only.
- xi. Personnel should never work on energized equipment, de-energizing (lockout/tag out) the equipment is always the first requirement.
- xii. The lockout and tag out procedure will be used when testing or working on, or around, energized installation.
- xiii. Working around energized equipment should never be done alone. A second electrician must always be available for assistance.
- xiv. If lockout/tag out of the work is infeasible (must be demonstrated), work on energized electrical circuits must be approved by the Site In-charge. All safety precautions necessary must be taken, PPE use must be evaluated per the exposure and used, i.e high/low voltage gloves, insulated shoes, overcoats/aprons, face shields, and other protective equipment like insulated tools, blankets, mats, etc. must be used.
- xv. The welding machines earth leads shall be properly fixed without loose contacts. The earth cable only has to be used. No steel members shall be used as earth leads.
- xvi. Electrical crews must be qualified for the equipment and tools they work on, including being trained in Cardio-Pulmonary Resuscitation (CPR) methods and First Aid for rendering help in the event of electric shock.

y. Qualified Persons for Electrical Works

(One who is trained and wiremen licensed to Govt. of Respective State and familiar with the construction, operation and safety hazards of the equipment upon which they are permitted to work.)

- i. Qualified persons are intended to be only those who are well acquainted/experienced with and thoroughly conversant in the electric equipment and electrical hazards involved with work being performed.
- ii. Only qualified persons may be permitted to work on or near exposed energized parts. Such persons are required to have been trained in three specific areas:
- iii. Qualified persons must be capable of working safely on energized circuits;
- iv. Must be familiar with the proper use of special precautionary techniques and procedures bases on equipment and exposure; and
- v. Must be familiar with required personal protective equipment, insulating and shielding materials, and insulated tools.

- vi. Qualified persons are expected to be able to evaluate unknown situations and adjust their activities in such a way that only safe work practices are used. Such behavior is the responsibility of the qualified person.
- vii. It is possible and likely for an individual to be 'qualified' with regard to certain equipment in the work place, and unqualified on other equipment they must know their limitation and stop work if not qualified on what equipment they were to work on.
- viii. An employee who is undergoing on-the-job training, who, in the course of such training, has demonstrated an ability to perform duties safely at his or her level of training, and who is under the direct supervision of a qualified person is considered to be a qualified person for the performance of those duties. The process must be documented as proof.

z. Mandatory PPEs of electrical work on LV & HV

- i. HV arc flash suit with protective hood (for protection of face and head) as specified for hazard risk category-4 in NFPA-70E or similar IS specification for working on HT switch gear (for all voltage >690 V) to the concerned licensed electrician or competent person.
- ii. LV arc flash jacket/FR as specified for hazard risk category-4 in NFPA-70E or similar IS specification having ATPV rating of 8.5 to 9 cal/cm² for working on LV (>260V and ≤690V) to the concerned licensed electrician or competent person.



- iii. The LV arc flash jacket as shown above shall be worn continuously while working on LV (>260V and ≤690V). The color specification of LV arc flash jacket should be blue.
- iv. Electrical hand gloves should have following specification: Flame resistance, arc flash and cut protection of voltage rating (>260V and ≤690V).
- v. Electrical safety over shoe of relevant IS make for foot protection of licensed electrician or competent person while working in HV & LV line or equipment.

9. USE OF HAND TOOLS AND POWER-OPERATED TOOLS

a. General Provisions

- i. All hands and power tools and similar equipment, shall be maintained in safe condition.
- ii. When power operated tools are designed to accommodate guards, they shall be equipped
- iii. with such guards, when in use;
- iv. Belts, gears, shafts, pulleys, sprockets, spindles, drums, fly wheels, chains and other reciprocating, rotating or moving parts of the equipment shall be similarly guarded;
- v. Personnel using hand and power tools and exposed to the hazard of falling, flying, abrasive, and splashing objects, or exposed to harmful dusts, fumes, mists, vapors, or gases shall be provided with the particular personal protective equipment necessary to protect them from the hazards;

- vi. All hand-held powered platen sanders, grinders, grinders with wheels of 5 cm or less, routers, planers, laminate trimmers, nibblers, shears, scroll saws and jigsaws with blade shanks of 0.5 cm wide or less shall be equipped with only a positive on-off control.
- vii. All hand-held powered drills, tappers, fastener drivers, horizontal, vertical or angle grinders with wheels greater than 5 cm in diameter, disc sanders, belt sanders, reciprocating saws, saber saws and other operating powered tools shall be equipped with a momentary contact on control provided that turnoff can be accomplished by a single motion of the same finger or fingers that turn it on.

b. Hand Tools

- i. The subcontractor shall not issue or permit the use of unsafe hand tools;
- ii. Wrenches including adjustable pipe end and socket wrenches shall not be used when saws are sprung to the point that slippage occurs;
- iii. Impact tools such as drift pins, wedges and chisels shall be kept free of mushroomed heads;
- iv. The wooden handles of tools shall be kept free of splinters or cracks and shall be kept tight on the tools.

c. Power Operated Tools

- i. Electric power operated tools shall be either of the approved double-insulated type or shall be grounded;
- ii. The use of electric cords for hoisting or lowering loads shall not be permitted;
- iii. Pneumatic power tools shall be secured to the hose or whip by some positive means to prevent the tool from becoming incidentally disconnected;
- iv. Safety clips or retainers shall be securely installed or maintained on pneumatic impact (percussion) tools to prevent attachments from being incidentally expelled;
- v. All pneumatically riveting machine staplers and other similar equipment provided with automatic fastener feed, which operate at more than 7 kg/cm² pressure at the tool a safety device on the muzzle to prevent the tool from ejecting the fasteners unless the muzzle is in contact with the work surface;
- vi. Compressed air shall not be used for cleaning purposes except when the pressure is reduced to less than 2 kg/cm² and that too with effective chip guarding. The 2 kg/cm² pressure requirement does not apply to concrete form, mill scale and similar cleaning purposes;
- vii. The manufacturer's safe operating for hoses, pipes, valves, filters and other fittings shall not be exceeded;
- viii. Only personnel who has been trained in the operation of the particular tool shall be allowed to operate power-actuated tools;
- ix. The tool shall be tested each day before loading to see that the safety devices are in proper working condition. The method of testing shall be accordance with the manufacturer's recommended procedure;
- x. Any tool found not in proper working order, or that which develops a defect during use, shall be immediately removed from service and not used until properly repaired;
- xi. Tools shall not be loaded until just prior to the intended firing time. Neither loaded nor empty tools are to be pointed at any other person. Hands shall be kept clear of the open barrel end;
- xii. Loaded tools shall not be left unattended;
- xiii. Fasteners shall not be driven into very hard or brittle materials including, but not limited to, cast iron, glazed tiles, surface hardened steel, glass block, live rock, face brick or hollow tiles;

- xiv. Driving into materials that can be easily penetrated shall be avoided unless backed by a
- xv. substance that will prevent the pin or fastener from passing completely through and creating a flying missile hazard on the other side;
- xvi. No fastener shall be driven into a palled area caused by an unsatisfactory fastening;
- xvii. Only non-sparking tools shall be used in an explosive or flammable atmosphere;
- xviii. All tools shall be used with the correct shield, guard or attachment as recommended by the manufacturer.

d. Abrasive Wheels and Tools

- i. All grinding wheel must be ISO certified only.
- ii. All grinding machines shall be supplied with sufficient power to maintain the spindle speed at safe levels under all conditions of normal operation;
- iii. Grinding machines shall be equipped with suitable safety guards;
- iv. The maximum angular exposure of the grinding wheel periphery and sides shall not be more than 900, except that when the work requires contact with the wheel below the horizontal plane of the spindle, the angular exposure shall not exceed 1200. In either case, the exposure shall begin not more than 8.650 above the horizontal plane of the spindle. Safety guards shall be strong enough to withstand the bursting of the wheel;
- v. Floor and bench-mounted grinders shall be work-rests, which shall be rigidly supported and readily adjustable. Such work-rests shall be kept at a distance not to exceed 5 mm from the surface of the wheel;
- vi. Cup type wheels used for external grinding shall be protected by either revolving cup guard or a band type guard;
- vii. When safety guards are required, they shall be mounted as to maintain proper alignment with the wheel and the guard and the guard and its fastening shall be adequate strength to retain the fragments of the wheel in case of incidental breakage. The maximum angular exposure of the grinding wheel periphery and sides shall not exceed 1800;
- viii. Portable abrasive wheel used for internal grinding shall be provided with suitable safety flanges;
- ix. When safety flanges are required, they shall be used only with wheels designed to fit the flanges. Only safety flanges, of a type and design and properly assembled so as to ensure that the pieces of the wheel will be retained in case of incidental breakage, shall be used;
- x. All abrasive wheels shall be closely inspected and ring tested before mounting to ensure that they are free from cracks or defects;
- xi. Grinding wheels shall fit freely on the spindle and shall not be forced on. The spindle nut shall be tightened only enough to hold the wheel in place;
- xii. All employees using abrasive wheels shall be protected by suitable eye protection equipment.

e. Wood Working Tools

- i. All fixed power-driven woodworking tools shall be provided with a disconnect switch that can either be locked or tagged in the off-position;
- ii. The operating speed shall be attached or otherwise permanently marked on all circular saws over 0.5 m in diameter or operating at over 3000 peripheral rpm. Any saw so marked shall not be operated at a speed other than that marked on the blade. When a marked saw is re-tensioned for a different speed,

- the marking shall be corrected to show the new speed;
- iii. Automatic feeding devices shall be installed on machines wherever the nature of the work will permit. Feeder attachments shall have the feed rolls or other moving parts covered or guarded so as to protect the operator from hazardous points;
 - iv. All portable power-driven circular saws shall be equipped with guards above and below the base plate or shoe. The upper guard shall cover the saw to the depth of the teeth, except for the minimum arc required to permit the base to be tilted for bevel cuts. The lower guard shall cover the saw to the depth of the teeth, except for the minimum arc required to allow proper retraction and contact with the work. When the tool is withdrawn from the work, the lower guard shall automatically and instantly return to the covering position.

10. START UP, COMMISSIONING AND TESTING:

There are various activities involved prior to commissioning- the major ones are -Hydraulic Test, Steam Blowing, Transformers Charging, Boiler Light Up, Rolling and Synchronisation and Full loading of unit.

- a. These activities shall be personally supervised by the site executive along with the commissioning engineer.
- b. Appropriate Work Permits shall be taken as applicable
- c. The readiness of upstream and downstream system shall be ensured before taking up.
- d. These shall be handled strictly by the authorized persons only and the team shall be suitably briefed about the activity including hazards & risks involved and control plan by the concerned executive-in-charge before start.
- e. Entry of persons to the area of activity shall be suitably restricted and the emergency functions like Ambulance, first aid center and Fire station shall be intimated about the plan well in advance.
- f. Tag-in/ Tag-out shall be in place while charging transformer and whenever necessary.
- g. Electricians with valid wiremen license only shall be permitted to work on power lines.
- h. The area and the passage shall be adequately illuminated.

11. FIRE SAFETY

- a. The Fire Prevention, Protection and Preparedness Program is an integral part of the overall HSE Program. Effort and consideration must be given to safety, life and potential for delays in construction schedules and plant startup, as well as protection of property on a given project. The purpose of which is to prevent
 - i. Inception of fire
 - ii. Loss of life or personal injury
 - iii. Loss of Property
 - iv. Interruption of operations
- b. Site-in-charge / Safety Officer will make periodical review of the site Fire Protection, Prevention Preparedness Programme, Site conditions and available fire protection equipment. It is very imperative that the Sub-contractors along with BHEL to establish good contact with Local fire station for availability of Fire tender in case of emergencies, in addition to their own fire equipment.
- c. Fire Protection, Prevention and Preparedness Inspections - The Contractor /Sub-Contractor will be required to make frequent fire prevention inspections of his work site and operating facilities. Deficiencies will be corrected at once.
- d. Area where Hot work activities are carried out (Gas cutting / Welding/ any other spark producing work)

- above a working spot, a GI / fire-resistant non-asbestos sheet or suitable material shall be placed to prevent the fall of hot sparks. A bucket of water shall be kept nearby while doing hot work
- e. Hot work shall be preferably carried out in a designated area with a standing Hot Work Permit, to be renewed monthly. The designated area shall have fire extinguishers.
 - f. Any hot work outside designated area shall require a Hot Work permit and fire watch. No flammable material shall be stored within 35 feet from any fire load.

12. PAINTING:

- a. Requirements provide a detailed procedure to be implemented by all concerned employees and sub-contractors involved in painting activities.
- b. Significant Environmental Hazards:
 - i. Chemical hazard due to inhalation of lead fumes (lead containing paint)
 - ii. Chemical hazard due to inhalation of VOC's from painting operations
 - iii. VOC's from painting and coating operation
 - iv. Disposal of paints and coats drums
- c. Control Procedure for Painting:
 - i. Chemical products used in painting and coating operation shall have proper MSDS sheet in place. Whenever any doubt arises with respect to handling and safety point of view it should be accessed to all concerned.
 - ii. Toxic substances and hazards relate the toxic chemicals shall be identified.
 - iii. Proper PPE shall be used including plastic gloves appropriate overall etc.,
 - iv. Arrangement for cleaning of spillage shall be ensured
- d. Only trained workers shall be allowed and proper training should be imparted to the works.
- e. Exposure limits of the toxic substances shall be checked before starting the work and nobody shall be allowed to carry the work beyond the permissible limit.
- f. Ventilation or exhaust facility shall be provided at place where painting and coating operations are carried out.
- g. Overalls shall be supplied by the contractors/subcontractors to the workmen and adequate facilities shall be provided to enable the painters to wash at the cessation of work.
- h. Smoking, open flames or sources of ignition shall not be allowed in places where paints and other flammable substances are stored.
- i. A caution board in national /regional language "**smoking strictly prohibited**" shall be displayed in the vicinity.
- j. Suitable fire extinguishers/sand buckets shall be kept available at places where flammable paints are stored, handled or used.
- k. In case of indoor painting or painting in confined spaces, exhaust ventilating shall be provided. If adequate ventilation is not provided a proper respirator shall be provided and used by persons who are trained and fit tested.
- l. The VOC's from painting and coating operations shall not exceed the permissible level of CPCB/ SPCB norms. The paints and coats must be selected as per the guidelines.
- m. Workers shall thoroughly wash their hands and feet before leaving the work.

13. "HAZARDOUS ENERGY" CONTROL PROCEDURE/ LOCKOUT/TAGOUT (LOTO)

Hazardous Energy Control Procedures, known as "Lockout/Tagout (LOTO)" refers to specific practices and procedures to safeguard employees from the unexpected energization or startup of machinery and equipment, or the release of hazardous energy during service or maintenance activities.

Contractors must develop and submit a written LOTO program. This requires that a designated qualified individual turns off and disconnects the machinery or equipment from its energy source(s) before performing service or maintenance and that the authorized employee(s) either lock and tag the energy-isolating device(s) to prevent the release of hazardous energy and test the machine or equipment to verify that the energy has been isolated effectively.

a. Minimum Requirements:

The following are minimum requirements that must be included in the Contractor's LOTO program:

- i. Inspection of equipment by a trained individual who is thoroughly familiar with the equipment operation and associated hazards.
- ii. Identification and labeling of lockout devices. Purchase of locks, tags, and blocks. Development of a standard written operating procedure, permitted through a controlling authority that is followed by all workers.

b. General Requirements

The following steps must be taken to protect workers that install or service equipment and systems:

Follow the hazardous energy procedures and statutory regulations. Follow the manufacturer's service/repair instructions. Identify and label all sources of hazardous energy. Before beginning work, accomplish the following:

- i. De-energize all sources of hazardous energy:
- ii. Disconnect or shut down engines or motors.
- iii. De-energize electrical circuits.
- iv. Block fluid (gas or liquid) flow in hydraulic or pneumatic systems.
- v. Block or secure machine parts against motion.
- vi. Block or dissipate stored energy.
- vii. Discharge capacitors.
- viii. Release or block springs that are under compression or tension.
- ix. Vent fluids from pressure vessels, tanks, or accumulators—but never vent toxic, flammable, or explosive substances directly into the atmosphere.
- c. Lockout and tag out all forms of hazardous energy including electrical breaker panels, control valves, etc. Make sure that only one key exists for each of your assigned locks and that access to the key is controlled. Verify by test and/or observation that all energy sources are de-energized.
- d. After completion of the work, accomplish the following:
 - i. Inspect repair work before removing the lock and activating the equipment.
 - ii. Make sure that only the worker that installed the lock removes his/her assigned lock.
 - iii. Make sure that all workers are clear of danger points before re-energizing the system.

e. LOTO Procedure**PURPOSE AND SUMMARY**

This procedure provides the requirements and responsibilities of Hazardous Energy Control and the process for Lockout / Tag out (LOTO) of energy isolating devices (valves, circuit breakers, disconnect, etc.). Its use

shall ensure that machinery, equipment, or systems are isolated from all potentially hazardous energy to prevent unexpected energization, startup, or release of stored energy which may cause personnel injury or property damage.

This procedure applies to all BHEL personnel and subcontractors working on the WBPDC (1X660MW) STAGE-III projects where equipment must be taken out of service for the performance of work activities such as installation, maintenance, repair, construction, or equipment removal. The procedure may also be used to isolate equipment of which the energization or operation may present danger to personnel or property.

Lockout / tag out are not required for electrical equipment that can be unplugged from the source and the person performing the work has control of the plug.

This procedure shall be applied to prevent injury or damage caused by the unexpected release of active or stored energy. Hazardous energy sources could be in the form of the following:

- Electrical
- Hydraulic
- Chemical
- Thermal
- Mechanical
- Pneumatic

Preplanning of work activities includes the identification of all potential hazardous energy sources so that they may be properly controlled and isolated, locked, and tagged out.

Prior to initiating work activities on or around locked out / tagged out equipment, the equipment must be tested and tried by or in the presence of the person(s) performing the work activities.

RESPONSIBILITIES

- The Engineers in Charge is responsible for implementing and enforcing this procedure and approving lockouts /tag outs that impact the operation of the project.
- The Engineer in Charges responsible for authorizing Lockout /Tag out Requests.
- The Lockout / Tag out Coordinator is responsible for maintaining the Lockout / Tag out Log. Each shift should have a designated Lockout / Tag out Coordinator.
- The Isolator is responsible for determining the proper isolation devices and device positions required to isolate all potential energy sources so that the work stated on the Lockout /Tag out Request Permit may be safely performed. The Isolator must be familiar with the equipment and energy type(s) that require isolation. For this reason, in some cases the Isolator may be more than one person (i.e. Engineer, System Operator and/or Electrician). The Isolator shall position the specified device points, and apply locks and tags, and sign the tags and the LOTO Permit isolation point blocks.
- The Safety Manager is responsible for conducting an annual audit that is documented to ensure all procedures and requirements are current and being followed as written.

DEFINITIONS

Affected Employee: -

An employee whose job requires him/her to operate or use machinery or equipment on which servicing or maintenance is being performed under a lock out/tag out procedure or whose job requires him/her to work in an area in which servicing or maintenance is being performed under a lockout/tag out procedure

Authorized Employee: -

An employee who implements a lockout/tag out procedure on machinery, equipment, or systems in order that servicing or maintenance may be performed. Often an authorized employee and an affected employee may be the same person.

Danger “Do Not Operate” Tag

A tag used to identify energy isolation devices and specify the required position of the device. The tag should be affixed to the isolation device such that it is in plain view of anyone attempting to operate the device. The tags shall be sequentially numbered and shall specify the lockout/ tag out request number. The tag shall also state the purpose, and the expected duration of the lockout /tag out

Isolation Device

A device that is designed and intended to prevent the passage of energy. These devices, usually located at the energy source, are typically valves, circuit breakers, etc. Isolation devices should have a means of being locked in position

Lockout Device

A device that uses a positive physical means such as a lock, either key or combination type to maintain an energy isolation device in the safe position and prevent the inadvertent energization of machinery, equipment, or systems. Device locks should serve no other purpose other than hazardous energy control isolation

Lockout Tag out Request Permit

A pre-numbered form used to request that machinery, equipment or systems be taken out of service. A Lockout/Tagout Request Permit may be initiated by any one requiring energy isolation for work activities or for taking faulty equipment out of service

Lockout / Tag out Request Log

A record of all Lockout /Tag out Request Permits shall be maintained by the Lockout /Tag out Coordinator.

PROCEDURE**1. REQUESTING A LOCKOUT / TAGOUT PERMIT**

When machinery, equipment, or systems are partially or completely taken out of service for work activities or equipment protection, a lockout / tag out shall be requested. The requestor shall be familiar with scope of work required and shall provide a brief description of the work on the Lockout / Tag out Request Permit. The requestor shall also provide the proposed start time and estimated duration of lockout / tag out. If familiar with the machinery, equipment, or system to be taken out of service, the requestor may identify the devices that are required to be isolated. The LOTO Request Permit shall be forwarded to the Authorized Lockout / Tag out Coordinator for reviewed and signature, along with Permit to Work number to be entered on the LOTO Request Permit.

- a. The Lockout / Tag out Coordinator shall record the necessary information on the Lockout / Tag out Request Log and forward the request to the Engineer in Charge for approval.
- b. The Safety Manager or Engineer in Charge shall review the Lockout / Tagout Request Permit for impact on project operations. Project operations could be impacted by the equipment being taken out of service or by the required isolation to take the equipment out of service. If project operations are impacted by the Lockout / Tagout, the request shall be forwarded to the Engineer in Charge for approval.
- c. The Engineer in Charge shall provide the lockout / tag out isolation points necessary to perform the task stated on the request. The device identification, device location, device position, and locking mechanism

shall be entered into the appropriate blocks on the Lockout / Tag out Request Permit.

- d. The Engineer in Charge indicates approval of the Lockout / Tagout Request Permit by signing in the appropriate space on the request. If the Lockout /Tag out Request Permit is rejected, the Engineer in Charge shall return it to the requestor, via the Lockout / Tagout Coordinator with a written explanation of the rejection.
- e. Once approved, the Lockout / Tag out Request Permit shall be forwarded to the Lockout / Tag out Coordinator to assign tags and locks.
- f. The log shall show current status of all Lockout / Tag out Request Permits from submittal to approval, through lifting of locks and tags to final closeout. The log shall be maintained by the Lockout / Tag out Coordinator in their office.

2. PLACEMENT OF LOCKS AND TAGS

- a. The tags shall be filled out to match the information on the LOTO Request Permit. Appropriate locks for the types of isolation devices specified shall be collected and placed with the tags and the Lockout / Tag out Request Permit.
- b. The isolator(s) shall take the device locks, tags, and the Lockout / Tagout Request Permit to position the specified isolation devices, sign and hang the tags, and place the locks. If the isolator does not agree with or understand the Lockout / Tagout Request Permit, or has a problem performing the isolation, the problem should be brought to the attention of the Safety Representative or Area Supervisor immediately and the lockout / tag out should be postponed until the situation is resolved.
- c. Once the Isolator has placed all “locks” on isolation points, they will “test ”and “try” the machinery, equipment, or system to ensure all hazardous energy has been completely removed and the isolation is one totally accomplished, and has initialed and signed the Lockout /Tag out Request Permit indicating all isolation points have been confirmed. Examples of “lock”, “test” and “try”:
 - by checking that all locks on the LOTO Request Permit have been applied and are in the specified position open/closed, on/off, etc.; metering test of electrical circuits, opening of drain valves, checking pressure gauges or indicators; and try by pushing start buttons and on/off switches, etc.
 - Testing shall be performed by person(s) knowledgeable of the energy source(s) being isolated (e.g., an electrician should meter electrical circuits).
- d. A copy of the completed Lockout /Tag out Request Permit shall remain with the Work Package and used as part of the daily Pre-Job Briefings

3. WORKING UNDER A LOCKOUT / TAGOUT REQUEST

- a. Prior to starting the work activity, the person(s) performing the work shall review the Lockout / Tag out Request Permit and place the necessary tags and personal locks on the identified isolation devices. Personal locks may be placed only on devices that have already been locked and tagged in accordance with the Lockout / Tag out Request Permit.
 - All personal locks shall be accompanied by a tag that is signed and dated by the worker(s) and specifies the work activity being performed.
 - Personal locks should be of a different color than device locks for ready identification.
- b. Verification of the effectiveness of the isolation by the Isolator shall be performed for Worker’s working under the lockout / tag out, by demonstrating the checks on “lock”, “test” and “try”,
- c. When the work activity is finished, personal locks and tags shall be removed and the Safety Representative

shall be notified that the Lockout / Tagout is no longer required. If work under a lockout / tag out is to be delayed or interrupted for a period in excess of 24 hours, personal locks shall be removed until the work restarts. Personal locks shall be removed prior to the worker(s) leaving the project at the end of shift unless the key(s) are maintained at the project.

4. REMOVAL OF LOCKS AND TAGS

- a. When the lockout / tag out is no longer required, the Safety Representative or Area Supervisor shall obtain the Lockout / Tagout Request Permit from the work package for LOTO removal. Prior to removing locks or tags that may allow equipment to be energized, a check shall be made to verify that the equipment is free to safely operate (i.e., will not cause damage or injury). The locks and tags shall be removed and returned to the Lockout / Tagout Coordinator. Isolation devices may be repositioned at the discretion of the Engineer in Charge according to operational requirements. The Isolator shall complete the Lockout / Tagout Request Permit indicating each lock and tag has been removed and the Safety Representative or Area Supervisor forward to the Lockout / Tagout Coordinator.
- b. The Lockout / Tagout Coordinator shall discard the tags and maintain the completed Lockout / Tagout Request Permit for future reference.
- c. In the event that an employee leaves the job site without removing the personal lock I tag, the following measures shall be taken and documented. The measures listed below are a minimum set of guidelines and under all circumstances, refer to the site-specific safe work plan for detailed procedures:
 - Attempt calling / contacting the employee to return to the site for removal.
 - In the event an employee cannot be contacted, the Site Manager and Safety Manager shall sign an Emergency Lockout/Tagout Removal Form, which has been completed by the Area Supervisor.
 - Employee shall be notified upon returning to the site, prior to beginning any work.

5. INTERRUPTION OF A LOCKOUT / TAGOUT

Operational Emergency

The Engineer in Charge / Safety Manager /Area Supervisor may deem it necessary to temporarily remove the locks and tags from isolation devices, prior to the end of the work activity. The standard procedure for removal of locks and tags shall be followed. Extreme caution shall be taken by the Isolator removing the locks and tags to prevent personnel injury.

Testing

When the performance of a work activity requires the functional testing of a machine, component, or system, the locks and tags may be temporarily removed in accordance with the tag removal, to perform the test. As a result of the testing, if it is determined that the equipment needs further work, the locks and tags shall be positioned back on to the device. If it is not necessary to replace all the locks and tags, then the unnecessary locks and tags may be returned to the Lockout / Tagout Coordinator. The Engineer in Charge shall initial the Lockout / Tag out Request Permit in the removal block to indicate that these locks and tags have been removed. When testing has been satisfactorily completed, the locks and tags shall be removed.

ISOLATION DEVICES

- In most industrial applications, there are isolation devices that were not designed to accommodate a locking device. In these instances, an acceptable alternative that physically obstructs or prevents the use of the isolation device shall be found. Chains shall be placed on valves or electrical panels. Wires shall be determinate, pulled back, taped, and secured.

- If an isolation device does not accept a lock, a tag only is acceptable; however, all possible precautions shall be undertaken to provide a level of safety for the workers. The tag shall be readily visible to anyone attempting to operate the device.
- If more than one Lockout / Tagout Request Permit requires that a single isolation device be locked and tagged, a lock and tag for each request shall be placed. Each lock in itself prevents the inadvertent operation of the device.

GROUP / COMPLEX LOCKOUT

In a multiple lockout / tag out procedure, each person working on the machinery or equipment must place a lock or tag on the energy isolating device. If the energy isolating device will not accept multiple locks or tags, a hasp (a multiple lockout device, may be used. The locks or tags must be placed in such a way that energy cannot be restored to the machinery or equipment until every lock or tag is removed. As each employee involved no longer needs to maintain lockout / tag out protection that employee removes his - her lock and/or tag. The employee attaching the lock or tag is the only person authorized to remove the lock or tag.

6. TRAINING

The training must include recognition of hazardous energy source, type and magnitude of energy available, methods and means necessary for energy isolation and control. Each authorized employee shall receive adequate training. The training should address that all affected employees are instructed in the purpose and use of the energy control procedure. There should be training provisions included for any other employee whose work operations are or may be in an area where energy control procedures may be utilized. The employee training should also address when tag out systems are used including the limitations of a tag (tags are warning devices and do not provide physical restraint). The training should also include that a tag is not to be removed without authorization. The tag is never to be ignored or defeated in any way. Retraining is required when there is a change in job assignments, in machines, a change in the energy control procedures, or a new hazard is introduced. All training and I or retraining must be documented with employee's name and dates of training.

7. PROGRAM REVIEW

The lockout / tag out program must be reviewed at least annually. The review must ensure that procedures are being followed and that they are effective. A documented review of the inspection must include the date, the equipment, employees involved & the inspector. The inspector must be someone other than those actually using the lockout / tag out in progress.

ATTACHMENTS

#1. Danger (DO NOT OPERATE) Tags



#2. Device & Personal Locks and Multi Lock Hasp:



#3. Lockout / Tagout Request Permit

		LOCKOUT / TAGOUT REQUEST PERMIT			LOTO Request Permit No.:		
					Work Permit No.:		
Equip. Out of Service:		LOTO Date Required by: _____/_____/_____		Estimated Duration:		LOTO Requested Date:	
Scope of Work:				LOTO Authorization			
				Signed by:			
				Date:			
				LOTO Removal Authorization			
				Signed by:			
				Date:		Time:	
Tag No.	Device to be Tagged / Locked I.D. No.	Device Location	Device Position OPEN / CLOSE D -	Lock No.	Tag/Lock Placed by Print/Sign - Date/Time	Tag /Lock Removed by Print/Sign - Date/Time	
Comments Instructions: Attachment 3.Lockout / Tag out Request Permit:							

#4. Lockout / Tag out Request Log

LOTO Permit No.	Request or Name	Equipment & Location	Est. Work Completed Date	Approval Date	LOTO Placed Date	LOTO Removed Date	Comments

14. RISK ASSESSMENT

Risk and Hazard Analysis

In order to produce an overall Project EHS Plan, a project must be assessed for its risks. There are two components to the risk and hazard analysis. The procedure used to examine and plan for the identified risks and hazards is called a General Hazard and Risk Assessment.

JSA/HIRA review

Prior to commence the following activities Method statement and JSA/HIRA to be prepared by the concern engineer in coordination with EHS officer and submit to the client for review and approval. After getting approval the work will be started under PTW after clearance. For HIRA and criteria for the defining the high, medium & low risk the relevant annexure be referred. In case any deviations required in the approved method statement the concerned engineer/supervisor has to prepare additional HIRA/JSA to cover the new activities and associated risk. Following activities to be covered,

- Deep excavation (more than 5 feet)
- Significant concrete pouring (like heavy foundation, TG deck, Slab casting etc.)
- Confined entry
- Blasting
- Working on electrical/ energized equipment's
- Steel erection more than 5-Ton weight
- Working at height prior to completion of stairs/ladders/hand railing etc.

Definition:

HAZARD - Any potential or present danger to persons or property within the project site, e.g., oil on the floor is a hazard.

INCIDENT - An unintended happening that may result in injury, loss or damage, e.g., Slipping on the oil is an Incident.

INJURY – Physical harm, the result of an Incident, e.g., a sprained wrist from the fall would be an injury.

Hazard Analysis Document

- For high risk and dangerous work identified, the Applicant shall complete and submit a Hazard Analysis Document together with the PTW request. It will be a JSA (Job Safety Analysis) or Preliminary Hazard Analysis Checklist. And it shall be reviewed and approved by respective Construction and HSE Representatives.
- Issues such as work interface, coordination, drawings, toolbox meetings and work type/duration shall be detailed and included with supporting documentation for the Applicant's request for PTW.
- If applicable, Hazard Analysis Document shall be used as the foundation for development of Safe Work Method Statement. Each hazard identified shall be addressed in the Safe Work Method Statement and be submitted as part of the Applicant's submittal package.

Evaluation of Sub-contractor Risk Assessments includes

- Experience and expertise in performing similar type work.
- Duration of work performed
- Location of the work to be performed.

- Nature of the work to be performed.
- Potential for a subcontractor performing the work to expose themselves, other persons or employees, to hazards.
- Potential for exposure to work site hazards.

Review of Subcontractor specific issues

Preventive and protective measures must be introduced according to the following order of priority

- Eliminating the hazard by removing the activity from the work process. Examples include substitution with less hazardous chemicals, using different manufacturing processes, etc.
- Controlling the hazard at its source through use of engineering controls. Examples include local exhaust ventilation, isolation rooms, machine guarding, acoustic insulating, etc.
- Minimizing the hazard through design of safe work systems and administrative or institutional control measures. Examples include job rotation, training safe work procedures, lock-out and tag-out, workplace monitoring, limiting exposure or work duration, etc.
- Providing appropriate personal protective equipment (PPE) in conjunction with training, use, and maintenance of the PPE.

15. HSE PREPAREDNESS FOR ADVERSE CLIMATES AND WEATHER

All Preventive and Precautionary measures to ensure Health & Safety of workers in all possible adverse weather conditions based on the analysis of the local area conditions to be taken by the subcontractor

15.1 SUMMER

1. The Working Time and Lunch Hour will be as per instruction of Statutory Authorities (no work between 11am to 3:30pm). However, in case temp comes down due to rain/cloudy weather work will continue as per normal routine.
2. During long lunch break, worker will be allowed to go back home for rest. Those who will like to stay back will avail at the facility of rest shed or other designed area.
3. They will be allowed to take small break during work as per their need.
4. Water sprinkling will be done on roads to reduce dust concentration.
5. Workers will be provided with adequate cool drinking water and Butter milk/Lemon water etc.
6. Adequate ORS stock will be made available at the work location in the First-Aid Box for use as needed and at First-aid Centre for emergency need.
7. Fire prevention shall be on high alert, with removal of dry grass and bushes, etc, inside and outside the surrounding work areas. No smoking, and control of open flame/sparks shall be maintained and monitored.
8. Worker will be informed about the Do's and Don'ts to be followed during summer in the Pre Job Brief.

Dos & Don'ts

1. Drink plenty of cool water and other non-alcoholic fluid and keep body well hydrated.
2. Eat salt in food to replenish loss of salt through sweating.
3. Avoid over physical exercise.
4. Have adequate sleep at night.
5. Eat light and less spicy food
6. Avoid eating food which was cooked long time ago.

7. Nobody should use small water bodies such as pits, running rain water through crevices etc. for drinking and cleaning purpose as it may be unhygienic.

Emergency Handling

In case of emergency due to heat disorder:

1. Rescue the victim from workplace and place under shed.
2. If to be rescued from height, use stoke basket or rescue kit.
3. Inform Ambulance immediately.
4. If nearby any air conditioned room/shed is available, place him inside the room/shed.
5. Administer First aid by trained First aider for Heat Disorder
6. If conscious, give him ORS solution to drink.
7. If required send the victim hospital immediately.

15.2 MONSOON**A. Height Work & Structural Safety:**

1. Ensure that all height work platforms are barricaded and avoid any highly hazardous
2. Height work.
3. Ensure that all personnel have good quality and intact safety shoes
4. Stop all dangerous height work during rain
5. Explain Do's and Don'ts to workers during Tool Box Meetings
6. Ensure that there are no weak structures, boards etc. that can fall during high winds
7. Do not allow any loose material (e.g. GI sheet, Ply board, empty cement bag, aluminium foil, foam sheets etc.) on roof sheds or top of structures.
8. Do not permit any one to ride up or come down scaffolds frame work during heavy wind or rain.
9. Provide "anchor" of adequate strength to scaffolds and other high-rise structures.
10. All rest sheds and GI sheds will be anchored into the round and wall and roof panels will be secured with J hook to prevent shed from blowing over or parts/pieces becoming airborne. Proper earthing per IS standard is also to be installed.
11. Do not go alone nor permit anyone to stay at tower-tops, roof-tops, high structures or on electrical poles during the course of stormy weather or heavy rain.

B. Electrical:

1. All electrical connections / loads have to be routed through ELCB / RCCB (residual current circuit breaker) whose rating should be 30mA.
2. RCCB operational checks need to be done DAILY / WEEKLY during monsoon season.
3. Avoid joints on power cables which need to be laid over-head or under-ground, better not to have any joint at all. In case joints become essential, such cables must be housed rigidly and insulation must be provided as per approved standard. The joint shall be suitable for outdoor use.
4. All electrical distribution board shall be properly covered at top and sides to protect from rain water. Extension boards shall be protected from rain water.
5. Ensure proper "earthing" for each and every electrical appliance.
6. Double earthing need to be provided for 3-phase power supply and for voltage more than 220V.

7. Provide lightening arrestors at the top of Boiler 3 and boiler 4 and rest sheds which are not covered by existing lightening arrestor of other installation.

C. Others:

1. Maintain smooth flow on open drains. i.e. no obstruction or blockade shall be made on storm water drains. If required, make temporary drains.
2. Arrange back-filling of excavated pits on war-footing basis.
3. Arrange bringing down booms of all cranes, hydra machines during stormy weather (wind speed 40-50 km/hr)
4. Confirm that all gantry cranes are effectively choked to prevent rolling and toppling.
5. Do not forget to deep ready a dew battery operated lights at site-offices during rainy season.
6. Avoid using wet damp clothes.
7. Hard Barricade excavated zone filled with water with scaffolding pipe & clamp with reflective net
8. Engage diesel operated water pump to dewater work area. For electrically operated water pump, the starter shall be protected from rain water. All rotating parts shall be guarded. Ensure availability of sufficient water pumps.

D. Health and hygiene:

1. Monsoon reduces the immunity of our body and makes us vulnerable to many diseases which are commonly associated with this season. It is time for us to keep our body challenging against disease by boosting our immunity and taking safety measures against these diseases.
2. The diseases associated with monsoon are Malaria, Jaundice, Gastro-intestinal infections, like typhoid, cholera etc. apart from these viral infections like cold and cough also make their presence felt. Majority of above said diseases are on account of:
3. Puddle of water formed due to rain become breeding grounds for mosquitoes which spread disease like, malaria and dengue fever. As a precautionary measure against mosquito-bite disease one can use mosquito net around the end which is better choice to mosquito repellents like mats and coils.
4. Pollution of drinking water during monsoon is very common. It is very necessary to drink clean and pure water when water-borne monsoon diseases like diarrhoea and gastro-intestinal infections threaten us.
5. Walking in dirty water during rainy season leads of numerous fungal infection which affect toes and nails. Diabetic patients have to take a special care about their feet. Keeping feet always dry and clean is very necessary. Avoid walking in dirty water. Keep shoes socks and raincoats dry and clean.

E. Workmen will be made aware of following Do's and Don'ts:

1. Do not sleep in daytime.
2. Avoid over physical exertion.
3. During lightning and thunder storm, do not take shelter under tree. Take shelter inside rest shed or store room.
4. Wash vegetables with clean water and steam them well to kill germs.
5. Avoid eating un-cooked foods and salads should be washed properly before consumption.
6. Drink plenty of water and keep body well-hydrated.
7. Always keep the surrounding area dry and clean. Don't allow to get water accumulated around.
8. Keep body warm as viruses attack immediately when body temperature goes down.

9. Do not enter air conditioned room with wet hair and damp cloths.
10. Dry your feet and webs with soft dry cloth whenever they are wet.
11. Eat light and less spicy food.
12. Avoid eating food which was cooked long time ago.
13. Eat salt in food to replenish loss of salt through sweating.

15.3 EMERGENCY WEATHER CONDITIONS

Cyclone/Severe thunder storm

In the event of Cyclone/Severe thunder storm, alert will be issued by subcontractor on notification received by Govt. authorities/Metrological departments Customer or BHEL.

The actions required during cyclone/rough weather:

1. Check and advice subcontractors to clean-up work area. Pick up all loose and unused material of respective supervisor's area.
2. Tie to secure all gas cylinders to avoid displacement and unsafe conditions which could be due to wind pressure.
3. Secure portable electricity generating sets and other equipment, pumps, hoses etc.
4. Make preparation for removal of water logging.
5. Take review of work activity and make preparation for removal of equipment and material from vulnerable areas.
6. Isolate/turn off all electrical power form the main panel/switches. Secure and anchor panels properly.
7. Recheck anchorage/tie of all temporary structures/sheds, tall objects, cranes, rigs, scaffolds etc. to avoid toppling due to wind force.
8. Cranes boom shall be secured, either locked or lowered the booms as reasonably and practicably possible and rigs to safe position for the safety point of view.
9. Group up all trash barrels, wooden pallets, forms; wooden decks etc. and anchor properly.
10. Welding machines, air compressors and such equipment are to be grouped together and secured to the stable objects. Welding leads, electrical cables, hoses are to be rolled up and secured properly.
11. Set on site vehicles on high ground in the site area with brakes set firmly.
12. Anchor all tanks, vessels, gas cylinders that may be moved by high wind and water.
13. Evacuate job site.

Personnel Evacuation:

1. Personnel Evacuation will be required if predicted wind speed and storm surge heights are beyond acceptable limits as per the instructions from Govt. Authorities/ Metrological departments or Customer.
2. Once the warning is received for personnel evacuation, an emergency response team shall be formed. The team will work with local authorities and other agencies formed/deployed to evacuate and transport all personnel involved in the project to the cyclone shelter.
3. Cyclone may be followed by the calm "EYE", be aware of it. If the wind suddenly drops, don't assume the cyclone is over. Violent wind may resume from the opposite side direction. Wait for the official "All clear Signal".

4. After the cyclone, do not go outside until officially communicated about safe situation outside. Use recommended routes for returning. Do not panic or rush while returning.
5. Checking of gas leaks and well-being of electrical appliances is essential before leaving the site.
6. Follow local communications for official warning and advice. The construction Manager shall also obtain updates from customer/metrological departments and communicate to the personnel on project site.

15.4 PREVENTION OF COVID-19 (COVID-19 HERE TO BE READ AS COVID-19 AND OTHER PANDEMICS/ COMMUNICABLE DISEASES) AT PROJECT SITE & LABOUR COLONY:

Resumption of Construction Activities after Lock Down and Prevention of Coronavirus Infection during Site Operations and OCP 61A: Prevention of COVID-19 Infection in Labor Colony will be strictly followed.

A. Preventive measures at project site:

- BHEL and Agencies shall nominate COVID Marshalls, who will be responsible for monitoring the COVID prevention measures and apprising management on the same.
- Mandatory health check-up for every worker/ official joining the site
- All activities to be carried out using least amount of paperwork and physical proximity as far as possible.
- **HSE Observer App** to be used to monitor HSE Activities and follow up with agencies for closure of non-conformities.

a. Strict Control at the Gate/ Banning Entry to Anyone Not Wearing Masks

- i. Security personnel at the gate may erect a barricade preferably approx. 10 meters from the gate and only allow personnel who are wearing proper masks inside.
- ii. Public address system may be used to warn any non-compliant visitors
- iii. Near entry gate, round markers at minimum 1-meter distance to be ensured so that distancing is ensured
- iv. A hand-wash or hand sanitiser facility is preferable at the gate to allow entry after hand wash or hand sanitisation. These are also to be provided at key locations to enable hand wash / hand sanitisation before starting work, before eating, etc.
- v. Gutkha, Paan, tobacco etc. to be banned from the site. Spitting to be strictly prohibited.

b. Screening at Gate with Contactless Thermometer & Action on Suspected Cases

- i. Security Personnel at the Gate to screen each person entering the premises using a non-contact infrared thermometer, which is duly serial numbered and calibrated.
 - ii. In case any site worker/ official is found to have fever more than 99 Degrees Fahrenheit or found coughing/ sneezing, he/she may be advised rest till recovery and entry to be permitted after obtaining clearance from medical officer/assistance/attendants.
- Parcel to be collected from gate by concerned person preferably with provision of Special Box
 - Any construction material received at site, unless properly sanitized, to be kept undisturbed for at least 3 days and to be used only after that period.
 - During Toolbox Talks, minimum 1-meter distance between any two workers to be ensured

c. During site execution activities:

For all site execution activities, social distancing is to be maintained. In case this is not possible due to nature of work, speciality of work, etc, ensure sensitisation of the labour/staff involved and use of appropriate PPEs, especially mandatory face mask. In any case, close working to be allowed only in special

circumstances and ensuring these activities are preferably time staggered to the extent possible

d. In office premises:

- i. Sharing of items like pens, water bottles etc. in office premises to be avoided
- ii. Doors preferably to be in open condition to avoid contact
- iii. All common touch points to be frequently disinfected in a day.

e. Regular disinfection of all Areas, Equipment and facilities

- i. A dedicated disinfectant gang to be identified for the task by each agency. The disinfectant gang to be provided full body suits for the task.
- ii. All areas (including office premises, site areas, chairs, tables, furniture etc.), tools & equipment to preferably be disinfected by dedicated gang every day before resumption of work.
- iv. Common touch points like handrails, lift buttons, door/window knobs or handles, vehicle door handles, taps, conference room & dining hall tables/chairs, common sofas/chairs, visitor sofa/chairs, files & folders, etc to preferably be disinfected regularly at frequent intervals every day.
- v. Pool vehicles, to be disinfected after every use. Social distancing to be maintained inside the common pool vehicles as per Govt./ statutory body guidelines.

f. Disinfecting the operator/driver touch points of Vehicles/cranes, T&Ps etc.

Disinfection to also be carried out for all Cranes, Vehicles, Equipment, consoles, T&Ps etc. which come into contact with operating personnel.

g. Posters on COVID-19

Sufficient Posters on COVID-19 to be ensured across the site in languages understood by most workers.

h. Brief guidelines for hand washing are as below:

- i. Soap to be provided at each wash basin and replenished regularly.
- ii. Washing with soap for at least 20 seconds is recommended.
- iii. As a general guideline, for every 100 workers, 1 wash-basin may be provided at site areas.
- iv. Close queue to be avoided near wash-basins and 1-meter distance to be maintained. Round markers at 1-meter distance can be ensured as guidance

Composition of Disinfectant:

- i. Readily available 1% hypochlorite solution or 4%
- ii. Liquid chlorine-1% solution
- lii. Surgical spirit-95% alcohol content
- iv. Hand sanitizer should have: Isopropyl alcohol-75%, Glycerol-1.45%, Hydrogen Peroxide-0.125%

B. Prevention of COVID-19 Infection in Labor Colony:

- Spacing of minimum 2 meters between living areas of workers inside a room may be maintained. Preferably, the living area of each worker may be partitioned using sheet of cloth, plastic etc.
- Rooms to be properly ventilated as far as possible
- Sanitation to be given prime importance and personal hygiene to be promoted
- Face masks shall be worn by everyone inside the colony premises
- Spitting of Pan. Gutkha etc. inside the colony and urinating etc. outside the toilets to be strictly avoided
- Regular visits by Doctors to the labor colony can be arranged on non-working day for check-up of all workers
- **Identification of "COVID Wardens" (CWs) by each agency for maintaining the following:**
 - i. Keeping an eye on the health of workers and report any suspected cases of fever, coughing etc. to the

management

- ii. Keeping an eye on the social distancing measures in the labor colony and report any non-conformances to the management.
 - iii. Educate the workers about social distancing and COVID prevention measures.
- Training/ Awareness regarding COVID-19 to be provided to workers regularly.
 - Workers to be instructed to maintain social distancing of minimum 1 m at all time
 - **Posters on COVID-19:** Sufficient Posters on COVID-19 to be ensured across the labor colony in languages understood by most workers.
 - All workers to be instructed to inform any suspected cases of illness (individual or others) to an emergency contact number of CW, the emergency contact numbers and CW contact numbers to be displayed at prominent locations
 - **Inspection & Review**
 - i. Daily Inspection by concerned COVID Wardens and reporting to Agency
 - ii. Regular inspection by Agency & BHEL

15.5 Noise Mitigation

High noise is harmful to the human health and it can cause impairment if exposed for long duration at regular intervals, and also cause disruption in nearby communities.

- Noise monitoring shall be carried out in all construction locations periodically.
- Use of silent DG is allowed at site during construction.
- Low noise generation equipment's to be preferred.
- Work areas where noise levels exceed the 85db shall be posted as hearing protection required.
- Use of PPEs / ear plug/ear muff for personnel entering into high noise area.
- Activities generation High noise will be planned in day shift.

Noise Level Chart

Parameter	Night Noise level dBA	Daytime Noise Level dBA
At 1-meter from each piece of equipment	85	85
At Property boundary	70	70



ANNEXURE J

First-Aid Box

Details & Contents of First Aid Box as per Contract Labor (Regulation & Abolition Act), Central Rules, 1971

- (1) The first-aid box shall be distinctively marked with a Red Cross on a white background and shall contain the following items, namely:

(a) For establishments in which the number of contract labor employed does not exceed fifty, each first aid box shall contain the following equipment:

(i)	6 small sterilized dressings
(ii)	3 medium size sterilized dressings
(iii)	3 large size sterilized dressings
(iv)	6 pieces of sterilized eye pads in separate sealed packets.
(v)	6 roller bandages 10 cm wide.
(vi)	6 roller bandages 5 cm wide.
(vii)	One tourniquet
(viii)	A supply of suitable splints
(ix)	Three packets of safety pins.
(x)	Kidney tray.
(xi)	3 large sterilized burn dressings.
(xii)	1 (30ml) bottle containing a two percent alcoholic solution of iodine
(xiii)	1 (30 ml) bottle containing Sal volatile having the dose and mode of administration indicated on the label
(xiv)	1 snake bite lancet
(xv)	1 (30gms) bottle of potassium permanganate crystals.
(xvi)	1 pair scissors
(xvii)	1 copy of the First-Aid leaflet issued by the Director General, Factory Advice Service and Labor Institutes, Government of India.
(xviii)	A bottle containing 100 tablets (each of 5 grains) of aspirin
(xix)	Ointment for burns
(xx)	A bottle of suitable surgical anti-septic solution

(b) For establishment in which the number of contract labor exceeds fifty each first-aid box shall contain the following equipment:

(i)	12 small sterilized dressings
(ii)	6 medium size sterilized dressings
(iii)	6 large size sterilized dressings.
(iv)	6 large size sterilized burn dressings
(v)	6 (15 grams) packets sterilized cotton wool
(vi)	12 pieces of sterilized eye pads in separate sealed packets.
(vii)	12 roller bandages 10 cm wide.
(viii)	12 roller bandages 5 cm wide.
(ix)	One tourniquet.
(x)	A supply of suitable splints.
(xi)	Three packets of safety pins.
(xii)	Kidney tray.
(xiii)	Sufficient number of eye washes bottles filled with distilled water or suitable liquid clearly indicated by a distinctive sign which shall be visible at all times.
(xiv)	4 per cent Xylocaine eye drops, and boric acid eye drops and soda by carbonate eye drops.
(xv)	1 (60ml) bottle containing a two percent alcoholic solution of iodine
(xvi)	One (two hundred ml) bottle of mercurochrome (2 per cent) solution in water.
(xvii)	1 (120ml) bottle containing Sal volatile having the dose and mode of administration indicated on the label.
(xviii)	1 roll of adhesive plaster (6 cmX1 meter)
(xix)	2 rolls of adhesive plaster (2 cmX1 meter)
(xx)	A snake bite lancet.
(xxi)	1 (30 grams) bottle of potassium permanganate crystals.
(xxii)	1 pair scissors
(xxiii)	1 copy of the First-Aid leaflet issued by the Director-General, Factory Advice service and labor Institutes, Government of India.
(xxiv)	a bottle containing 100 tablets (each of 5 grains) of aspirin
(xxv)	Ointment for burns
(xxvi)	A bottle of a suitable surgical anti septic solution.

- (2) Adequate arrangement shall be made for immediate recoupment of the equipment when necessary.



ANNEXURE K

Vertigo Test

Rk

Vertigo Test Procedure/ Guidelines

This document specifies minimum requirements for vertigo test. These may be supplemented by any additional requirements deemed fit by the medical examiner/ HSE department)

Fear of height may be physiological or psychological. Therefore, to rule out any possibility of physiological factor, detailed medical check-up of workers is carried out before vertigo test. Medical check-up of workers includes the following:

history of past illnesses (like epilepsy, drug allergy, diabetics/ hypertension, unconsciousness etc.), general physical examination (like height, weight, BMI, build and nourishment etc.), measurement of pulse rate, Blood Pressure, respiratory rate.

After this check-up, those who are found suitable for height work by examining doctor, are allowed to undergo vertigo test.

During this health check-up, psychology of workers is also studied. If any worker finds it extremely difficult/ frightening to climb the monkey ladder & walk on the beam, during/after performing vertigo test or even before performing, then he is treated as disqualified.

As per standard, during vertigo test, worker is allowed to climb on a foundation through monkey ladder, walk on a beam, then steps down at the other end of beam, through monkey ladder. Height of the beam should be at least six feet from ground level. All necessary safety precautions are taken during this test. Worker has to wear full body harness with double lanyard. A horizontal lifeline is run parallel to the beam and worker has to put his lanyards into the lifeline. Additionally, a safety net is also put below the beam for rescue of the victim in case of a fall from beam.

Following activities are suggested to be carried out during testing:

1. Walking Bench Training:

- a. Person should walk over the channel. He should maintain balance & walk without much problem.
- b. If the person has problem to balances himself on repeated chances, he may be having flat foot or some other problem. So, he may not be fit for height work.

2. Rope Climb Training:

Person should be able to climb the rope up to the top channel for ensuring that in case of fall, a person hanging on the safety harness, will be able to safely climb back to the platform within minimum time period before the safety harness start breaking down under the load.

3. Height Work Training:

Person should walk freely on the middle channel while holding the top channel with the help of safety harness.

4. Ladder for Vertical fall arrestor Training:

Vertical fall arrestor rope is fixed from top to bottom of the ladder. It will ensure:

- Usage of vertical fall arrestor.
- Usage of two lanyards of a safety harness.
- Ensure 3-point contact on the ladder while climb.

5. Chair for work at height Training:

- Climb though vertical ladder with two lanyard ropes.
- Hooking of two lanyard ropes to life line. With this safe arrangement, he can walk to chair.
- Sits in the chair safely, comes out & walks back to the vertical ladder & come down from vertical ladder. After completion of vertigo test, blood pressure of worker is again measured. If it is not within acceptable limits for any worker, concerned worker is denied height pass.

Only those who pass the above training are to be considered as fit for height work.