



भारत हेवी इलेक्ट्रिकल्स लिमिटेड

(भारत सरकार का उपक्रम)

BHARAT HEAVY ELECTRICALS LIMITED

(A Govt. of India Undertaking)

Ref: BHEL: MSTPP: C- RW:CSD:22:10:06

Date:07.12.23

NOTICE INVITING TENDER (INTERNATIONAL BIDDING)

NOTE: INTENDING BIDDER TO PARTICIPATE MAY DOWNLOAD FROM WEB SITES

Sealed offers in two part bid system are invited from reputed & experienced bidders meeting PRE QUALIFICATION CRITERIA as mentioned in Annexure-1 hard copy mode, for the subject job by the undersigned on the behalf of BHARAT HEAVY ELECTRICALS LIMITED as per the tender document. Issue/ forwarding intimation regarding tender to any bidder shall not construe that the bidder is considered to be qualified. Consideration of their offer is subject to compliance of loading criteria as per clause no. 8.0 of NIT etc specified below. Following points relevant to the tender may please be noted and complied with.

1.0 Salient Features of NIT

SL NO	ISSUE	DESCRIPTION
i	TENDER NUMBER	Ref: BHEL: MSTPP: C- RW:CSD:22:10:06
ii	Broad Scope of job	PACKAGE 10W: Pile Cap, Civil, Structural & Architectural works of Construction Sheds and part balance works of roof water proofing for Aux & BOP Buildings for 2 x 660 MW Maitree STPP, Bangladesh.
iii	DETAILS OF TENDER DOCUMENT	
a	Volume-IA	General conditions of contract (Supply) Not Applicable.
b	Volume-IB	General conditions of contract (Service) Applicable.
c	Volume-IC	Special conditions of contract (Supply) Not Applicable.
d	Volume-ID	Special conditions of contract (Service) Applicable.
e	Volume-IE	Forms and Procedures etc. Applicable.
f	Volume-IF	Technical Conditions of Contract (TCC) (CML) Applicable.
g	Volume-III	Price Schedule (Absolute value) – Rev-00 Applicable.
iv	ISSUE OF TENDER DOCUMENTS	From BHEL website (www.bhel.com , Tender documents can be downloaded from above website till due date of submission. Applicable.
v	DUE DATE & TIME OF OFFER SUBMISSION	Date: 13.12.23 Time: 15-00 Hrs BST. The bidder may respond by submitting their offer through hard copy mode. Offers are invited in two-parts only. Applicable.
vi	OPENING OF TENDER	Date: 13.12.23 Time: 16-00 Hrs BST. (1 hours after the latest due date and time of Offer submission) Notes: (1) In case the due date of opening of tender becomes a non-working day, tenders shall be opened on next working day at the same time. (2) Bidder may depute representative to witness the opening of tender. Applicable.
vii	EMD AMOUNT	BDT 26,43,000/- Applicable
viii	COST OF TENDER	NA Not Applicable
ix	LAST DATE FOR	Date: 11.12.23

पावर सेक्टर पूर्वी क्षेत्र (मुख्यालय)

BHARAT HEAVY ELECTRICALS LIMITED, RAMPAL, BANGLADESH

	SEEKING CLARIFICATION		<i>Applicable.</i>
x	PREBID MEETING	<i>Prebid meeting shall be held at site office Rampal, Bagerhat, Bangladesh.</i>	
xi	SCHEDULE of Pre-Bid Discussion (PBD)		<i>Not Applicable (In case BHEL decides to conduct PBD, date, time & venue of PBD will be intimated suitably thru TCN.)</i>
xii	INTEGRITY PACT & DETAILS OF INDEPENDENT EXTERNAL MONITOR (IEM)	IEM DETAILS: <i>Shri D.R.S Chaudhary, IAS (Retd.), E-1/164, Arera Colony, Bhopal -462016 Email: dilip.chaudhary@icloud.com</i>	<i>Applicable.</i>
xiii	Latest updates	Latest updates on the important dates, Amendments, Correspondences, Corrigenda, Clarifications, Changes, Errata, Modifications, Revisions, etc to Tender Specifications will be hosted in BHEL webpage (www.bhel.com →Tender Notifications →View Corrigendum. Bidders to keep themselves updated with all such information.	<i>Shall be intimated to bidder.</i>

2.0 The offer shall be submitted as per the instructions of tender document and as detailed in this NIT. Bidders to note specifically that all pages of tender document, including these NIT pages of this particular tender together with subsequent correspondences shall be submitted by them, duly signed and stamped (digitally signed & stamped in case of e mode of bidding) on each page, as part of offer. **Rates/Price including discounts/rebates, if any, mentioned anywhere/ in any form in the techno-commercial offer other than the Price Bid, shall not be entertained.**

3.0 Unless specifically stated otherwise, bidder shall have to deposit EMD through Demand Draft / Pay Order/FDR from recognized bank as mentioned in the document in favor of Bharat Heavy Electricals Ltd, payable at Khulna. For other details please refer Technical Conditions of Contract / General Conditions of Contract.

4.0 **Procedure for Submission of Tenders:** The Tenderers must submit their Tenders as detailed below:

FOR HARD COPY SUBMISSION OF OFFER

- PART-I consisting of 'PART-I A (Techno Commercial Bid)' & 'PART-I B (EMD)' in two separate sealed and superscribed envelopes (ENVELOPE-I & ENVELOPE-II)
- PART-II (Price Bid) – in sealed and superscribed envelope (ENVELOPE-III)
One set of tender documents shall be retained by the bidder for their reference

The contents for ENVELOPES and the superscription for each sealed cover/Envelope are as given below.
FOR HARD COPY SUBMISSION (All pages to be signed and stamped)

Sl no	Description	Remarks
	Part-I A	
	ENVELOPE – I super scribed as : PART-I (TECHNO COMMERCIAL BID) TENDER NO : NAME OF WORK : PROJECT: DUE DATE OF SUBMISSION:	
	CONTAINING THE FOLLOWING: -	
i.	Covering letter/Offer forwarding letter of Tenderer.	
ii.	Duly filled-in 'No Deviation Certificate' as per prescribed format to be placed after document under sl no (i) above. Note: a. In case of any deviation, the same should be submitted separately for technical & commercial parts, indicating respective clauses of tender against which deviation is taken by bidder. The list of such deviation shall be placed after document under sl no (i) above. It shall be specifically noted that deviation recorded elsewhere shall not be entertained. b. BHEL reserves the right to accept/reject the deviations without assigning any reasons, and BHEL decision is final and binding. i). In case of acceptance of the deviations, appropriate loading shall be done by BHEL ii). In case of unacceptable deviations, BHEL reserves the right to reject the tender	Applicable.
iii.	Supporting documents/ annexures / schedules/ drawing etc as required in line with Pre-Qualification criteria. It shall be specifically noted that all documents as per above shall be indexed properly and credential certificates issued by clients shall distinctly bear the name of organization, contact ph no, FAX no, etc.	Applicable
iv.	All Amendments/Correspondences/Corrigenda/Clarifications/Changes/ Errata etc pertinent to this NIT.	
v.	Integrity Pact Agreement (Duly signed by the authorized signatory)	Applicable.
vi.	Duly filled-in annexures, formats etc as required under this Tender Specification/NIT	Applicable.
vii.	Notice inviting Tender (NIT)	Applicable.
viii.	Volume – I F : Technical Conditions of Contract (TCC)	Applicable.
ix.	Volume – I D : Special Conditions of Contract (SCC)-Service	Applicable.
x.	Volume - I B : General Conditions of Contract (GCC)-Service	Applicable.
xi.	Volume – I E : Forms & Procedures etc.	Applicable.
xii.	Volume – III- (UNPRICED – without disclosing rates/price, but mentioning only 'QUOTED' or 'UNQUOTED' against each item.	Applicable.
xiii.	Any other details preferred by bidder with proper indexing.	Applicable.

	PART-I B	
	ENVELOPE – II superscribed as: PART-I (EMD) TENDER NO : NAME OF WORK : PROJECT: DUE DATE OF SUBMISSION:	
	CONTAINING THE FOLLOWING:-	
i.	1. Earnest Money Deposit (EMD) in the form as indicated in this Tender	

PART-II	
	PRICE BID consisting of the following shall be enclosed
	ENVELOPE-III superscribed as: PART-II- (PRICE BID) TENDER NO : NAME OF WORK : PROJECT: DUE DATE OF SUBMISSION:
	CONTAINING THE FOLLOWING: -
i	Covering letter/Offer forwarding letter of Tenderer enclosed in Part-I
ii	Volume III – PRICE BID (Duly Filled in Schedule of Rates – rate/price to be entered in words as well as figures)

OUTER COVER	
	ENVELOPE-IV (MAIN ENVELOPE / OUTER ENVELOPE) superscribed as: TECHNO-COMMERCIAL BID, PRICE BID & EMD TENDER NO: NAME OF WORK: PROJECT: DUE DATE OF SUBMISSION:
	CONTAINING THE FOLLOWING:
i	<ul style="list-style-type: none"> o Envelopes I o Envelopes II o Envelopes III

SPECIAL NOTE:

- A) Your offer & documents submitted along with offer shall be signed & stamped in each page by your authorised representative. No overwriting/ correction in tender documents by bidders shall be allowed. However, if correction is unavoidable, the same may be signed by authorized signatory.
- B) The credentials/ documents submitted towards compliance of Pre-qualification requirement shall be physically signed by the authorized signatory & stamped before submission of offer.
- C) **All documents/ annexures submitted with the offer shall be properly annexed** and placed in respective places of the offer as per enclosure list mentioned in the covering letter. BHEL shall not be responsible for any missing documents.

5.0 No Deviation with respect to tender clauses and no additional clauses/ suggestions/ in Techno-commercial bid/ Price bid shall normally be considered by BHEL. Bidders are requested to positively comply with the same.

6.0 BHEL reserves the right to accept or reject any or all Offers without assigning any reasons thereof. BHEL also reserves the right to cancel the Tender wholly or partly without assigning any reason thereof. Also, BHEL shall not entertain any correspondence from bidders in this matter (except for the refund of EMD).

7.0 Assessment of Capacity of Bidders:

Bidder's capacity for executing the job under tender shall be assessed 'LOAD' wise and 'PERFORMANCE' wise as per the following:

- I. **LOAD:** Load takes into consideration **ALL** the contracts of the Bidder under execution with BHEL Regions, irrespective of whether they are similar to the tendered scope or not. The cut off month for reckoning 'Load'

shall be the 3rd Month preceding the month corresponding to the 'latest date of bid submission', in the following manner -

(Note: For example, if latest bid submission is in Jan 2017, then the 'load' shall be calculated up to and inclusive of Oct 2016)

Total number of Packages in hand = Load (P)

Where 'P' is the sum of all unit wise identified packages (refer table-1) under execution with BHEL Regions as on the cut off month defined above, including packages yet to be commenced, excepting packages which are on Long Hold.

- II. **PERFORMANCE:** Here 'Monthly Performance' of the bidder for all the packages (under execution/ executed during the 'Period of Assessment' in all Power Sector Regions of BHEL) **SIMILAR** to the packages covered under the tendered scope, excepting packages not commenced shall be taken into consideration. The 'Period of Assessment' shall be 6 months preceding and including the cut off month. The cut off month for reckoning 'Period of Assessment' shall be the 3rd Month preceding the month corresponding to 'latest date of bid submission', in the following manner:

(Note: For example, if 'latest date of bid submission' is in Jan 2017, then the 'performance' shall be assessed for a 6 months' period up to and inclusive of Oct 2016 (i.e. from May 2016 to Oct 2016), for all the unit wise identified packages (refer Table I))

- i). Calculation of Overall 'Performance Rating' for 'Similar Package/Packages' for the tendered scope under execution at Power Sector Regions for the 'Period of Assessment':

This shall be obtained by summing up the 'Monthly Performance Evaluation' scores obtained by the bidder in all Regions for all the similar Package/packages', divided by the total number of Package months for which evaluation should have been done, as per procedure below:

- $P_1, P_2, P_3, P_4, P_5, \dots, P_N$ etc. be the packages (under execution/ executed during the 'Period of Assessment' in all Regions of BHEL) **SIMILAR** to the packages covered under the tendered scope, excepting packages not commenced. Total number of similar packages for all Regions = P_T (i.e. $P_T = P_1 + P_2 + P_3 + P_4 + \dots + P_N$)
- Number of Months ' T_1 ' for which 'Monthly Performance Evaluation' as per relevant formats, should have been done in the 'Period of Assessment' for the corresponding similar package P_1 . Similarly T_2 for package P_2, T_3 for package P_3 , etc. for the tendered scope. Now calculate cumulative total months ' T_T ' for total similar Packages ' P_T ' for all Regions (i.e. $T_T = T_1 + T_2 + T_3 + T_4 + \dots + T_N$)
- Sum ' S_1 ' of 'Monthly Performance Evaluation' Scores ($S_{1-1}, S_{1-2}, S_{1-3}, S_{1-4}, S_{1-5}, \dots, S_{1-T_1}$) for similar package P_1 , for the 'period of assessment' ' T_1 ' (i.e. $S_1 = S_{1-1} + S_{1-2} + S_{1-3} + S_{1-4} + S_{1-5} + \dots + S_{1-T_1}$). Similarly, S_2 for package P_2 for period T_2 , S_3 for package P_3 for period T_3 etc. for the tendered scope for all Regions. Now calculate cumulative sum ' S_T ' of 'Monthly Performance Evaluation' Scores for total similar Packages ' P_T ' for all Regions (i.e. ' $S_T = S_1 + S_2 + S_3 + S_4 + S_5 + \dots + S_N$ ')
- Overall Performance Rating ' R_{BHEL} ' for the Similar Package/Packages** (under execution/ executed during the 'Period of Assessment') in all the Power Sector Regions of BHEL

$$= \frac{\text{Aggregate of Performance scores for all similar packages in all the Regions}}{\text{Aggregate of months for each of the similar packages for which performance should have been evaluated in all the Regions}}$$

$$= \frac{S_T}{T_T}$$

- e) Bidders to note that the risk of non-evaluation or non-availability of the 'Monthly Performance Evaluation' reports as per relevant formats is to be borne by the Bidder.

f) Table showing methodology for calculating 'a', 'b' and 'c' above

Sl. No.	Item Description	Details for all Regions							Total
		(iii)	(iv)	(v)	(vi)	(vii)	(viii)	(ix)	
(i)	(ii)								(x)
	Similar Packages for all Regions → (under execution/ executed during period of assessment)	P ₁	P ₂	P ₃	P ₄	P ₅	...	P _N	Total No. of similar packages for all Regions = P _T i.e. Sum (Σ) of columns (iii) to (ix)
2	Number of Months for which 'Monthly Performance Evaluation' as per relevant formats should have been done in the 'period of assessment' for corresponding Similar Packages (as in row 1)	T ₁	T ₂	T ₃	T ₄	T ₅	...	T _N	Sum (Σ) of columns (iii) to (ix) = T _T
3	Monthly performance scores for the corresponding period (as in Row 2)	S ₁₋₁ , S ₁₋₂ , S ₁₋₃ , S ₁₋₄ , ... S _{1-T1}	S ₂₋₁ , S ₂₋₂ , S ₂₋₃ , S ₂₋₄ , ... S _{2-T2}	S ₃₋₁ , S ₃₋₂ , S ₃₋₃ , S ₃₋₄ , ... S _{3-T3}	S ₄₋₁ , S ₄₋₂ , S ₄₋₃ , S ₄₋₄ , ... S _{4-T4}	S ₅₋₁ , S ₅₋₂ , S ₅₋₃ , S ₅₋₄ , ... S _{5-T5}	S _{N-1} , S _{N-2} , S _{N-3} , S _{N-4} , ... S _{N-TN}	-----
4	Sum of Monthly Performance scores of the corresponding Package for the corresponding period (as in row-3)	S ₁	S ₂	S ₃	S ₄	S ₅	...	S _N	Sum (Σ) of columns (iii) to (ix) = S _T

ii). Calculation of Overall 'Performance Rating' (R_{BHEL}) in case at least 6 evaluation scores for 'similar Package/Packages' for the tendered scope ARE NOT AVAILABLE, during the 'Period of Assessment':

This shall be obtained by summing up the 'Monthly Performance Evaluation' scores obtained by the bidder in all Regions for ALL the packages, divided by the total number of Package months for which evaluation should have been done. 'R_{BHEL}' shall be calculated subject to availability of 'performance scores' for at least 6 'package months' in the order of precedence below:

- 'Period of Assessment' i.e. 6 months preceding and including the cut-off month
- 12 months preceding and including the cut-off month
- 24 months preceding and including the cut-off month
- 36 months preceding and including the cut-off month

In case, R_{BHEL} cannot be calculated as above, then Bidder shall be treated as 'NEW VENDOR'. Further eligibility and qualification of this bidder shall be as per definition of 'NEW VENDOR' described in 'Explanatory Notes'.

iii). Factor "L" assigned based on Overall Performance Rating (R_{BHEL}) at Power Sector Regions:

Sl. no.	Overall Performance Rating (R _{BHEL})	Corresponding value of 'L'
1	=60	NA
2	> 60 and ≤ 65	0.4
3	> 65 and ≤ 70	0.35

4	> 70 and ≤ 75	0.25
5	> 75 and < 80	0.2
6	≥ 80	NA

III. 'Assessment of Capacity of Bidder':

'Assessment of Capacity of Bidder' is based on the Maximum number of packages for which a vendor is eligible, considering the performance scores of similar packages, as below:

Max number of packages $P_{Max} = (R_{BHEL} - 60)$ divided by corresponding value of 'L', i.e. $(R_{BHEL} - 60)/L$

Note:

- i). In case the value of P_{Max} results in a fraction, the value of P_{Max} is to be rounded off to next whole number
- ii). For $R_{BHEL} = 60$, $P_{Max} = '1'$
- iii). For $R_{BHEL} \geq 80$, there will be no upper limit on P_{Max}

The Bidder shall be considered 'Qualified' as per 'Assessment of Capacity of Bidder' for the subject Tender if $P \leq P_{Max}$
(Where P is calculated as per clause 'I' above)

IV. Explanatory note:

- i). Similar package means Boiler or ESP or Piping or Turbine or Civil or Structure or Electrical or C&I etc. at the individual level irrespective of rating of Plant and irrespective of whether the subject tender is a single package or as part of combined/composite packages. Normally Boiler, ESP, Piping, Turbine, Electrical, C&I, Civil, Structure etc. is considered individual level of package. For example, in case the tendered scope is a Boiler Vertical Package comprising of Boiler, ESP and Power Cycle Piping (i.e. the 'identified packages as per Table-1 below), the 'PERFORMANCE' part against sl.no. II above, needs to be evaluated considering all the identified packages (i.e. Boiler, ESP and Power Cycle Piping) and finally the Bidder's capacity to execute the tendered scope is assessed in line with III above.
- ii). Identified Packages (Unit wise)

Table-1

Civil	Electrical and C&I	Mechanical
i). Enabling works	i). Electrical	i). Boiler & Aux (All types including CW Piping if applicable)
ii). Pile and Pile Caps	ii). C&I	ii). Power Cycle Piping/Critical Piping
iii). Civil Works including foundations	iii). Others (Elect. and C&I)	iii). ESP
iv). Structural Steel Fabrication & Erection		iv). LP Piping
v). Chimney		v). Steam Turbine Generator set & Aux
vi). Cooling Tower		vi). Gas Turbine Generator set & Aux
vii). Others (Civil)		vii). Hydro Turbine Generator set & Aux
		viii). Turbo Blower (including Steam Turbine)
		ix). Material Management
		x). Others (Mechanical)

- iii). Bidders who have not been evaluated for at least six package months in the last 36 months preceding and including the Cut-off month in the online BHEL system for contractor performance evaluation in BHEL PS Regions, shall be considered "NEW VENDOR".

A 'NEW VENDOR' shall be considered qualified subject to satisfying all other tender conditions.

A 'NEW VENDOR' if awarded a job (of package/packages identified under this clause) shall be tagged as "FIRST TIMER" on the date of first LOI from BHEL.

The "FIRST TIMER" tag shall remain till completion of all the contracts against which vendor has been tagged as First Timer or availability of 6 evaluation scores within last 36 months preceding

and including the Cut-off month in the online BHEL system for contractor performance evaluation in BHEL PS Regions.

A Bidder shall not be eligible for the next job as long as the Bidder is tagged as "FIRST TIMER" excepting for the Tenders which have been opened on or before the date of the bidder being tagged as 'FIRST TIMER'.

After removal of 'FIRST TIMER' tag, the Bidder shall be considered 'QUALIFIED' for the future tenders subject to satisfying all other tender conditions including 'Assessment of Capacity of Bidders'.

- iv). In the unlikely event of all bidders shortlisted against Technical and Financial Qualification criteria not meeting the criteria on 'Assessment of Capacity of Bidders' detailed above, OR leads to a single tender response on applying the criteria of 'Assessment of Capacity of Bidders' OR due to non-approval by Customer, then BHEL at its discretion reserves the right to consider the further processing of the Tender based on the **Overall Performance Rating 'R_{BHEL}'** only, starting from the upper band.
- v). 'Under execution' shall mean works in progress as per the following:
- a. Up to execution of 90% of anticipated Contract Value in case of Civil, MM, Structural and Turbo Blower Packages
 - b. Up to Steam Blowing in case of Boiler/ESP/Piping Packages
 - c. Up to Synchronization in all Balance Packages
- Note: BHEL at its discretion can extend (or reduce in exceptional cases in line with Contract conditions) the period defined against (a), (b) and (c) above, depending upon the balance scope of work to be completed.
- vi). Contractor shall provide the latest contact details i.e. mail-ID and Correspondence Address to SCT Department, so that same can be entered in the Contractor Performance Evaluation System, and in case of any change/discrepancy same shall be informed immediately. Login Details for viewing scores in Contractor Performance Evaluation System shall be provided to the Contractor by SCT Department.
- vii). Performance Evaluation for Activity Month shall be completed in Evaluation Month (i.e. month next to Activity Month) or in rare cases in Post Evaluation Month (i.e. month next to Evaluation Month) after approval from Competent Authority. In case scores are not acceptable, Contractor can submit Review Request to GM Site/ GM Project latest by 25th of Evaluation Month or 3 days after approval of score, whichever is later. However, acceptance/rejection of 'Review Request' solely depends on the discretion of GM Site/GM Project. After acceptance of Review Request, evaluation score shall be reviewed at site and the score after completion of review process shall be acceptable and binding on the contractor.
- viii). Project on Hold due to reasons not attributable to bidder -
- a. **Short hold:** Evaluation shall not be applicable for this period; however Loading will be considered.
 - b. **Long hold:** Short hold for continuous six months and beyond or hold on account of Force Majeure shall be considered as Long Hold. Evaluation as well as Loading shall not be considered for this period.
- ix). Performance evaluation in CL 8 above is applicable to prime bidder and Consortium partner (or Technical tie up partner) for their respective scope of work.
- x). The above procedure of performance is not applicable for local Bangladesh Vendor and shall be evaluated based on Prequalification criteria.**

- 8.0 Since the job shall be executed at site, bidders must visit site/ work area and study the job content, facilities available, availability of materials, prevailing site conditions including law & order situation, applicable wage structure, wage rules, etc before quoting for this tender. They may also consult this office before submitting

- their offers, for any clarifications regarding scope of work, facilities available at sites or on terms and conditions.
- 9.0 For any clarification on the tender document, the bidder may seek the same in writing, through e-mail or through web site <https://www.bhel.com>, as per specified format, within the scheduled date for seeking clarification, from the office of the undersigned. BHEL shall not be responsible for receipt of queries after due date of seeking clarification due to any delay. Any clarification / query received after last date for seeking clarification may not be normally entertained by BHEL and no time extension will be given.
- 10.0 BHEL may decide holding of pre-bid discussion [PBD] with all intending bidders as per date indicated in the NIT. The bidder shall ensure participation for the same at the appointed time, date and place as may be decided by BHEL. Bidders shall plan their visit accordingly. The outcome of pre-bid discussion (PBD) shall also form part of tender.
- 11.0 In the event of any conflict between requirement of any clause of this specification/ documents/drawings/data sheets etc or requirements of different codes/standards specified, the same to be brought to the knowledge of BHEL in writing for clarification before due date of seeking clarification (whichever is applicable), otherwise, interpretation by BHEL shall prevail. Any typing error/missing pages/ other clerical errors in the tender documents, noticed must be pointed out before pre-bid meeting/submission of offer else BHEL's interpretation shall prevail.
- 12.0 Unless specifically mentioned otherwise, bidder's quoted price shall deem to be in compliance with tender including PBD.
- 13.0 Bidders shall submit Integrity Pact Agreement (Duly signed by authorized signatory who signs in the offer), **along** with techno - commercial bid. This pact shall be considered as a preliminary qualification for further participation. **The names and other details of Independent External Monitor (IEM) for the subject tender is as given at point (xi) of 1 above.**
- 14.0 The Bidder has to satisfy the Pre-Qualifying Requirements stipulated for this Tender in order to be qualified. The Price Bids of only those bidders will be opened who will be qualified for the subject job on the basis of satisfying the Pre-Qualification Criteria specified in this NIT as per Annexure-1 (as applicable), past performance etc. and date of opening of price bids shall be intimated to only such bidders. BHEL reserves the right not to consider offers of parties under HOLD.
- 15.0 In case BHEL decides on a 'Public Opening', the date & time of opening of the PRICE BID shall be intimated to the qualified bidders.
- 16.0 Validity of the offer shall be for **Ten months** from the latest due date of offer submission (including extension, if any) unless specified otherwise.
- 17.0 On submission of offer, further consideration will be subject to compliance to tender & qualifying requirement and customer's acceptance, as applicable.
- 18.0 In case the bidder is an "Indian Agent of Foreign Principals", 'Agency agreement has to be submitted along with Bid, detailing the role of the agent along with the terms of payment for agency commission in INR, along with supporting documents.
- 19.0 The bidders shall not enter into any undisclosed M.O.U. or any understanding amongst themselves with respect to tender.
- 20.0 Consortium Bidding (or Technical Tie up) shall be allowed only if specified in Pre-Qualifying Requirement (PQR) criteria, and in such a case the details to be complied with is enclosed herewith as per Annexure-5 UNLESS SPECIFIED OTHERWISE IN PQR.
- 21.0 The bidder shall submit documents in support of possession of 'Qualifying Requirements' duly self certified and stamped/ digitally signed (as applicable) by the authorized signatory, indexed and properly linked in the format for PQR. In case BHEL requires any other documents/proofs, these shall be submitted immediately.

- 22.0 The bidder may have to produce original document for verification if so decided by BHEL.
- 23.0 The offers of the bidders who are on the banned list as also the offer of the bidders, who engage the services of the banned firms, shall be rejected. The list of banned firms is available on BHEL Website (www.bhel.com).

l) Integrity commitment, performance of the contract and punitive action thereof:

a) Commitment by BHEL:

BHEL commits to take all measures necessary to prevent corruption in connection with the tender process and execution of the contract. BHEL will during the tender process treat all Bidder(s) in a transparent and fair manner, and with equity.

b) Commitment by Bidder/ Supplier/ Contractor:

b.i) The bidder/ supplier/ contractor commit to take all measures to prevent corruption and will not directly or indirectly influence any decision or benefit which he is not legally entitled to nor will act or omit in any manner which tantamount to an offence punishable under any provision of the law in force in India/Bangladesh.

b.ii) The bidder/ supplier/ contractor will, when presenting his bid, disclose any and all payments he has made, and is committed to or intends to make to agents, brokers or any other intermediaries in connection with the award of the contract and shall adhere to relevant guidelines issued from time to time by Govt. of India/Bangladesh/BHEL.

b.iii) The bidder/ supplier/ contractor will perform/ execute the contract as per the contract terms & conditions and will not default without any reasonable cause, which causes loss of business/ money/ reputation, to BHEL.

If any bidder/ supplier/ contractor during pre-tendering/ tendering/ post tendering/ award/ execution/ post-execution stage includes in mal-practices, cheating, bribery, fraud or and other misconduct or formation of cartel so as to influence the bidding process or influence the price or acts or omits in any manner which tantamount to an offence punishable under any provision of any other law in force in India/Bangladesh, then, action may be taken against such bidder/ supplier/ contractor as per extant guidelines of the company available on www.bhel.com and/ or under applicable legal provisions.

- 24.0 It may please be noted that Guidelines/Rules in respect of Suspension of business dealings (Hold- 12 to 24 Months/ Banning – 3 years etc), Vendor Evaluation formats, quality, safety and HSE guidelines , standard T&P hire charges of BHEL etc may undergo change from time to time and the latest one shall be followed. Latest “Guidelines for Vendor Evaluation” is web based, quality, safety & HSE”; standard T&P hire charges shall be available at site and shall be given to the successful vendors/ subcontractors during execution.
- 25.0 **(Not applicable for Vendors from Bangladesh)** MSE suppliers can avail the intended benefits in respect of the procurements related to the Goods and Services only (Definition of Goods and Services as enumerated by Govt. of India vide Office Memorandum F. No. 21(8)/2011-MA dtd. 09/11/2016 office of AS & DC, MSME) if they submit along with the offer, attested copies of either EM II certificate having deemed validity (five years from the date of issue of acknowledgement in EM II) or valid NSIC certificate or Udyog Aadhar Memorandum (UAM) & Acknowledgement or EM II certificate along with attested copy of a CA certificate (Format enclosed at Annexure – C where deemed validity of EM II certificate of five years has expired) applicable for the relevant financial year (latest audited). Date to be reckoned for determining the deemed validity will be the date of bid opening (Part 1 in case of two-part bid). Non submission of such documents will lead to consideration of their bid at par with other bidders. No benefit shall be applicable for this enquiry if any deficiency in the above required documents are not submitted before price bid opening. If the tender is to be submitted through e-procurement portal, then the above required documents are to be uploaded on the portal. Documents should be notarized or attested by a Gazetted officer.

Any Bidder falling under MSME category, shall furnish the following details & submit documentary evidence/Govt. Certificate etc. in support of the same along with their techno-commercial offer: -

Type under MSME	SC/ST owned	Others
Micro		
Small		
Medium		

Note: - If the bidder does not furnish the above, offer shall be processed construing that the bidder is not falling under MSME category.

- 26.0 The bidder along with its associates/collaborators/sub-contractors/sub-vendors/consultants/service providers shall strictly adhere to BHEL Fraud Prevention Policy displayed on BHEL website www.bhel.com and shall immediately bring to the notice of BHEL Management about any fraud or suspected fraud as soon as it comes to their notice.
- 27.0 Annexure-A -Amendment to GCC/SCC shall be read in conjunction with GCC-Volume-IB & SCC-Volume-ID. This Annexure-A (Amendment to GCC/SCC) of NIT shall not be considered as part of the NIT but addendum/corrigendum to the GCC/SCC only.
- 28.0 Annexure-E – Guidelines/ rules for Bank Guarantee submission by Foreign vendor.
- 29.0 For sale & import transactions, Foreign Bidders are required to submit the following documents before raising first bill for payment –
a) Tax Residency Certificate.
- 30.0 **Integrity Pact (IP) –**

a) IP is a tool to ensure that activities and transactions between the Company and its Bidders/ Contractors are handled in a fair, transparent and corruption free manner. A panel of Independent External Monitors (IEMs) have been appointed to oversee implementation of IP in BHEL.

The IP as enclosed with the tender is to be submitted (duly signed by authorized signatory who signs in the offer) along with techno-commercial bid. Only those bidders who have entered into such an IP with BHEL would be competent to participate in the bidding. In other words, entering into this Pact would be a preliminary qualification.

Details of IEM for this tender is furnished below:-

Name	} ---- REFER SL NO (xi) UNDER CLAUSE NO 1 ABOVE
Address	
e-mail	

(b) Please refer Section-8 of the IP for Role and Responsibilities of IEMs. In case of any complaint arising out of the tendering process, the matter may be referred to the IEM mentioned in the tender.

Note:

No routine correspondence shall be addressed to the IEM (phone/ post/ email) regarding the clarifications, time extensions or any other administrative queries, etc. on the tender issued. All such clarification/ issues shall be addressed directly to the tender issuing (procurement) department.

For all clarifications /issues related to tender, PI contact

Name	RIKASH JYOTI DUTTA (DGM)
Dept	PUR&SCT Dept ,BHEL,MSTPP.
Address	Rampal,Bagerhat,Bangladesh.
Phone no	+8801787671932 (Whatapp Call Available)
e-mail	rjd@bhel.in

- 35.0 The contractor shall, at all stages of work deploy skilled/ semi-skilled tradesmen who are qualified and possess certificate in particular trade from CPWD Training Institute/ Industrial Training Institute/ National Institute of Construction Management and Research (NICMAR), National Academy of Construction, CIDC **or any similar reputed and recognized Institute managed/ certified by State/ Central Government of India/Bangladesh.** The number of such qualified tradesmen shall not be less than 20% of total skilled/ semi-skilled workers required in each trade at any stage of work. The contractor shall submit number of man days required in respect of each trade, its scheduling and the list of qualified tradesmen along with requisite certificate from recognized Institute to Engineer-in-Charge for approval. Notwithstanding such approval, if the tradesmen are found to have inadequate skill to execute the work of respective trade, the contractor shall substitute such tradesmen within two days of written notice from Engineer-in-Charge. Failure on the part of contractor to obtain approval of Engineer-in-Charge or failure to deploy qualified tradesmen will attract a compensation to be paid by contractor at the rate of Rs. 100 equivalent per such tradesman per day. Decision of Engineer-in-Charge as to whether particular tradesman possesses requisite skill and amount of compensation in case of default shall be final and binding.”
- 36.0 It may please be noted that Bid should be free from correction, overwriting, using corrective fluid, etc. Any interlineation, cutting, erasure or overwriting shall be valid only if they are attested under full signature(s) of person(s) signing the bid, else bid shall be liable for rejection.

All overwriting/ cutting, etc. will be numbered by bid opening officials and announced during bid opening.

38.0 Order of Precedence

In the event of any ambiguity or conflict between the Tender Documents, the order of precedence shall be in the order below:

- I. Amendments/Clarifications/Corrigenda/Errata etc issued in respect of the tender documents by BHEL
- II. Notice Inviting Tender (NIT)
- III. Price Bid-Volume-III
- IV. Technical Conditions of Contract (TCC) -- Volume-IF
- V. Special Conditions of Contract (SCC) — Volume-ID
- VI. General Conditions of Contract (GCC) — Volume-IB
- VII. Forms and Procedures —Volume-IE
- VIII. Integrity Pact- Annexure-VI

for BHARAT HEAVY ELECTRICALS LTD



DGM (PUR&SCT)

Agency	Contact details	
BHEL, PSER, MAITREE SITE	Address	Bharat Heavy Electricals Ltd., Power Sector Easter Region, 2x660 MW Maitree Super Thermal Power Project, Upazilla: Rampal, Dist: Bagerhat, Division: Khulna, Bangladesh, Pin code: 9340
	Phone no	+8801787671932
	E-mail	rjd@bhel.in

Enclosure

01. Annexure-I: Pre-Qualification Criteria.
02. Annexure-II: Format for No deviation Certificate.
03. Annexure-III: Format for seeking clarification.
04. Annexure-IV: Check List.
05. Annexure-V: Conditions for consortium/tie up.
06. Annexure –A- Amendment to GCC/SCC.
07. Annexure –C- CA certificate Format.
08. Annexure-E – Guidelines/ rules for Bank Guarantee submission by Foreign vendor.
09. Annexure– CPP-GST/I.
10. Integrity Pact Agreement Format (Separate).
11. Form 10F (Separate).
12. Currency Matrix (Separate)
13. Other Tender documents as per this NIT

ANNEXURE - I**PRE QUALIFICATION CRITERIA**

JOB	PACKAGE 10W: Pile Cap, Civil, Structural & Architectural works of Construction Sheds and part balance works of roof water proofing for Aux & BOP Buildings for 2 x 660 MW Maitree STPP, Bangladesh.
TENDER NO	Ref: BHEL: MSTPP: C- RW:CSD:22:10:06
SL NO	CRITERIA
1.0	FINANCIAL CRITERIA
1.0 (a)	BIDDER SHOULD HAVE AVERAGE MINIMUM ANNUAL FINANCIAL TURNOVER OF BDT 4,13,43,750/- DURING THE LAST 3 (THREE) YEARS, ENDING ON 2021-22 OR CORRESPONDING FINANCIAL YEAR FOLLOWED BY THE BIDDER AND HAVING POSITIVE NET WORTH AS ON LATEST AUDITED ACCOUNTS AS SUBMITTED FOR PARA 1(C).
(b)	BIDDER MUST HAVE EARNED PROFIT IN ANY ONE OF THE LAST THREE FINANCIAL YEARS ENDING ON 2021-22 OR CORRESPONDING FINANCIAL YEAR FOLLOWED BY THE BIDDER. AUDITED BALANCE SHEET AND PROFIT & LOSS ACCOUNT OF THE COMPANY FOR LAST 3 (THREE) FINANCIAL YEARS, ENDING ON 2021-22 OR CORRESPONDING FINANCIAL YEAR FOLLOWED BY THE BIDDER NEED TO BE SUBMITTED IN SUPPORT OF ABOVE.
(c)	IN CASE AUDITED BALANCE SHEET AND PROFIT AND LOSS ACCOUNT HAS NOT BEEN SUBMITTED FOR ALL THREE YEARS INDICATED ABOVE THEN THE APPLICABLE FINANCIAL AUDITED STATEMENTS SUBMITTED BY THE BIDDERS AGAINST THE REQUISITE THREE YEARS WILL BE AVERAGED FOR THREE YEARS.
(d)	IF FINANCIAL STATEMENTS ARE NOT REQUIRED TO BE AUDITED STATUTORILY, THEN INSTEAD OF AUDITED FINANCIAL STATEMENTS, FINANCIAL STATEMENTS ARE REQUIRED TO BE CERTIFIED BY CHARTERED ACCOUNTANT.
2.0	TECHNICAL CRITERIA
2.1	GENERAL TECHNICAL CRITERIA (B1)
2.1	BIDDER SHOULD HAVE EXECUTED 'CIVIL' WORKS OR 'CIVIL AND STRUCTURES' WORKS IN INDUSTRIAL SECTOR DURING THE LAST 7 (SEVEN) YEARS, ENDING ON THE LATEST DATE OF BID SUBMISSION, VALUE OF WHICH SHOULD NOT BE LESS THAN EITHER OF THE FOLLOWING: RELEVANT DOCUMENT IN SUPPORT OF ABOVE SHALL BE SUBMITTED.
2.1.1	1 (SINGLE) WORK OF VALUE NOT LESS THAN BDT 11,02,50,000/-
	OR
2.1.2	2 (TWO) WORKS EACH OF VALUE NOT LESS THAN 6,89,06,250/-
	OR
2.1.3	3 (THREE) WORKS EACH OF VALUE NOT LESS THAN 5,51,25,000/-
2.2	SPECIALIZED CRITERIA (B2)
A	EXECUTED AN RCC QUANTITY OF 1025 CUM, IN CUMULATIVE OF TWO RUNNING /COMPLETED CONTRACTS WITHIN A COMMON PERIOD OF TWELVE CONSECUTIVE MONTHS
	OR
B	EXECUTED AN RCC QUANTITY OF 1025 CUM, WITHIN A PERIOD OF TWELVE CONSECUTIVE MONTHS IN ONE RUNNING/COMPLETED CONTRACTS
C	TENDERED CONCRETE QUANTITY = 1025 CUM, ANNUALIZED QUANTITY = 1025 CUM (COMPLETION PERIOD LESS THAN 12 MONTHS)
2.3	THE BIDDER SHOULD HAVE VALID LICENSE FOR THE CONSTRUCTION WORK IN BANGLADESH.
2.4	BIDDER SHOULD SUBMIT VALID -TIN & BIN IN BANGLADESH.
2.5	RELEVANT DOCUMENT IN SUPPORT OF ABOVE SHALL BE SUBMITTED.
3.0	GENERAL
A	CONSORTIUM BIDDING IS NOT ALLOWED.
B	IN CASE THE JOB IS UNDER EXECUTION/ ONGOING JOB, THE VALUE OF EXECUTED PORTION OF THE JOB SHALL BE AT LEAST CORRESPOND TO THE RESPECTIVE VALUES SPECIFIED ABOVE EVEN IF THE CONTRACT HAS NOT BEEN COMPLETED OR CLOSED.
C	THE VENDOR SHOULD HAVE ACHIEVED THE CRITERIA SPECIFIED IN THE PRE-QUALIFICATION CRITERIA, EVEN IF THE CONTRACT HAS NOT BEEN COMPLETED OR CLOSED.
D	AFTER SATISFACTORY FULFILLMENT OF ALL ABOVE CRITERIA, OFFER SHALL BE CONSIDERED FOR FURTHER EVALUATION & PARTICIPATION AS PER NIT & ALL OTHER TERMS OF TENDER.

Explanatory Notes for the PQR (unless otherwise specified in the PQR):

- Bidder to submit Audited Balance Sheet and Profit and Loss Account for the respective years as indicated along with all annexures.
- In case audited Financial statements have not been submitted for all the three years as indicated, then the applicable audited

- statements submitted by the bidders against the requisite three years, will be averaged for three years i.e total divided by three.
3. NET WORTH: Shall be calculated based on the latest Audited Accounts as furnished. Net worth = Paid up share capital + Reserves. (Net worth is required to be evaluated in case of companies)
 4. PROFIT: shall be NET profit (PAT + Non cash expenditure viz depreciation) earned during any one of the three financial years.
 5. 'Additional' Criteria in respect of 'Technical' criteria of PQR for Civil, Electrical, CI, unless otherwise specified:
 - i) 'Similar' work means
 - a. Piling or Civil or Structure or 'Civil and Structures' or Chimney or Cooling Tower for 'CIVIL Works'.
 - b. Electrical and C&I for 'Electrical and C&I Works'.
 6. Time period for achievement of the 'Technical' criteria of PQR will be the last 7 years ending on the 'latest date' of Bid submission
 7. 'EXECUTED' means the Vendor should have achieved the criteria specified in the Technical criteria of PQR even if the Contract has not been completed or closed
 8. Unless otherwise specified, for the purpose of 'Technical' criteria of PQR, the word 'EXECUTED' means:
 - a. "ACHIEVEMENT OF PHYSICAL QUANTITIES" as per respective PQRs in respect of Piling / Civil / Structures / Chimney.
 - b. "READINESS FOR COAL FILLING" in respect of Mill Bunker.
 - c. "CHARGING" in respect of Power Transformers / Bus Ducts / "HT/LT Switchgears" / "HT / LT Cabling".
 - d. For C&I works: "SYNCHRONISATION" in case of power project and "WORK COMPLETION of the value as defined in PQR" in case of industry.
 - e. "BOILER LIGHT UP" in respect of Boiler / CFBC / ESP.
 - f. "GAS IN" in respect of HRSG.
 - g. "STEAM BLOWING COMPLETION" in respect of Power Cycle Piping.
 - h. "HYDRAULIC TEST" of the system in respect of Pressure parts / LP Piping / CW Piping.
 - i. "FULL LOAD OPERATION OF THE UNIT" in respect of Insulation work.
 - j. "SYNCHRONISATION" in respect of STG / GTG.
 - k. "SPINNING" in respect of HTG.
 9. Boiler means HRSG or WHRB or any other types of Steam Generator
 10. Power Cycle piping means Main Steam, Hot Reheat, Cold Reheat, HP Bypass
 11. For the purpose of evaluation of the PQR, one MW shall be considered equivalent to 3.5TPH where ever rating of HRSG/BOILER is mentioned in MW. Similarly, where ever rating of Gas Turbine is mentioned in terms of Frame size, ISO rating in terms of MW shall be considered for evaluation.
 12. In case the experience/PO/WO certificate enclosed by bidders do not have separate break up prices for the E&C portion of Electrical and CI Works, (i.e. the certificates enclosed are for composite order for supply and erection of Electrical & CI and other works if any), then value of Erection and Commissioning for the Electrical & CI portion shall be considered as 15% of the supply & erection of Electrical & CI, unless otherwise specifically indicated in the PQR.
 13. Scope for capital overhaul of STG shall cover Bearing Inspection work and overhauling of all cylinders of the Turbine.
 14. In case the tendered scope is not a Pulverised Fuel Boiler, experience of Oil/Gas Fired Boilers also can be considered.
 15. Value of work is to be updated with indices for "All India Avg. Consumer Price index for industrial workers" and "Monthly Whole Sale Price Index for All Commodities" with base month as per last month of work execution and indexed up to three (3) months prior to the month of latest due date of bid submission as per following formula-

$$P = R + \left\{ 0.425 \times R \times \frac{(X_N - X_0)}{X_0} \right\} + \left\{ 0.425 \times R \times \frac{(Y_N - Y_0)}{Y_0} \right\}$$

Where P = Updated value of work, R = Value of executed work

X_N = All India Avg. Consumer Price index for industrial workers for the month, three months prior to the month of latest due date of bid submission (e.g. If latest bid submission date is 03-Apr-17, then bid submission month shall be reckoned as April'17 and index for Jan'17 shall be considered).

X_0 = All India Avg. Consumer Price index for industrial workers for last month of work execution

Y_N = Monthly Whole Sale Price Index for All Commodities for the month, three months prior to the month of latest due date of bid submission (e.g. If latest bid submission date is 03-Apr-17, then bid submission month shall be reckoned as April'17 and index for Jan'17 shall be considered).

Y_0 = Monthly Whole Sale Price Index for All Commodities for last month of work execution

16. PROFIT shall be PBT earned during any one year of last three financial years as mentioned in PQR.
17. For evaluation of PQR, the credentials of the Bidder alone, and not that of the Group Company shall be considered.
18. "Executed" means the bidder should have achieved the criteria specified in the PQR even if the Contract has not been completed or closed.

ANNEXURE – II**NO DEVIATION CERTIFICATE**
(To be submitted in the bidder's letter head)

To,
BHARAT HEAVY ELECTRICALS LIMITED,
MSTPP, RAMPAL, BAGERHAT, BANGLADESH

Sub	No Deviation Certificate.	
Job	PACKAGE 10W: Pile Cap, Civil, Structural & Architectural works of Construction Sheds and part balance works of roof water proofing for Aux & BOP Buildings for 2 x 660 MW Maitree STPP, Bangladesh.	
Ref	1.0	TENDER NO: Ref: BHEL: MSTPP: C- RW:CSD:22:10:06
	2.0	All other pertinent issues till date.

Dear Sirs,

With reference to above, this is to confirm that as per tender conditions, we have visited site before submission of our offer and noted the job content & site conditions etc. We also confirm that we have not changed/ modified the tender documents as appeared in the website/ issued by you and in case of such observance at any stage, it shall be treated as null and void.

We hereby confirm that we have not taken any deviation from tender clauses together with other references as enumerated in the above referred NIT. We hereby confirm our unqualified acceptance to all terms & conditions, unqualified compliance to technical specification and integrity pact.

In the event of observance of any deviation in any part of our offer at a later date whether implicit or explicit, the deviations shall stand null & void.

We confirm to have submitted/uploaded offer/documents in accordance with tender instructions with acceptance of the terms & conditions of the tender by us and as per aforesaid references.

Thanking you,

Yours faithfully,

(Signature, date & seal of authorized
representative of the bidder)

ANNEXURE - IV**CHECK LIST****NOTE:- Tenderers are required to fill in the following details and no column should be left blank**

1	Name and Address of the Tenderer		
2	Details about type of the Firm/Company		
3.a	Details of Contact person for this Tender	Name : Mr/Ms Designation: Telephone No: Mobile No: Email ID: Fax No:	
3.b	Details of alternate Contact person for this Tender	Name : Mr/Ms Designation: Telephone No: Mobile No: Email ID: Fax No:	
4	EMD DETAILS	DD No: Date: Bank: Amount: Please tick (<input checked="" type="checkbox"/>) whichever applicable:- ONE TIME EMD / ONLY FOR THIS TENDER	
5	Validity of Offer	TO BE VALID FOR TEN MONTHS FROM DUE DATE	
		APPLICABILITY (BY BHEL)	ENCLOSED BY BIDDER
6	Whether the format for compliance with PRE-QUALIFICATION CRITERIA (ANNEXURE-I) is understood and filled with proper supporting documents referenced in the specified format	Applicable	YES / NO
7	Audited profit and Loss Account for the last three years	Applicable/Not Applicable	YES/NO
8	Copy of PAN Card/TIN NO	Applicable/Not Applicable	YES/NO
9	Whether all pages of the Tender documents including annexures, appendices etc are read understood and signed	Applicable/Not Applicable	YES/NO
10	Integrity Pact	Applicable/Not Applicable	YES/NO
11	Declaration by Authorised Signatory	Applicable/Not Applicable	YES/NO
12	No Deviation Certificate	Applicable/Not Applicable	YES/NO
13	Declaration confirming knowledge about Site Conditions	Applicable/Not Applicable	YES/NO
14	Declaration for relation in BHEL	Applicable/Not Applicable	YES/NO
15	Non-Disclosure Certificate	Applicable/Not Applicable	YES/NO
16	Bank Account Details for E-Payment	Applicable/Not Applicable	YES/NO
17	Capacity Evaluation of Bidder for current Tender	Applicable/Not Applicable	YES/NO
18	Tie Ups/Consortium Agreement are submitted as per format	Applicable/Not Applicable	YES/NO
19	Power of Attorney for Submission of Tender/Signing Contract Agreement	Applicable/Not Applicable	YES/NO
20	Analysis of Unit rates	Applicable/Not Applicable	YES/NO

NOTE: STRIKE OFF 'YES' OR 'NO', AS APPLICABLE. TENDER NOT ACCOMPANIED BY THE PRESCRIBED **ABOVE APPLICABLE DOCUMENTS** ARE LIABLE TO BE SUMMARILY REJECTED.

DATE :

AUTHORISED SIGNATORY
(With Name, Designation and Company seal)

ANNEXURE-V

CONDITIONS TO BE COMPLIED WITH FOR CONSORTIUM BIDDING (TECHNICAL TIE UP)

- 1 NOT APPLICABLE.

Annexure - A**Amendment to GCC/SCC (Vol-IB/Vol-ID)****1. Clause no. 1.9.1(ii) of GCC shall be read as below:**

The EMD may be accepted only in the following forms:

- (a) Cash deposit as permissible under the extant Income Tax Act (before tender opening)
- (b) Electronic Fund Transfer credited in BHEL account (before tender opening)
- (c) Banker's cheque/ Pay order/ Demand draft, in favour of BHEL (along with offer)

In case total EMD amount is more than Rs. 20 Lakh or equivalent, the amount in excess of Rs. 20 lakh may be accepted in the form of Bank Guarantee from scheduled bank. The Bank Guarantee in such cases shall be valid for atleast ten months. EMD of successful tenderer will be retained as part of Security Deposit.

Clause no. 1.9.1(iv) & (v) of GCC stands deleted.

2. Clause no. 1.10.1 of GCC shall be read as below:

The total amount of Security Deposit will be 5% of the contract value. EMD of the successful tenderer shall be converted and adjusted towards the required amount of Security Deposit.

3. Clause no. 1.10.2 of GCC shall be read as below:

At least 50% of the required Security Deposit, including the EMD, should be furnished before start of the work. Balance of the Security Deposit can be deposited by deducting 10% of the gross amount progressively from each of the running bills of the Contractor till the total amount of the required Security Deposit is collected.

The recoveries made from running bills (cash deduction towards balance SD amount) can be released against submission of equivalent Bank Guarantee in acceptable form, but only once, before completion of work, with the approval of competent authorities.

4. Clause no. 1.10.3 of GCC shall be read as below:

The balance amount to make up the required Security Deposit of 5% of the contract value may be accepted in the following forms:

- a) Cash (as permissible under the extant Income Tax Act)
- b) Local cheques of Scheduled Banks (subject to realization)/ Pay Order/ Demand Draft/ Electronic Fund Transfer in favour of BHEL
- c) Bank Guarantee from Scheduled Banks/ Public Financial Institutions as defined in the Companies Act. The Bank Guarantee format should have the approval of BHEL
- d) Fixed Deposit Receipt issued by Scheduled Banks/ Public Financial Institutions as defined in the Companies Act (FDR should be in the name of the Contractor, a/c BHEL)
- e) Securities available from Indian Post offices such as National Savings Certificates, Kisan Vikas Patras etc. (held in the name of Contractor furnishing the security and duly endorsed/ hypothecated/ pledged, as applicable, in favour of BHEL)

(Note: BHEL will not be liable or responsible in any manner for the collection of interest or renewal of the documents or in any other matter connected therewith)

5. Clause no. 1.11 of GCC shall be read as below:

Security Deposit shall be refunded/Bank Guarantee(s) released to the Contractor along with the 'Final Bill' after deducting all expenses / other amounts due to BHEL under the contract / other contracts entered into with them by BHEL upon fulfilment of contractual obligations as per terms of the contract.

6. Clause no. 2.8.3, 2.8.4 and 2.8.5 of GCC shall be read as below:

Clause no. 2.8.3: The contractor shall comply with all applicable Laws, Statutory Rules, Regulations, Notifications, etc. such as Payment of Wages Act, Minimum Wages Act, Workmen Compensation Act, Employer's Liability Act, Industrial Disputes Act, Employers Provident Act, Employees State Insurance Scheme, Contract Labour (Regulation and Abolition) Act, Payment of Bonus & Gratuity Act, Building and Other Construction Workers (Regulation of Employment and Conditions of Service) Act, or any other Acts, Rules, and Regulations for labour/workers or governing execution of the work as may be enacted by the Bangladesh Government during the tenure of the Contract and having force or jurisdiction at Site. The Contractor shall also comply with provisions of and give all such notices to the local Governing Body, Police and other relevant Authorities as may be required by the Law of the land.

Clause no. 2.8.4: The Contractor shall obtain independent License for engaging contract labour/workers as required from the concerned Authorities issued by the Principal Employer/Customer/Statutory Bodies as per the prevailing Act or Rules/Regulations of Bangladesh

Clause no. 2.8.5: The contractor shall pay and bear all taxes, fees, license charges, Cess, duties, deposits, tolls, royalties, commission or other charges which may be leviable on account of his operations in executing the contract.

7. Clause 2.12 of GCC (Overrun Compensation) (Not applicable)

a) Existing Clause 2.12.2 of GCC stands revised as follows:

"Rates shall be increased by **5%** for the first twelve months of one or more extensions beyond original contract period. For the next twelve months of further extensions if any, rates shall be increased as above by **5%** over the previous twelve months, and similarly for each subsequent twelve months extension"

b) Existing Clause 2.12.3 of GCC stands revised as follows:

"The amount of increase payable per month due to rate revisions is subject to a minimum of Rs 1,00,000/- per month and a maximum of Rs **5,00,000/-** per month".

8. Clause 2.14 of GCC (Quantity Variation)

a) Existing Clause 2.14.1 of GCC stands revised as follows:

"The quantities given in the contract are tentative and may change to any extent (both in plus side and minus side). The quoted rates for individual items shall remain firm irrespective of any variations in the individual quantities No compensation becomes payable in case the variation of the final executed contract value is within the limit of Minus (-) 30% of awarded contract value"

b) Existing Clause 2.14.2 ii). of GCC stands revised as follows:

"In case the finally executed contract value increases above the awarded Contract Value due to quantity variation, there will be no upward revision in the rates **for the individual items and also contractor is not eligible for any compensation.**"

9. Clause 2.17 of GCC (Price Variation Compensation) stands revised as follows:

2.17 PRICE VARIATION COMPENSATION (NOT APPLICABLE)

2.17.1 In order to take care of variation in cost of execution of work on either side, due to variation in the index of LABOUR, HIGH SPEED DIESEL OIL, WELDING ROD, CEMENT, STEEL, MATERIALS, Price Variation

Formula as described herein shall be applicable (only for works executed during extended period, if any, subject to other conditions as described in this section)

2.17.2 85% component of Contract Value shall be considered for PVC calculations and remaining 15% shall be treated as fixed component.

2.17.3 The basis for calculation of price variation in each category, their component, Base Index shall be as under:

SL NO	CATEGORY	BASE INDEX	PERCENTAGE COMPONENT ('K')				
			CIVIL PACKAGES (See Note AB/C)			MECHANICAL PACKAGES	Electrical, C&I Material Management/Handling and other labour oriented packages
			A	B	C		
i)	LABOUR (ALL CATEGORIES)	'MONTHLY ALL-INDIA AVERAGE CONSUMER PRICE INDEX NUMBERS FOR INDUSTRIAL WORKERS' published by Labour Bureau, Ministry of Labour and Employment, Government of India. (Website: labourbureau.nic.in)	40	25	30	65	80
ii)	HIGH SPEED DIESEL OIL	Name of Commodity: HSD Commodity Code: 1202000005 (See Note E)	5	3	5	5	5
iii)	WELDING ROD	Name of Commodity: MANUFACTURE OF BASIC METALS Commodity Code: 1314000000 (See Note E)				15	
iv)	CEMENT	Name of Commodity: ORDINARY PORTLAND CEMENT Commodity Code: 1313050003 (See Note E)		20	30		
v)	STEEL (Structural and Reinforcement Steel)	Name of Commodity: MILD STEEL: LONG PRODUCTS Commodity Code: 1314040000 (See Note E)		25			
vi)	All OTHER MATERIALS (Other than Cement & Steel)	Name of Commodity: ALL COMMODITIES Commodity Code: 1000000000 (See Note E)	40	12	20		

Note: A) Cement & Steel: Free Issue (BHEL Scope)
 B) Cement & Steel : In Contractor Scope
 C) Cement in Contractor Scope, and Steel is Free Issue (BHEL Scope)
 D) For Composite packages (i.e. Civii+Mechanicai+Electrical and/or CI or Civil+Mechanical or Mechanicai+Electrical and/or CI), the COMPONENT ('K') for various categories shall be as per respective packages as above.
 E) As per the 'MONTHLY WHOLE SALE PRICE INDEX' for the respective Commodity and Type, published by Office of Economic Adviser, Ministry of Commerce and Industry, Government of India. (Website: <http://eaindustry.nic.in/home.asp>). Revisions in the index or commodity will be re adjusted accordingly.

2.17.4 Payment/recovery due to variation in index shall be determined on the basis of the following notional formula in respect of the identified COMPONENT ('K') viz LABOUR, HIGH SPEED DIESEL OIL, WELDING ROD, CEMENT, STEEL, MATERIALS.

$$P = K \times R \times \frac{(X_N - X_0)}{X_0}$$

Where

P = Amount to be paid/recovered due to variation in the Index for Labour, High Speed Diesel Oil, Welding Rod, Cement, Steel and Materials

K = Percentage COMPONENT ('K') applicable for Labour, High Speed Diesel Oil, Welding Rod, Cement, Steel and Materials

R = Value of work done for the billing month (Excluding Taxes and Duties if payable extra)

X_N = Revised Index for Labour, High Speed Diesel Oil, Welding Rod, Cement, Steel and Materials for the billing month under consideration

X_o = Index for Labour, High Speed Diesel Oil, Welding Rod, Cement, Steel and Materials as on the Base date

2.17.5 Base date shall be the calendar month of the schedule completion date (i.e. Actual start date+ Scheduled Contractual completion period as per Letter of Intent/award and/or work order).

2.17.6 PVC shall not be payable for the ORC amount, Supplementary/Additional Items, Extra works. However, PVC will be payable for items executed under quantity variation of BOQ items under originally awarded contract.

2.17.7 The contractor shall furnish necessary monthly bulletins in support of the requisite indices from the relevant websites along with his Bills.

2.17.8 The contractor will be required to raise the bills for price variation payments on a monthly basis along with the running bills irrespective of the fact whether any increase/decrease in the index for relevant categories has taken place or not. In case there is delay in publication of bulletins (final figure), the provisional values as published can be considered for payments and arrears shall be paid/recovered on getting the final values.

2.17.9 PVC shall be applicable only, during the extended period of contract (if any) after the scheduled completion period and for the portion of work delayed / backlog for the reasons not attributable to the Contractor.

However total quantum of Price Variation amount payable/recoverable shall be regulated as follows:

- i. For the portion of shortfall / backlog not attributable to contractor, PVC shall be worked out on the basis of indices applicable for the respective month in which work is done. Base index shall be applicable as defined in clause 2.17.5
- ii. In case of Force majeure, PVC shall be regulated as per (a) or (b) below:
 - a) Force majeure is invoked before "base date"/ "revised base date" (as explained below) OR immediately after "base date"/ "revised base date" in continuation (i.e. during the period when PVC is not applicable):
 1. Base date shall be revised: Revised base date = Previous base date + duration of Force majeure.
No PVC will be applicable for the work done till revised base date.
 2. PVC will be applicable for the work done after "base date"/ "revised base date" as the case may be (during extended period when delay is not attributable to contractor). PVC shall be worked out on the basis of indices applicable for the respective month in which work is done with base index as on "base date"/"revised base date" as the case may be.
 - b) Force majeure is invoked after "base date"/ "revised base date" as the case may be (during extended period when delay is not attributable to contractor) -
 1. PVC shall be applicable for the work done after revocation of force majeure.
 2. PVC for the work done after revocation of force majeure shall be worked out on the basis of indices applicable for the respective month in which work is done excluding the effect of change in indices during total period of Force majeure(s) invoked after "base date"/ "revised base date" as the case may be. Base index shall be taken as on "base date"/ "revised base date" as the case may be.
- iii. The total amount of PVC shall not exceed 15% of the cumulatively executed contract value. Executed contract value for this purpose is exclusive of PVC, ORC, Supplementary/Additional Items and Extra works except extra items due to quantity variation.

10. Clause 2.2 of GCC (Law governing the contract and court jurisdiction) stands revised as follows:

"The contract shall be governed by the Law for the time being in force in the Republic of India. **Subject to Clause 2.21.1 or 2.21.2 of this Contract**, the Civil Court having original Civil Jurisdiction at Delhi for PSNR, at Kolkata for PSER, at Nagpur for PSWR and at Chennai for PSSR, shall alone have exclusive jurisdiction in regard to all **matters** in respect of the Contract."

11. Clause 2.21 of GCC (Arbitration clause)

Clause 2.21 of GCC is re-titled as 'ARBITRATION' and shall be replaced by following:

2.21 ARBITRATION

2.21.1 If any dispute or differences of any kind whatsoever shall arise between BHEL and the contractor, arising out of the contract for the performance of the work whether during the progress of termination, abandonment or breach of the contract, it shall in the first place be referred to and settled by the Designated Engineer (nominated by BHEL for settlement of the disputes arising out of this contract) who within a reasonable period after being requested shall give written notice of his decision to the contractor. Save as hereinafter provided, such decision in respect of every matter so referred shall forthwith be given effect to by the contractor who shall proceed with the work with all due diligence, whether he or BHEL required arbitration as hereinafter provided or not.

2.21.2 If after the Designated Engineer has given written notice of this decision to the party, no claim to arbitration has been communicated to him by the party within 30 days from the receipt of such notice, the said decision shall become final and binding on the parties. In the event the contractor being dissatisfied with any such decision or if amicable settlement can not be reached then all such disputed issues shall be referred to the sole arbitration of the person appointed by BHEL.

2.21.3 Except as provided elsewhere in this Contract, in case amicable settlement is not reached between the Parties, in respect of any dispute or difference; arising out of the formation, breach, termination, validity or execution of the Contract; or, the respective rights and liabilities of the Parties; or, in relation to interpretation of any provision of the Contract; or, in any manner touching upon the Contract, then, either Party may, by a notice in writing to the other Party refer such dispute or difference to the sole arbitration of an arbitrator appointed by Head of the BHEL Power Sector Region issuing the Contract. It shall not be open to the Contractor to object to such arbitrator only on the ground that such arbitrator is an employee/ex-employee of BHEL or has dealt with or has expressed any opinion on any issue touching upon the Contract.

The Arbitrator shall pass a reasoned award and the award of the Arbitrator shall be final and binding upon the Parties.

Subject as aforesaid, the provisions of Arbitration and Conciliation Act 1996 (India) or statutory modifications or re-enactments thereof and the rules made thereunder and for the time being in force shall apply to the arbitration proceedings under this clause. The seat of arbitration shall be Kolkata.

2.21.4 In case of Contract with Public Sector Enterprise (PSE) or a Government Department, the following shall be applicable:

In the event of any dispute or difference relating to the interpretation and application of the provisions of the Contract, such dispute or difference shall be referred by either Party for arbitration to the sole arbitrator in the Department of Public Enterprises to be nominated by the Secretary to the Government of India in-charge of the Department of Public Enterprises. The Arbitration and Conciliation Act, 1996 shall not be applicable to arbitration under this clause. The award of the arbitrator shall be binding upon the Parties to the dispute, provided, however, any Party aggrieved by such award may make further reference for setting aside or revision of the award to the Law

Secretary, Department of Legal Affairs, Ministry of Law and Justice, Government of India. Upon such reference the dispute shall be decided by the Law Secretary or the Special Secretary or Additional Secretary when so authorized by the Law Secretary, whose decision shall bind the Parties hereto finally and conclusively.

2.21.5 The cost of arbitration shall be borne equally by the Parties.

2.21.6 Notwithstanding the existence or any dispute or differences and/or reference for the arbitration, the Contractor shall proceed with and continue without hindrance the performance of its obligations under this Contract with due diligence and expedition in a professional manner.

12. Clause 2.24 of GCC (Performance Guarantee for Workmanship)

Term "**Special** Conditions of Contract" appearing in 3rd line of the current clause 2.24.1, is replaced by "**Technical** Conditions of Contract"

13. Clause no. 2.7.2 and 2.7.3 of Volume-IB-GCC shall be revised as follows:

2.7.2 To terminate the contract or withdraw portion of work and get it done through other agency, at the risk and cost of the contractor after due notice of a period of 14 days' by BHEL in any of the following cases:

- i). Contractor's poor progress of the work vis-à-vis execution timeline as stipulated in the Contract, backlog attributable to contractor including unexecuted portion of work does not appear to be executable within balance available period considering its performance of execution.
- ii). Withdrawal from or abandonment of the work by contractor before completion of the work as per contract.
- iii). Non-completion of work by the Contractor within scheduled completion period as per Contract or as extended from time to time, for the reasons attributable to the contractor.
- iv). Termination of Contract on account of any other reason (s) attributable to Contractor.
- v). Assignment, transfer, subletting of Contract without BHEL's written permission.
- vi). Non-compliance to any contractual condition or any other default attributable to Contractor.

Risk & Cost Amount against Balance Work:

Risk & Cost amount against balance work shall be calculated as follows:

$$\text{Risk \& Cost Amount} = [(A-B) + (A \times H/100)]$$

Where,

A= Value of Balance scope of Work (*) as per rates of new contract

B= Value of Balance scope of Work (*) as per rates of old contract being paid to the contractor at the time of termination of contract i.e. inclusive of PVC & ORC, if any.

H = Overhead Factor to be taken as 5

In case (A-B) is less than 0 (zero), value of (A-B) shall be taken as 0 (zero).

* Balance scope of work (in case of termination of contract):

Difference of Contract Quantities and Executed Quantities as on the date of issue of Letter for 'Termination of Contract', shall be taken as balance scope of Work for calculating risk & cost amount.

Contract quantities are the quantities as per original contract. If, Contract has been amended, quantities as per amended Contract shall be considered as Contract Quantities.

Items for which total quantities to be executed have exceeded the Contract Quantities based on drawings issued to contractor from time to time till issue of Termination letter, then for these items total Quantities as per issued drawings would be deemed to be contract quantities.

Substitute/ extra items whose rates have already been approved would form part of contract quantities for this purpose. Substitute/ extra items which have been executed but rates have not been approved, would also form part of contract quantities for this purpose and rates of such items shall be determined in line with contractual provisions.

However, increase in quantities on account of additional scope in new tender shall not be considered for this purpose.

NOTE: In case portion of work is being withdrawn at risk & cost of contractor instead of termination of contract, contract quantities pertaining to portion of work withdrawn shall be considered as 'Balance scope of work' for calculating Risk & Cost amount.

LD against delay in executed work in case of Termination of Contract:

LD against delay in executed work shall be calculated in line with LD clause no. 2.7.9 of GCC, for the delay attributable to contractor. For limiting the maximum value of LD, contract value shall be taken as Executed Value of work till termination of contract.

Method for calculation of "LD against delay in executed work in case of termination of contract" is given below.

- i). Let the time period from scheduled date of start of work till termination of contract excluding the period of Hold (if any) not attributable to contractor = T1
- ii) Let the value of executed work till the time of termination of contract= X
- iii) Let the Total Executable Value of work for which inputs/fronts were made available to contractor and were planned for execution till termination of contract = Y
- iv) Delay in executed work attributable to contractor i.e. $T2 = [1 - (X/Y)] \times T1$
- v) LD shall be calculated in line with LD clause (clause 2.7.9) of the Contract for the delay attributable to contractor taking "X" as Contract Value and "T2" as period of delay attributable to contractor.

In case Contractor fails to deploy the resources as per requirement, BHEL can deploy own/hired/otherwise arranged resources at the risk and cost of the contractor and recover the expenses incurred from the dues payable to contractor. Recoveries shall be actual expenses incurred plus 5% overheads or as defined in TCC.

2.7.3 Recoveries arising out of Risk & Cost and LD or any other recoveries due from Contractor

Following sequence shall be applicable for recoveries from contractor:

- a) Dues available in the form of Bills payable to contractor, SD, BGs against the same contract.
- b) Demand notice for deposit of balance recovery amount shall be sent to contractor, if funds are insufficient to effect complete recovery against dues indicated in (a) above.
- c) If contractor fails to deposit the balance amount to be recovered within the period as prescribed in demand notice, following action shall be taken for balance recovery:
 - i) Dues payable to contractor against other contracts in the same Region shall be considered for recovery.
 - ii) If recovery cannot be made out of dues payable to the contractor as above, balance amount to be recovered, shall be informed to other Regions/Units for making recovery from the Unpaid Bills/Running Bills/SD/BGs/Final Bills of contractor.
 - iii) In-case recoveries are not possible with any of the above available options, Legal action shall be initiated for recovery against contractor.

14. Clause 4.2.1.7 of Special Condition of Contract (SCC)

At the end of Clause 4.2.1.7 (i.e. after the line "Decision of BHEL shall be final and binding on the contractor") following para is to be added

"It is not obligatory on the part of BHEL to provide any tools and tackles or other materials other than those specifically agreed to do so by BHEL. However, depending upon the availability, BHEL /BHEL's Customer handling equipment and other plants may be made available to the contractor on payment of hire charges as fixed, subject to the conditions laid down by BHEL/Customer from time to time. Unless paid in advance, such hire charges, if applicable, shall be recovered from contractor's bill / security deposit or any other due payment in one installment."

15. Clause 9.61 of SCC (NON-COMPLIANCE)

Under NON-COMPLIANCE, at the end of Clause 9.61 (i.e. **after the line** "Also the amount will be spent for purchasing the safety appliances and supporting the safety activity at site.") following para is to be added:

"In case of any financial deduction made by Customer for lapses of safety other than what is provided above or elsewhere in the contract, the same shall be charged on back-to-back basis on the defaulting contractor without prejudice to any other right spelt anywhere in the tender / contract"

16. Clause 9.0 & 9.1 of SCC (HSE & OHSAS Obligations)

Cl. no. 9.0	No change
Cl. no. 9.1	HSE (Health, safety & Environment): Contractor will comply with HSE (Health, safety & Environment) requirements of BHEL as per "HSE Plan for Site Operations by Sub-contractors" (Document no. HSEP:14, Rev.00) attached with this tender.

18. Introduction of Clause No. 1.10.8 in GCC as below:

Clause No 1.10.8: SDBG to be furnished by the vendor before start of work. No payment will be released till SDBG is submitted by the vendor.

If requested by the vendor, cash recovery equivalent to SDBG value to be made from bills submitted by the vendor.

Also recovery of interest calculated @SBI PLR +2% on amount equivalent to SDBG / PBG value to be made for the gap period (difference between date of start of work and date of submission of BG / cash recovery).

In case of delay in extension of SDBG, in case of validity expiry, SDBG shall be invoked. However, if the vendor submits a new BG after invocation of the previous BG then, it shall be refunded and recovery for the gap period, i.e. the duration for which BG is not available shall be made as stated above.

Annexure -C**Certificate by Chartered Accountant on letter head**

This is to to Certify that M/S,
 (hereinafter referred to as 'company') having its registered office at
 is registered under MSMED Act 2006, (Entrepreneur
 Memorandum No (Part-II) dtd:.....,
 Category:..... (Micro/Small)). (Copy enclosed).

Further verified from the Books of Accounts that the investment of the company as per the latest audited financial year as per MSMED Act 2006 is as follows:

1. **For Manufacturing Enterprises:** Investment in plant and machinery (i.e. original cost excluding land and building and the items specified by the Ministry of Small Scale Industries vide its notification No.S.0.1722(E) dated October 5, 2006 :
 Rs.....Lacs
2. **For Service Enterprises:** Investment in equipment (original cost excluding land and building and furniture, fittings and other items not directly related to the service rendered or as may be notified under the MSMED Act, 2006:
 Rs.....Lacs

(Strike off whichever is not applicable)

The above investment of Rs.....Lacs is within permissible limit of Rs.....Lacs forMicro I Small (Strike off which is not applicable) Category under MSMED Act 2006.

Or

The company has been graduated from its original category {Micro/ Small} (Strike off which is not applicable) and the date of graduation of such enterprise from its original category is (dd/mm/yyyy) which is within the period of 3 years from the date of graduation of such enterprise from its original category as notified vide S.O. No. 3322(E) dated 01.11.2013 published in the gazette notification dated 04.11.2013 by Ministry of MSME.

Date:

(Signature)

Name-

Membership number-

Seal of Chartered Accountant

Annexure –E**Guidelines/ rules for Bank Guarantee submission by Foreign vendor**

As per tender provision Bank Guarantees shall be furnished by the contractor from scheduled Banks/ Public Financial Institutions in line with the following guidelines/rules for acceptance of the BG:

- I. In case of Bank Guarantees submitted by the Foreign Vendors-**
- a)** From Nationalized/ Public sector/ Private Sector/ Foreign Banks (BG issued by Branches in India) can be accepted subject to the condition that the Bank Guarantee should be enforceable in the town/city or at nearest branch where the unit is located i.e. Demand can be presented at the Branch Located in the town / city or at nearest branch where the unit is located.
 - b)** From Foreign Banks (wherein Foreign Vendors intend to provide BG from local branch of the Vendor country's Bank)
 - b.1)** In such cases, Bank Guarantee issued by any of the Consortium Banks only will be accepted by BHEL. As such, Foreign Vendor needs to make necessary arrangements for issuance of Counter – Guarantee by Foreign Bank in favour of the Indian Bank (BHEL's Consortium Bank)(List of BHEL's Consortium Bank is given below). It is advisable that all charges for issuance of Bank Guarantee/ counter- Guarantee should be borne by the Foreign Vendor.
 - b.2)** In case, Foreign Vendors intend to provide BG from Overseas Branch of our Consortium Bank, the same is acceptable. However, the procedure at sl.no. b.1 will required to be followed.
 - b.3)** The BG issued may preferably be subject to Uniform Rules for Demand Guarantees (URDG) 758 (as amended from time to time).
 - b.4)** The BG should clearly specify that the demand or other document can be presented in electronic form.
- II. Currency of BG shall be the currency indicated in the Letter of Intent (LOI).**

List of Consortium Banks					
	Nationalised Bank		Nationalised Bank		Foreign bank
1	Allahabad bank	13	State Bank of Hyderabad	21	CITI Bank N.A
2	Andhra bank	14	Syndicate Bank	22	Deutsche Bank AG
3	Bank of Baroda	15	State Bank of Travancore	23	The Hongkong and Shanghai Banking Corporation Limited
4	Canara Bank	16	UCO Bank	24	Standard Chartered Bank
5	Corporation bank	17	Union Bank of India	25	J P Morgan
6	Central bank	18	United Bank of India		Private bank
7	Indian Bank	19	Vijaya Bank	26	Axis Bank
8	Indian Oversea Bank			27	The Federal Bank Limited
9	Oriental bank of Commerce		Public Sector Banks	28	HDFC
10	Punjab National Bank	20	IDBI	29	Kotak Mahindra Bank
11	Punjab & Sindh Bank			30	ICICI
12	State Bank of India			31	Indusind Bank
				32	Yes Bank

Annexure- CPP-GST/I**Please arrange to submit this filled-up format along with Tender**

Name of the Company	
Address of Company*	
Company Registration Number*	
Name of Partners / Directors	
ALL THE STATES WHERE BIDDER HAS A PLACE OF BUSINESS*	
ALL ADDRESS OF VENDOR MENTIONING THEIR PIN AS PER THE LATEST GST REGISTRATION*	
GSTN OF ALL THE ABOVE NOTED PLACES OF VENDOR*	
Bidder Type: Indian/ Foreign*	
City*	
State*	
Country*	
Postal Code*	
PAN/TAN Number*	
Company's Establishment Year	
Company's Nature of Business*	
Company's Legal Status* {limited /undertaking/joint venture/partnership/other}	
Company Category* {micro unit as per MSME/small unit as per MSME/medium unit as per MSME/ UAN as per Udyog Aadhaar Memorandum/ Ancillary unit/project affected person of this company/ssi/ other}	
Relevant documents to be submitted as applicable.	
Enter Company's Contact Person Details	
Title(Mr. / Mrs. / Ms. / Dr. / Shri)*	
Contact Name*	
Date Of Birth*	
Correspondence Email*	
(Correspondence Email ID can be same as your Login ID. All the mail correspondence will be sent only to the Correspondence Email ID.)	
Designation	
Phone*	
Fax*	
Mobile*	

ON BIDDER'S LETTER HEAD

Certificate of Declaration for Confirming the Knowledge of Site Conditions, Laws and Regulations

We, _____ hereby declare and confirm that we have visited the project site under the subject namely Project Site of 2 x 660 MW MAITREE SUPER THERMAL POWER PROJECT which is located in Moithara Village, Rampal Upazila, Bagerhat District, Bangladesh and acquired full knowledge and information about the site condition, wages structure, industrial climate and total work involved.

We confirm to agree and acknowledge that we are fully aware of all the Applicable Laws and Regulations applicable in Project Site in Bangladesh including the Bangladesh Labor Act 2006 and the Bangladesh Labor Rules 2015. We further confirm to ensure our respective employees, servants, consultants and agents abide by the all Applicable Laws (i) relating to the performance of the Work (ii) by all rules and regulation of those Governmental Authorities who have control or jurisdiction over the Site or the countries where we may reside or perform work, directly or indirectly under this Contract (including the timely payment of any or all fees, assessments or other governmental charges and registrations with relevant agencies or other Governmental Authorities required in connection therewith) and (iii) with the terms and conditions of any Authorizations.

We further confirm that the above information is true and correct and we will not raise any claim of any nature due to lack of knowledge of site conditions and Laws and Regulations.

Bidder's Name and Address

(Signature of the Bidder's with Seal)

Place :

Dated :

Bharat Heavy Electricals Limited		
Power Sector - Eastern Region, Kolkata		
TENDER NO: Ref: BHEL: MSTPP: C- RW: CSD: 22:10:06		
VOLUME-IB	GENERAL CONDITIONS OF CONTRACT (SERVICE)	

TABLE OF CONTENTS

1. Chapter-1: General Instructions to Tenderers

- 1.1. Dispatch Instructions
- 1.2. Submission of Tenders
- 1.3. Language
- 1.4. Price Discrepancy
- 1.5. Qualification of Tenderers
- 1.6. Evaluation of Bids
- 1.7. Data to be enclosed
- 1.8. Authorization and Attestation
- 1.9. Earnest Money Deposit
- 1.10. Security Deposit
- 1.11. Return of Security Deposit
- 1.12. Bank Guarantee
- 1.13. Validity of offer
- 1.14. Execution of Contract Agreement
- 1.15. Rejection of Tender and other Conditions

2. Chapter-2

- 2.1. Definitions
- 2.2. Law Governing Contract and Court Jurisdiction
- 2.3. Issue of Notice
- 2.4. Use of land
- 2.5. Commencement of Work

Bharat Heavy Electricals Limited		
Power Sector - Eastern Region, Kolkata		
TENDER NO: Ref: BHEL: MSTPP: C- RW: CSD: 22:10:06		
VOLUME-IB	GENERAL CONDITIONS OF CONTRACT (SERVICE)	

- 2.6. Measurement of Work and Mode of Payment
- 2.7. Rights of BHEL
- 2.8. Responsibilities of Contractor in respect of Local Laws, Employment of Workers etc
- 2.9. Progress Monitoring, Monthly Review and Performance Evaluation
- 2.10. Time of Completion
- 2.11. Extension of Time for Completion
- 2.12. Over Run Compensation
- 2.13. Interest Bearing Recoverable Advances
- 2.14. Quantity Variation
- 2.15. Extra Works
- 2.16. Supplementary Items
- 2.17. Price Variation Clause
- 2.18. Insurance
- 2.19. Strikes & Lockout
- 2.20. Force Majeure
- 2.21. Arbitration and Reconciliation
- 2.22. Retention Amount
- 2.23. Payments
- 2.24. Performance Guarantee for Workmanship
- 2.25. Closing of Contracts
- 2.26. Reverse Auction
- 2.27. Suspension of Business Dealings
- 2.28. Other Issues

Bharat Heavy Electricals Limited		
Power Sector - Eastern Region, Kolkata		
TENDER NO: Ref: BHEL: MSTPP: C- RW: CSD: 22:10:06		
VOLUME-IB	GENERAL CONDITIONS OF CONTRACT (SERVICE)	

CHAPTER -1

1. GENERAL INSTRUCTION TO TENDERERS

1.1. DISPATCH INSTRUCTION

- i) The General Conditions of Contract form part of the Tender specifications. **All pages of the tender documents shall be duly signed, stamped and submitted along with the offer in token of complete acceptance thereof.** The information furnished shall be complete by itself. The tenderer is required to furnish all the details and other documents as required in the following pages
- ii) Tenderers are advised to study all the tender documents carefully. Any submission of tender by the tenderer shall be deemed to have been done after careful study and examination of the tender documents and with the full understanding of the implications thereof. Should the tenderers have any doubt about the meaning of any portion of the Tender Specification or find discrepancies or omissions in the drawings or the tender documents issued are incomplete or shall require clarification on any of the technical aspect, the scope of work etc., he shall at once, contact the authority inviting the tender well in time (so as not to affect last date of submission) for clarification before the submission of the tender. Tenderer's request for clarifications shall be with reference to Sections and Clause numbers given in the tender documents. The specifications and terms and conditions shall be deemed to have been accepted by the tenderer in his offer. Non-compliance with any of the requirements and instructions of the tender enquiry may result in the rejection of the tender.
- iii) Integrity pact (IP) shall be applicable for all tenders / contracts if indicated in NIT. This integrity pact shall be issued as part of the Tender documents and shall be returned by the bidder along with Techno-commercial bid duly filled, signed and stamped by the authorized signatory who signs the bid. Only those vendors / bidders who have entered into such an IP with BHEL shall be considered qualified to participate in the bidding. Entering into this pact shall be a preliminary qualification.

1.2. SUBMISSION OF TENDERS

- 1.2.1 The tenderers must submit their tenders to Officer inviting tender as per instructions in the NIT
- 1.2.2 Tenders submitted by post shall be sent by 'REGISTERED POST ACKNOWLEDGEMENT DUE / by COURIER' and shall be posted with due allowance for any postal/courier delays. BHEL takes no responsibility for delay, loss or non-receipt of tenders sent by post/courier. **The tenders received after the specified time of their submission are treated as 'Late Tenders' and shall not be considered under any circumstances.** Offers received by Fax/Email/Internet shall be considered as per terms of NIT.

Bharat Heavy Electricals Limited		
Power Sector - Eastern Region, Kolkata		
TENDER NO: Ref: BHEL: MSTPP: C- RW: CSD: 22:10:06		
VOLUME-IB	GENERAL CONDITIONS OF CONTRACT (SERVICE)	

- 1.2.3 Tenders shall be opened by authorized Officer of BHEL at his office at the time and date as specified in the NIT, in the presence of such of those tenderers or their authorized representatives who may be present
- 1.2.4 Tenderers whose bids are found techno commercially qualified shall be informed the date and time of opening of the Price Bids and such Tenderers may depute their representatives to witness the opening of the price bids. BHEL's decision in this regard shall be final and binding.
- 1.2.5 Before submission of Offer, the tenderers are advised to inspect the site of work and the environments and be well acquainted with the actual working and other prevalent conditions, facilities available, position of material and labour, means of transport and access to Site, accommodation, etc. No claim will be entertained later on the grounds of lack of knowledge of any of these conditions.
- 1.3. LANGUAGE**
- 1.3.1 The tenderer shall quote the rates in English language and international numerals. These rates shall be entered in figures as well as in words. For the purpose of the tenders, the metric system of units shall be used.
- 1.3.2 All entries in the tender shall either be typed or written legibly in ink. Erasing and over-writing is not permitted and may render such tenders liable for rejection. All cancellations and insertions shall be duly attested by the tenderer.
- 1.4 PRICE DISCREPANCY:**
- 1.4.1 **Conventional (Manual) Price Bid opening:** In the case of price bid opening without resorting to Reverse Auction, if there are differences between the rates given by the tenderer in words and figures or in amount worked out by him, the following procedure for evaluation and award shall be followed:
- i) When there is a difference between the rates in figures and in words, the rates which corresponds to the amounts worked out by the contractor, shall be taken as correct
 - ii) When the amount of an item is not worked out by the contractor or it does not correspond with the rate written either in figure or in words, then the rate quoted by the contractor in words shall be taken as correct
 - iii) When the rate quoted by the contractor in figures and words tallies but the amount is not worked out correctly, the rate quoted by the contractor shall be taken as correct and not the amount.
 - iv) In case of lumpsum price, if there is any difference between the amount in figures and in words, the amount quoted by the bidder in words shall be taken as correct.
 - v) In case of omission in quoting any rate for one or more items, the evaluation shall be done considering the highest quoted rate obtained against the respective items by other tenderers for the subject tender. If the tenderer becomes L-1, the notional rates for the omission items shall be the lowest rates quoted for the respective items by the other tenderers against the respective omission items for the subject job and the 'Total quoted price (loaded for omissions)' shall be arrived at. However, the overall price remaining the same as quoted originally, the rates for all the items in the 'Total quoted price (loaded for omissions)' shall be reduced item wise in proportion to the ratio of 'Original' total price and the 'Total quoted price (loaded for omissions)'
 - vi) The 'Final Total Amount' shall be arrived at after considering the amounts worked out in line with 'i' to 'iv' above.
- 1.4.2 **Reverse Auction:** In case of Reverse Auction, the successful bidder shall undertake to execute

Bharat Heavy Electricals Limited		
Power Sector - Eastern Region, Kolkata		
TENDER NO: Ref: BHEL: MSTPP: C- RW: CSD: 22:10:06		
VOLUME-IB	GENERAL CONDITIONS OF CONTRACT (SERVICE)	

the work as per overall price offered by him during the Reverse Auction process. In case of omission of rates, the procedure shall be as per 'Guidelines for Reverse Auction' enclosed.

1.5. QUALIFICATION OF TENDERERS

- i) Only tenderers who have previous experience in the work of the nature and description detailed in the Notice Inviting Tender and/or tender specification are expected to quote for this work duly detailing their experience along with offer.
- ii) Offers from tenderers who do not have proven and established experience in the field shall not be considered
- iii) Offers from tenderers who are under suspension (banned) by any Unit/Region/Division of BHEL shall not be considered.
- iv) Offers from tenderers who do not comply with the latest guidelines of Ministry/Commissions of Govt of India shall not be considered.

1.6. EVALUATION OF BIDS

- i) Technical Bids submitted by the tenderer will be opened first and evaluated for fulfilling the Pre-Qualification criteria and other conditions in NIT/Tender documents, based on documentary evidences submitted along with the offer
- ii) In case the same qualifying experience is claimed by more than one agency, then the agency who has executed the work as per documentary evidence submitted shall only be qualified. Scope of qualifying work should be totally with the agency who has executed and in case it is only labour+consumables without T&P, then the responsibility of execution is assigned to the first agency and not to the agency who has executed only as labour supply contractor. Further, BHEL reserves the right to ask for further proofs including submission of TDS certificates for the said job
- iii) In case the qualifying experience is claimed by private organizations based on Work Order and completion certificates from another private organization, BHEL reserves the right to ask for further proofs including submission of TDS certificates for the said job
- iv) Assessing Bidder Capacity for executing the current tender shall be as per Notice Inviting Tender
- v) Price Bids of shortlisted bidders shall only be opened either through the conventional price bid opening or through electronic Reverse Auction, at the discretion of BHEL
- vi) Price Bids of unqualified bidders shall not be opened. Reasons for rejection shall be intimated in due course after issue of LOI/LOA to successful bidder and receipt of unqualified acceptance from the successful bidder
- vii) Bidders are advised to also refer to clause no 2.9.4 regarding evaluation of their performance in ongoing projects for the current tender

1.7. DATA TO BE ENCLOSED

Full information shall be given by the tenderer in respect of the following. Non-submission of this information may lead to rejection of the offer.

i) INCOME TAX PERMANENT ACCOUNT/TIN NUMBER

Certified copies of Permanent Account Numbers as allotted by Income Tax Department for the Company/Firm/Individual Partners, etc. shall be furnished along with tender.

ii) ORGANIZATION CHART

The organization chart of the tenderer's organization, including the names, addresses and contact

Bharat Heavy Electricals Limited		
Power Sector - Eastern Region, Kolkata		
TENDER NO: Ref: BHEL: MSTPP: C- RW: CSD: 22:10:06		
VOLUME-IB	GENERAL CONDITIONS OF CONTRACT (SERVICE)	

information of the Directors/Partners shall be furnished along with the offer.

- iii) An attested copy of the Power of Attorney, in case the tender is signed by an individual other than the sole proprietor
- iv) **IN CASE OF INDIVIDUAL TENDERER:**
His / her full name, address and place & nature of business.
- v) **IN CASE OF PARTNERSHIP FIRM**
The names of all the partners and their addresses, A copy of the partnership deed/instrument of partnership duly certified by the Notary Public shall be enclosed.
- vi) **IN CASE OF COMPANIES:**
 - a. Date and place of registration including date of commencement certificate in case of Public Companies (certified copies of Memorandum and articles of Association are also to be furnished).
 - b. Nature of business carried on by the Company and the provisions of the Memorandum relating thereof.

1.8 AUTHORIZATION AND ATTESTATION

Tenders shall be signed by a person duly authorized/empowered to do so. An attested copy of the Power of Attorney, in case the tender is signed by an individual other than the sole proprietor shall be submitted along with the tenders

1.9 EARNEST MONEY DEPOSIT

1.9.1 Every tender must be accompanied by the prescribed amount of Earnest Money Deposit (EMD) in the manner described herein.

- i) EMD shall be furnished along with the offer in full as per the amount indicated in the Special Conditions of Contract / NIT
- ii) EMD is to be paid in cash (as permissible under Income Tax Act), Pay order or Demand Draft in favour of 'Bharat Heavy Electricals Limited' and payable at Regional HQ issuing the tender.
- iii) No other form of EMD remittance shall be acceptable to BHEL
- iv) Bidder may opt to deposit "One Time EMD" of Rs. 2.0 lakhs (Rupees Two lakhs only) with BHEL:Power Sector Region HQ issuing the tender, which will enable them to participate in all the future tender enquiries in respect of Erection and Commissioning services issued from the respective office. Interested bidders may clearly send their consent for converting the present EMD into a "One Time EMD" in their offer.
 - Note : The 'One Time EMD' cannot be withdrawn by the tenderers within 3 years from the date of deposit, under any circumstances. The Tenderer who wishes to withdraw after three years will not be allowed to submit 'One Time EMD' again.
- v) Bidders who have already deposited such "One Time EMD" of Rs. 2.00 lakh are exempted from submission of EMD for this tender. However, a copy of 'One Time EMD' certificate issued by BHEL Regional HQ issuing the tender shall be enclosed along with the offer.

1.9.2 EMD by the bidder will be forfeited as per Tender Documents if

- i) After opening the tender, the bidder revokes his tender within the validity period or increases his

Bharat Heavy Electricals Limited		
Power Sector - Eastern Region, Kolkata		
TENDER NO: Ref: BHEL: MSTPP: C- RW: CSD: 22:10:06		
VOLUME-IB	GENERAL CONDITIONS OF CONTRACT (SERVICE)	

earlier quoted rates.

- ii) The bidder does not commence the work within the period as per LOI/Contract. In case the LOI / contract is silent in this regard then within 15 days after award of contract.

1.9.3 EMD shall not carry any interest.

1.9.4 In the case of unsuccessful bidders, the Earnest Money will be refunded to them within a reasonable time after acceptance of award by successful tenderer.

1.10 SECURITY DEPOSIT

1.10.1 Upon acceptance of Tender, the successful Tenderer should deposit the required amount of Security Deposit for satisfactory completion of work, as per the rates given below:

SN	Contract Value	Security Deposit Amount
1	Up to Rs. 10 lakhs	10% of Contract Value
2	Above Rs. 10 lakhs upto Rs.50 lakhs	1 lakh + 7.5% of the Contract Value exceeding Rs. 10 lakhs.
3	Above Rs. 50 lakhs	Rs 4 lakhs + 5% of the Contract Value exceeding Rs. 50 lakhs.

1.10.2 The security Deposit should be furnished before start of the work by the contractor.

1.10.3 Security Deposit may be furnished in any one of the following forms

- i) Cash (as permissible under the Income Tax Act)
- ii) Pay Order / Demand Draft in favor of BHEL.
- iii) Local cheques of scheduled banks, subject to realization.
- iv) Securities available from Post Offices such as National Savings Certificates, Kisan Vikas Patras etc. (Certificates should be held in the name of Contractor furnishing the security and duly pledged in favor of BHEL and discharged on the back).
- v) Bank Guarantee from Scheduled Banks / Public Financial Institutions as defined in the Companies Act. The Bank Guarantee format for Security Deposit shall be in the prescribed formats
- vi) Fixed Deposit Receipt issued by Scheduled Banks / Public Financial Institutions as defined in the Companies Act. The FDR should be in the name of the contractor, A/C BHEL, duly discharged on the back.
- vii) Security deposit can also be recovered at the rate of 10% from the running bills. However in such cases at least 50% of the Security Deposit should be deposited in any form as prescribed before start of the work and the balance 50% may be recovered from the running bills.
- viii) EMD of the successful bidder can be converted and adjusted against the cash portion of Security Deposit excepting for such bidders who have remitted One Time EMD.

NOTE: Acceptance of Security Deposit against Sl. No. (iv) and (vi) above will be subject to hypothecation or endorsement on the documents in favor of BHEL. However, BHEL will not be liable or responsible in any manner for the collection of interest or renewal of the documents or in any other matter connected therewith.

1.10.4 The Security Deposit shall not carry any interest.

Bharat Heavy Electricals Limited		
Power Sector - Eastern Region, Kolkata		
TENDER NO: Ref: BHEL: MSTPP: C- RW: CSD: 22:10:06		
VOLUME-IB	GENERAL CONDITIONS OF CONTRACT (SERVICE)	

1.10.5 In case the value of work exceeds / reduces from the awarded / accepted value, the Security Deposit shall be correspondingly enhanced / reduced as given below:

- i) The enhanced part of the Security Deposit shall be immediately deposited by the Contractor or adjusted against payments due to the Contractor.
- ii) There will be no reduction in Security Deposit value in case of variation in contract value upto the lower limit specified in Quantity variation clause. In case of reduction of contract value beyond the lower limit specified in Quantity Variation clause, then the Security Deposit shall be re adjusted in proportion.
- iii) In case of reduction, the reduced Contract value shall be certified by BHEL Construction Manager after ascertaining / freezing of BOQ / Drawings from the Design / Engineering Centre. The reduced Security Deposit value can only be considered after taking into account the adequacy of the securities held by BHEL to meet the liabilities of the contractor for the contract, and the performance of the contract in general. **In such cases, the revised value of Security Deposit shall be worked out only after execution of not less than the lower limit of the revised scope of work/contract value as per quantity variation clause, and as certified by Construction Manager. This reduction in value of Security Deposit shall not entitle the contractor to any amendment of Contract and shall be operated at the discretion of BHEL**
- iv) Contract value for the purpose of operating the reduced/increased value of Security Deposit due to Quantity Variation, shall be exclusive of Price Variation Clause, Over Run Compensation and Extra works done on man-day rates.

1.10.6 The validity of Bank Guarantees towards Security Deposit shall be initially upto the completion period as stipulated in the Letter of Intent/Award + 3 months, and the same shall be kept valid by proper renewal till the acceptance of Final Bills of the Contractor, by BHEL

1.10.7 BHEL reserves the right of forfeiture of Security Deposit in addition to other claims and penalties in the event of the Contractor's failure to fulfill any of the contractual obligations or in the event of termination of contract as per terms and conditions of contract. BHEL reserves the right to set off the Security Deposit against any claims of other contracts with BHEL.

Additional security deposit (SD) has to be submitted by the successful bidder with value as follows:

1.10.8 If the final price of successful bidder is lesser by 'more than 20%' of BHEL's estimate - 'Additional Security Deposit' will be required to be submitted by the successful bidder with value as follows:

Additional Security Deposit = 30 % of (A-B) limited to a maximum of 10% of the 'Total Price/Contract Value', where,

A = 80% of BHEL estimate

B = The final offered price of successful bidder.

OR

Sealed paper price bid of successful bidder (in case of paper bid)

This 'Additional Security Deposit' shall have the same validity as that of the 'Security Deposit' and shall be revalidated/released in the manner as spelt out for the 'Security Deposit' as per relevant clause of GCC. BHEL's estimated value shall be disclosed to the successful bidder (on their request) at appropriate juncture in case 'Additional Security Deposit' is applicable."

1.11 RETURN OF SECURITY DEPOSIT

Security Deposit shall be refunded/Bank Guarantee(s) released to the Contractor along with the 'Final Bill' after deducting all expenses / other amounts due to BHEL under the contract / other contracts entered into with them by BHEL.

Bharat Heavy Electricals Limited		
Power Sector - Eastern Region, Kolkata		
TENDER NO: Ref: BHEL: MSTPP: C- RW: CSD: 22:10:06		
VOLUME-IB	GENERAL CONDITIONS OF CONTRACT (SERVICE)	

1.12 BANK GUARANTEES

Where ever Bank Guarantees are to be furnished/submitted by the contractor, the following shall be complied with

- i) Bank Guarantees shall be from Scheduled Banks / Public Financial Institutions as defined in the Companies Act.
- ii) The Bank Guarantees shall be as per prescribed formats.
- iii) It is the responsibility of the bidder to get the Bank Guarantees revalidated/extended for the required period (subject to a minimum period of six months), as per the advice of BHEL Site Engineer / Construction Manager. BHEL shall not be liable for issue of any reminders regarding expiry of the Bank Guarantees.
- iv) In case extension/further extensions of any Bank Guarantees are not required, the bidders shall ensure that the same is explicitly endorsed by the Construction Manager and submitted to the Regional HQ issuing the LOI/LOA.
- v) In case the Bank Guarantees are not extended before the expiry date, BHEL reserves the right to invoke the same by informing the concerned Bank in writing, without any advance notice/communication to the concerned bidder.
- vi) Bidders to note that any corrections to Bank Guarantees shall be done by the issuing Bank, only through an amendment in an appropriate non-judicial stamp paper.
- vii) The Original Bank Guarantee shall be sent directly by the Bank to BHEL under Registered Post (Acknowledgement Due), addressed to the Subcontracting Department of the respective Region.

Bharat Heavy Electricals Limited		
Power Sector - Eastern Region, Kolkata		
TENDER NO: Ref: BHEL: MSTPP: C- RW: CSD: 22:10:06		
VOLUME-IB	GENERAL CONDITIONS OF CONTRACT (SERVICE)	

1.13 EXECUTION OF CONTRACT AGREEMENT

The successful tenderer's responsibility under this contract commences from the date of issue of the Letter of Intent by Bharat Heavy Electricals Limited. The Tenderer shall submit an unqualified acceptance to the Letter of Intent/Award within the period stipulated therein.

The successful tenderer shall be required to execute an agreement in the prescribed form, with BHEL, within a reasonable time after the acceptance of the Letter of Intent/Award, and in any case before releasing the first running bill. The contract agreement shall be signed by a person duly authorized/empowered by the tenderer. The expenses for preparation of agreement document shall be borne by BHEL

1.14 REJECTION OF TENDER AND OTHER CONDITIONS

1.14.1 The acceptance of tender will rest with BHEL which does not bind itself to accept the lowest tender or any tender and reserves to itself full rights for the following without assigning any reasons whatsoever: -

- a. To reject any or all of the tenders.
- b. To split up the work amongst two or more tenderers as per NIT
- c. To award the work in part if specified in NIT
- d. In case of either of the contingencies stated in (b) and (c) above, the time for completion as stipulated in the tender shall be applicable.

1.14.2 Conditional tenders, unsolicited tenders, tenders which are incomplete or not in the form specified or defective or have been materially altered or not in accordance with the tender

Bharat Heavy Electricals Limited		
Power Sector - Eastern Region, Kolkata		
TENDER NO: Ref: BHEL: MSTPP: C- RW: CSD: 22:10:06		
VOLUME-IB	GENERAL CONDITIONS OF CONTRACT (SERVICE)	

- conditions, specifications etc., are liable to be rejected.
- 1.15.3 Tenders are liable to be rejected in case of unsatisfactory performance of the tenderer with BHEL, or tenderer under suspension (hold/banning /delisted) by any unit / region / division of BHEL or tenderers who do not comply with the latest guidelines of Ministry/Commissions of Govt of India. BHEL reserves the right to reject a bidder in case it is observed that they are overloaded and may not be in a position to execute this job as per the required schedule in line with clause no. 7.0 of the 'NIT'. The decision of BHEL will be final in this regard.
- 1.15.4 If a tenderer who is a proprietor expires after the submission of his tender or after the acceptance of his tender, BHEL may at their discretion, cancel such tender. If a partner of a firm expires after the submission of tender or after the acceptance of the tender, BHEL may then cancel such tender at their discretion, unless the firm retains its character.
- 1.15.5 BHEL will not be bound by any Power of Attorney granted by changes in the composition of the firm made subsequent to the execution of the contract. They may, however, recognize such power of Attorney and changes after obtaining proper legal advice, the cost of which will be chargeable to the contractor concerned.
- 1.15.6 If the tenderer deliberately gives wrong information in his tender, BHEL reserves the right to reject such tender at any stage or to cancel the contract if awarded and forfeit the Earnest Money/Security Deposit/any other money due.
- 1.15.7 Canvassing in any form in connection with the tenders submitted by the Tenderer shall make his offer liable to rejection.
- 1.15.8 In case the Proprietor, Partner or Director of the Company/Firm submitting the Tender, has any relative or relation employed in BHEL, the authority inviting the Tender shall be informed of the fact as per specified format, along with the Offer. Failing to do so, BHEL may, at its sole discretion, reject the tender or cancel the contract and forfeit the Earnest Money/Security Deposit.
- 1.15.9 The successful tenderer should not sub-contract part or complete work detailed in the tender specification undertaken by him without written permission of BHEL's Construction Manager/Site In charge. The tenderer is solely responsible to BHEL for the work awarded to him.
- 1.15.10 The Tender submitted by a techno commercially qualified tenderer shall become the property of BHEL who shall be under no obligation to return the same to the bidder. However unopened price bids and late tenders shall be returned to the bidders
- 1.15.11 Unsolicited discount received after the due date and time of Bid Submission shall not be considered for evaluation. However, if the party who has submitted the unsolicited discount/rebate becomes the L-1 party, then the awarded price i.e. contract value shall be worked out after considering the discount so offered.
- 1.15.12 BHEL shall not be liable for any expenses incurred by the bidder in the preparation of the tender irrespective of whether the tender is accepted or not.

Bharat Heavy Electricals Limited		
Power Sector - Eastern Region, Kolkata		
TENDER NO: Ref: BHEL: MSTPP: C- RW: CSD: 22:10:06		
VOLUME-IB	GENERAL CONDITIONS OF CONTRACT (SERVICE)	

CHAPTER-2

2.1 **DEFINITION:** The following terms shall have the meaning hereby assigned to them except where the context otherwise requires

- i) BHEL shall mean Bharat Heavy Electricals Limited (of the respective Power Sector Region inviting the Tender), a company registered under Indian Companies Act 1956, with its Registered Office at BHEL HOUSE, SIRI FORT, NEW DELHI – 110 049, or its Power Sector Regional Offices or its Authorized Officers or its Site Engineers or other employees authorized to deal with any matters with which these persons are concerned on its behalf.
- ii) “EXECUTIVE DIRECTOR” or ‘GROUP GENERAL MANAGER’ or “GENERAL MANAGER (In charge)” or “GENERAL MANAGER” shall mean the Officer in Administrative charge of the respective Power Sector Region.
- iii) “COMPETENT AUTHORITY” shall mean Executive Director or Group General Manager or General Manager (In charge) or General Manager or BHEL Officers who are empowered to act on behalf of the Executive Director or General Manager (In charge) or General Manager of BHEL.
- iv) “ENGINEER” or “ENGINEER IN CHARGE” shall mean an Officer of BHEL as may be duly appointed and authorized by BHEL to act as “Engineer” on his behalf for the purpose of the Contract, to perform the duty set forth in this General Conditions of Contract and other Contract documents. The term also includes ‘CONSTRUCTION MANAGER’ or ‘SITE IN CHARGE’ as well as Officers at Site or at the Headquarters of the respective Power Sector Regions.
- v) “SITE” shall mean the places or place at which the plants/equipment are to be erected and services are to be performed as per the specification of this Tender.
- vi) “CLIENT OF BHEL” or “CUSTOMER” shall mean the project authorities with whom BHEL has entered into a contract for supply of equipment or provision of services.
- vii) “CONTRACTOR” shall mean the successful Bidder/Tenderer who is awarded the Contract and shall include the Contractor’s successors, heirs, executors, administrators and permitted assigns.
- viii) “CONTRACT” or “CONTRACT DOCUMENT” shall mean and include the Agreement of Work Order, the accepted appendices of Rates, Schedules, Quantities if any, General Conditions of Contract, Special Conditions of Contract, Instructions to the Tenderers, Drawings, Technical Specifications, the Special Specifications if any, the Tender documents, subsequent amendments mutually agreed upon and the Letter of Intent/Acceptance issued by BHEL. Any conditions or terms stipulated by the contractor in the tender documents or subsequent letters shall not form part of the contract unless, specifically accepted in writing by BHEL in the Letter of Intent/Award and incorporated in the agreement.
- ix) “GENERAL CONDITIONS OF CONTRACT” shall mean the ‘Instructions to Tenderers’ and ‘General Conditions of Contract’ pertaining to the work for which above tenders have been called for.

Bharat Heavy Electricals Limited		
Power Sector - Eastern Region, Kolkata		
TENDER NO: Ref: BHEL: MSTPP: C- RW: CSD: 22:10:06		
VOLUME-IB	GENERAL CONDITIONS OF CONTRACT (SERVICE)	

x)	“TENDER SPECIFICATION” or “TENDER” or “TENDER DOCUMENTS” shall mean General Conditions, Common Conditions, Special Conditions, Price Bid, Rate Schedule, Technical Specifications, Appendices, Annexures, Corrigendum, Amendments, Forms, procedures, Site information, etc. and drawings/documents pertaining to the work for which the tenderers are required to submit their offers. Individual specification number will be assigned to each Tender Specification.
xi)	“LETTER OF INTENT” shall mean the intimation by a Letter/Fax/email to the tenderer that the tender has been accepted in accordance with provisions contained in the letter. The responsibility of the contractor commences from the date of issue of this letter and all terms and conditions of the contract are applicable from this date.
xii)	“COMPLETION TIME” shall mean the period by ‘date/month’ specified in the ‘Letter of Intent/Award’ or date mutually agreed upon for handing over of the intended scope of work, the erected equipment/plant which are found acceptable by the Engineer, being of required standard and conforming to the specifications of the Contract.
xiii)	“PLANT” shall mean and connote the entire assembly of the plant and equipment covered by the contract.
xiv)	“EQUIPMENT” shall mean equipment, machineries, materials, structural, electricals and other components of the plant covered by the contract.
xv)	“TESTS” shall mean and include such test or tests to be carried out on the part of the contractor as are prescribed in the contract or considered necessary by BHEL, in order to ascertain the quality, workmanship, performance and efficiency of the contractor or part thereof.
xvi)	“APPROVED”, “DIRECTED” or “INSTRUCTED” shall mean approved, directed or instructed by BHEL.
xvii)	“WORK or CONTRACT WORK” shall mean and include supply of all categories of labour, specified consumables, tools and tackles and Plants required for complete and satisfactory site transportation, handling, stacking, storing, erecting, testing and commissioning of the equipments to the entire satisfaction of BHEL.
xviii)	“SINGULAR AND PLURALS ETC.” words carrying singular number shall also include plural and vice versa, where the context so requires. Words imparting the masculine Gender shall be taken to include the feminine Gender and words imparting persons shall include any Company or Associations or Body of Individuals, whether incorporated or not.
xix)	“HEADING” – The heading in these General Conditions are solely for the purpose of facilitating reference and shall not be deemed to be part thereof or be taken as instructions thereof or of the contract.
xx)	“MONTH” shall mean calendar month unless otherwise specified in the Tender.

Bharat Heavy Electricals Limited		
Power Sector - Eastern Region, Kolkata		
TENDER NO: Ref: BHEL: MSTPP: C- RW: CSD: 22:10:06		
VOLUME-IB	GENERAL CONDITIONS OF CONTRACT (SERVICE)	

xxi)	Day' or 'Days' unless herein otherwise expressly defined shall mean calendar day or days of twenty-four (24) hours each. A week shall mean continuous period of seven (7) days.
xxii)	“COMMISSIONING” shall mean the synchronization testing and achieving functional operation of the Equipment with associated system after all initial adjustments, trials, cleaning, re-assembly required at site if any, have been completed and Equipment with associated system is ready for taking into service.
xxiii)	“WRITING” shall include any manuscript type written or hand written or printed statement or electronically transmitted messages, under the signature or seal or transmittal of BHEL.
xxiv)	“TEMPORARY WORK” shall mean all temporary works for every kind required in or for the execution, completion, maintenance of the work.
xxv)	‘CONTRACT PRICE’ or ‘CONTRACT VALUE’ shall mean the sum mentioned in the LOI/LOA/Contract Agreement subject to such additions thereto or deductions there from as may be made under provisions hereinafter contained
xxvi)	“COMMENCEMENT DATE” or “START DATE” shall mean the commencement/start of work at Site as per terms defined in the Tender
xxvii)	“SHORT CLOSING” or “FORE CLOSING” of Contract shall mean the premature closing of Contract, for reasons not attributable to the contractor and mutually agreed between BHEL and the contractor
xxviii)	“TERMINATION” of Contract shall mean the pre mature closing of contract due to reasons as mentioned in the contract
xxix)	“DE MOBILIZATION” shall mean the temporary winding up of Site establishment by Contractor leading to suspension of works temporarily for reasons not attributable to the contractor
xxx)	“RE MOBILIZATION” shall mean the resumption of work with all resources required for the work after demobilization.
2.2	LAW GOVERNING THE CONTRACT AND COURT JURISDICTION
	The contract shall be governed by the Law for the time being in force in the Republic of India. The Civil Court having original Civil Jurisdiction at Delhi for PSNR, at Kolkata for PSER, at Nagpur for PSWR and at Chennai for PSSR, shall alone have exclusive jurisdiction in regard to all claims in respect of the Contract. No other Civil Court shall have jurisdiction in case of any dispute, under this contract
2.3	ISSUE OF NOTICE
2.3.1	<u>Service of notice on contractor</u> Any notice to be given to the Contractor under the terms of the contract shall be served by sending the same by Registered Post / Speed Post to or leaving the same at the Contractor's last known address of the principal place of business (or in the event of the contractor being a company, to or at its Registered Office). In case of change of address, the notice shall be served at changed address as notified in writing by the Contractor to BHEL. Such posting or leaving of the notice shall be deemed to be good service of such notice and the time mentioned to the condition for doing any act after notice shall be reckoned from the date so mentioned in such notice.
2.3.2	<u>Service of notice on BHEL</u>

Bharat Heavy Electricals Limited		
Power Sector - Eastern Region, Kolkata		
TENDER NO: Ref: BHEL: MSTPP: C- RW: CSD: 22:10:06		
VOLUME-IB	GENERAL CONDITIONS OF CONTRACT (SERVICE)	

<p>Any notice to be given to BHEL in-charge/Region under the terms of the Contract shall be served by sending the same by post to or leaving the same at BHEL address or changed address as notified in writing by BHEL to the Contractor.</p>	
2.4	<p>USE OF LAND</p> <p>No land belonging to BHEL or their Customer under temporary possession of BHEL shall be occupied by the contractor without written permission of BHEL.</p>
2.5	<p>COMMENCEMENT OF WORK</p> <p>2.5.1 The contractor shall commence the work as per the time indicated in the Letter of Intent from BHEL and shall proceed with the same with due expedition without delay.</p> <p>2.5.2 If the contractor fails to start the work within stipulated time as per LOI or as intimated by BHEL, then BHEL at its sole discretion will have the right to cancel the contract. The Earnest Money and/or Security Deposit with BHEL will stand forfeited without any further reference to him without prejudice to any and all of BHEL's other rights and remedies in this regard.</p> <p>2.5.3 All the work shall be carried out under the direction and to the satisfaction of BHEL.</p>
2.6	<p>MEASUREMENT OF WORK AND MODE OF PAYMENT:</p> <p>2.6.1 All payments due to the contractors shall be made by e mode only, unless otherwise found operationally difficult for reasons to be recorded in writing</p> <p>2.6.2 For progress running bill payments: - The Contractor shall present detailed measurement sheets in triplicate, duly indicating all relevant details based on technical documents and connected drawings for work done during the month/period under various categories in line with terms of payment as per contract. The basis of arriving at the quantities, weights shall be relevant documents and drawings released by BHEL. These measurement sheets shall be prepared jointly with BHEL Engineers and signed by both the parties.</p> <p>2.6.3 These measurement sheets will be checked by BHEL Engineer and quantities and percentage eligible for payment under various groups shall be decided by BHEL Engineer. The abstract of quantities and percentage so arrived at based on the terms of payment shall be entered in Measurement Book and signed by both the parties.</p> <p>2.6.4 Based on the above quantities, contractor shall prepare the bills in prescribed format and work out the financial value. These will be entered in Measurement Book and signed by both the parties. Payment shall be made by BHEL after effecting the recoveries due from the contractor.</p> <p>2.6.5 All recoveries due from the contractor for the month/period shall be effected in full from the corresponding running bills unless specific approval from the competent authorities is obtained to the contrary.</p> <p>2.6.6 Measurement shall be restricted to that portion of work for which it is required to ascertain the financial liability of BHEL under this contract.</p>

Bharat Heavy Electricals Limited		
Power Sector - Eastern Region, Kolkata		
TENDER NO: Ref: BHEL: MSTPP: C- RW: CSD: 22:10:06		
VOLUME-IB	GENERAL CONDITIONS OF CONTRACT (SERVICE)	

- 2.6.7 The measurement shall be taken jointly by persons duly authorized on the part of BHEL and by the Contractor.
- 2.6.8 The Contractor shall bear the expenditure involved if any, in making the measurements and testing of materials to be used/used in the work. The contractor shall, without extra charges, provide all the assistance with appliances and other things necessary for measurement.
- 2.6.9 If at any time due to any reason whatsoever, it becomes necessary to re-measure the work done in full or in part, the expenses towards such re measurements shall be borne by the contractor unless such re measurements are warranted solely for reasons not attributable to contractor.
- 2.6.10 Passing of bills covered by such measurements does not amount to acceptance of the completion of the work measured. Any left-out work has to be completed, if pointed out at a later date by BHEL.
- 2.6.11 Final measurement bill shall be prepared in the final bill format prescribed for the purpose based on the certificate issued by BHEL Engineer that entire works as stipulated in tender specification has been completed in all respects to the entire satisfaction of BHEL. Contractor shall give unqualified "No Claim" Certificate. All the tools and tackles loaned to him should be returned in satisfactory condition to BHEL. The abstract of final quantities and financial values shall also be entered in the Measurement Books and signed by both parties to the contract. The Final Bill shall be prepared and paid within a reasonable time after completion of work.

2.7 RIGHTS OF BHEL

BHEL reserves the following rights in respect of this contract during the original contract period or its extensions if any, as per the provisions of the contract, without entitling the contractor for any compensation.

- 2.7.1 To withdraw any portion of work and/or to restrict/alter quantum of work as indicated in the contract during the progress of work and get it done through other agencies to suit BHEL's commitment to its customer or in case BHEL decides to advance the date of completion due to other emergent reasons/ BHEL's obligation to its customer.
- 2.7.2 To terminate the contract or get any part of the work done through other agency or deploy BHEL's own/hired/otherwise arranged resources , at the risk and cost of the contractor after due notice of a period of two weeks by BHEL, in the event of:-
- i) Contractor's continued poor progress
 - ii) Withdrawal from or abandonment of the work before completion of the work
 - iii) Contractor's inability to progress the work for completion as stipulated in the contract
 - iv) Poor quality of work
 - v) Corrupt act of Contractor
 - vi) Insolvency of the Contractor
 - vii) Persistent disregard to the instructions of BHEL
 - viii) Assignment, transfer, sub-letting of contract without BHEL's written permission
 - ix) Non fulfillment of any contractual obligations
 - x) In the opinion of BHEL, the contractor is overloaded and is not in a position to execute the job as per required schedule

Bharat Heavy Electricals Limited		
Power Sector - Eastern Region, Kolkata		
TENDER NO: Ref: BHEL: MSTPP: C- RW: CSD: 22:10:06		
VOLUME-IB	GENERAL CONDITIONS OF CONTRACT (SERVICE)	

2.7.3 To meet the expenses including BHEL overheads on the differential cost at 5%, over and above the Liquidated damages/penalties arising out of "Risk & Cost" as explained above under SI.No. 2.7.2. BHEL shall recover the amount from any money due from Contractor, or from any money due to the Contractor including Security Deposit, or by forfeiting any T&P or material of the contractor under this contract or any other contract of BHEL or by any other means or any combination thereof

2.7.4 To terminate the contract or to restrict the quantum of work and pay for the portion of work executed in case BHEL's contract with their customer are terminated for any reason, as per mutual agreement.

2.7.5 To effect recovery from any amounts due to the contractor under this or any other contract or in any other form, the moneys BHEL is statutorily forced to pay to anybody, due to contractor's failure to fulfill any of his obligations. BHEL shall levy overheads of 5% on all such payments along with interest as defined elsewhere in the GCC.

2.7.6 While every endeavor will be made by BHEL to this end, they cannot guarantee uninterrupted work due to conditions beyond their control. The Contractor will not be normally entitled for any compensation/extra payment on this account unless otherwise specified elsewhere in the contract.

2.7.7 In case the execution of works comes to a complete halt or reaches a stage wherein worthwhile works cannot be executed and there is no possibility of commencement of work for a period of not less than two months, due to reasons not attributable to the contractor and other than Force Majeure conditions, BHEL may consider permitting the contractor to de mobilize forthwith and re mobilize at an agreed future date. Cost of such demobilization/remobilization shall be mutually agreed. ORC in such cases shall not be applicable for the period between the period of demobilization and re mobilization. The duration of contract/time extension shall accordingly get modified suitably. In case of any conflict, BHEL decision in this regard shall be final and binding on the contractor.

2.7.8 In the unforeseen event of inordinate delay in receipt of materials, drawings, fronts, etc, due to which inordinate discontinuity of work is anticipated, BHEL at its discretion may consider contractor's request to short close the contract in following cases:

- a) The balance works (including but not limited to Trial Operation, PG Test, etc.) are minor vis a vis the scope of work envisaged as per the contract.
- b) There has been no significant work in past 6 months OR no significant work is expected in next 6 months (example in Hydro projects or in projects where work has stopped due to reasons beyond the control of BHEL)
- c) The balance works cannot be done within a reasonable period of time as they are dependent on unit shutdown or on other facilities of customer or any other reasons not attributable to the contractor

At the point of requesting for short closure, contractor shall establish that he has completed all works possible of completion and he is not able to proceed with the balance works due to constraints beyond his control. In such a case, the estimated value of the unexecuted portion of work (or estimated value of services to be provided for carrying out milestone/stage payments like

Bharat Heavy Electricals Limited		
Power Sector - Eastern Region, Kolkata		
TENDER NO: Ref: BHEL: MSTPP: C- RW: CSD: 22:10:06		
VOLUME-IB	GENERAL CONDITIONS OF CONTRACT (SERVICE)	

Trial Operation/PG Test, etc.) as mutually agreed, shall however be reduced from the final contract value.

2.7.9 LIQUIDATED DAMAGES/PENALTY

If the contractor fails to maintain the required progress of work which results in delay in the completion of the work as per the contractual completion period, BHEL shall have the right to impose Liquidated Damage/Penalty at the rate of 0.5% of the contract value, per week of delay or part thereof subject to a maximum of 10% of the contract value. For this purpose, the period of delay shall be the delay attributable to the Contractor for the completion of work as per contract. Contract Value for this purpose, shall be the final executed value exclusive of ORC, Extra Works executed on Man-day rate basis, Supplementary/Additional Items and PVC.

2.8 RESPONSIBILITIES OF THE CONTRACTOR IN RESPECT OF LOCAL LAWS, EMPLOYMENT OF WORKERS ETC.

The following are the responsibilities of the contractor in respect of observance of local laws, employment of personnel, payment of taxes etc. The subcontractor shall fully indemnify BHEL against any claims of whatsoever nature arising due to the failure of the contractor in discharging any of his responsibilities hereunder:

- 2.8.1 As far as possible, Unskilled Workers shall be engaged from the local areas in which the work is being executed.
- 2.8.2 The contractor at all times during the continuance of this contract shall, in all his dealings with local labour for the time being employed on or in connection with the work, have due regard to all local festivals and religious and other customs.
- 2.8.3 The contractor shall comply with all applicable State and Central Laws, Statutory Rules, Regulations etc. such as Payment of Wages Act, Minimum Wages Act, Workmen Compensation Act, Employer's Liability Act, Industrial Disputes Act, Employers Provident Act, Employees State Insurance Scheme, Contract Labour (Regulation and Abolition) Act 1970, Payment of Bonus & Gratuity Act and other Acts, Rules and Regulations for labour as may be enacted by the Government during the tenure of the Contract and having force or jurisdiction at Site. The Contractor shall also give to the local Governing Body, Police and other relevant Authorities all such notices as may be required by the Law.
- 2.8.4 The contractor shall obtain independent License under the Contract Labour (Regulations and Abolition Act, 1970) as required from the concerned Authorities based on the certificate (Form-V) issued by the Principal Employer/Customer
- 2.8.5 The contractor shall pay all taxes, fees, license charges, deposits, duties, tolls, royalties, commission or other charges which may be leviable on account of his operations in executing the contract.
- 2.8.6 While BHEL would pay the inspection fees and Registration fees of Boiler/Electrical Inspectorate,

Bharat Heavy Electricals Limited		
Power Sector - Eastern Region, Kolkata		
TENDER NO: Ref: BHEL: MSTPP: C- RW: CSD: 22:10:06		
VOLUME-IB	GENERAL CONDITIONS OF CONTRACT (SERVICE)	

- all other arrangements for site visits periodically by the Inspectorate to site, Inspection certificate etc. will have to be made by contractor. However, BHEL will not make any payment to the Inspectorate in connection with contractor's Welders/Electricians qualification tests etc.
- 2.8.7 Contractor shall be responsible for provision of Health and Sanitary arrangements (more particularly described in Contract Labour Regulation & Abolition Act), Safety precautions etc. as may be required for safe and satisfactory execution of contract.
- 2.8.8 The contractor shall be responsible for proper accommodation including adequate medical facilities for personnel employed by him.
- 2.8.9 The contractor shall be responsible for the proper behavior and observance of all regulations by the staff employed by him.
- 2.8.10 The contractor shall ensure that no damage is caused to any person/property of other parties working at site. If any such damage is caused, it is responsibility of the contractor to make good the losses or compensate for the same.
- 2.8.11 All the properties/equipment/components of BHEL/their Client loaned with or without deposit to the contractor in connection with the contract shall remain properties of BHEL/their Client.
- 2.8.12 The contractor shall use such properties for the purpose of execution of this contract. All such properties/equipment/components shall be deemed to be in good condition when received by the contractor unless he notifies within 48 hours to the contrary. The contractor shall return them in good condition as and when required by BHEL/their Client. In case of non-return, loss, damage, repairs etc., the cost thereof as may be fixed by BHEL Engineer will be recovered from the contractor
- 2.8.13 In case the contractor is required to undertake any work outside the scope of this contract, the rates payable shall be those mutually agreed upon if the item rates are not mentioned in existing contract
- 2.8.14 Any delay in completion of works/or non-achievement of periodical targets due to the reasons attributable to the contractor, the same may have to be compensated by the contractor either by increasing manpower and resources or by working extra hours and/or by working more than one shift. All these are to be carried out by the contractor at no extra cost.
- 2.8.15 The contractor shall arrange, coordinate his work in such a manner as to cause no hindrance to other agencies working in the same premises.
- 2.8.16 All safety rules and codes applied by the Client/BHEL at site shall be observed by the contractor without exception. The contractor shall be responsible for the safety of the equipment/material and works to be performed by him and shall maintain all light, fencing guards, slings etc. or other protection necessary for the purpose. Contractor shall also take such additional precautions as may be indicated from time to time by the Engineer with a view to prevent pilferage, accidents, fire hazards. Due precautions shall be taken against fire hazards and atmospheric conditions. Suitable number of Clerical staffs, watch and ward, store keepers to take care of equipment/materials and construction tools and tackles shall be posted at site by the contractor till the completion of work

Bharat Heavy Electricals Limited		
Power Sector - Eastern Region, Kolkata		
TENDER NO: Ref: BHEL: MSTPP: C- RW: CSD: 22:10:06		
VOLUME-IB	GENERAL CONDITIONS OF CONTRACT (SERVICE)	

under this contract.

The contractor shall arrange for such safety devices as are necessary for such type of work and carry out the requisite site tests of handling equipment, lifting tools, tackles etc. as per prescribed standards and practices.

Contractor has to ensure the implementation of Health, Safety and Environment (HSE) requirements as per directions given by BHEL/Customer. The contractor has to assist in HSE audit by BHEL/Customer and submit compliance Report. The contractor has to generate and submit record/reports as per HSE plan/activities as per instruction of BHEL/Customer

- 2.8.17 The contractor will be directly responsible for payment of wages to his workmen. A pay roll sheet giving all the payments given to the workers and duly signed by the contractor's representative should be furnished to BHEL site for record purpose, if so called for.
- 2.8.18 In case of any class of work for which there is no such specification as laid down in the contract, such work shall be carried out in accordance with the instructions and requirements of the Engineer.
- 2.8.19 Also, no idle charges will be admissible in the event of any stoppage caused in the work resulting in contractor's labour and Tools & Plants being rendered idle due to any reason at any time.
- 2.8.20 The contractor shall take all reasonable care to protect the materials and work till such time the plant/equipment has been taken over by BHEL or their Client whichever is earlier.
- 2.8.21 The contractor shall not stop the work or abandon the site for whatsoever reason of dispute, excepting force majeure conditions. All such problems/disputes shall be separately discussed and settled without affecting the progress of work. Such stoppage or abandonment shall be treated as breach of contract and dealt with accordingly
- 2.8.22 The contractor shall keep the area of work clean and shall remove the debris etc. while executing day-to-day work. Upon completion of work, the contractor shall remove from the vicinity of work, all scrap, packing materials, rubbish, unused and other materials and deposit them in places specified by the Engineer. The contractor will also demolish all the hutments, sheds, offices, etc. constructed and used by him and shall clean the debris. In the event of his failure to do so, the same will be arranged to be done by the Engineer and the expenses recovered from the contractor.
- 2.8.23 The contractor shall execute the work in the most substantial and workman like manner in the stipulated time. Accuracy of work and timely execution shall be the essence of this contract. The contractor shall be responsible to ensure that the quality, assembly and workmanship conform to the dimensions and clearance given in the drawings and/ or as per the instructions of the Engineer.
- 2.8.24 The Contractor to note that some of BHEL's T&Ps/MMDs may not be insured. The Contractor will take necessary precautions and due care to protect the same while in his custody from any damage/ loss till the same is handed over back to BHEL. In case the damage / loss is due to carelessness/ negligence on the part of the contractor, the Contractor is liable to get them repair/

Bharat Heavy Electricals Limited		
Power Sector - Eastern Region, Kolkata		
TENDER NO: Ref: BHEL: MSTPP: C- RW: CSD: 22:10:06		
VOLUME-IB	GENERAL CONDITIONS OF CONTRACT (SERVICE)	

	replaced immediately and in case of his failure to do so within a reasonable time, BHEL will reserve the right to recover the loss from the contractor.
2.9	PROGRESS MONITORING, MONTHLY REVIEW AND PERFORMANCE EVALUATION
2.9.1	A detailed plan/program for completion of the contractual scope of work as per the time schedule given in the contract shall be jointly agreed between BHEL and Contractor, before commencement of work. The above program shall be supported by month wise deployment of resources viz Manpower, T&P, Consumables, etc. Progress will be reviewed periodically (Daily/Weekly/Monthly) vis a vis this jointly agreed program. The Contractor shall submit periodical progress reports (Daily/Weekly/Monthly) and other reports/information including manpower, consumables, T&P mobilization etc. as desired by BHEL.
2.9.2	Monthly progress review between BHEL and Contractor shall be based on the agreed program as above, availability of inputs/fronts etc. and constraints if any, as per prescribed formats. Manpower, T&P and consumable reports as per prescribed formats shall be submitted by contractor every month. Release of RA Bills shall be contingent upon certification by BHEL Site Engineer of the availability of the above prescribed formats duly filled in and signed.
2.9.3	The burden of proof that the causes leading to any shortfall is not due to any reasons attributable to the contractor is on the contractor himself. The monthly progress review shall record shortfalls attributable to (i) Contractor, (ii) Force Majeure Conditions, and (iii) BHEL
2.9.4	Performance of the Contractor shall be assessed as per prescribed formats and shall form the basis for 'Annual/Overall Performance Evaluation' of the Contractor and also for 'Assessment of Capacity of Bidder' for Tenders where the Contractor is a bidder. BHEL reserves the right to revise the evaluation formats during the course of execution of the works
2.10	TIME OF COMPLETION
2.10.1	The time schedule shall be as prescribed in the Contract. The time for completion shall be reckoned from the date of commencement of work at Site as certified by BHEL Engineers
2.10.2	The entire work shall be completed by the contractor within the time schedule or within such extended periods of time as may be allowed by BHEL under clause 2.11
2.11	EXTENSION OF TIME FOR COMPLETION
2.11.1	If the completion of work as detailed in the scope of work gets delayed beyond the contract period, the contractor shall request for an extension of the contract and BHEL at its discretion may extend the Contract.
2.11.2	Based on the monthly reviews jointly signed, the works balance at the end of original contract period less the backlog attributable to the contractor shall be quantified, and the number of months of 'Time extension' required for completion of the same shall be jointly worked out. Within this period of 'Time extension', the contractor is bound to complete the portion of backlog attributable to the contractor. Any further 'Time extension' or 'Time extensions' at the end of the previous extension shall be worked out similarly.
2.11.3	However if any 'Time extension' is granted to the contractor to facilitate continuation of work and completion of contract, due to backlog attributable to the contractor alone, then it shall be without prejudice to the rights of BHEL to impose penalty/LD for the delays attributable to the contractor, in addition to any other actions BHEL may wish to take at the risk and cost of contractor.
2.11.4	A joint program shall be drawn for the balance amount of work to be completed during the period of 'Time Extension', along with matching resources (with weightages) to be deployed by the contractor as per specified format. Review of the program and record of shortfall shall be done

Bharat Heavy Electricals Limited		
Power Sector - Eastern Region, Kolkata		
TENDER NO: Ref: BHEL: MSTPP: C- RW: CSD: 22:10:06		
VOLUME-IB	GENERAL CONDITIONS OF CONTRACT (SERVICE)	

every month of the 'Time extension' period in the same manner as is done for the regular contract period.

2.11.5 During the period of 'Time extension', contractor shall maintain their resources as per mutually agreed program

2.11.6 At the end of total work completion as certified by BHEL Engineer, and upon analysis of the total delay, the portion of time extensions attributable to (i) Contractor, (ii) Force majeure conditions, and (iii) BHEL, shall be worked out and shall be considered to be exhausted in the same order. The total period of time extensions shall be the sum of (i), (ii) and (iii) above and shall be equal to period between the scheduled date of completion and the actual date of completion of contract. LD shall be imposed/levied for the portion of time extensions attributable to contractor and recoverable from the dues payable to the contractor.

2.12 OVERRUN COMPENSATION

2.12.1 Over Run Compensation (ORC) is payable for works done during the extension period, by way of rate revisions for periods beyond original contract period subject to the following terms and conditions.

2.12.2 Rates shall be increased by 10% for the first twelve months of one or more extensions beyond original contract period. For the next twelve months of further extensions if any, rates shall be increased as above by 10% over the previous twelve months, and similarly for each subsequent twelve months extension.

2.12.3 The amount of increase payable per month due to rate revisions is subject to a minimum of Rs 1,00,000/- per month and a maximum of Rs 10,00,000/- per month.

2.12.4 Should there be any 'Time extension' for reasons attributable only to the contractor, then the work shall be executed by the contractor at the rates applicable for the period the work was planned

2.12.5 Payment of ORC shall be regulated as follows:

- i) Contractor is entitled to Over Run Compensation (ORC) only for the portion of backlog attributable to BHEL.
- ii) 50% of the compensation as per clause 2.12.3 is allocated for deployment of resources agreed as per the joint program drawn vide 2.11.4. Payment shall however be based on the actual deployment of resources for the month as certified by BHEL, as per weightages assigned therein
- iii) 50% of the compensation as per clause 2.12.3, is allocated for achieving of planned progress agreed as per the joint program drawn vide 2.11.4. Payment shall be on pro rata basis for actual achieved quantities
- iv) Total Over Run Compensation shall be limited to 10% of the executed contract value as certified in Final Bill. For this purpose, executed contract value excludes PVC, ORC, Supplementary/Additional Items and Extra Works done on Man-day rate basis

2.12.6 Contractor shall not be entitled for any Over Run Compensation (ORC) for the portion of backlog attributable to the contractor. Such works shall be executed at the rates applicable for the period the work was planned

2.13 INTEREST BEARING RECOVERABLE ADVANCES

2.13.1 Normally no advance is payable to the contractor. However, advance payment in exceptional circumstances shall be interest bearing and secured through a Bank Guarantee and shall be limited to a maximum of 5% of contract value. This 'Interest Bearing Recoverable Advance' shall be

Bharat Heavy Electricals Limited		
Power Sector - Eastern Region, Kolkata		
TENDER NO: Ref: BHEL: MSTPP: C- RW: CSD: 22:10:06		
VOLUME-IB	GENERAL CONDITIONS OF CONTRACT (SERVICE)	

	<p>payable in not less than two installments with any of the installment not exceeding 60% of the total eligible advance.</p> <p>2.13.2 In exceptional circumstances, with due justification, Competent Authority of BHEL is empowered to approve proposals for payment of additional interim interest-bearing advance against Bank Guarantee, for resource augmentation towards expediting work for project implementation.</p> <p>2.13.3 Bank Guarantee towards 'Interest Bearing Recoverable Advance' shall be at least 110% of the advance so as to enable recovery of not only principle amount but also the interest portion, if so required.</p> <p>2.13.4 Contractor shall establish the utilization of advance drawn before the release of next installment.</p> <p>2.13.5 Payment and recovery of Interest-Bearing Recoverable advance shall be at the sole discretion of BHEL and shall not be a subject matter of arbitration.</p> <p>2.13.6 The rate of interest applicable for the above advances shall be the prime lending rate of State Bank of India prevailing at the time of disbursement of the advance + 2%, and such rate will remain fixed till the total advance amount is recovered</p> <p>2.13.7 Unadjusted amount of advances paid shall not exceed 5% of the total contract value at any point of time. Recovery of advances shall be made progressively from each Running Bill such that the advance amounts paid along with the interest is fully recovered by the time the contractor's billing reaches 80% of contract value.</p> <p>2.13.8 Recovery rate per month shall be the sum of:</p> <ol style="list-style-type: none"> a. Not less than 10% of Running Bill amount b. Simple interest up to the date of RA Bill on the outstanding Principle amount/amounts <p>2.13.9 Contractor to submit Bank Guarantee as per prescribed formats for each of the advance and shall be valid for at least one year or the recovery duration or the balance contract period whichever is later. In case the recovery of dues does not get completed within the aforesaid BG period, the contractor shall renew the BG or submit fresh BG for the outstanding amount and the remaining recovery period.</p> <p>2.13.10 BHEL is entitled to make recovery of the entire outstanding amount in case the contractor fails to comply with the BG requirement</p>
2.14	QUANTITY VARIATION
2.14.1	The quoted rates shall remain firm irrespective of any variations in the individual quantities. No compensation becomes payable in case the variation of the final executed contract value is within the limits of Plus (+) or Minus (-) 30% of awarded contract value
2.14.2	Compensation due to variation of final executed value in excess of the limits defined in clause above, shall be as follows:
	<ol style="list-style-type: none"> i) In case the finally executed contract, value reduces below the lower limit of Contract Value due to quantity variation specified above, the contractor will be eligible for compensation @ 30% of the difference between the lower limit of the contract value and the actual executed value. ii) In case the finally executed contract, value increases above the upper limit of Contract Value

Bharat Heavy Electricals Limited		
Power Sector - Eastern Region, Kolkata		
TENDER NO: Ref: BHEL: MSTPP: C- RW: CSD: 22:10:06		
VOLUME-IB	GENERAL CONDITIONS OF CONTRACT (SERVICE)	

due to quantity variation specified above, there will be no revision in the rates within the contract period.

2.15 EXTRA WORKS

- 2.15.1 All rectifications/modifications, revamping, and reworks required for any reasons not due to the fault of the contractor, or needed due to any change in deviation from drawings and design of equipment, operation/maintenance requirements, mismatching, or due to damages in transit, storage and erection/commissioning, and other allied works which are not very specifically indicated in the drawings, but are found essential for satisfactory completion of the work, will be considered as extra works.
- 2.15.2 Extra works arising on account of the contractor's fault, irrespective of time consumed in rectification of the damage/loss, will have to be carried out by the contractor free of cost. Under such circumstances, any material and consumable required for this purpose will also have to be arranged by the contractor at his cost.
- 2.15.3 All the extra work should be carried out by a separately identifiable gang, without affecting routine activities. Daily log sheets in the pro-forma prescribed by BHEL should be maintained and shall be signed by the contractor's representative and BHEL engineer. No claim for extra work will be considered/entertained in the absence of the said supporting documents i.e. daily log sheets. Signing of log sheets by BHEL engineer does not necessarily mean the acceptance of such works as extra works.
- 2.15.4 BHEL retains the right to award or not to award any of the major repair/rework/modification/rectification/fabrication works to the contractor, at their discretion without assigning any reason for the same
- 2.15.5 After eligibility of extra works is established and finally accepted by BHEL engineer/designer, payment will be released on competent authority's approval at the following rate.
- MAN-HOUR RATE FOR ELIGIBLE EXTRA WORKS:** Single composite average labour man-hour rate, including overtime if any, supervision, use of tools and tackles and other site expenses and incidentals, consumables for carrying out any major rework/ repairs/ rectification/ modification/ fabrication as certified by site as may arise during the course of erection, testing, commissioning or extra works arising out of transit, storage and erection damages, payment, if found due will be at Rs 60/- per man hour.
- 2.15.6 The above composite labour man hour rate towards extra works shall remain firm and not subject to any variation during execution of the work. PVC will not be applicable for extra works. Rate revision, Over Run Charges/compensation etc. will not be applicable due to extra works.
- 2.15.7 **Extra Works for Civil Packages** shall be regulated as follows
- i) Rates for Extra Works arising due to (1) non-availability of BOQ (Rate Schedule), OR (2) change in Specifications of materials/works (3) rectification/modification/dismantling & re-erecting etc. due to no fault of Contractor, shall be in the order of the following:

Bharat Heavy Electricals Limited		
Power Sector - Eastern Region, Kolkata		
TENDER NO: Ref: BHEL: MSTPP: C- RW: CSD: 22:10:06		
VOLUME-IB	GENERAL CONDITIONS OF CONTRACT (SERVICE)	

- a) Item rates are to be derived from similar nature of items in the BOQ (Rate Schedule) with applicable escalation derived from All India Consumer Price Index for Whole Sale Commodities.
 - b) As per CPWD-DSR-2007 (or latest edition) with applicable escalation derived from All India Consumer price Index for Whole Sale Commodities, OR, Notification issued by the office of CPWD for 'Cost Index' in that Region where the project is being executed, whichever is less
 - c) Item rates are to be worked out on the basis of prevailing market rates mutually agreed between BHEL and Contractor, plus 15% towards Contractor's overheads and profit.
- ii) PVC and ORC will not applicable be for (i) above.

2.16 SUPPLEMENTARY ITEMS

2.16.1 For NON-Civil Works

Supplementary items are items/works required for completion of entire work but not specified in the scope of work. Subject to certification of such items/works as supplementary items by BHEL Engineer, rates shall be derived on the basis of any one of the following on mutual agreement:

- i) Based on percentage breakup/rates indicated for similar/nearby items
- ii) In case (i) above does not exist, then BHEL/site may derive the percentage breakup/rates to suit the type of work

2.16.2 For Civil Works

- i) Rates for Supplementary Works/Additional Works arising out due to additions/alterations in the original scope of works as per contract subject to certification of BHEL Engineer shall be worked out as under:

- a) Item rates which are available in existing BOQ (Rate Schedule) shall be operated with applicable escalation derived from All India Consumer Price Index for Whole Sale Commodities
- b) Items of works which are not available in existing BOQ shall be operated as an 'Extra Works' and rate shall be derived as per clause no 2.15.7

- ii) Execution of Supplementary Works/Additional Works through the Contractor shall be at the sole discretion of BHEL, and shall be considered as part of executed contract value for the purpose of Quantity Variation as per clause 2.14
- iii) BHEL Engineer's decision regarding fixing the rate as above is final and binding on the contractor.
- iv) PVC and ORC will not be applicable for (i) above.

2.17 PRICE VARIATION COMPENSATION

2.17.1 In order to take care of variation in cost of execution of work on either side, due to variation in the index of LABOUR, HIGH SPEED DIESEL OIL, WELDING ROD, CEMENT, STEEL, MATERIALS, Price Variation Formula as described herein shall be applicable

2.17.2 85% component of Contract Value shall be permitted to be adjusted for variation in various relevant indices during execution of work. The remaining 15% shall be treated as fixed component

2.17.3 The basis for calculation of price variation in each category, their component, Base Index, shall be as under:

SL NO.	CATEGORY	BASE INDEX	COMPONENT ('K')		
			CIVIL PACKAGES (See Note A/B/C)	MECHANICAL PACKAGES	LABOUR ORIENTED

Bharat Heavy Electricals Limited Power Sector - Eastern Region, Kolkata		
TENDER NO: Ref: BHEL: MSTPP: C- RW: CSD: 22:10:06		
VOLUME-IB	GENERAL CONDITIONS OF CONTRACT (SERVICE)	

			A	B**	C		PACKAGES (See Note D)
i)	LABOUR (ALL CATEGORIES)	'MONTHLY ALL-INDIA AVERAGE CONSUMER PRICE INDEX NUMBERS FOR INDUSTRIAL WORKERS' published by Labour Bureau, Ministry of Labour and Employment, Government of India. (Website: labourbureau.nic.in)	40	25	30	65	80
ii)	HIGH SPEED DIESEL OIL	Name of Commodity: HSD OIL. Type: INDIVIDUAL COMMODITY (See Note F)	5	3	5	5	5
iii)	WELDING ROD	Name of Commodity: WELDING ROD Type: INDIVIDUAL COMMODITY (See Note F)				15	
iv)	CEMENT	Name of Commodity: GREY CEMENT Type: INDIVIDUAL COMMODITY (See Note F)		20	30		
v)	STEEL (Structural and Reinforcement Steel)	Name of Commodity: a1. IRON & SEMIS Type: GROUP ITEM (See Note F)		25			
vi)	MATERIALS (Other than Cement & Steel)	Name of Commodity: ALL COMMODITIES Type: GROUP ITEM (See Note F)	40	12	20		

Note: A) Cement & Steel: Free Issue (BHEL Scope)

B) Cement & Steel: In Contractor Scope {**: unless otherwise specified in Special Conditions of Contract (SCC) }

C) Cement in Contractor Scope, and Steel is Free Issue (BHEL Scope)

D) Predominantly 'Labour Oriented' packages including Material Handling & Management, Insulation, Painting, Electrical and CI or a combination thereof, which are separately tendered and awarded

E) For Composite packages (i.e. Civil+Mechanical+Electrical/CI or Civil+Mechanical or Mechanical+Electrical/CI), the components for various categories shall be as per respective packages

F) As per the 'MONTHLY WHOLE SALE PRICE INDEX' for the respective Commodity and Type, published by Office of Economic Adviser, Ministry of Commerce and Industry, Government of India. (Website: www.eaindustry.nic.in). Revisions in the index or commodity will be re adjusted accordingly.

2.17.4 Payment/recovery due to variation in index shall be determined on the basis of the following notional formula without any initial absorption, in respect of the identified components viz LABOUR, HIGH SPEED DIESEL OIL, WELDING ROD, CEMENT, STEEL, MATERIALS

$$P = K \times R \times \frac{(X_N - X_0)}{X_0}$$

Where

P = Amount to be paid/recovered due to variation in the Index for Labour, High Speed Diesel Oil, Welding Rod, Cement, Steel and Materials

K = Percentage component applicable for Labour, High Speed Diesel Oil, Welding Rod, Cement, Steel and Materials

R = Value of work done for the billing month (Excluding Taxes and Duties if payable extra)

XN = Revised Index No for Labour, High Speed Diesel Oil, Welding Rod, Cement, Steel and Materials for the billing month under consideration

Xo = Index no for Labour, High Speed Diesel Oil, Welding Rod, Cement, Steel and Materials as on the Base date.

Bharat Heavy Electricals Limited		
Power Sector - Eastern Region, Kolkata		
TENDER NO: Ref: BHEL: MSTPP: C- RW: CSD: 22:10:06		
VOLUME-IB	GENERAL CONDITIONS OF CONTRACT (SERVICE)	

- 2.17.5 Base date shall be calendar month of the latest date of submission of Tender.
- 2.17.6 PVC shall not be payable for the ORC amount, Supplementary/Additional Items, Extra works.
- 2.17.7 The contractor shall furnish necessary monthly bulletins for the necessary indices from the relevant websites along with his Bills.
- 2.17.8 The contractor will be required to raise the bills for price variation payments on a monthly basis along with the running bills irrespective of the fact whether any increase/decrease in the index for relevant categories has taken place or not. In case there is delay in publication of bulletins (final figure), the provisional values as published can be considered for payments and arrears shall be paid/recovered on getting the final values.
- 2.17.9 PVC shall be applicable for the entire original contract period plus the extended period. However, the Total Quantum of Price Variation amount payable/recoverable shall be regulated as follows:
- i) For the portion of backlog attributable to the contractor, the PVC will be based on the average of the indices for the period of the original contract period.
 - ii) For the period of Force Majeure, the PVC will be limited to the indices applicable at the beginning of the force majeure period.
 - iii) For the portion of backlog attributable to BHEL, the PVC will be as per the indices applicable for the respective months
 - iv) The total amount of PVC shall not exceed 20% of the cumulatively executed contract value. Executed contract value for this purpose is exclusive of PVC, ORC, Supplementary/Additional Items and Extra works.

2.18 INSURANCE

- 2.18.1 BHEL/their customer shall arrange for insuring the materials/properties of BHEL/customer covering the risks during transit, storage, erection and commissioning.
- 2.18.2 It is the sole responsibility of the contractor to ensure his materials, equipment, workmen, etc. against accidents and injury while at work and to pay compensation, if any, to workmen as per Workmen's compensation Act. The work will be carried out in a protected area and all the rules and regulations of the client /BHEL in the area of project which are in force from time to time will have to be followed by the contractor.
- 2.18.3 If due to negligence and or non-observation of safety and other precautions by the contractors, any accident/injury occurs to the property / manpower belong to third party, the contractor shall have to pay necessary compensation and other expense, if so, decided by the appropriate authorities.
- 2.18.4 The contractor will take necessary precautions and due care to protect the material, while in his custody from any damage/ loss due to theft or otherwise till the same is taken over by BHEL or customer. For lodging / processing of insurance claim the contractor will submit necessary documents. BHEL will recover the loss including the deductible franchise from the contractor, in case the damage / loss is due to carelessness / negligence on the part of the contractor. In case of any theft of material under contractor's custody, matter shall be reported to police by the contractor immediately and copy of FIR and subsequently police investigation report shall be submitted to BHEL for taking up with insurance. However, this will not relieve the contractor of his

Bharat Heavy Electricals Limited		
Power Sector - Eastern Region, Kolkata		
TENDER NO: Ref: BHEL: MSTPP: C- RW: CSD: 22:10:06		
VOLUME-IB	GENERAL CONDITIONS OF CONTRACT (SERVICE)	

contractual obligation for the material in his custody.	
2.19	<p style="text-align: center;">STRIKES & LOCKOUT</p> <p>2.19.1 The contractor will be fully responsible for all disputes and other issues connected with his labour. In the event of the contractor's labour resorting to strike or the Contractor resorting to lockout and if the strike or lockout declared is not settled within a period of one month, BHEL shall have the right to get the work executed through any other agencies and the cost so incurred by BHEL shall be deducted from the Contractor's bills.</p> <p>2.19.2 For all purposes whatsoever, the employees of the contractor shall not be deemed to be in the employment of BHEL</p>
2.20	<p style="text-align: center;">FORCE MAJEURE</p> <p style="text-align: center;">The following shall amount to Force Majeure: -</p> <p>2.20.1 Acts of God, act of any Government, War, Sabotage, Riots, Civil commotion, Police action, Revolution, Flood, Fire, Cyclones, Earth quake and Epidemic and other similar causes over which the contractor has no control.</p> <p>2.20.2 If the contractor suffers delay in the due execution of the contractual obligation due to delays caused by force majeure as defined above, the agreed time of completion of the job covered by this contract or the obligations of the contractor shall be extended by a period of time equal to period of delay, provided that on the occurrence of any such contingency, the contractor immediately reports to BHEL in writing the causes of delay and the contractor shall not be eligible for any compensation.</p>
2.21	<p style="text-align: center;">ARBITRATION & RECONCILIATION</p> <p>2.21.1 In case amicable settlement is not reached in the event of any dispute or difference arising out of the execution of the Contract or the respective rights and liabilities of the parties or in relation to interpretation of any provision by the Contractor in any manner touching upon the Contract, such dispute or difference shall (except as to any matters, the decision of which is specifically provided for therein) be referred to the sole arbitration of the arbitrator appointed by BHEL/In charge(Region).</p> <p style="text-align: center;">The award of the Arbitrator shall be binding upon the parties to the dispute</p> <p style="text-align: center;">Subject as aforesaid, the provisions of Arbitration and Reconciliation Act 1996 (India) or statutory modifications or re enactments thereof and the rules made there under and for the time being in force shall apply to the arbitration proceedings under this clause. The venue of the arbitration shall be the place from which the contract is issued or such other place as the Arbitrator at his discretion may determine</p> <p>2.21.2 In case of Contract with Public Sector Enterprise (PSE) or a Government Department, the following shall be applicable:</p>

Bharat Heavy Electricals Limited		
Power Sector - Eastern Region, Kolkata		
TENDER NO: Ref: BHEL: MSTPP: C- RW: CSD: 22:10:06		
VOLUME-IB	GENERAL CONDITIONS OF CONTRACT (SERVICE)	

In the event of any dispute or difference relating to the interpretation and application of the provisions of the Contract, such dispute or difference shall be referred to by either party to the arbitration of one of the arbitrators in the department of public enterprises. The award of the arbitrator shall be binding upon the parties to the dispute, provided, however, any party aggrieved by such award may make further reference for setting aside or revision of the award to the Law Secretary, Department of Legal Affairs, Ministry of Law and Justice, Government of India. Upon such reference the dispute shall be decided by the Law Secretary or the Special Secretary or Additional Secretary when so authorized by the Law Secretary, whose decision shall bind the parties hereto finally and conclusively.

2.21.3 The cost of arbitration shall be borne equally by the parties.

2.21.4 Work under the contract shall be continued during the arbitration proceedings

2.22 RETENTION AMOUNT

2.22.1 Retention Amount shall be 5% of executed contract value and shall be recovered at the rate of 5% from each Running Bill admitted, including PVC Bills.

2.22.2 Refund of Retention Amount shall be as follows:

- i) 50% of retention amount along with 'Final Bill'
- ii) Balance 50% of retention amount shall be retained towards 'Performance Guarantee for Workmanship' and shall become refundable after expiry of Guarantee period, provided all the defects noticed during the guarantee period have been rectified to the satisfaction of BHEL Site Engineer/BHEL Construction Manager, and after deducting all expenses/other amounts due to BHEL under the contract/other contracts entered into by BHEL with them. This portion of the retention amount can be released on commencement of the Guarantee period, on submission of equivalent Bank Guarantee.

2.23 PAYMENTS

Payments to Contractors are made in any one of the following forms

2.23.1 Running Account Bills (RA Bills)

- i) These are for interim payments when the contracts are in progress. The bills for such interim payments are to be prepared by Contractor in prescribed formats (RA Bill forms).
- ii) Payments shall be made according to the extent of work done as per measurements taken up to the end of the calendar month and in line with the terms of payments described in the Tender documents
- iii) Recoveries on account of electricity, water, statutory deductions, etc are made as per terms of contract
- iv) Full rates for the work done shall be allowed only if the quantum of work has been done as per the specifications stipulated in the contract. If the work is not executed as per the stipulated specifications, BHEL may ask the contractor to re do the work according to the required specifications, without any extra cost. However, where this is not considered necessary 'OR' where the part work is done due to factors like non-availability of material to be supplied by BHEL 'OR' non-availability of fronts 'OR' non-availability of drawings, fraction payment against full rate, as is considered reasonable, may be allowed with due regard for the work remaining to be done. BHEL decision in this regard will be final and

Bharat Heavy Electricals Limited		
Power Sector - Eastern Region, Kolkata		
TENDER NO: Ref: BHEL: MSTPP: C- RW: CSD: 22:10:06		
VOLUME-IB	GENERAL CONDITIONS OF CONTRACT (SERVICE)	

	<p>binding on the contractor.</p> <p>v) In order to facilitate part payment, BHEL Site Engineer at his discretion may further split the contracted rates/percentages to suit site conditions, cash flow requirements according to the progress of work</p>
2.23.2	<p>Final Bill</p> <p>Final Bill' is used for final payment on closing of Running Account for works or for single payment after completion of works. 'Final Bill' shall be submitted as per prescribed format after completion of works as per scope and upon material reconciliation, along with the following.</p> <ul style="list-style-type: none"> i) 'No Claim Certificate' by contractor ii) Clearance certificates where ever applicable viz Clearance Certificates from Customer, various Statutory Authorities like Labour department, PF Authorities, Commercial Tax Department, etc. iii) Indemnity bond as per prescribed format <p style="text-align: center;">BHEL shall settle the final bills after deducting all liabilities of Contractor to BHEL</p>
2.24	<p>PERFORMANCE GUARANTEE FOR WORKMANSHIP</p>
2.24.1	<p>Even though the work will be carried out under the supervision of BHEL Engineers the Contractor will be responsible for the quality of the workmanship and shall guarantee the work done for a period of twelve months from the date of commencement of guarantee period as defined in Special Conditions of Contract, for good workmanship and shall rectify free of cost all defects due to faulty erection detected during the guarantee period. In the event of the Contractor failing to repair the defective works within the time specified by the Engineer, BHEL may proceed to undertake the repairs of such defective works at the Contractor's risk and cost, without prejudice to any other rights and recover the same from the Guarantee money.</p>
2.24.2	<p>BHEL shall release the guarantee money subject to the following</p> <ul style="list-style-type: none"> i) Contractor has submitted 'Final Bill' ii) Guarantee period as per contract has expired iii) Contractor has furnished 'No Claim Certificate' in specified format iv) BHEL Site Engineer/Construction Manager has furnished the 'No Demand Certificate' in specified format v) Contractor has carried out the works required to be carried out by him during the period of Guarantee and all expenses incurred by BHEL on carrying out such works is included for adjustment from the Guarantee money refundable.
2.25	<p>CLOSING OF CONTRACTS</p> <p>The Contract shall be considered completed and closed upon completion of all contractual obligations and settlement of Final Bill or completion of Guarantee period whichever is later. Upon closing of Contract, BHEL shall issue a completion certificate as per standard format, based on specific request of Contractor.</p>
2.26	<p>REVERSE AUCTION:</p> <p>BHEL reserves the right to go for Reverse Auction for Price Bid Opening by BHEL appointed service provider, instead of opening the submitted sealed price bid in the conventional way. The Business Rules for Reverse Auction shall be as per BHEL guidelines issued from time to time.</p>
2.27	<p>SUSPENSION OF BUSINESS DEALINGS</p> <p>BHEL reserves the right to take action against Contractors who either fail to perform or Tenderers/Contractor who indulge in malpractices, by suspending business dealings with them in</p>

Bharat Heavy Electricals Limited		
Power Sector - Eastern Region, Kolkata		
TENDER NO: Ref: BHEL: MSTPP: C- RW: CSD: 22:10:06		
VOLUME-IB	GENERAL CONDITIONS OF CONTRACT (SERVICE)	

line with BHEL guidelines issued from time to time.	
2.28	OTHER ISSUES
2.28.1	Value of Non-judicial Stamp Paper for Bank Guarantees and for Contract Agreement shall be not less than Rs 100/- unless otherwise required under relevant statutes.
2.28.2	In case of any conflict between the General Conditions of Contract and Special Conditions of Contract, provisions contained in the Special Conditions of Contract shall prevail.
2.28.3	Unless otherwise specified in NIT, offers from consortium/JVs shall not be considered.
2.28.4	BHEL may not insist for signing of Contract Agreements in respect of low value and short time period contracts like providing services for Hot water flushing, Chemical Cleaning, Transportation, etc.

End

Bharat Heavy Electricals Limited		
MSTPP, Rampal, Bagerhat, Bangladesh		
TENDER NO: BHEL: MSTPP: C- RW: CSD: 22:10:06		
VOLUME-ID	SPECIAL CONDITIONS OF CONTRACT (SERVICE)	PAGE 1 of 47

CONTENTS

SN	DESCRIPTION	Chapter
1	General Intent of the Specifications	Chapter-I
2	General Services to be rendered by the Bidder	Chapter-II
3	General Technical Requirements (Codes and Standards)	Chapter-III
4	Obligations of Contractor (In respect of Tools, Tackles, Consumables, etc. employment of supervisory staff and workmen)	Chapter-IV
5	Responsibilities of Contractor (In respect of employment of Labour, Supervisory staff, etc.)	Chapter-V
6	Material Handling, Storage, Preservation, etc	Chapter-VI
7	Drawings and Documents	Chapter-VII
8	Inspection and Quality	Chapter-VIII
9	HSE & OHSAS Obligations	Chapter-IX
10	RA Bill Payment	Chapter-X
11	Performance Monitoring	Chapter-XI
12	Suspension of Business Dealings	Chapter-XII

SPECIAL CONDITIONS OF CONTRACT (SCC)

Chapter - I : General Intent of Specifications

1.0	GENERAL INTENT OF THE SPECIFICATION
1.1	The intent of this erection specification is to provide services for execution of the project according to most modern and proven techniques and codes. The omission of specific reference to any method, equipment or material necessary for the proper and efficient services towards installation of the plant shall not relieve the contractor of the responsibility of providing such services / facilities to complete the work or portion of work awarded to him. The quoted / accepted rates / price shall deem to be inclusive of all such contingencies.
1.2	The work shall conform to dimensions and tolerances given in various drawings and documents that will be provided during erection. If any portion of works is found to be defective in workmanship and not conforming to drawings / documents or other stipulations, the contractor shall dismantle and re-do the work duly replacing the defective materials at their own cost, failing which recoveries, as determined by BHEL, shall be effected from contractor's bills.
1.3	It is not the intent of this specification to specify herein all the details of erection and commissioning. However, the system shall conform in all respects to high standards of quality and workmanship for performing the required duties in a manner acceptable to purchaser who will interpret the meaning of drawings and specifications and shall be entitled to reject any work or material, which in his judgments is not in full accordance herewith.
1.4	The omission of specific reference to any fabrication / erection or other method, equipment or material necessary for proper and efficient working of the plant shall not relieve the tenderer of the responsibility of providing such facilities to complete the work at quoted rates. Any mismatch/ defect found due to mistake in fabrication / erection shall have to be rectified by the vendor free of cost. Inspection by BHEL/Customer does not relieve vendor of his responsibility of executing quality erection.
1.5	The work covered under this specification is of highly sophisticated nature, requiring the best quality workmanship, supervision, engineering and construction management. The contractor should ensure proper planning and successful and timely completion of the work to meet the overall project schedule. The contractor must deploy adequate quantity of tools & plants, modern / latest construction aids etc. He must also deploy adequately trained, qualified and experienced supervisory staff and skilled personnel.

SPECIAL CONDITIONS OF CONTRACT (SCC)

Chapter - I : General Intent of Specifications

1.6	Contractor shall erect and commission all the equipment and auxiliaries as per the sequence & methodology prescribed by BHEL depending upon the technical requirements. Availability of materials and fronts will decide this. BHEL Engineer's decision regarding correctness of the work and method of working shall be final and binding on the contractor. No claims for extra payment from the contractor will be entertained on the ground of deviation from the methods / sequence adopted in erection of similar sets elsewhere.
1.7	Following shall be the minimum responsibility of contractor and have to be provided within finally accepted rates / prices:
1.7.1	Provision as required of all types of labour, supervisors, engineers, watch and ward, tools & tackles, calibrated MMEs (Monitoring and Measuring Equipment) as specified and otherwise required for the work, consumables for erection, testing and commissioning including material handling
1.7.2	Achieving Proper out-turn / Turn-over as per BHEL plan and commitment.
1.7.3	Completion of work as per BHEL Schedule
1.7.4	Good quality and accurate workmanship for proper performance of the equipment
1.7.5	Repair and rectification
1.7.6	Preservation / Re-conservation of all components during storage / erection / commissioning till handing over.

SPECIAL CONDITIONS OF CONTRACT (SCC)
Chapter - IV : Obligations of Contractor

2.0	GENERAL SERVICES TO BE RENDERED BY THE BIDDER
2.1	Services for construction, fabrication, equipment erection testing as well as trial run & commissioning of various equipment and accessories under the contract shall include but not be limited to the following:
2.2	Issuing materials from store/open yard from time to time for erection as per the construction program . The Contractor shall be the custodian of all the materials issued till the plant/equipment is officially taken over by the owner / BHEL after complete erection any successful trial run & commissioning.
2.3	Transport of material to their respective places of erection and erection of the complete plant & equipment as supplied under this specification.
2.4	Trial run and commissioning of individual equipment / sub-systems to the satisfaction of Owner/BHEL.
2.5	Deployment of all skilled and unskilled manpower required for erection, supervision of erection, watch & ward, commissioning and other services to be rendered under this specification.
2.6	Deployment of all erection tools & tackle, construction machinery, transportation vehicles and all other implements in adequate number and size, appropriate for the erection work to be handled under scope of this specification except otherwise specified.
2.7	Supply of all consumables, eg welding electrodes, cleaning agents, diesel oil, lubricant etc as well as materials required for temporary supports, scaffolding etc as necessary for such erection work, unless specified other wise.
2.8	Providing support services for the contractor's erection staff eg construction of site offices, temporary stores, residential accommodation and transport to work site for erection personnel, watch and ward for security and safety of the materials under the Contractor's custody etc. as required.
2.9	Maintaining proper documentation of all the site activities undertaken by the Contractor as per the proforma mutually agreed with BHEL, Submission of monthly progress reports and any such document as and when desired by BHEL/owner, taking approval of all statutory authorities i.e. Boiler Inspector, Factory Inspector, Inspector of Explosives etc. , as applicable for respective portions of work fall under the jurisdiction of such statutes of laws.
2.10	Any other service, although not specifically called for but required for a contract of the size and nature indicated in the specification.

SPECIAL CONDITIONS OF CONTRACT (SCC)
Chapter - IV : Obligations of Contractor

3.0	GENERAL TECHNICAL REQUIREMENTS (CODES AND STANDARDS)
3.1	Except where otherwise specified, the plant/equipment shall comply with the appropriate Indian Standard or an agreed internationally accepted Standard Specification as mentioned elsewhere in contract specifications, each incorporating the latest revisions at the time of tendering. Where no internationally accepted standard is applicable, the Bidder shall give all particulars and details as necessary, to enable BHEL to identify all of the plant/equipment in the same detail as would be possible had there been a Standard Specification.
3.2	Where the Bidder proposes alternative codes or standards he shall include in his tender one copy (in English) of each Standard Specification to which materials offered shall comply. In such case, the adopted alternative standard shall be equivalent or superior to the standards mentioned in the specification.
3.3	In the event of any conflict between the codes and standards referred above, and the requirements of this specification, the requirements which are more stringent shall govern.
3.4	Tools used during erection and commissioning shall not be accepted except with the specific approval of the Engineer.

SPECIAL CONDITIONS OF CONTRACT (SCC)
Chapter - IV : Obligations of Contractor

4.0	OBLIGATIONS OF CONTRACTOR
4.1	CONSUMABLES & OTHER ITEMS
4.1.1	The contractor shall provide within finally accepted price / rates, all consumables (excepting those indicated in BHEL scope) like welding electrodes (including alloy steel and stainless steel), filler wires, TIG filler wires (over & above as supplied by the unit along with the plant materials, which will be given free of cost to bidder), gases (inert, welding, cutting), soldering material, dye penetrants, radiography films, etc. Other erection consumables such as tapes, jointing compound, grease, mobile oil, M-seal, Araldite, petrol, CTC / other cleaning agents, grinding and cutting wheels are to be provided by the contractor. Steel, packers, shims, wooden planks, scaffolding materials hardware items etc. required for temporary works such as supports, scaffoldings are to be arranged by the contractor. Sealing compounds, gaskets, gland packing, wooden/concrete sleepers, for temporary work, required for completion of work except those which are specifically supplied by manufacturing unit are also to be arranged by the contractor.
4.1.2	All the shims, gaskets and packing, which go finally as part of plant equipment, shall be supplied by BHEL free of cost.
4.1.3	It shall be the responsibility of the contractor to plan the activities and store sufficient quantity of consumables. Non-availability of any consumable materials or equivalent suggested by BHEL cannot be considered as reason for not attaining the required progress or for additional claim.
4.1.4	<u>TIG Filler wire for Boiler and Filler wires for Electrodes for P91/T91 piping:</u> These shall be supplied by BHEL free of cost as supplied by BHEL Manufacturing Units as part of regular supply. Required quantity as arrived at by calculation / standards will only be supplied. It would be the contractors' responsibility to account for the consumption of these filler wires. Additional consumption beyond standard / calculated quantity will be at cost recovery basis only unless and otherwise accounted for. Surplus quantity of TIG filler wire, if any, shall be properly stored and returned to BHEL stores.
4.1.5	It shall be the responsibility of the contractor to obtain prior approval of BHEL, regarding suppliers, type of electrodes etc. before procurement of welding electrodes. On receipt of electrodes at site these shall be subjected to inspection and approval by BHEL. The contractor shall inform BHEL details regarding type of electrodes, batch number, date of expiry etc. and produce test certificate for each lot / batch with correlation of batch / lot number with respective test certificate. No

Bharat Heavy Electricals Limited
Rampal, Bagerhat, Bangladesh

SPECIAL CONDITIONS OF CONTRACT (SCC)

Chapter - IV : Obligations of Contractor

	electrode without a valid test certificate will to be used.
4.1.6	BHEL reserves the right to reject the use of any consumable including electrodes, gases, lubricants / special consumables if it is not found to be of the required standard / make / purity or when shelf life has expired. Contractor shall ensure display of shelf life on consumable wherever required and records maintained.
4.1.7	Storage of all consumables including welding electrodes shall be done as per requirement / instruction of the Engineer by the contractor at his cost.
4.1.8	In case of improper arrangement for procurement of any consumable, BHEL reserves the right to procure the same from any source and recover the cost from the Contractor's first subsequent bill at market value plus the departmental charges of BHEL from time to time. Postponement of such recovery is normally not permitted. The decision of Engineer in this regard shall be final and binding on the Contractor.
4.1.9	All lubricants and chemicals required for pre-commissioning, commissioning, testing, preservation and lubricants for trial runs of the equipment shall be supplied by BHEL / BHEL's client. All services including labour and T&P will be provided by the contractor for handling, filling, emptying, refilling etc. The consumption of lubricants / chemicals shall be properly accounted for. Surplus material if any shall be properly stacked/tagged and returned to BHEL/ CUSTOMER stores at no extra cost to BHEL. BHEL reserves the right to recover costs for wastage by the contractor.
4.1.10	Transportation of oil drums, from stores, filling of oil for flushing, first filling, subsequent changeover if any, topping/making up till the unit is fully commissioned and handed over to customer is included in scope of this contract. The contractor shall have to return all the empty drums to BHEL / BHEL's client store at no extra cost. Any loss / damage to above drums shall be to contractor's account.
4.1.11	All charges on account of Octroi, terminal or sales tax and other duties on materials obtained from any source for carrying out the works in the scope of the contractor shall be borne by the contractor.
4.2	TOOLS AND PLANTS / MONITORING AND MEASURING EQUIPMENT (MMEs)
4.2.1	T&Ps and MMEs to be provided by Contractor
4.2.1.1	All T&Ps and MMEs excepting those specifically indicated in BHEL scope are to be provided by the Contractor. Contractor has to make his own arrangement at his cost for completing the formalities (including arrangement of Road permits, if any) if required with Sales Tax/VAT authorities, for bringing their materials, plants and

Bharat Heavy Electricals Limited
Rampal, Bagerhat, Bangladesh

SPECIAL CONDITIONS OF CONTRACT (SCC)
Chapter - IV : Obligations of Contractor

	equipment at site for the execution of work under this contract.
4.2.1.2	All suitable cranes, lifting and transport equipment for material handling at stores/yard/siding of BHEL/Customer are included in scope. BHEL's cranes will not be available for this purpose unless otherwise specifically permitted as per contract conditions
4.2.1.3	All T&Ps to be deployed by the contractor shall have the approval of BHEL Engineer with regard to brand, quality and specification.
4.2.1.4	Indicative list of Major T&Ps in the scope of Contractor are given in the Technical Conditions of Contract. Bidders to note that these are only indicative and as such all other T&P necessary for timely and satisfactory completion of work in scope shall be mobilized by Contractor
4.2.1.5	Timely deployment of adequate T&Ps is the responsibility of the contractor. The contractor shall be prepared to augment the T&P at short notice to match the planned program and to achieve the milestones.
4.2.1.6	Contractor shall maintain and operate his tools and plants in such a way that major breakdowns are avoided. In the event of major breakdown, contractor shall make alternative arrangements expeditiously so that the progress of work is not hampered.
4.2.1.7	In the event of contractor failing to arrange the required tools, plants, machinery, equipment, material or non-availability of the same owing to breakdown, BHEL will make alternative arrangement at the risk and cost of the contractor. Decision of BHEL shall be final and binding on the contractor
4.2.1.8	The T&P to be arranged by the contractor shall be in proper working condition and their operation shall not lead to unsafe condition. The movements of cranes, and other equipment should be such that no damage / breakage occurs to foundations, other equipment, material, property and men. All arrangements for the movement of the T&P etc. shall be the contractor's responsibility.
4.2.1.9	Use of welding generators/ rectifiers only shall be permitted for welding. Use of welding transformers will be subject to specific approval of BHEL engineer.
4.2.1.10	The contractor at his cost shall carry out periodical testing of his construction equipment. Test certificates shall be furnished to BHEL.
4.2.1.11	Contractor shall ensure deployment of serviced and healthy T&Ps including cranes, lifting tackles, wire ropes, manila ropes, winches and slings etc. History card and maintenance records for major T&Ps will be maintained by the contractor and will be made available to BHEL Engineer for inspection as and when required.

SPECIAL CONDITIONS OF CONTRACT (SCC)

Chapter - IV : Obligations of Contractor

	<p>Fitness certificate / Test Certificates of T&P shall have to be submitted before it is put in use. Identification for such T&Ps will be done as per BHEL Engineer's advice.</p> <p>BHEL reserves the right to permit only new slings up to 20 mm and lifting tackles up to 3 MT capacities.</p>
4.2.1.12	<p>Contractor shall ensure deployment of reliable and calibrated MMEs (Inspection measuring and Monitoring equipment). The MMEs shall have test / calibration certificates from authorized / Government approved / accredited agencies traceable to National / International standards. Each MME shall have a label indicating calibration status i.e. date of calibration, calibration agency and due date for calibration. A list of such instruments deployed by contractor at site with its calibration status is to be submitted to BHEL Engineer for control.</p>
4.2.1.13	<p>Re-testing / re-calibration shall also be arranged at regular intervals during the period of use as advised by BHEL Engineer within the contract price. The contractor will also have alternate arrangements for such MME so that work does not suffer when the particular instrument is sent for calibration. If any MMEs not found fit for use, BHEL shall have the right to stop the use of such item. It will be necessary for the contractor to deploy proper item. Any readings taken by the defective instrument will be recalled and repeat the readings taken by that instrument with a proper one. In case he fails to do so, BHEL may deploy MMEs and retake the readings at contractor's cost.</p>
4.2.1.14	<p>BHEL shall have lien on all T&P, MMEs and other equipment of the contractor brought to the site for the purpose of erection, testing and commissioning. BHEL shall continue to hold the lien on all such items throughout the period of contract / extended period. The contractor and / or his sub-contractors, without the prior written approval of the Engineer, shall remove no material brought to the site.</p>
4.2.1.15	<p>The month wise T&P deployment plan to execute the work is to be submitted as per relevant format as per the instruction of BHEL. It shall be the contractor's responsibility to deploy the required T&P, for timely and successful completion of the job, to any extent.</p>
4.2.2	Obligations in respect of T&Ps and MMEs provided by BHEL
4.2.2.1	<p>T&P / MMEs being provided by BHEL to sub-contractor free of hire charges shall be shared by other subcontractors working for BHEL at site and the allotment done by BHEL Engineer shall be final and binding.</p>
4.2.2.2	<p>BHEL T&P will be issued in basic assembled condition. Additional loose components / sub-assemblies / attachments as and when necessary, will be</p>

SPECIAL CONDITIONS OF CONTRACT (SCC)

Chapter - IV : Obligations of Contractor

	issued by BHEL. Assembly of such additional loose components/sub-assemblies/ attachments is in contractor's scope.
4.2.2.3	In case of non-availability of the T&Ps to be provided by BHEL due to breakdown, major overhauls, distribution pattern or any other reason, the contractor shall plan / amend / alter his activities to meet erection / commissioning targets in consultation with BHEL.
4.2.2.4	void
4.2.2.5	The contractor shall engage trained and experienced operators for the operation of BHEL's T&Ps. Their skill / performance will be checked by BHEL Engineer before they are allowed to operate the same. However checking of skills by BHEL does not absolve the contractor of his responsibilities for proper and safe handling of equipment, consistent good performance of operators and regular performance evaluation of operators.
4.2.2.6	<p>The day to day operation and maintenance of BHEL's T&Ps (Other than cranes) shall be carried out by contractor as per manufacturer's / BHEL's maintenance schedule at his cost. The contractor shall arrange, at his own cost, trained operators, fuel and other consumables for their operation. BHEL shall arrange all spares needed for upkeep of major T&Ps provided like Huck Bolting Machine*, DG Set, Induction Machine and Hydraulic Test pumps. The contractor has to arrange for fixing of the spares; supervision in specialized cases will be provided by BHEL. For upkeep of all other T&Ps supplied by BHEL, spares shall be arranged by the Contractor. BHEL supplied T&Ps shall be maintained in good working condition during the entire period of use. T&Ps in defective / damaged condition shall be rectified promptly to the full satisfaction of BHEL engineer. Contractor shall maintain records for maintenance of major T&Ps. These shall be made available for inspection whenever required. In case of any lapses on the part of the contractor, BHEL at its own discretion shall get the servicing / repair of equipment done at the risk and cost of the contractor along with BHEL overheads. Further, if there are breakdowns / damages due to negligence of the contractor, the complete service / repair charges and cost of all the spares damaged with BHEL overheads shall be recovered from contractor's RA bills.</p> <p>*: for operation and maintenance of ESP Huck bolting machine, BHEL shall provide the basic power rig and hose. Balance tooling Sie Guns, chuck jaws etc. are to be arranged by contractor.</p>
4.2.2.7	void

SPECIAL CONDITIONS OF CONTRACT (SCC)

Chapter - IV : Obligations of Contractor

4.2.2.8	Increasing / shortening of the crane boom to suit work requirements shall have to be arranged by the indenting contractor at his cost including restoration to a state as directed by BHEL. All necessary manpower tools, support, consumables, illumination etc. will have to be arranged by contractor at his cost. If required, contractor has to return the crane with original boom.
4.2.2.9	The area and infrastructure development of the area to be carried out by the customer. However in construction projects of this magnitude it is possible that all the areas / approaches may not be ready. In such cases backfilling of approaches where ever necessary, consolidation of ground and arrangement of sleepers / sand bag filling etc. for safe operation / movement of equipment including cranes / trailers etc. shall be the responsibility of the contractor at his cost. No compensation on this account shall be payable.
4.2.2.10	In the event of contractor not using and maintaining BHEL T&Ps according to BHEL's instructions. BHEL will have the right to withdraw such item without any notice and no claim in this regard shall be entertained and contractor shall be responsible for delay in execution on this account.
4.2.2.11	The contractor shall furnish regular utilization report of the BHEL T&Ps, as per requirement of BHEL.
4.2.2.12	Any loss / damage to any part of BHEL T&Ps and MMEs shall be to the contractor's account and any expenditure on these accounts by BHEL will be recovered from the contractor's bill in case the contractor fails to make good the loss.
4.2.2.13	It shall be responsibility of the contractor to take delivery of T&Ps and MMEs from stores or place of use by other contractor at project site, transport the same to site and return the same to BHEL store / place as intimated by Engineer in project site in good working conditions after use.
4.2.2.14	The contractor shall return BHEL T&Ps and MMEs issued to him in good working condition as and when desired by BHEL (on completion or reduction of workload). If contractor delays return of T&P and MME, hire charges as applicable shall be levied by BHEL from time, it was requisitioned till the time of actual return. T&Ps and MMEs returned in damaged / unserviceable condition shall be got repaired by BHEL at its own discretion and entire cost of repair with BHEL overheads shall be recovered from the contractor.
4.2.2.15	Replacement cost including BHEL overheads in respect of irreparable / completely damaged / non return of T&Ps and MMEs shall be recovered from the contractor's

Bharat Heavy Electricals Limited
Rampal, Bagerhat, Bangladesh

SPECIAL CONDITIONS OF CONTRACT (SCC)
Chapter - IV : Obligations of Contractor

	running / final bills
4.2.2.16	Obligations in respect of Cranes provided by BHEL
a)	BHEL will make available the cranes (as per Technical Conditions of Contract) free of charge to the contractor on sharing basis mainly for the purposes enumerated/indicated therein. BHEL cranes have to be shared with other agencies / contractors of BHEL. The allocation of cranes shall be the discretion of BHEL engineer, which shall be binding on the contractor.
b)	BHEL Cranes may be initially issued in basic assembled condition. Any alteration/addition like boom reduction / extension, assembly of components/sub-assemblies needed for modulating the capacity/reach/other features of cranes and restoration to the state as directed by BHEL shall be the contractor's responsibility.
c)	<p>In case the BHEL cranes are not covered under AMC of BHEL, then the day-to-day upkeep and running maintenance like filling / topping up of lubricants, changing filters, etc. including repair of self-starter and dynamo of these cranes shall be the responsibility of the contractor. If on checking it is found that the same is not followed, BHEL will exercise its right to get the job/works done at the risk and cost of contractor.</p> <p>In case BHEL cranes are covered under AMC awarded by BHEL, then the day-to-day upkeep and running maintenance as described above are excluded from scope. However any additional helpers if any required during Preventive/Breakdown Maintenance, Assembly/disassembly shall be provided by contractor at no extra cost.</p> <p>BHEL may also provide cranes through crane hiring agencies in which case the day-to-day upkeep and running maintenance shall be excluded from scope of contractor.</p>
d)	Minor consumables like cotton cloth, cotton waste, etc. is to be supplied by Contractor. All spares and lubricants/grease is excluded from scope. Contractor to give the requirements of these items well in advance in case the cranes provided by BHEL are BHEL owned cranes.
e)	Unless otherwise specified, trained operators for BHEL owned cranes shall be provided by the contractor. These operators should possess valid license for heavy vehicle.
f)	BHEL cranes will be withdrawn for regular and capital maintenance as per the respective schedule of maintenance. As far as possible such schedules will be intimated to the contractor in advance and may be adjusted depending on the work

Bharat Heavy Electricals Limited
Rampal, Bagerhat, Bangladesh

SPECIAL CONDITIONS OF CONTRACT (SCC)
Chapter - IV : Obligations of Contractor

	requirements at site. However no claim whatsoever will be entertained on account of non-availability of cranes.
g)	Where the services of the cranes provided by BHEL are to be shared by other agencies/ contractors of BHEL, the contractor's responsibilities defined above will also be apportioned accordingly to the beneficiary agency. Working arrangements in this regard will be done at site by BHEL engineer and in any case his decision shall be final and binding.
h)	Major breakdowns will be attended to by BHEL. However, in case of breakdowns or damages due to negligence of the contractor, the complete service/repair charges including cost of spares shall be to the account of the contractor, along with BHEL overheads.
4.2.2.17	Obligations in respect of Construction Lift/Elevators provided by BHEL
a)	The total erection including commissioning, maintenance, statutory clearances shall be included in scope of work. Supervision by the original equipment supplier or their authorized agency shall be arranged for by BHEL, in case found necessary.
b)	All day to day and routine maintenance and checking is to be carried out by the contractor as per the recommendations of the supplier. He should periodically check the brakes and carry out the all works to ensure the safety of all those using the lift/elevator. BHEL shall arrange spares required for upkeep of Construction lift/elevator
c)	The construction lift/elevator should never be overloaded as this can lead to serious accidents. Ensuring all safety aspects in operation of the lift shall be the responsibility of the contractor. Erection of all the required number of landing platforms is included in scope. Landing platforms are to be provided with proper barricades and hand railings.
d)	After completion of contractual scope of work or as per BHEL advice, the temporary elevator/lift shall be dismantled and handed over to BHEL neatly identified/tagged. Temporary structures/platforms etc. erected for the elevators/lifts are also to be dismantled and materials to be returned to stores as applicable. The construction and dismantling of the foundations required for the construction/elevator lifts is included in the scope of the contractor.

SPECIAL CONDITIONS OF CONTRACT (SCC)

Chapter – V : Responsibilities of Contractor in respect of Labour, Supervisory Staff, etc.

5.0	RESPONSIBILITIES OF CONTRACTOR IN RESPECT OF LABOUR, SUPERVISORY STAFF, ETC.
5.1	Refer relevant clauses of General Conditions of Contract (GCC) also in this regard
5.2	The contractor shall deploy all the necessary skilled/semiskilled/ unskilled labor including highly skilled workmen etc. These workmen should have previous experience on similar job. They shall hold valid certificates wherever necessary. BHEL reserves the right to insist on removal of any employee of the contractor at any time if he is found to be unsuitable and the contractor shall forthwith remove him.
5.3	Contractor shall also comply with the requirements of local authorities/ project authorities calling for police verification of antecedents of the workmen, staff etc.
5.4	It is the responsibility of the contractor to engage his workmen in shifts and or on overtime basis for achieving the targets set by BHEL. This target may be set to suit BHEL's commitments to its customer or to advance date of completion of events or due to other reasons. The decision of BHEL in regard to setting the erection and commissioning targets will be final and binding on the contractor.
5.5	Contractor shall provide at different elevation suitable arrangement for urinal and drinking water facility with necessary plumbing & disposal arrangement including construction of septic tank. These installations shall be maintained in hygienic condition at all times.
5.6	The Contractor in the event of engaging 20 or more workmen, shall obtain Independent license under the Contract labor (Regulation and Abolition) Act 1970 from the concerned authorities based on Form-V issued by the Principal Employer/Customer. In order to issue Form-V by Customer, Contractor shall fulfill all Statutory requirements like Insurance Policy, PF Code/PF Account number etc. as per the requirement of BHEL/Customer
5.7	Contractor shall deduct the necessary amount towards Provident Fund and contribute equal amount as per Government of India laws. This amount will be deposited regularly to the provident Fund Commissioner. BHEL/Customer may insist for submission of the account code duly certified by PF Commissioner
5.8	Contractor may also be required to comply with provisions of ESI Act in vogue if applicable and submit evidence to BHEL.
5.9	BHEL / customer may insist for witnessing the regular payment to the labor. They may also like to verify the relevant records for compliance with statutory

Bharat Heavy Electricals Limited
Rampal , Bagerhat , Bangladesh

VOLUME-ID

TENDER NO: BHEL: MSTPP: C- RW: CSD: 22:10:06

PAGE 14 OF 47

SPECIAL CONDITIONS OF CONTRACT (SCC)

Chapter – V : Responsibilities of Contractor in respect of Labour, Supervisory Staff, etc.

	requirements. Contractor shall enable such facilities to BHEL / Customer.
5.10	Contractor shall deploy only qualified and experienced engineers/ supervisors. They shall have professional approach in executing the work.
5.11	The contractor's supervisory staff shall execute the work in the most professional manner in the stipulated time. Accuracy of work and aesthetic finish are essential part of this contract. They shall be responsible to ensure that the assembly and workmanship conform to dimensions and tolerances given in the drawings/instructions given by BHEL engineer from time to time.
5.12	The supervisory staff employed by the contractor shall ensure proper outturn of work and discipline on the part of the labour put on the job by the contractor. Also in general they should see that the works are carried out in a safe and proper manner and in coordination with other labour and staff employed directly by BHEL or other contractors of BHEL or BHEL's client.
5.13	It is the responsibility of the contractor to arrange gate pass for all his employees, T&P etc. for entering the project premises. Necessary coordination with customer officials is the responsibility of the contractor. Contractor to follow all the procedures laid down by the customer for making gate passes. Where permitted, by customer / BHEL, to work beyond normal working hours, the contractor shall arrange necessary work permits for working beyond normal working hours.
5.14	The actual deployment will of Labour and Engineer/supervision staff shall be so as to satisfy the erection and commissioning targets set by BHEL. If at any time, it is found that the contractor is not in a position to deploy the required engineers/supervisors/workmen due to any reason, BHEL shall have the option to make alternate arrangements at the contractor's risk and cost. The expenditure incurred along with BHEL overheads thereon shall be recovered from the contractor
5.15	Contractor shall not deploy women labor at night.

SPECIAL CONDITIONS OF CONTRACT (SCC)
Chapter – VI: Material Handling, Storage & preservation

6.0	MATERIAL HANDLING, STORAGE AND PRESERVATION ETC
6.1	MATERIAL HANDLING AND STORAGE
6.1.1	All the equipment/materials furnished under this contract shall be received from the project stores, sheds / storage yards and transported to pre assembly area / erection site and stored in the storage spaces in a manner so that they are easily retrievable till the contractor erects them. While drawing/lifting material from BHEL / customer stores, the contractor shall ensure that the balance / other materials are stacked back immediately. No claim is admissible on this account
6.1.2	While BHEL will endeavor to store / stack / identify materials properly in their open / close / semi closed / tarpaulins covered storage yard / shed, it shall be contractor's responsibility to assist BHEL in identifying materials well in time for erection. They should take the delivery of the same, following the procedure indicated by BHEL, and transport the material safely to pre-assembly yard / erection site in time, according to program.
6.1.3	The contractor shall take delivery of components, equipment / consumables from storage area after getting the approval of BHEL Engineer on standard indent forms.
6.1.4	The contractor shall identify and deploy necessary Engineers / supervisors / workmen for the above work in sufficient number as may be needed by BHEL, for areas covering their scope.
6.1.5	All the equipment shall be handled very carefully to prevent any damage or loss. No untested wire ropes / slings etc. shall be used for unloading / handling. The equipment shall be properly protected to prevent damage either to the equipment or to the floor where they are stored. The equipment from the stores shall be moved to the actual location at the appropriate time so as to avoid damage of such equipment at site.
6.1.6	Contractor shall ensure that while lifting slings shall be put over the points indicated on the equipment or as indicated in the manufacturer's drawings. Slings / shackles of proper size shall be used for all lifting and rigging purposes. All care shall be taken to safe guard the equipment against any damage. Dragging of piping / valves should be avoided. In case of any damage the cost shall be covered from the contractor.
6.1.7	Approach road conditions from the stores / yards to the erection site may not

Bharat Heavy Electricals Limited
Rampal , Bagerhat , Bangladesh

SPECIAL CONDITIONS OF CONTRACT (SCC)
Chapter – VI: Material Handling, Storage & preservation

	be equipped and ideal for smooth transportation of the equipment. Contractor may have to be adequately prepared to transport the materials under the above circumstances without any extra cost. The contractor may familiar himself with soil conditions at site.
6.1.8	Contractor shall be responsible for examining all the plant and materials issued to him and notify the Engineer immediately of any damage, shortage, discrepancy etc. before they are moved out of the stores / storage area. The contractor shall be solely responsible for any shortages or damages in transit, handling, storage and erection of the equipment once received by him. As the erection work will be spread in different areas / locations of the project, contractor has to arrange sufficient number of watch / ward personal to avoid any pilferage of material
6.1.9	The contractor shall maintain an accurate and exhaustive record-detailing out the list of all equipment received by him for the purpose of erection and keep such record open for the inspection of the engineer at any time.
6.1.10	All the material in the custody of contractor and stored in the open or dusty locations must be covered with suitable weather proof / fire retardant covering material wherever applicable and shall be blocked up on raised level above ground. All covering materials including blocks and sleeper shall be arranged by the contractor at his cost.
6.1.11	If the material belonging to the contractor are stored in area other than those earmarked for his operation the engineer will have the right to get it moved to the area earmarked for the contractor at the contractors risk and cost.
6.1.12	The contractor shall be responsible for making suitable indoor storage facilities to store all equipment (drawn by the contractor from BHEL / customer stores), which require indoor storage till the time of their installation. The Engineer will direct the contractor in this regard, which item in his opinion will require indoor storage, and the contractor shall comply with Engineer's decision.
6.1.13	The contractor shall ensure that all surplus / damaged / scrap / unused material, packing wood / containers/ special transporting frames etc. are returned to BHEL at a place in project area identified by the Engineer. The contractor will maintain an account for all items received and returned to BHEL. Any shortage in returning such items shall be chargeable to the contractor except allowable wastage for packing wood only.
6.1.14	The contractor shall hand over all parts / materials remaining extra over the normal requirement with proper identification tags to the stores as directed by

SPECIAL CONDITIONS OF CONTRACT (SCC)
Chapter – VI: Material Handling, Storage & preservation

	the concerned BHEL engineer.
6.1.15	The contractor shall ensure that all the packing materials and protective devices installed on equipment during transit and storage are removed before installation.
6.1.16	It shall be the responsibility of the contractor to keep the work / storage areas in neat, tidy and working conditions. All surplus/unusable packing and other materials shall be removed and deposited at location(s) specified by BHEL within the project premises. If required weighing of the same within the project premises will have to be carried out.
6.2	PRESERVATION OF COMPONENTS
6.2.1	After taking delivery from BHEL / customer's stores, plant materials storage shall be subjected to the following protection besides other provisions indicated in these specifications elsewhere.
6.2.1.1	Items stored outdoors shall be stacked up at least six inches (6") off the ground. Items should not be stored in a low lying area where water logging is a possibility. Contractor should have sufficient numbers of wooden / concrete / steel sleepers for the job.
6.2.1.2	Motors, valves, electrical equipment, control equipment and instruments, and special or precision items requiring special care, etc. shall be stored indoors. Motor windings shall be kept dry by use of external heat or space heaters.
6.2.1.3	Bearings and other wearing surfaces of plant materials shall be protected against corrosion and kept clean and should be regularly monitored.
6.2.1.4	Insulation materials shall be stored indoors or otherwise protected against getting wet/ damaged, using suitable measures and should be protected from direct rain.
6.2.2	It shall be the responsibility of the contractor to apply preservatives / touch up paints (primer) on equipment handled and erected by him till such time of final painting. It shall be contractor's responsibility to arrange for required paints (primer), thinners, labor, scaffolding materials, cleaning materials like wire brush, emery sheets, etc., cleaning of surface and provide one coat of preservatives / paints (primer) from time to time as decided by BHEL engineer. The accepted rate shall include this work also. It is to be noted that such painting may have to be done as and when required till such time the final painting is carried out.
6.2.3	The contractor shall effectively protect the finished work from action of weather

Bharat Heavy Electricals Limited
Rampal , Bagerhat , Bangladesh

SPECIAL CONDITIONS OF CONTRACT (SCC)
Chapter – VI: Material Handling, Storage & preservation

	and from damage or defacement and shall cover the finished parts then and there for their protection.
6.2.4	Any failure on the part of contractor to carry out works according to above clauses will entail BHEL to carry out the job from any other party and recover the cost from contractor.

SPECIAL CONDITIONS OF CONTRACT (SCC)
Chapter – VII: Drawings and documents

7.0	DRAWINGS AND DOCUMENTS
7.1	The detailed drawings, specifications available with BHEL engineers will be made available to the contractor during execution of work at site. The contractor will also ensure availability of all drawings / documents at work place.
7.2	Necessary drawings to carry out the erection work will be furnished to the contractor by BHEL on loan, which shall be returned to BHEL Engineer at site after completion of work. Contractor shall ensure safe storage and quick retrieval of these documents.
7.3	The contractor shall maintain a record of all drawings and documents available with him in a register as per format given by BHEL Engineer. Contractor shall ensure use of pertinent drawings / data / documents and removal of obsolete ones from work place and returning to BHEL.
7.4	The data furnished in various annexure enclosed with this tender specification are only approximate and for guidance. However, the change in the design and in the quantity may occur as is usual in any such large scale of work. The contractors quoted rates shall be inclusive of the above factor
7.5	Should any error or ambiguity be discovered in the specification or information the contractor shall forthwith bring the same to the notice of BHEL before commencement of work. BHEL's interpretation in such cases shall be final and binding on the contractor.
7.6	Deviation from design dimensions should not exceed permissible limit. The contractor shall not correct or alter any dimension / details, without specific approval of BHEL.

SPECIAL CONDITIONS OF CONTRACT (SCC)
Chapter – VIII: Inspection and Quality

8.0	INSPECTION AND QUALITY
8.1	Inspection, Quality Assurance, Quality Control
8.1.1	Preparation of quality assurance log sheets and protocols with customer/ consultants/statutory authority, welding logs, NDE records, testing & calibration records and other quality control and quality assurance documentation as per BHEL engineer's instructions, is within the scope of work/specification. These records shall be submitted to BHEL/customer for approval from time to time.
8.1.2	The protocols between contractor and customer/ BHEL shall be made prior to installation for correctness of foundations, materials, procedures, at each stage of installation, generally as per the requirement of customer/ BHEL. This is necessary to ensure elimination of errors or keeping them within tolerable limits and to avoid accumulation and multiplication of errors.
8.1.3	<p>A daily log book should be maintained by every supervisor/engineer of contractor on the job in duplicate (one for BHEL and one for contractor) for detailing and incorporating alignment/clearance / centering / leveling readings and inspection details of various equipment etc.</p> <p>High pressure welding details like serial number of weld joints, welders name, date of welding, details of repair, heat treatment etc. will be documented in welding log as per BHEL Engineer's instructions.</p> <p>Record of radiography containing details like serial number of weld joints, date of radiography, repairs, if any, re-shots etc. shall also be maintained as per BHEL Engineer's instructions.</p> <p>Record of heat treatments performed shall be maintained as prescribed by BHEL</p>
8.1.4	The performance of welders will be reviewed from time to time as per the BHEL standards. Welders' performance record shall be furnished periodically furnished for scrutiny of BHEL's Engineer. Corrective action as informed by BHEL shall be taken in respect of those welders not conforming to these standards. This may include removal/ discontinuance of concerned welder(s). Contractor shall arrange for the alternate welders immediately
8.1.5	All the welders shall carry identity cards as per the proforma prescribed by BHEL/Customer/Consultant. Only welders duly authorized by

SPECIAL CONDITIONS OF CONTRACT (SCC)
Chapter – VIII: Inspection and Quality

	BHEL/customer/consultant shall be engaged on the work.
8.1.6	Contractor shall provide all the Measuring Monitoring Equipment (MMEs) required for completion of the work satisfactorily. These MMEs shall be of brand, quality and accuracy specified by BHEL Engineer and should have necessary calibration and other certificates as per the requirement of BHEL Engineer. Decision of BHEL Engineer regarding acceptance or otherwise of the measuring instruments/gauges/tools for the work under this specification, is final and binding on the contractor. BHEL may give an indicative list of MMEs required for this work and to be made available by the contractor. The list will be reviewed by BHEL and the contractor shall meet any augmentation needed wherever required.
8.1.7	It is the responsibility of the contractor to prove the accuracy of the testing/measuring/calibrating equipment brought by him based on the periodicity of calibration as called for in the BHEL's quality assurance standards/BHEL Engineer's instructions.
8.1.8	Any re-laying or re-termination of cables/re-erection of instruments/recalibration of instruments etc. required due to contractor's mistake or design requirement and found at any stage inspection, shall be carried out by the contractor at no extra cost.
8.1.9	BHEL, Power Sector Regions (PSNR/PSER/PSWR/PSSR) have already been accredited with ISO 9001 certification and as such this work is subject to various audits to meet ISO 9001 requirements. One particular aspect which needs special mention is about arrangement of calibration of instruments by the contractor. Contractor shall ensure deployment of reliable and calibrated MMEs (Measuring and Monitoring Equipment). The MMEs shall have test / calibration certificates from authorized / Government approved / Accredited agencies traceable to National / International Standards. Re-testing / recalibration shall also be arranged at regular intervals during the period of use as advised by BHEL Engineer within the contract price. The contractor will also have alternate arrangements for such MMEs so that work does not suffer when the particular equipment / instrument is sent for calibration. Also if any MMEs not found fit for use, BHEL shall have the right to stop the use of such item and instruct the contractor to deploy proper item and recall i.e. repeat the readings taken by that instrument, failing which BHEL may deploy MME and retake the readings at Contractor's cost.

SPECIAL CONDITIONS OF CONTRACT (SCC)
Chapter – VIII: Inspection and Quality

8.1.10	Re-work necessitated on account of use of invalid MMEs shall be entirely to the contractor's account. He shall be responsible to take all corrective actions, including resource augmentation if any, as specified by BHEL to make-up for the loss of time.
8.1.11	In the courses of erection, it may become necessary to carry repeated checks of the work with instruments recently calibrated, re-calibrated. BHEL may counter/ finally check the measurements with their own MMEs. Contractor shall render all assistance in conduct of such counter/final measurements.
8.1.12	Total Quality is the watchword of the work and Contractor shall strive to achieve the Quality Standards, procedures laid down by BHEL. He shall follow all the instructions as per BHEL drawings and Quality Standards.
8.2	Stage Inspection By FES/QA Engineers
8.2.1	Apart from day-to-day inspection by BHEL Engineers stationed at Site and Customer's Engineers, stage inspection of equipment under erection and commissioning at various stages shall also be conducted by teams of Engineers from Field Engineering Services of BHEL's Manufacturing Units, Quality Assurance teams from Field Quality Assurance, Unit/Factory Quality Assurance and Commissioning Engineers from Technical Services etc. Contractor shall arrange all labor, tools and tackles etc. along with proper access for such stage inspections free of cost.
8.2.2	Any modifications suggested by BHEL FES and QA Engineers' team shall be carried out. Claims of contractor, if any, shall be dealt as per Section 13, and provided such modifications have not arisen for reasons attributable to the contractor.
8.3	Statutory Inspection of Work
8.3.1	The work to be executed under these specifications has to be offered for inspection, at appropriate stages of work completion, to various statutory authorities for compliance with applicable regulations. The work related statutory inspections, though not limited to, are as under: <ol style="list-style-type: none"> 1) Inspectorate of Steam Boilers and Smoke Nuisance 2) Electrical Inspector 3) Factory Inspector, Labour Commissioner, PF Commissioner and other authority connected to this project work

Bharat Heavy Electricals Limited
Rampal, Bagerhat, Bangladesh

SPECIAL CONDITIONS OF CONTRACT (SCC)
Chapter – VIII: Inspection and Quality

	The scope includes getting the approvals from the statutory authorities, which includes arranging for inspection visits of statutory authority periodically as per BHEL Engineer’s instructions, arranging materials for ground inspection, taking rub outs for the pressure parts to be offered for inspection, submitting co-related inspection reports, documents, radiographs etc and following up the matter with them. Contractor shall also make all arrangements for offering the Products / Systems for inspection at location, as applicable, to the concerned authority.
8.3.2	Contractor should be qualified to execute pressure parts & piping work coming under the purview of IBR, for which he should register himself with CIB of state concerned. contractor also should be aware of the latest IBR regulations and Electricity Act, including the amendments thereof.
8.3.3	Contractor shall comply with ‘Qualification Tests for welders engaged in welding of Boilers and Steam Pipes under Construction, Erection and Fabrication at Site in India and in repairing Boilers and steam pipes by welding’ in line with Chapter XIII of Indian Boiler Regulations-1950, for testing his welders / men / workers, including all associated fees, procedures, required instruments and equipment and their calibration there of. It shall be contractor’s responsibility to obtain approval of Statutory Authorities, wherever applicable, for the conducting of any work which comes under the purview of these authorities, at his cost.
8.3.4	The following fees shall be excluded from scope of Contractor: 1. Registration Fee as per Regulation 385 of Chapter IX of Indian Boiler Regulations-1950 2. Fees for inspection of Boiler at the site of Construction as per Regulation 395 A, sl no 4 of Chapter IX of Indian Boiler Regulations-1950 However all other fees like visit fees charged by the Boiler Inspector and other arrangements for his visit or visits till satisfactory completion of work, shall be included in scope of Contractor
8.4	The Quality Management System of BHEL, Power Sector Regions (PSNR/PSER/PSWR/PSSR) have already been certified and accredited under ISO 9002 standards in this regard. The basic philosophy of the Quality Management System is to define the organizational responsibility, work as per

SPECIAL CONDITIONS OF CONTRACT (SCC)
Chapter – VIII: Inspection and Quality

	<p>documented procedures, verify the output with respect to acceptance norms, identify the non-conforming product/ procedure and take corrective action for removal of non-conformance specifying the steps for avoiding recurrence of such non-conformities, & maintain the relevant quality records. The nonconformities are to be identified through the conduct of periodical audit of implementation of quality systems at various locations/stages of work. Suppliers/vendors of various products/services contributing in the work are also considered as part of the quality management system. .as such the contractor is expected not only to conform to the quality management system of BHEL but also it is desirable that they themselves are accredited under any quality management system standard.</p>
8.5	Field Quality Assurance
8.5.1	<p>Contractor shall carry out all activities conforming to the approved Field Quality Plan (FQP) as revised from time to time. Total quality shall be the watchword of the work and contractor shall strive to achieve the quality standards, procedures laid down by BHEL. He shall follow all the instructions as per BHEL drawings and quality standards. Contractor shall provide the services of quality assurance engineer as per the relevant clauses.</p>

SPECIAL CONDITIONS OF CONTRACT (SCC)

Chapter - IX: HSE & OHSAS

9.0	OCCUPATIONAL HEALTH, SAFETY & ENVIRONMENT MANAGEMENT/ QUALITY ASSURANCE PROGRAM : BHEL, Power Sector Regions (PSNR/ER/WR/SR) are each certified for ISO 9001. Quality of work to customer's satisfaction and fulfillment of system requirements are the essence of ISO 9001 certification. BHEL, PS Regions have HSE certification (ISO 14001 & OHSAS 18001) and therefore Contractor also shall organize/ plan/ perform all their activities to meet with the applicable requirements of these standards.
9.1	HSE (Health, safety & Environment): Contractor will comply with HSE (Health, safety & Environment) requirements of BHEL. HSE requirements in brief, are given below :-
9.1.1	Contractor will nominate one of their qualified and experienced employees as Safety Officer, who will be responsible for all HSE related issues of contractors work area. Safety Officer will have authority to stop any activity, in case he observes that the activity is not being carried out in safe manner. He will conduct surprise inspection as well as periodic inspection/drill (at least once in a month) and submit such reports to BHEL. He will conduct periodic meetings with supervisors of different working groups and explain HSE issues and use of PPEs to them. Reports of such meetings will be submitted to BHEL. Contractor will develop suitable work procedures based upon HSE guidelines and OCPs and implement it. Such work procedures will consist of Area of work, T&P Details, Work Procedure, PPE requirements etc. Please refer Schedule VIII of BOCW Rules for number of safety officers, qualification, duties etc. Contractor should highlight the requirement of safety to staff and labor through daily tool box meeting before start of the days job. Contractor to also submit monthly safety reports as per the format/procedure of BHEL.
9.1.2	The contractor shall arrange induction and regular health check of their employees as per schedule VII of BOCW rules by are registered medical practitioner. The contractor shall take special care of the employees affected with occupational diseases under rule 230 and schedule II of BOCW Rules. The employees not meeting the fitness requirement should not be engaged for such job
9.1.3	Following personnel protective equipment (PPEs), in adequate numbers, will be

Bharat Heavy Electricals Limited

Rampal, Bagerhat , Bangladesh

VOLUME-ID

TENDER NO: BHEL: MSTPP: C- RW: CSD: 22:10:06

PAGE 26 OF 47

SPECIAL CONDITIONS OF CONTRACT (SCC)

Chapter - IX: HSE & OHSAS

	made available at site & their regular use by all concerned will be ensured :-
	- HELMET
	- SAFETY GOGGLES & WELDING FACE SHIELDS
	- SAFETY BELTS AND PROTECTIVE NET FOR WORKING AT HEIGHT
	- SAFETY SHOES
	- EAR PLUG
	- ANY OTHER SAFETY EQUIPMENT REQUIRED FOR SAFE COMPLETION OF THE WORK
	Contractor to also submit monthly reports on above as per the format/procedure of BHEL.
9.1.4	Providing appropriate First Aid facilities for prompt treatment of injuries and illness at work place. Arranging training to contractor workmen/ employees for giving first aid.
9.1.5	Arranging ambulance in case of any emergency situation .
9.1.6	Identification of nearest hospital and health check-up of workmen/employees
9.1.7	Providing filtered drinking water at work place in cool container.
9.1.8	Providing Canteen, Rest Room, Washing facilities to the contracted employees as per provisions of Contract Labour Regulation Act 1970 (Chapter V).
9.1.9	Providing appropriate fire fighting equipment at designated work place and nominate a fire officer/warden adequately trained for his job.
9.1.10	Identification of nearest fire station and display contact telephone nos. / person's name around work places for cases of emergencies .
9.1.11	Providing adequate no. of 24 V sources and ensure that no hand lamps are operating at voltage level above 24 Volts.
9.1.12	Fulfilling safety requirements at all power tapping points.
9.1.13	Red & White caution tape of proper width(1.5 to 2 inch) to be used for cordoning unsafe area such as open trench, excavation area etc.
9.1.14	Providing contractors company logo on cloths /uniform/ proper identity cards with photographs, for correct identification of people working at project site .
9.1.15	High/ Low pressure welders to be identified with separate colourclothings. No welders will be deployed without passing appropriate tests and holding valid welding certificates. Approved welding procedure should be displayed at work place.
9.1.16	Displaying safe handling procedures for all chemicals such as lube oil, acid, alkali, sealing compounds etc , at work place .

Bharat Heavy Electricals Limited

Rampal, Bagerhat , Bangladesh

VOLUME-ID

TENDER NO: BHEL: MSTPP: C- RW: CSD: 22:10:06

PAGE 27 OF 47

SPECIAL CONDITIONS OF CONTRACT (SCC)

Chapter - IX: HSE & OHSAS

9.1.17	All scaffolding/ platforms should be made from materials of appropriate quality/grade so that these are safe for use. It should be certified/declared safe for use by an experienced contractor person, before any scaffolding/platform is used. Please refer IS:3696 part 1&2 and 4014 part 1 & 2
9.1.18	All T&Ps/ MMEs should be of reputed brand/appropriate quality & must have valid test/calibration certificates bearing endorsement from competent authority of BHEL.. Contractor to also submit monthly reports of T&Ps deployed and validity test certificates to BHEL safety Officer as per the format/procedure of BHEL.
9.1.19	Ensure that the regulatory requirement of excessive weight limit (to carry/lift/ move weights beyond prescribed limits) for male and female workers are complied with.
9.1.20	Safety slogan, Safety/ Caution boards, wherever required to be displayed in consultation with BHEL.
9.1.21	Take suitable measures for waste management and environment related laws/legislation as a part of normal construction activities. Compliance with the legal requirements on storage/ disposal of paint drums (including the empty ones), Lubricant containers, Chemical Containers, and transportation and storage of hazardous chemicals will be strictly maintained. Ensure proper cleanliness of work place, housekeeping and waste management (including proper waste disposal) on daily basis.
9.1.22	It is imperative on the part of the contractor to join and effectively contribute in joint measures such as tree plantation, environment protection, contributing towards social upliftment, conversion of packing woods to school furniture, keeping good relation with local populace etc.
9.1.23	The contractor shall carry out periodic air and water quality check and illumination level checking in his area of work place and take suitable control measure.
9.1.24	The Contractor is required to provide proper safety net systems (IS-11057) where ever the hazard of fall from height is present as per instruction of BHEL Engineer. The safety nets shall be fire resistant, duly tested and shall be of ISI Mark and the nets shall be located as per site requirements to arrest or to reduce the consequences of a possible fall of persons working at different heights.
9.1.25	All applicable OCPs (Operational control procedures) will be followed by contractor as per BHEL instructions. This will be done as part of normal scope of work. List of such OCPs is given below . In case any other OCP is found to

Bharat Heavy Electricals Limited

Rampal, Bagerhat , Bangladesh

VOLUME-ID

TENDER NO: BHEL: MSTPP: C- RW: CSD: 22:10:06

PAGE 28 OF 47

SPECIAL CONDITIONS OF CONTRACT (SCC)

Chapter - IX: HSE & OHSAS

be applicable during the execution of work at site, then contractor will follow this as well, within quoted rate. These OCPs (applicable ones) will be made available to contractor during work execution at site. However for reference purpose, these are kept with Safety Officer of BHEL at the Power Sector Regional HQ, or available in downloadable format in the website, which may be referred by contractor, if they so desire.

■	OCP for safe handling of chemicals
■	OCP for Electrical safety
■	OCP for energy conservation
■	OCP for safe welding and gas cutting operation
■	OCP for fire safety
■	OCP for safety in use of hand tools
■	OCP for first aid
■	OCP for food safety at canteen
■	OCP for safety in use of cranes
■	OCP for storage and handing of gas cylinders
■	OCP for manual arc welding
■	OCP for safe use of helmets
■	OCP for good house keeping
■	OCP for working at height
■	OCP for safe excavation
■	OCP for safe filling of Hydrogen in cylinder
■	OCP for illumination
■	OCP for handling and erection of heavy metals
■	OCP for safe acid cleaning
■	OCP for safe alkali boil out
■	OCP for safe oil flushing
■	OCP for steam blowing
■	OCP for safe working in confined area
■	OCP for safe operation of passenger lift, material hoists & cages
■	OCP for Vehicle maintenance
■	OCP for safe radiography
■	OCP for waste disposal
■	OCP for working at night
■	OCP for blasting
■	OCP for DG Set
■	OCP for handling & storage of mineral wool

Bharat Heavy Electricals Limited

Rampal, Bagerhat , Bangladesh

SPECIAL CONDITIONS OF CONTRACT (SCC)
Chapter - IX: HSE & OHSAS

	■ OCP for drilling, reaming and grinding(machining) etc.
	■ OCP for hydraulic test
	■ OCP for spray insulation
	■ OCP for trial run of rotary equipment
	■ OCP for stress relieving
	■ OCP for material preservation
	■ OCP for cable laying/tray work
	■ OCP for electrical maintenance
	■ OCP for transformer charging
	■ OCP for safe handling of battery system
	■ OCP for computer operation
	■ OCP for storage in open yard
	■ OCP for sanitary maintenance
	■ OCP for batching
	■ OCP for piling rig operation
	■ OCP for gas distribution test
	■ OCP for cleaning of hotwell / deaerator
	■ OCP for electro-resistance heating
	■ OCP for compressor operation
	■ OCP for O&M of control of AC plant & system
	■ OCP for air compressor
	■ OCP for passivation
	■ OCP for Safe EDTA Cleaning
	■ OCP for Safe Chemical cleaning of Pre boiler system
	■ OCP for Safe Boiler Light up
	■ OCP for Safe Rolling and Synchronisation
	■ OCP for Safe Loading of Unit
9.2	<p>SAFETY AND CLEANLINESS :</p> <p>The contractor shall take all necessary safety precautions and arrange for appropriate appliances as per discretion of BHEL or its authorized officials (Site Construction Manager) to prevent loss of human lives, injuries, to personnel engaged and damage to property. Before commencing the work, the contractor shall submit a "Safety Plan" to the above authorized BHEL official and obtain approval on the same. The safety plan shall indicate in detail the measures that would be taken by the contractor to ensure safety of men, equipment, materials and environment during execution of the work. This will also include an organization structure, role and responsibilities of the concerned key</p>

SPECIAL CONDITIONS OF CONTRACT (SCC)

Chapter - IX: HSE & OHSAS

	personnel, the safety practices that will be followed, PPEs deployed, plan for handling critical activities and emergencies.
9.3	If the contractor fails to take appropriate safety precautions or to provide necessary safety devices and equipment or to carry out instructions issued by the authorized BHEL official, BHEL shall have the right to take corrective steps at the risk and cost of the contractor.
9.4	During the course of construction, alternation or repairs, scrap with protruding nail, sharp edge etc. and all other debris shall be kept clean from working areas, passage, ways and stairs in and around site.
9.5	Combustible scrap and debris shall be removed at regular intervals during the course of execution. Safe means shall be provided to facilitate such removal. The combustible scrap should be stored in safe place away from the plant materials to avoid fire accidents. The area shall be chosen in consultation with the Engineer and to be cordoned off.
9.6	Rigging equipment for materials handling shall be inspected prior to use in each shift and as necessary during its use to ensure that it is safe. Defective rigging equipment will be removed from service.
9.7	Rigging equipment shall not be loaded in excess of its recommended safe working load. Rigging equipment, when not in use, shall be removed from the original work area so as not to present a hazard to employees.
9.8	Contractor shall notify the engineer, of his intention to bring on to site any equipment or any container, with liquid or gaseous fuel or other substance which may create a hazard. The Engineer shall have the right to prescribe the condition under which such equipment or container may be handled and used during the performance of the works and the contractor shall strictly adhere to such instructions. The Engineer shall have the right to inspect any construction tool and to forbid its use, if in his opinion it is unsafe. No claim due to such prohibition will be entertained.
9.9	Where it is necessary to provide and/or store petroleum products or petroleum mixture & explosives, the contractor shall be responsible for carrying out such provision / storage in accordance with the rules & regulations laid down in the relevant petroleum act, explosive act and petroleum and carbide of calcium manual, published by the chief inspector of explosives of India. All such storage shall have prior approval if necessary from the chief inspector of explosives or any other statutory authority. The contractor shall be responsible for obtaining

Bharat Heavy Electricals Limited

Rampal, Bagerhat, Bangladesh

VOLUME-ID

TENDER NO: BHEL: MSTPP: C- RW: CSD: 22:10:06

PAGE 31 OF 47

SPECIAL CONDITIONS OF CONTRACT (SCC)
Chapter - IX: HSE & OHSAS

	the same.
9.10	Cylinders shall be moved by tilting and rolling them on their bottom edges. They shall not be intentionally dragged, struck or permitted to strike each other violently.
9.11	When cylinders are transported by powered vehicle they shall be secured in a vertical position.
9.12	All workmen of the contractor working on construction area shall wear safety shoes, hand gloves, safety helmets and safety belt as applicable. The contractor shall provide to its workforce and ensure the use of following personnel protective equipment as found necessary and as directed by BHEL.
9.12.1	Safety Helmets conforming to IS-2925 : 1984
9.12.2	Safety Belts conforming to IS-3521:1983
9.12.3	Safety Shoes conforming to IS-1989 : 1978
9.12.4	Eye and face protection devices conforming to IS – 1179:1967, IS 5983:1980, IS 8521 Part 1:1977, IS 8521 Part 2: 1994.
9.12.5	Hand and body protection devices conforming to IS 4770:1991 and IS- 6994 : Part 1: 1973, IS – 8619 : 1977
9.12.6	Ear protection IS-9167:1979
9.12.7	Respiratory Protective Devices as per IS-9473:2002, i4746:1999 and 14166:1994
9.13	The contractor shall insure his workmen against all accidents and the policy shall be presented to BHEL Engineer on demand. Other wise, BHEL will arrange the same and the expenditure towards this will be debited to the contractor. In case of a fatal or disabling injury accident to any person at construction site due to lapses by the contractor, the victim and/or his/her dependents shall be compensated by the contractor as per statutory requirements. However, if considered necessary BHEL shall have the right to impose appropriate financial penalty on contractor and recover the same from payments due to the contractor for suitably compensating the victim and/or his/her dependence before imposing any such penalty. Appropriate enquiry shall be held by BHEL giving opportunity to the contractor for presenting his case. Above safety conditions are not exhaustive but gives an idea for the contractor and contractor shall adhere to all safety precaution given by the

SPECIAL CONDITIONS OF CONTRACT (SCC)
Chapter - IX: HSE & OHSAS

	Engineer at site.
9.14	The contractor shall arrange at his cost adequate lighting facilities e.g. flood lighting, hand lamps, area lighting etc. at various levels for safe and proper working operations during night hours at the work spot as well as at the pre-assembly area.
9.15	The contractor shall be responsible for provision of all the safety notices and safety equipment as enjoined on him by the application of relevant statutory regulation / provisions and/or as called upon by BHEL from time to time. He shall be held responsible for any violation of statutory regulations (local, state or central) and BHEL instruction that may endanger safety of men, equipment and material.
9.16	The contractor shall provide temporary fencing wherever required as a safety measure against accident and damage to properties. Suitable caution notices shall be displayed where access to any part is found to be unsafe and hazardous.
9.17	Contractor shall ensure safety of all the workmen, material and equipment either belonging to him or to others working at site. He shall observe safety rules and codes applied by BHEL without exception.
9.18	It will be the responsibility of the contractor to ensure safe lifting of the equipment, taking due precaution to avoid any accident and damage to other equipment and personnel. All requisite tests and inspection of handling equipment, tools & tackle shall be periodically done by the contractor by engaging only the COMPETENT PERSONS as per law. Defective equipment or uncertified shall be removed from service. Any equipment shall not be loaded in excess of its recommended safe working load.
9.19	The contractor shall provide necessary first aid facilities as per schedule III. In addition, ambulance facilities, OHC and CMO as per schedule IV, V, X and XI of BOCW Rules as applicable for all his employees, representatives and workmen at site and BHEL shall have no obligation in this regard. The first aid boxes should be placed at various elevations so as to make them available within the reach and at the quickest possible time. The contractor should conduct periodical first –aid classes to keep his supervisor and Engineers properly trained for attending to any emergency.
9.20	Training

SPECIAL CONDITIONS OF CONTRACT (SCC)
Chapter - IX: HSE & OHSAS

9.20.1	The contractor shall arrange induction safety training for all employees before assigning work. In addition, awareness program , mock drill at regular intervals and daily tool box meetings shall be arranged. Monthly report of the above to be given to BHEL safety Officer as per prescribed BHEL formats
9.20.2	All the contractor's supervisory personnel and sufficient number of workers shall be trained for fire protection systems. Enough number of such trained personnel must be available during the tenure of contract. Contractor should nominate his supervisor to coordinate and implement the safety measures.
9.21	Contractor shall provide enough fire protecting equipment of the types and numbers at his office, stores, temporary structure in labor colony etc. Such fire protection equipment shall be easy and kept open at all times. The fire extinguishers shall be properly refilled and kept ready which should be certified at periodic intervals. The date of changing should be marked on the Cylinders. All other fire safety measures as laid down in the "codes for fire safety at construction site" issued by safety coordinator of BHEL shall be followed. Non-compliance of the above requirement under fire protection shall in no way relieve the contractor of any of his responsibility and liabilities to fire accident occurring either to his materials or equipment or those of others. Emergency contacts nos must be displayed at prominent locations
9.22	The contractor shall at his cost, remove from vicinity of work at least once each day all combustible waste, scrap, panting materials, rubbish, unused or other materials and deposit them in places specified by BHEL to keep the work site clear and tidy. Use of undercoated canvas paper, corrugated paper, fabricated carton, plastic or other flammable materials shall be restricted to the minimum and promptly removed.
9.23	The contractor shall not use any hand lamp energized by Electric power with supply voltage of more than 24 volts in confined spaces like inside water boxes, turbine casings, condensers etc.
9.24	All portable electric tools used by the contractor shall have safe plugging system to source of power and be appropriately earthed. Only electricians licensed by appropriate statutory authority shall be employed by the contractor to carry out all types of electrical works. Details of earth resource ad their test date to be given to BHEL safety officer as per the prescribed formats of BHEL
9.25	In case of any delay in completion of a job due to mishaps attributable to lapses by the contractor, BHEL shall have the right to recover cost of such delay from

SPECIAL CONDITIONS OF CONTRACT (SCC)
Chapter - IX: HSE & OHSAS

	the payments due to the contractor, after notifying the contractor suitably.
9.26	Valve protection caps shall be kept in place and secured.
9.27	The contractor shall be responsible for the safe storage and handling of his radio-active sources as per BARC rules and regulations.
9.28	Tarpaulin being inflammable should not be used (instead, only non infusible covering materials shall be used) as protective cover while preheating, welding, stress relieving etc. at site.
9.29	If the contractor fails to improve the standards of safety in its operation to the satisfaction of BHEL after being given reasonable opportunity to do so and/or if the contractor fails to take appropriate safety precautions or to provide necessary safety devices and equipment or to carry out instruction regarding safety issued by BHEL, BHEL shall have the right to take corrective steps at the risk and cost of the contractor after giving a notice of not less than 7 days indicating the steps that would be taken by BHEL.
9.30	If the contractor succeeds in carrying out its job in time with out any fatal or disabling injury accident and without any damage to property BHEL may, at its sole discretion, favorably consider to reward the contractor suitably for the performance.
9.31	The contractor shall carefully follow the safety requirement of BHEL/ the purchaser with the regard to voltages used in critical areas.
9.32	The contractor shall use only properly insulated and armored cables which conform to the requirement of Indian Electricity Act and Rules for all wiring, electrical applications at site. BHEL reserves the right to replace any unsafe electrical installations, wiring, cabling etc. at the cost of the contractor. All electrical appliances used in the work shall be in good working condition and shall be properly earthed. No maintenance work shall be carried out on live equipment. The contractor shall maintain adequate number of qualified electricians to maintain his temporary electrical installations. Area wise Electrical safety inspection is to be carried out on monthly basis as per "Electrical Safety Inspection checklist' and the report is to be submitted to BHEL safety officer
9.33	The contractor shall arrange adequate number of persons specifically for clearing any debris and for house keeping of the erection area including restacking of components in the erection areas. Housekeeping to be carried out

SPECIAL CONDITIONS OF CONTRACT (SCC)

Chapter - IX: HSE & OHSAS

	as per BHEL's checklist and report is to be submitted to BHEL safety officer
9.34	In case of any damage to property due to lapses by the contractor, BHEL shall have the right to recover the cost of such damages from the contractor after holding an appropriate enquiry.
9.35	The contractor shall submit report of all accidents, fires and property damage etc. to the Engineer immediately after such occurrence, but in any case not later than 24 hours of the occurrence. Such reports shall be furnished in the manner prescribed by BHEL. In addition periodic reports on safety shall also be submitted by the contractor to BHEL from time to time as prescribed by the Engineer. Compiled monthly reports of all kinds of accidents, fires and property damage to be submitted to BHEL safety officer as per prescribed formats
9.36	Before commencing the work, the contractor shall appoint/nominate a responsible person to supervise implementation of all safety measures and liaison with his counterpart of BHEL.
9.37	Suitable scaffolds shall be provided for workman for all works that cannot safely be done from the ground, or from solid construction except in the case of short duration of work which can be done safely from ladders. When a ladder is used, it shall be of rigid construction made of steel. The steps shall have a minimum width of 45 cm and a maximum rise of 30 cm. Suitable handholds of good quality wood or steel shall be provided and the ladder shall be given an inclination not steeper than $\frac{1}{4}$ horizontal and 1 vertical.
9.38	Scaffolding or staging more than 3.6 m above the ground floor, swung or suspended from an overhead support or erected with stationery support shall have a guard rail properly bolted, braced or otherwise secured, at least 90 cm above the floor or platform of such scaffolding or staging and extending along the entire length of the out side and ends thereof with only such openings as may be necessary for the delivery of materials. Such scaffolding or staging shall be so fastened as to prevent it from savor, from swaying, from the building or structure.
9.39	Working platforms, gangways and stairways shall be so constructed that they do not sag unduly or unequally and if the height of the platform gangways provided is more than 3.6 m above ground level or floor level, they shall be closely boarded and shall have adequate width which shall not be less than 750 mm and be suitably fenced as described above.

Bharat Heavy Electricals Limited

Rampal, Bagerhat, Bangladesh

VOLUME-ID

TENDER NO: BHEL: MSTPP: C- RW: CSD: 22:10:06

PAGE 36 OF 47

SPECIAL CONDITIONS OF CONTRACT (SCC)

Chapter - IX: HSE & OHSAS

9.40	Every opening in the floor or a building or in a working platform shall be provided with suitable means to prevent the fall of persons or materials by providing suitable fencing or railing whose minimum height shall be 90 cm.
9.41	Wherever there are open excavation in ground, they shall be fenced off by suitable railing and danger signals installed at night so as to prevent persons slipping into the excavations.
9.42	Safe means of access shall be provided to all working places. Every ladder shall be securely fixed. No portable single ladder shall be over 9 m in the length while the width between side rails in rung ladder shall in no case be less than app. 29.2 cm for ladder upto and including 3 m in length. For longer ladders this width shall be increased at least ¼” for each additional foot of length.
9.43	A sketch of the ladders and scaffolds proposed to be used shall be prepared and approval of the Engineer obtained prior to Construction.
9.44	All personnel of the Contactor working within the plant site shall be provided with safety helmets. All welders shall wear welding goggles while doing welding work and all metal worker shall be provided with safety gloves. Persons employed on metal cutting and grinding shall wear safety glasses.
9.45	Adequate precautions shall be taken to prevent danger for electrical equipment. No materials on any of the sites of work shall be so stacked or placed as to cause danger or inconvenience to any person or the public.
9.46	All trenches, four feet or more in depth, shall at all times be supplied with at least one ladder for each 30 m in length or fraction thereof. The ladder shall be extended from bottom of the trench to at least 90 cm above the surface of the ground. Sides of the trenches which are 1.50 m or more in depth shall be stepped back to give suitable slope or securely held by timer bracing, so as to avoid the danger of sides collapsing. The excavated materials shall not be placed within 1.5 m of the edges of the trench or half of the depth of the trench whichever is more. Cutting shall be done from top to bottom. Under no circumstances undermining or undercutting shall be done.
9.47.1	The contractor shall take permission of BHEL prior to risky jobs such as working at height, hot work, lifting activities, etc. through permits. No job should be started without permits.
9.47.2	The Contactor shall take all measures at the sites of the work to protect all persons from accidents and shall be bound to bear the expenses of defense of

Bharat Heavy Electricals Limited

Rampal, Bagerhat , Bangladesh

VOLUME-ID

TENDER NO: BHEL: MSTPP: C- RW: CSD: 22:10:06

PAGE 37 OF 47

SPECIAL CONDITIONS OF CONTRACT (SCC)

Chapter - IX: HSE & OHSAS

	every suit, action or other proceeding at law that may be brought by any persons for injury sustained or death owing to neglect of the above precautions and to pay any such persons such compensation or which may with the consent of the Contractor be paid to compromise any claim by any such person should such claim proceeding be filed against BHEL, the Contractor hereby agrees to indemnify BHEL against the same.
9.48	Before any demolition work is commenced and also during the process of the work the following shall be ensured:
9.48.1	All roads and open areas adjacent to the work site shall either be closed or suitably protected.
9.48.2	No electric cable or apparatus which is liable to be a source of danger nor a cable or an apparatus used by the operator shall remain electrically charged.
9.48.3	All practical steps shall be taken to prevent danger to persons employed from the risks of fire or explosion or flooding. No floor, roof or other part of the building shall be so overloaded with debris or materials as to render them unsafe.
9.49	All necessary personnel safety equipment as considered adequate by the Engineer should be kept available for the use of the persons employed in the Site and maintained in a condition suitable for immediate use and the Contractor should take adequate steps to ensure proper use of equipment by those concerned.
9.49.1	Workers employed on mixing asphalted materials, cement and lime mortars shall be provided with protective foot wear and protective goggles.
9.49.2	Those engaged in white washing and mixing or stacking of cement bags or any materials which is injurious to the eyes shall be provided with protective goggles.
9.49.3	Those engaged in welding works shall be provided with welder's protective eyesight lids.
9.49.4	Stone breakers shall be provided with protective goggles and protective clothing and seated sufficient to safe intervals.
9.49.5	Where workers are employed in sewers and manholes, which are in use, the Contractor shall ensure that the manhole covers are opened and ventilated at least for an hour before the workers are allowed to get into manhole, and the manholes so opened shall be cordoned off with suitable railing and provided

Bharat Heavy Electricals Limited

Rampal, Bagerhat, Bangladesh

VOLUME-ID

TENDER NO: BHEL: MSTPP: C- RW: CSD: 22:10:06

PAGE 38 OF 47

SPECIAL CONDITIONS OF CONTRACT (SCC)

Chapter - IX: HSE & OHSAS

	with warning signals or boards to prevent accident to the public.
9.49.6	The Contractor shall not employ men below the age of 18 years and women on the work of painting with products containing lead in any form. Wherever men above the age of 18 are employed on the work of lead painting, the following precautions should be taken.
9.49.6.1	No paint containing lead or lead products shall be used except in the form of paste or ready made paint.
9.49.6.2	Suitably face masks should be supplied for use by the workers where paints are applied in the form of spray or a surface having lead paint dry rubbed and scrapped.
9.49.6.3	Overalls shall be supplied by the Contractor to the workmen and adequate facilities shall be provided to enable the working painters to wash during the cessation of work.
9.50	When the work is being done near any place where there is risk of drowning all necessary equipment should be provided and kept ready for use and all necessary steps taken for prompt rescue of any person in danger and adequate provision should be made for prompt first aid treatment of all injuries likely to be sustained during the course of the work.
9.51	Motors, gearing, transmission, electric wiring and other dangerous parts of hoisting appliances should be provided with efficient safe guards. Hoisting appliance should be provided with such means as will reduce to the minimum the risk of any part of a suspended load becoming accidentally displaced. When workers employed on electrical installations which are already energized, insulting mats, wearing apparel, such as gloves, sleeves and boots as may be necessary should be provided. The worker should not wear any rings, watches and carry keys or other materials which are good conductor of electricity.
9.52	All scaffolds, ladders and other safety devices mentioned or described herein shall be maintained in safe condition and no scaffold, ladder or equipment shall be altered or removed while it is in use. Adequate washing facilities should be provided at or near the places of work.
9.53	The contractor shall maintain and ensure necessary safety measures as required for inspection and tests HV test, Pneumatic test, Hydraulic test, Spring test, Bend test etc as applicable, to enable inspection Agency for performing Inspection. If any test equipment is found not complying with proper safety

Bharat Heavy Electricals Limited

Rampal, Bagerhat, Bangladesh

VOLUME-ID

TENDER NO: BHEL: MSTPP: C- RW: CSD: 22:10:06

PAGE 39 OF 47

SPECIAL CONDITIONS OF CONTRACT (SCC)

Chapter - IX: HSE & OHSAS

	requirements then the Inspection Agency may withhold inspection, till such time the desired safety requirements are met.
9.54	The Contractor shall notify BHEL of his intention to bring to site any equipment or material which may create hazard. BHEL shall have the right to prescribe the conditions under which such equipment or materials may be handled and the contractor shall adhere to such instructions. BHEL may prohibit the use of any construction machinery, which according to him is unsafe. No claim for compensation due to such prohibition will be entertained by BHEL.
9.55	All safety precautions shall be taken for welding and cutting operations as per IS-818. All safety precautions shall be taken for foundation and other excavation marks as per IS-3764.
9.56	.All gas cylinders shall be stored in upright position. Suitable trolley shall be used. There shall be flash-back arrestors conforming to IS-11006 at both cylinder and burner ends. Damaged tube and regulators must be immediately replaced. No of cylinders shall not exceed the specified quantity as per OCP
9.57	These safety provisions should be brought to the notice of all concerned by display on a notice board at a prominent, place at work spot. The persons responsible for compliance of the safety code shall be named therein by the Contractor
9.58	To ensure effective enforcement of the rules and regulations relating to safety precautions the arrangement made by the contract shall be open to inspection by the Engineer of the Engineer's Representative.
9.59	Keeping the work area clean/ free from debris, removed scaffoldings, scraps, insulation/sheeting wastage /cut pieces, temporary structures, packing woods etc. will be in the scope of the contractor. Such cleanings has to be done by contractor within quoted rate, on daily basis by an identified group. If such activity is not carried out by contractor / BHEL is not satisfied, then BHEL may get it done by other agency and actual cost along with BHEL overheads will be deducted from contractor's bill. Such decisions of BHEL shall be binding on the contractor.
9.60	Notwithstanding the above clauses there is nothing to exit the Contractor from the operations of any other Act or Rule in force in area of work in this respect. Provided always that all safety measures apart from those specifically provided in this agreement which are brought to the notice of the Contractor from time to time by the Engineer shall be complied by the Contractor. Provided further that

Bharat Heavy Electricals Limited

Rampal, Bagerhat , Bangladesh

VOLUME-ID

TENDER NO: BHEL: MSTPP: C- RW: CSD: 22:10:06

PAGE 40 OF 47

SPECIAL CONDITIONS OF CONTRACT (SCC)
Chapter - IX: HSE & OHSAS

	all consequences, damages, or losses arising by reason of any safety code shall be met with by the Contractor.																																																																
9.61	<p><u>NON-COMPLIANCE: -</u> NONCONFORMITY OF SAFETY RULES AND SAFETY APPLIANCES WILL BE VIEWED SERIOUSLY AND BHEL HAS RIGHT TO IMPOSE FINES ON THE CONTRACTOR AS UNDER <u>for every instance of violation noticed:</u></p> <table border="1"> <thead> <tr> <th>SN</th> <th>Violation of Safety Norms</th> <th>Fine (in Rs)</th> </tr> </thead> <tbody> <tr> <td>01</td> <td>Not Wearing Safety Helmet</td> <td>50/- *</td> </tr> <tr> <td>02.</td> <td>Not wearing Safety Belt or not anchoring life line</td> <td>100/-*</td> </tr> <tr> <td>03</td> <td>Not wearing safety shoe</td> <td>100/-*</td> </tr> <tr> <td>04</td> <td>Not keeping gas cylinders vertically</td> <td>100/-</td> </tr> <tr> <td>05</td> <td>Not using flash back arrestors</td> <td>50/-</td> </tr> <tr> <td>06</td> <td>Not wearing gloves</td> <td>50/- *</td> </tr> <tr> <td>07.</td> <td>Grinding Without Goggles</td> <td>50/- *</td> </tr> <tr> <td>08.</td> <td>Not using 24 V Supply For Internal Work</td> <td>500/-</td> </tr> <tr> <td>09.</td> <td>Electrical Plugs Not used for hand Machine</td> <td>100/-</td> </tr> <tr> <td>10.</td> <td>Not Slinging property</td> <td>200/-</td> </tr> <tr> <td>11.</td> <td>Using Damaged Sling</td> <td>200/-</td> </tr> <tr> <td>12.</td> <td>Lifting Cylinders Without Cage</td> <td>500/-</td> </tr> <tr> <td>13.</td> <td>Not Using Proper Welding Cable With Lot of Joints And Not Insulated Property.</td> <td>200/-</td> </tr> <tr> <td>14.</td> <td>Not Removing Small Scrap From Platforms</td> <td>200/-</td> </tr> <tr> <td>15.</td> <td>Gas Cutting Without Taking Proper Precaution or Not Using Sheet Below Gas Cutting</td> <td>200/-</td> </tr> <tr> <td>16.</td> <td>Not Maintaining Electric Winches Which are Operated Dangerously</td> <td>500/-</td> </tr> <tr> <td>17.</td> <td>Improper Earthing Of Electrical T&P</td> <td>500/-</td> </tr> <tr> <td>18</td> <td>No or improper barricading</td> <td>500/-</td> </tr> <tr> <td>19.</td> <td>Activity carried out without Safety work permit (Height work, Lifting activity, Hot work-each person/case)</td> <td>1000/-</td> </tr> <tr> <td>20.</td> <td>Accident Resulting in Partial Loss in Earning Capacity</td> <td>25,000/- per victim</td> </tr> </tbody> </table>		SN	Violation of Safety Norms	Fine (in Rs)	01	Not Wearing Safety Helmet	50/- *	02.	Not wearing Safety Belt or not anchoring life line	100/-*	03	Not wearing safety shoe	100/-*	04	Not keeping gas cylinders vertically	100/-	05	Not using flash back arrestors	50/-	06	Not wearing gloves	50/- *	07.	Grinding Without Goggles	50/- *	08.	Not using 24 V Supply For Internal Work	500/-	09.	Electrical Plugs Not used for hand Machine	100/-	10.	Not Slinging property	200/-	11.	Using Damaged Sling	200/-	12.	Lifting Cylinders Without Cage	500/-	13.	Not Using Proper Welding Cable With Lot of Joints And Not Insulated Property.	200/-	14.	Not Removing Small Scrap From Platforms	200/-	15.	Gas Cutting Without Taking Proper Precaution or Not Using Sheet Below Gas Cutting	200/-	16.	Not Maintaining Electric Winches Which are Operated Dangerously	500/-	17.	Improper Earthing Of Electrical T&P	500/-	18	No or improper barricading	500/-	19.	Activity carried out without Safety work permit (Height work, Lifting activity, Hot work-each person/case)	1000/-	20.	Accident Resulting in Partial Loss in Earning Capacity	25,000/- per victim
SN	Violation of Safety Norms	Fine (in Rs)																																																															
01	Not Wearing Safety Helmet	50/- *																																																															
02.	Not wearing Safety Belt or not anchoring life line	100/-*																																																															
03	Not wearing safety shoe	100/-*																																																															
04	Not keeping gas cylinders vertically	100/-																																																															
05	Not using flash back arrestors	50/-																																																															
06	Not wearing gloves	50/- *																																																															
07.	Grinding Without Goggles	50/- *																																																															
08.	Not using 24 V Supply For Internal Work	500/-																																																															
09.	Electrical Plugs Not used for hand Machine	100/-																																																															
10.	Not Slinging property	200/-																																																															
11.	Using Damaged Sling	200/-																																																															
12.	Lifting Cylinders Without Cage	500/-																																																															
13.	Not Using Proper Welding Cable With Lot of Joints And Not Insulated Property.	200/-																																																															
14.	Not Removing Small Scrap From Platforms	200/-																																																															
15.	Gas Cutting Without Taking Proper Precaution or Not Using Sheet Below Gas Cutting	200/-																																																															
16.	Not Maintaining Electric Winches Which are Operated Dangerously	500/-																																																															
17.	Improper Earthing Of Electrical T&P	500/-																																																															
18	No or improper barricading	500/-																																																															
19.	Activity carried out without Safety work permit (Height work, Lifting activity, Hot work-each person/case)	1000/-																																																															
20.	Accident Resulting in Partial Loss in Earning Capacity	25,000/- per victim																																																															

SPECIAL CONDITIONS OF CONTRACT (SCC)
Chapter - IX: HSE & OHSAS

	<table border="1" style="width: 100%; border-collapse: collapse;"> <tr> <td style="width: 10%; text-align: center;">21.</td> <td style="width: 50%;">Fatal Accident/Accidents Resulting in total loss in Earning Capacity</td> <td style="width: 40%; text-align: center;">1,00,000/- per victim #</td> </tr> </table>	21.	Fatal Accident/Accidents Resulting in total loss in Earning Capacity	1,00,000/- per victim #	
21.	Fatal Accident/Accidents Resulting in total loss in Earning Capacity	1,00,000/- per victim #			
<p>Legend: -*: per head, #: or as deducted by Customer whichever is higher</p> <p>Any other non-conformity noticed not listed above will also be fined as deemed fit by BHEL. The decision of BHEL engineer is final on the above. The amount will be deducted from running bills of the contractor. The amount collected above will be utilized for giving award to the employees who could avoid accident by following safety rules. Also the amount will be spent for purchasing the safety appliances and supporting the safety activity at site.</p>					
9.61	<p><u>CITATION</u>:-If safety record of the contractor in execution of the awarded job is to the satisfaction of safety department of BHEL, issue of an appropriate certificate to recognize the safety performance of the contractor may be considered by BHEL after completion of the job</p>				
9.62	<p><u>MEMORANDUM OF UNDERSTANDING</u> After Award Of Work, Contractors Are Required To Enter Into A Memorandum Of Understanding As Given Below:</p> <p style="text-align: center;"><u>Memorandum of Understanding</u></p> <ul style="list-style-type: none"> ➤ BHEL, Power Sector _____ Region is committed to Health, Safety and Environment Policy (EHS Policy). ➤ M/s _____ do hereby also commit to the same EHS Policy while executing the Contract Number _____ ➤ M/s _____ shall ensure that safe work practices not limited to the above are followed by all construction workers and supervisors. Spirit and content therein shall be reached to all workers and supervisors for compliance. ➤ BHEL will be carrying out EHS audits twice a year and M/s _____ shall ensure to close any non-conformity observed/reported within fifteen days. <p>Signed by authorized representative of M/s -----</p>				

SPECIAL CONDITIONS OF CONTRACT (SCC)
Chapter - IX: HSE & OHSAS

	Name : Place & Date:
--	-----------------------------

SPECIAL CONDITIONS OF CONTRACT (SCC)
Chapter-X: RA Bill Payments

10.0	RA Bill Payments
10.1	The contractor shall submit his monthly RA bills with all the details required by BHEL on specified date every month covering progress of work in all respects and areas for the previous calendar month.
10.2	Mode of payment and measurement of work completed shall be as per relevant clauses of General Conditions of Contract
10.3	Release of payment in each running bill including PVC Bills where ever applicable will be restricted to 95% of the value of work admitted as per stages of progressive pro rata payments.
10.4	The 5% thus remaining shall be treated as 'Retention Amount' and shall be released as per terms specified in the General Conditions of Contract.
10.5	<p>The payment for running bills will normally be released within 30 days of submission of running bill complete in all respects with all documents. It is the responsibility of the contractor to make his own arrangements for making timely payments towards labour wages, statutory payments, outstanding dues etc and other dues in the meanwhile.</p> <p>In case of Civil works, 60% of RA Bills complete and correct in all respects and certified by BHEL Engineer, shall be paid within 15 days of receipt. Balance payment shall be within 30 days.</p>
10.6	<p>BHEL shall release payment through Electronic Fund Transfer (EFT)/RTGS. In order to implement this system, Contractor to furnish details pertaining to his Bank Accounts where proceeds will be transferred through BHEL's banker, as per prescribed formats:</p> <p>Note: BHEL may also choose to release payment by other alternative modes as applicable</p>
10.7	Paying Authority shall be the Construction Manager of the Site. Any change in the paying Authority shall be intimated to the Contactor accordingly.

SPECIAL CONDITIONS OF CONTRACT (SCC)
Chapter-XI : Performance Monitoring

11.0	Performance Monitoring
11.1	Performance of the contractor is monitored through various reports/reviews and shall be jointly evaluated every month for unit wise identified packages as per prescribed formats. Based on the net weighted scores obtained, Contractors shall be rated 'Good' or 'Satisfactory' or 'Unsatisfactory'
11.2	In case of any dispute on performance rating and the contractor refuses to sign on the performance rating given by BHEL package In charge, the same shall be reviewed by BHEL site In charge/Construction Manager and his decision shall be final.
11.3	Release of RA Bills will be contingent upon joint evaluation of performance
11.4	Performance of the contractor will be taken into consideration for assessing the capacity of the bidder to execute future jobs under tender, as detailed in the Notice Inviting Tender. Risk of non evaluation or non availability of the Monthly performance evaluation reports is to be borne by the Bidder.
11.5	In case of 'Unsatisfactory performance' for a continuous period of three or more months for a package or packages, BHEL has the right to get the balance works executed at the risk and cost of the contractor.
11.6	In case of 'Unsatisfactory performance' in a financial year, BHEL reserves the right to put on hold such Contractors for a period of six months for similar package or similar packages

SPECIAL CONDITIONS OF CONTRACT (SCC)

12.0	Suspension of Business dealings
12.1	BHEL reserves the right to take action against contractors who fail to perform or indulge in malpractices, by suspending business dealings with them.
12.2	Suspension could be in the form of 'Hold', 'De-listing' or 'Banning' a contractor.
12.3	<p>A bidder may be put on HOLD for a period of 6 months, for future tenders for specific works on the basis of one or more of the following reasons:</p> <ul style="list-style-type: none"> a) Bidder does not honor his own offer or any of its conditions within the validity period. b) Bidder fails to respond against three consecutive enquires of BHEL. c) After placement of order, Bidder fails to execute a contract. d) Bidder fails to settle sundry debt account, for which he is legitimately liable, within one year of its occurrence. e) Bidder's performance rating falls below 60% in specific category (more fully described in chapter 'Performance Monitoring') f) Bidder works are under strike/ lockout for a long period.
12.4	<p>A Bidder may be de-listed from the list of registered Bidders of the region for a period of 1 year on the basis of one or more of the following reasons:-</p> <ul style="list-style-type: none"> a) Bidder tampers with tendering procedure affecting ordering process or commits any misconduct which is contrary to business ethics. b) Bidder has substituted, damaged, failed to return, short returned or unauthorizedly disposed off materials/ documents/ drawings/ tools etc of BHEL. c) Bidder no longer has the technical staff, equipment, financial resources etc. required to execute the orders/ contracts.
12.5	<p>A Bidder can be banned from doing any business with all Units of BHEL for a period of 3 years on the basis of one or more of the following reasons:</p> <ul style="list-style-type: none"> a) Bidder is found to be responsible for submitting fake/ false/ forged documents, certificates, or information prejudicial to BHEL's interest. b) In spite of warnings, the Bidder persistently violates or circumvents the provisions of labour laws/ regulations/ rules and other statutory requirements. c) Bidder is found to be involved in cartel formation

SPECIAL CONDITIONS OF CONTRACT (SCC)

	<p>d) The Bidder has indulged in malpractices or misconduct such as bribery, corruption and fraud, pilferage etc which are contrary to business ethics.</p> <p>e) The Bidder is found guilty by any court of law for criminal activity/offences involving moral turpitude in relation to business dealings.</p> <p>f) The Bidder is declared bankrupt, insolvent, has wound up or been dissolved; i.e. ceases to exist for all practical purposes.</p> <p>g) Bidder is found to have obtained Official Company information/documentation by questionable means.</p> <p>h) Communication is received from the administrative Ministry of BHEL to ban the Bidder from business dealings.</p>
12.6	Contracts already entered with a contractor before the date of issue of order of 'HOLD' or 'DE-LISTING' shall not be affected.
12.7	All existing contracts with a 'BANNED' contractor shall normally be short closed
12.8	Once the order for suspension is passed, existing offers/new offers of the contractor shall not be entertained
12.9	The above guidelines are not exhaustive but enunciate broad principles governing action against contractors



भारत हेवी इलेक्ट्रिकल्स लिमिटेड

(भारत सरकार का उपक्रम)

BHARAT HEAVY ELECTRICALS LIMITED

(A Govt. of India Undertaking)

**HEALTH, SAFETY AND
ENVIRONMENT PLAN FOR SUB-
CONTRACTORS FOR 2x660MW
MAITREE SUPER THERMAL
POWER PROJECT**

DOCUMENT NO; HSEP:14-MAITREE: VENDOR DATE:05.05.16

HSE DEPARTMENT

Plot No. 9/1, Block-DJ, Sector-II, Salt Lake, Kolkata – 700 091

Phone no. 033-23398049, Web : www.jantermanter.com



**HEALTH, SAFETY AND ENVIRONMENT
PLAN FOR SITE SUB-CONTRACTORS
(MAITREE PROJECT)**

Doc no.: HSEP: 14-MAITREE:VENDOR

REV: 00

Date: 05.05.16

Page: 1 of 90

POWER SECTOR-EASTERN REGION

SPECIAL NOTES

- ❖ **This document supersedes section-IX of SCC or any such HSE related document in the tender**
 - ❖ This document is a living document and subject to changes as many times as desired by BHEL and customer, BIFPCL and project consultant Fichtner GmbH. Any cost implication shall be absorbed by the contractor.
 - ❖ This project is a highly eco-sensitive project. There will be regular assessment of impact of the site activities on ecology. The contractors shall be obligated to take corrective actions, if any, as advised by BHEL/ Customer/ any Statutory body.
 - ❖ The contractor shall ensure that only persons with required competence and sound health are engaged at the site. No deviation shall be allowed. The person and the contractor shall be in possession of relevant documents in support of competence and health condition for producing before BHEL for verification, whenever demanded.
 - ❖ It may take minimum 2 days for finishing health check-up and induction training before a gate-pass/ ID is issued. In a day, maximum 30 persons can be given induction training. Mobilization shall be planned accordingly
 - ❖ Method statement and Job Safety Analysis shall be carried out for all hazardous jobs and critical lifts
 - ❖ As the site is located in an area which is prone to adverse weather condition, the contractors shall have infrastructure for fast evacuation of people
 - ❖ Contractor for Boiler-1, Chimney-1 and Cooling Tower-1 shall provide one double-mounted siren at a height covering a dia of about 2KM for alerting site workers in case of emergency.
 - ❖ The following basic instruments shall be available with contractors HSE team if their job involves:
 - Height work: Binoculars
 - Confined space work: Oxy-meter
 - Night work: Lux meter, Torch light
 - Checking of ELCBs: ELCB tester
 - Checking of earthing: Megger
- Apart from these, DB meter, Alcohol Breath analyzer, and other HSE promotional items shall be made available by the contractors as and when demanded by BHEL.
- ❖ Well-equipped sick room shall be set up and ambulance shall be made available by specific contractors as provided for in the work order of certain packages. However, the operational expenses can be shared by those contractors who will avail services of these facilities.



**HEALTH, SAFETY AND ENVIRONMENT
PLAN FOR SITE SUB-CONTRACTORS
(MAITREE PROJECT)**

Doc no.: HSEP: 14-MAITREE:VENDOR

REV: 00

Date: 05.05.16

Page: 2 of 90

POWER SECTOR-EASTERN REGION

INDEX

Sr. No.	Description	Page No.
1.0	PURPOSE	5
2.0	SCOPE	5
3.0	OBJECTIVES	5
4.0	HEALTH, SAFETY & ENVIRONMENT POLICY	6
5.0	TERMS & DEFINITIONS	7
6.0	HSE ORGANIZATION	8
6.1	QUALIFICATION FOR HSE PERSONNEL	8
6.2	RESPONSIBILITIES	9
7.0	PLANNING BY SUBCONTRACTOR	10
7.1	MOBILISATION OF MACHINERY/EQUIPMENT/TOOLS	11
7.2	MOBILISATION OF MANPOWER BY SUBCONTRACTOR	11
7.3	PROVISION OF PPEs	11
7.4	ARRANGEMENT OF INFRASTRUCTURE	13
8.0	HSE TRAINING & AWARENESS	17
8.1	HSE INDUCTION TRAINING	17
8.2	HSE TOOLBOX TALK	17
8.3	TRAINING ON HEIGHT WORK	18
8.4	HSE TRAINING DURING PROJECT EXECUTION	18



**HEALTH, SAFETY AND ENVIRONMENT
PLAN FOR SITE SUB-CONTRACTORS
(MAITREE PROJECT)**

Doc no.: HSEP: 14-MAITREE:VENDOR

REV: 00

Date: 05.05.16

Page: 3 of 90

POWER SECTOR-EASTERN REGION

8.5	HSE PROMOTION-SIGNAGE, POSTERS, COMPETITION, AWARDS ETC	19
9.0	HSE COMMUNICATION	19
9.1	INCIDENT REPORTING, INVESTIGATION & RECORDS	19
9.2	HSE EVENT REPORTING	20
10.0	OPERATIONAL CONTROL	20
10.1	HSE ACTIVITIES	21
10.2	WORK PERMIT SYSTEM	21
10.3	SAFETY DURING WORK EXECUTION	22
10.3.1	POWER SUPPLY & UPKEEP OF INSTALLATION	22
10.3.2	QUALIFIED AND UNQUALIFIED WORKERS	23
11.0	LIFTING OPERATION	24
12.0	FIRE PREVENTION, PROTECTION AND PREPAREDNESS	30
13.0	RADIOGRAPHY	31
14.0	CONFINED SPACE ENTRY	31
15.0	WELDING & GAS CUTTING OPERATIONS	33
16.0	COMPRESSED GAS	34
17.0	WORK AT HEIGHT	35
18.0	SCAFFOLDS	36
18.1	SAFE USE OF LADDERS	39
18.2	PRECAUTIONS AGAINST THE FALL OF MATERIALS & PERSONS AND COLLAPSE OF STRUCTURES	40



**HEALTH, SAFETY AND ENVIRONMENT
PLAN FOR SITE SUB-CONTRACTORS
(MAITREE PROJECT)**

Doc no.: HSEP: 14-MAITREE:VENDOR

REV: 00

Date: 05.05.16

Page: 4 of 90

POWER SECTOR-EASTERN REGION

18.3	SAFETY NETS	41
19.0	SAFETY IN JETTY CONSTRUCTIONS	42
20.0	NIGHT SHIFT OPERATIONS	43
21.0	CONTROL OF MOVEMENTS AND USE OF HAZARDOUS SUBSTANCES AND CHEMICALS	44
22.0	CHEMICAL CLEANING	44
23.0	USE OF HAND TOOLS AND POWER OPERATED TOOLS	45
24.0	START-UP, COMMISSIONING AND TESTING	47
25.0	DEMOLITION WORK	47
26.0	EXCAVATION	48
27.0	ENVIRONMENTAL CONTROL	48
28.0	HOUSEKEEPING	49
29.0	WASTE MANAGEMENT	50
30.0	WORK VEHICLES	52
31.0	EMERGENCY PREPAREDNESS AND RESPONSE	52
32.0	HSE INSPECTION	63
33.0	HSE PERFORMANCE AND HSE PENALTIES	65
34.0	OTHER REQUIREMENTS	68
35.0	HSE AUDIT/INSPECTION	69
36.0	MONTHLY HSE REVIEW MEETING	69
37.0	FORMATS USED	69



**HEALTH, SAFETY AND ENVIRONMENT
PLAN FOR SITE SUB-CONTRACTORS
(MAITREE PROJECT)**

Doc no.: HSEP: 14-MAITREE:VENDOR

REV: 00

Date: 05.05.16

Page: 5 of 90

POWER SECTOR-EASTERN REGION

1.0 PURPOSE

- 1.1 The purpose of this HSE Plan is to provide for the systematic identification, evaluation, prevention and control of general workplace hazards, specific job hazards, potential hazards and environmental impacts that may arise from foreseeable conditions during installation and servicing of industrial projects and power plants.
- 1.2 This document shall be followed by BHEL's subcontractors at all installation and servicing sites. In case customer specific documents are to be implemented, this document will be followed in conjunction with customer specific documents.
- 1.3 Although every effort has been made to make the procedures and guidelines in line with statutory requirements, in case of any discrepancy relevant statutory guidelines or EHSS contract requirements must be followed of which the most stringent shall apply
- 1.4 In case the customer has any specific requirement, the same is to be fulfilled.
- 1.5 We will promote and maintain a safe, healthy and environmentally compliant workplace for all employees, contractors, visitors and any others that may be affected by construction activities, and strive for a "GOAL of ZERO REPORTABLE INCIDENTS" on the project.

2.0 SCOPE

The document is applicable for installation and commissioning of 2x660MW SETS as per the relevant contractual obligations, and provides the minimum HSE requirements to be followed at the project site and labour colony. As an item of note, this HSE Plan is considered a living document and will be revised as/if necessary to ensure that contractual and regulatory compliance requirements are met during the performance of work on the project

3.0 OBJECTIVES

The HSE Plan reflects that BHEL places high priority upon the Occupational Health, Safety and Environment at workplaces.

- Ensure the Health and Safety of all persons at work site is not adversely affected by the work.
- Ensure protection of environment of the work site.
- Comply at all times with the relevant statutory and contractual HSE requirements.
- Provide trained, experienced and competent personnel. Ensure medically fit personnel only are engaged at work.
- Provide and maintain plant, places and systems of work that are safe and without risk to health and the environment.
- Provide all personnel with adequate information, instruction, training and supervision.
- Effectively control, co-ordinate and monitor the activities of all personnel on the Project sites including subcontractors in respects of HSE.
- Establish effective communication on HSE matters with all relevant parties involved in the Project works.
- Ensure that all work planning takes into account all persons that may be affected by the work.
- Ensure fitness testing of all T&Ps/Lifting appliances like cranes, chain pulley blocks etc. are to be certified by competent authority.
- Ensure timely provision of resources to facilitate effective implementation of HSE requirements.
- Ensure continual improvements in HSE performance
- Ensure conservation of resources and reduction of wastage.



**HEALTH, SAFETY AND ENVIRONMENT
PLAN FOR SITE SUB-CONTRACTORS
(MAITREE PROJECT)**

Doc no.: HSEP: 14-MAITREE:VENDOR

REV: 00

Date: 05.05.16

Page: 6 of 90

POWER SECTOR-EASTERN REGION

- Capture the data of all incidents including near misses, process deviation etc. Investigate and analyze the same to find out the root cause.
- Ensure timely implementation of correction, corrective action and preventive action.

3.1 Goals and Targets -

- To achieve "Zero Fatal Incident at Site"
- 100% compliance of all legal/statutory requirements related to EHS.
- 100% Health, Safety and Environmental Induction training attendance for all employees and sub-contractors.
- 100% High Risk activities to be carried out only after approved Method Statement, HIRA/JSA and Permit to Work are implemented.
- 100% PPEs compliance in high & medium risk activities.
- 100% incident reporting, recording and reviewing for corrective & preventive actions.
- A monthly review shall be scheduled and conducted to assess HSE program compliance and to close any recognized gaps to improve safety management and incident prevention.

4.0 BHEL POWER SECTOR HEALTH, SAFETY & ENVIRONMENT POLICY

Power Sector HSE Policy

We, at BHEL Power Sector, reaffirm our belief that the Health and Safety of our stakeholders and conservation of Environment is of utmost importance and takes precedence in all our business decisions. In pursuit of this belief and commitment, we strive to:

- ✓ Ensure total compliance with applicable legislation, regulations and other requirements concerning Occupational Health, Safety and Environment.
- ✓ Ensure continual improvement in the Occupational Health, Safety and Environment Management System performance.
- ✓ Enhance Occupational Health, Safety and Environment awareness amongst employees, customers and suppliers by proactive communication and training.
- ✓ Review periodically and improve Occupational Health, Safety and Environment Management System to ensure its continuing suitability, adequacy and effectiveness in a continuously changing business environment.
- ✓ Develop a culture of safety through active leadership and provide appropriate training at all levels to enable employees to fulfill their Health, Safety and Environmental obligations.
- ✓ Incorporate appropriate Occupational Health, Safety and Environmental criteria into business decisions for selection of plant, technology and services as well as appointment of key personnel.
- ✓ Ensure availability at all times of appropriate resources to fully implement the Occupational Health, Safety and Environmental policy of the company.

This policy will be communicated to all employees and made available to interested parties.

Sd/-

Director (Power)



**HEALTH, SAFETY AND ENVIRONMENT
PLAN FOR SITE SUB-CONTRACTORS
(MAITREE PROJECT)**

Doc no.: HSEP: 14-MAITREE:VENDOR

REV: 00

Date: 05.05.16

Page: 7 of 90

POWER SECTOR-EASTERN REGION

5.0 TERMS AND DEFINITIONS

5.1 DEFINITIONS

5.1.1 INCIDENT

Work- related event(s) in which an injury or ill health (regardless of severity) or fatality occurred, or could have occurred.

5.1.2 NEAR MISS

An incident where no ill health, injury, damage or other loss occurs, but it had a potential to cause, is referred to as "Near-Miss".

5.1.3 MAN-HOUR WORKED

The total number of employee hours worked by all employees including subcontractors working in the premises. It includes managerial, supervisory, professional, technical, clerical and other workers including contract labours. Man-hours worked shall be calculated from the payroll or time clock recorded including overtime. When this is not feasible, the same shall be estimated by multiplying the total man-days worked for the period covered by the number of hours worked per day. The total number of workdays for a period is the sum of the number of men at work on each day of period. If the daily hours vary from department to department separate estimate shall be made for each department and the result added together.

5.1.4 FIRST AID CASES

First Aid includes:

- Visit to a physician or a licensed health care professional solely for observation or counselling
- Conduct of diagnostic procedures like X rays, blood test including the prescription medications used solely for diagnostic purposes (e.g. eye drops to dilate eyes)
- Using a non-prescription medicine at non-prescription strength (for medication available in both prescription and non-prescription form as recommendation by a physician or other licensed health care professional to use a non-prescription medication at prescription strength is considered medical treatment for record keeping purposes);
- Administering tetanus immunizations (other immunizations, such as Hepatitis B vaccine or rabies vaccine, are considered medical treatment);
- Cleaning, flushing or soaking wounds on the surface of the skin;
- Using wound coverings such as bandages, Band-Aids TM, gauze pads, etc.; or using butterfly bandages or Steri-StripsTM (other wound closing devices such as sutures, staples, etc., are considered medical treatment);
- Using hot or cold therapy;
- Using any non-rigid means of support, such as elastic bandages, wraps, non-rigid back belts, etc. (devices with rigid stays or other systems designed to immobilize parts of the body are considered medical treatment for record-keeping purposes);
- Using temporary immobilization devices while transporting an accident victim (e.g., splints, slings, neck collars, back boards, etc.).
- Drilling of a fingernail or toenail to relieve pressure, or draining fluid from a blister;
- Using eye patches;
- Removing foreign bodies from the eye using only irrigation or a cotton swab;
- Removing splinters or foreign material from areas other than the eye by irrigation, tweezers, cotton swabs or other simple means;
- Using finger guards;



**HEALTH, SAFETY AND ENVIRONMENT
PLAN FOR SITE SUB-CONTRACTORS
(MAITREE PROJECT)**

Doc no.: HSEP: 14-MAITREE:VENDOR

REV: 00

Date: 05.05.16

Page: 8 of 90

POWER SECTOR-EASTERN REGION

- Using massages (physical therapy or chiropractic treatment are considered medical treatment for recordkeeping purposes); or
- Drinking fluids for relief of heat stress.

No other treatments are considered first aid.

5.1.5 INJURY OTHER THAN FIRST-AID: (As per Chapter VII, Rule 69 of Bangladesh Labour Rules, 2015)

Notice to be given of any accident—When any accident occurs in an establishment causing loss of life or bodily injury, or an accidental explosion, ignition, outbreak of fire or irruption of water or fumes occurs, the employer shall give notice of the occurrence to the Inspector within following 3 (three) working days [:]

Provided that the factory authority shall, immediately after the occurrence of such incident, inform the matter to the Government, Fire Service, Directorate of Inspection of Factories and Establishments, Police Station, and if required, the nearby hospital or government-private medical service establishment, through telephone, mobile phone, SMS or fax, in order to take immediate necessary action to minimize potential damages or bring the situation under control.]

Fatal incident and Serious Incident:

If the victim dies in the incident, it will be treated as a fatal incident.

In this case the injured person is likely to be disable for more than 20 days to perform his duty, it will be treated as Serious Incident. In these cases, the intimation will be made as described above.

Minor Incident: (As per Chapter VII , Rule 70 of Bangladesh Labour Rules, 2015)

Where an accident mentioned above causes bodily injury resulting the compulsory absence from work of the person injured for a period exceeding 48 (forty-eight) hours, but not exceeding 20days. The management will inform the concerned statutory authority within 7 days in form-27 under rule 69/1/(A), (B) and (C) of Bangladesh Labour Rules, 2015.

6.0 HSE ORGANISATION

Number of HSE officers:

The subcontractor must deploy one HSE officer for every 500 workers or part thereof in each package. If there are more than one HSE officer, one shall be designated as head/HSE. No Of HSE stewards shall be one for every 100 workers deployed

Deployment: The subcontractor should deploy sufficient HSE officers and HSE-steward/supervisor, as per requirement given above, since initial stage and add more in proportion to the added strength in work force. Any delay in deployment of HSE Officer will attract a penalty of BNR.40,000/- per man month for the delayed period.

6.1 QUALIFICATION FOR HSE PERSONNEL

Sl.no	Designation	Minimum Qualification	Experience
1	Safety officer (Construction Agency)	Degree or Diploma in Engineering with diploma in Industrial Safety with construction safety as one of the subjects. If Degree/Diploma in safety is from India, it must be recognized by AICTE/SCTE&VT. NEBOSH IGC /IOSH diploma also acceptable	Minimum two years for degree holder and five years for diploma holder in the field of Construction of power plant/ major industries



**HEALTH, SAFETY AND ENVIRONMENT
PLAN FOR SITE SUB-CONTRACTORS
(MAITREE PROJECT)**

Doc no.: HSEP: 14-MAITREE:VENDOR

REV: 00

Date: 05.05.16

Page: 9 of 90

POWER SECTOR-EASTERN REGION

6.2 RESPONSIBILITIES

6.2.1 SITE IN -CHARGE OF SUBCONTRACTOR

- Shall engage qualified safety officer(s) as per clause 6.1
- Shall adhere to the rules and regulations mentioned in this code, practice very strictly in his area of work in consultation with his concerned engineer and the safety coordinator.
- Shall screen all workmen for health and competence requirement before engaging for the job and periodically thereafter as required.
- Shall not engage any employee below 18 years.
- Shall arrange for all necessary PPEs like safety helmets, belts, full body harness, shoes, face shield, hand gloves etc. before starting the job. Shall ensure that no working men/women carry excessive weight more than stipulated in Factory Rule Regulation R57.
- Shall ensure that all T&Ps engaged are tested for fitness and have valid certificates from competent authorities.
- Shall ensure that provisions stipulated in contract Labour Regulation Act 1970, Chapter V C.9, canteen, rest rooms/washing facilities to contracted employees at site.
- Shall adhere to the instructions laid down in Operation Control Procedures (OCPs) available with the site management.
- Shall ensure that person working above 2.0 meter should use Safety Harness tied to a life line/stable structure.
- Shall ensure that materials are not thrown from height. Cautions to be exercised to prevent fall of material from height.
- Shall report all incidents (Fatal/Major/Minor/Near Miss) to the Site engineer /HSE officer of BHEL.
- Shall ensure that Horseplay is strictly forbidden.
- Shall ensure that adequate illumination is arranged during night work.
- Shall ensure that all personnel working under subcontractor are working safely and do not create any Hazard to self and to others.
- Shall ensure display of adequate signage/posters on HSE.
- Shall ensure that mobile phone is not used by workers while working.
- Shall ensure conductance of HSE audit, mock drill, medical camps, induction training and training on HSE at site.
- Shall ensure full co-operation during HQ/External /Customer HSE audits.
- Shall ensure submission of look-ahead plan for procurement of HSE equipment's and PPEs as per work schedule.
- Shall ensure good housekeeping.
- Shall ensure adequate valid fire extinguishers are provided at the work site.
- Shall ensure availability of sufficient number of toilets /restrooms and adequate drinking water at work site and labour colony.
- Shall ensure adequate emergency preparedness.
- Shall be member of site HSE committee and attend all meetings of the committee



**HEALTH, SAFETY AND ENVIRONMENT
PLAN FOR SITE SUB-CONTRACTORS
(MAITREE PROJECT)**

Doc no.: HSEP: 14-MAITREE:VENDOR

REV: 00

Date: 05.05.16

Page: 10 of 90

POWER SECTOR-EASTERN REGION

6.2.2 HEALTH, SAFETY AND ENVIRONMENT OFFICER OF SUBCONTRACTOR

- Carry out safety inspection of Work Area, Work Method, Men, Machine & Material, P&M and other tools and tackles.
- Facilitate inclusion of safety elements into Work Method Statement.
- Highlight the requirements of safety through Tool-box / other meetings.
- Help concerned HOS to prepare Job Specific instructions for critical jobs.
- Conduct investigation of all incident/dangerous occurrences & recommend appropriate safety measures.
- Advice & co-ordinate for implementation of HSE permit systems, OCPs & MPs.
- Convene HSE meeting & minute the proceeding for circulation & follow-up action.
- Plan procurement of PPE & Safety devices and inspect their healthiness.
- Report to PS Region/HQ on all matters pertaining to status of safety and promotional program at site level.
- Facilitate administration of First Aid
- Facilitate screening of workmen and safety induction.
- Conduct fire Drill and facilitate emergency preparedness
- Design campaigns, competitions & other special emphasis programs to promote safety in the workplace.
- Apprise PS– Region on safety related problems.
- Notify site personnel non-conformance to safety norms observed during site visits / site inspections.
- Recommend to Site In charge, immediate discontinuance of work until rectification, of such situations warranting immediate action in view of imminent danger to life or property or environment.
- To decline acceptance of such PPE / safety equipment that do not conform to specified requirements.
- Encourage raising Near Miss Report on safety along with, improvement initiatives on safety.
- Shall work as interface between various agencies such customer, package-in-charges, subcontractors on HSE matters

7.0 PLANNING BY SUBCONTRACTOR

7.1 MOBILISATION OF MACHINERY/EQUIPMENT/TOOLS BY SUBCONTRACTOR

- As a measure to ensure that machinery, equipment and tools being mobilized to the construction site are fit for purpose and are maintained in safe operating condition and complies with legislative and owner requirement. A documented daily prior to use inspection checklist shall be completed by the end user and periodic inspection shall be arranged by in-house competent authority for acceptance as applicable. All Tools & Plants shall be certified by a third party COMPETENT person before these are put to use [as per Rule 60, 75 and schedule 3 of Bangladesh Labor Rules](#). As far as possible, this certification shall be made available to site HSE function by the contractor before entry into the site. The certification shall be renewed annually, otherwise, the item shall be withdrawn from the work area. [The fitness of T&Ps shall be monitored by site HSE quarterly and alert/ reminder issued to the concerned agency and BHEL package in-charge.](#)
- The machinery and equipment to be embraced for this purpose shall include but not limited to the following:
 - Mobile cranes.



**HEALTH, SAFETY AND ENVIRONMENT
PLAN FOR SITE SUB-CONTRACTORS
(MAITREE PROJECT)**

Doc no.: HSEP: 14-MAITREE:VENDOR

REV: 00

Date: 05.05.16

Page: 11 of 90

POWER SECTOR-EASTERN REGION

- Side Booms.
- Grinding machine.
- Drilling machine.
- Air compressors.
- Welding machine.
- Generator sets.
- Dump Trucks.
- Excavators.
- Dozers
- Grit Blasting Equipment.
- Hand and power tools.

- Subcontractor shall notify the engineer, of his intention to bring on to site any equipment or any container, with liquid or gaseous fuel or other substance which may create a hazard. The Engineer shall have the right to prescribe the condition under which such equipment or container may be handled and used during the performance of the works and the subcontractor shall strictly adhere to such instructions. The Engineer shall have the right to inspect any construction tool and to forbid its use, if in his opinion it is unsafe. No claim due to such prohibition will be entertained.

7.2 MOBILIZATION OF MANPOWER BY SUBCONTRACTOR

- As a measure to ensure that manpower being mobilized to the construction site is fit and competent for safe working, screening arrangement shall be made by the sub-contractors to fulfill contractual as well as legislative requirement.
- Examination of medical fitness shall be conducted through qualified medical professional for all workers to be deployed (pre-employment). Post-employment medical check-up shall be done for persons engaged in hazardous jobs at a regular interval as per legislations.
- Ensure that the regulatory requirements of excessive weight limit (to carry/lift/ move weights beyond prescribed limits) for male and female workers are complied with.
- Appropriate accommodation to be arranged for all workmen in hygienic condition.

7.3 PROVISION OF PPEs

- Personnel Protective Equipment (PPEs), in adequate numbers, will be made available at site & their regular use by all concerned will be ensured. PPE details shall be maintained as per Form-23
- The following matrix recommends usage of minimum PPEs against the respective job.

Sl. No	Type of work	PPEs
1	Concrete and asphalt mixing	Nose mask, hand glove, apron and gum boot
2	Welders/Grinders/ Gas cutters	Welding/face screen, apron, hand gloves, nose mask and ear muffs if noise level exceeds 90dB. Helmet fitted with welding shield is preferred for welders
3	Stone/ concrete breakers	Ear muffs, safety goggles, hand gloves
4	Electrical Work	Rubber hand glove, Electrical Resistance shoes, Apron
5	Insulation Work	Respiratory mask, Hand gloves, safety goggles
6	Work at height	Double lanyard full body harness, Fall arrestor (specific cases)
7	Grit/Sand blasting	Blast suit, blast helmet, respirator, leather gloves



**HEALTH, SAFETY AND ENVIRONMENT
PLAN FOR SITE SUB-CONTRACTORS
(MAITREE PROJECT)**

Doc no.: HSEP: 14-MAITREE:VENDOR

REV: 00

Date: 05.05.16

Page: 12 of 90

POWER SECTOR-EASTERN REGION

8	Painting	Plastic gloves, Respirators (particularly for spray painting)
9	Radiography	As per BARC guidelines

The PPEs and other related safety equipments shall conform to the relevant indian or equivalent European or American standards as below:

BS EN 397:2012	Industrial Safety Helmets.
BS EN 60903:2003	Insulating material gloves for electrical purposes.
BS EN 374-3: 2003	Protective Gloves- Chemical Penetration
BS EN 388:2003	Protective Gloves- Mechanical Risks
BS EN 407: 2004	Protective Gloves- heat and fire
BS EN 420:2003	Gloves- general requirement
BS EN-20345	Industrial safety footwear
BS EN 166:2002	Eye protectors.
BS EN 352-1 & 2:2002	Ear Muff & Ear Plug
BS EN 175:1997	Eye & Face protection during welding
BS EN 361:2002	Fall Arrest Full Body Harness
BS EN 360:2002	Retractable type fall arresters
BS EN 795:2012	Lifeline System
BS EN 358;1999	Work Resistant Harness
BS EN 813:2008	Seat harness
BS EN 1498+ others	Rescue Harness+ other items of a rescue kit
BS EN 353:2002	Detachable fall arrester
BS EN 149: 2001	Filtering Half masks tp protect against particles
BS EN 471:2003	High Visibility Clothing

The list is not exhaustive. The safety officer may demand additional PPEs based on specific requirement.

- Where workers are employed in sewers and manholes, which are in use, the subcontractor shall ensure that the manhole covers are opened and ventilated at least for an hour before the workers are allowed to get into manhole, and the manholes so opened shall be cordoned off with suitable railing and provided with warning signals or boards to prevent incident to the public
- . The visitors shall also use Reflective Vests, Helmet and any other PPEs as deemed appropriate for the area of work.

Colour scheme for Helmets:

1. Workmen: Yellow
2. Safety staff: Green or white with green band
3. Electrician: Red
4. Others including visitors: White



**HEALTH, SAFETY AND ENVIRONMENT
PLAN FOR SITE SUB-CONTRACTORS
(MAITREE PROJECT)**

Doc no.: HSEP: 14-MAITREE:VENDOR

REV: 00

Date: 05.05.16

Page: 13 of 90

POWER SECTOR-EASTERN REGION

- All the PPEs shall be checked for its quality before issue and the same shall be periodically checked. The users shall be advised to check the PPEs themselves for any defect before putting on. The defective ones shall be repaired/ replaced.
 - The issuing agency shall maintain register for issue and receipt of PPEs.
 - The Helmets shall have logo or name (abbreviation of agency name permitted) affixed or printed on the front.
 - The body harnesses shall be serial numbered.
- In case, contractor fails to provide PPEs in time, BHEL/Customer may provide the same and the cost as deemed appropriate by BHEL/Customer shall be debited

7.4 ARRANGEMENT OF INFRASTRUCTURE

7.4.1 DRINKING WATER

- Adequate drinking water shall be provided and maintained at suitable places at different elevations.
- Chilled water shall be made available from 1st April to 30th Sep of the year
- Container should be labeled as “ Drinking Water”
- Cleaning of the storage tank shall be ensured at least once in 1 month indicating date of cleaning and next due date. Mild cleaning detergents as used for cleaning vessels shall be applied and scrubbers (3M or equivalent) shall be used for removing scales and deposits on the inside surface. The tank shall be thoroughly cleaned with potable water only before it is refilled.
- Employees should use their own cup for collecting water-no cup shall be shared
- Potability of water should be tested as per standard at least once in every quarter as per Rule 50(5) of Bangladesh Labour Rules, 2015.
- Apart from above, those who are engaged in work producing significant heat , shall be served saline water or Sarbat at the rate of 2litres perday
- Storage of drinking water shall be min 6M away from any toilet and washroom

7.4.2 WASHING FACILITIES (As per Chapter VIII, Rule 86 of Bangladesh Labour Rules, 2015)

- In every workplace, adequate and suitable facilities for washing shall be provided and maintained.
- Separate and adequate cleaning facilities shall be provided for the use of male and female workers. Such facilities shall be conveniently accessible and shall be kept in clean and hygienic condition and dully illuminated for night use.
- Overalls shall be supplied by the subcontractor to the workmen and adequate facilities shall be provided to enable the painters and other workers to wash during the cessation of work.
- If water used for washing is not potable, it shall be marked “Do Not Drink” in English and Bangla

7.4.3 LATRINES AND URINALS (As per Chapter V, Rule 51, Schedule II of Bangladesh Labour Rules, 2015)

- Latrines and urinals shall be provided in every work place based on strength of workmen at the rate of one toilet seat and one urinal for every 50 female workmen and that for every 60 male workmen
- Urinals shall also be provided at different elevations.
- They shall be adequately illuminated and shall be maintained in a clean and hygienic condition at all times, by appointing designated person.
- Separate facilities shall be provided for the use of male and female worker if any.
- Hand-wash facility shall be provided



**HEALTH, SAFETY AND ENVIRONMENT
PLAN FOR SITE SUB-CONTRACTORS
(MAITREE PROJECT)**

Doc no.: HSEP: 14-MAITREE:VENDOR

REV: 00

POWER SECTOR-EASTERN REGION

Date: 05.05.16

Page: 14 of 90

7.4.4 PROVISION OF SHELTER DURING REST

Proper Shed & Shelter shall be provided for rest during break::

7.4.5 MEDICAL FACILITIES (Sharing with other sub-contractors at site is permitted)

7.4.5.1 Sick Room (As per rule 77) (As stipulated in the contract)

- A Sick room shall be ensured/identified at site with basic facilities as per subrule 77(5) for handling medical emergencies. The sick room can be run independently or jointly developed on proportionate sharing basis with permission from BHEL. It shall be equipped with one rigid stretcher, one foldable stretcher, one rescue basket stretcher, a wheel chair, at least 2 beds with separator and all basic facilities that a doctor needs for basic health check-up and quick referral including those listed in sub-rule 77(5) of Bangladesh Labour Rules,2015
- A qualified medical professional, not less than a Degree in Medical Science (Allopathy) as recognized in Bangladesh, shall be deployed at the sick room along with sufficient support staff
- Medical waste shall be disposed as per prevailing legislation
- Ambulance, **as stipulated in the contract**, shall be made available at the site along with a trained driver and shall be equipped with at least an Oxygen cylinder along with dispensation system, first-aid box, a portable ABC type fire extinguisher.

7.4.5.2 FIRST AIDER

- Must have a competence certificate in First-aid issued by Bangladesh Red Cross Society/ Bangladesh St Johns Ambulance/ any other agency which is recognised by the Govt of Bangladesh
- Ensure availability of **one** Qualified First-aider throughout the working hours for every 150 workmen engaged as per clause 89 of Bangladesh Labour Law
- Every injury shall be treated, recorded and reported.
- Refresher course on first aid shall be conducted as necessary.
- List of Qualified first aiders and their contact numbers should be displayed at conspicuous places.

7.4.5.3 FIRST AID BOX (as per rule 76(2) of Bangladesh Labour Rules.2015))

- The subcontractor shall provide necessary first aid facilities. At every work place first aid facilities shall be provided and maintained.
- The first aid box shall be kept by first aider who shall always be readily available during the working hours of the work place. His name and contact no to be displayed on the box.
- The first aid boxes should be placed at various elevations so as to make them available within the reach and at the quickest possible time.
- The first aid box shall be distinctly marked with a Green Cross on white background.
- Details of contents of first aid box is given in Annexure No. 01
- Monthly inspection of First Aid Box shall be carried out by the owner as per format no. HSEP:14-F01
- The subcontractor should conduct periodical first –aid classes to keep his supervisor and Engineers properly trained for attending to any emergency.



**HEALTH, SAFETY AND ENVIRONMENT
PLAN FOR SITE SUB-CONTRACTORS
(MAITREE PROJECT)**

Doc no.: HSEP: 14-MAITREE:VENDOR

REV: 00

Date: 05.05.16

Page: 15 of 90

POWER SECTOR-EASTERN REGION

7.4.5.4 HEALTH CHECK UP

The persons engaged at the site shall undergo mandatory health checkup from a qualified doctor as per the **format no. HSEP:13-F03 and Health Record 31-A** before induction. The persons engaged in the following works shall undergo health checkup at least once in a year:

- Height workers
- Drivers/crane operators/riggers
- Confined space workers
- Shot/sand blaster
- Welding and Gas cutting personnel

7.4.6 PROVISION OF CANTEEN FACILITY

- Canteen facilities shall be provided for the workmen of the project inside the project site.
- Proper cleaning and hygienic condition shall be maintained.
- Proper care should be taken to prevent biological contamination.
- Adequate drinking water should be available at canteen.
- Fire extinguisher shall be provided inside canteen.
- Regular health check-up and medication to the canteen workers shall be ensured.

7.4.7 PROVISION OF ACCOMODATION/LABOUR COLONY

- The subcontractor shall arrange for the accommodation of workmen at nearby houses or by making a labour colony.
- Regular housekeeping of the labour colony shall be ensured.
- Proper sanitation and hygienic conditions shall be maintained and inspected once in a month.
- Adequate number of toilet facilities with water for workers as per norms to be provided. There must be separate toilet for women workers. Drinking water and electricity to be provided at the labour colony.
- Potable water shall be tested once in six months as per IS10500.
- MSDS of LPG shall be put up prominently. This shall be included in the induction training as well.
- The labour colony shall be appropriately secure so that only authorized persons have access to it.
- First aid facility shall be provided in the labour camp under the administration of trained first aiders.
- Common kitchen facilities to be ensured and cooking inside the room to be avoided. The canteen should be maintained in hygienic condition.
- No. of occupants in room rooms to be as per the standards practice.
- Awareness training shall be organized for the workers regarding fire safety, safe use of LPG, Health & Hygiene, and electrical safety etc. on monthly basis.
- Adequate drainage and approach roads to be done.
- Perimeter fencing, security and main gate entrance shall be established and maintained.
- Monthly inspection to be done to ensure the compliance and for opportunity of improvement.
- Workers shall not be transported in open vehicles i.e. trailers, truck beds etc within project boundaries which includes the labor colony.

7.4.8 PROVISION OF EMERGENCY VEHICLE (in addition to Ambulance)

Generally one vehicle (4 wheeler) is identified by each major package holder (sub-agency). Minor package holders are permitted to have a tie-up with major package holder



**HEALTH, SAFETY AND ENVIRONMENT
PLAN FOR SITE SUB-CONTRACTORS
(MAITREE PROJECT)**

Doc no.: HSEP: 14-MAITREE:VENDOR

REV: 00

POWER SECTOR-EASTERN REGION

Date: 05.05.16

Page: 16 of 90

7.4.9 PEST CONTROL

Regular pest control should be carried out at all offices, mainly laboratories, canteen, labour colony and stores

7.4.10 GENERAL DISCIPLINE:

Workmen under influence of liquor or drug or any other intoxication shall not be permitted to work and sent out of the work area. Workmen shall not be permitted to smoke in work area. None shall be permitted to carry any arms or firearms. The workmen shall report to work on time and follow supervisor's instruction. Use of cell phone particularly in hazardous jobs shall be discouraged like height work, crane operation etc. Horseplay, willful violation of rules shall be dealt with suitable disciplinary action including suspension and termination. They shall be subjected to physical frisking or alcohol/drug test at random by security and security shall be authorized to take appropriate disciplinary action against any delinquent employee like throwing out of the gate for the day and so on. If any such employee returns to work, he shall be put through induction training once again.

7.4.11 SCRAPYARD

- In consultation with customer, scrap yard shall be developed to store metal scrap, wooden scrap, waste, hazardous waste.
- Scrap/Waste shall be segregated as Bio-degradable and non-bio-degradable and stored separately.

7.4.12 ILLUMINATION (to be reviewed)

- Adequate and suitable light shall be provided at all work places & their approaches including passage ways as per IS: 3646 (Part-II) or as per Bangladesh standard. Some recommended values are given below:

S. No.	Location	Illumination (Lux)
A. Construction Area		
1.	Outdoor areas like store yards, entrance and exit roads	20
2.	Platforms	50
3.	Entrances, corridors and stairs	100
4.	General illumination of work area	150
5.	Rough work like fabrication, assembly of major items	150
6.	Medium work like assembly of small machined parts rough measurements etc.	300
7.	Fine work like precision assembly, precision measurements etc.	700
8.	Sheet metal works	200
9.	Electrical and instrument labs	450
B. Office		
1.	Outdoor area like entrance and exit roads	20
2.	Entrance halls	150
3.	Corridors and lift cars	70
4.	Lift landing	150
5.	Stairs	100
6.	Office rooms, conference rooms, library reading tables	300
7.	Drawing table	450
8.	Manual telephone exchange	200



**HEALTH, SAFETY AND ENVIRONMENT
PLAN FOR SITE SUB-CONTRACTORS
(MAITREE PROJECT)**

Doc no.: HSEP: 14-MAITREE:VENDOR

REV: 00

Date: 05.05.16

Page: 17 of 90

POWER SECTOR-EASTERN REGION

- Lamp (hand held) shall not be powered by mains supply but either by 24V or dry cells.
- Lamps shall be protected by suitable guards where necessary to prevent danger, in case of breakage of lamp.
- Emergency lighting provision for night work shall be made to minimise danger in case of main supply failure.

If the subcontractor fails to take appropriate safety precautions or to provide necessary safety devices and equipment or to carry out instructions issued by the authorized BHEL official, BHEL shall have the right to take corrective steps at the risk and cost of the subcontractor

8.0 HSE TRAINING& AWARENESS (Trainer, venue and infrastructure shall be decided by site HSE team headed by BHEL site HSE head). Cost shall be borne by respective contractor alone or on sharing basis on case-to-case basis.

8.1 HSE INDUCTION TRAINING

All persons entering into project site shall be given HSE induction training by the HSE officer of BHEL /subcontractor before being assigned to work.

In-house induction training subjects shall include but not limited to:

- Briefing of the Project details.
- Safety objectives and targets.
- Site HSE rules.
- Site HSE hazards and aspects.
- First aid facility.
- Emergency Contact No.
- Incident reporting.
- Fire prevention and emergency response.
- Rules to be followed in the labour colony (if applicable)
- Proper safety wear & gear must be issued to all the workers being registered for the induction (i.e., Shoes/Helmets/Goggles/Leg guard/Apron etc.)
- They must arrive fully dressed in safety wear & gear to attend the induction.
- Any one failing to conform to this safety wear& gear requirement shall not qualify to attend.
- On completing attending subcontractor's in-house HSE induction, each employee shall sign an induction training form (format no. HSEP:14-F03) to declare that he had understood the content and shall abide to follow and comply with safe work practices. They may only then be qualified to be issued with a personal I.D. card, for access to the work site.

8.2 HSE TOOLBOX TALK

- HSE tool Box talk shall be conducted by frontline foreman/supervisor of subcontractor to specific work groups prior to the start of work. The agenda shall consist of the followings:
 - Details of the job being intended for immediate execution.
 - The relevant hazards and risks involved in executing the job and their control and mitigating measures.
 - Specific site condition to be considered while executing the job like high temperature, humidity, unfavorable weather etc.
 - Recent non-compliances observed.
 - Appreciation of good work done by any person.
 - Any doubt clearing session at the end.
- Record of Tool box talk shall be maintained as per format no. HSEP:14-F04



**HEALTH, SAFETY AND ENVIRONMENT
PLAN FOR SITE SUB-CONTRACTORS
(MAITREE PROJECT)**

Doc no.: HSEP: 14-MAITREE:VENDOR

REV: 00

Date: 05.05.16

Page: 18 of 90

POWER SECTOR-EASTERN REGION

- Tool box talk to be conducted at least once a week for the specific work.

8.2.1 PRE JOB BRIEFING

- A separate documented daily pre job briefing must be conducted at the actual job/work site location with the supervisor and work crew, to cover working environment/conditions, safe work practices for the activities to be carried out, required PPE and review of the work package, JSA and permit requirements. Each crew member and the supervisor will sign-off on the pre job briefing form, and form will be submitted to the HSE department at the end of each shift

8.3 TRAINING ON HEIGHT WORK

Training on height work (3m and above from ground) shall be imparted to all workers working at height by in-house/external faculty at least twice in a year. Fall protection training must involve as much hands-on activity with the equipment as possible. The training shall include following topics:

- Fall hazards associated with the elevated work.
- Elements of the fall protection systems utilized
- Requirement for 100% tie-off when working at or above 6' or 2m.
- Body Harnesses of at least a five-point configuration shall be used in all fall arrest systems. The harness Deering shall have a minimum tensile strength of 5,000 pounds (22.2 kN).
- Fall protection equipment used. Use of PPEs – Harness proper fit, storage and compulsory tie-off of body harness to a firm support/life-line or anchorage point).
- Anchorage selection used for attachment of personal fall arrest systems shall be capable of supporting at least 5,000 pounds (22.2 kN) per employee attached, determined by a competent person.
- Use of fall arrester (shock absorbing lanyard), retractable fall arrester, life line, safety nets etc.
- Safe climbing through monkey ladders.
- Maintenance and Inspection of PPEs.(Daily/periodical)-color coding
- Medical fitness requirements.
- Mock drill on rescue at height.
- Dos & Don'ts during height work.For the workers & staff passed through the vertigo test, an additional sticker for height pass to be issued. This is applicable for those who are supposed to work or inspecting in BTG area, etc.

8.4 HSE TRAINING DURING PROJECT EXECUTION

- Other HSE training shall be arranged by BHEL/sub-contractor as per the need of the project execution and recommendation of HSE committee of site.
- The topics of the HSE training shall be as follows but not limited to:
 - Hazards identification and risk analysis (HIRA)
 - Work Permit System
 - Incident investigation and reporting
 - Fire fighting
 - First aid
 - T & Ps fitness and operation
 - Electrical safety
 - Welding, NDE & Radiological safety
 - Storage, preservation & material handling.



**HEALTH, SAFETY AND ENVIRONMENT
PLAN FOR SITE SUB-CONTRACTORS
(MAITREE PROJECT)**

Doc no.: HSEP: 14-MAITREE:VENDOR

REV: 00

POWER SECTOR-EASTERN REGION

Date: 05.05.16

Page: 19 of 90

- A matrix shall be maintained to keep an up-to-date record of attendance of training sessions carried out.
- Skill labour (like fitter, electrician, rigger, scaffolder, carpenter etc.) will pass through the trade test (written and practical) conducted at site by the respective engineer & EHS officer. A pass sticker of qualified person to be marked on their ID Card/Gate Pass.

8.4.1 HSE Induction for Visitors: No visitors are allowed to visit the construction site without safety induction, mandatory PPEs, and designated escort.

8.4.2 Safety Induction for all (Staff/engineers/sub-Contractors officials/supervisors): It is compulsory to provide safety induction and briefing about the site HSE management systems, requirements and individual's roles & responsibility to carry out the activities in safe manner, before deploying them.

8.5 HSE PROMOTION-SIGNAGE, POSTERS, COMPETITION, AWARDS ETC

8.5.1 Display of HSE posters and banners

- Site shall arrange appropriate posters, banners, slogans in local/Hindi/English languages at work place

8.5.2 Display of HSE signage as per [Safety signages will be as per BS 5378 safety signs & Colors and BS 5499 graphical symbols & signs](#)

- Appropriate HSE signage shall be displayed at the work area to aware workmen and passersby about the work going on and do's and don'ts to be followed

8.5.3 Competition on HSE and award

- Site will arrange different competition (slogan, poster, essay etc.) on HSE time to time (Safety day, BHEL day, World Environment Day etc.) and winners will be suitably awarded. Monthly Safety Day shall be celebrated every month preferably on a fixed date or day at the site jointly by all the contractors as a promotional measure on cost sharing basis

9.0 HSE COMMUNICATION

9.1 INCIDENT INVESTIGATION, REPORTING AND RECORDS:

Every incident including near-misses or injury of any kind and at any level of severity shall be immediately reported by the contractor's workmen in their work area to the safety officer/ HSE coordinator, site engineer or RCM. The site HSE co-ordinator shall be the nodal person for this purpose.

For any reportable injury to any employee or to the contractor's workmen, the safety officer/ HSE-coordinator shall report the incident in incident/ incident report, to CUSTOMER

In the case of serious injury requiring hospitalization or fatality, communication shall be made to customer through telecom immediately with submission of incident report within 24 hrs and detail investigation report may be forwarded in INCIDENT INVESTIGATION REPORT FORMAT within seven days.

Investigations into all reportable incidents shall be conducted using accepted Root Cause Analysis (RCA) methodology cause and effect, 5 why's, etc, to determine the Physical, Human and Latent Root Causes for these type accident/incidents. However, it is recommended to conduct preliminary investigations into all other incidents as a proactive measure.



**HEALTH, SAFETY AND ENVIRONMENT
PLAN FOR SITE SUB-CONTRACTORS
(MAITREE PROJECT)**

Doc no.: HSEP: 14-MAITREE:VENDOR

REV: 00

POWER SECTOR-EASTERN REGION

Date: 05.05.16

Page: 20 of 90

Every contractor shall maintain record of incidents / incidents at site, and shall be available for inspection by representatives of statutory agencies / officials visiting site from BHEL/customer The Safety Officer/ HSE coordinator shall maintain these records.

26.1 Incident Investigation Procedure:

The purpose of the investigation procedure is to find out root cause of accidents / incidents & not to find out faults, so as to avoid recurrences, in future and share lessons learned.

RCM shall constitute a committee of at-least 2 site engineers within 24 hours of such incidents. The investigation shall aim at finding out the basic unsafe acts / conditions that have caused the incidents. Immediately after all appropriate emergency measures, first aid and damage containment measures have been taken, every effort shall be made by the committee to:

- Preserve physical evidence
- Take photographs
- Take statement from incident victim(s) and eyewitnesses and anyone who may have knowledge of possible cause(s) of incidents

The committee shall also recommend corrective measures to prevent recurrence of similar incidents

25.2 Initial Incident Response:

In the event of an accident/incident, the supervisor and employees at the work site must:

- Stop work and make the work area safe (mitigate or remove the exposure to the hazard)
- Provide first aid and activate "Emergency Medical Services" and other emergency services, e.g. fire or police, as required,
- Ensure the injured worker is transported to "Emergency Medical Services" for medical attention if necessary,
- Secure the site to ensure the protection of employees and the public and to aid with the investigation,
- Report the incident immediately to the local Site In-Charge.

26.3 Incident Investigation Report:

The investigation committee on completion of the all investigations shall prepare and submit the report to the RCM. The report shall also include corrective measures with assigned responsibility to be taken at site to prevent similar incidents in future. The RCM shall forward the copy of the investigation report to BHEL

9.2 HSE EVENT REPORTING

- Important HSE events like HSE training, Medical camp etc. organized at site shall be reported to BHEL site management in detail with photographs for publication in different in-house magazines
- Celebration of important days like National Safety Day, World Environment Day etc. shall also be reported as mentioned above.

10.0 OPERATIONAL CONTROL

All applicable OCPs (Operational control procedures) will be followed by subcontractor as per BHEL instructions. This will be done as part of normal scope of work. List of such OCPs is given below. In case any other OCP is found to be applicable during the execution of work at site, then subcontractor will follow this as well, within quoted rate. These OCPs (applicable ones) will be made available to subcontractor during work execution at site. However for reference purpose, these are kept with Safety Officer of BHEL



**HEALTH, SAFETY AND ENVIRONMENT
PLAN FOR SITE SUB-CONTRACTORS
(MAITREE PROJECT)**

Doc no.: HSEP: 14-MAITREE:VENDOR

REV: 00

POWER SECTOR-EASTERN REGION

Date: 05.05.16

Page: 21 of 90

at the Power Sector Regional HQ, or available in downloadable format in the website, which may be referred by subcontractor, if they so desire.

LIST OF OCPs

Safe handling of chemicals	Safety in use of cranes	Hydraulic test
Electrical safety	Storage and handling of gas cylinders	Spray insulation
Energy conservation	Manual arc welding	Trial run of rotary equipment
Safe welding and gas cutting operation	Safe use of helmets	Stress relieving
Fire safety	Good house keeping	Material preservation
Safety in use of hand tools	Working at height	Cable laying/tray work
First aid	Safe excavation	Transformer charging
Food safety at canteen	Safe filling of hydrogen in cylinder	Electrical maintenance
Illumination	Vehicle maintenance	Safe handling of battery system
Handling and erection of heavy metals	Safe radiography	Computer operation
Safe acid cleaning	Waste disposal	Storage in open yard
Safe alkali boil out	Working at night	For sanitary maintenance
Safe oil flushing	Blasting	Batching
Steam blowing	DG set	Piling rig operation
Safe working in confined area	Handling & storage of mineral wool	Gas distribution test
Safe operation of passenger lift, material hoists & cages	Drilling, reaming and grinding(machining)	Cleaning of hot well / de-aerator
Electro-resistance heating	Compressor operation	O&M of control of AC plant & system
Air compressor	Passivation	Safe Loading of Unit
Safe EDTA Cleaning	Safe Chemical cleaning of Pre boiler system	Safe Boiler Light up
Safe Rolling and Synchronization		

10.1 HSE ACTIVITIES

While planning for any activity the following documents shall be referred for infrastructural requirements to establish control measures: Only specific portion of the following documents may be shared as reference at discretion of BHEL.

- 1) HSE Procedure for Register of OHS Hazards and Risks
- 2) HSE Procedure for Register of Environmental Aspects and Impacts
- 3) HSE Procedure for Register of Regulations
- 4) Operational Control Procedures
- 5) HSE Procedure for Emergency Preparedness and Response Plan
- 6) Contract documents

10.2 WORK PERMIT SYSTEM

- The following activities shall come under Work Permit System
- a The following activities shall come under Work Permit System
 - a. Height working
 - b. Hot work in general and at height including handling of hazardous substance viz, Acetylene, Oxygen and LPG
 - c. Confined space



**HEALTH, SAFETY AND ENVIRONMENT
PLAN FOR SITE SUB-CONTRACTORS
(MAITREE PROJECT)**

Doc no.: HSEP: 14-MAITREE:VENDOR

REV: 00

Date: 05.05.16

Page: 22 of 90

POWER SECTOR-EASTERN REGION

- d. Radiography
- e. Hazardous Energy Control (lockout/tagout)
- f. Excavation and Trenching
- g. Heavy lifting exceeding 50Metric Tonne
- h. Handling of Hazardous Substances- Diesel, Caustic Soda, Citric Acid/EDTA, Thinner, Battery Acid, Oil-based paint, Lubricants, Transformer oil.

Refer Annexure 05 for Work permit formats.

- Permit applicant shall apply for general work permit and other permits as referenced above of particular work activity at particular location before starting of the work with Method Statement and HIRA/Job Hazard Analysis.
- Permit signatory shall check that all the control measures necessary for the activity are in place and issue the permit to the permit holder.
- Permit holder shall implement and maintain all control measures during the period of permit .He will close the permit after completion of the work. The closed permit shall be archived in HSE Department of site.

10.3 SAFETY DURING WORK EXECUTION

Respective OCPS are to be followed and adherence to the same would be contractually binding

10.3.1 Power supply & upkeep of installation -

- Only persons licensed to Govt of State shall maintain and operate power installations.
- All distribution boxes shall be locked and the key controlled by site management of concerned contractor.
- Electrical appliance shall have proper earthing and for appliances equal to & more than 415V shall have two separate earthing (as per IS-3043-1987)
- All electrical supply shall be provided through ELCB of 30mA sensitivity.
- The working condition and sensitivity of ELCB shall be checked periodically.
- All fuses and fuse wires shall be of standard size and rating.
- All power supplies through cables shall be underground or overhead with height > 3mtrs.

The following guidelines are to be considered the absolute minimum requirements to be supplemented by requirements of all applicable codes and standards for such work; Wiring and Branch Circuits Must be protected by a proper amperage over-current device such as a HRC fuse or circuit breaker. Such installations must be located so as to prevent physical damage to the wire conductors & panels.

- Portable electric lights used in wet or potentially wet locations must be either low voltage type (24 volts or less) or protected by a GFI (ground fault interrupter).
- Must be visually checked before each use and periodically while in use to assure their original integrity is maintained. Cords with cuts, breaks, deep abrasions, etc. shall be taken out of service immediately. Repairs to extension cords shall only be performed by qualified/ licensed electricians.
- Must not be allowed to lie in wet or potentially wet areas.
- Every electric line or cable of unknown origin that is discovered or exposed during a digging, drilling, probing, or similar operation is to be considered as energized and life threatening. The senior company employee on the site will ensure that all necessary safety precautions are taken in order to isolate the line from all workers and the public. Such precautions may include halting the operation if appropriate. The senior company employee on the site is to then contact the proper authorities to have the line identified and either confirmed to be abandoned and/or made safe for continuing the work.



**HEALTH, SAFETY AND ENVIRONMENT
PLAN FOR SITE SUB-CONTRACTORS
(MAITREE PROJECT)**

Doc no.: HSEP: 14-MAITREE:VENDOR

REV: 00

Date: 05.05.16

Page: 23 of 90

POWER SECTOR-EASTERN REGION

- Any and all underground lines that are discovered or become severed must be considered energized on both sides, and be treated accordingly.
- In general, equipment or machinery being moved or transported must maintain minimum clearances of 25 ft to all power lines.
- TAG IN/ TAG OUT must be in force in Switch Room and all Distribution Boxes for live power line. The authorized person's name and contact no shall be displayed
- Ensure "double insulated" three - core cables and three pin connectors are used and are properly ground "all insulated" types, all electrical tools and appliances must be manufactured for industrial use.
- All connections shall be electrically and mechanically sound and properly insulated. Taped joints are not permitted. Connections to socket outlets must be made with proper plugs.
- Splices in electrical cords are not permitted. Repairs must be made at the socket connection and retain the same mechanical and dielectric condition of the original connection.
- Damaged or defective electric tools, equipment and extension cords, etc must not be used and shall be tagged out of service, removed from the work area and taken back to stores.
- Only licensed electricians are authorized to repair and work on electrical equipment. Tampering with electric tools or equipment by others could result in termination.
- Temporary electric cabling should be elevated 2.2 meters above the floor/ground or covered for protection. It must be kept clear of walkways and other locations where it may be exposed to damage or create a tripping hazard.
- Energized wiring in junction boxes, circuit breaker panels and similar places must be covered and locked at all times.
- Areas with live high voltage wires or terminals must be barricaded against entry and warning signs posted Danger – High Voltage and Authorized Personnel Only.
- Personnel should never work on energized equipment, deenergizing (lockout/tagout) the equipment is always the first requirement.
- The lockout and tagout procedure will be used when testing or working on, or around, energized installation.
- Working around energized equipment should never be done alone. A second electrician must always be available for assistance.
- If lockout/tagout of the work is infeasible (must be demonstrated), work on energized electrical circuits must be approved by the Site In-charge. All safety precautions necessary must be taken, PPE use must be evaluated per the exposure and used, i.e high/low voltage gloves, insulated shoes, overcoats/aprins, faceshields, and other protective equipment like insulated tools, blankets, mats, etc. must be used.
- The welding machines earth leads shall be properly fixed without loose contacts. The earth cable only has to be used. No steel members shall be used as earth leads.
- Electrical crews must be qualified for the equipment and tools they work on, including being trained in Cardio-Pulmonary Resuscitation (CPR) methods and First Aid for rendering help in the event of electric shock.

10.3.2 Qualified and Unqualified Workers (Electrical Works):

Basic electrical safety knowledge is a major concern. It is critical that only qualified workers be allowed to perform this work. Therefore only those persons that are both qualified and authorized may install, fabricate, repair, test, calibrate or modify electrical or electronic wiring, devices, parts, systems or equipment.

Qualified Person:

One who is trained and wiremen licensed to Govt as per Rule 58(9) of Bangladesh Labor Rules and familiar with the construction, operation and safety hazards of the equipment upon which they are permitted to work.



**HEALTH, SAFETY AND ENVIRONMENT
PLAN FOR SITE SUB-CONTRACTORS
(MAITREE PROJECT)**

Doc no.: HSEP: 14-MAITREE:VENDOR

REV: 00

POWER SECTOR-EASTERN REGION

Date: 05.05.16

Page: 24 of 90

- Qualified persons are intended to be only those who are well acquainted/experienced with and thoroughly conversant in the electric equipment and electrical hazards involved with work being performed.
- Only qualified persons may be permitted to work on or near exposed energized parts. Such persons are required to have been trained in three specific areas:
 - Qualified persons must be capable of working safely on energized circuits;
 - Must be familiar with the proper use of special precautionary techniques and procedures based on equipment and exposure; and
 - Must be familiar with required personal protective equipment, insulating and shielding materials, and insulated tools.
- Qualified persons are expected to be able to evaluate unknown situations and adjust their activities in such a way that only safe work practices are used. Such behavior is the responsibility of the qualified person.
- It is possible and likely for an individual to be 'qualified' with regard to certain equipment in the work place, and unqualified on other equipment they must note their limitation and stop work if not qualified on what equipment they were to work on.
- An employee who is undergoing on-the-job training, who, in the course of such training, has demonstrated an ability to perform duties safely at his or her level of training, and who is under the direct supervision of a qualified person is considered to be a qualified person for the performance of those duties. The process must be documented as proof.

11.0 Lifting Operations:

All the cranes and lifting tools & tackles shall be inspected on daily basis and as well as formal monthly by expert and as per the law third party for annual certification. These shall be tested and certificates of fitness shall be obtained from 3rd party govt approved competent agency before deploying at site and later periodically (As per Rule 60 and 75, Schedule 3 of Bangladesh Labour Rules). The last date of Third Party Inspection and the next Due date shall be conspicuously displayed on all cranes. A copy of certificate shall be pasted on operators cabin of all the lifting equipment. The record shall be maintained in Form-24

The manufacturer's instruction for maintenance shall also be followed. All safety measures shall be followed. All tools tackles, lifting appliances; material-handling equipment etc used by the contractor shall be of safe design and construction. The operators, slingers and signalers shall be qualified as per IS 13367 (part-1):2003 "Safe use of cranes- code of practices". There shall be a person responsible for co-ordination

11.1 Personnel Lifts (Man-Basket): (To be treated as a T&P item)

A Personnel Man-Basket permit shall be completed prior to lifting any people, along with a rigging plan. Man-basket shall be used where access through ladders or scaffolding is not feasible. Man-baskets shall be designed and engineered by a manufacturer (job made man-baskets are not allowed, unless designed and tested by a certified engineer), and built robust with MS Angles and flats or plates or channels only. Guard rails top and mid, must be in place and screened-in to avoid material from falling out of basket. The factor of safety shall be 200%. It shall have a door with double latches and shall open inside. Anchor points shall be identified within the man-basket. The man-basket shall be thoroughly inspected and load tested and a trial run performed without personnel before being put to job. It shall be treated as a lifting tool and shall undergo same certification cycle and inspection as other lifting equipments. An additional sling of required lifting capacity shall be fixed to the man-basket main lifting point and attached to the crane above the ball or block. While lifting man-basket, the crane shall maintain a uniform speed of lift without any swing. Once man-basket reaches the destination, the lift brakes shall be locked as long as the basket remains at that point. The same care shall be taken in its descent. As for hanging man-basket, the same shall be hung off a rigid structure with help U-shaped handle welded to man-basket. This shall be tested once in a year by a competent person.



HEALTH, SAFETY AND ENVIRONMENT PLAN FOR SITE SUB-CONTRACTORS (MAITREE PROJECT)

Doc no.: HSEP: 14-MAITREE:VENDOR

REV: 00

Date: 05.05.16

POWER SECTOR-EASTERN REGION

Page: 25 of 90

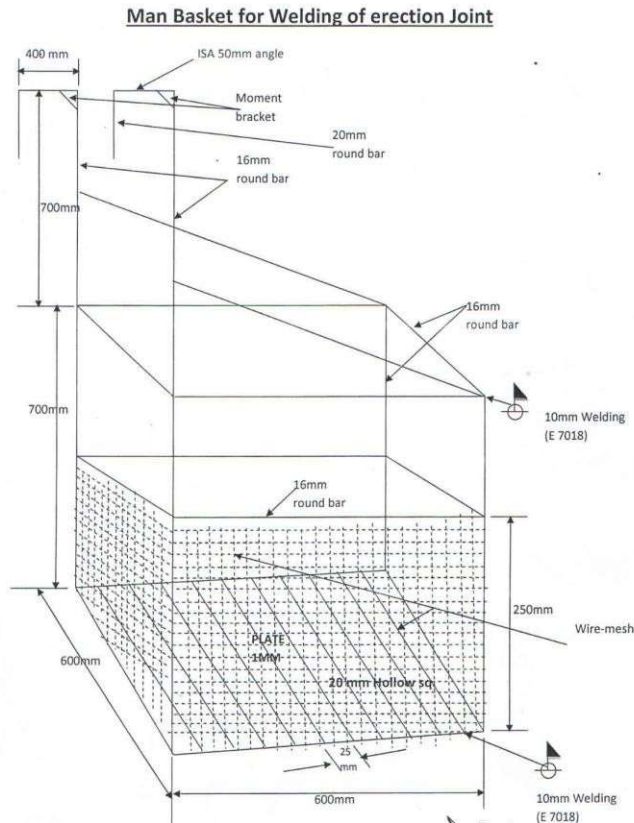

11.2 CRANES AND HOISTING EQUIPMENTS:

This procedure provides the guidelines to ensure proper rigging and lifting activities are accomplished safely and in accordance with applicable specifications, codes, and regulations.

- On every crane or piece of hoisting equipment notices of all rated load capacities, recommended operating speeds, and any hazard warnings or special instructions shall be conspicuously posted. All instructions and warning shall be visible from the equipment operator's station.
- Cranes shall have an Anti Two-block safety device installed
- All mobile cranes shall have overload and backup alarms
- Load angle indicators and limit switch

All areas within swing radius of cranes that are potentially accessible by pedestrian, vehicular, or equipment movement shall be barricaded to prevent anyone or any vehicle or equipment from being struck by the crane or hoisting equipment, or its load(s).

- No part of the lifting equipment or its load shall be within the distance as specified in the Indian Electricity Act from an energised power line
- Cranes shall have annual certified third party inspection and be inspected before use by the operator. Any defects shall be corrected before use. Logs of crane inspection shall be kept with the crane.
- Make certain that the rigging personnel, material, and equipment have the necessary capabilities for the job and are in safe condition.



HEALTH, SAFETY AND ENVIRONMENT PLAN FOR SITE SUB-CONTRACTORS (MAITREE PROJECT)

Doc no.: HSEP: 14-MAITREE:VENDOR

REV: 00

Date: 05.05.16

POWER SECTOR-EASTERN REGION

Page: 26 of 90

- Communicate with person(s) directly responsible for accomplishing the work and / or work area to establish requirements/responsibilities and make certain that all preparatory work is complete.
- Mats/Pads must be used on all lifting equipment, equipped with outriggers.
- Pick and carry must have the load secured to the rig in front.
- Proper crane setup:

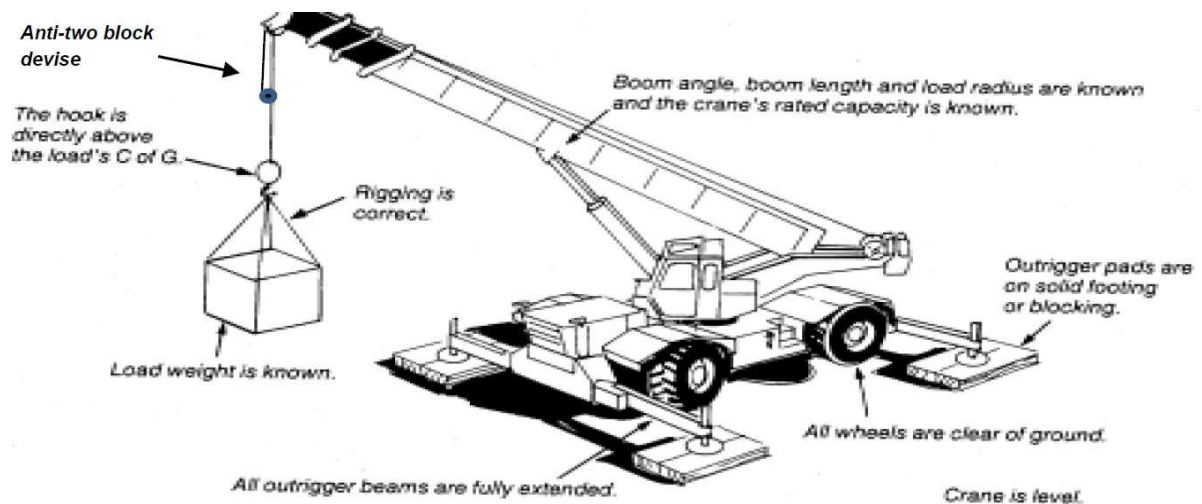

11..2.1 Safe Rigging Practices:

- Review the planned operation and requirements with the operator and rigging crew.
- Ensure a pre-lift meeting is conducted with crane operator, tagline operator, signal personnel, and Safety Manager.
- Designate a qualified person from the rigging crew to observe clearance of the equipment and give timely warning for all operations where it is difficult for the operator to maintain the desire clearance by visual means.
- Clear the lift area of all unnecessary personnel.

11.2.2 The following are rules for safe rigging:

- Use loops, thimbles and corner pads to prevent damage to slings when used around corners or on cutting edges.
- Never allow wire rope to lie on the ground for any length of time or on rusty steel or near solvents, chemicals or corrosive substances.
- Slings must not be pulled from between or under loads with load resting on the sling.
- Keep all rope away from flame cutting or welding operations.
- Never use rope as sling material.
- Never wrap a wire rope completely around a hook.
- Do not bend wire rope near any attached fitting.



**HEALTH, SAFETY AND ENVIRONMENT
PLAN FOR SITE SUB-CONTRACTORS
(MAITREE PROJECT)**

Doc no.: HSEP: 14-MAITREE:VENDOR

REV: 00

POWER SECTOR-EASTERN REGION

Date: 05.05.16

Page: 27 of 90

- The sling must be selected to suite the most heavily loaded leg rather than the total weight when using multi-legged sling to lift loads in which one end is heavier than the other.
- When using 3 and 4 legged sling configurations, any two legs must be capable of supporting the entire load.
- Where possible, wire rope choker hitches must include a shackle with the eye around the shackle pin to prevent breaking wires of the choke. The choker hitch must be “snugged down” prior to lifting, not after tension is applied.
- Unless authorized by the hook manufacturer when more than two rope eyes are placed over a hook, install a shackle, pin resting in the hook, and place the rope eyes in the bowl of the shackle.
- Properly rig all loads to prevent dislodgment of any part.
- Use guide ropes or tag lines to prevent the rotation or uncontrolled motion of the load when necessary.
- Loads must be safely landed and properly blocked before being unhooked and unslung. Tag lines must not be used in situations that jeopardize the safety of the lift.
- Lifting beams must be plainly marked with their weight and designed working load and must only be used in the manner for which they were designed.
- The hoist rope or chain must never be wrapped around the load. The load must be attached to the hook by slings or other rigging devices that are adequate for the load being lifted.
- Multiple part lines must not be twisted around each other.
- The hook must be brought over the center of gravity of load before the lift is started.
- If there has been a slack rope condition, determine that the rope is properly seated on the drum and in the sheaves prior to lifting.
- Keep hands away from pinch points as the slack is being taken up.
- Leather gloves are recommended when handling wire rope.
- Avoid impact loading caused by sudden jerking when lifting or lowering. Lift the load gradually until the slack is eliminated.
- Never ride on a load that is suspended.
- Avoid allowing the load to be carried over the heads of any personnel.
- Never work under a suspended load until the load has been adequately supported from the floor and all conditions have been approved by the supervisor in charge of the operation.
- Never leave a load suspended unless emergency evacuation is required.
- Never make temporary repairs to sling.
- The capacity of a sling is determined by its angle, construction, type of hitch and size.
- Never lift loads with one leg of a multi-leg sling until the unused legs are made secure.
- Never point load a hook unless it is especially designed and rated for such use.
- Make certain that the load is broken free before lifting and that all legs are taking the load.
- When using two or more slings on a load make certain all slings are made from the same materials.
- Lower the loads on to adequate blocking to prevent damage to the slings.
- Materials and equipment being hoisted must be loaded and secured to prevent any movement which could create a hazard in transit.
- The weight of the hook, load block and any material handling devices must be included when determining crane capacity.
- Operator must have clear sight of loads being picked up or put down by crane. Tag lines will be used to control the loads. Loads must not be touched by hand while placing/ moving.



**HEALTH, SAFETY AND ENVIRONMENT
PLAN FOR SITE SUB-CONTRACTORS
(MAITREE PROJECT)**

Doc no.: HSEP: 14-MAITREE:VENDOR

REV: 00

POWER SECTOR-EASTERN REGION

Date: 05.05.16

Page: 28 of 90

11.2.3 Synthetic Slings

The following are rules for safe use of synthetic slings:

- Synthetic slings must be marked to show the rated capacity for each type of hitch and type of web material.
- Nylon web slings must not be used where fumes, vapors, sprays or mists or liquids of acids or phenolic are present. Web slings with aluminum fittings must apply in this category.

11.2.3.1 Synthetic web slings must be removed from service and destroyed if any of the following conditions are present:

- Acid or caustic burns
- Melting or charring of any part of the sling surface
- Snags, punctures tears or cuts
- Broken stitches
- Distortion of fittings
- Synthetic web slings of polyester or nylon must not be used at or come in contact with temperatures in excess of 82°C
- Polypropylene web slings must not be used at or come in contact with temperatures in excess of 93°C
- Insulated hooks must be tested yearly to insure insulation integrity to at least manufacturer's specifications.

11.2.4 Wire Rope Slings must be removed from service and destroyed if any of the following conditions are present:

- In (10) randomly distributed wires broken in one (1) rope lay, or five (5) broken wires in one (1) strand in one (1) rope lay.
- Wear or scraping of one-third the original diameter of outside wires.
- Kinking, crushing, bird caging or any other damage resulting in distortion of the wire rope structure such as:
- Evidence of heat damage.
- End attachments that are cracked, deformed worn.
- Corrosion of the rope or end attachments.

11.2.5 Metal mesh slings must be immediately removed from service if any of the following conditions are present:

- A broken weld or broken brazed joint along the sling edge.
- Reduction in wire diameter of 25 percent due to abrasion or 15 percent due to corrosion.
- Lack of flexibility due to distortion or corrosion.
- Synthetic web slings must be removed from service and destroyed if any of the following conditions are present:
- Acid or caustic burns
- Melting or charring of any part of the sling service
- Snags, punctures, tears or cuts
- Broken stitches
- Distortion of fittings



**HEALTH, SAFETY AND ENVIRONMENT
PLAN FOR SITE SUB-CONTRACTORS
(MAITREE PROJECT)**

Doc no.: HSEP: 14-MAITREE:VENDOR

REV: 00

Date: 05.05.16

Page: 29 of 90

POWER SECTOR-EASTERN REGION

11.2.6 Requirements of Plate Clamps:

- The rated load of the plate clamp must be marked on the main structure.
- Care must be taken to make certain the load is correctly distributed for the plate clamp being used.
- Do not allow load or plate clamp to come into contact with any obstruction.
- The plate clamp must not be used for side pulls or sliding the load.
- When lifting stainless steel or special alloys, ensure plate clamp is designed for use on the specific metal.

11.2.7 Crane operators must follow the followings:

- Pass an annual Operator's Physical examination
- Carry a valid experience certificate from the previous employers

11.2.8 Colour Coding Procedure

- Inspections and tests shall be documented by means of color coding which shall verify that inspections or testing are current and that all receptacles, portable Power tools, Lifting Tools & Tackles have been inspected and tested as required. The color codes used on the project shall be:

GREEN	BLUE	YELLOW	RED
January February March	April May June	July August September	October November December

-
-
- The cycle of colors shall be Quarterly. The color code tape / Sticker shall be clearly visible to designate the period for which the inspections and tests were conducted.
- Following the initial inspection the equipment must be color-coded quarterly as per color-coding instructions that will be issued by the CONTRACTOR.
- Fire extinguisher with the current month color-coding inspection sticker must be provided and secured in the platform.
- All slings shall be regularly inspected in accordance with the requirement of the project for frequent and periodic inspections and removed from the job site if they fail to meet the minimum requirements of the project.
- The CONTRACTOR'S SFO shall ensure that all PPE is inspected prior to its issue. He is to ensure all SUBCONTRACTOR personnel are using safe and proper PPE equipment. Regular inspections on the PPE shall be carried out and personnel not adhering to those inspections shall be removed immediately from the SITE.
- A five (10) day interval period shall be given into each monthly color code change. During this five (10) day period either color shall be acceptable.



HEALTH, SAFETY AND ENVIRONMENT PLAN FOR SITE SUB-CONTRACTORS (MAITREE PROJECT)

Doc no.: HSEP: 14-MAITREE:VENDOR

REV: 00

POWER SECTOR-EASTERN REGION

Date: 05.05.16

Page: 30 of 90

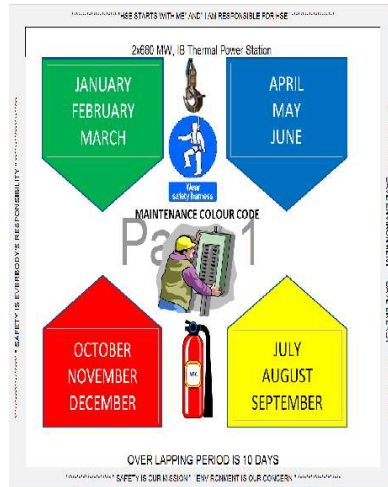

12.0 Fire prevention, protection & preparedness -

The Fire Prevention, Protection and Preparedness Program is an integral part of the overall HSE Program. Effort and consideration must be given to safety, life and potential for delays in construction schedules and plant startup, as well as protection of property on a given project.

The purpose of which is to prevent -

- Inception of fire
- Loss of life or personal injury
- Loss of Property
- Interruption of operations

Site-in-charge / Safety Officer will make periodical review of the site Fire Protection, Prevention Preparedness Programme, Site conditions and available fire protection equipment. It is very imperative that the Sub-contractors along with BHEL to establish good contact with Local fire station for availability of Fire tender in case of emergencies, in addition to their own fire equipment.

Fire Protection, Prevention and Preparedness Inspections - The Contractor /Sub-Contractor will be required to make frequent fire prevention inspections of his work site and operating facilities. Deficiencies will be corrected at once.

- Area where Hot work activities are carried out (Gas cutting / Welding/ any other spark producing work) above a working spot, a GI / fire-resistant non-asbestos sheet or suitable material shall be placed to prevent the fall of hot sparks. A bucket of water shall be kept nearby while doing hot work
- Hot work shall be preferably carried out in a designated area with a standing Hot Work Permit, to be renewed monthly. The designated area shall have fire extinguishers.
- Any hot work outside designated area shall require a Hot Work permit and fire watch.

No flammable material shall be stored within 35 feet from any fire load.

- Necessary fire extinguishers shall be kept at accessible area as per the chart below:
- The record of Fire safety training and Fire drill shall be maintained in Form-22 and 22(A)



HEALTH, SAFETY AND ENVIRONMENT PLAN FOR SITE SUB-CONTRACTORS (MAITREE PROJECT)





Doc no.: HSEP: 14-MAITREE:VENDOR

REV: 00

POWER SECTOR-EASTERN REGION

Date: 05.05.16

Page: 31 of 90

Extinguisher		Type of Fire				
Colour	Type	Solids (wood, paper, cloth, etc)	Flammable Liquids	Flammable Gasses	Electrical Equipment	Cooking Oils & Fats
	Water	✓ Yes	✗ No	✗ No	✗ No	✗ No
	Foam	✓ Yes	✓ Yes	✗ No	✗ No	✓ Yes
	Dry Powder	✓ Yes	✓ Yes	✓ Yes	✓ Yes	✗ No
	Carbon Dioxide (CO2)	✗ No	✓ Yes	✗ No	✓ Yes	✓ Yes

- Emergency telephone number to be displayed at all conspicuous places.

General flammable material storage requirements:

- All flammable material shall be stored in deigned areas and/or in flammable storage cabinets, as necessary.
- Fire extinguishers shall be located near by and have unobstructed access.

13.0 RADIOGRAPHY: Wherever the process requires examination by radiography,

- BHEL /contractor shall use approved radiography contractors for the work on site.
- Site radiography shall be carried out after advance notification to the HSE officer and client personnel. All radiography on the site shall be subject to receipt of client/BHEL work permit and shall normally be performed outside of normal working hours. No ionising radiation sources shall be left unsupervised whilst on site.
- A minimum of 2 qualified persons from the radiography contractor are required for each activity involving ionising radiation. Adequate warning signs shall be posted on barriers and the work area shall be marked off at a safe distance with tape or hard barricades prior to starting radiography by concerned job sub-contractor.
- All personal executing radiography operations shall carry calibrated radiation monitoring devices at all times.
- The storage of radioactive sources on the site is prohibited, they shall be present only for the time required to complete the work. Whilst not in use, radiation sources and their container shall be secured in a safe location with adequate warning signs displayed as per AERB guidelines.

14.0 Confined Space Entry:

A confined space must have an opening of minimum dimension of 40.65cm X 30.65cm if shape is rectangular or oval and dia of 40.65cm if shape is round.



**HEALTH, SAFETY AND ENVIRONMENT
PLAN FOR SITE SUB-CONTRACTORS
(MAITREE PROJECT)**

Doc no.: HSEP: 14-MAITREE:VENDOR

REV: 00

POWER SECTOR-EASTERN REGION

Date: 05.05.16

Page: **32 of 90**

A hazard assessment must be completed prior to any entry into a confined space. The hazard assessment must identify the sequence of work to be performed in the confined space, the specific hazards known or anticipated, and the control measures to be implemented to eliminate or reduce each of the hazards to an acceptable level. No entry must be permitted until the hazard assessment has been reviewed and discussed by all persons engaged in the activity. Personnel who enter confined spaces must be trained per role e.g. entrant (worker), confined space supervisor & attendant, and must be informed of known or potential hazards associated with the confined spaces to be entered. Number of persons entering shall be kept at minimum. All confined spaces must be inventoried at site and kept on file. Confined spaces must be posted at the entrance with similar type wording "DANGER - Do Not Enter – Confined Space - Permit Required".



Once a hazard assessment is completed the Contractors/Subcontractors requirements are:

- All confined space activities must be reviewed with the Contractor's Safety Manager prior to commencement of the work. Confined space permits are required as part of the entry process.
- Prior to entering the confined space, the area must be completely controlled to prevent the entry of any unauthorized individual, hazardous substances, or materials, which would threaten the safety of the entrants and the stability of the space. All energy sources, including stored or residual energy, must be isolated and/or blanked, and locked out.
- All shall be given a pep-talk by the concerned supervisor giving details of the jobs to be performed, hazards and risks associated and mitigation measures. The persons shall be provided with all necessary PPEs including respiratory masks, if necessary.
- The confined space must be monitored prior to one entering the identified area. Then periodic atmospheric testing must take place throughout the entry, especially after breaks or work interruptions during the entry. Continuous monitoring is preferable, and may be necessary in certain situations. Monitoring results must be documented on the entry permit with the initials of the individual conducting the testing.
- Contractors/Subcontractors must complete a Confined Space Permit before permitting workers to enter the space. This document must be reviewed and approved via a signature by the entry supervisor. The content of the completed permit must be reviewed with the entrants before entering the space and posted at the confined space entrance.
- A proper and accessible means of exit and exit shall be ensured before entry.
- The space shall be illuminated with 24V lamps only
- All gas cylinders/welding machines shall be preferably kept outside the confined space. Even cutting torches/ electrode holders shall be kept outside, when not in use, if possible.
- All electrical equipments shall be connected to ELCB
- The confined space must have an attendant monitoring the activities within the space. This individual must be in constant communication with work crew inside the space. The attendant must know who is inside the space, that must



**HEALTH, SAFETY AND ENVIRONMENT
PLAN FOR SITE SUB-CONTRACTORS
(MAITREE PROJECT)**

Doc no.: HSEP: 14-MAITREE:VENDOR

REV: 00

Date: 05.05.16

Page: **33 of 90**

POWER SECTOR-EASTERN REGION

be documented. The attendant must not have any other responsibilities than monitoring the space. He/she may not enter the space to perform rescue unless relieved of the duties as an attendant.

- Adequate ventilation must be provided to establish and maintain a stable atmospheric environment. Air circulation shall be ensured. Fumes/dusts generated inside shall be extracted. Ventilation systems must be designed for use in confined spaces.
- Any space 5' or more in depth must have a mechanical retrieval system. This system must be designed for the retrieval of human, and must not be used for equipment purposes. Workers inside the space must wear full body harnesses, and must be connected to the retrieval system.
- Rescue procedures must be established prior to any entry. The local fire department must be contracted prior to entry if they will be the primary source of rescue.
- All individuals involved in the confined space activities must be trained, including hands-on experience with the safety equipment involved. Documentation of the required training must be available prior to the start of any confined space work activities.
- The confined space shall be cleared off all cables, machines, cylinders, materials at the end of the day's work as far as possible.

Once the confined space work has been completed, the entry permit must be cancelled. A copy of the cancelled permit must be given to the HSE Manager

15.0 Welding and Gas Cutting Operations

- When possible, items to be welded, cut, heated, etc. shall be moved to a safe location free of combustible or flammable material. If this is not possible, then all combustibles/flammables that can be removed from the area shall be removed within a 35 foot circumference and a positive means of confining arcs and sparks generated by the process shall be taken and additional person(s) shall be stationed as fire watch for the area(s) still exposed, along with obtaining the Hot Work Permit as applicable.
- Appropriate fire-fighting equipment is to be available in close proximity of any welding and gas cutting operations at all times.
- Drums, tanks, and similar containers that have contained flammable or toxic material shall not be welded, cut, or heated until they have been made safe by water filling, thorough cleansing, or similar accepted practices. The container shall also be ventilated during the welding, cutting, or heating process.
- Proper ventilation is required for any welding or torch operations performed in a confined space.
- Any welding or gas cutting operations performed on metals of toxic compounds or coating such as zinc, stainless steel, lead, cadmium, chromium, and beryllium shall be properly ventilated and/or proper respiratory protection shall be worn by any person that could be exposed to fumes, vapors, and gasses created by the welding and gas cutting processes.
- Wherever it is practical, all arc welding operations shall be shielded to prevent direct light rays or sparks from contacting persons in the vicinity or from reaching areas normally used to travel through or into the vicinity. Where this is not practical, persons who shall be in the area are to use proper eye and skin protection. Other persons who are not participating in the welding or gas cutting operations are not to be allowed into the hazard zone.
- Welders and other employees who are exposed to arc welding radiation shall wear suitable clothing and protective apparel to prevent burns and other types of ultraviolet radiation damage to the skin.
- Arc welding machines shall be shut down when being moved or when they are not in continuous use.
- Electrode holders left unattended shall have electrodes removed and shall not be left where they might contact



**HEALTH, SAFETY AND ENVIRONMENT
PLAN FOR SITE SUB-CONTRACTORS
(MAITREE PROJECT)**

Doc no.: HSEP: 14-MAITREE:VENDOR

REV: 00

Date: 05.05.16

Page: **34 of 90**

POWER SECTOR-EASTERN REGION

employees or conducting objects.

- Arc welding power supply cable shall be of proper rating and material, e.g. copper.
- Welders shall guard against allowing materials adjacent to or behind them to reflect radiation back toward them or towards others in the area. Reflected radiation can cause skin burns and eye flash burns.
- Compressed gas cylinders shall always be secured from tipping or falling, whether in use, in storage or in transit. The cylinders shall always be secured upright, except during times when actually being hoisted or carried.
- Valve caps shall be in place when cylinders are not in use. Valve caps shall never be used for lifting the cylinder vertically.
- Regulators shall be removed when cylinders are not in use or are in transit, unless the cylinder is firmly secured on a special carrier designed for this purpose.
- Cylinders being transported by a powered vehicle shall be secured in an upright position. Gas cylinders are not allowed to be used in man-basket when occupied.
- Cylinders containing oxygen or fuel gasses shall not be taken into confined spaces.
- Oxygen cylinders shall be stored a minimum of (6) meters from fuel gas cylinders or shall have an approved firewall between them.
- Torches shall only be lit by approved strikers; never with matches, cigarette lighters, or hot work.
- While carrying out job at height, the sparks or molten slag shall be prevented from falling down by putting a fire-resistant (non-asbestos) sheet or even MS Sheet. If such can not be provided, the passage of falling sparks or molten slag shall be barricaded till ground floor and any cable/ tubes/ any other objects interfering in the passage shall either be removed or covered with Fire-resistant sheet or M S Sheet.

16.0 COMPRESSED GAS :

- All cylinder valves shall be closed when any work is finished and when any cylinders are empty or being moved.
- Valve protection caps shall be placed and secured properly before gas cylinders are transported, moved or stored.
- Compressed gas cylinders shall be secured in an upright position with chain or other appropriate means.
- All cylinders shall be kept at a safe distance from welding or cutting operations or shielded from safe.
- All cylinders shall be placed where they cannot become part of the electrical circuit.
- Oxygen and acetylene shall not be stored together.
- Oxygen and fuel gas regulators, hoses and associated equipment shall not be altered and shall be in proper working order while in use.
- Compressed air can be extremely dangerous if allowed to penetrate the skin. As such, the use of compressed air to clean off yourself or other workers shall be strictly prohibited.



**HEALTH, SAFETY AND ENVIRONMENT
PLAN FOR SITE SUB-CONTRACTORS
(MAITREE PROJECT)**

Doc no.: HSEP: 14-MAITREE:VENDOR

REV: 00

POWER SECTOR-EASTERN REGION

Date: 05.05.16

Page: 35 of 90

17.0 **WORK AT HEIGHT:** All work at height above 3meter above ground level without complete platforms, handrails and other related fall protection shall require a work permit in the prescribed form. This shall require approval by the competent authority. The HSE officer of sub-contractors and subsequently BHEL shall follow the checklist religiously by physically verifying the condition of the work area before recommending for approval.

Whenever a fall hazard or other exposure exists for working at heights more than 3m, the nature and scope of work will be evaluated for conditions and environmental factors before selecting the appropriate fall protection system (active, passive or a combination of measures, as appropriate). A personnel fall protection system must include:

- The only permissible personal fall arrest system is an industry approved safety harness. Employees can use positioning belts with two-D ring attachment points as long as they are used in conjunction with a safety harness. Safety harnesses must be secured to an overhead object of substantial capacity capable of supporting five thousand pounds. In order to accomplish this and ensure 100% protection, the worker may need to use two lanyards. The primary lanyard is never unhooked until the secondary lanyard is secure.
- The type of work and the environment conditions determine lanyard and lifeline selection. If welding, chemical cleaning that may damage lanyards, connectors or lifelines, sandblasting, etc., either protect the components or use more appropriate type of system. Lanyards and lifelines must incorporate, or be used with, an appropriate deceleration (shock absorbing) device. Deceleration devices include rope grabs, rip-stitch lanyards, specially woven lanyards, tearing, or deforming lanyards, automatic self-retracting lifelines and lanyards which dissipate or limit the energy imposed on the employee during fall arrest. Once in use, the system's effectiveness is to be monitored. In some cases, a program for cleaning and maintaining the system may be necessary. Lanyard and lifelines must use locking snap hooks only and under no circumstances must two lanyard snap hooks be connected.

Minimum Requirements:

Prior to the start of work at elevation, the HSE Manager involved with the work must meet with the work supervisor to review the scope of work, and must review all the possible fall hazards and effective safety responses. The evaluation/analysis must be documented and kept on file and on site by the HSE Manager.

The procedures for the safety response to identified fall hazards developed and rescue plans by must be reviewed with all individuals exposed to the hazards.

The HSE Manager must establish an inspection process of fall protection systems. Some equipment requires documented inspections by its manufacture on a regular schedule. This equipment must have evidence of the inspection and re-certification process on it. This information must be reviewed before the equipment is actually used. Individuals must visually inspect the fall protection equipment before each use. Failure to complete this inspection process could result in serious injury or death.

Immediately remove from service any fall protection equipment that is identified as defective, damaged, or has been subjected to an impact. Damaged fall protective equipment must be destroyed to prevent re-use and not be discarded into trash containers, as the worn or damaged equipment could be unintentionally re-used.

Aerial lifting devices, excluding scissors lifts require the use of full body harnesses and lanyards in any elevated position.

All lifelines in general are to be made of min 8mm dia steel rope and tied to columns with 3 clamps at each end. Wherever columns are not available to tie the lifelines, the vertical posts are to be provided after carrying out drop-



**HEALTH, SAFETY AND ENVIRONMENT
PLAN FOR SITE SUB-CONTRACTORS
(MAITREE PROJECT)**

Doc no.: HSEP: 14-MAITREE:VENDOR

REV: 00

POWER SECTOR-EASTERN REGION

Date: 05.05.16

Page: **36 of 90**

load test initially.

18.0 SCAFFOLDS: (As per IS 3696 or any international standard)

The safe and efficient erection, use, dismantling, and storage of scaffolds, ladders and elevated work platforms are considered important objectives in maintaining a safe work environment. This procedure provides the guidelines for erection, use, dismantlement, and storage of scaffolding and elevated work platforms.

There is no such thing as a temporary scaffold. All scaffolds must be erected and maintained to conformed standard. The Scaffold Tagging defines satisfactory, incomplete or defective scaffolds.

Management must ensure or have each worker who performs work while on a scaffold trained by a person qualified in the subject matter to recognize the hazards associated with the type of scaffold being used and to understand the procedures to control or minimize those hazards.

All employees must be competent for the type of scaffolding work they are undertaking and should have received appropriate training relevant to the system they are working on.

- All scaffolds shall be erected / dismantled by scaffolding crew under direct supervision of **competent scaffolding supervisors**.
- All scaffolds shall be capable of supporting 4 times maximum intended load and erected on sound, rigid footing, capable of carrying the maximum intended load without settling or displacement. Bamboo scaffolding is not permitted for use on site.
- Guard rails and toe boards shall be installed on all open sides and ends of platforms more than (2) meters above ground or floor

Scaffold planks must be at least 5 cm x 25 cm (2" x 10") full thickness lumber scaffold grade or better.

- Scaffold planks shall not span distances greater than 2.5 meters (8 feet).

Scaffold planks shall extend over end supports not less than 6 inches nor more than 12 inches and be secured to the scaffold. Scaffolding and accessories with defective parts shall be immediately repaired or replaced.

- All scaffolding must be a minimum of two planks wide. No one may work from a single plank.
- Scaffold planks must be inspected before use. Planks that have been damaged must be removed from the site.
- Access ladders must be provided for each scaffold. Climbing the end frames is prohibited unless the design incorporates an approved ladder.
- Adequate mudsills or other rigid footing capable of withstanding the maximum intended load must be provided.
- Scaffolds more the 6 meters (20 feet) in height must be tied to the building or structure at intervals which do not exceed 4 meters (13 feet) vertically and 6 meters (20 feet) horizontally.
- Do not overload scaffolds. Material should be brought up as needed. Scaffolding must not be loaded in



**HEALTH, SAFETY AND ENVIRONMENT
PLAN FOR SITE SUB-CONTRACTORS
(MAITREE PROJECT)**

Doc no.: HSEP: 14-MAITREE:VENDOR

REV: 00

Date: 05.05.16

Page: 37 of 90

POWER SECTOR-EASTERN REGION

excess of its rated capacity.

- Barrels, boxes, kegs, blocks or similar unstable object must never be used as work platforms or to support scaffold.
- Where persons must work under or pass under a scaffold then a 18 gauge wire mesh screen must be installed between the toe board and guard rail.
- Employees exposed to overhead hazards while working on a scaffold will be protected by 5 cm (2") thick planks.
- Wooden/bamboo ladders shall not be allowed at any cost. Ladder's rungs shall be fitted /welded properly. Before every use the rungs should be checked for safe use.
- The platform should have permanent hand rail and mid rail with Toe board without fail.
- All platforms are to be tightly planked for the full width of the scaffold, except as may be necessary for entrance openings. Platforms shall be secured in place.
- On suspension scaffolds designed for a working load of 500 pounds, no more than two workers are permitted to work on the scaffold simultaneously. On suspension scaffolds with a working load of 750 pounds, no more than three workers are permitted on the scaffold simultaneously. Each employee on the scaffold shall use an approved safety harness attached to an independent lifeline. The lifeline is to be securely attached to substantial members of the structure (not the scaffold itself) or to securely rigged lines, which shall safely suspend a worker in event of a fall.

Suspension Scaffold

- Suspended scaffolds are platforms suspended by ropes, or other non-rigid means, from an overhead structure.
- Requirements for use are to be preapproved by HSE Head, under a specific Permit to Work.

Rolling Scaffolds

- The height of rolling scaffolds shall not exceed three times the minimum base dimension.
- The minimum base dimension of rolling scaffold will be 1.25 meters (4 feet).
- Adequate help must be provided when moving a rolling scaffold.
- Secure or remove all loose materials, equipment and tools before moving a rolling scaffold.
- No one is permitted to ride a rolling scaffold when it is being moved. Castor brakes must be locked - on when the scaffold is not being moved.

Typical Scaffold Designs

Tube & Coupler Scaffold –



**HEALTH, SAFETY AND ENVIRONMENT
PLAN FOR SITE SUB-CONTRACTORS
(MAITREE PROJECT)**

Doc no.: HSEP: 14-MAITREE:VENDOR

REV: 00

POWER SECTOR-EASTERN REGION

Date: 05.05.16

Page: 38 of 90

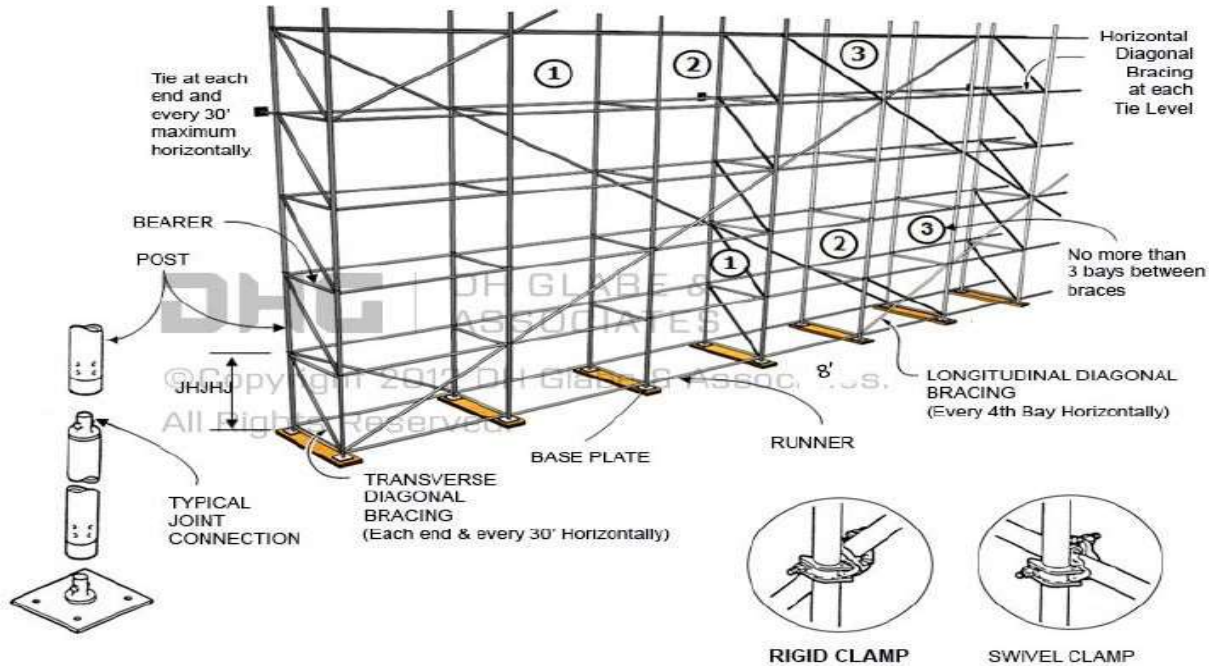

Rolling Scaffold –

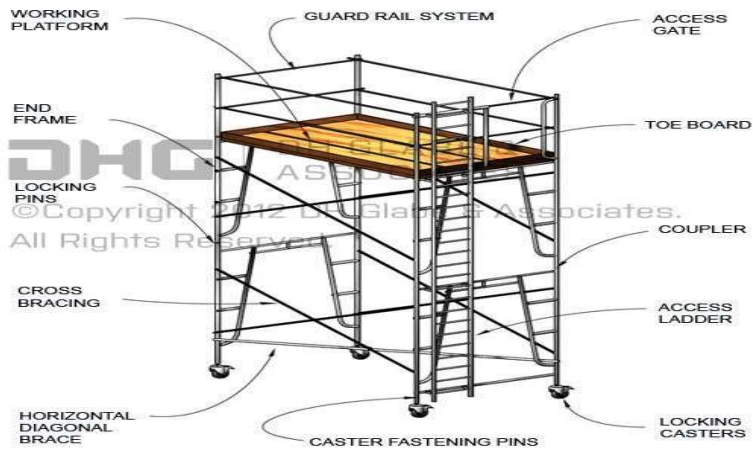

Scaffold Tagging:

Scaffolds being erected, modified or dismantled must be tagged as suitable for use. The scaffolds can only be accessed by those involved with the process.

- GREEN scaffold tag- shall be fixed when scaffold is complete and safe for use, signed and dated by the scaffolding competent person daily.



**HEALTH, SAFETY AND ENVIRONMENT
PLAN FOR SITE SUB-CONTRACTORS
(MAITREE PROJECT)**

Doc no.: HSEP: 14-MAITREE:VENDOR

REV: 00

POWER SECTOR-EASTERN REGION

Date: 05.05.16

Page: 39 of 90

- RED scaffold tag – to be fixed if scaffold is in some way defective and cannot be used or is still under erection.

Examples of scaffold tags:

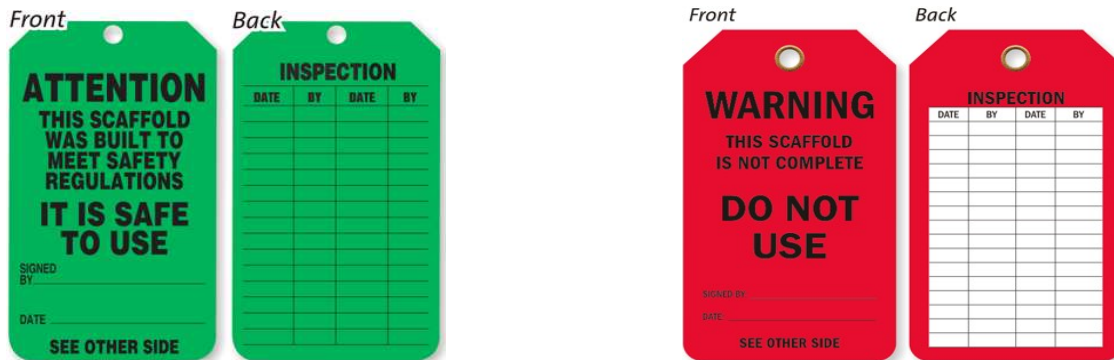

18.1 SAFE USE OF LADDERS.

- ❖ Fall protection is required when working on a ladder above 2 meters and when climbing above nearby guardrails.
- ❖ Ladders must be inspected prior to use and by a competent person quarterly, with documentation.
- ❖ Use portable ladders for height up to 4 M only
- ❖ Provide fixed ladders for height above 4 M
- ❖ Place the ladder at an angle of 75 degrees (approx) from the horizontal (1:4)
- ❖ Extend ladder at least 1 M above the top landing
- ❖ Secure top and bottom of the ladder firmly to prevent displacement- anti skid lining at the bottom
- ❖ Ensure that the width of the ladder is not less than 300 mm and distance between rungs is not more than 300 mm
- ❖ Provide landings of minimum size 600 x 600 mm at intervals not more than 6 M for fixed ladders. Check the ladders daily for any defects
- ❖ Ensure that the areas around base and top of the ladder are clear. Getting on and off the ladder is more hazardous than using it. Use a mudsill if the ladder is to rest on soft, loose or rough soil
- ❖ Do not use ladders of conducting material near power lines, and only use ladders near powerline or other energize system with exposed parts if they are confirmed locked-out and de-energized.



**HEALTH, SAFETY AND ENVIRONMENT
PLAN FOR SITE SUB-CONTRACTORS
(MAITREE PROJECT)**

Doc no.: HSEP: 14-MAITREE:VENDOR

REV: 00

Date: 05.05.16

POWER SECTOR-EASTERN REGION

Page: 40 of 90

- ❖ Stand no higher than the fourth rung from the top for carrying out any job standing on a ladder.
- ❖ Never reach out from a ladder to perform work where your belt buckle protrude past the ladder rung.
- ❖ Always face the ladder while climbing up or down
- ❖ Maintain three point contact while climbing up or down a ladder i.e. two hands and one foot or two feet and one hand on the ladder at all the times.
- ❖ Avoid climbing up or down a ladder while carrying anything in hands. Lift tools, equipment and materials with a rope.
- ❖ Work from portable and extension ladders near guarrail where fall expouse exist over the guardrail regardless of height, and above 2.0 mtr. heights from the working/walking surface will require the use of personal fall arrest equipment.

18.2 Precautions against the fall of materials and persons and collapse of structures

- ❖ Adequate precautions should be taken such as the provision of fencing, or barriers to protect any person who might be injured by the fall of materials, or tools or equipment being raised or lowered. Cradle may be used for lifting materials - however this shall be made of MS angles and flats only and duly certified by the HSE officer. Operators may also use designed containers for lifting small tools.
- ❖ Guardrails (including scaffolding) erected over/adjacent working areas must have the guardrails screened (opening < 0.5), to prevent material from falling outside the platform/decking.
- ❖ Guardrails must be able to withstand a 200 pound force exerted in any one direction.
- ❖ Where necessary to prevent danger, guys, stays or supports should be used or other effective precautions should be taken to prevent the collapse of structures or parts of structures that are being erected, maintained, repaired, dismantled or demolished.
- ❖ All openings through which workers are liable to fall should be kept effectively covered or fenced and indicated in the most appropriate manner.
- ❖ As far as practicable, guard-rails and toe-boards in accordance with Indian laws and regulations as depicted below:

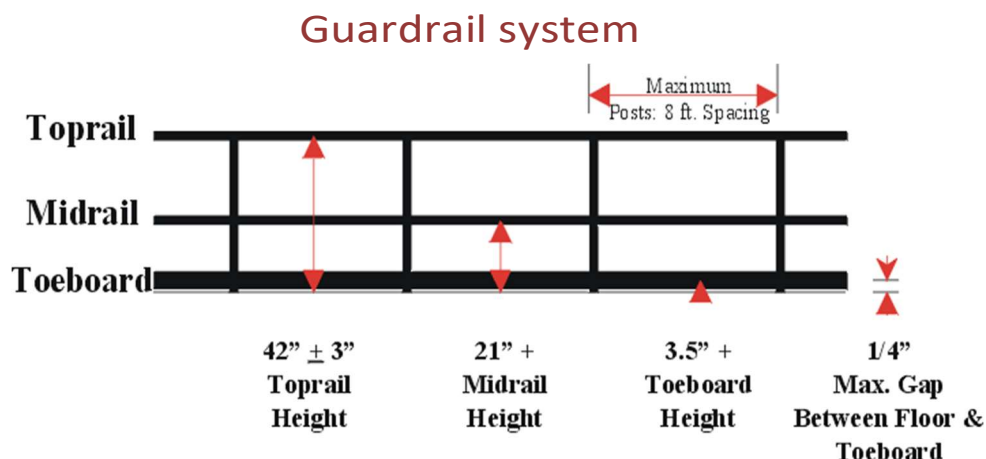



**HEALTH, SAFETY AND ENVIRONMENT
PLAN FOR SITE SUB-CONTRACTORS
(MAITREE PROJECT)**

Doc no.: HSEP: 14-MAITREE:VENDOR

REV: 00

Date: 05.05.16

Page: 41 of 90

POWER SECTOR-EASTERN REGION

- ❖ Guardrails shall be provided to protect workers from falling from elevated work places. The rails are generally made of MS pipes of suitable dia. Rebar shall not be used for any handrails, ladder or cover purpose. Wherever the guard-rails and toe-boards cannot be provided:

- (a) adequate safety nets or safety sheets shall be erected and maintained; or
- (b) adequate safety harnesses shall be provided and used and or
- (c) adequate fall arrestor shall be provided and used.

As mentioned under PPE clause, all these PPEs shall be defect free and regularly inspected for any defect. The full body safety harness shall have double lanyard only with max 1.8m length.

The monkey ladders shall have sufficient fall arrestors. Adequate lifelines of 8mm steel wire rope shall be provided across the work area.

The HSE officer shall recommend appropriate PPEs after analysing hazards and risks involved.

18.3 Safety Nets:

- ❖ All safety net systems shall meet the requirements of Indian Standard (IS: 5175)
- ❖ Safety net mesh openings shall have a maximum size of 6 inches x 6 inches and be secured at each crossing to prevent elongation of the opening. All nets must meet IS: 5175 standard.
- ❖ Safety nets must be installed with sufficient clearance to prevent contact with the surface or structures under them
- ❖ Safety nets shall be installed as close as possible to the working level but in no case more than 25 feet below the working level.
- ❖ The safety nets shall extend out at least 8 ft. from the side of the open edge.
- ❖ Material, equipment and other items that fall into the net are to be promptly removed.
- ❖ Safety nets are to be inspected before use and then daily for wear or damage caused by falling materials.
- ❖ Safety net installation shall be inspected by a competent person.
- ❖ Safety nets must be installed below the working decks of the super structure for protection from falls of personnel and material.
- ❖ Safety nets and safety net installations must be drop-tested at the jobsite:
 - After initial installation and before being used.
 - Whenever relocated.
 - After major repair.
 - At 6-month intervals if left in one place.
- ❖ The drop test consists of a 400 pound bag of sand 28-32 inches in diameter dropped into the net from the highest surface at which employees are exposed to fall hazards, but not from less than than 42 inches above that level.
- ❖ When the employer can demonstrate that it is unreasonable to perform the drop-test described above, the employer or a designated competent person shall certify that the net and net installation have sufficient clearance and impact absorption by preparing a certification record prior to the net being used as a fall protection system. The certification must include:
 - Identification of the net and net installation.
 - Date that it was determined that the net and net installation were in compliance.
 - Signature of the person making the determination and certification.



HEALTH, SAFETY AND ENVIRONMENT PLAN FOR SITE SUB-CONTRACTORS (MAITREE PROJECT)

Doc no.: HSEP: 14-MAITREE:VENDOR

REV: 00

POWER SECTOR-EASTERN REGION

Date: 05.05.16

Page: 42 of 90

19.0 SAFETY IN JETTY CONSTRUCTION:

A jetty is to be constructed close to the power plant site over a river. The construction activity involves deployment of cranes and other lifting appliances – a few may be mounted on vessels.

Prior to taking up job at the identified space, a HIRA shall be prepared and corrective measures shall be prepared by an expert group. This shall be shared with the subcontractor/gang to be deployed for the job through meeting/TBM as well as proper documentations.

- The safety rules as described in clause 12.0 shall be followed for all safety appliances. However, the operators shall be certified specifically for operating the lifting appliances mounted on the vessels by the owner of the vessels or the lifting supervisor of the agency.
- The lifting appliances on vessels shall be fixed and securely anchored
- Lifting appliances/ mobile plant shall be kept away from dangerous locations such as openings, edges close to water.
- The operation zone shall be clearly demarcated and properly fenced off.

19.1 SAFE USE OF LIFE JACKETS AND BUOYANCY AIDS:

- Lifejackets/buoyancy aids should be provided to and worn by workers with risk of falling into water.
- Lifejackets/buoyancy aids should conform to BS EN ISO 12402-1, 2, 3 or 4, or other equivalent international standards according to working conditions
- Lifejackets should be thoroughly checked by the user before each use.



Efficient state:
Green

Maintenance Record



**HEALTH, SAFETY AND ENVIRONMENT
PLAN FOR SITE SUB-CONTRACTORS
(MAITREE PROJECT)**

Doc no.: HSEP: 14-MAITREE:VENDOR

REV: 00

POWER SECTOR-EASTERN REGION

Date: 05.05.16

Page: 43 of 90

- A lifebuoy with sufficient lifeline (not less than 30 meters) shall be provided and the locations of the lifebuoys shall be at less than 50 metre intervals along the edges of places where work is being carried out overside or in exposed position on vessels where there is a reasonably foreseeable risk of falling or being washed overboard. To avoid any delays to rescue operations, lifebuoys shall be tightly tied to the posts.



- The lifejacket/ buoyancy aid shall preferably be provided with a whistle and/ or a self-activating light (for night work) in order to aid locating the wearer and facilitating rescue.
- The lifejackets /buoyancy aids shall be inspected and checked periodically by a competent person.



- The life jackets/ buoyancy aids shall be properly maintained in a good serviceable condition according to the manufacturer's instructions.
- All inflatable life jackets shall be serviced by an authorized person/agent at least once a year.

19.2 WORKING AT HEIGHT

- Suitable guard-rails and toe-boards shall be installed at edges. Openings shall be properly covered where persons are liable to fall from height, to land surfaces or into water.
- Suitable working platforms, with suitable guard-rails and toe-boards, shall be provided for work at height. Safe means of access and egress shall be provided for the working platform.
- Safety harnesses with continuous and effective anchorage system shall be provided when it is impracticable to provide a suitable working platform, access and egress and safe place of work.
- Access and egress shall be sufficiently illuminated and free from any obstructions, openings, projections in order to avoid any slip, trip and fall.

20.0 NIGHT SHIFT OPERATION:

Night shift operation shall be avoided to the extent possible, so shall be any complicated or heavy job. However, prior administrative approval shall be obtained from BHEL for such operation. The following shall be ensured:

- i. Adequate illumination along access, work area and egress



**HEALTH, SAFETY AND ENVIRONMENT
PLAN FOR SITE SUB-CONTRACTORS
(MAITREE PROJECT)**

Doc no.: HSEP: 14-MAITREE:VENDOR

REV: 00

Date: 05.05.16

Page: 44 of 90

POWER SECTOR-EASTERN REGION

- ii. Supervision
- iii. Issue of strict instruction to workmen not to stray away from the work area and earmarked approach
- iv. Non-deployment of women workforce
- v. Non-deployment of fatigued workforce
- vi. Vacating the area immediately on completion of the job
- vii. informing first-aid facility and ambulance in advance

21.0 CONTROL OF MOVEMENTS AND USE OF HAZARDOUS SUBSTANCES AND CHEMICALS:

- ❖ The hazardous substances and chemicals shall be stored in a cool, well ventilated, dry and covered space with restricted entry only
- ❖ The loading, unloading, issue and use of these materials shall be strictly in accordance with the Material Safety Data Sheet (MSDS) and under strict supervision. Every supply shall accompany a MSDS as per standard purchase order clause.
- ❖ The site HSE team shall maintain MSDS of all these items and the same shall be shared with the stores or the user as and when required.
- ❖ Each container shall be labeled.
- ❖ The stores shall check the expiry date of perishable chemicals while receiving and store in such a fashion so as to follow First-in-first-out queue.
- ❖ There shall be enough space for movement of material and people in the stores.
- ❖ Containment shall be provided so as to arrest spillage from spreading.
- ❖ There shall be sufficient fire extinguishers and sand buckets in the stores and at point of use. In case of any spillage, dry sand shall be put on the spill and soaked sand shall be disposed as per the procedure for hazardous waste.
- ❖ There shall be provision of water preferably flowing one and a face shower at stores and point of use
- ❖ The persons handling these items shall strictly wear appropriate PPEs like leather gloves, apron, shield etc

22.0 CHEMICAL CLEANING: The chemicals have to be handled as instructed in MSDS. Only authorized person(s) shall be engaged for this job under strict supervision. The waste chemicals shall be drained out to a suitable storage provision and disposed off as per the relevant procedure. The area shall be barricaded while carrying out cleaning operation so as to prevent any unauthorized entry. Once the operation is completed, the surplus material along with the containers shall be returned to stores or scrap yard, as the case may be. The users shall use all appropriate PPEs and shall have water and sand for handling any incidental spillage or splash etc. The area shall be left completely clean before removing barricades.

22.1 PAINTING

Requirements provide a detailed procedure to be implemented by all concerned employees and sub-contractors involved in painting activities.

Significant Environmental Hazards:

- Chemical hazard due to inhalation of lead fumes (lead containing paint)
- Chemical hazard due to inhalation of VOC's from painting operations
- VOC's from painting and coating operation
- Disposal of paints and coats drums

Control Procedure for Painting:

- Chemical products used in painting and coating operation shall have proper MSDS sheet in place. Whenever any doubt arise with respect to handling and safety point of view it should be accessed to all concerned.
- Toxic substances and hazards relate the toxic chemicals shall be indentified.
- Proper PPE shall be used including plastic gloves appropriate overall etc.,
- Arrangement for cleaning of spillage shall be ensured



**HEALTH, SAFETY AND ENVIRONMENT
PLAN FOR SITE SUB-CONTRACTORS
(MAITREE PROJECT)**

Doc no.: HSEP: 14-MAITREE:VENDOR

REV: 00

Date: 05.05.16

Page: 45 of 90

POWER SECTOR-EASTERN REGION

- In case of nauseating feeling by any one immediate action shall be taken
- Only trained workers shall be allowed and proper training should be imparted to the works.
- Exposure limits of the toxic substances shall be checked before starting the work and nobody shall be allowed to carry the work beyond the permissible limit.
- Ventilation or exhaust facility shall be provided at place where painting and coating operations are carried out.
- Overalls shall be supplied by the contractors/subcontractors to the workmen and adequate facilities shall be provided to enable the painters to wash at the cessation of work.
- Smoking, open flames or sources of ignition shall not be allowed in places where paints and other flammable substances are stored.
- A caution board in national /regional language "smoking strictly prohibited" shall be displayed in the vicinity.
- Suitable fire extinguishers/sand buckets shall be kept available at places where flammable paints are stored, handled or used.
- In case of indoor painting or painting in confined spaces, exhaust ventilating shall be provided. If adequate ventilation is not provided a proper respirator shall be provided and used by persons who are trained and fit tested.
- The VOC's from painting and coating operations shall not exceed the permissible level of CPCB/ SPCB norms. The paints and coats must be selected as per the guidelines.
- Workers shall thoroughly wash their hands and feet before leaving the work.

23.0 SAFETY IN THE USE OF HAND TOOLS AND POWER-OPERATED TOOLS

23.1 General provisions

- i. All hands and power tools and similar equipment, shall be maintained in safe condition.
- ii. When power operated tools are designed to accommodate guards, they shall be equipped
- iii. with such guards, when in use;
- iv. Belts, gears, shafts, pulleys, sprockets, spindles, drums, fly wheels, chains and other reciprocating, rotating or moving parts of the equipment shall be similarly guarded;
- v. Personnel using hand and power tools and exposed to the hazard of falling, flying, abrasive, and splashing objects, or exposed to harmful dusts, fumes, mists, vapours, or gases shall be provided with the particular personal protective equipment necessary to protect them from the hazards;
- vi. All hand-held powered platen sanders, grinders, grinders with wheels of 5 cm or less, routers, planers, laminate trimmers, nibblers, shears, scroll saws and jigsaws with blade shanks of 0.5 cm wide or less shall be equipped with only a positive on-off control.
- vii. All hand-held powered drills, tappers, fastener drivers, horizontal, vertical or angle grinders with wheels greater than 5 cm in diameter, disc sanders, belt sanders, reciprocating saws, saber saws and other operating powered tools shall be equipped with a momentary contact on control provided that turnoff can be accomplished by a single motion of the same finger or fingers that turn it on.

23.2 Hand Tools

- i. The contractor shall not issue or permit the use of unsafe hand tools;
- ii. Wrenches including adjustable pipe end and socket wrenches shall not be used when saws are sprung to the point that slippage occurs;
- iii. Impact tools such as drift pins, wedges and chisels shall be kept free of mushroomed heads;
- iv. The wooden handles of tools shall be kept free of splinters or cracks and shall be kept tight on the tools.

23.3 Power operated tools

- i. Electric power operated tools shall be either of the approved double-insulated type or shall be grounded;
- ii. The use of electric cords for hoisting or lowering loads shall not be permitted;



**HEALTH, SAFETY AND ENVIRONMENT
PLAN FOR SITE SUB-CONTRACTORS
(MAITREE PROJECT)**

Doc no.: HSEP: 14-MAITREE:VENDOR

REV: 00

Date: 05.05.16

Page: 46 of 90

POWER SECTOR-EASTERN REGION

- iii. Pneumatic power tools shall be secured to the hose or whip by some positive means to prevent the tool from becoming incidentally disconnected;
- iv. Safety clips or retainers shall be securely installed or maintained on pneumatic impact (percussion) tools to prevent attachments from being incidentally expelled;
- v. All pneumatically riveting machine staplers and other similar equipment provided with automatic fastener feed, which operate at more than 7 kg/cm² pressure at the tool a safety device on the muzzle to prevent the tool from ejecting the fasteners unless the muzzle is in contact with the work surface;
- vi. Compressed air shall not be used for cleaning purposes except when the pressure is reduced to less than 2 kg/cm² and that too with effective chip guarding. The 2 kg/cm² pressure requirement does not apply to concrete form, mill scale and similar cleaning purposes;
- vii. The manufacturer's safe operating for hoses, pipes, valves, filters and other fittings shall not be exceeded;
- viii. Only personnel who has been trained in the operation of the particular tool shall be allowed to operate power-actuated tools;
- ix. The tool shall be tested each day before loading to see that the safety devices are in proper working condition. The method of testing shall be accordance with the manufacturer's recommended procedure;
- x. Any tool found not in proper working order, or that which develops a defect during use, shall be immediately removed from service and not used until properly repaired;
- xi. Tools shall not be loaded until just prior to the intended firing time. Neither loaded nor empty tools are to be pointed at any other person. Hands shall be kept clear of the open barrel end;
- xii. Loaded tools shall not be left unattended;
- xiii. Fasteners shall not be driven into very hard or brittle materials including, but not limited to, cast iron, glazed tiles, surface hardened steel, glass block, live rock, face brick or hollow tiles;
- xiv. Driving into materials that can be easily penetrated shall be avoided unless backed by a
- xv. substance that will prevent the pin or fastener from passing completely through and creating a flying missile hazard on the other side;
- xvi. No fastener shall be driven into a palled area caused by an unsatisfactory fastening;
- xvii. Only non-sparking tools shall be used in an explosive or flammable atmosphere;
- xviii. All tools shall be used with the correct shield, guard or attachment as recommended by thee manufacturer.

23.4 Abrasive wheels and tools

- i. All grinding machines shall be supplied with sufficient power to maintain the spindle speed at safe levels under all conditions of normal operation;
- ii. Grinding machines shall be equipped with suitable safety guards;
- iii. The maximum angular exposure of the grinding wheel periphery and sides shall not be more than 90°, except that when the work requires contact with the wheel below the horizontal plane of the spindle, the angular exposure shall not exceed 120°. In either case, the exposure shall begin not more than 8.650 above the horizontal plane of the spindle. Safety guards shall be strong enough to withstand the bursting of the wheel;
- iv. Floor and bench-mounted grinders shall be work-rests, which shall be rigidly supported and readily adjustable. Such work-rests shall be kept at a distance not to exceed 5 mm from the surface of the wheel;
- v. Cup type wheels used for external grinding shall be protected by either revolving cup guard or a band type guard;
- vi. When safety guards are required, they shall be mounted as to maintain proper alignment with the wheel and the guard and the guard and its fastening shall be adequate strength to retain the fragments of the wheel in case of incidental breakage. The maximum angular exposure of the grinding wheel periphery and sides shall not exceed 180°;
- vii. Portable abrasive wheel used for internal grinding shall be provided with suitable safety flanges;
- viii. When safety flanges are required, they shall be used only with wheels designed to fit the
- ix. flanges. Only safety flanges, of a type and design and properly assembled so as to ensure that the pieces of the wheel will be retained in case of incidental breakage, shall be used;



**HEALTH, SAFETY AND ENVIRONMENT
PLAN FOR SITE SUB-CONTRACTORS
(MAITREE PROJECT)**

Doc no.: HSEP: 14-MAITREE:VENDOR

REV: 00

Date: 05.05.16

Page: 47 of 90

POWER SECTOR-EASTERN REGION

- x. All abrasive wheels shall be closely inspected and ring tested before mounting to ensure that they are free from cracks or defects;
- xi. Grinding wheels shall fit freely on the spindle and shall not be forced on. The spindle nut shall be tightened only enough to hold the wheel in place;
- xii. All employees using abrasive wheels shall be protected by suitable eye protection equipment.

23.5 Woodworking tools

- i. All fixed power driven woodworking tools shall be provided with a disconnect switch that can either be locked or tagged in the **off-position**;
- ii. The operating speed shall be attached or otherwise permanently marked on all circular saws over 0.5 m in diameter or operating at over 3000 peripheral rpm. Any saw so marked shall not be operated at a speed other than that marked on the blade. When a marked saw is retensioned for a different speed, the marking shall be corrected to show the new speed;
- iii. Automatic feeding devices shall be installed on machines wherever the nature of the work will permit. Feeder attachments shall have the feed rolls or other moving parts covered or guarded so as to protect the operator from hazardous points;
- iv. All portable power driven circular saws shall be equipped with guards above and below the base plate or shoe. The upper guard shall cover the saw to the depth of the teeth, except for the minimum arc required to permit the base to be tilted for bevel cuts. The lower guard shall cover the saw to the depth of the teeth, except for the minimum arc required to allow proper retraction and contact with the work. When the tool is withdrawn from the work, the lower guard shall automatically and instantly return to the covering position.

23.6 Defective tools to be tagged out for maintenance, as **DEFECTIVE, DO NOT USE**, and sent to tool/store room for repair or to be discarded.

24.0 START UP, COMMISSIONING AND TESTING:

There are various activities involved prior to commissioning- the major ones are -Hydraulic Test, Steam Blowing, Charging of transformers, Boiler Light Up, Rolling and Synchronisation and Full loading of unit.

These activities shall be personally supervised by the site executive along with the commissioning engineer. The readiness of upstream and downstream system shall be ensured before taking up. These shall be handled strictly by the authorised persons only and the team shall be suitably briefed about the activity including hazards & risks involved and control plan by the concerned executive-in-charge before start. Entry of persons to the area of activity shall be suitably restricted and the emergency functions like Ambulance, first aid centre and Fire station shall be intimated about the plan well in advance. Tag-in/ Tag-out shall be in place while charging transformer and whenever necessary. Electricians with valid wiremen license only shall be permitted to work on power lines. The area and the passage shall be adequately illuminated.

25.0 DEMOLITION WORK

Before any demolition work is commenced and also during the process of the work the following shall be ensured:

- All roads and open areas adjacent to the work site shall either be closed or suitably protected.
- No electric cable or apparatus which is liable to be a source of danger nor a cable or an apparatus used by the operator shall remain electrically charged.
- All practical steps shall be taken to prevent danger to persons employed from the risks of fire or explosion or flooding. No floor, roof or other part of the building shall be so overloaded with debris or materials as to render them unsafe.



**HEALTH, SAFETY AND ENVIRONMENT
PLAN FOR SITE SUB-CONTRACTORS
(MAITREE PROJECT)**

Doc no.: HSEP: 14-MAITREE:VENDOR

REV: 00

Date: 05.05.16

Page: 48 of 90

POWER SECTOR-EASTERN REGION

26.0 EXCAVATION

Wherever there is open excavation in ground, they shall be fenced off by suitable railing and danger signals installed at night so as to prevent persons slipping into the excavations. All safety precautions shall be taken for foundation and other excavation marks as per IS-3764. Any excavation above 2m shall be considered as hazardous job.

27.0 ENVIRONMENTAL CONTROL

Environment protection has always been given prime importance by BHEL. Environmental damage is a major concern of the principal contractor and every effort shall be made, to have effective control measures in place to avoid pollution of Air, Water and Land and associated life. Chlorofluorocarbons such as carbon tetrachloride and trichloroethylene shall not be used. Waste disposal shall be done in accordance with the guidelines laid down in the project specification.

Any chemical including solvents and paints, required for construction shall be stored in designated bonded areas around the site as per MSDS.

In the event of any spillage, the principle is to recover as much material as possible before it enters drainage system and to take all possible action to prevent spilled materials from running off the site. BHEL shall use appropriate MSDS for clean-up technique

All contractors shall be responsible for the cleanliness of their own areas and must not pollute the ground, air and water.

BHEL shall ensure that noise levels generated by plant or machinery are as low as reasonably practicable. Where the contractor anticipates the generation of excessive noise levels from his operations the contractor shall inform to Construction manager of BHEL accordingly so that reasonable & practicable precautions can be taken to protect other persons who may be affected.

27.1 Water Supply and Wastewater Discharge Requirement

- Source of water is provided by client from the existing system.
- Wastage of water to be controlled by monitoring the required water for construction & domestic use and actual consumed.
- No contaminated water to be discharged in the storm water drain confirming the standard parameters before discharge. Proper approval to be taken if applicable as per [Bangladesh Environmental Standards](#)

27.2 Storm water runoff Management

- Expansion of existing plant, no existing drainage systems will be disturbed and damaged.
- No construction waste water to be discharged in the existing storm water drain or newly construction storm water drains.

27.3 Noise Mitigation

High noise is harmful to the human health and it can cause impairment if exposed for long duration at regular intervals, and also cause disruption in nearby communities.

- Noise monitoring shall be carried out in all construction locations periodically.
- Use of silent DG is allowed at site during construction.
- Low noise generation equipment's to be preferred
- Acoustic enclosure to be used in case noise level is high for particular equipment or system.
- Work areas where noise levels exceed the 85db shall be posted as hearing protection required.
- Use of PPEs / ear plug/ear muff for personnel entering into high noise area.
- Activities generation High noise will be planned in day shift.



**HEALTH, SAFETY AND ENVIRONMENT
PLAN FOR SITE SUB-CONTRACTORS
(MAITREE PROJECT)**

Doc no.: HSEP: 14-MAITREE:VENDOR

REV: 00

POWER SECTOR-EASTERN REGION

Date: 05.05.16

Page: 49 of 90

Noise Level Chart (As per Bangladesh Environmental Standards)

Parameter	Night Noise level dBA	Daytime Noise Level dBA
At 1-meter from each piece of equipment	85	85
At Property boundary	70	70

27.4 Air pollution Control

- Water sprinkling on road for suppression of fugitive dust to be done regularly.
- Startup and commissioning activities to be planned for compliance with contract, regulatory and permit requirements..(As per Bangladesh Environmental Standards)
- Required monitoring to be done in the respective work location as applicable.

27.5 Land and Water Resource Protection

- Only prior approved land by CUSTOMERL to be used during construction work.
- Contract clauses to be followed
- All hazardous substances will be stored with proper containment facilities to avoid any release into the water system, causing land/water contamination.

28.0 HOUSEKEEPING

- Keeping the work area clean/ free from debris, removed scaffoldings, scraps, insulation/sheeting wastage /cut pieces, temporary structures, packing woods etc. will be in the scope of the subcontractor. Such cleanings has to be done by subcontractor within quoted rate, on daily basis by an identified group. If such activity is not carried out by subcontractor / BHEL is not satisfied, then BHEL may get it done by other agency and actual cost along with BHEL overheads will be deducted from contractor's bill. Such decisions of BHEL shall be binding on the subcontractor
- Proper housekeeping to be maintained at work place and the following are to be taken care of on daily basis:
 - ❖ All surplus earth and debris are removed/disposed off from the working areas to identified locations.
 - ❖ Unused/Surplus cables, steel items and steel scrap lying scattered at different places/elevation within the working areas are removed to identified locations.
 - ❖ All wooden scrap, empty wooden cable drums and other combustible packing materials, shall be removed from workplace to identified locations. Sufficient waste bins shall be provided at
 - ❖ Different work places for easy collection of scrap/waste. Scrap chute shall be installed to remove scrap from high location.
 - ❖ Access and egress (stair case, gangways, ladders etc.) path should be free from all scrap and other hindrances.
 - ❖ Workmen shall be educated through tool box talk about the importance of housekeeping and encourage not to litter.
 - ❖ Labour camp area shall be kept clear and materials like pipes, steel, sand, concrete, chips and bricks, etc. shall not be allowed in the camp to obstruct free movement of men and machineries.
 - ❖ Fabricated steel structures, pipes & piping materials shall be stacked properly.
 - ❖ No parking of trucks/trolleys, cranes and trailers etc. shall be allowed in the camp, which may obstruct the traffic movement as well as below LT/HT power line.
 - ❖ Utmost care shall be taken to ensure over all cleanliness and proper upkeep of the working areas
 - ❖ The paint and thinner and other chemical containers (filled, partly used and empty) shall be carefully stored, used and tracked. All empty containers shall be removed after getting punctured/lid removed and deformed to the scrap yard. The partial used one shall either be returned to store or carefully kept at a corner much away from any hot work or source of fire.



**HEALTH, SAFETY AND ENVIRONMENT
PLAN FOR SITE SUB-CONTRACTORS
(MAITREE PROJECT)**

Doc no.: HSEP: 14-MAITREE:VENDOR

REV: 00

Date: 05.05.16

Page: 50 of 90

POWER SECTOR-EASTERN REGION

29.0 WASTE MANAGEMENT

There are operations on construction projects that may create hazardous waste, which would require handling, storage, transferring, and transporting. Therefore, hazardous waste guidelines apply for Hazardous Waste Planning:

29.1 Minimum Requirements:

- Contractors must designate a Material Manager who is responsible for checking delivered materials as potential hazardous waste and informing the Contractor's Safety Manager.
- Contractors who create, may be expected to create or could accidentally create a material that could be classified to be hazardous waste must provide Disposal number (or equivalent) and other pertinent information on file.
- All hazardous waste or waste which could be considered hazardous waste, as determined by the methodology and definitions from environmental regulators must be stored and collected in special areas and properly disposed of by the Contractor.
- No waste haulers, disposers, recyclers, or scavengers will be allowed on the site without the permission of the owner. It will be the responsibility of the Contractor to provide copies of all licenses, permits, and authorizations to the.
- No waste may be removed from the site by any person without the authorization of the Contractor. No waste may be brought onto the site and disposed of using the Contractor's systems or facilities.
- Burning of waste, if not used for generating energy, shall be generally prohibited

29.2 General Requirements

- For non-hazardous waste disposal. Receptacles e.g., dumpsters, etc. must be placed around the site for collection of waste materials. No material is to be abandoned on the site.
- Dumpsters will be inspected frequently, and any potentially hazardous material or waste will be removed from the dumpster and placed in the appropriate storage area at the expense of the responsible Contractor.

29.3 Definitions

- Solid Waste - Any garbage, refuse, sludge, or any other waste material which is not an "excluded waste."
 - The following solid wastes are not hazardous wastes unless otherwise designated as such by local authorities:
 - Fly ash waste, bottom ash waste, slag waste, and flue gas emission control waste generated primarily from the combustion of coal or other fossil fuels
 - Drilling fluids, produced waters, and other wastes associated with the exploration, development, or production of crude oil, natural gas, or geothermal energy.
- Other Waste Material - Any solid, liquid, semi-solid, or contained gaseous material, resulting from industrial, commercial, mining or agricultural operations which are discarded. This is usually an incidental by-product of the operation. Discarded material must be treated as follows:
 - Disposed of, and not used, reused, reclaimed, or recycled
 - Burned or incinerated, except where the material is being burned as a fuel for the purpose of recovering usable energy
 - Physically, chemically, or biologically treated (other than burned or incinerated) in lieu of or prior to being disposed of.



**HEALTH, SAFETY AND ENVIRONMENT
PLAN FOR SITE SUB-CONTRACTORS
(MAITREE PROJECT)**

Doc no.: HSEP: 14-MAITREE:VENDOR

REV: 00

POWER SECTOR-EASTERN REGION

Date: 05.05.16

Page: 51 of 90

- Excluded Waste - Materials that are not solid wastes. The following materials are not solid wastes for the purpose of this part:
 - Domestic sewage (“Domestic sewage” means untreated sanitary wastes that pass through a sewer system.)
 - Any mixture of domestic sewage and other wastes that passes through a sewer system to a publicly-owned treatment works for treatment
 - Industrial wastewater discharges that are point source discharges.

29.4 Treatment - Any method, technique, or process, including neutralization, designed to change the physical, chemical, or biological character or composition of any hazardous waste to neutralize such waste, to recover energy or material resources from the waste, or to render such waste non-hazardous.

29.5 Improper Disposal - The discharge, deposit, injection, dumping, spilling, leaking, or placing of any solid waste or hazardous waste into the environment.

29.6 Temporary Storage - The holding of a hazardous waste for a period less than 90 days, at the end of which the hazardous waste is properly disposed of.

29.7 BINS AT WORK PLACE

- Sufficient rubbish bins shall be provided close to workplaces.
- Bins should be painted yellow and numbered.
- Sufficient nos. of drip trays shall be provided to collect oil and grease.
- Sufficient qty. of broomsticks with handle shall be provided.
- Adequate strength of employees should be deployed to ensure daily monitoring and service for waste management.

29.8 STORAGE AND COLLECTION

- Different types of rubbish/waste should be collected and stored separately.
- Paper, oily rags, smoking material, flammable, metal pieces should be collected in separate bins with close fitting lids.
- Rubbish should not be left or allowed to accumulate on construction and other work places.
- Do not burn construction rubbish near working site.

29.9 SEGREGATION

- Earmark the scrap area for different types of waste.
- Store wastes away from building.
- Oil spill absorbed by non-combustible absorbent should be kept in separate bin.
- Clinical and first aid waste stored and incinerated separately.

29.10 DISPOSAL

- Sufficient containers and scrap disposal area should be allocated.
- All scrap bin and containers should be conveniently located.



**HEALTH, SAFETY AND ENVIRONMENT
PLAN FOR SITE SUB-CONTRACTORS
(MAITREE PROJECT)**

Doc no.: HSEP: 14-MAITREE:VENDOR

REV: 00

POWER SECTOR-EASTERN REGION

Date: 05.05.16

Page: 52 of 90

- Provide self-closing containers for flammable/spontaneously combustible material.
- Keep drainage channels free from choking.
- Make schedule for collection and disposal of waste.

29.11 WARNING AND SIGNS

- Appropriate sign to be displayed at scrap storage area
- No toxic, corrosive or flammable substance to be discarded into public sewage system.
- Waste disposal shall be in accordance with best practice.
- Comply with all the requirements of Pollution Control Board (PCB) for storage and disposal of hazardous waste.

30.0 WORK VEHICLES (Limited to contractual provision)

Work vehicle shall be as safe stable efficient and roadworthy as private vehicles on public roads. Site management shall ensure that drivers are minimum 18 years of age, physically fit, suitably qualified and trained for the equipment they are operating. All vehicle e.g. heavy motor vehicle forklift trucks dump trucks mobile cranes shall ensure that the work equipment conforms to the following:

- A high level of stability.
- Equipped with backup alarms.
- A safe means of access/egress.
- Suitable and effective service and parking brakes.
- Windscreens with wipers and external mirrors giving optimum all round visibility.
- Provision of horn, vehicle lights, reflectors, reversing lights, reversing alarms.
- Provision of seat belts.
- Guards on dangerous parts.
- Driver protection - to prevent injury from overturning and from falling objects/materials.
- Driver protection from adverse weather.
- No vehicle shall be parked below HT/LT power lines.
- Valid Pollution Under Control certification for all vehicles

30.1 TRANSPORTATION OF PERSONNEL AND MATERIALS BY VEHICLES

- All drivers shall hold a valid driving License for the class of vehicle to be driven and be registered as an authorized BHEL driver with the Administration Department.
 - Securing of the load shall be by established and approved methods, i.e. chains with patented tightening equipment for steel/heavy loads. Sharp corners on loads shall be avoided when employing ropes for securing.
 - All overhangs shall be made clearly visible and restricted to acceptable limits
 - Load shall be checked before moving off and after traveling a suitable distance.
 - On no account is construction site to be blocked by parked vehicles Drivers of vehicles shall only stop or park in the areas designate by the stringing foreman.
 - Warning signs shall be displayed during transportation of material.
- All vehicles used by BHEL shall be in worthy condition and in conformance to the Land Transport requirement

31.0 EMERGENCY PREPAREDNESS AND RESPONSE Preferably to be maintained jointly by all stake-holders in the project) (A separate document titled "Emergency Preparedness and Response Plan bearing document no HSEP:EPRP:MAITREE is to be read along with this plan)Emergency preparedness and response plan requirements are to protect worker life and health, and to safeguard property used and stored on the project. This plan



**HEALTH, SAFETY AND ENVIRONMENT
PLAN FOR SITE SUB-CONTRACTORS
(MAITREE PROJECT)**

Doc no.: HSEP: 14-MAITREE:VENDOR

REV: 00

Date: 05.05.16

Page: **53** of **90**

POWER SECTOR-EASTERN REGION

is prepared in anticipation of an emergency to prevent losses to any Incident. This plan describes how the organization identifies, respond to and review emergency situations.

This plan covers fire, medical and other environmental incidents. It aims at controlling the emergency and generally mitigating the adverse effects of a major Incident. This plan is applicable to all activities carried at all BHEL project sites. Determination of hazard potential and identification and assessment of hazards is the first part in emergency planning. This requires systematic study of the site / plant to identify emergencies that can occur.

31.1 Definition:

A major emergency can be defined as an Incident that has potential to cause serious injury or loss of life. It may cause extensive property damage and adversely affect the environment as a whole.

31.2 Emergency scenarios and General Guidelines:

Various scenarios that are anticipated to cause emergency at BGRESL site are discussed in brief along with guidelines.

- **Personal injuries:**

In spite of putting best efforts some technical failure or human error may lead to personal injury at site. Guidelines are given below when personnel injuries happen:

- Contact medical center over phone/cell/radio;
- Contact security control room over phone/cell/radio;
- Contact HR/Admin department over phone/cell/radio;
- Tell your location nature of injury or near miss incident;
- Inform site safety department;
- Provide First Aid treatment if properly trained person is available, otherwise take the injured person to Medical center if practical; or
- Stay with the injured person until medical assistant arrives.

- **In case of fire:**

- Shout "fire fire";
- Inform the persons nearby. Contact Fire Center and give your location and other details as warranted and act very calmly and swiftly. Then contact security and safety department once in a safe location;
- Try to put out the fire by using available portable fire extinguisher if trained and fire is in incipient stage only, otherwise let firefighting personnel tend to it;
- Do not make any attempt to collect your belonging;
- Get out and away from the area immediately and walk do not run. Follow shortest escape route and assemble at assembly point; and
- Under no circumstance put your precious life at risk.

- Mishaps involving failures of crane, structures, equipment and vehicular incidents, etc., can also lead to an Emergency situation on construction sites. Guidelines for actions to be taken in case of such situations are as:

- Inform immediate authority and also inform security and safety departments.
- Try to assist in rescue personnel involved only if safe to do so;
- Cordon off the area to prevent entry of personnel in affected area;
- Security shall ensure movement in affected area in coordination with Section/Site In-charge.



**HEALTH, SAFETY AND ENVIRONMENT
PLAN FOR SITE SUB-CONTRACTORS
(MAITREE PROJECT)**

Doc no.: HSEP: 14-MAITREE:VENDOR

REV: 00

POWER SECTOR-EASTERN REGION

Date: 05.05.16

Page: 54 of 90

- Fire/Security service departments responding to affected area to contain and control the situation;
- All other personnel not involved in mitigation operation shall be directed to assembly point; and
- Contractor/ sub-contractor management shall ensure that their workmen are away from emergency site, not gathering around location of emergency.

- Toxic leakage from nearby live units can also lead to emergency situation at construction site. Guidelines for actions to be taken are as:
 - Inform immediate authority and also inform security and safety departments;
 - Evacuate all the personnel from the area immediately depending upon the wind direction to safest assembly point;
 - Call for help from fire and medical by phone/Cell/radio;
 - Arrange transport for any victims to medical Centre; and
 - Do not panic, act swiftly, do not run and proceed as per advice of emergency services.

- Bomb threat, sabotage, riot etc., also may lead to emergency situation at construction site. Such situation shall be dealt by HR/Admin and security department with the advice of Site In-charge.
 - Notification to the owner and authorizes to follow immediately.

- Natural calamities like earthquake, cyclone, and flood like situation can also lead to emergency situation at construction site. Site In-charge will act with required diligent and directive received from Concerned State Government, Corporate office and Owner.

- High Angle rescue -
 - First arrival. The first arriving HSE Officer should assume command after arriving on the scene;
 - HSE Officer should secure a witness as soon as possible after arriving on scene. This will help in identifying the problem and locating the victim;
 - Locate the victim to determine nature of injuries if any and report to Medical for response as needed.
 - Administer first aid to the victim as necessary;
 - Rescue team to use proper rescue kit / equipment to reach the victim;
 - Personnel manbasket or arial lift may be used to reach the vitim if applicable;
 - Assess the hazards. HSE Officer to identify all potential hazards and assist rescuers.
 - The HSE Officer will be responsible for securing those hazards or making all members aware of those hazards.
 - HSE Officer shall be made aware of the specific emergency action plans once the emergency response team arrives.
 - The HSE Officer shall also be responsible for assuring that all safety procedures are adhered to.

31.3 Communication system

An important key to effective emergency response is an effective communication system. At BHEL, site telephone, mobile and radios will be used for communication during emergency.

- Whosoever is observing any emergency shall inform about emergency to:
 - HR/Admin department
 - HSE-Head /Officers /
 - Medical and Security department
 - Fire department,



**HEALTH, SAFETY AND ENVIRONMENT
PLAN FOR SITE SUB-CONTRACTORS
(MAITREE PROJECT)**

Doc no.: HSEP: 14-MAITREE:VENDOR

REV: 00

POWER SECTOR-EASTERN REGION

Date: 05.05.16

Page: 55 of 90

- BHEL Site/Section In-charge

- BHEL Section In-charge will confirm the information emergency services and also inform the Regional Manager as well as sub-contractors Site In-charge.

31.4 Communication matrix shall be as:

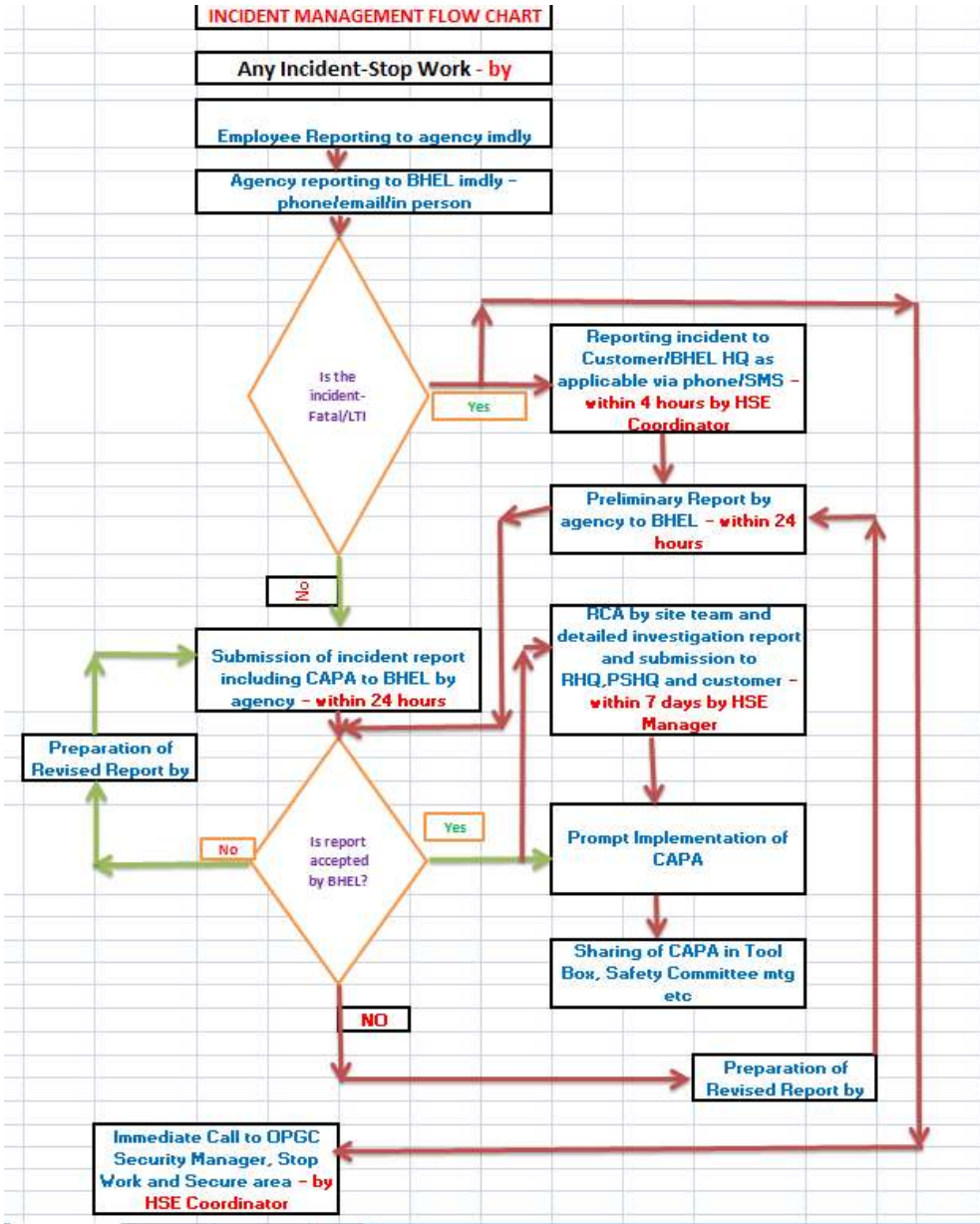



**HEALTH, SAFETY AND ENVIRONMENT
PLAN FOR SITE SUB-CONTRACTORS
(MAITREE PROJECT)**

Doc no.: HSEP: 14-MAITREE:VENDOR

REV: 00

POWER SECTOR-EASTERN REGION

Date: 05.05.16

Page: 56 of 90

31.5 Emergency Organization -

An emergency organization establishment is based on nature of emergency at BHEL site. The matrix for the Emergency Management Team showing the reporting of various key members is as:

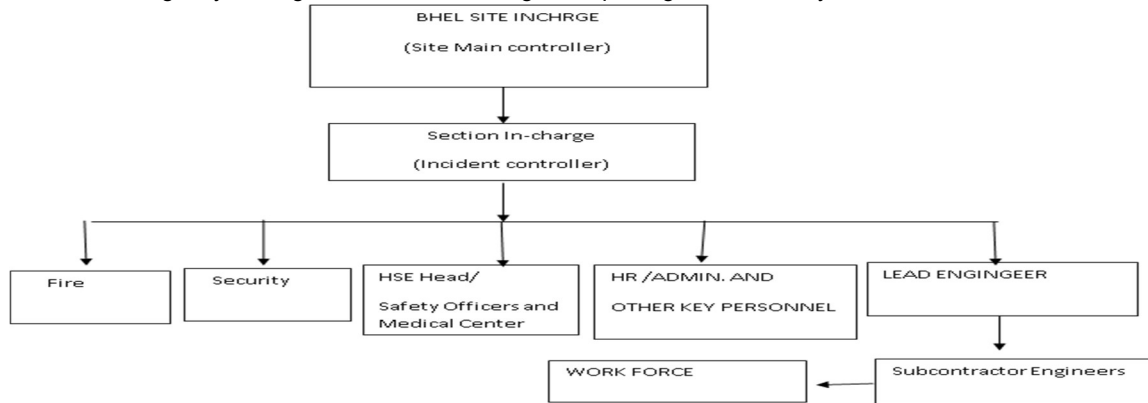

31.6 List of Key Personnel -

Sl. No.	Name	Designation	Telephone Number	Mobile number

31.7 Emergency Control Center -

For the coordination with emergency situations at BHEL site Site In-charge office shall operate as an Emergency Control Room. Site Main Controller (Site In-charge) will coordinate from this Emergency Control Room. Control Room shall be equipped with all necessary communication devises necessary to manage particular emergencies.

31.8 Emergency Drills -

The site HSE Manager and Emergency and Rescue Teams must participate in regular emergency drills of various types. The intervals between such drills must not exceed three months. The records of the drills must be prepared and kept on site for review by the Owner and site Management. The records must be reviewed during regularly scheduled project HSE Committee meetings.

- After each drill, a formal, documented debriefing must be conducted to discuss areas of improvement and an Action Plan developed with Responsible Person and Anticipated Completion Dates describing improvements to be implemented.



**HEALTH, SAFETY AND ENVIRONMENT
PLAN FOR SITE SUB-CONTRACTORS
(MAITREE PROJECT)**

Doc no.: HSEP: 14-MAITREE:VENDOR

REV: 00

Date: 05.05.16

Page: 57 of 90

POWER SECTOR-EASTERN REGION

31.9 Roles & Responsibility -

Responsibility of Site In-charge (Site Main Controller):

- Immediately on receiving message regarding emergency will proceed to their cabin and fill their role as Main Controller and activate the Emergency Control Room and Emergency Management Team.
- Take strategic and technical decisions in line with the incident scenario to mitigate the cause of emergency.
- Provide leadership and guidance to the Emergency Management Team.
- As soon an emergency call is received they shall inform respective Section In-charge.
- Call for available resources Fire, Medical, Security as needed based on emergency situation.
- Stay in contact with Section In-charge for coordination efforts of resources and evacuation of personnel.
- Ensure head count is conducted and received.
- Notify Owner representative of situation and plan.

Responsibility of Section In-charge (Area Controller):

- If not at the location, once notified of an emergency will proceed to the area and act as an incident controller if safe or as appropriate based on the nature of emergency.
- Will be overall in-charge of the area situation in consultation with emergency responding offices and mobilized resources in coordination with Main Controller.
- Will assess the situation and take necessary action to control the emergency and give necessary instruction to site personnel as necessary and appropriate.
- Will evaluate if fire emergency and attempt to extinguish if safe and in incipient stage and assist injured as applicable.
- Shall instruct the sub-contractors and ensure that all non-essential employees are moved to safe assembly point and organize head count.
- Ensure safe exvacuation of site personnel to safe assembly point in coordination with Main Controller.
- Shall keep in contact with Main Controller keep them informed about site situation and seek directives for mitigation of emergency.
- Communicate with shift Fire Officer of fire condition and rescue measures.
- Communicate with shift Security Officer assist in barricading the affected area.
- Communicate with shift Medical for transporting of casualties, if any.

Fire officer /shift Fire in charge:

- Respond to the emergency call with fire crew in first turn out. Report to Incident controller at site of emergency.
- Decide line of control action in consultation with Section In-charge/Incident Controller for firefighting and other control actions including evacuation of trapped personnel.
- Deploy auxiliary fire squad for assisting fire crew.
- Ensure safety of the crew members
- Keep in constant contact with Emergency Control Room and Team.

Security officer / In charge:



**HEALTH, SAFETY AND ENVIRONMENT
PLAN FOR SITE SUB-CONTRACTORS
(MAITREE PROJECT)**

Doc no.: HSEP: 14-MAITREE:VENDOR

REV: 00

Date: 05.05.16

Page: **58 of 90**

POWER SECTOR-EASTERN REGION

- Instruct and deploy security personnel at security posts/gates and around the affected area.
- Communicate with the auxiliary fire squad at emergency site immediately on receiving emergency call to ensure their mobilization.
- Cordon off the affected area and guide traffic /emergency vehicles and manage crowd control by dispersing unnecessary persons from the area.
- Ensure vigilance at security posts /gates and be in contact with area manager and other members connected with firefighting or rescue operation.
- Mobilize for evacuation of personnel to safe locations/assemble point.

Medical Center:

- Upon receiving notification of an emergency, anticipate the casualties and prepare accordingly as per medical response plan. Inform Medical Staff and nearest Hospital in advance.
- Dispatch ambulance to incident site along with necessary staff.
- Provide medical treatment/first aid as necessary.

HR/Admin and HSE Teams:

- Coordinate with Main Controller and all other Emergency Management Team members and Government agencies as per requirement.
- Identify appropriate Assembly Points at project site, provide directions and marked areas clearly.
- Assist with arrangement of necessary PPE and use of.
- Support the Emergency Management Team as directed and/or necessary based on situation.

31.10 General Requirements:

- Emergency preparedness and response capability of site shall be developed as per Emergency Preparedness and Response plan issued by Regional HQ
- Availability of adequate number of first aiders and fire warden shall be ensured with BHEL and its sub-contractors
- Assembly point shall be earmarked and access to the same from different location shall be shown in consultation with the owner
- Fire exit shall be identified and pathway shall be clear for emergency escape.
- Appropriate type and number of fire extinguisher shall be deployed as per Fire extinguisher deployment plan and validity shall be ensured periodically through inspection
- Adequate number of first aid boxes shall be strategically placed at different work places to cater emergency need. Holder of the first aid box shall be identified on the box itself who will have the responsibility to maintain the same.
- First aid center shall be developed at site with trained medical personnel and ambulance
- Emergency contact numbers (format given in EPRP) of the site shall be displayed at prominent locations.
- Tie up with fire brigade shall be done in case customer is not having fire station.
- Tie up with hospital shall be done in case customer is not having hospital.
- Emergency Organization group shall be formed at site.
- Mock drill shall be conducted on different emergencies periodically (every three months) to find out gaps in emergency preparedness and taking necessary corrective action



**HEALTH, SAFETY AND ENVIRONMENT
PLAN FOR SITE SUB-CONTRACTORS
(MAITREE PROJECT)**

Doc no.: HSEP: 14-MAITREE:VENDOR

REV: 00

POWER SECTOR-EASTERN REGION

Date: 05.05.16

Page: 59 of 90

31.11 WEATHER SEVERITY PLAN

A. OBJECTIVE AND SCOPE:

considering the over all monsoon and wind speed in the area the emergencies like cyclone and flood shall be considered from safety point of view during project work.

Warning/alerts issued by Bangladesh Meteorological department shall be acted upon by appropriate measures. These alerts are mostly conveyed to District Administration which in turn passes on to the owner of the project i.e. BIFPCL in this case. BIFPCL shall convey such alert to contractors. and coordinate appropriate response. Such alert is transmitted over Radio and TV channels also. However, contractors shall also remain alert to w3eather conditions and share with BHEL and fellow contractors any input received. Contractors shall actively participate in the Emergency Response activities

This safety plan provides procedure to be followed during emergency due to flood and cyclone for the period of entire project work with respect:

- To give clear guidance as to the actions that must be implemented.
- To inform employees what to do in an Emergency Scenario.
- To establish an emergency response and communications procedure.

B. RESPONSIBILITIES

RCM or his assignee shall coordinate with various departments in charge and supervisors, who will execute the alert procedures in their assigned areas. The coordination shall be in line with directives received from the Client/consultants.

C. CYCLONE

In the event of CYCLONE, alert warning is in three parts. The alert will be issued by BHEL Site Manager.

The actions required during cyclone/Rough Weather:

- Check and assist subcontractors in cleanup. Pick up all loose and unused material of respective supervisor's area
- Check tie-down arrangement is proper for all temporary structure, cranes and tall objects etc.
- Tie to secure all gas cylinders to avoid displacement and unsafe conditions which could be due to wind pressure.
- Secure portable electricity generating sets and other equipments, pumps, hoses etc.
- Make preparation for removal of water logging.
- Take review of work activity and make preparation for removal of equipments and material from all areas.
- Isolate/Turn off all electrical power from the main panel/switches. Secure and anchor panels properly.
- Recheck anchorage/tie of all temporary structures/sheds, tall objects, cranes, rigs, scaffolds etc to avoid toppling due to wind force.
- Cranes boom shall be either locked or lowered the booms as reasonably & practicably and rigs to safe position for the safety point of view.
- Group up all trash barrels, wooden pallets, forms; wooden decks etc. and anchor properly.
- Welding machines, air compressors, and such equipments are to be grouped together and secured to the stable objects. Welding leads, electrical cables, hoses are to be rolled up and secured properly.
- Set on site vehicles on high ground in the site area with brakes set firmly.
- Anchor all tanks, vessels, gas cylinders that may be moved by high wind and water.



**HEALTH, SAFETY AND ENVIRONMENT
PLAN FOR SITE SUB-CONTRACTORS
(MAITREE PROJECT)**

Doc no.: HSEP: 14-MAITREE:VENDOR

REV: 00

Date: 05.05.16

Page: **60 of 90**

POWER SECTOR-EASTERN REGION

- Evacuate job site.

D. PERSONNEL EVACUATION:

Personnel Evacuation will be required if predicted wind speed and storm surge heights are beyond acceptable limits as per the guidelines of BHEL management.

Special cyclone shelter shall be arranged in consultation with BHEL management. This shelter shall be equipped with first aid kit and emergency kit containing torch, sufficient batteries, jackets, emergency treatment manual. The map of escape routes and other site specific instructions of emergency situations shall be prominently displayed in the shelter.

Once the warning received from Client/Consultant, the emergency response team shall evacuate and transport all personnel involved in the project to the cyclone shelter.

Cyclone may followed by the calm "EYE" be aware of it. If the wind suddenly drops, don't assume the cyclone is over. Violent wind may resume from the opposite side direction. Wait for the official "All clear Signal".

After the cyclone do not go outside until officially communicated about safe situation outside. Use recommended routs for returning. Do not panic or rush while returning.

Checking of gas leaks and wellbeing of electrical appliances is essential before leaving the site.

Listen to local radio for official warning and advice. The site manager shall also obtain updates from client/consultants/metrological departments and communicate to the personnel on project site.

E. MONSOON:

During monsoon following precautions needs to be considered.

- **Excavation:** Inspect all excavations and protect from collapsing or subsidence. Clear all excavated material.
- **Storm water drains:** Check all storm water drains ahead of monsoon for any blockage etc. Identify way for draining out water collected in the site. If required, temporary drains should be prepared for draining out accumulated water in site. The sufficient number of dewatering pumps should be available for the purpose and logged water shall be pumped to nearest drain by dewatering pumps.
- **Access Routes:** Identify access routes to the site in case of flood. Sand should be available to spread over slippery surface.
- **Electrical Supply:** Beforehand check earthing of electrical panels and electrical cables for joints, cracks, insulation failure etc. Keep additional stock of electrical cables and plug tops for replacement of damaged one or to energize dewatering pumps. Do not keep electrical cables/welding cables on the ground but route them above head level. Do not use welding / DB sheds as shelters. All electrical equipment shall be equipped with ELCBs/RCCBs.
- **Power Cable route demarking:** cable rout shall be demarked by either by temporary or permanent.
- **Scaffolding:** Check all scaffolds for stability after heavy rain/storm.



**HEALTH, SAFETY AND ENVIRONMENT
PLAN FOR SITE SUB-CONTRACTORS
(MAITREE PROJECT)**

Doc no.: HSEP: 14-MAITREE:VENDOR

REV: 00

Date: 05.05.16

Page: 61 of 90

POWER SECTOR-EASTERN REGION

- **Work restrictions:** Do not perform any height work, electrical work and rigging activities during rain. Lower the crane boom to avoid striking of lightning.
- **Vehicular movement:** Instruct the vehicle operators about following safety precautions during monsoon in daily tool box meeting, Slippery surface and road conditions, Speed limit, Wind shield wiper, Fog light, break condition is proper, break light is in proper condition & functioning. Not to take vehicle in loose soil.
 - **Lightening protection:** Boiler structure shall be facilitated with thunder protecting equipment.
 - **Workmen shed construction:** workmen rest shed shall be constructed in robust way. RCC pillar shall be used instead of brick pillar. It shall be facilitated with lightning arrestor as per site resource. However if the rest room is nearby high mast light. Lighting arrestor may or may not be provided.
 - **Field Training Programme on Lightening/Thunder: Dos or Dos not.**

F. SAFETY PRECAUTIONS FOR SNAKE MENACE:

Preventive Measures –

- ③ Remove vegetations around the site
- ③ Pour Carbolic acid around site boundaries in regular intervals to keep away poisonous snakes. . In summer and rainy season, frequency will be once a month and in other seasons, it will be once a quarter. It may be noted that as the location of the project is on a sand bed, there is almost no wild growths. Hence, Snake menace may not of significant severity and scale.

Precautions to avoid snake bite –

- ③ Avoid stepping out in the dark, especially during monsoon without safety shoes and torch.
- ③ Before wearing shoes, check inside the shoes for any snake/insect hiding inside. Similarly before lifting any material with hand lying on ground for long time, look for snake/insect handling inside. Wear leather hand gloves. Always check inside gunny bags, cartons, boxes before putting your hand in side or lifting them.
- ③ Be aware of your surroundings at all time. Never sit or step over obstacles without looking carefully. Never go near bushes for natural calls.
- ③ Don't chase snakes as they become aggressive. Never try to hit a snake or try to catch it, where there is one, there are likely others.
- ③ Never handle a snake, even if you think it is dead.

Symptoms of Snake Bite –

- ③ A pair of punctured mark, severe pain, Redness & swelling around bitten area
- ③ Victim gets nausea, vomiting sensation, sweating, disturbed breathing and increased salivation.

Actions required in case of snake bite –

- ③ Reassure the victim
- ③ Immobilize the bitten body part without compression.
- ③ Get the patient to hospital as fast as safely possible



**HEALTH, SAFETY AND ENVIRONMENT
PLAN FOR SITE SUB-CONTRACTORS
(MAITREE PROJECT)**

Doc no.: HSEP: 14-MAITREE:VENDOR

REV: 00

Date: 05.05.16

Page: **62 of 90**

- ③ Tell the doctor any of the symptoms appearing on the way to the hospital.

Snakebite Emergency: DO's and DON'Ts

Do's:

- ③ Avoid yourself and victim from the risk of second bite.
- ③ Remove tight clothing, shoes, watch or ring near bitten area before swelling starts. Calm the victim. Tell victim that virtually all snakebites are successfully treated. Panic can increase the danger to the victim by inducing rapid heartbeat.
- ③ Clean / disinfect bite area thoroughly, apply hard direct pressure with gauze pad over bite area, soak gauze pad with Betadine if possible before application and strap pad tightly in place with adhesive tape
- ③ Wrap affected extremity with 2" – 3" elastic bandaging as tightly as one would for sprain, keep the affected extremity positioned at or as close to heart level as possible and immobilize affected extremity; use a splint if possible.
- ③ Get medical attention as soon as possible
- ③ Ensure the availability of anti venom serum in the hospital.

Don'ts:

- ③ Do not bleed the wound, cut or increase bite marks or put ice on the bite
- ③ Do not eat or drink anything and engage in strenuous physical activity
- ③ Do not apply oral suction to bite
- ③ Do not take alcoholic beverage or any self medication
- ③ Do not apply cold / hot packs or burn wound
- ③ Do not delay seeking medical attention
- ③ Do not remove dressings/elastic wrap until at hospital

G. EMERGENCY CONTACT LIST:

Following emergency contact numbers shall be available / displayed at site and updated regularly.

Emergency Contact Numbers

(Contact numbers to be filled by Site Management)

Client	
	Project Manager
	Plant Safety Manager
	OPGC Fire Services
	Medical and Ambulance Services
	ADMIN-OPGC
	Security- OPGC



**HEALTH, SAFETY AND ENVIRONMENT
PLAN FOR SITE SUB-CONTRACTORS
(MAITREE PROJECT)**

Doc no.: HSEP: 14-MAITREE:VENDOR

REV: 00

Date: 05.05.16

Page: **63** of **90**

POWER SECTOR-EASTERN REGION

BHEL		
	RCM	
	Safety Manager	
	HSE COORDINATOR	
	HR-ADMIN	
SUB-CONTRACTOR		
	RCM	
	Project Manager	
	Safety Manager	
	Ambulance	
	HR-ADMIN	
Emergency Services		
	Near Hospital	
	Near Fire Station	
	Ambulance Service	
	Police Station	

32.0 HSE INSPECTION

Inspection on HSE for different activities being carried out at site shall be done to ensure compliance to HSEMS requirements. The subcontractor shall maintain and ensure necessary safety measures as required for inspection and tests HV test, Pneumatic test, Hydraulic test, Spring test, Bend test etc as applicable, to enable inspection agency for performing Inspection. If any test equipment is found not complying with proper safety requirements then the Inspection Agency may withhold inspection, till such time the desired safety requirements are met.

32.1 DAILY HSE CHECKS

Both the Site Supervisors and safety officer of Subcontractor are to conduct daily site Safety inspection around work activities and premises to ensure that work methods and the sites are maintained to an acceptable standard. The following are to form the common subjects of a daily safety inspection:



**HEALTH, SAFETY AND ENVIRONMENT
PLAN FOR SITE SUB-CONTRACTORS
(MAITREE PROJECT)**

Doc no.: HSEP: 14-MAITREE:VENDOR

REV: 00

Date: 05.05.16

Page: 64 of 90

POWER SECTOR-EASTERN REGION

- Personal Safety wears & gear compliance.
- Complying with site safety rules and permit-to-work (PTW).
- Positions and postures of workers.
- Use of tools and equipment etc. by the workers.
- The inspection should be carried out just when work starts in beginning of the day, during peak activities period of the day and just before the day's work ends.

32.2 INSPECTION OF PPE

- PPEs shall be inspected by HSE officer at random once in a week as per format no. HSEP:14-F06 for its compliance to standard and compliance to use and any adverse observation shall be recorded in the PPE register.
- The applicable PPEs for carrying out particular activities are listed below.

32.3 INSPECTION OF T&Ps

- A master list of T&Ps shall be maintained by each subcontractor.
- All T&Ps being used at site shall be inspected by HSE officer once in a month as per format no. HSEP:14-F07 for its healthiness and maintenance.
- The T&Ps which require third party inspection shall be checked for its validity during inspection. The third party test certificate should be accompanied with a copy of the concerned competent person's valid qualification record.
- The validity of T&P shall be monitored as per "Status of T&Ps" format no. HSEP:14-F08

32.4 INSPECTION OF CRANES AND WINCHES

- Cranes and winches shall be inspected by the operator through a daily checklist for its safe condition (as provided by the equipment manufacturer) before first use of the day.
- Cranes and Winches shall be inspected by HSE officer once in a month as per format no. HSEP:14-F09 for healthiness, maintenance and validity of third party inspection.
- The date of third party inspection and next due date shall be painted on cranes and winches.
- The operators/drivers shall be authorized by sub-contractor based on their competency and experience and shall carry the I-card.

32.5 INSPECTION ON HEIGHT WORKING

- Inspection on height working shall be conducted daily by supervisors before start of work to ensure safe working condition including provision of
 - Fall arrestor
 - Lifelines
 - Safety nets
 - Fencing and barricading
 - Warning signage
 - Covering of opening
 - Proper scaffolding with access and egress.
 - Illumination
- Inspection on height working shall be conducted once in a week by HSE officer as per format no. HSEP:14-F10.



**HEALTH, SAFETY AND ENVIRONMENT
PLAN FOR SITE SUB-CONTRACTORS
(MAITREE PROJECT)**

Doc no.: HSEP: 14-MAITREE:VENDOR

REV: 00

Date: 05.05.16

Page: 65 of 90

POWER SECTOR-EASTERN REGION

- Medical fitness of height worker shall be ensured.
- Height working shall not be allowed during adverse weather.

32.6 INSPECTION ON WELDING AND GAS CUTTING OPERATION

- Supervisor shall ensure that no flammable items are available in near vicinity during welding and gas cutting activity.
- Gas cylinders shall be kept upright.
- Use of Flash back arrestor shall be ensured at both ends.
- Inspection during welding and gas cutting operations shall be carried out by HSE officer once a month as per format no. HSEP:14-F11.
- Use of fire blanket to be ensured to avoid falling of splatters during welding or gas cutting operation at height.
- Availability of fire extinguisher at vicinity shall be ensured.

32.7 INSPECTION ON ELECTRICAL INSTALLATION / APPLIANCES

- Ensure proper earthing in electrical installation
- Use ELCB at electrical booth
- Electrical installation shall be properly covered at top where required
- Use appropriate PPEs while working
- Use portable electrical light < 24 V in confined space and potentially wet area.
- Monthly inspection shall be carried out as per format no. HSEP:14-F12.

32.8 INSPECTION OF ELEVATOR

- Elevators shall be inspected by concerned supervisors once in a week as per format no. HSEP:14-F13.
- All elevators shall be inspected by competent person and validity shall be ensured.
- The date of third party inspection and next due date shall be painted on elevator.

33.0 HSE PERFORMANCE EVALUATION:

HSE performance of the subcontractor shall be monitored as per the following parameters: (For each contract-wise package). PERIODICITY: RA Bill period

Sl. No.	Parameters of measurement	Ref Clauses	Weightage	Actual
1	Availability of safety officers at site – absence up to 15% permissible. Score proportionately gets reduced with higher rate of absence. Availability to be reckoned from start date of manpower mobilisation	7.0,7.1	10	
2	Attendance by the safety officer and site CM (as applicable) in the meeting convened by BHEL	7.2.1 and 7.2.2	5	
3	Level of compliance w.r.t decisions taken in previous meetings/audit/inspection/as reported.	32.0,35.0,36.0	5	
4	Timely submission of monthly report on safety in the prescribed format		3	
5	Timely reporting any incident including near-miss to BHEL /Customer/statutory authority(if required) and submission of investigation report of all LTIs/ Major Property Loss incident and HSE events	10.0	10	



**HEALTH, SAFETY AND ENVIRONMENT
PLAN FOR SITE SUB-CONTRACTORS
(MAITREE PROJECT)**

Doc no.: HSEP: 14-MAITREE:VENDOR

REV: 00

Date: 05.05.16

Page: **66 of 90**

POWER SECTOR-EASTERN REGION

6	Degree of PPE compliance, Fall protection arrangements and safety net coverage	8.3, 19.2,19.3	15	
7	Level of compliance w.r.t safety rules	11.0 to 26.0	25	
8	Availability of proper first-aid facility , ambulance, hygienic labour colony and other adequate labor welfare initiatives, conducting of health check-up as per BOCW requirements	8.4	6	
9	Conducting induction training ,skill training, tool box meeting, mock-drills, HSE Promotion, Emergency Preparedness and Response. Participation in BHEL training also counted	9.0, 31.0	6	
10	Level of House-keeping, Environmental Control	27.0, 28.0, 29.0	10	
11	Level of general illumination	8.4.11	5	
A	TOTAL Obtained		100	

Penalty score:

- i. For each fatality: -10
- ii. For each Major Incident: -07

NET TOTAL score will be arrived after deducting penalty score from Total score.

33.1 HSE PENALTIES/ REWARDS (Performance Related)

- Suitable HSE reward system shall be developed at site level to promote HSE compliance amongst workmen.
- To decide HSE reward performance towards HSE shall be evaluated for workmen and it shall be awarded regularly in public gathering.
- If safety record of the subcontractor in execution of the awarded job is to the satisfaction of safety department of BHEL, issue of an appropriate certificate to recognize the safety performance of the subcontractor may be considered by BHEL after completion of the job.

33.2 PENALTIES AGAINST SPECIFIC NON-COMPLIANCE WITH HSE RULES/ INCIDENTS: (To be operated in addition to any other deduction on unsatisfactory HSE performance under relevant clause in the contract)

S. No	Nature of Non - Compliance	Penalty in BTK	Remarks
1.	Not wearing safety helmet/ safety shoes/ welding shield	250	Per lapse/ Person/ day
2.	Not wearing double lanyard full body harness while working at height (> 2 metres)or not anchoring to lifeline/ not providing fall arrestor/ safety net Using defective or non-standard or uninspected scaffolding/ scaffolding not properly supported Using defective ladders/ drums for work at height	1000	Per Person/ lapse/day or per lapse/day
3.	Not wearing gloves/ goggle/earplug/nose mask/ apron	250	Per lapse/ Person/ day
4.	Not using 24 V supply for lighting in confined spaces	500	Per occasion



**HEALTH, SAFETY AND ENVIRONMENT
PLAN FOR SITE SUB-CONTRACTORS
(MAITREE PROJECT)**

Doc no.: HSEP: 14-MAITREE:VENDOR

REV: 00

POWER SECTOR-EASTERN REGION

Date: 05.05.16

Page: 67 of 90

5.	Improper earthing of welding & Other electrical machines and DBs/ no ELCB/ no rubber mat/ not properly covered/ person without valid wireman license/ no Tag in-Tag out	500	Per lapse/ Machine
6.	Electrical plug not used for connection/ loose insertion	200	Per connection
7.	Using damaged slings or not slinging properly/ damaged hooks/ slings without any identification mark/	1000	Per event Per T&P
8.	Use of lifting equipments including cage or man-basket without having valid Test certificate / without SLI display	5000	Per equipment
9.	Using frayed/ broken welding cables / not using double insulation electrical cable	500	Per machine
10.	Non removal of scrap from work areas and shift to scrap yard/ not providing bins/ improper house keeping	1000	Per location
11.	Lifting cylinders without cage or rolling of cylinders	500	Per occasion
12.	Gas cutting without flash back arrestor at both ends	200	Per machine
13.	Gas cutting at height without sheet below/ barricade at level below (Spark falling from height)	500	Per event
14.	Not having valid driving license for the type of vehicle/ T&P/operator identification card/ rash driving or operation/ not having safety devices like reverse horn & light/ overload switch	500	Per driver / operator
15.	Not providing proper barricades / signage/ unauthorized excavation or barricading	500	Per location per day
16.	Not keeping filled gas cylinders vertically/ mix-up of cylinders/ using broken or damaged manifold/ using domestic LPG cylinder	500	Per occasion
17.	Activity carried out without valid safety work permit	1000	Per occasion
18.	Not carrying out mandatory health check up/ not maintaining First aid box/ centre properly	1000	Per occasion
19.	Non reporting of incident in time / completion of CAPA in time	1000	Per occasion
20.	Non-display of emergency numbers/ non-availability of sufficient fire-extinguishers/ insufficient display of safety posters/ insufficient initiative for safety promotion like TBM	1000	Per occasion



**HEALTH, SAFETY AND ENVIRONMENT
PLAN FOR SITE SUB-CONTRACTORS
(MAITREE PROJECT)**

Doc no.: HSEP: 14-MAITREE:VENDOR

REV: 00

Date: 05.05.16

Page: **68 of 90**

POWER SECTOR-EASTERN REGION

- If principal customer or statutory and regulatory bodies impose penalty on ground of statutory non-compliance or non-compliance of HSE rules by the subcontractor or any incident of any nature including fatality or permanent disability, the same shall be passed on to the subcontractor with appropriate overhead
- The penalty amount shall be recovered from subcontractors from the RA Bill, otherwise Final bill.
- The list of non-compliances is not exhaustive. The site CM has liberty to impose a penalty for any other non-compliance and incidents of any nature including fatality and permanent disability.

340 OTHER REQUIREMENTS

- In case of any delay in completion of a job due to mishaps attributable to lapses by the subcontractor, BHEL shall have the right to recover cost of such delay from the payments due to the subcontractor, after notifying the subcontractor suitably.
- If the subcontractor fails to improve the standards of safety in its operation to the satisfaction of BHEL after being given reasonable opportunity to do so and/or if the subcontractor fails to take appropriate safety precautions or to provide necessary safety devices and equipment or to carry out instruction regarding safety issued by BHEL, BHEL shall have the right to take corrective steps at the risk and cost of the subcontractor after giving a notice of not less than 7 days indicating the steps that would be taken by BHEL.
- If the subcontractor succeeds in carrying out its job in time without any fatal or disabling injury incident and without any damage to property BHEL may, at its sole discretion, favorably consider to reward the subcontractor suitably for the performance.
- In case of any damage to property due to lapses by the subcontractor, BHEL shall have the right to recover the cost of such damages from the subcontractor after holding an appropriate enquiry.
- The subcontractor shall take all measures at the sites of the work to protect all persons from incidents and shall be bound to bear the expenses of defense of every suit, action or other proceeding of law that may be brought by any persons for injury sustained or death owing to neglect of the above precautions and to pay any such persons such compensation or which may with the consent of the subcontractor be paid to compromise any claim by any such person, should such claim proceeding be filed against BHEL, the subcontractor hereby agrees to indemnify BHEL against the same.
- The subcontractor shall not employ men below the age of 18 years and women on the work of painting with products containing lead in any form. Wherever men above the age of 18 are employed on the work of lead painting, overalls shall be supplied by the subcontractor to the workmen and adequate facilities shall be provided to enable the working painters to wash during the cessation of work.
- The subcontractor shall notify BHEL of his intention to bring to site any equipment or material which may create hazard.
- BHEL shall have the right to prescribe the conditions under which such equipment or materials may be handled and the subcontractor shall adhere to such instructions.
- BHEL may prohibit the use of any construction machinery, which according to the organization is unsafe. No claim for compensation due to such prohibition will be entertained by BHEL.



**HEALTH, SAFETY AND ENVIRONMENT
PLAN FOR SITE SUB-CONTRACTORS
(MAITREE PROJECT)**

Doc no.: HSEP: 14-MAITREE:VENDOR

REV: 00

POWER SECTOR-EASTERN REGION

Date: 05.05.16

Page: 69 of 90

35.0 HSE AUDIT/INSPECTION

- Regular HSE Audit/inspection shall be carried out by Subcontractor as per Site HSE audit calendar.
- HSE checklist(**Annexure 02**)shall be used for carrying out audit/inspection and report shall be submitted to BHEL site mangement
- All non-conformities and observations on HSE identified during internal or external HSE audit shall be disposed off by site in a time bound manner and reported back the implementation status
- Corrective action and Preventive action on HSE issues raised by certification body issued by Regional HQs shall be implemented by site and reported to Site management.

36.0 MONTHLY HSE REVIEW MEETING

- Site shall hold HSE review meeting every month to discuss and resolve HSE issues of site and improve HSE performance. It will also discuss the incidents occurred since previous meeting, its root cause and Corrective action and Preventive action. The agenda is given below:
 - Implementation of earlier MOM
 - HSE performance
 - HSE inspection
 - HSE audit and CAPA
 - HSE training
 - Health check-up camp
 - HSE planning for the erection and commissioning and installation activities in the coming month
 - HSE reward and promotional activities
- The meeting shall be chaired by Construction Manager, convened by HSE coordinator and attended by all HOS, Site In charge of Subcontractors and HSE officer of Subcontractors. MOM on the discussion will be circulated to the concerned for implementation.

37.0 FORMATS USED (Details available in Annexure-04) (subject to revisions any time during the contract)

SL. No.	Format Name	Format No.	Rev No.
01	Inspection of First Aid Box	HSEP:14-F01:MAITREE	00
02	Health Check Up	FORM-26	00
03	HSE Induction Training	HSEP:14-F03	00
04	Tool Box Talk	HSEP:14-F04	00
05	MONTHLY HSE REPORT AND HSE INDICES	HSEP:14-F05	00
06	Inspection of PPE	HSEP:14-F06	00



**HEALTH, SAFETY AND ENVIRONMENT
PLAN FOR SITE SUB-CONTRACTORS
(MAITREE PROJECT)**

Doc no.: HSEP: 14-MAITREE:VENDOR

REV: 00

Date: 05.05.16

Page: 70 of 90

POWER SECTOR-EASTERN REGION

07	Inspection of T&Ps	HSEP:14-F07	00
08	Status of T&Ps	FORM-24	00
09	Inspection of Cranes and Winches	HSEP:14-F09	00
10	Inspection on Height Working	HSEP:14-F10	00
11	Inspection on Welding & Gas Cutting	HSEP:14-F11	00
12	Inspection on Electrical Installation	HSEP:14-F12	00
13	Inspection on Elevator	HSEP:14-F13	00
14	Hse Performance and Penalty	HSEP:14-F14	00
15	incident / property damage /fire incident report	HSEP:14-F15	00
16	Crane operators Identification cum Authorization	HSEP:14-F16	
17	List of T&P	FORM-24	00
18	WORK PERMIT- EXCAVATION (DEEP)	HSEP:14-F18	00
19	WORK PERMIT- RADIATION	HSEP:14-F19	00
20	WORK PERMIT- CONFINED SPACE	HSEP:14-F20	00
21	WORK PERMIT- WORK-AT-HEIGHT (ABOVE 1.8M)	HSEP:14-F21	00



**HEALTH, SAFETY AND ENVIRONMENT
PLAN FOR SITE SUB-CONTRACTORS
(MAITREE PROJECT)**

Doc no.: HSEP: 14-MAITREE:VENDOR

REV: 00

POWER SECTOR-EASTERN REGION

Date: 05.05.16

Page: 71 of 90

36.0 ANNEXURES

ANNEXURE 01

As per Rule 76(2):

(1) The first-aid box shall be distinctively marked with a GREEN Cross and shall contain the following items, namely:

(a) For establishments in which the number of contract labour employed does not exceed fifty, each first aid box shall contain the following equipment:

(i)	6 small sterilized dressings
(ii)	3 medium size sterilized dressings
(iii)	3 large size sterilized dressings
(iv)	6 pieces of sterilized eye pads in separate sealed packets.
(v)	6 roller bandages 10 cm wide.
(vi)	6 roller bandages 5 cm wide.
(vii)	One tourniquet
(viii)	A supply of suitable splints
(ix)	Three packets of safety pins.
(x)	Kidney tray.
(xi)	3 large sterilized burn dressings.
(xii)	1 (30ml) bottle containing a two percent alcoholic solution of iodine
(xiii)	1 (30 ml) bottle containing Sal volatile having the dose and mode of administration indicated on the label
(xiv)	1 snake bite lancet
(xv)	1 (30gms) bottle of potassium permanganate crystals.
(xvi)	1 pair scissors
(xvii)	A bottle containing 100 tablets (each of 5 grains) of aspirin
(xviii)	Ointment for burns
(xix)	A bottle of suitable surgical anti-septic solution
(xx)	3 packets of ORS

(2) Adequate arrangement shall be made for immediate recoupment of the equipment when necessary.



**HEALTH, SAFETY AND ENVIRONMENT
PLAN FOR SITE SUB-CONTRACTORS
(MAITREE PROJECT)**

Doc no.: HSEP: 14-MAITREE:VENDOR

REV: 00

Date: 05.05.16

Page: 72 of 90

POWER SECTOR-EASTERN REGION

ANNEXURE 02**HSE AUDIT/INSPECTION CHECKLIST CUM COMPLIANCE REPORT**

PROJECT: _____

SUBCONTRACTOR: _____

DATE : _____

OWNER : _____

INSPECTION BY: _____

Note : write 'NA' wherever the items is not applicable

Item	Y e s	N o	Remarks	Action
HOUSEKEEPING				
Waste containers provided and used				
Passageways and walkways clear				
General neatness of working area				
Other				
PERSONNEL PROTECTIVE EQUIPMENTS				
Goggles; shields				
Face protection				
Hearing protection				
Respiratory masks etc.				
Safety belts				
Other				
EXCAVATIONS / OPENINGS				
Openings properly covered or barricaded				
Excavations shored				
Excavations barricaded				
Overnight lighting provided				
Other				
WELDING, CUTTING				
Gas cylinders chained upright				
Cable and hoses not obstructing				
Fire extinguisher (s) accessible				
Others				
SCAFFOLDING				
Fully decked platforms				
Guard and intermediate rails in place				
Toe boards in place				
Adequate shoring				
Adequate access				
Others				
LADDER				
Extension side rails 1 m above				
Top of landing				
Properly secured				
Angle + 70° from horizontal				



**HEALTH, SAFETY AND ENVIRONMENT
PLAN FOR SITE SUB-CONTRACTORS
(MAITREE PROJECT)**

Doc no.: HSEP: 14-MAITREE:VENDOR

REV: 00

Date: 05.05.16

Page: 73 of 90

POWER SECTOR-EASTERN REGION

Other				
HOISTS, CRANES AND DERRICKS				
Condition of cables and sheaf OK				
Condition of slings, chains, hooks OK				
Inspection & maintenance log maintained				
Outriggers used				
Signals observed and understood				
Qualified operators				
Others				
MACHINERY, TOOLS & EQUIPMENT				
Proper instruction				
Safety devices				
Proper cords				
Inspection and maintenance				
Other				
VEHICLE AND TRAFFIC				
Rules and regulations observed				
Inspection and maintenance				
Licensed drivers				
Other				
TEMPORARY FACILITIES				
Emergency instructions posted				
Fire extinguishers provided				
Fire-aid equipment available				
General neatness				
Others				
FIRE PREVENTION				
Personnel instructed				
Fire extinguishers checked				
No smoking in prohibited areas.				
Hydrants				
Clearance				
Others				
ELECTRICAL				
Proper wiring				
ELCB's provided				
Ground fault circuit interrupters				
Protection against damage				
Prevention of tripping hazards				
Other				
HANDLING & STORAGE OF MATERIALS				
Properly stored or stacked				
Passageways clear				
Other				
FLAMMABLE GASES AND LIQUIDS				
Containers clearly identified				
Proper storage				
Fire extinguisher nearby				
Other				



**HEALTH, SAFETY AND ENVIRONMENT
PLAN FOR SITE SUB-CONTRACTORS
(MAITREE PROJECT)**

Doc no.: HSEP: 14-MAITREE:VENDOR

REV: 00

Date: 05.05.16

Page: 74 of 90

POWER SECTOR-EASTERN REGION

WORKING AT HEIGHT				
Safety nets				
Safety belts				
Safety helmets				
Anchoring of safety belt to the life line rope				
ENVIRONMENT				
Lubricant waste/engine oils properly dispose.				
Waste from Canteen, offices, sanitation etc. disposed properly.				
Disposal of surplus earth, stripping materials, expired batteries, oily rags and combustible materials done properly.				
HEALTH CHECKS				
Hygienic conditions at labor camps O.K.				
Availability of first-aid facilities				
Proper sanitation at site, office & labor camps.				
Arrangement of medical facilities.				
Measures for dealing with illness.				
Availability of potable drinking water for workmen & staff.				



**HEALTH, SAFETY AND ENVIRONMENT
PLAN FOR SITE SUB-CONTRACTORS
(MAITREE PROJECT)**

Doc no.: HSEP: 14-MAITREE:VENDOR

REV: 00

POWER SECTOR-EASTERN REGION

Date: 05.05.16

Page: 75 of 90



**Bharat Heavy Electricals Ltd
Power Sector- Eastern Region**

HSEP:13-F04**Date:****PROJECT: _____****(TO BE SUBMITTED IN TRIPLICATES)****EXCAVATION WORK PERMIT**

Sl No:

- I. Name of the work:
- II. Name of Contractor:
- III. Exact location of work and item for excavation:
- IV. Duration of work: From _____ to _____
- V. Type of excavation: Manual/ by Excavator
- VI. Dimension of excavation:

The following items have been checked and compliance shall be ensured during the currency of the permit:

item	Done
1. Checked for underground pipe/power cable	
2. Proper illumination provided (for night work)	
3. Plan/drawing available and checked (sloping, shoring provided). Safety of any adjacent structure taken care of.	
4. Access/Egress ensured (in case of manual)	
5. Equipment operator skill checked	



**HEALTH, SAFETY AND ENVIRONMENT
PLAN FOR SITE SUB-CONTRACTORS
(MAITREE PROJECT)**

Doc no.: HSEP: 14-MAITREE:VENDOR

REV: 00

Date: 05.05.16

Page: 76 of 90

POWER SECTOR-EASTERN REGION

6. Area cordoned off, signage put up

7. Appropriate PPEs provided

The following persons are permitted to work for the duration mentioned herein:

Date		No of persons allowed	Time Duration	
From	To		From	To

List of persons to be maintained by contractor separately

Sign of Initiator (Sub-contractor)

Sign of Recommender

Sign of Approver

Work completed/stopped/area cleared at _____ on _____

The permit stands closed on _____

Sign of BHEL HSE team



**HEALTH, SAFETY AND ENVIRONMENT
PLAN FOR SITE SUB-CONTRACTORS
(MAITREE PROJECT)**

Doc no.: HSEP: 14-MAITREE:VENDOR

REV: 00

POWER SECTOR-EASTERN REGION

Date: 05.05.16

Page: 77 of 90



**Bharat Heavy Electricals Ltd
Power Sector- Eastern Region**

HSEP:13-F05**Date:**

**PROJECT: _____
(TO BE SUBMITTED IN TRIPLICATES)**

RADIATION WORK PERMIT

Sl No:

- I. Name of the work:
- II. Name of Contractor:
- III. Exact location of work and item for radiography:
- IV. Duration of work: From _____ to _____
- V. Name of Radiography agency and its authorised supervisor:

The following items have been checked and compliance shall be ensured during the currency of the permit:

item	Done
1. Safety regulations as per BARC/AERB ensured while source in use/transit/stores	
2. Proper illumination provided	
3. Area cordoned off	
4. Appropriate PPEs provided	



**HEALTH, SAFETY AND ENVIRONMENT
PLAN FOR SITE SUB-CONTRACTORS
(MAITREE PROJECT)**

Doc no.: HSEP: 14-MAITREE:VENDOR

REV: 00

Date: 05.05.16

Page: **78 of 90**

POWER SECTOR-EASTERN REGION

The following persons are permitted to work for the duration mentioned herein:

Date		No of persons allowed	Time Duration	
From	To		From	To

List of persons to be maintained by contractor separately

Sign of Initiator (Sub-contractor)

Sign of Recommender

Sign of Approver

Work completed/stopped/area cleared at _____ on _____

The permit stands closed on _____

Sign of BHEL HSE team



**HEALTH, SAFETY AND ENVIRONMENT
PLAN FOR SITE SUB-CONTRACTORS
(MAITREE PROJECT)**

Doc no.: HSEP: 14-MAITREE:VENDOR

REV: 00

POWER SECTOR-EASTERN REGION

Date: 05.05.16

Page: 79 of 90



**Bharat Heavy Electricals Ltd
Power Sector- Eastern Region**

HSEP:13-F06

Date:

**PROJECT: _____
(TO BE SUBMITTED IN TRIPLICATES)**

CONFINED SPACE WORK PERMIT

Sl No:

- I. Name of the work:
- II. Name of Contractor:
- III. Exact location of work:

1. Condition check of target space:

Condition	Y/N	NR
8. Isolated from air/ water/ steam/ gas/ power/radiation source		
9. Thoroughly cleaned/washed		
10. Adequately cooled		
11. Proper illumination provided		
12. Manways open & ventilated		

2. Protection measures:

Measure	Y/N	NR
1. Handlamp is of 24V		
2. Operators wearing recommended PPEs- gloves/ clothing/ear plug/ muff/ safety harness/lifeline/ goggles /face shield		



**HEALTH, SAFETY AND ENVIRONMENT
PLAN FOR SITE SUB-CONTRACTORS
(MAITREE PROJECT)**

Doc no.: HSEP: 14-MAITREE:VENDOR

REV: 00

Date: 05.05.16

Page: **80 of 90**

POWER SECTOR-EASTERN REGION

3. Operators wearing special devices –
dust/gas/airline mask, communication equipment,
personal gas alarm

4. Attendant with SCBA/Air mask

5. Rescue equipment/ team deployed

6. Fire fighting equipment close-by

The following persons are permitted to enter the confined space to work for the duration mentioned herein:

Date(s)	No of persons allowed	Name of persons allowed	Duration	
			From	To

Sign of Initiator (Sub-contractor)

Sign of Recommender

Sign of Approver

Work completed/stopped/area cleared at _____ on _____

The permit stands closed on _____

Sign of BHEL HSE team



**HEALTH, SAFETY AND ENVIRONMENT
PLAN FOR SITE SUB-CONTRACTORS
(MAITREE PROJECT)**

Doc no.: HSEP: 14-MAITREE:VENDOR

REV: 00

Date: 05.05.16

Page: 81 of 90

POWER SECTOR-EASTERN REGION



**Bharat Heavy Electricals Ltd
Power Sector- Eastern Region**

HSEP:13-F07

Date:

**PROJECT: _____
(TO BE SUBMITTED IN TRIPLICATES)**

WORK-AT-HEIGHT PERMIT

Sl No:

- I. **Name of the work:**
- II. **Name of Contractor:**
- III. **Exact location of work:**

Sl.	Description of the point to be checked	Pl tick (✓) if it is OK
1.	Whether the manpower of the Gang engaged is having adequate number and skill required for the said activity?	
2.	Whether Supervisor has been engaged for this activity?	
3.	Whether following PPEs have been provided to all workers? Full body Harness, Safety Shoe, Helmet	
4.	Whether Lifelines tied with solid anchorage above 1 M level from the job?	
5.	Whether Tool-Box meeting carried out and Hazard related to the said job and safety precaution to be taken told to workers?	
6.	Whether Fall arrestor fixed where staircase is not available for access to job?	
7.	Whether Scaffold/Platform/Place for job is strong enough, has easy access and is safe for the job? Is the Space sufficient for doing work? Whether Safety Net has been fixed?	
8.	Whether all Lifting T&Ps and Tackles have valid Fitness Certificates? Whether Lubrication is Ok? Whether these are free from any defect when visually checked before use?	
9.	Pl ensure that none of the workers of the Gang has Vertigo or High or Very Low Blood Pressure. (Health register to be referred)	



**HEALTH, SAFETY AND ENVIRONMENT
PLAN FOR SITE SUB-CONTRACTORS
(MAITREE PROJECT)**

Doc no.: HSEP: 14-MAITREE:VENDOR

REV: 00

Date: 05.05.16

Page: **82 of 90**

POWER SECTOR-EASTERN REGION

The following persons are permitted to work for the duration mentioned herein:

Date		No of persons allowed	Time Duration	
From	To		From	To

List of persons to be maintained by contractor separately

Sign of Initiator (Sub-contractor)

Sign of Recommender

Sign of Approver

Work completed/stopped/area cleared at _____ on _____

The permit stands closed on _____

Sign of BHEL HSE team



**HEALTH, SAFETY AND ENVIRONMENT
PLAN FOR SITE SUB-CONTRACTORS
(MAITREE PROJECT)**

Doc no.: HSEP: 14-MAITREE:VENDOR

REV: 00

Date: 05.05.16

Page: 83 of 90

POWER SECTOR-EASTERN REGION

HSEP:13-F09



**Bharat Heavy Electricals Limited
Power Sector Eastern Region**

INCIDENT (PERSONAL INJURY / PROPERTY DAMAGE) REPORT

(This report is to be sent within 24 hours directly to GM/Q &S/PS-HQ, , Noida with copy to MR(HSE)/PSE in respect of all incidents in addition to immediate Fax/Telegraphic intimation of fatalities and major damages including fires.)

1	NAME OF SITE		3	ACTIVITY AREA	
2	SCOPE OF WORK		4	NAME OF CONTRACTOR	
			5	NAME & DESIGNATION OF BHEL ACTIVITY I/C	
6	DATE & TIME OF INCIDENT		7	DATE RESUMED	
8	NO. OF WORK-DAYS LOST BY VICTIM (If duty not resumed, give estimated figure)				
9	NO. OF MANHOURS LOST BY OTHERS				
10	PERSONAL DETAILS OF INJURED AND / OR DETAILS OF MATERIALS / EQUIPMENT / PROPERTY DAMAGED				
	NAME		NAME OF MATERIAL / EQUIPMENT / PROPERTY		
	PERIOD OF EMPLOYMENT				
	AGE	YRS	SEX	MALE/FEMALE	ESTIMATED COST
	MARITAL STATUS		SINGLE / MARRIED		ACTUAL COST
	OCCUPATION				NATURE OF DAMAGE
	PART OF BODY INJURED				
	NATURE OF INJURY				
	AGENCY (OBJECT / EQUIPMENT / SUBSTANCE) MOST RESPONSIBLE FOR CAUSING INCIDENT / INJURY / DAMAGE				
12	PERSON (NAME & DESIGNATION) WITH MOST CONTROL OVER AGENCY (OBJECT / EQUIPMENT / SUBSTANCE) CAUSING INCIDENT INJURY / DAMAGE				
13	DESCRIBE CLEARLY HOW THE INCIDENT OCCURRED AND IF THE VICTIM WAS WEARING THE APPROPRIATE PPEs. (USE ADDI SHEET, IF REQUIRED).				



**HEALTH, SAFETY AND ENVIRONMENT
PLAN FOR SITE SUB-CONTRACTORS
(MAITREE PROJECT)**

Doc no.: HSEP: 14-MAITREE:VENDOR

REV: 00

Date: 05.05.16

Page: **84 of 90**

POWER SECTOR-EASTERN REGION

ANALYSIS

14	WHAT ACTS AND /OR CONDITIONS CONTRIBUTED MOST DIRECTLY TO THIS INCIDENT	
15	WHAT ARE THE BASIC REASON FOR THE EXISTENCE OF THESE ACTS AND / OR CONDITION ?	
16	WHAT CORRECTIVE ACTIONS HAVE BEEN TAKEN TO PREVENT INCIDENT RECURRENCE ?	
	DATE :	SIGNATURE OF SITE HSE COORDINATOR
17	COMMENTS OF HEAD / SOX	
	DATE:	SIGNATURE OF HEAD/SOX



**HEALTH, SAFETY AND ENVIRONMENT
PLAN FOR SITE SUB-CONTRACTORS
(MAITREE PROJECT)**

Doc no.: HSEP: 14-MAITREE:VENDOR

REV: 00

Date: 05.05.16

Page: 85 of 90

POWER SECTOR-EASTERN REGION



**BHARAT HEAVY ELECTRICALS LIMITED HSEP:13-F10
POWER SECTOR: EASTERN REGION**

INVESTIGATION REPORT FROM PROJECT SITE :

INCIDENT(FATAL/SERIOUS INJURY/PROPERTY DAMAGE/FIRE)

DATE :

Instructions

This report is to be sent within seven days to GM/Q&S/PS-HQ and RHQ Safety Department, in respect of incident requiring investigation by a committee.

Report date	Incident Date	Incident Time	Incident Type	
Name of Site :				
Scope of work :				
Name & Designation of BHEL Package I/C				
Name of Contractor :				
Incident Location :				
Victim(s) Information				
Name	Designation	Age	Sex	Address



**HEALTH, SAFETY AND ENVIRONMENT
PLAN FOR SITE SUB-CONTRACTORS
(MAITREE PROJECT)**

Doc no.: HSEP: 14-MAITREE:VENDOR

REV: 00

Date: 05.05.16

Page: **86 of 90**

POWER SECTOR-EASTERN REGION

Witness Information

Name	Address
1	Describe, how the incident took place (Attach separate sheets, diagrams, and photographs, if possible.)
2	Description of Injury (Attach medical report as applicable)
3	Describe property and equipment damaged in the incident and extent of damage.
4	Describe any personal protective equipment used and other safety equipment that were in place.
5	Describe any perceived actual or possible safety violations in the area of incident.



**HEALTH, SAFETY AND ENVIRONMENT
PLAN FOR SITE SUB-CONTRACTORS
(MAITREE PROJECT)**

Doc no.: HSEP: 14-MAITREE:VENDOR

REV: 00

Date: 05.05.16

Page: 87 of 90

POWER SECTOR-EASTERN REGION

6 Describe events and conditions immediately before the incident.

7 Are these conditions still in existence?

8 Were any unsafe actions performed by the victim or by others or were any safety rules violated that caused/ contributed to the incident.

9 Describe steps taken to secure the area.



**HEALTH, SAFETY AND ENVIRONMENT
PLAN FOR SITE SUB-CONTRACTORS
(MAITREE PROJECT)**

Doc no.: HSEP: 14-MAITREE:VENDOR

REV: 00

Date: 05.05.16

Page: **88 of 90**

POWER SECTOR-EASTERN REGION

10 Describe measures to be taken to prevent similar recurrences.

11 Any other information

Prepared by

Name

Designation

Signature

Date

Submitted to:

- 1 Construction Manager
- 2 RHQ: Safety Department
- 3 GM/Q&S/PS-HQ



**HEALTH, SAFETY AND ENVIRONMENT
PLAN FOR SITE SUB-CONTRACTORS
(MAITREE PROJECT)**

Doc no.: HSEP: 14-MAITREE:VENDOR

REV: 00

Date: 05.05.16

Page: **90 of 90**

POWER SECTOR-EASTERN REGION

RECORD OF REVISION

CLAUSE No.	Rev No.	Brief of Revision	Date
All	00	New plan introduced	05.04.17

FORMS & PROCEDURES

Tender No: BHEL: MSTPP: C- RW: CSD: 22:10:06

INDEX

SN	Description	Form No	Remarks
1.0	Forms		
1.1	Offer forwarding Letter/Submission of Tender	F-1 (Rev 00)	
1.2	Declaration by Authorized Signatory	F-2 (Rev 00)	
1.3	No Deviation Certificate	F-3 (Rev 00)	
1.4	Declaration confirming knowledge about Site Conditions	F-4 (Rev 00)	
1.5	Declaration for relation in BHEL	F-5 (Rev 00)	
1.6	Non-Disclosure Certificate	F-6 (Rev 00)	
1.7	Bank Account Details for E-Payment	F-7 (Rev 00)	
1.8	Form for seeking clarifications	F-8 (Rev 00)	
1.9	Capacity Evaluation of Bidder for current Tender	F-9 (Rev 00)	
1.10	Contract Agreement	F-10 (Rev 00)	
1.11	Bank Guarantee for Security Deposit	F-11 (Rev 00)	
1.12	Bank Guarantee for Interest Bearing Refundable Advance	F-12 (Rev 00)	
1.13	Extension of Validity of Bank Guarantee	F-13 (Rev 00)	
1.14	Monthly Plan & Review with Contractors	F-14 (Rev 00)	
1.15	Monthly Performance Evaluation of Contractor	F-15 (Rev 01)	Revised
1.16	Evaluation of Contractor Performance (Quarterly)	F-16 (Rev 00)	Deleted
1.17	Evaluation of Contractor Performance (Annual)	F-17 (Rev 01)	Under revision ##
1.18	Evaluation of Contractor Performance for the Contract (Overall)	F-18 (Rev 01)	Under revision ##

FORMS & PROCEDURES

Tender No: BHEL: MSTPP: C- RW: CSD: 22:10:06

SN	Description	Form No	Remarks
1.19	Milestone Completion Certificate	F-19 (Rev 00)	
1.20	Completion Certificate	F-20 (Rev 01)	Revised
1.21	Indemnity Bond	F-21 (Rev 00)	
1.22	Consortium Agreement	F-22 (Rev 00)	
1.23	Refund of Security Deposit	F-23 (Rev 00)	
1.24	Refund of Guarantee Money	F-24 (WAM-11)	
1.25	Power of Attorney for Submission of Tender/Signing Contract Agreement	F-25 (Rev 00)	
1.26	Analysis of Unit Rates Quoted	F-26 (Rev 00)	
1.27	RA Bill Format	WAM-6	
1.28	Final Bill Submission format with No Claim Certificate and No Demand Certificate	WAM-7	
1.29	PROFORMA FOR PERFORMANCE BANK GUARANTEE		
1.30	BANK GUARANTEE FOR SD CUM PBG BOND		
2.0	Procedures		
2.1	Procedure and Business Rules for Reverse Auction	As per Company Policy	
2.2	Integrity Pact	As per Company Policy	
3.0	Customer specific procedures		
3.1			

- BANK GUARANTEE FORMATS FOR "RELEASE OF AMOUNTS WITHED/ LIQUIDATED DAMAGES AMOUNT", "SUPPLY FREE ISSUE MATERIAL" & "EARNEST MONEY" IS ALSO GIVEN.

: will be released later

FORMS & PROCEDURES

Tender No: BHEL: MSTPP: C- RW: CSD: 22:10:06

Form No: F-01 (Rev 00)

OFFER FORWARDING LETTER / TENDER SUBMISSION LETTER (To be typed and submitted in the Letter Head of the Company/Firm of Bidder)

Offer Reference No:.....

Date:.....

To,

(Write Name & Address of Officer of BHEL inviting the Tender)

Dear Sir,

Sub : Submission of Offer against Tender Specification No:

I/We hereby offer to carry out the work detailed in the Tender Specification issued by Bharat Heavy Electricals Limited, Power Sector-....., in accordance with the terms and conditions thereof.

I/We have carefully perused the following listed documents connected with the above work and agree to abide by the same.

1. Amendments/Clarifications/Corrigenda/Errata/etc issued in respect of the Tender documents by BHEL
2. Notice Inviting Tender (NIT)
3. Price Bid
4. Technical Conditions of Contract
5. Special Conditions of Contract
6. General Conditions of Contract
7. Forms and Procedures

Should our Offer be accepted by BHEL for Award, I/we further agree to furnish 'Security Deposit' for the work as provided for in the Tender Conditions within the stipulated time as may be indicated by BHEL.

I/We further agree to execute all the works referred to in the said Tender documents upon the terms and conditions contained or referred to therein and as detailed in the appendices annexed thereto.

I/We have deposited/depositing herewith the requisite Earnest Money Deposit (EMD) as per details furnished in the Check List.

Authorized Representative of Bidder

Signature :

Name :

Address :

Place:

Date:

FORMS & PROCEDURES

Tender No: BHEL: MSTPP: C- RW: CSD: 22:10:06

Form No: F-02 (Rev 00)

DECLARATION BY AUTHORIZED SIGNATORY OF BIDDER

(To be typed and submitted in the Letter Head of the Company/Firm of Bidder)

To,

(Write Name & Address of Officer of BHEL inviting the Tender)

Dear Sir,

Sub : **Declaration by Authorized Signatory**

Ref : 1) NIT/Tender Specification No:,
2) All other pertinent issues till date

I/We, hereby certify that all the information and data furnished by me with regard to the above Tender Specification are true and complete to the best of my knowledge. I have gone through the specifications, conditions, stipulations and all other pertinent issues till date, and agree to comply with the requirements and Intent of the specification.

I further certify that I am authorized to represent on behalf of my Company/Firm for the above mentioned tender and a valid Power of Attorney to this effect is also enclosed.

Yours faithfully,

(Signature, Date & Seal of Authorized
Signatory of the Bidder)

Date:

Enclosed : Power of Attorney

FORMS & PROCEDURES

Tender No: BHEL: MSTPP: C- RW: CSD: 22:10:06

Form No: F-03 (Rev 00)

NO DEVIATION CERTIFICATE

(To be typed and submitted in the Letter Head of the Company/Firm of Bidder)

To,

(Write Name & Address of Officer of BHEL inviting the Tender)

Dear Sir,

Sub : **No Deviation Certificate**

Ref : 1) NIT/Tender Specification No:,
2) All other pertinent issues till date

We hereby confirm that we have not changed/ modified/materially altered any of the tender documents as downloaded from the website/ issued by BHEL and in case of such observance at any stage, it shall be treated as null and void.

We also hereby confirm that we have neither set any Terms and Conditions and nor have we taken any deviation from the Tender conditions together with other references applicable for the above referred NIT/Tender Specification.

We further confirm our unqualified acceptance to all Terms and Conditions, unqualified compliance to Tender Conditions, Integrity Pact (if applicable) and acceptance to Reverse Auctioning process.

We confirm to have submitted offer in accordance with tender instructions and as per aforesaid references.

Thanking you,

Yours faithfully,

(Signature, date & seal of authorized representative of the bidder)

FORMS & PROCEDURES

Tender No: BHEL: MSTPP: C- RW: CSD: 22:10:06

Form No: F-04 (Rev 00)

DECLARATION CONFIRMING KNOWLEDGE ABOUT SITE CONDITIONS
(To be typed and submitted in the Letter Head of the Company/Firm of Bidder)

To,

(Write Name & Address of Officer of BHEL inviting the Tender)

Dear Sir,

Sub : **Declaration confirming knowledge about Site conditions**

Ref : 1) NIT/Tender Specification No:,

2) All other pertinent issues till date

I/We, _____ hereby declare and confirm that we have visited the Project Site as referred in BHEL Tender Specifications and acquired full knowledge and information about the Site conditions including Wage structure, Industrial Climate, the Law & Order and other conditions prevalent at and around the Site. We further confirm that the above information is true and correct and we shall not raise any claim of any nature due to lack of knowledge of Site conditions.

I/We, hereby offer to carry out work as detailed in above mentioned Tender Specification, in accordance with Terms & Conditions thereof.

Yours faithfully,

(Signature, Date & Seal of Authorized
Representative of the Bidder)

Date :

Place:

FORMS & PROCEDURES

Tender No: BHEL: MSTPP: C- RW: CSD: 22:10:06

Form No: F-05 (Rev 00)

DECLARATION FOR RELATION IN BHEL

(To be typed and submitted in the Letter Head of the Company/Firm of Bidder failing which the offer of Bidder is liable to be summarily rejected)

To,

(Write Name & Address of Officer of BHEL inviting the Tender)

Dear Sir,

Sub : **Declaration for relation in BHEL**

Ref : 1) NIT/Tender Specification No:,

I/We hereby submit the following information pertaining to relation/relatives of Proprietor/Partner(s)/Director(s) employed in BHEL

Tick(✓) any one as applicable:

1. The Proprietor, Partner(s), Director(s) of our Company/Firm DO NOT have any relation or relatives employed in BHEL
OR
2. The Proprietor, Partner(s), or Director(s) of our Company/Firm HAVE relation/relatives employed in BHEL and their particulars are as below:
 - (i)
 - (ii)

Signature of the Authorized Signatory

Note:

1. Attach separate sheet, if necessary.
2. If BHEL Management comes to know at a later date that the information furnished by the Bidder is false, BHEL reserves the right to take suitable against the Bidder/Contractor.

FORMS & PROCEDURES

Tender No: BHEL: MSTPP: C- RW: CSD: 22:10:06

Form No: F-06 (Rev 00)

NON DISCLOSURE CERTIFICATE

(To be typed and submitted in the Letter Head of the Company/Firm of Bidder)

NON-DISCLOSURE CERTIFICATE

I/We understand that BHEL PS___is committed to Information Security Management System as per their Information Security Policy.

Hence, I/We M/s.....
who are submitting offer for providing services to BHEL PS___against
Tender Specification No:_____,
hereby undertake to comply with the following in line with Information
Security Policy of BHEL PS____, _____

- To maintain confidentiality of documents & information which shall be used during the execution of the Contract.
- The documents & information shall not be revealed to or shared with third party which shall not be in the business interest of BHEL PS___.

(Signature, date & seal of Authorized Signatory of the bidder)

Date:

FORMS & PROCEDURES

Tender No: BHEL: MSTPP: C- RW: CSD: 22:10:06

Form No: F-07 (Rev 00)

BANK ACCOUNT DETAILS FOR E-PAYMENT

(To be given on Letter head of the Company /Firm of Bidder, and **ENDORSED (SIGNED & STAMPED) BY THE BANK** to enable BHEL release payments through Electronic Fund Transfer (EFT/RTGS)

1. Beneficiary Name :

2. Beneficiary Account No. :

3. Bank Name & Branch :

4. City/Place :

5. 9 digit M ICR Code of Bank Branch :

6. IFSC Code of Bank Branch :

7. Beneficiary E-mail ID :
(for payment confirmation)

NOTE: In case Bank endorsed certificate regarding above has already been submitted earlier, Kindly submit photocopy of the same

FORMS & PROCEDURES

Tender No: BHEL: MSTPP: C- RW: CSD: 22:10:06

Form No: F-08 (Rev 00)

FORMAT FOR SEEKING CLARIFICATION

(To be typed and submitted in the Letter Head of the Company/Firm of Bidder)

To,

(Write Name & Address of Officer of BHEL inviting the Tender)

Dear Sir,

Sub : **Request for Clarification**

Ref : 1) NIT/Tender Specification No:,

2) All other pertinent issues till date

Sl no	Reference clause of Tender Document	Existing provision	Bidder's query	BHEL's clarification
1				
2				
3				

Yours faithfully,

(Signature, date & seal of Authorized Representative of the Bidder)

FORMS & PROCEDURES

Tender No: BHEL: MSTPP: C- RW: CSD: 22:10:06

Form No: F-09 (Rev 00)

CAPACITY EVALUATION OF BIDDERS FOR CURRENT TENDER

SL NO.	DESCRIPTION OF WORK (Similar to Tendered Scope)	WORK ORDER REF & DATE	CONTRACT VALUE (Rs. LACS)	CUSTOMER NAME & ADDRESS	CURRENT STATUS OF THE JOB ALONG WITH LATEST MILE STONE COMPLETED	%AGE OF WORK COMPLETED	VALUE OF BALANCE WORK (Rs. Lacs)
1							
2							
3							
4							
5							

NOTES:

1. BIDDERS ARE REQUIRED TO FURNISH ALL THE JOBS OF SIMILAR NATURE WHICH THEY ARE EXECUTING (IN PROGRESS) AT THE TIME OF SUBMISSION OF TENDER, AS PER ABOVE FORMAT.

2. BIDDERS HEREBY UNDERTAKE THAT THEY HAVE FURNISHED THE DETAILS SOUGHT AS PER POINT NO. 1 IN TOTALITY AND THAT THE DETAILS FURNISHED IS COMPLETE IN ALL RESPECT.

3. BHEL WILL TAKE APPROPRIATE ACTION AS DEEMED FIT , IN CASE, IT IS FOUND AT A LATER DATE THAT THE CONTRACTOR HAD SUPPRESSED THE FACTS AND HAVE NOT FURNISHED THE CORRECT & COMPLETE INFORMATION.

Signature

DATE :

PLACE:

Name, Designation & Seal of Bidder

FORMS & PROCEDURES

Tender No: BHEL: MSTPP: C- RW: CSD: 22:10:06

CONTRACT AGREEMENT

Form No: F-10 (Rev 00)

BHARAT HEAVY ELECTRICALS LIMITED
(A Government of India Undertaking)
Power Sector Region

CONTRACT AGREEMENT

AGREEMENT NO. _____

NAME OF WORK	
NAME OF THE CONTRACTOR WITH FULL ADDRESS	
VALUE OF WORK AWARDED	
LETTER OF INTENT NO.	
TIME ALLOTTED FOR COMPLETING THE WORK (DATE OF COMPLETION)	

SIGNATURE OF CONTRACTOR

(SIGNATURE OF BHEL OFFICER)



FORMS & PROCEDURES

Tender No: BHEL: MSTPP: C- RW: CSD: 22:10:06

CONTRACT AGREEMENT

THIS AGREEMENT MADE THIS _____ DAY OF _____ between BHARAT HEAVY ELECTRICALS LIMITED (A Government of India Enterprise) a Company incorporated under the Companies Act, 1956, having its Registered Office at BHEL House, Siri Fort New Delhi- 110049 (herein after called BHEL) of the ONE PART.

AND

M/S _____
_____ (hereinafter called the `Contractor') of t he SECOND PART.

WHEREAS M/s _____ state that they have acquired and possess extensive experience in the field of _____

And Whereas in response to an Invitation to Tender No _____ issued by BHEL for execution of _____ the contractor submitted their offer No.- _____ dated _____ And whereas BHEL has accepted the offer of the Contractor on terms and conditions specified in the Letter of Intent No. _____ dated _____ read with the references cited therein.

THIS AGREEMENT WITNESSES AND it is hereby agreed by and between the parties as follows:

1. That the contractor shall execute the work of _____ and more particularly described in Tender Specification No _____ including Drawings and Specifications (hereinafter called the said works) in accordance with and subject to terms and conditions contained in these presents, instructions to Tenderers, General Conditions of Contract, Special Conditions, Annexures, Letter of Intent dated _____ and such other instructions, Drawings, Specifications given to him from time to time by BHEL.
2. The Contractor is required to furnish to BHEL Security deposit in the form of cash/ approved securities/ Bank Guarantee valid upto _____ for a sum of Rs. _____ towards satisfactory performance and completion of the Contract.
3. The Contractor has furnished a Bank Guarantee bearing no. _____ dated _____ for a sum of Rs. _____ executed by _____ in favor of BHEL towards Security Deposit valid upto _____

OR

The Contractor has furnished to BHEL an initial Security Deposit of Rs _____ in the form of cash / approved Securities/ B.G No. _____ dated _____ for Rs. _____ executed by _____ in favor of BHEL valid upto _____ and has agreed for recovery of the balance security deposit by BHEL @ 10% of the value of work done from each running bill till the entire Security Deposit is recovered.

OR

FORMS & PROCEDURES

Tender No: BHEL: MSTPP: C- RW: CSD: 22:10:06

The contractor has furnished to BHEL an initial Security Deposit of Rs.----(Rs.----- vide Bank draft No.-----dated -----and by adjusting EMD of Rs.----- submitted vide Bank draft No.----- dt-----) and has agreed for recovery of balance Security Deposit by BHEL @ 10% of the value of work done from each running bill till the entire security deposit is recovered.

4. The Contractor hereby agrees to extend the validity of the Bank Guarantee for such further period or periods as may be required by BHEL and if the Contractor fails to obtain such extension(s) from the Bank, the Contractor, shall pay forthwith or accept recovery of Rs.----- from the bills in one installment and the contractor further agrees that failure to extend the validity of the Bank Guarantee or failure to pay the aforesaid amount in the manner specified above shall constitute breach of contract. In addition to above, BHEL shall be entitled to take such action as deemed fit and proper for recovering the said sum of Rs.-----

OR

In case the contractor furnishes the bank guarantee at a later date the contractor hereby agrees to extend the validity of bank guarantee for such further period or periods as may be required by BHEL and if the contractor fails to obtain such extension(s) from the bank, the contractor shall pay forthwith or accept recovery of the amount of bank guarantee given in lieu of security deposit from the bills in one installment and the contractor further agrees that failure to extend the validity of bank guarantee or failure to pay the aforesaid amount in the manner specified above shall constitute breach of contract. In addition to above, BHEL shall be entitled to take such action as deemed fit and proper for recovering the said sum.

5. That in consideration of the payments to be made to the Contractor by BHEL in accordance with this Agreement the Contractor hereby covenants and undertakes with BHEL that they shall execute, construct, complete the works in conformity, in all respect, with the terms and conditions specified in this Agreement and the documents governing the same.
 6. That the Contractor shall be deemed to have carefully examined this Agreement and the documents governing the same and also to have satisfied himself as to the nature and character of the Works to be executed by him.
 7. That the Contractor shall carry out and complete the execution of the said works to the entire satisfaction of the Engineer or such other officer authorized by BHEL, within the agreed time schedule, the time of completion being the essence of the Contract.
 8. That BHEL shall, after proper scrutiny of the bills submitted by the Contractor, pay to him during the progress of the said works such sum as determined by BHEL in accordance with this Agreement.
 9. That this Agreement shall be deemed to have come into force from ----- the date on which the letter of intent has been issued to the Contractor.
-

FORMS & PROCEDURES

Tender No: BHEL: MSTPP: C- RW: CSD: 22:10:06

- 10. That whenever under this contract or otherwise, any sum of money shall be recoverable from or payable by the Contractor, the same may be deducted in the manner as set out in the General Conditions of Contract or other conditions governing this Agreement.
- 11. That all charges on account of Octroi, Terminal and other taxes including sales tax or other duties on material obtained for execution of the said works shall be borne and paid by the Contractor.
- 12. That BHEL shall be entitled to deduct from the Contractor's running bills or otherwise Income Tax under Section 194 (C) of the Income Tax Act, 1961.
- 13. That BHEL shall be further entitled to recover from the running bills of the Contractor or otherwise such sum as may be determined by BHEL from time to time in respect of consumables supplied by BHEL, hire charges for tools and plants issued (Where applicable) and any other dues owed by the Contractor.
- 14. That it is hereby agreed by and between the parties that non-exercise, forbearance or omission of any of the powers conferred on BHEL and /or any of its authorities will not in any manner constitute waiver of the conditions hereto contained in these presents and the liability of the Contractor with respect to compensation payable to BHEL or Contractor's obligations shall remain unaffected.
- 15. It is clearly understood by and between the parties that in the event of any conflict between the Letter of Intent and other documents governing this Agreement, the provisions in the Letter of Intent shall prevail.

16. The following documents

1. Invitation to Tender No-----
and the documents specified therein.

2. Contractor's Offer No.....
dated-----.

3. _____

4. _____

5. _____

6. Letter of Intent No_____dated_____.

7. _____

shall also form part of and govern this Agreement.

IN WITNESS HEREOF, the parties hereto have respectively set their signatures in the presence of

WITNESS

(CONT

RACTOR)

FORMS & PROCEDURES

Tender No: BHEL: MSTPP: C- RW: CSD: 22:10:06

1. (to be signed by a person holding
a valid Power of Attorney)

2.

WITNESS (For and on behalf of BHEL)

1.

2.

FORMS & PROCEDURES

Tender No: BHEL: MSTPP: C- RW: CSD: 22:10:06

PROFORMA OF BANK GUARANTEE (in lieu of SECURITY DEPOSIT)

In consideration of the Bharat Heavy Electricals Limited (hereinafter referred to as the 'Employer' which expression shall unless repugnant to the context or meaning thereof, include its successors and permitted assigns) incorporated under the Companies Act, 1956 and having its registered office at BHEL House, Siri Fort, Asiad, New Delhi – 110049 through its Unit at Bharat Heavy Electricals Limited, Power Sector Eastern Region, BHEL Bhawan, Plot No 9/1, DJ Block, Sector-II, Salt lake City, Kolkata – 700091 having agreed to exempt (Name of the Vendor / Contractor / Supplier) having its registered office at _____¹ (hereinafter called the said Contractor which term includes supplier), from demand under the terms and conditions of the Contract reference No. _____² dated _____² valued at Rs.² (Rupees -----)² for <Nature of the Work>³ (hereinafter called the said Contract) of Security Deposit for the due fulfilment by the said contractor of the terms and conditions contained in the said Contract, on production of a Bank Guarantee for Rs. _____⁴ (Rupees _____ only), we _____ (indicate the name and address of the Bank) having its Head Office at _____ (address of the head Office) (hereinafter referred to as the Bank) at the request of _____ [Name of Contractor(s)] do hereby undertake to pay to the Employer an amount not exceeding Rs. _____ in the event of any breach by the said Contractor(s) of any of the terms and conditions contained in the said Contract.

We, _____ (indicate the name of the Bank), do hereby undertake to pay the amounts due and payable under this guarantee without any demur, merely on a demand from the Employer. Any such demand made on the bank, shall be conclusive as regards the amount due and payable by the Bank under this guarantee. However, our liability under this guarantee shall be restricted to an amount not exceeding Rs. _____.

We undertake to pay to the Employer any money so demanded notwithstanding any dispute or disputes raised by the Contractor(s) in any suit or proceeding pending before any Court or Tribunal relating thereto our liability under this present being absolute and unequivocal.

The payment so made by us under this guarantee shall be a valid discharge of our liability for payment hereunder and the Contractor(s) shall have no claim against us for making such payment.

FORMS & PROCEDURES

Tender No: BHEL: MSTPP: C- RW: CSD: 22:10:06

We, further agree that the guarantee herein contained shall remain in full force and effect during the period that would be taken for the performance of the said Contract and that it shall continue to be enforceable till all the dues of the Employer under or by virtue of the said Contract have been fully paid and its claim satisfied or discharged or till _____⁵ or till the office/Department/Division of Bharat Heavy Electricals Limited certifies that the terms and conditions of the said Contract have been fully and properly carried out by the said contractor(s) and also including the satisfactory performance of the equipment during guarantee period and accordingly discharges this guarantee. Unless a demand or claim under this guarantee is made on us in writing on or before the _____⁶, (3 months more than the present date of validity of Bank Guarantee) we shall be discharged from all the liability under this guarantee thereafter.

We, _____ (indicate the name of the Bank) _____ further agree with the Employer that the Employer shall have the fullest liberty without our consent and without affecting in any manner our obligations hereunder to vary any of the terms and conditions of the said Contract or to extend time of performance by the said contractor(s) from time to time or to postpone for any time or from time to time any of the powers exercisable by the Employer against the said contractor(s) and to forbear or enforce any of the terms and conditions relating to the said Contract and we shall not be relieved from our liability by any reason of any such variation or extension being granted to the said contractor(s) or for any forbearance, act or omission on the part of the Employer or any indulgence by the Employer to the said contractor(s) or by any such matter or thing whatsoever which under the law relating to sureties would but for this provision have effect of so relieving us.

This guarantee will not be discharged due to the change in the constitution of the Bank or the Contractor(s).

We,..... BANK lastly undertake not to revoke this guarantee during its currency except with the previous consent of the Employer in writing.

Notwithstanding anything to the contrary contained hereinabove:

- a) The liability of the Bank under this Guarantee shall not exceed.....⁷
- b) This Guarantee shall be valid up to⁸
- c) Unless the Bank is served a written claim or demand on or before _____⁹ (3 months more than the present date of validity of Bank Guarantee) all rights under this guarantee shall be forfeited and the Bank shall be relieved and discharged from all liabilities under this guarantee irrespective of whether or not the original bank guarantee is returned to the Bank.

We, _____ (indicate the name of the Bank) _____ lastly undertake not to revoke this guarantee during its currency except with the previous consent of the Employer in writing.

FORMS & PROCEDURES

Tender No: BHEL: MSTPP: C- RW: CSD: 22:10:06

Any claim or dispute arising under the terms of this document shall only be enforced or settled in the courts of at Kolkata only.

Date _____ Day of _____

for _____ (indicate the name of the Bank)

(Signature of Authorized signatory)

¹ NAME AND ADDRESS OF THE VENDOR /CONTRACTOR / SUPPLIER .

² DETAILS ABOUT THE NOTICE OF AWARD/CONTRACT REFERENCE

³ PROJECT/SUPPLY DETAILS

⁴ BG AMOUNT IN FIGURES AND WORDS

⁵ VALIDITY DATE

⁶ DATE OF EXPIRY OF CLAIM PERIOD

⁷ BG AMOUNT IN FIGURES AND WORDS.

⁸ VALIDITY DATE

⁹ DATE OF EXPIRY OF CLAIM PERIOD

Note:

1. Units are advised that expiry of claim period may be kept 2/3 months after validity date.

2. In Case of Bank Guarantees submitted by Foreign Vendors-

a. From Nationalized/Public Sector / Private Sector/ Foreign Banks (BG issued by Branches in India) can be accepted subject to the condition that the Bank Guarantee should be enforceable in the town/city or at nearest branch where the Unit is located i.e. Demand can be presented at the Branch located in the town/city or at nearest branch where the Unit is located.

b. From Foreign Banks (wherein Foreign Vendors intend to provide BG from local branch of the Vendor country's Bank)

b.1 In such cases, in the Tender Enquiry/ Contract itself, it may be clearly specified that Bank Guarantee issued by **any of the Consortium Banks only** will be accepted by BHEL. As such, Foreign Vendor needs to make necessary arrangements for issuance of Counter-Guarantee by Foreign Bank in favour of the Indian Bank (BHEL's Consortium Bank). It is advisable that all charges for issuance of Bank Guarantee/ counter- Guarantee should be borne by the Foreign Vendor. The tender stipulation should clearly specify these requirements.

FORMS & PROCEDURES

Tender No: BHEL: MSTPP: C- RW: CSD: 22:10:06

- b.2** In case, Foreign Vendors intend to provide BG from Overseas Branch of our Consortium Bank (e.g. if a BG is to be issued by SBI Frankfurt), the same is acceptable. However, the procedure at **sl.no. b.1** will required to be followed.
- b.3** The BG issued may preferably be subject to Uniform Rules for Demand Guarantees (URDG) 758 (as amended from time to time). In case, of Foreign Vendors, the BG Format provided to them should clearly specify the same.
- b.4** The BG should clearly specify that the demand or other document can be presented in electronic form.

FORMS & PROCEDURES

Tender No: BHEL: MSTPP: C- RW: CSD: 22:10:06

BANK GUARANTEE FOR ADVANCE

Bank Guarantee No:

Date:

To

NAME

& ADDRESSES OF THE BENEFICIARY

Dear Sirs,

In consideration of the Bharat Heavy Electricals Limited (hereinafter referred to as the 'Employer' which expression shall unless repugnant to the context or meaning thereof, include its successors and permitted assigns) incorporated under the Companies Act, 1956 and having its registered office at BHEL House, Siri Fort, Asiad, New Delhi – 110049 through its Unit at Bharat Heavy Electricals Limited, Power Sector Eastern Region, BHEL Bhawan, Plot No 9/1, DJ Block, Sector-II, Salt lake City, Kolkata – 700091 having awarded to (Name of the Vendor / Contractor / Supplier) having its registered office at _____¹ (hereinafter called "the Contractor" which expression shall include its successors and permitted assigns) a contract Ref No.....dated²valued at Rs.....(Rupees -----) for <Nature of Work> ³(hereinafter called the 'Contract')

AND WHEREAS the Employer has agreed to advance to the Contractor, a sum of Rs..... (Rupees..... only), equivalent to _____% of the said value of the Contract (hereinafter called "the said Advance"), upon the condition, that the said Advance shall be secured by undertaking guarantee for Rs ----- (Rupees -----)⁴ from a Bank as hereinafter appearing.

We,, (hereinafter referred to as the Bank), having registered/Head office at and a branch at being the Guarantor under this Guarantee, hereby irrevocably and unconditionally undertake to forthwith and immediately pay to the Employer without any demur, merely on your first demand any sum or sums upto a maximum amount but not exceeding Rs ----- (Rupees -----).

Any such demand made on the Bank shall be conclusive as regards the amount due and payable by the Bank under this guarantee. However, our liability under this guarantee shall be restricted to an amount not exceeding Rs. _____

FORMS & PROCEDURES

Tender No: BHEL: MSTPP: C- RW: CSD: 22:10:06

We undertake to pay to the Employer any money so demanded notwithstanding any dispute or disputes raised by the Contractor/ Supplier in any suit or proceeding pending before any Court or Tribunal relating thereto our liability under this present being absolute and unequivocal.

The payment so made by us under this Guarantee shall be a valid discharge of our liability for payment hereunder and the Contractors/Supplier shall have no claim against us for making such payment.

We the.....Bank further agree that the guarantee herein contained shall remain in full force and effect during the period that would be taken for the performance of the said Contract and that it shall continue to be enforceable till all the dues of the Employer under or by virtue of the said Contract have been fully paid and its claims satisfied or discharged.

We Bank further agree that the Employer shall have the fullest liberty without our consent and without affecting in any manner our obligations hereunder to vary any of the terms and conditions of the said Contract or to extend time of performance by the said Contractor/Supplier from time to time or to postpone for any time or from time to time any of the powers exercisable by the Employer against the said Contractor/Supplier and to forbear or enforce any of the terms and conditions relating to the said Agreement and we shall not be relieved from our liability by reason of any such variation, or extension being granted to the said Contractor/Supplier or for any forbearance, act or omission on the part of the Employer or any indulgence by the Employer to the said Contractor/Supplier or by any such matter or thing whatsoever which under the law relating to sureties would but for this provision have effect of so relieving us.

The Bank also agrees that the Employer at its option shall be entitled to enforce this Guarantee against the Bank as a principal debtor, in the first instance without proceeding against the Contractor and notwithstanding any security or other guarantee that the Employer may have in relation to the Contractor's liabilities.

This Guarantee shall remain in force upto and including.....⁵ and shall be extended from time to time on the request of the Employer for such period as may be desired by the Employer.

This Guarantee shall not be determined or affected by liquidation or winding up, dissolution or change of constitution or insolvency of the Contractor/Supplier but shall in all respects and for all purposes be binding and operative until payment of all money payable to the Employer in terms hereof. However, unless a demand or claim under this Guarantee is made on us in writing on or before the⁶ (3 months more than the present date of validity of Bank Guarantee) we shall be discharged from all liabilities under this Guarantee.

FORMS & PROCEDURES

Tender No: BHEL: MSTPP: C- RW: CSD: 22:10:06

We, BANK lastly undertake not to revoke this guarantee during its currency except with the previous consent of the Employer in writing.

Notwithstanding anything to the contrary contained hereinabove:

- a) The liability of the Bank under this Guarantee shall not exceed.....⁷
- b) This Guarantee shall be valid up to⁸
- c) Unless the Bank is served a written claim or demand on or before.....⁹ (3 months more than the present date of validity of Bank Guarantee) all rights under this guarantee shall be forfeited and the Bank shall be relieved and discharged from all liabilities under this guarantee irrespective of whether or not the original bank guarantee is returned to the Bank

We,.....Bank, have power to issue this Guarantee under law and the undersigned as a duly authorized person has full powers to sign this Guarantee on behalf of the Bank.

Any claim or dispute arising under the terms of this document shall only be enforced or settled in the courts of at Kolkata only.

For and on behalf of
(Name of the Bank)

Date.....

Place of Issue.....

¹ NAME OF VENDOR /CONTRACTOR / SUPPLIER

² DETAILS ABOUT THE NOTICE OF AWARD/CONTRACT REFERENCE

³ PROJECT/SUPPLY DETAILS

⁴ BG AMOUNT IN FIGURES AND WORDS

⁵ VALIDITY DATE

⁶ DATE OF EXPIRY OF CLAIM PERIOD

⁷ BG AMOUNT IN FIGURES AND WORDS

⁸ VALIDITY DATE

⁹ DATE OF EXPIRY OF CLAIM PERIOD

Note:

FORMS & PROCEDURES

Tender No: BHEL: MSTPP: C- RW: CSD: 22:10:06

1. Units are advised that expiry of claim period may be kept 2/3 months after validity date.
2. In Case of Bank Guarantees submitted by Foreign Vendors-
 - a. **From Nationalized/Public Sector / Private Sector/ Foreign Banks (BG issued by Branches in India)** can be accepted subject to the condition that the Bank Guarantee should be enforceable in the town/city or at nearest branch where the Unit is located i.e. Demand can be presented at the Branch located in the town/city or at nearest branch where the Unit is located.
 - b. **From Foreign Banks (wherein Foreign Vendors intend to provide BG from local branch of the Vendor country's Bank)**
 - b.1 In such cases, in the Tender Enquiry/ Contract itself, it may be clearly specified that Bank Guarantee issued by **any of the Consortium Banks only** will be accepted by BHEL. As such, Foreign Vendor needs to make necessary arrangements for issuance of Counter- Guarantee by Foreign Bank in favour of the Indian Bank (BHEL's Consortium Bank). It is advisable that all charges for issuance of Bank Guarantee/ counter- Guarantee should be borne by the Foreign Vendor. The tender stipulation should clearly specify these requirements.
 - b.2 **In case, Foreign Vendors intend to provide BG from Overseas Branch of our Consortium Bank** (e.g. if a BG is to be issued by SBI Frankfurt), the same is acceptable. However, the procedure at **sl.no. b.1** will required to be followed.
 - b.3 The BG issued may preferably be subject to Uniform Rules for Demand Guarantees (URDG) 758 (as amended from time to time). In case, of Foreign Vendors, the BG Format provided to them should clearly specify the same.
 - b.4 The BG should clearly specify that the demand or other document can be presented in electronic form.

FORMS & PROCEDURES

Tender No: BHEL: MSTPP: C- RW: CSD: 22:10:06

Form No: F-13 (Rev 00)

FORM for EXTENSION OF VALIDITY OF BANK GUARANTEE

1. To be typed on non judicial Stamp Papers of value as applicable in the State of India from where the BG has been issued or the State of India where the BG shall be operated
2. The non judicial stamp papers shall be purchased in the name of the Party on whose behalf the BG is being issued or the BG issuing Bank

BANK GUARANTEE No:

Date:.....

To

(Write Designation and Address of Officer of BHEL inviting the Tender)

Dear Sir

Sub : Validity of Bank Guarantee No:..... Dated for
..... Rs in favor of yourself, expiry date, on
account of M/s in respect of Contract
Number..... , (herein after called the Original bank Guarantee)

At the request of M/s....., we..... Bank, having its
branch Office at and having Head office at, do
hereby extend our liability under the above mentioned Bank Guarantee number... dated
..... for a further period ofMonths/years fromto expire on
.....

Except as provided above, all other terms and conditions of the Original Bank Guarantee No
..... Dated... shall remain unaltered and binding on us.

Kindly treat this extension as an integral part of the original Bank Guarantee to which it would be attached.

Yours faithfully

Signature.....

Name & Designation.....

Power of Attorney/Signing Power No

Seal of Bank

FORMS & PROCEDURES

Tender No: BHEL: MSTPP: C- RW: CSD: 22:10:06

Form No: F-15 (Rev 01)

MONTHLY PERFORMANCE EVALUATION OF CONTRACTOR

Project		Vendor			Package & Unit	
SL	Parameter for Measurement	Classification	Max Score	Score Obtained	Measurement Key/Scheduled date	Supporting Documents
#1.01	Cumulative number of days in the month, the nominated Quality Officer or his authorized nominee was not available	QUALITY	0.35		Quality Officer or his authorized nominee should be available for all the days	Daily Log Book entry/Incident Registers/letter references
#1.02	Shortfall in number of weekly Quality meetings in the month, not conducted or not attended by Quality officer or his authorized nominee	QUALITY	0.7		Quality meetings to be held every week	Daily Log Book entry/Incident Registers/letter references
#1.03	Level of compliance wrt decisions taken in previous Quality meetings	QUALITY	0.35		Number of consolidated issues discussed in Quality meetings	Daily Log Book entry/Incident Registers/letter references
#1.04	Number of batches of welding electrodes, cement, sand, aggregate, consumable, Paints etc. as applicable for which test certificates not submitted OR MM & MH pkg:) In case of MM & MH package, monthly checks	QUALITY	0.375		Total number of non compliances	Daily Log Book entry/Incident Registers/letter references
#1.05	Number of incidences of improper storage of inflammable gases and liquids, fuel etc.	QUALITY	0.35		Total number of non compliances	Daily Log Book entry/Incident Registers/letter references
#1.06	Total number of complaints in the month on non-preservation of materials under the custody of the contractor / erected in his scope.	QUALITY	0.35		Total number of non compliances	Daily Log Book entry/Incident Registers/letter references
#1.07	Cumulative number of days in the month delayed due to poor organization/planning of works at site.	QUALITY	0.625		Cumulative number of days delayed	Daily Log Book entry/Incident Registers/letter references
#1.08	Total number of rework instances in a month necessitated due to improper works/procedures by contractor	QUALITY	0.625		Total number of non compliances	Daily Log Book entry/Incident Registers/letter references
#1.09	Total number of complaints received in the month on the quality of finish / aesthetics	QUALITY	0.65		Total number of non compliances	Daily Log Book entry/Incident Registers/letter references
#1.10	Total number of instances in the month, Housekeeping NOT attended to in spite of instructions by BHEL -ie removal / disposal of surplus earth / debris / scrap / unused / surplus cable drums / other electrical items / surplus steel items / packing materials, thrown out scrap like weld butts, cotton waste etc. from the working area to identified locations	QUALITY	0.625		Total number of non compliances	Daily Log Book entry/Incident Registers/letter references

FORMS & PROCEDURES

Tender No: BHEL: MSTPP: C- RW: CSD: 22:10:06

#2.01	Number of times the workplan submitted FOR THE NEXT MONTH is REJECTED for not being supported with proper T&P (major) and Manpower.	PERFORMANCE	3.47		Number of rejections	Daily Log Book entry/Incident Registers/letter references
#2.02	Number of times the Work plan (unloading and storage plans in case of MM & MH packages) is not supported by relevant construction/layout drawings - like A4 plan / elevation views of plan status for structures / pressure parts/Civil Works, Piping isometrics for piping, Layout / PID / System reference sketch, Unloading/storage plans etc as applicable for the works planned	PERFORMANCE	3.47		Total number of non compliances	Daily Log Book entry/Incident Registers/letter references
#2.03	Cumulative number of days of delay in submission of plan FOR THE NEXT MONTH supported by deployment plan of Major T&Ps and Manpower (as per C-1 & C-2 of Format F-14)	PERFORMANCE	1.73		Number of days delayed/Scheduled date is first working day of next month	Daily Log Book entry/Incident Registers/letter references
#2.04	Percentage of delayed submission of Daily Reports for Progress, Labor etc	PERFORMANCE	1.87		Percentage of daily reports delayed/Scheduled date is each day for the previous day	Daily Log Book entry/Incident Registers/letter references
#2.05	Number of days delayed for submission of log sheets / protocols / Monthly Progress reports for the work executed during the month under measurement	PERFORMANCE	0.93		Number of days delayed/Scheduled date is first working day of next month	Daily Log Book entry/Incident Registers/letter references
#2.06	Shortfall attributable to contractor as a percentage of what is clearly executable (In line with Terms of payment) by contractor as per the plan (part-A of F-14) for the subject month	PERFORMANCE	20.67		Percentage calculated as per part-A of F-14	Progress review formats
#2.07	Cumulative number of days in the month for which feedback/briefing on plans for the day and the progress of previous day was not given to BHEL	PERFORMANCE	2.67		Cumulative number of days for which briefing or feedback not given/each day for the previous day	Daily Log Book entry/Incident Registers/letter references
#2.08	Cumulative number of major instances in the month hampering/affecting progress of work due to improper management of labor and T&P at site leading to slowed progress of work or extended the completion of works	PERFORMANCE	3.47		Cumulative number of days lost	Daily Log Book entry/Incident Registers/letter references
#2.09	Cumulative number of days of work lost due to interface issues with fellow contractors/ customers leading to stoppage / delay in works, attributable to the contractor	PERFORMANCE	1.73		Cumulative number of days lost	Daily Log Book entry/Incident Registers/letter references
#2.10	Number of times the commitments on augmentation of resources as per plan for the month have slipped	PERFORMANCE	3.47		Total number of non compliances	Daily Log Book entry/Incident Registers/letter references
#2.11	Number of days the submission of Running bills for the month are delayed	PERFORMANCE	0.93		Number of days delayed/Scheduled date is first working day of next month	Daily Log Book entry/Incident Registers/letter references

FORMS & PROCEDURES

Tender No: BHEL: MSTPP: C- RW: CSD: 22:10:06

#2.12	Number of days the supporting documents for the Running bills submitted for the month are delayed	PERFORMANCE	0.93		Number of days delayed/Scheduled date is first working day of next month	Daily Log Book entry/Incident Registers/letter references
#2.13	Number of times updating were not carried out in maintenance of records in PCin a form approved by BHEL at site (as applicable for respective packages).	PERFORMANCE	1.33		Cumulative number of days updation not carried out/	Daily Log Book entry/Incident Registers/letter references
#2.14	Number of times the Top Management of contractor did not respond to critical issues of site, for the month	PERFORMANCE	3.47		Total number of non compliances	Daily Log Book entry/Incident Registers/letter references
#2.15	Number of refusals for improvement/remedial measures suggested by BHEL	PERFORMANCE	0.67		Total number of non compliances	Daily Log Book entry/Incident Registers/letter references
#2.16	Cumulative number of days in the month the works were stopped / refused on interpretation of contract clauses/scope due to tendency of taking undue advantage by interpreting contract clauses in their favor	PERFORMANCE	2.67		Cumulative number of days lost	Daily Log Book entry/Incident Registers/letter references
#2.17	Number of times rework refused	PERFORMANCE	1.73		Total number of non compliances	Daily Log Book entry/Incident Registers/letter references
#2.18	Cumulative number of days in the month recording/logging was not done in daily log/ history register / hindrance register maintained at BHEL Site Office	PERFORMANCE	1.33		Cumulative number of days recording or logging was not done/all days of the month	Daily Log Book entry/Incident Registers/letter references
#2.19	Erection Agency: Cumulative number of major instances in the month hampering/affecting progress of work due to delayed or non-deployment of separate gang for material handling works OR MM Agency: Cumulative number of major instances in the month hampering/affecting erection work due to not identifying or not locating or not retrieving of materials required by erection agency	PERFORMANCE	3.47		Cumulative number of days lost	Daily Log Book entry/Incident Registers/letter references
#3.01	Number of days of delay in submission of PLAN vis a vis ACTUAL deployment of Manpower for the month under review (as per part B-2 of F-014)	RESOURCES	1.5		Number of days delayed/ Scheduled date is first working day of next month	Daily Log Book entry/Incident Registers/letter references
#3.02	Number of days of non-availability of supporting staff at office for submission of required reports/documentation as required for the contract	RESOURCES	1.5		Cumulative number of days supporting staff not available	Daily Log Book entry/Incident Registers/letter references
#3.03	Number of days of delay in submission of PLAN vs ACTUAL deployment of major T&P for the month under review (as per B-1 of F-14)	RESOURCES	2.5		Number of days delayed/Scheduled date is first working day of next month	Daily Log Book entry/Incident Registers/letter references
#3.04	Cumulative number of major instances in the month hampering/affecting progress of work due to non availability of operator / fuel in contractor's scope for Major T&P and MME	RESOURCES	2.5		Cumulative number of days lost	Daily Log Book entry/Incident Registers/letter references

FORMS & PROCEDURES

Tender No: BHEL: MSTPP: C- RW: CSD: 22:10:06

#3.05	Cumulative number of major instances in the month hampering/affecting progress of work due to breakdown or non availability of major T&P and MME for the work	RESOURCES	2.5		Cumulative number of days lost	Daily Log Book entry/Incident Registers/letter references
#3.06	Cumulative number of major instances in the month hampering/affecting progress of work due to non-availability of proper T&P/MME (number, capacity adequacy, and working condition) under the scope of contractor	RESOURCES	2.5		Cumulative number of days lost	Daily Log Book entry/Incident Registers/letter references
#3.07	Number of times Contractor's T&P (items common to BHEL and Contractor) was NOT made available before requesting for the same T&P from BHEL	RESOURCES	2.5		Total number of requests from contractor	Daily Log Book entry/Incident Registers/letter references
#3.08	Cumulative number of major instances in the month hampering/affecting progress of work due to non-availability of Consumables under the scope of contractor	RESOURCES	2.5		Cumulative number of days lost	Daily Log Book entry/Incident Registers/letter references
#3.09	Cumulative number of days in the month lost due to use of improper consumables like electrodes, gases, Cement, sand, etc as applicable	RESOURCES	2		Cumulative number of days lost	Daily Log Book entry/Incident Registers/letter references
#4.01	Number of deviations from the site organization report submitted initially wrt deployment for the current month affecting work progress.	SITE INFRASTRUCTURE & SERVICE	0.94		Total number of non compliances	Daily Log Book entry/Incident Registers/letter references
#4.02	Cumulative number of days in the month lost due to delayed renewal in respect of Labor license, Insurance, electrical license, factory inspector etc. as applicable	SITE INFRASTRUCTURE & SERVICE	0.94		Cumulative number of days lost	Daily Log Book entry/Incident Registers/letter references
#4.03	Number of non-compliances of Statutory requirements like validity of Labor License, Labor Insurance, PF, etc and any other applicable Regulation	SITE INFRASTRUCTURE & SERVICE	0.5		Total number of non compliances	Daily Log Book entry/Incident Registers/letter references
#4.04	Cumulative number of days in a month poor illumination is reported at storage area, erection area, pre-assy area and other designated areas by BHEL site.	SITE INFRASTRUCTURE & SERVICE	0.44		Total number of non compliances/random checks	Daily Log Book entry/Incident Registers/letter references
#4.05	Number of days of non-availability of well maintained toilets facilities for workers (separate for men and women)	SITE INFRASTRUCTURE & SERVICE	0.44		Total number of non compliances/random checks	Daily Log Book entry/Incident Registers/letter references
#4.06	Number of days of non-availability of potable drinking water stations for workers in specified areas.	SITE INFRASTRUCTURE & SERVICE	0.44		Total number of non compliances/random checks	Daily Log Book entry/Incident Registers/letter references

FORMS & PROCEDURES

Tender No: BHEL: MSTPP: C- RW: CSD: 22:10:06

#4.07	If applicable as per contract, Provision of Water meter for each point of distribution and cumulative number of days of non-submission of water consumption / non-working of water meter	SITE INFRASTRUCTURE & SERVICE	0.44		Total number of non compliances/random checks	Daily Log Book entry/Incident Registers/letter references
#4.08	Provision of Energy meter for each point of distribution and cumulative number of days of non-submission of energy consumption / non-working of energy meter	SITE INFRASTRUCTURE & SERVICE	0.44		Total number of non compliances/random checks	Daily Log Book entry/Incident Registers/letter references
#4.09	Commitment of Top Management of Contractor for welfare of labour	SITE INFRASTRUCTURE & SERVICE	0.44		Percentage of welfare activities done	Daily Log Book entry/Incident Registers/letter references
#5.01	Number of days delayed in making labour payments of the last month	SITE FINANCE	2.14		Number of days delayed/Scheduled date is 10th day of the month succeeding the month under reference	Daily Log Book entry/Incident Registers/letter references
#5.02	Number of complaints from sub supplier for non receipt of payments	SITE FINANCE	1.43		Total number of non compliances	Daily Log Book entry/Incident Registers/letter references
#5.03	Number of times the site operations are hampered for want of funds at the disposal of site-in-charge.	SITE FINANCE	1.43		Total number of non compliances	Daily Log Book entry/Incident Registers/letter references
#6.01	Cumulative number of days in a month the nominated Safety Officer or his authorised nominee is not available	HSE & SA	0.5		Safety Officer or his authorised nominee should be available for all the days	Daily Log Book entry/Incident Registers/letter references
#6.02	Shortfall in number of weekly safety meetings in the month conducted or attended by the Safety Officer or his authorised nominee	HSE & SA	0.25		Safety meetings to be held every week	Copy of Minutes of meeting
#6.03	Level of compliance wrt decisions taken in previous Safety meetings	HSE & SA	0.25		Number of consolidated issues discussed in Safety meetings	Daily Log Book entry/Incident Registers/letter references
#6.04	Delay in submission of monthly report on safety in the prescribed form	HSE & SA	0.25		Number of days delayed/Scheduled date is first working day of next month	Daily Log Book entry/Incident Registers/letter references
#6.05	Number of days taken for lodging FIRs from date of occurrence/notice of incident of theft / accident etc	HSE & SA	0.25		Number of days delayed/Scheduled date is the next date of occurrence/notice of incidence	Copy of FIR lodged by Contractor
#6.06	Number of times warnings issued for using scaffoldings other than steel	HSE & SA	0.25		Total number of non compliances	Daily Log Book entry/Incident Registers/letter references

FORMS & PROCEDURES

Tender No: BHEL: MSTPP: C- RW: CSD: 22:10:06

#6.07	Number of times punitive fines imposed for not complying with use of PPE	HSE & SA	0.375		Total number of non compliances	Non-compliance intimation documents from BHEL site
#6.08	Number of times punitive fines imposed for unsafe practices	HSE & SA	0.345		Total number of non compliances	Copy of fine intimation documents from BHEL site
#6.09	Delay in number of days in submission of monthly report on provisions, maintainance and validity of fire extinguishers	HSE & SA	0.25		Number of days delayed/Scheduled date is first working day of next month	Daily Log Book entry/Incident Registers/letter references
#6.10	Delay in number of days in submission of monthly report on provisions and maintenance of Electrical Safety for Equipments	HSE & SA	0.25		Number of days delayed/Scheduled date is first working day of next month	copy of report
#6.11	Delay in number of days in submission of monthly report on provisions and maintainance of proper ELCBs for Electrical Safety of Personnel.	HSE & SA	0.25		Number of days delayed/Scheduled date is first working day of next month	copy of report
#6.12	Number of times the agency has defaulted on display of safety posters / safety slogans / safety barriers/emergency numbers etc in identified areas	HSE & SA	0.25		Total number of non compliances	Non-compliance intimation documents from BHEL site
#6.13	Non compliances observed during HSE and Safety Audit	HSE & SA	0.25		Total number of non compliances	Daily Log Book entry/Incident Registers/letter references
#6.14	Cumulative number of days in the month, First Aid Kits were not maintained at designated places at site	HSE & SA	0.25		Cumulative number of days	Non-compliance intimation documents from BHEL site
#6.15	Cumulative number of days in the month, there was non-availability of Ambulance or Emergency vehicle (whichever applicable) at Site.	HSE & SA	0.25		Cumulative number of days Ambulance or Emergency vehicle not available	Daily Log Book entry/Incident Registers/letter references
#6.16	Number of days taken for submission of Root Cause analysis (RCA) for the accident /theft/ incidence from the cut off date intimated by BHEL for submission of RCA NOTE: Occurrences of last month to be accounted for in the evaluating month)	HSE & SA	0.25		Number of days delayed/Scheduled date is 7th day of occurrence or notice of incidence NOTE: Occurrences of last month to be accounted for in the evaluating month)	Daily Log Book entry/Incident Registers/letter references
#6.17	Cumulative number of days in the month Women labour were deployed for office or site works during night hours (anytime between 18.00 hrs to 08.00 hrs)	HSE & SA	0.25		Cumulative number of days	Daily Log Book entry/Incident Registers/letter references
#6.18	Cumulative number of days in the month children under the age of 18 years were deployed for office or site works	HSE & SA	0.25		Cumulative number of days	Daily Log Book entry/Incident Registers/letter references

Performance Score Summary for the Month	Total score	Score Obtained
QUALITY	5	

FORMS & PROCEDURES

Tender No: BHEL: MSTPP: C- RW: CSD: 22:10:06

PERFORMANCE	60	
RESOURCES	20	
SITE INFRASTRUCTURE & SERVICE	5	
SITE FINANCE	5	
HSE & SA	5	
OTHERS	0	
TOTAL	100	0

FORMS & PROCEDURES

Tender No: BHEL: MSTPP: C- RW: CSD: 22:10:06

Form No: F-19 (Rev 00)

MILESTONE COMPLETION CERTIFICATE
(issued by BHEL on the specific request of Contractor)

Ref :

Date:

To,

(Name & address of Contractor)

Dear Sir,

References

1. Contract No:
2. Job Description:

This is to hereby confirm that the following Milestone Activity has been achieved in respect of the Contract /Job under reference

Sl No	Milestone Activity	Remarks

This certificate is issued as per your request vide letter no
without any prejudice to the rights of BHEL in line with the terms and conditions of the
above referred Contract

Yours faithfully,

For and on behalf of Bharat Heavy Electricals Limited

Construction Manager/Head (Subcontracts)

FORMS & PROCEDURES

Tender No: BHEL: MSTPP: C- RW: CSD: 22:10:06

Form No: F-20 (Rev 01)

CONTRACT COMPLETION CERTIFICATE
(Issued by BHEL/HQ on the specific request of Contractor)

Ref :

Date:

To Whom so ever it may concern

1	DESCRIPTION OF WORK	
2	NAME AND ADDRESS OF THE CONTRACTOR	
3	CONTRACT NO	
4	CONTRACT VALUE	
5	LETTER OF INTENT NO & DATE	
6	CONTRACT PERIOD//CONTRACT DURATION	
7	DATE OF START/COMPLETION	
8	FINAL EXECUTED VALUE	
9	PERFORMANCE	GOOD SATISFACTORY UNSATISFACTORY

This certificate is issued as per your request vide letter no
without any prejudice to the rights of BHEL to use this certificate for evaluation of your offers for future tenders

Yours faithfully,

For and on behalf of Bharat Heavy Electricals Limited

Head (Subcontracts)

FORMS & PROCEDURES

Tender No: BHEL: MSTPP: C- RW: CSD: 22:10:06

Form No: F-21 (Rev 00)

INDEMNITY BOND

(To be executed on a Non Judicial Stamp Paper of the requisite value as per Stamp Duty prevalent in the respective State)

This Indemnity Bond executed by <name of company> having their Registered Office at <xxxxxxxxxxxx> in favour of M/s Bharat Heavy Electricals Limited, a Company incorporated under the Companies Act, 1956, having its Registered Office at BHEL House, Siri Fort, Asiad, New Delhi - 110049 through its Unit at Power Sector _____ Region, _____ State. (Hereinafter referred to as the Company)

And whereas the Company has entered into a Contract with M/s xxxxxxxx, the executants of this Deed (hereinafter referred to as the Contractor) as its contractor in respect of the work of "xxxxxxxxxxxxxxxxxxxxxxxxxxxx".

AND WHEREAS under the provisions of GCC further stipulates that the Contractor shall indemnify the Company against all claims of whatever nature arising during the course of execution of Contract including defects liability period of <xx Months > i.e till <xx xx xxxx>

Now this deed witnesses that in case the Company is made liable by any Authority including Court to pay any claim or compensation etc. in respect of all labourers or other matters at any stage under or relating to the Contract with the Contractor, the Contractor hereby covenants and agrees with the Company that they shall indemnify and reimburse the Company to the extent of such payments and for any fee, including litigation charges, lawyers' fees, etc, penalty or damages claimed against the Company by reason of the Contractor falling to comply with Central/States Laws, Rules etc, or his failure to comply with Contract (including all expenses and charges incurred by the Company).

The Contractor further indemnifies the Company for the amount which the Company may be liable to pay by way of penalty for not making deductions from the Bills of the Contractor towards such amount and depositing the same in the Government Treasury.

FORMS & PROCEDURES

Tender No: BHEL: MSTPP: C- RW: CSD: 22:10:06

The Contractor further agree that the Company shall be entitled to with hold and adjust the Security Deposit and/or with ho ld and adjust payment of Bills of Contractor per taining to this Contract against any payme nt which the Company has made or is required to mak e for which the Contractor is liab le under the Contract and that such amount can be w ithheld, adjusted by the Company till satisfactory and final settlement of all pending matters and the Contractor hereby gives his consent for the same.

The Contractor further agrees that the terms of indemnity shall s urvive the ter mination or completion of this contract.

The contractor further agrees that the liability of the contractor shall be extended on actual basis notwithstanding the limitations of liability clause, in respect of :

1. breach of terms of contract by the contractor
2. breach of laws by the contractor
3. breach of Intellectual property rights by the contractor
4. breach of confidentiality by the contractor

Nothing contained in this deed, shall be construed as absolving or limiting the liability of the Contractor under said Contract between the Company and the Contractor . That this Indemnity Bond is irrevocable and the condition of the bond is that the Contractor shall duly and punctually c omply with the terms and the conditions of this deed and contractu al provisions to the satisfaction of the Company.

In witness where of M/s xxxxxxxxxxxxxx these presents on the day, month and year first, above written at xxxxxxxx by the hand of its signatory Mr. xxxxxxxxxxxx.

Signed for and on behalf of
M/s xxxxxxxxxxxxxxxxxxxx

Witness:

- 1
 - 2
-

FORMS & PROCEDURES

Tender No: BHEL: MSTPP: C- RW: CSD: 22:10:06

Form No: F-22 (Rev 00)

CONSORTIUM AGREEMENT

(To be executed on Rs. 50/- Non – Judicial Stamp Paper)

THIS AGREEMENT is made and executed on this _____ day of _____, by and between (1) M/s _____, (The First Party, i.e, the Bidder) a company incorporated under the Company's Act 1956, having its registered office at _____ (herein after called the "Bidder", which expression shall include its' successors, administrators, executors and permitted assigns) and (2) M/s _____, (The Second Party, i.e, the associates), a company incorporated under the Company's Act 1956, having its registered office at _____ (herein after called the " Associates", which expression shall include its' successors, administrators, executors and permitted assigns).

WHEREAS the Owner, Bharat Heavy Electricals Ltd, a Government of India Undertaking, proposes to issue / issued an NIT (herein after referred to as the said NIT) inviting bids from the individual Bidders for undertaking the work _____ of _____ at _____ (herein after referred to as the said works).

WHEREAS the said NIT enables submission of a bid by a Consortium subject to fulfillment of the stipulations specified in the said NIT.

AND WHEREAS M/s _____ (The First Party, i.e, the Bidder) will submit its proposal in response to the aforesaid invitation to _____ bid by the Owner for _____ as detailed in the Bid doc. no. < TENDER REF >

FORMS & PROCEDURES

Tender No: BHEL: MSTPP: C- RW: CSD: 22:10:06

AND WHEREAS M/s _____ (The First Party, i.e the Bidder) itself is meeting all the qualifying requirements except the qualifying requirements of _____ (as detailed in the NIT) and in order to fully meet the qualifying requirements of NIT, this tie-up agreement is _____ being entered into with M/s _____ (The Second Party, the Associates), who fully meet the balance part of the said works _____ (_____).

WHEREAS the First Party and the Second Party are contractors engaged in the business of carrying out various items of works. WHEREAS the two parties have agreed to constitute themselves into a consortium for the purpose of carrying out the said works, and that the consortium will be continued till the completion of the works in all respects.

WHEREAS the parties have agreed to certain terms and conditions in this regard:

NOW THEREFORE THIS AGREEMENT WITNESSETH AS FOLLOWS :

1. First and Second parties hereby constitute themselves into a Consortium for the purpose of bidding and undertaking the said works pursuant to the said NIT as hereinafter stated.
 2. The First Party will be the leader (Lead Partner) and will be responsible for the entire works.
-

FORMS & PROCEDURES

Tender No: BHEL: MSTPP: C- RW: CSD: 22:10:06

CONSORTIUM AGREEMENT

3. The First Party shall undertake the following part(s) of work detailed in _____ the NIT namely

 4. The Second Party shall undertake the following part(s) of work detailed _____ in the said NIT namely

 5. The parties hereby declare and confirm that each of them will fulfill the required minimum qualifying requirements as prescribed in the said NIT for the works agreed to be undertaken by them as stated here-in-above.
 6. It is also agreed between the parties hereto that all of them shall be individually and severally responsible for the completion of the said works as per the schedule. Further, if the Employer/Owner sustains any loss or damage on account of any breach of the Contracts, we the, Consortium partners individually and severally undertake to promptly indemnify and pay such losses / damages caused to the Employer/Owner on its written demand without any demur, reservation, contest or protest in any manner whatsoever.
 7. The parties hereby agree and undertake that they shall provide adequate finances, suitable Tools, Plants, Tractors, Trailers, other transportation equipment, other Tools & Plants, Measuring & Monitoring Equipments (MMEs), Men and Machinery etc. for the proper and effective execution of the works to be undertaken by them as specified here-in-above.
-

FORMS & PROCEDURES

Tender No: BHEL: MSTPP: C- RW: CSD: 22:10:06

8. It is agreed interse between t he parties hereto that all the consequences liabilities etc., arising out of any default in the due execution of the said works shall be borne by the party in default, that is by party in whose area of works default has occurred, provided however, so far as M/s Bharat Hea vy Electricals Limited is concer ned, all the parties shall be liable jointly and severally.

IN WITNESS HEREOF the parties above named have signed this agreement on the day month and year first above written at _____(Place) .

WITNESS

For

1. NAME (FIRST PARTY)

2. OFFICIAL ADDRESS

WITNESS

For

1. NAME (SECOND PARTY)

2. OFFICIAL ADDRESS

[The successful bidder shall have to execute the " JOINT DEED OF UNDERTAKING " in the format to be made available by BHEL at the time of awarding].

FORMS & PROCEDURES

Tender No: BHEL: MSTPP: C- RW: CSD: 22:10:06

Form No: F-23 (Rev 00)

REFUND OF SECURITY DEPOSIT

To,
The Construction Manager
BHEL Site Office

Dear Sir,

Sub : **Refund of Security Deposit**

Ref : Contract No:.....,

Work:.....

I/We have submitted Final Bill in respect of the above Contract/Work vide our letter no:..... dated In line with Tender conditions (GCC clause no 1.11), kindly arrange to release/refund the Security Deposit along with Final Bill payments.

The details of Security Deposit are as below:

- 1. Cash Portion :
- 2. BG Portion :

Thanking You

Date:_____

Authorised representative of Contractor

To be filled up by BHEL

- 1. Security Deposit to be refunded:
 - a. Cash Portion:
 - b. BG Portion :
- 2. Less
 - a. Amount spent by BHEL on behalf of Contractor:
 - b. Payments made by BHEL on behalf of Contractor:
 - c. Other recoveries for Services etc
 - d. Any other recoveries
 - e. Total of 'a' to 'd':
- 3. Net Amount to be released (1-2) :
- 4. Certified that
 - a. The payment recommended for release is in order and there are no demands other than those included in the claim outstanding from the Contractor
 - b. Contract Guarantee period of Months commenced wef : _____
 - c. All objections raised so far have been settled
 - d. A note for refund of Security Deposit has been made in the Measurement Book

Signature of BHEL Engineer

Construction Manager

Date:-----

FORMS & PROCEDURES

Tender No: BHEL: MSTPP: C- RW: CSD: 22:10:06

Form No: F-24 (Rev 00)

REFUND OF GUARANTEE MONEY

**BHARAT HEAVY ELECTRICALS LIMITED
POWER SECTOR, _____ REGION**

Ref No:

Date:

1. Name and Address of Contractor :
 2. Contract Agreement/LOI No :
 3. Date of Contract Agreement/LOI :
 4. Name of the Work undertaken :
 5. Date of commencement of the Work :
 6. Date of Completion of the Work :
 7. Period of Maintenance :
(Guarantee Period)
 8. Date on which the Final Bill was paid :
 9. Last date of making good the defect :
during Maintenance Period
 10. Expenditure incurred by BHEL during :
Maintenance Period, if any, recoverable
 11. Date on which Guarantee Money refund:
falls due as per Contract
 12. Amount of Guarantee Money to be refunded:
 13. Less Amounts recoverable (with details)
 - a. Amount spent by BHEL on maintenance :
 - b. Payments made by BHEL on behalf of Contractor:
 - c. Court dues/penalties/compensation :
 - d. Other recoveries for Services, etc :
 - e. Total of 'a' to 'd' :
 14. Net Amount recommended for release (12-13) :
-

FORMS & PROCEDURES

Tender No: BHEL: MSTPP: C- RW: CSD: 22:10:06

Signature of BHEL Engineer

Date: _____

CERTIFICATE TO BE FURNISHED BY THE CONTRACTOR

I/We have no claim or demand outstanding against BHEL _____, for the work done or for labour or material supplied or any other account arising out of or connected with the Contract Agreement/LOI (No _____ dated _____) and the payment of this bill shall be in full and final settlement of all my/our claims and demands including the 'Deposits' of the Contract Agreement/LOI referred to.

Signature of Contractor

Date: _____

CERTIFICATE TO BE FURNISHED BY SENIOR ENGINEER/CONSTRUCTION MANAGER

1. Certified that
 - a. The payment recommended for release is in order and there are no demands other than those included in the claim outstanding from the Contractor
 - b. Maintenance period (Contract Guarantee period) is over and the Contractor has carried out the works required to be carried out by him during the period of maintenance (Guarantee) to our satisfaction, and all expenses incurred by the Company on carrying out such works have been included for adjustment
 - c. All objections raised so far have been settled
 - d. A note for refund of Guarantee Amount has been made in the Measurement Book and Contract Agreement/Work Order

Signature of BHEL Engineer

Construction Manager

Date:-----

FOR USE IN ACCOUNTS DEPARTMENT

Passed for Rs _____ (Rupees _____ only)

Accountant

Accounts Officer

ACKNOWLEDGE BY THE CONTRACTOR

Received Rs _____ in full and final settlement of my/our claim

Signature of Contractor

Date: _____

FORMS & PROCEDURES

Tender No: BHEL: MSTPP: C- RW: CSD: 22:10:06

Form No: F-25 (Rev 00)

POWER OF ATTORNEY for SUBMISSION OF TENDER/SIGNING CONTRACT AGREEMENT

(To be typed on non judicial Stamp Papers of appropriate value as applicable and Notarised)

KNOW ALL MEN BY THESE PRESENTS, that I/We do hereby make, no minate, constitute and appoint Mr , whose signatur e given below herewith to be true and lawful Attorney of M/s..... hereinafter call ed 'Company', for submitting Ten der/entering into Contract and inter alia, sign, execute all papers and to do nec essary lawful acts on behalf of C ompany with M/s Bhar at Heavy Electricals Ltd, Power Sector _____ Region, _____, in connection with

.....
.....
..... vide Tender Specification No :
_____, dated _____.

And the C ompany do hereby agree to rati fy and confirm all acts, deeds, things or proceedings as may be lawfully done by the sa id attorney and by or on behalf of the company and in the name of the company, by virtue of the powers conferred herein and the same shall be binding on the company and shall have full force and effect.

IN WITNESS WHEREOF the common seal of the company has been hereunto affixed in the manner hereinafter appearing on the document.

Dated at _____, this _____ day of _____

Director/CMD/Partner/Proprietor

Signature of Mr.....(Attorney)

Attested by: Director/CMD/Partner/Proprietor

Witness

Notary Public

FORMS & PROCEDURES

Tender No: BHEL: MSTPP: C- RW: CSD: 22:10:06

Form No: F-26 (Rev 00)

ANALYSIS OF UNIT RATES QUOTED

(To be typed and submitted in the Letter Head of the Company/Firm of Bidder)

Offer Reference No:.....

Date:.....

To,
(Write Name & Address of Officer of BHEL inviting the Tender)

Dear Sir,

Sub : Analysis of Unit Rates Quoted

Ref : Tender Specification No:

Analysis of Unit Rates quoted by us in respect of above Tender is as detailed

SN	DESCRIPTION	% OF QUOTED RATE	REMARKS
01	SITE FACILITIES VIZ., ELECTRICITY, WATER OTHER INFRASTRUCTURE.		
02	SALARY AND WAGES + RETRENCHMENT BENEFITS		
03	CONSUMABLES		
04	T&P DEPRECIATION & MAINTENANCE		
05	ESTABLISHMENT & ADMINISTRATIVE EXPENSES		
06	OVERHEADS		
07	PROFIT		
	TOTAL	100%	

Yours faithfully,

(Signature, Date & Seal of Authorized Representative of the Bidder)

FORMS & PROCEDURES

Tender No: BHEL: MSTPP: C- RW: CSD: 22:10:06

Form WAM 6

**BHARAT HEAVY ELECTRICALS LIMITED
DIVISION.....**

Running Account Bill

(Para 4.31.1 of Works Accounts Manual)

Name of the Contractor:
Name of the Work:
Sanctioned Estimate:
Code No:
Contract Agreement No :

Dated:

Departmental Bill no:
Division:
Date of written order to commence the work :
Date of commencement of the Work:
Due date of completion as per Agreement:

Date:
Sub-Division:

1. ACCOUNT OF WORK EXECUTED

On account payment for work not previously measured**	Item No of	Description of Work	Quantity as per agree-ment	Quantity executed up to date	Rate	Unit	Payment on the basis of actual measurement up to date	Quantity since last running account bill	Payment on the basis of actual measurement since last running account bill	Remarks		
----- Total since last Total As per running up to Running account date Account bill bill Rs. Rs. Rs.					Rs.	P.	Rs.	P.	Rs.	P.		
1	2	3	4	5	6	7	8	9	10	11	12	13

* *1. Whenever payment is made on 'on account' basis without actual measurements the amount in whole rupees should be entered in columns 1 to 3 only and not in columns 7 to 12.
2. whenever there is an entry in column 12 on the basis of actual measurement, the whole of the amount previously paid without detailed measurement should be adjusted by a minus entry in column 2 equivalent to the amount shown in column 1, so that the total up to date in column 4 may become nil.

FORMS & PROCEDURES

Tender No: BHEL: MSTPP: C- RW: CSD: 22:10:06

Form WAM 6 (contd...)

1	2	3	4	5	6	7	8	9	10	11	12	13
---	---	---	---	---	---	---	---	---	----	----	----	----

Total value of work done up to date (A) ...

Running Account Bill Deduct value of work shown on the last (B) ...

Net value of work done since last (C) ...

Rupees (in words)

.....only.

FORMS & PROCEDURES

Tender No: BHEL: MSTPP: C- RW: CSD: 22:10:06

Form WAM 6 (contd...)

II.MEMORANDUM OF PAYMENTS

		Rs.	P.		
				I	II
				Rs. P. P.	Rs. P. P.
1.Total value of work actually measured as per Account No. I. Column 10	(A)
2.Total up to date 'on account' payment for work covered by approximate Or plan measurements as per Account No. I, Column 3	(B)
3.Total up to date secured advances on security of materials as per column 8 Of the enclosed Account (Form WAM 10)	(C)
4.Total up to date payments [(A) + (B) + (C)]	(D)
5.Total amount of payments already made as per Entry (D) of last Running Account Bill No..... Dated.....forwarde to the Accounts Office on	(E)				
6.Balance [(D)-(E)]				
7.Payments now to be made:					
a) by cash/cheque				
b) by deduction for value of materials supplied					
c) by BHEL vide Annexure A attached				
d) by deduction for hire of tools and plant vide					

FORMS & PROCEDURES

Tender No: BHEL: MSTPP: C- RW: CSD: 22:10:06

Annexure B attached
 e) by deduction for other charges vide Annexure C
 Attached
 f) by deduction on account of security deposit
 h) by deduction on account of Income Tax

Note: Amounts relating to items 4 to 6 above should be entered in column II and those relating to item 7 in column I. The amount shown against item 6 and the total of item 7 should agree with each other.

III. CERTIFICATE OF THE ENGINEER IN CHARGE

Form WAM 6 (contd...)

1. The measurements on which the entries in column 7 to 12 of Part I of this Bill (Account of work executed) are based were made by.....and are recorded at pages..... of
(Name and Designation)

Measurement Book No

2. Certified that the methods of measurement are correct and the work has been carried out in accordance with the terms and conditions, schedules, specifications and drawings etc, forming part of the contract agreement, subject to deviations included in the deviation statement (Annexure D).

3. Certified that in addition to and quite apart from the quantities of work actually executed as shown in column 10 of Part I, some work has actually been done in connection with several items and the value of the such work is, in no case, less than 'on account' payments as per column 3 of Part I, made or proposed to be made, for the convenience of the contractor in anticipation of, and subject to the results of, detailed measurement which will be made as soon as possible.

Signature of Contractor

Signature of Engineer in charge

Date:

Designation:

Date:

FORMS & PROCEDURES

Tender No: BHEL: MSTPP: C- RW: CSD: 22:10:06

IV. CERTIFICATE OF THE SENIOR ENGINEER

1. Certified that measurements have been check measured to the prescribed extent byat site and also by the undersigned and the relevant entries have been intialled in the Measurement book. (vide pages.....)
(Name and Designation)
2. Certified that all the measurements recorded in the measurement book have been correctly billed for
3. Certified that all recoberable amounts in respect of materials tools and plant etc, and other charges have been correctly made vide Annexures A to C attached. Certified for payment * of Rs.....(Rupees..... only)
To be paid in cash/by cheque in the presence of

ALLOCATION

The expenditure is chargeable as under and to be included in the accounts for.....20.....

Ledger Head	Debit (Gross amount)	Credit (Deductions)
	Rs. P.	Rs. P.
Total		

* Here specify the net amount payable.

Signature of Senior Engineer

Date:

Form WAM 6 (contd...)

V. ENTRIES TO BE MADE IN THE ACCOUNTS OFFICE

Accounts Bill NoDated.....
 Entered in Journal Book vide entry No.....Dated.....
 Passed for.....Rs.....
 Less Deductions.....Rs.....
 Net Amount Payable.....Rs.....
 (Rupees.....only)
 Payable to Shri/M/s.....by cheque/cash
 Entered in Contractor's Ledger No.....Page.....

ALLOCATION

Estimate No: Code no:
 Name of the Work:

Ledger Head	Debit (Gross amount)	Credit (Deductions)
	Rs. P.	Rs. P.

FORMS & PROCEDURES

Tender No: BHEL: MSTPP: C- RW: CSD: 22:10:06

Assistant Date: _____	Accountant Date: _____	Account Officer Date: _____	Total	_____	_____
--------------------------	---------------------------	--------------------------------	-------	-------	-------

VI. Received Rs.....(Rupees.....only) as per
Memorandum of Payments on account of this work.

Signature of witness Address : Date:	Revenue	Stamp Signature of Contractor Date:
--	---------	---

VII. ENTRIES TO BE MADE BY TREASURY SECTION

Cash Book entry No. and date:	Amount paid	Rs.....
	Amount unpaid	Rs.....
	Total	Rs.....

Signature of Cashier
Date:

Form WAM 6 (contd...)

ANNEXURE A

FORMS & PROCEDURES

Tender No: BHEL: MSTPP: C- RW: CSD: 22:10:06

Statement showing details of materials issued to the contractor Shri/M/s.....

In respect of Contract Agreement NoDated.....

Sl. No.	Stores issue Voucher No. and date	Issue voucher No. and date allotted by stores to the SIV	Description of material issued to the contractor	Quantity issued	Quantity actually incorporated in the work	Whether recoverable from the contractor or supplied free	If recoverable from the contractor				R E M A R K S	
							Rate at which recoverable	Amount recoverable	Amount recovered up to previous bill	Balance now recovered		
							Rs. P.	Rs. P.	Rs. P.	Rs. P.		
1	2	3	4	5	6	7	8	9	10	11	12	
Total												

Signature of contractor

Signature of Engineer in Charge

Signature of Senior Engineer

Date:

Date:

Date:

FORMS & PROCEDURES

Tender No: BHEL: MSTPP: C- RW: CSD: 22:10:06

Form WAM 6 (contd...)

ANNEXURE B

Statement showing tools and plant issued to the contractor Shri/M/s.....

In respect of Contract Agreement NoDated.....

Sl. No	Description of tools and plant issued	Period for which Issued	Rate at which recovery is to be Made	Amount recover-able	Amount recovered upto previous bill	Balance now recovered	Remarks
			Rs. P.	Rs. P.	Rs. P.	Rs. P.	
1	2	3	4	5	6	7	8

Total -----

Signature of contractor

Signature of Engineer in Charge

Signature of Senior Engineer

Date:

Date:

Date:

FORMS & PROCEDURES

Tender No: BHEL: MSTPP: C- RW: CSD: 22:10:06

Form WAM 6 (contd...)

ANNEXURE C

Statement showing details of other recoveries to be made from the contractor Shri/M/s.....

In respect of Contract Agreement NoDated.....

Sl. No	Particulars	Unit	Quantity	Rate	Amount recover- able	Amount recovered upto pre- vious bill	Amount now recovered	Remarks
				Rs. P.	Rs. P.	Rs. P.	Rs. P.	
1	2	3	4	5	6	7	8	9

- | | | | | | | | | |
|----|-------------------------------|--|--|------------------------------|--|--|--|--|
| 1. | | | | Water Charges | | | | |
| 2. | | | | Electricity charges | | | | |
| 3. | | | | Seignorage charges | | | | |
| 4. | | | | Medical charges | | | | |
| 5. | | | | Cost of empty gunny bags and | | | | |
| | Empty containers not returned | | | | | | | |
| 6. | | | | | | | | |
| 7. | | | | | | | | |
| 8. | | | | | | | | |
| 9. | | | | | | | | |

FORMS & PROCEDURES

Tender No: BHEL: MSTPP: C- RW: CSD: 22:10:06

10.

Total

Signature of contractor

Signature of Engineer in Charge

Signature of Senior Engineer

Date:

Date:

Date:

FORMS & PROCEDURES

Tender No: BHEL: MSTPP: C- RW: CSD: 22:10:06

Form WAM 6 (contd...)

ANNEXURE D

Name of the Contractor:
Name of the Work:

Contract Agreement No:
Date:

Sl. No.	Description of item	Unit	Quantity as per Agreement	Quantity as executed	Quantity further anticipated	Total quantity anticipated on completion	Rate as per agreement Rs. P.
1	2	3	4	5	6	7	8

Rate as the executed with any Rs. P.	Amount as per agreement Rs. P.	Amount as executed Rs. P.	Amount further anticipated Rs. P.	Total amount anticipated on completion Rs. P.	Difference ----- Excess savings Rs. P. Rs. P.		Reason for deviation authority, if
9	10	11	12	13	14	15	16

Signature of Engineer in Charge
Date:

Signature of Senior Engineer
Date:

FORMS & PROCEDURES

Tender No: BHEL: MSTPP: C- RW: CSD: 22:10:03

FORMS & PROCEDURES

Tender No: BHEL: MSTPP: C- RW: CSD: 22:10:03

II MEMORANDUM OF PAYMENT												
										Rs.	P	
1	Total Value of work actually measured as per Account no I coloumn 10										(A)	
2	Deduct amount of paym,ents already made as per last running account bill No Dated..... Forwarded to the Accounts Office on										(B)	
3	Payments now to be made { (A) - (B)}										(C)	
4	Deduct ammounts recoverable from the contractor on account of :										Rs	P
	a	Material suplied by BHEL vide annexure A attached										
	b	Hire of Tools & Plants vide Annexure B attached										
	c	Other charges vide Annexure C attached										
	d	Income Tax										
	Total deduction											
5	Balance											
6	Refund of 50% of security deposite on completion of work											
7	Net amount to be paid to the Contractor											
III. CERTIFICATE OF THE ENGINEER IN CHARGE												
The measurement on which the entries in coulms 7 to 12 of Part I of this bill (Account of work executed) are based were made by												
1 (Name and designation)											
2	A statement showing the quantities of stores issued to the contractor (whether free or on recovery basis) and their disposal is attached.											
Date:										Signature of Engineer in charge		
										Designation		

FORMS & PROCEDURES

Tender No: BHEL: MSTPP: C- RW: CSD: 22:10:03

V. ENTRIES TO BE MADE IN THE ACCOUNTS OFFICE											
Account Bill no..... Dated						ALLOCATION					
Entered in Journal book vide entry No..... Dated.....						Estimate No:		Code No			
Passed for.....Rs.....						Name of the Work					
Less Deductions.....Rs.....						Ledger Head		Debit		Credit	
(Rupees..... Only)						(Gross Amount)		Rs P		(Deduction)	
Payable to Shri/M/s..... by cheque/cash						Rs		P		Rs	
Entered in contractors' Ledger no..... Page						Total		
Assistant		Accountant		Accounts officer							
Date:		Date:		Date:							
VI. Received Rs.....(Rupees..... Only) in full and final settlement of all moneys due under this contract and I / we have no further claims of this contract.											
Signature of Witness											
Address											
Revenue Stamp											
Signature of Contractor											
Date:											
VII . ENTRIES TO BE MADE BY TREASURY SECTION											
Cash book entry no and date :						Amount Paid Rs.....					
						Amount unpaid Rs.....					
						Total Rs.....					
Signature of Cashier											
Date:											

FORMS & PROCEDURES

Tender No: BHEL: MSTPP: C- RW: CSD: 22:10:03

BHARAT HEAVY ELECTRICALS LIMITED DIVISION.....And Final bill (Para 4.3.2 Of Works Accounts Manual)												
Name of Contractor			Departmental Bill no				Date					
Name of the Work			Division				Division					
Sanctioned Estimate			Date of written order to commence the work									
Contract Agreement/work Order No			Date of commencement of work									
			Due date of completion as per agreement									
			Date of actual completion of the work									
I. ACCOUNT OF WORK EXECUTED												
On Account payment for the work not previously measured **												
Total as per last running account bill Rs.	Since last running account bill Rs	Total up to date Rs	Item No of the agreement/work order	Description of work	Quantity as per agreement	Quantity executed up to date	Rate Rs. P	Unit	Payment on the basis of actual measurement up to date Rs P	Quantity since last running account bill	Payment on the basis of actual measurement since last running account bill Rs P	Remarks
1	2	3	4	5	6	7	8	9	10	11	12	13

FORMS & PROCEDURES

Tender No: BHEL: MSTPP: C- RW: CSD: 22:10:03

1	2	3	4	5	6	7	8	9	10	11	12	13
---	---	---	---	---	---	---	---	---	----	----	----	----

Total Value of Work Done up to date (A)	
Deduct Value of work shown on the last running account bill (B)	
Net value of work done since last running account bill (C)	

Rupees (In Words)..... Only

FORMS & PROCEDURES

Tender No: BHEL: MSTPP: C- RW: CSD: 22:10:03

II MEMORANDUM OF PAYMENT

		Rs.	P
1	Total Value of work actually measured as per Account no I coloumn 10	(A)	
	Deduct amount of paym,ents already made as per last running account bill No Dated.....		
2	Forwarded to the Accounts Office on	(B)	
3	Payments now to be made { (A) - (B)}	(C)	
4	Deduct ammounts recoverable from the contractor on account of :	Rs	P
	a Material suplied by BHEL vide annexure A attached		
	b Hire of Tools & Plants vide Annexure B attached		
	c Other charges vide Annexure C attached		
	d Income Tax		
	Total deduction		
5	Balance		
6	Refund of 50% of security deposite on completion of work		
7	Net amount to be paid to the Contractor		

III. CERTIFICATE OF THE ENGINEER IN CHARGE

The measurement on which the entries in coulms 7 to 12 of Part I of this bill (Account of work executed) are based were made by

-
- 1 (Name and designation)
 - 2 A statement showing the quantities of stores issued to the contractor (whether free or on recovery basis) and their disposal is attached.

Date:

Signature of Engineer in charge
Designation

FORMS & PROCEDURES

Tender No: BHEL: MSTPP: C- RW: CSD: 22:10:03

V. ENTRIES TO BE MADE IN THE ACCOUNTS OFFICE

Account Bill no..... Dated

Entered in Journal book vide entry No.....Dated.....

Passed for.....Rs.....

Less Deductions.....Rs.....

(Rupees..... Only)

Payable to Shri/M/s..... by cheque/cash

Entered in contractors' Ledger no..... Page

ALLOCATION

Estimate No:

Name of the Work

Code No

Ledger Head

Debit
(Gross Amount)
Rs P

Credit
(Deduction)
Rs

Total

Assistant
Date:

Accountant
Date:

Accounts officer
Date:

VI. Received Rs.....(Rupees..... Only) in full and final settlement of all moneys due under this contract and I / we have no further claims of this contract.

Signature of Witness
Address

Revenue Stamp
Signature of Contractor
Date:

VII . ENTRIES TO BE MADE BY TREASURY SECTION

Cash book entry no and date :

Amount Paid Rs.....
Amount unpaid Rs.....
Total Rs.....

Signature of Cashier
Date:

FORMS & PROCEDURES

Tender No: BHEL: MSTPP: C- RW: CSD: 22:10:03

ANNEXURE A

Part I

Statement showing details of material issued to the contractor Shri/M/s..... In respect of Contract Agreement/Work Order No..... Dated

SI No	Stores Issue voucher No and date	Issue voucher No and date allotted by stores to the SIV	description of material issued to the contractor	Quantity issued	Quantity incorporated in the work	Whether recoverable from the contractor or supplied free	Rate at which recoverable		If recoverable from contractor				Remarks		
							Rs	P	Amount Recoverable		Amount recoverable upto previous bill			Balance Now recovered	
									Rs	P	Rs	P	Rs	P	
1	2	3	4	5	6	7	8	9	10	11	12				

Total

Signature of Contractor
Date

Signature of Engineer in charge
Date

Signature of Senior Engineer
Date

FORMS & PROCEDURES

Tender No: BHEL: MSTPP: C- RW: CSD: 22:10:03

ANNEXURE A

Part II

Statement showing details of material issued to the contractor Shri/M/s..... in respect of Contract Agreement/Work Order No..... Dated and not covered by the agreement

SI No	Stores Issue voucher No and date	Issue voucher No and date allotted by stores to the SIV	description of material issued to the contractor	Quantity issued	Quantity incorporated in the work	Issue Rate	Amount Recoverable		Amount recoverable upto previous bill		Balance Now recovered		Remarks
							Rs	P	Rs	P	Rs	P	
1	2	3	4	5	6	7	8	9	10	10	10	11	

Total

Add Departmental Charges

Add Sales Tax (wherever applicable)

Total

Signature of Contractor
Date

Signature of Engineer in charge
Date

Signature of Senior Engineer
Date

FORMS & PROCEDURES

Tender No: BHEL: MSTPP: C- RW: CSD: 22:10:03

ANNEXURE B

Statement showing TOOLS & PLANTS issued to the contractor Shri/M/s.....in respect of Contract Agreement/Work Order No..... Dated and not covered by the agreement

SI No	Description of tools & plants issued	Period for which issued	Rate at which Recivry is to be made	Amount recoverabl e		Amount recoverable upto previous bill		Balance Now recovered		Remarks
				Rs	P	Rs	P	Rs	P	
1	2	3	4	5		6		7		8
				Total					

Signature of Contractor
Date

Signature of Engineer in charge
Date

Signature of Senior Engineer
Date

FORMS & PROCEDURES

Tender No: BHEL: MSTPP: C- RW: CSD: 22:10:03

ANNEXURE C

showing detail of other recoveries to be made from the contractor Shri/M/s.....
ment/Work Order No.....Dated.....

Sr.No	Particulars	Unit	Quantity	Rate Rs. P.	Amount recoverable Rs. P	Amount recovered upto previous bill Rs. P.	Amount now recovered Rs. P.	Remarks
1	2	3	4	5	6	7	8	9
	1 Water Charges							
	2 Electricity Charges							
	3 Seignorage Charges							
	4 Medical Charges							
	Cost of empty gunny bags and empty containers not 5 returned							
	6							
	7							
	8							
	9							
	10							
Total								

Signature of Contractor
Date

Signature of Engineer Incharge
Date

Signature of Sr. Engineer
Date

FORMS & PROCEDURES

Tender No: BHEL: MSTPP: C- RW: CSD: 22:10:03

Form V

ANNEXURE D -
DEVIATION STATEMENT :

Name of the Contractor :
Name of the Work :

Contract Agreement
Date :

Sl. No.	Description of item	Unit	Quantity as per agreement	Quantity as executed	Rate as per agreement Rs. P.	Rate as executed Rs. P.	Amount as per agreement Rs. P.	Amount as executed Rs. P.	Difference Rs. P.
1	2	3	4	5	6	7	8	9	10

Signature of Engineer in Charge
Date :

Signature of Ser
Date :

FORMS & PROCEDURES

Tender No: BHEL: MSTPP: C- RW: CSD: 22:10:03

Form WAM 7 (Contd.)

ANNEXURE E

Statement showing the consumption of materials issued to the contractor Shri/M/s.....
in respect of Contract Agreement/Work Order No..... Dated.....

Name of the Work :

ON RECOVERY BASIS

Sl. No.	Description of material	Unit	Quantity actually issued	Quantity actually incorporated in the work	Balance	Particulars of disposal of balance	Quantity to be issued as per approved data for work actually done	Variation in consumption (Difference between column 5 and 8)		Rate charge-able for excess/short consumption, if any	Amount recover-able for excess/short consum-ption, including materials not returned	Rs. P.
								More	Less			
1	2	3	4	5	6	7	8	9	10	11	12	13
1.	Cement											
2.	Bricks											
3.	Wood.....											
4.	Asbestos Sheet											
5.	Iron Materials											
6.												
7.												
8.												
9.												
10.												

Signature of Contractor

Signature of Engineer in Charge

Signature of Senior Engineer

Date :

Date :

Date :

Note : 1. The quantities shown in columns 4 and 5 above should tally with those shown in columns 5 and 6 respectively of Annexure A (Part I and II).

2. Data statement of theoretical consumption should be attached in support of quantity specified in column 8.

FORMS & PROCEDURES

Tender No: BHEL: MSTPP: C- RW: CSD: 22:10:03

ANNEXURE F

Statement showing detail of materials issued to the contractor Shri/M/s.....
 ct of Contract Agreement/Work Order No..... Dated.....

Name of work;

FREE OF COST

Sr.No	Stores issue voucher No.	Description of material	Unit	Quantity issued	Quantity required as per data	Quantity consumed in the work	Balance(if any)	Nature of disposal for the balance	Rate chargeable for material not returned Rs.P.	Amount recoverable for material not returned Rs. P	Remarks
1	2	3	4	5	6	7	8	9	10	11	12
Total											
Signature of Contractor Date				Signature of Engineer Incharge Date				Signature of Sr. Engineer Date			
Note: Data statement of theoretical consumption should be attached in support of the quantity specified in column 6											

Annexure-G

QUESTIONNAIRE TO BE ANSWERED BY ENGINEER IN CHARGE AND SENIOR ENGINEER	
(Correct particulars and answers to be recorded)	
Name of the work :	
Name of the Contractor :	
Date of commencement of the work:	
Contract agreement/work ordered no. and date:	
Reference to supplementary agreement no,if any :	
Whether administrative approval and technical sanction has been accorded by the competent authority ? If so ,cite reference	
Whether sanction of the competent authority and financial concurrence of the Accounts Department for award of the work has been accorded ? If so,cite reference.	
Whether the work has been completed in time ? If not ,whether penalty has been levied or sanction of the competent authority for extension of time granted and communicated to the Accounts Department with reasons for grant of extension? (Due and actual date of completion of the work and reference to letter no. and date granting the extension of time should be given)	
(a) Whether the rates allowed in the bill have been checked with the contract agreement ? (b) Whether the rates for extra/supplemental items have been approved by the competent authority and the sanction communicated to the accounts Department together with rate analysis? If so,cite reference.	
Whether deviations have been approved by the competent authority? If yes, give reference to the approval; if not, give reasons.	
Whether the rates of recovery of stores issued to the contractor which are not provided for in the Contract Agreement have been settled in consultation with Finance?	
Whether discrepancies pointed out by the Accounts Department in the store statement have been reconciled and accepted by the Accounts Department?	

Annexure-G

QUESTIONNAIRE TO BE ANSWERED BY ENGINEER IN CHARGE AND SENIOR ENGINEER	
(Correct particulars and answers to be recorded)	
Whether materials issued to the contractor in excess of the theoretical requirements have been returned to the Stores Department and the no. and date of such returned stores vouchers have been shown in stores statement? If not, whether the cost of such excess material has been recovered at the prescribed rate? Whether consumption statements in respect of materials chargeable to the work have been attached to the bill?	
Whether consumption of materials shown has been technically checked by Senior Engineer?	
Whether materials issued and used in the work is not less than that required for consumption in work according to our specification? If consumption is less, whether necessary recovery has been made in the bill?	
Whether measurements have been checked by the Engineer and Sr. Engineer to the extent required and certificates of check recorded in the measurement books?	
Whether contractor has signed the bill and the measurement books without reservations? If not, whether reasons have been intimated to the Accounts Department?	
Whether arithmetical calculations have been checked and certificate recorded in the measurement books by a person other than the one who calculated initially	
Whether any work was done at the risk and cost of the contractor and whether such cost has been recovered from him? Give particulars.	
Whether all advance payments on running Accounts have been recovered?	
Whether all the recoveries due to services given to the contractor like rent of accommodation, water charges, electricity charges etc. have been recovered and whether payments made by the company on behalf of the contractor have been adjusted?	
Whether the files containing abstracts from measurement books/ standard measurement books have been completed/ updated?	
Whether hire charges of tools and plant have been recovered and the statement of hire charges with full details attached?	

Annexure-G

QUESTIONNAIRE TO BE ANSWERED BY ENGINEER IN CHARGE AND SENIOR ENGINEER	
(Correct particulars and answers to be recorded)	
Whether the certificate of workmanship and completion of work according to specifications, drawings etc. is recorded by Engineer/ Sr. Engineer and whether recoveries have been made for defective works, if any?	
Whether all corrections in the bill/measurement books etc. have been neatly made and attested and there are no overwriting?	
Whether final measurements have been taken as soon as possible after completion of work and the certificate of completion issued? If not, whether reasons for delay have been recorded and communicated to Accounts?	
In respect of quantities reduced in the final bill as compared to the running payment, whether adequate reasons have been recorded and communicated to Accounts?	
Whether the expenditure has been classified correctly according to heads of Account recorded in the sanctioned estimate?	
Whether the work has been completed within the estimated cost? If not, what is the percentage of excess over the sanctioned estimate/ administrative approval? In case the excess is beyond the competency of Sr. Engineer, what action has been taken for the obtaining the approval of the authority competent to sanction the excess?	
(a) If the contractor has furnished bank guarantee in lieu of cash security deposit towards proper execution of works and guarantee against defects during the maintenance period, whether the period of currency of the bank guarantee covers the entire maintenance period? (b) If not, whether security deposit has been proposed to be recovered from the final bill?	
Whether all the previous audit objections raised on running Account bills have been settled? If so, cite reference.	
Signature of Engineer in Charge	Signature of Engineer in Charge
Date:	Date:

FORMS & PROCEDURES

Tender No: BHEL: MSTPP: C- RW: CSD: 22:10:06

Form No: F-14 (Rev 00)

 PS- R	MONTHLY PLAN & REVIEW WITH CONTRACTOR						Page 1 of 4		
Name of Site						Contract No.			
						Name of Contractor			
Review for the month of						Brief Scope of work			
Date of Review									
PART- A PHYSICAL REVIEW									
Sl.No	Description of work	Unit of Measurement	Original Plan (QTY Planned for the month as per joint review of previous month)	Last months shortfall (attributable to Contractor)	Total Planned for the month (including previous month backlog attributable to Contractor)	Achieved	Shortfall attributable to (in Qty)		REMARKS
			(a)	(b)	C=(a)+(b)		BHEL	Contractor	
		UOM	Phy.	Phy	Phy	Phy.	Phy.	Phy.	
Use separate sheets if necessary									

BHEL
(Sign with name, designation and date)

CONTRACTOR
(Sign with name, designation and date)

FORMS & PROCEDURES

Tender No: BHEL: MSTPP: C- RW: CSD: 22:10:06

Form No: F-14 (Rev 00)

 PS- R	<p>MONTHLY PLAN & REVIEW WITH CONTRACTOR</p>	Page 2 of 4
--	---	-------------

CONTRACT NO:

CONTRACTOR:

PART – B-1 REVIEW OF DEPLOYMENT OF MAJOR T&Ps

SUPPLIER SCOPE:-

SN.	MAJOR T&P TO BE DEPLOYED AS PER WORK PLANNED FOR THE MONTH	QTY.	DEPLOYMENT STATUS (ACTUAL DEPLOYED)	REMARKS (WORKS EFFECTED DUE TO NON-DEPLOYMENT OF T&Ps)

BHEL SCOPE:-

BHEL
(Sign with name, designation and date)

CONTRACTOR
(Sign with name, designation and date)

FORMS & PROCEDURES

Tender No: BHEL: MSTPP: C- RW: CSD: 22:10:06

Form No: F-14 (Rev 00)

 PS- R	MONTHLY PLAN & REVIEW WITH CONTRACTOR	Page 3 of 4
--	--	-------------

CONTRACT NO:

CONTRACTOR:

PART – B-2 REVIEW OF DEPLOYMENT OF MANPOWER

SUPPLIER SCOPE:-

SNO.	AREA OF WORK	CATEGORY OF LABOUR	NO. OF LABOUR REQUIRED AS PER CATEGORY	DEPLOYED FOR THE PERIOD	REMARKS (WORKS AFFECTED DUE TO NON-AVAILABILITY OF LABOUR)

BHEL
(Sign with name, designation and date)

CONTRACTOR
(Sign with name, designation and date)

FORMS & PROCEDURES

Tender No: BHEL: MSTPP: C- RW: CSD: 22:10:06

Form No: F-14 (Rev 00)

 PS- R	<p>MONTHLY PLAN & REVIEW WITH CONTRACTOR</p>	Page 4 of 4
--	---	-------------

CONTRACT No.:

Date of Report:

PART C1 : PLAN FOR THE NEXT MONTH (PHYSICAL)

SL NO.	DESCRIPTION OF WORK (Area Wise)	PLANNED MT/ % / QTY (EXCLUDING SHORTFALLS ATTRIBUTABLE TO CONTRACTOR TILL DATE)	T&Ps REQUIRED	MANPOWER REQUIRED	REMARKS

NOTE: USE SEPARATE SHEETS, IF REQUIRED

PART C2: PLAN FOR THE NEXT MONTH (OTHERS)

SL NO.	DESCRIPTION OF WORK (Area Wise)	PLANNED MT/ % / QTY	T&Ps REQUIRED	MANPOWER REQUIRED	REMARKS

NOTE: USE SEPARATE SHEETS, IF REQUIRED

BHEL
(Sign with name, designation and date)

CONTRACTOR
(Sign with name, designation and date)

FORMS & PROCEDURES

Tender No: BHEL: MSTPP: C- RW: CSD: 22:10:06

Form No: F-14 (Rev 00)

 <p>PS- R</p>	<p>MONTHLY PLAN & REVIEW WITH CONTRACTOR</p>	<p>Page 5 of 4</p>
--	--	--------------------

BHEL
(Sign with name, designation and date)

CONTRACTOR
(Sign with name, designation and date)

FORMS & PROCEDURES

Tender No: BHEL: MSTPP: C- RW: CSD: 22:10:06

BANK GUARANTEE FOR PERFORMANCE SECURITY

Bank Guarantee No:

Date:

To

NAME

& ADDRESSES OF THE BENEFICIARY

Dear Sirs,

In consideration of the Bharat Heavy Electricals Limited (hereinafter referred to as the 'Employer' which expression shall unless repugnant to the context or meaning thereof, include its successors and permitted assigns) incorporated under the Companies Act, 1956 and having its registered office at BHEL House, Siri Fort, Asiad, New Delhi – 110049 through its Unit at Bharat Heavy Electricals Limited, Power Sector Eastern Region, BHEL Bhawan, Plot No 9/1, DJ Block, Sector-II, Salt lake City, Kolkata – 700091 having awarded to (Name of the Vendor / Contractor / Supplier) having its registered office at _____¹ hereinafter referred to as the 'Contractor/Supplier', which expression shall unless repugnant to the context or meaning thereof, include its successors and permitted assigns), a contract Ref No... .. dated² valued at Rs.....² (Rupees -----)for <Nature of Work>³ (hereinafter called the 'Contract') and the Contractor having agreed to provide a Contract Performance Guarantee, equivalent to% (.... Percent) of the said value of the Contract to the Employer for the faithful performance of the Contract,

we,, (hereinafter referred to as the Bank), having registered/Head office atand inter alia a branch at being the Guarantor under this Guarantee, hereby, irrevocably and unconditionally undertake to forthwith and immediately pay to the Employer a maximum amount Rs ----- (Rupees -----)⁴ without any demur, immediately on a demand from the Employer, .

Any such demand made on the Bank shall be conclusive as regards the amount due and payable by the Bank under this guarantee. However, our liability under this guarantee shall be restricted to an amount not exceeding Rs._____.

We undertake to pay to the Employer any money so demanded notwithstanding any dispute or disputes raised by the Contractor/ Supplier in any suit or proceeding pending before any Court or Tribunal relating thereto our liability under this present being absolute and unequivocal.

FORMS & PROCEDURES

Tender No: BHEL: MSTPP: C- RW: CSD: 22:10:06

The payment so made by us under this Guarantee shall be a valid discharge of our liability for payment thereunder and the contractors/supplier shall have no claim against us for making such payment.

We the.....bank further agree that the guarantee herein contained shall remain in full force and effect during the period that would be taken for the performance of the said Contract and that it shall continue to be enforceable till all the dues of the Employer under or by virtue of the said Contract have been fully paid and its claims satisfied or discharged.

We BANK further agree with the Employer that the Employer shall have the fullest liberty without our consent and without affecting in any manner our obligations hereunder to vary any of the terms and conditions of the said Contract or to extend time of performance by the said Contractor/Supplier from time to time or to postpone for any time or from time to time any of the powers exercisable by the Employer against the said Contractor/Supplier and to forbear or enforce any of the terms and conditions relating to the said Agreement and we shall not be relieved from our liability by reason of any such variation, or extension being granted to the said Contractor/Supplier or for any forbearance, act or omission on the part of the Employer or any indulgence by the Employer to the said Contractor/Supplier or by any such matter or thing whatsoever which under the law relating to sureties would but for this provision have effect of so relieving us.

The Bank also agrees that the Employer at its option shall be entitled to enforce this Guarantee against the Bank as a principal debtor, in the first instance without proceeding against the Contractor and notwithstanding any security or other guarantee that the Employer may have in relation to the Contractor's liabilities.

This Guarantee shall remain in force upto and including.....⁵ and shall be extended from time to time for such period as may be desired by Employer.

This Guarantee shall not be determined or affected by liquidation or winding up, dissolution or change of constitution or insolvency of the Contractor/Supplier but shall in all respects and for all purposes be binding and operative until payment of all money payable to the Employer in terms thereof.

Unless a demand or claim under this guarantee is made on us in writing on or before the⁶ (3 months more than the present date of validity of Bank Guarantee) we shall be discharged from all liabilities under this guarantee thereafter.

We, BANK lastly undertake not to revoke this guarantee during its currency except with the previous consent of the Employer in writing.

Notwithstanding anything to the contrary contained hereinabove:

FORMS & PROCEDURES

Tender No: BHEL: MSTPP: C- RW: CSD: 22:10:06

- a) The liability of the Bank under this Guarantee shall not exceed.....⁷
- b) This Guarantee shall be valid up to.....⁸
- c) Unless the Bank is served a written claim or demand on or before _____⁹ (3 months more than the present date of validity of Bank Guarantee) all rights under this guarantee shall be forfeited and the Bank shall be relieved and discharged from all liabilities under this guarantee irrespective of whether or not the original bank guarantee is returned to the Bank.

We, _____ Bank, have power to issue this Guarantee under law and the undersigned as a duly authorized person has full powers to sign this Guarantee on behalf of the Bank.

Any claim or dispute arising under the terms of this document shall only be enforced or settled in the courts of at Kolkata only.

For and on behalf of
(Name of the Bank)

Dated.....

Place of Issue.....

¹ NAME AND ADDRESS OF THE VENDOR /CONTRACTOR / SUPPLIER.

² DETAILS ABOUT THE NOTICE OF AWARD/CONTRACT REFERENCE

³ PROJECT/SUPPLY DETAILS

⁴ BG AMOUNT IN FIGURES AND WORDS

⁵ VALIDITY DATE

⁶ DATE OF EXPIRY OF CLAIM PERIOD

⁷ BG AMOUNT IN FIGURES AND WORDS.

⁸ VALIDITY DATE

⁹ DATE OF EXPIRY OF CLAIM PERIOD

Note:

1. Units are advised that expiry of claim period may be kept 2/3 months after validity date.

2. In Case of Bank Guarantees submitted by Foreign Vendors-

- a. From Nationalized/Public Sector / Private Sector/ Foreign Banks (BG issued by Branches in India) can be accepted subject to the condition that the Bank Guarantee should be enforceable in the town/city or at nearest branch where the Unit is located i.e. Demand can be presented at the Branch located in the town/city or at nearest branch where the Unit is located.

FORMS & PROCEDURES

Tender No: BHEL: MSTPP: C- RW: CSD: 22:10:06

- b. From Foreign Banks (wherein Foreign Vendors intend to provide BG from local branch of the Vendor country's Bank)**
- b.1** In such cases, in the Tender Enquiry/ Contract itself, it may be clearly specified that Bank Guarantee issued by **any of the Consortium Banks only** will be accepted by BHEL. As such, Foreign Vendor needs to make necessary arrangements for issuance of Counter- Guarantee by Foreign Bank in favour of the Indian Bank (BHEL's Consortium Bank). It is advisable that all charges for issuance of Bank Guarantee/ counter- Guarantee should be borne by the Foreign Vendor. The tender stipulation should clearly specify these requirements.
- b.2** **In case, Foreign Vendors intend to provide BG from Overseas Branch of our Consortium Bank** (e.g. if a BG is to be issued by SBI Frankfurt), the same is acceptable. However, the procedure at **sl.no. b.1** will required to be followed.
- b.3** The BG issued may preferably be subject to Uniform Rules for Demand Guarantees (URDG) 758 (as amended from time to time). In case, of Foreign Vendors, the BG Format provided to them should clearly specify the same.
- b.4** The BG should clearly specify that the demand or other document can be presented in electronic form.

FORMS & PROCEDURES

Tender No: BHEL: MSTPP: C- RW: CSD: 22:10:06

BANK GUARANTEE FOR SECURITY DEPOSIT CUM PERFORMANCE BANK GUARANTEE BOND

B.G. NO.

Date

This deed of Guarantee made this ----- day of -----two thousand ---- by <Name and Address of Bank> hereinafter called the "The Guarantor" (which expression shall unless repugnant to the context or meaning thereof be deemed to include its successors and assigns) in favour of M/s Bharat Heavy Electrical Limited (A Govt. of India Undertaking) a company incorporated under the Companies Act, 1956, having its registered office at BHEL House, Siri Fort, Asiad, New Delhi – 110049 through its unit at <Address of Power Sector Region¹> hereinafter called "The Company" (which expression shall unless repugnant to the context or meaning thereof be deemed to include its successors and assigns)

WHEREAS < Contractor's Name and Address > (hereinafter referred to as the Contractor) have entered into a contract arising out of Letter of Intent no. < LOI REF & Date > (hereinafter referred to as "the contract") for < Name of Work > with the company.

AND WHEREAS the contract inter-alia provides that the contractor shall furnish to the company a sum of Rs.----- (Rupees -----) towards security deposit for due and faithful performance of the contract in the form and manner specified therein.

AND WHEREAS the contractor has approached the Guarantor and in consideration of the arrangement arrived at between the contractor and the Guarantor, the Guarantor has agreed to give the Guarantee as hereinafter mentioned in favour of the company.

The Guarantor do hereby guarantee to the company the due and faithful performance, observance or discharge of the Contract by the contractor and further unconditionally and irrevocably undertake to pay to the Company without demur and merely on a demand, to the extent of Rs.----- (Rupees-----) against any claim by the company on them for any loss, damage, costs, charges and expenses caused to or suffered by the company by reasons of the contractor making any default in the performance, observance or discharge of the terms, conditions, stipulations or undertakings or any of them as contained in the contract.

The decision of the company whether any default has occurred or has been committed by the contractor in the performance, observance or discharge of any of the terms, conditions, stipulations or undertakings or any one of them as contained in the contract and / or as to the extent of loss, damage, costs, charges and expenses caused to or suffered by the company by reason of the contractor making any default in the performance, observance or discharge of any of the terms, conditions, stipulations or undertakings or any one of them shall be conclusive and binding on the Guarantor irrespective of the fact whether the contractor admits or denies the default or questions the correctness of any demand made by the company in any Court, Tribunal or Arbitration proceedings or before any other Authority.

The company shall have the fullest liberty without affecting in any way the liability of the Guarantor under this Guarantee, from time to time to vary any of the terms and conditions of the contract or extend time of performance by the contractor or to postpone for any time and from time to time any of the powers exercisable by it against the contractor and either enforce or forbear from enforcing any of the terms and conditions governing the contract or securities available to the company and the Guarantor shall not be released from its liability under these presents by any exercise by the company of the liberty with reference to the matters aforesaid or by reasons of time being given to the contractor or any other forbearance, act or commission on the part of the company or any indulgence by the company to the contractor or any other matter or thing whatsoever which under the law relating to sureties would, but for this provision have the effect of so releasing the Guarantor from its liability under this guarantee.

The Guarantor further agrees that the Guarantee herein contained shall remain in full force and effect during the period that would be taken for the performance of the contract and its claim satisfied or discharged and till the company certifies that the terms and conditions of the contract have been fully and properly carried out by the contractor and accordingly discharges this Guarantee, subject however, that the company shall have no claim under this Guarantee after -- ----- i.e. (3 months more than the present date of validity of Bank Guarantee unless the date of validity of this Bank Guarantee is further extended from time to time, as the case may be) unless a notice of the claim under this Guarantee has been served on the Guarantor before the expiry of the said period in which case the same shall be enforceable against the Guarantor notwithstanding the fact that the same is enforced after the expiry of the said period.

FORMS & PROCEDURES

Tender No: BHEL: MSTPP: C- RW: CSD: 22:10:06

The Guarantor undertakes not to revoke this Guarantee during the period it is in force except with the previous consent of the Company in writing and agrees that any liquidation or winding up or insolvency or dissolution or any change in the constitution of the contractor or the Guarantor shall not discharge the Guarantor's liability hereunder.

It shall not be necessary for the company to proceed against the contractor before proceeding against the Guarantor and the Guarantee herein contained shall be enforceable against them notwithstanding any security which the Company may have obtained or obtain from the Contractor shall at the time when proceedings are taken against the Guarantor hereunder be outstanding or unrealized.

Notwithstanding anything contained herein before, our liability under the Guarantee is restricted to Rs.----- (Rupees-----). Our guarantee shall remain in force until-----, i.e. (the present date of validity of Bank Guarantee unless the date of validity of this Bank Guarantee is further extended from time to time) unless a claim or demand under this guarantee is made against us on or before ----- (3 Months more than the validity date) we shall be discharged from our liabilities under this Guarantee thereafter.

Any claim or dispute arising under the terms of this documents shall only be enforced or settled in the courts of at < **Name of place²** > only.

The Guarantor hereby declares that it has power to execute this guarantee and the executant has full powers to do so on behalf of the Guarantor.

IN WITNESS whereof the----- (Bank) has hereunto set and subscribed its hand the day, month and year first, above written.

(Name of the Bank)

Signed for and on behalf of the Bank
(Designation of the Authorized Person Signing the Guarantee)

(Signatory No -----)

DATED:

SEAL

Notes :

1. **Address of Power Sector Regions (inviting the Tender)** is as below:
 - PSNR : Bharat Heavy Electricals Limited, Power Sector Northern Region, HRDI & PSNR Complex, Plot No 25, Sector 16-A, Noida – 201 301 (Uttar Pradesh)
 - PSER : Bharat Heavy Electricals Limited, Power Sector Eastern Region, BHEL Bhawan, Plot No 9/1, DJ Block, Sector-II, Salt lake City, Kolkata – 700 091
 - PSWR: Bharat Heavy Electricals Limited, Power Sector Western Region, Shree Mohini Complex, 345 Kingsway, Nagpur 440 001
 - PSSR: Bharat Heavy Electricals Limited, Power Sector Southern Region, 690, Anna Salai, Nandanam, Chennai 600 035
2. **Name of place (for jurisdiction of Courts)** is as below:
 - PSNR : Delhi
 - PSER : Kolkata
 - PSWR: Nagpur
 - PSSR : Chennai
3. The BG shall be executed on non-judicial stamp papers of adequate value procured in the name of the Bank in the State where the Bank is located.
4. The BG is required to be sent by the executing Bank directly to BHEL at the address where tender is submitted / accepted under sealed cover.

FORMS & PROCEDURES

Tender No: BHEL: MSTPP: C- RW: CSD: 22:10:06

BANK GUARANTEE FOR RELEASE OF AMOUNTS WITHHELD/LIQUIDATED DAMAGES AMOUNT

Bank Guarantee No:

Date:

To

NAME

& ADDRESSES OF THE BENEFICIARY

Dear Sirs,

In consideration of the Bharat Heavy Electricals Limited ¹(hereinafter referred to as the 'Employer' which expression shall unless repugnant to the context or meaning thereof, include its successors and permitted assigns) incorporated under the Companies Act, 1956 and having its registered office at BHEL House, Siri Fort, Asiad, New Delhi – 110049 through its Unit at Bharat Heavy Electricals Limited, Power Sector Eastern Region, BHEL Bhawan, Plot No 9/1, DJ Block, Sector-II, Salt lake City, Kolkata – 700091 having awarded to (Name of the Vendor / Contractor / Supplier) incorporated under thehaving its registered office at _____¹(hereinafter referred to as the 'Contractor', which expression shall unless repugnant to the context or meaning thereof, include its successors and permitted assigns), a contract Ref No.....dated²valued at Rs.....(Rupees-----) for <Nature of Work>³(hereinafter called the 'Contract')

The Contractor as per Contract should have completed the work/ supplies under the contract by(date). As per terms and conditions of the Contract, the Employer is entitled to levy Liquidated Damages (LD) for delays and the Employer has withheld an amount of Rs..... by way of LD as per the Contract. Now, on the request of the Contractor, the Employer having agreed to release the amount of Rs... ..withheld from the Contractor's invoices as Liquidated damages under the terms and conditions of the Contract on production of a Bank Guarantee for Rs. _____(Rupees... ..only)⁴

We,, (hereinafter referred to as the Bank), having registered/Head office atand inter alia a branch at being the Guarantor under this Guarantee, hereby irrevocably and unconditionally undertake to forthwith and immediately pay to the Employer a maximum amount of Rs ----- (Rupees -----) without any demur, merely on a demand from the Employer

Any such demand made on the Bank shall be conclusive as regards the amount due and payable by the Bank under this guarantee. However, our liability under this guarantee shall be restricted to an amount not exceeding Rs. _____

FORMS & PROCEDURES

Tender No: BHEL: MSTPP: C- RW: CSD: 22:10:06

We undertake to pay to the Employer any money so demanded notwithstanding any dispute or disputes raised by the Contractor/ Supplier in any suit or proceeding pending before any Court or Tribunal relating thereto our liability under this present being absolute and unequivocal.

The payment so made by us under this Guarantee shall be a valid discharge of our liability for payment thereunder and the contractors/supplier shall have no claim against us for making such payment.

We the.....bank further agree that the guarantee herein contained shall remain in full force and effect during the period that would be taken for the performance of the said Contract and that it shall continue to be enforceable till all the dues of the Employer under or by virtue of the said Contract have been fully paid and its claims satisfied or discharged.

We BANK further agree with the Employer that the Employer shall have the fullest liberty without our consent and without affecting in any manner our obligations hereunder to vary any of the terms and conditions of the said Contract or to extend time of performance by the said Contractor/Supplier from time to time or to postpone for any time or from time to time any of the powers exercisable by the Employer against the said Contractor/Supplier and to forbear or enforce any of the terms and conditions relating to the said Agreement and we shall not be relieved from our liability by reason of any such variation, or extension being granted to the said Contractor/Supplier or for any forbearance, act or omission on the part of the Employer or any indulgence by the Employer to the said Contractor/Supplier or by any such matter or thing whatsoever which under the law relating to sureties would but for this provision have effect of so relieving us.

The Bank also agrees that the Employer at its option shall be entitled to enforce this Guarantee against the Bank as a principal debtor, in the first instance without proceeding against the Contractor and notwithstanding any security or other guarantee that the Employer may have in relation to the Contractor's/ Supplier's liabilities.

This Guarantee shall remain in force upto and including.....⁵ and shall be extended from time to time for such period as may be desired by Employer.

This Guarantee shall not be determined or affected by liquidation or winding up, dissolution or change of constitution or insolvency of the Contractor/Supplier but shall in all respects and for all purposes be binding and operative until payment of all money payable to the Employer in terms thereof.

Unless a demand or claim under this guarantee is made on us in writing on or before the⁶ (3 months more than the present date of validity of Bank Guarantee) we shall be discharged from all liabilities under this guarantee thereafter.

FORMS & PROCEDURES

Tender No: BHEL: MSTPP: C- RW: CSD: 22:10:06

We, BANK lastly undertake not to revoke this guarantee during its currency except with the previous consent of the Employer in writing.

Notwithstanding anything to the contrary contained hereinabove:

- a) The liability of the Bank under this Guarantee shall not exceed.....⁷
- b) This Guarantee shall be valid up to.....⁸
- c) Unless the Bank is served a written claim or demand on or before_____⁹ (3 months more than the present date of validity of Bank Guarantee) all rights under this guarantee shall be forfeited and the Bank shall be relieved and discharged from all liabilities under this guarantee irrespective of whether or not the original bank guarantee is returned to the Bank.

We,_____Bank, have power to issue this Guarantee under law and the undersigned as a duly authorized person has full powers to sign this Guarantee on behalf of the Bank.

Any claim or dispute arising under the terms of this document shall only be enforced or settled in the courts of at Kolkata only.

For and on behalf of
(Name of the Bank)

Dated.....

Place of Issue.....

¹ NAME AND ADDRESS OF THE VENDOR /CONTRACTOR / SUPPLIER.

² DETAILS ABOUT THE NOTICE OF AWARD/CONTRACT REFERENCE

³ PROJECT/SUPPLY DETAILS

⁴ BG AMOUNT IN FIGURES AND WORDS

⁵ VALIDITY DATE

FORMS & PROCEDURES

Tender No: BHEL: MSTPP: C- RW: CSD: 22:10:06

⁶ DATE OF EXPIRY OF CLAIM PERIOD

⁷ BG AMOUNT IN FIGURES AND WORDS.

⁸ VALIDITY DATE

⁹ DATE OF EXPIRY OF CLAIM PERIOD

Note:

1. Units are advised that expiry of claim period may be kept 2/3 months after validity date.
2. In Case of Bank Guarantees submitted by Foreign Vendors-
 - a. **From Nationalized/Public Sector / Private Sector/ Foreign Banks (BG issued by Branches in India)** can be accepted subject to the condition that the Bank Guarantee should be enforceable in the town/city or at nearest branch where the Unit is located i.e. Demand can be presented at the Branch located in the town/city or at nearest branch where the Unit is located.
 - b. **From Foreign Banks (wherein Foreign Vendors intend to provide BG from local branch of the Vendor country's Bank)**
 - b.1 In such cases, in the Tender Enquiry/ Contract itself, it may be clearly specified that Bank Guarantee issued by **any of the Consortium Banks only** will be accepted by BHEL. As such, Foreign Vendor needs to make necessary arrangements for issuance of Counter- Guarantee by Foreign Bank in favour of the Indian Bank (BHEL's Consortium Bank). It is advisable that all charges for issuance of Bank Guarantee/ counter- Guarantee should be borne by the Foreign Vendor. The tender stipulation should clearly specify these requirements.
 - b.2 **In case, Foreign Vendors intend to provide BG from Overseas Branch of our Consortium Bank** (e.g. if a BG is to be issued by SBI Frankfurt), the same is acceptable. However, the procedure at **sl.no. b.1** will required to be followed.
 - b.3 The BG issued may preferably be subject to Uniform Rules for Demand Guarantees (URDG) 758 (as amended from time to time). In case, of Foreign Vendors, the BG Format provided to them should clearly specify the same.
 - b.4 The BG should clearly specify that the demand or other document can be presented in electronic form.

BANK GUARANTEE FOR SUPPLY FREE ISSUE MATERIAL.

Bank Guarantee No:

Date:

To

NAME

& ADDRESSES OF THE BENEFICIARY

Dear Sirs,

In consideration of the Bharat Heavy Electricals Limited (hereinafter referred to as the 'Employer' which expression shall unless repugnant to the context or meaning thereof, include its successors and permitted assigns) incorporated under the Companies Act, 1956 and having its registered office at BHEL House, Siri Fort, Asiad, New Delhi – 110049 through its Unit at Bharat Heavy Electricals Limited, Power Sector Eastern Region, BHEL Bhawan, Plot No 9/1, DJ Block, Sector-II, Salt lake City, Kolkata – 700091 having awarded to (Name of the Vendor / Contractor / Supplier).having its registered office at _____¹ (hereinafter referred to as the 'Contractor/Supplier/Fabricator' which expression shall unless repugnant to the context or meaning thereof, include its successors and permitted assigns), a contract Ref. No dated² valued at Rs.....(Rupees -----) for <Nature of Work>³ (hereinafter called the 'Contract')

and, the Employer having agreed as per the terms and conditions of the Contract to supply free issue material costing Rs._____ for the manufacture/fabrication of the equipment at the Contractor's site on on furnishing a Bank Guarantee for Rs._____ (Rupees)⁴ in the manner hereinafter specified for the due safeguard of the free issue material,

we,, (hereinafter referred to as the Bank), having registered/Head office atand inter alia a branch at being the Guarantor under this Guarantee, hereby irrevocably and unconditionally undertake to forthwith and immediately pay to the Employer a maximum amount of Rs ----- (Rupees -----) without any demur, merely on a demand from the Employer, .

Any such demand made on the Bank shall be conclusive as regards the amount due and payable by the Bank under this guarantee. However, our liability under this guarantee shall be restricted to an amount not exceeding Rs. _____

FORMS & PROCEDURES

Tender No: BHEL: MSTPP: C- RW: CSD: 22:10:06

We undertake to pay to the Employer any money so demanded notwithstanding any dispute or disputes raised by the Contractor/ Supplier in any suit or proceeding pending before any Court or Tribunal relating thereto our liability under this present being absolute and unequivocal.

The payment so made by us under this Guarantee shall be a valid discharge of our liability for payment hereunder and the Contractors/Supplier shall have no claim against us for making such payment.

We the..... Bank further agree that the guarantee herein contained shall remain in full force and effect during the period that would be taken for the performance of the said Contract and that it shall continue to be enforceable till all the dues of the Employer under or by virtue of the said Contract have been fully paid and its claims satisfied or discharged.

We Bank further agree that the Employer shall have the fullest liberty without our consent and without affecting in any manner our obligations hereunder to vary any of the terms and conditions of the said Contract or to extend time of performance by the said Contractor/Supplier from time to time or to postpone for any time or from time to time any of the powers exercisable by the Employer against the said Contractor/Supplier and to forbear or enforce any of the terms and conditions relating to the said Agreement and we shall not be relieved from our liability by reason of any such variation, or extension being granted to the said Contractor/Supplier or for any forbearance, act or omission on the part of the Employer or any indulgence by the Employer to the said Contractor/Supplier or by any such matter or thing whatsoever which under the law relating to sureties would but for this provision have effect of so relieving us.

The Bank also agrees that the Employer at its option shall be entitled to enforce this Guarantee against the Bank as a principal debtor, in the first instance without proceeding against the Contractor/Supplier/ Fabricator and notwithstanding any security or other guarantee that the Employer may have in relation to the Contractor's/Supplier's/ Fabricator's liabilities.

This Guarantee shall remain in force upto and including.....⁵ and shall be extended from time to time for such period as may be desired by Employer.

This Guarantee shall not be determined or affected by liquidation or winding up, dissolution or change of constitution or insolvency of the Contractor/ Supplier/ Fabricator but shall in all respects and for all purposes be binding and operative until payment of all money payable to the Employer in terms thereof.

FORMS & PROCEDURES

Tender No: BHEL: MSTPP: C- RW: CSD: 22:10:06

Unless a demand or claim under this guarantee is made on us in writing on or before the⁶ (3 months more than the present date of validity of Bank Guarantee) we shall be discharged from all liabilities under this guarantee thereafter.

We, BANK lastly undertake not to revoke this guarantee during its currency except with the previous consent of the Employer in writing.

Notwithstanding anything to the contrary contained hereinabove:

- a) The liability of the Bank under this Guarantee shall not exceed.....⁷
- b) This Guarantee shall be valid up to.....⁸
- c) Unless the Bank is served a written claim or demand on or before.....⁹ (3 months more than the present date of validity of Bank Guarantee) all rights under this guarantee shall be forfeited and the Bank shall be relieved and discharged from all liabilities under this guarantee irrespective of whether or not the original bank guarantee is returned to the Bank.

We,.....Bank, have power to issue this Guarantee under law and the undersigned as a duly authorized person has full powers to sign this Guarantee on behalf of the Bank.

Any claim or dispute arising under the terms of this document shall only be enforced or settled in the courts of at Kolkata only.

For and on behalf of
(Name of the Bank)

Dated.....

Place of Issue.....

¹ NAME AND ADDRESS OF THE VENDOR /CONTRACTOR / SUPPLIER .

² DETAILS ABOUT THE NOTICE OF AWARD/CONTRACT REFERENCE

³ PROJECT/SUPPLY DETAILS

⁴ BG AMOUNT IN FIGURES AND WORDS

⁵ VALIDITY DATE

⁶ DATE OF EXPIRY OF CLAIM PERIOD

⁷ BG AMOUNT IN FIGURES AND WORDS.

⁸ VALIDITY DATE

⁹ DATE OF EXPIRY OF CLAIM PERIOD

Note:

1. Units are advised that expiry of claim period may be kept 2/3 months after validity date.
2. In Case of Bank Guarantees submitted by Foreign Vendors-
 - a. **From Nationalized/Public Sector / Private Sector/ Foreign Banks (BG issued by Branches in India)** can be accepted subject to the condition that the Bank Guarantee should be enforceable in the town/city or at nearest branch where the Unit is located i.e. Demand can be presented at the Branch located in the town/city or at nearest branch where the Unit is located.
 - b. **From Foreign Banks (wherein Foreign Vendors intend to provide BG from local branch of the Vendor country's Bank)**
 - b.1 In such cases, in the Tender Enquiry/ Contract itself, it may be clearly specified that Bank Guarantee issued by **any of the Consortium Banks only** will be accepted by BHEL. As such, Foreign Vendor needs to make necessary arrangements for issuance of Counter- Guarantee by Foreign Bank in favour of the Indian Bank (BHEL's Consortium Bank). It is advisable that all charges for issuance of Bank Guarantee/ counter- Guarantee should be borne by the Foreign Vendor. The tender stipulation should clearly specify these requirements.
 - b.2 **In case, Foreign Vendors intend to provide BG from Overseas Branch of our Consortium Bank** (e.g. if a BG is to be issued by SBI Frankfurt), the same is acceptable. However, the procedure at **sl.no. b.1** will required to be followed.
 - b.3 The BG issued may preferably be subject to Uniform Rules for Demand Guarantees (URDG) 758 (as amended from time to time). In case, of Foreign Vendors, the BG Format provided to them should clearly specify the same.
 - b.4 The BG should clearly specify that the demand or other document can be presented in electronic form.

FORMS & PROCEDURES

Tender No: BHEL: MSTPP: C- RW: CSD: 22:10:06

PROFORMA OF BANK GUARANTEE FOR EARNEST MONEY
(On non-Judicial paper of appropriate value)

Bank Guarantee No.....

Date.....

To

(Employer's Name and Address)
.....

Dear Sirs,

In accordance with the terms and conditions of your Invitation for Bids/Notice Inviting Tender No¹(Tender Conditions) M/ s. having its registered office at² (hereinafter referred to as the 'Tenderer'), is submitting its bid for the work of..... for.....³ . at Bharat Heavy Electricals Limited, Power Sector Eastern Region, BHEL Bhawan, Plot No 9/ 1, DJ Block, Sector- II, Salt lake City, Kolkata – 700091.⁴(name of the Employer)

The Tender Conditions provide that the **Tenderer** shall pay a sum of Rs as Earnest Money Deposit in the form therein mentioned. The form of payment of Earnest Money Deposit includes Bank Guarantee executed by a Scheduled Bank.

In lieu of the stipulations contained in the aforesaid Tender Conditions that an irrevocable and unconditional Bank Guarantee against Earnest Money Deposit for an amount of⁵..... is required to be submitted by the Tenderer as a condition precedent for participation in the said Tender and the Tenderer having approached us for giving the said Guarantee,,

we, the[Name & address of the Bank] having our Head Office at(hereinafter referred to as the Bank) being the Guarantor under this Guarantee, hereby irrevocably and unconditionally undertake to forthwith and immediately pay to the Employer without any demur, merely on your first demand any sum or sums of Rs.⁵(*).....without any reservation, protest, and recourse and without the beneficiary needing to prove or demonstrate reasons for its such demand. Any such demand made by the 'Employer' shall be

FORMS & PROCEDURES

Tender No: BHEL: MSTPP: C- RW: CSD: 22:10:06

conclusive and binding on us irrespective of any dispute or difference raised by the Tenderer.

The payment so made by us under this Guarantee shall be a valid discharge of our liability for payment hereunder and the Tenderer shall have no claim against us for making such payment.

We Bank further agree that the Employer shall have the fullest liberty without our consent and without affecting in any manner our obligations hereunder to vary any of the terms and conditions of the said Tender or to extend the time of submission of bids from time to time or to postpone for any time or from time to time any of the powers exercisable by the Employer against the said Tenderer and we shall not be relieved from our liability by reason of any such variation, or extension being granted to the said Tendered or for any forbearance, act or omission on the part of the Employer or any indulgence by the Employer to the said Tenderer or by any such matter or thing whatsoever which under the law relating to sureties would but for this provision have effect of so relieving us.

The Bank also agrees that the Employer at its option shall be entitled to enforce this Guarantee against the Bank as a principal debtor, in the first instance without proceeding against the Tenderer and notwithstanding any security or other guarantee that the Employer may have in relation to the Tenderer's liabilities.

This Guarantee shall be irrevocable and shall remain in force upto and including.....⁶ and shall be extended from time to time for such period as may be desired by the Employer.

This Guarantee shall not be determined or affected by liquidation or winding up, dissolution or change of constitution or insolvency of the Tenderer but shall in all respects and for all purposes be binding and operative until payment of all money payable to the Employer in terms hereof. However, unless a demand or claim under this Guarantee is made on us in writing on or before the⁷ we shall be discharged from all liabilities under this Guarantee.

We, Bank lastly undertake not to revoke this guarantee during its currency except with the previous consent of the Employer in writing.

FORMS & PROCEDURES

Tender No: BHEL: MSTPP: C- RW: CSD: 22:10:06

Notwithstanding anything to the contrary contained hereinabove:

- a) The liability of the Bank under this Guarantee shall not exceed.....5.....
- b) This Guarantee shall be valid up to6
- c) Unless the Bank is served a written claim or demand on or before _____⁷ all rights under this guarantee shall be forfeited and the Bank shall be relieved and discharged from all liabilities under this guarantee irrespective of whether or not the original bank guarantee is returned to the Bank

We, _____ Bank, have power to issue this Guarantee under law and the undersigned as a duly authorized person has full powers to sign this Guarantee on behalf of the Bank.

For and on behalf of

(Name of the Bank)

Date.....

Place of Issue.....

¹ *Details of the Invitation to Bid/Notice Inviting Tender*

² *Name and Address of the Tenderer*

³ *Details of the Work*

⁴ *Name and Address of BHEL Unit/Division/Region (Already filled up)*

⁵ *BG Amount in words and Figures*

⁶ *Validity Date*

⁷ *Date of Expiry of Claim Period*

Note:

1. Units are advised that expiry of claim period may be kept 2/3 months after validity date. As per Works Policy, the Bank Guarantee shall be valid for at least six months.

2. In Case of Bank Guarantees submitted by Foreign Vendors-

FORMS & PROCEDURES

Tender No: BHEL: MSTPP: C- RW: CSD: 22:10:06

- a. **From Nationalized/Public Sector / Private Sector/ Foreign Banks (BG issued by Branches in India)** can be accepted subject to the condition that the Bank Guarantee should be enforceable in the town/city or at nearest branch where the Unit is located i.e. Demand can be presented at the Branch located in the town/city or at nearest branch where the Unit is located.
- b. **From Foreign Banks (wherein Foreign Vendors intend to provide BG from local branch of the Vendor country's Bank)**
 - b.1 In such cases, in the Tender Enquiry/ Contract itself, it may be clearly specified that Bank Guarantee issued by **any of the Consortium Banks only** will be accepted by BHEL. As such, Foreign Vendor needs to make necessary arrangements for issuance of Counter- Guarantee by Foreign Bank in favour of the Indian Bank (BHEL's Consortium Bank). It is advisable that all charges for issuance of Bank Guarantee/ counter-Guarantee should be borne by the Foreign Vendor. The tender stipulation should clearly specify these requirements.
 - b.2 **In case, Foreign Vendors intend to provide BG from Overseas Branch of our Consortium Bank** (e.g. if a BG is to be issued by SBI Frankfurt), the same is acceptable. However, the procedure at **sl.no. b.1** will required to be followed.
 - b.3 The BG issued may preferably be subject to Uniform Rules for Demand Guarantees (URDG) 758 (as amended from time to time). In case, of Foreign Vendors, the BG Format provided to them should clearly specify the same.
 - b.4 The BG should clearly specify that the demand or other document can be presented in electronic form.

CONTENTS

CLAUSE NO	DESCRIPTION
1.0	PROJECT SYNOPSIS AND GENERAL INFORMATION
2.0	SCOPE OF THE CONTRACT
3.0	SITE VISIT
4.0	TOOLS & PLANTS
5.0	MATERIAL HANDLING-ISUUE OF STEEL RECONCILATION
6.0	INSPECTION, TESTING AND INSPECTION CERTIFICATES
7.0	INSURANCE
8.0	DEVIATIONS/ CLARIFICATIONS
9.0	DEWATERING
10.0	TIME SCHEDULE/ COMPLETION PERIOD
11.0	PRICE BID, CONTRACT PRICE & EVALUATION OF PRE-QUALIFICATION CRITERIA
12.0	TERMS OF PAYMENT
13.0	DELETED
14.0	TAXES AND DUTIES
15.0	PROJECT MANAGEMENT/ CONSTRUCTION MANAGEMENT
16.0	QUALITY CONTROL & QUALITY ASSURANCE
17.0	QUALITY ASSURANCE PROGRAMME
18.0	GENERAL REQUIREMENTS – QUALITY ASSURANCE
19.0	HEALTH, SAFETY & ENVIRONMENT
20.0	SPECIFIC REQUIREMENTS FOR ISO 9002
21.0	INTEREST BEARING RECOVERABLE ADVANCE/ MOBILISATION ADVANCE
22.0	OVER RUN CHARGES
23.0	REVISION ON ACCEPTED CONTRACT RATE
24.0	PRICE VARIATION CLAUSE/ ESCALATION
25.0	LIQUIDATED DAMAGE
26.0	GUARANTEE / WARRANTY
27.0	EXTENSION OF TIME FOR COMPLETION
28.0	EARNEST MONEY DEPOSIT (EMD), SECURITY DEPOSIT(SD) AND PERFORMANCE BOND (PB)
29.0	CERTIFICATE TOWARDS COMPLETION
30.0	CIVIL LABORATORY
31.0	CONSTRUCTION SCHEDULE
32.0	PAYMENT FOR ADDITIONAL/EXTRA ITEMS FOR CIVIL FOUNDATION WORKS
33.0	Deleted
34.0	TOOLS & PLANTS (TO BE PROVIDED BY CONTRACTOR)
35.0	TOOLS & PLANTS (TO BE PROVIDED BY BHEL)
36.0	OTHER TERMS

1.0 PROJECT SYNOPSIS AND GENERAL INFORMATION

1.1 The 2 x 660 MW MAITREE SUPER THERMAL POWER PROJECT is located in Moithara Village, Rampal Upazila, Bagerhat District, Bangladesh.

The Bidder shall acquaint himself by a visit to the site, with the conditions prevailing at site before submission of the bid. The information given here in under is for general guidance and shall not be contractually binding on the Owner. All relevant site data/information as may be necessary shall have to be obtained / collected by the Bidder.

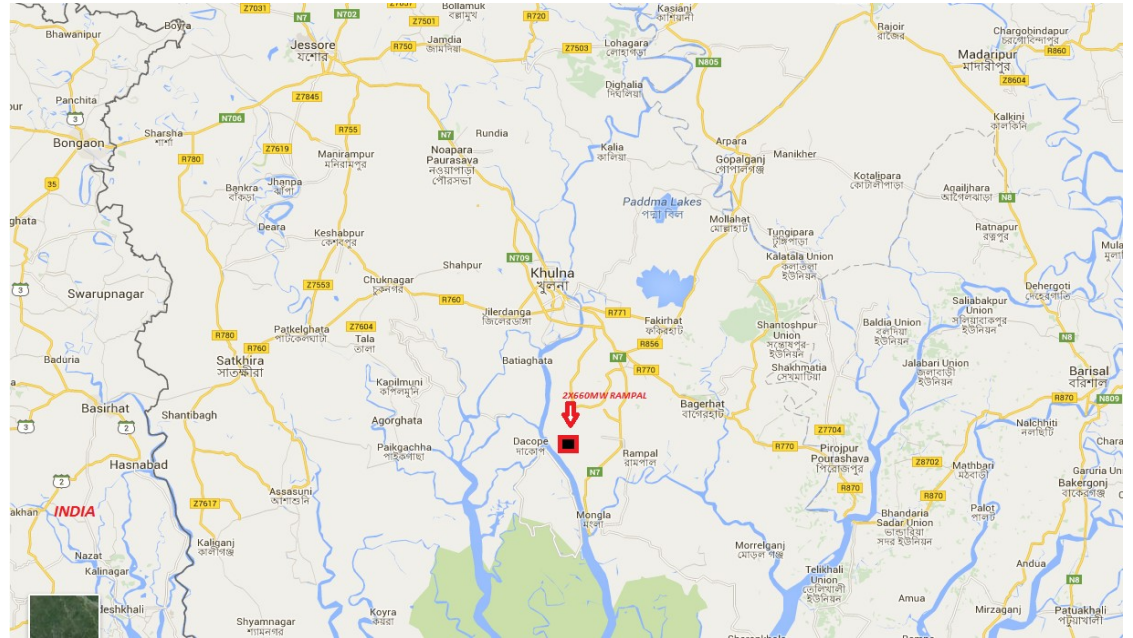

LOCATION MAP:2X660MW MAITREE RAMPAL PROJECT



	LOCATION MAP:2X660MW MAITREE RAMPAL PROJECT																										
1.2	APPROACH TO SITE																										
	The nearest town Khulna is at a distance of 23 km from project site. The site is Connected by road from Mongla- Khulna Highway. Nearest Domestic airport is Jessore, Bangladesh at a distance of about 93 KM and international airport is Dhaka at a distance of 263 KM, Bangladesh																										
1.3	Owner: BIFPCL (BANGLADESH-INDIA FRIENDSHIP POWER COMPANY (PVT.) LIMITED)																										
2.0	SCOPE OF THE CONTRACT																										
2.1	BUILDINGS/STRUCTURES																										
	PILE CAP (EXCEPT PILING), CIVIL FOUNDATION & SUPERSTRUCTURE, ARCHITECTURAL & STRUCTURAL WORKS OF CONSTRUCTION SHED AND PART BALANCE WORKS OF ROOF WATER PROOFING FOR AUX & BOP BUILDINGS FOR 2 X 660 MW MAITREE STPP, RAMPAL, BANGLADESH.																										
	Name of Buildings / Structures																										
	<table border="1"> <tr> <td>Construction Sheds (10 Nos)</td> <td></td> </tr> <tr> <td>Raw Water Intake Pump House & Elect Annexe Building</td> <td></td> </tr> <tr> <td>Raw Water Chlorination Building</td> <td></td> </tr> <tr> <td>CW Pump House and Elect Annexe Building</td> <td></td> </tr> <tr> <td>PT Plant Chemical House</td> <td></td> </tr> <tr> <td>RODM Control Building</td> <td></td> </tr> <tr> <td>Re-mineralization Building</td> <td></td> </tr> <tr> <td>Bulk Chemical Storage Building</td> <td></td> </tr> <tr> <td>Desalination Water Pump House Building</td> <td></td> </tr> <tr> <td>Weigh Bridge</td> <td></td> </tr> <tr> <td>Boundary Wall</td> <td></td> </tr> <tr> <td>Miscellaneous Structures / cable pull pit / cable trench / pipe support pedestal / duct bank / culvert, paver block, etc</td> <td></td> </tr> <tr> <td>STP network civil works</td> <td></td> </tr> </table>	Construction Sheds (10 Nos)		Raw Water Intake Pump House & Elect Annexe Building		Raw Water Chlorination Building		CW Pump House and Elect Annexe Building		PT Plant Chemical House		RODM Control Building		Re-mineralization Building		Bulk Chemical Storage Building		Desalination Water Pump House Building		Weigh Bridge		Boundary Wall		Miscellaneous Structures / cable pull pit / cable trench / pipe support pedestal / duct bank / culvert, paver block, etc		STP network civil works	
Construction Sheds (10 Nos)																											
Raw Water Intake Pump House & Elect Annexe Building																											
Raw Water Chlorination Building																											
CW Pump House and Elect Annexe Building																											
PT Plant Chemical House																											
RODM Control Building																											
Re-mineralization Building																											
Bulk Chemical Storage Building																											
Desalination Water Pump House Building																											
Weigh Bridge																											
Boundary Wall																											
Miscellaneous Structures / cable pull pit / cable trench / pipe support pedestal / duct bank / culvert, paver block, etc																											
STP network civil works																											
2.2	For some of the structures partial civil works is executed by other vendor and hence balance work as per drawings/specifications is to be executed.																										
2.2a	All the major balance works to meet the project requirement have been included in the scope. Bidder may also require to execute similar works in other area not covered in the list but necessary to meet the project requirement within the rates quoted as per BOQ cum Price Schedule. Such works shall be taken up as per direction of BHEL in writing. Rate quoted by bidder as per price schedule shall be inclusive of such similar works.																										
	GENERAL																										
2.3	All necessary parts, and works necessary for transport, storage and erection purposes.																										
2.4	Deleted																										
2.5	The Work shall include everything required and necessary to finish the Work properly, notwithstanding that every item of labour or materials or accessories required to make the installation complete may not be specifically mentioned.																										
2.6	Deleted																										
2.7	Deleted																										
2.8	The works to be performed under this contract consist of providing all labour, supervision, material, scaffolding, construction equipment, tools and plants, temporary																										

	works, supplies including POL, transportation and all incidental items not shown or specified but reasonably implied or necessary for the proper completion of work in all respects. Testing of all materials, concrete, earthwork other allied works, preparation of bar bending schedules on the basis of construction drawings, preparation of fabrication drawings etc. are included on the rates of items of work. Works shall only be carried out with approved drawings.
2.9	The area of work shall be cleared of all vegetation, rubbish and other objectionable matter and materials remove shall be burnt or otherwise disposed of as directed by the Engineer-in-Charge. No separate payment for these operations shall be made. The cost of all these operations shall be deemed to have been included in the unit rates rendered for the different items under bill of quantities unless specifically provided in the BOQ.
2.10	All the works areas shall be adequately flood lighted to the satisfaction of the Engineer-in-Charge when the work is in progress during the night shifts.
2.11	The unit rates shall include all material equipment, fixtures, labour construction plant, temporary works and everything whether of permanent or temporary nature necessary for the completion of job in all respects.
2.12	The unit rates for various items of B.O.Q shall include all the stipulations mentioned in Section C and technical specifications under Section D and nothing extra over B.O.Q rates shall be payable.
2.13	Drawings showing enough details for the construction as per the specification shall be furnished to the contractor in a phased manner as far as possible.
2.14	The bidder should fully apprise himself of the prevailing conditions at the proposed site, climatic conditions including monsoon pattern, local conditions, soil strata and site specific parameters and shall include for all such conditions and contingent measures in the bid, including those which may have not been specifically brought out in the specifications.
3.0	SITE VISIT
3.1	Contractor should visit site and acquire full knowledge & information about site conditions prevailing at site and in and around the plant premises together with all the statutory, obligatory, mandatory requirements of various authorities before submission of the bid. In line with the above, site visit confirmation will be required to be submitted by the bidder with the technical bid. Bidder may please note that The contractor will be responsible for the quality of workmanship, quality of materials/ items and design for which the contractor is responsible for construction of Balance structure of BOP Buildings. Even though the some part of structures will be carried out by other agency under supervision of BHEL, the successful bidder will be responsible for the above.
3.1	OPEN SPACE FOR OFFICE & STORAGE
3.1.1	Open spaces for material storage yard & construction of temporary site office may be allocated as made available by the customer / BHEL free / hire charges. Contractor has to make his own arrangements for labour colony including Electricity and water.
3.1.2	Construction of necessary stores and storage of materials shall be in contractor's scope. BHEL shall provide available space as received from customer on mutually agreed basis. Security of stores & work place shall be in Contractor's scope.
3.1.3	REMOVAL OF TEMPORARY FACILITIES

	When the Work is completed all such temporary structures and facilities shall be removed from the Site and the area shall be restored to its original condition.
3.2	WATER
3.2.1	BHEL will provide construction water at one point or at mutually agreed points within 500 m from work premises, free of cost to the contractor . Bidder to note that no ground water is allowed for construction purpose by the project authority.
3.2.2	Further necessary network for construction water system shall be done by the bidder at his own cost.
3.2.3	Contractor should arrange on their own drinking water in their labour colony.
3.2.4	BHEL shall not be responsible for any inconvenience or delay caused due to any interruption of water supply and the contractor shall claim no compensation for delay in work for such interruption. Contractor may make standby arrangement for water for which no separate payment shall be made by BHEL.
3.2.5	Contractor will have to arrange for storage of water to meet the day-to-day requirement.
3.2.6	The availability of water (construction as well as drinking) in Maitree project may be limited. Contractor shall ensure that no water is wasted. In this regard the contractor shall take all necessary measure towards preservation of water.
3.3	ELECTRICITY
3.3.1	CONSTRUCTION POWER & GENERAL ILLUMINATION NETWORK: - BHEL Shall Provide Construction Power free of charge at 415V level at one/two point (within 150 M from his workplace), bidder has to make his own distribution arrangement to draw electricity. The bidder will have to procure & install adequate area illumination system during construction right from start of his work. This system will include temporary pole lighting, portable lighting towers with sufficient DG back-up for area lighting at different working areas for execution of the work & safety of workmen within the quoted rate. The illumination should be such that minimum illumination requirement as specified in specification or any-where for general illumination is maintained.
3.3.2	The bidder shall have to provide earth leakage circuit breaker at each point wherever human operated electrical drives / T&Ps are deployed.
3.3.3	The power supply will be from the available source of customer. BHEL shall not be responsible for any inconvenience or delay caused due to any interruption of power supply / variation in voltage level and no compensation for delay in work can be claimed by the contractor due to such non-supply on the grounds of idle labour, machinery or any other grounds.
3.3.4	Bidder will have to arrange sufficient illumination at their own work areas.
3.3.5	Deleted
3.3.6	The contractor shall have to make arrangement at their own cost for illumination that will be required in the working area for execution of the work & safety of workmen.
3.3.7	The contractor shall have to make arrangement at their own cost for illumination etc. in labor colony. However there may be provision of Chargeable Power for labor colony for which contractor has to install meters and necessary accessories
4.0	TOOLS & PLANTS
4.1	All the tools and plants required for execution of the above work are in contractor's scope.

5.0	MATERIAL HANDLING (BHEL ISSUED MATERIAL)
5.1.1	Reinforcement (TMT bar) earthing Strip/Bar, structural steel (MS plate/ ISMB/ channel/ angle/chequered plate/ stainless steel plate/liner excluding embedments) only will be issued free of cost by BHEL for use in the work covered in this contract. All other materials required for proper completion of job shall be provided by the contractor and quoted rates shall be inclusive of this. Please note that BHEL will only issue the above free materials if has written in the description of the BOQ.
5.1.2	Vendor has to arrange lifting, shifting & transportation of TMT bar or other free issued material from BHEL store without any additional cost.
5.1.3	BHEL reserve the right to recover from the contractor any loss arising out of damage/ theft or any other causes of the materials issued to him at any point.
5.1.4	<p>Open land (very limited space) for storage shall be provided by BHEL on free of cost basis as per availability.</p> <p>You shall maintain one centralized fenced store cum bar bending yard (Area Approx. 50mx50m). Hard surfacing of this yard and all round drain shall be carried out by you at your own cost within the accepted rate.</p> <p>You shall make complete arrangement of necessary security personnel, to safeguard all such materials in your custody. Materials issued will be used only for construction of permanent work. You shall take care of material issued by BHEL and shall protect the same from theft, damage and weathering.</p> <p>Barbed wire fencing of the steel storage yard, reinforcement bending yard area etc. are to be done by the contractor at his own cost. Contractor shall also remove grass, bushes, trees etc. wherever required off the land provided to him and shall make proper continuous up-keepment of the open yard/ land by removing grass, bushes trees etc. and same is included under the scope of his work & no extra payment shall be made to the contractor in this regard.</p>
5.1.5	The contractor shall in no case be entitled for any compensation or damages on account of any delay in supply or non-supply thereof for all or any such material.
5.1.6	Excessive rusting of steel must be avoided. In case, due to any cause attributable to the contractor, such clotting of and/ or rusting of steel occur rendering the same unusable, then such quantity of steel shall be recovered from the interim payment at the penal rate specified in the tender.
5.1.7	No material shall be issued to the contractor except as those indicated above, i.e. steel unless otherwise expressly provided for in the contract. Contractor will have to make his own arrangement at his own cost for procurement of any other material as required for the works and of such quality as acceptable to BHEL.
5.1.8	The contractor shall maintain proper store account for all the BHEL issued materials and shall give three copies of monthly computerized reconciliation statement of such account to the BHEL.
5.1.9	Contractor shall carry out in complete association with BHEL, material management functions and execution like day to day update of materials, issued to contractor, accounting for surplus/ scrap material returned etc. These functions shall also be carried out through computerized system utilizing suitable software. Contractor shall provide experienced software personnel to associate on dedicated basis for efficient discharge of the same.
5.1.10	The contractor shall solely be responsible for the safety & quality of material after it is handed over and issued to contractor by BHEL.
5.1.11	BHEL issued materials shall not under any circumstances be taken out of the project site unless otherwise permitted by BHEL.

5.1.12	Deleted
5.1.13	No separate rate will be applicable for the above job. The contractor will quote the rate for the items inclusive of all charges for the above job.
5.1.14	Bidder's scope of handling of steel under the scope of this tender includes stacking/ storing of materials over concrete sleepers. Bidder scope shall include provision of concrete sleepers for this purpose and no separate payment against the same will be made by BHEL. After completion of the job bidder shall take back the sleepers Bidder's quoted rate/ price shall be in consideration to this.
5.2	DELETED
5.3	ISSUE OF STEEL Steel shall be provided only against those items of the BOQ where it is specifically mentioned that Steel shall be supplied by BHEL as free of cost
5.3.1	The steel shall be issued to the contractor free of cost on the following basis.
5.3.1.1	Structural steel (MS plate, angle, channel, ISMB, Stainless steel plate/Liner, chequered plate and EOT crane rails) – Weighment basis (unit – MT).
5.3.1.2	Reinforcement steel(TMT) and earthing rod (MS round) – Weighment basis (unit – MT).
5.3.2	All the steel (structural steel, reinforcement, earthing strip/bar) issued by BHEL shall be properly accounted for. The total quantity of steel required for the work will be calculated from the approved Bar Bending schedule, fabrication drawings, approved laps, chairs and lugs. The measurement for payment as well as for accounting shall be based on the sectional weights.
5.3.3	In case any such sectional weights are not available in the above documents, the manufacturer recommendation shall be binding.
5.3.4	The steel issued to the contractor shall be mainly in standard length and sections as received from the supplier. However, the contractor shall be bound to accept the steel in length as available in the project stores and no claim for extra payment because of issue of non-standard length will be entertained. BHEL Site / Store have stock of structural steel packing boxes / crates. Structural steel members from these crates / boxes may be used for miscellaneous structural steel works. These materials shall also be issued to the bidder on as is where is basis available at project site / store yard.
5.3.5	In case MS flats as required in the fabrication of structures are not available, you shall cut such width out of the available MS plates to make flats at no extra cost till such material is available and procured by BHEL.
5.3.3	The contractor shall satisfy himself of the quality and quantity of the materials at the time of taking delivery from BHEL stores. No claims whatsoever will be entertained by BHEL because of quality or quantity after the materials are taken by contractor from BHEL stores.
5.4	ISSUE OF READY MIX DESIGN(RMC):
5.4.1	The RMC shall be issued to the contractor free of cost as per item of the Price Schedule.
5.5	Quarterly requirement of steel must be positively submitted by the contractor at the last month of the previous quarter. In addition, the contractor shall also furnish the estimated requirement of steel during a month by the third week of the previous month indicating his requirement.
5.6	Bidders to ensure that no lamination materials are taken over by them from BHEL. Fabrication wastage, if any due to above, shall not be compensated by BHEL
5.7	Bidder to note that steel required for his enabling job like store/ site office etc. shall be arranged at his own cost.
5.8	RETURN OF MATERIALS
5.8.1	RETURN OF STEEL INCLUDING SCRAP
5.8.1.1	All surplus steel and all wastage materials will be taken back on weighment basis.

5.8.1.2	Surplus, unused and un-tampered steel shall be sorted section-wise and returned separately at a place directed by BHEL/ engineer within the project area. Return of such materials will not be entitled to any handling and incidental charges.		
5.8.1.3	Scrap generated after reconciliation shall be the property of BHEL. All wastage/ scrap (including wastage, unusable scrap) shall be returned to the stores on weighment basis and a receipt obtained for material accounting purposes. Return of such material will not be entitled to any additional cost due to handling and transportation and incidental charge.		
5.8.1.4	Scrap for reinforcement steel and structural steel shall be returned separately		
5.9	RMC & STEEL CONSUMPTION AND WASTAGE		
5.9.1	READY MIX CONCRETE (RMC) WASTAGE		
5.9.1.1	Allowable wastage – One and half (+1.5%) of theoretical consumption of RMC unless specified otherwise in the technical specification.		
5.9.1.2	For any material issued by BHEL to the contractor free of cost, and which is not accounted for by the contractor to BHEL, then recovery for such material shall be affected at penal rates.		
	SL	RMC consumption	Basis of issue & penal recovery
	C-1	Theoretical consumption (without considering any wastage or loss).	Free
	C-2	Actual consumption being Limited to plus one and half percent (+1.5%) of aforesaid theoretical consumption towards allowable wastage.	Free
	C-3	Actual consumption beyond one and half percent (+1.5%) of above (C-1).	Penal rate
5.9.5	REINFORCEMENT STEEL CONSUMPTION		
5.9.5.1	The theoretical consumption of various diameters of reinforcement and earthing MS round shall be based on approved construction drawing and bar bending schedule. Weight shall be calculated considering the sectional weights as per Indian standards. No extra cost shall be payable to the contractor for any deviation in weights for the different procedures adopted for issue and calculation of the theoretical consumption including rolling tolerances.		
5.9.5.2	Actual consumption = Issue – Surplus		
5.9.5.3	Surplus = Un-tampered and unused quantity of steel returned by the contractor to BHEL store along-with relevant documents. However, cut pieces of length greater than or equal to 5.0 m in good condition as per judgement of the engineer shall be treated as surplus steel. If contractor deposits/returns steel more than the allowable wastage quantity to BHEL as specified in clause No. 5.10.1 & 5.12.1 then same quantity will be considered for penal recoveries.		
5.9.5.4	Wastage = Actual consumption – Theoretical consumption.		
5.10	REINFORCEMENT STEEL WASTAGE		
5.10.1	Allowable wastage – Three Percent (+3%) of the theoretical consumption shall be considered as allowable wastage.		
5.10.2	Wastage and scrap shall be as per actual weighment basis.		
	SL	Reinforcement steel	Basis of issue & penal recovery
	R-1	Theoretical consumption (without considering wastage and scrap or loss)	Free
	R-2	Wastage limited to plus three percent (+3%) of aforesaid theoretical consumption (R-1) towards allowable wastage.	Free

	R-3	Wastage beyond three percent (+3%) of the theoretical consumption above (R-1).	Penal rate
5.11	STRUCTURAL STEEL CONSUMPTION		
5.11.1	Deleted		
5.12	Deleted		
5.13	COPPER STRIP/BAR/CONDUCTOR CONSUMPTION		
5.13.1	The theoretical consumption of various sections shall be based on approved drawings. Weights shall be calculated considering the sectional weights as per Indian standard as mentioned in relevant clause. No extra shall be payable to the contractor for any deviation in weights for the two different procedures adopted for issue and calculation of the theoretical consumption including rolling tolerances.		
5.13.2	Actual consumption = Issue – Surplus.		
5.13.3	Surplus = Un-tempered, unused, uncut quantity of steel returned by the contractor to BHEL store.		
5.13.4	Wastage = Actual consumption – Theoretical consumption.		
5.14	COPPER STRIP/BAR/CONDUCTOR - WASTAGE		
5.14.1	Allowable wastage – 0.5% (Half percent) of the theoretical consumption shall be considered.		
5.14.2	All wastage reinforcement, MS round/Copper Strip/Copper bar, structural steel including excess wastage shall be returned to BHEL.		
5.15	RECONCILIATION OF BHEL ISSUED MATERIALS		
5.15.1	The contractor shall submit a reconciliation statement of RMC and steel issued to him once in every two months. The same may be submitted along with each RA bill. Reconciliation shall be done on total concrete consumed for various grades combined together and recovery if any shall be done at prevailing highest rate amongst the grade of concrete consumed.		
5.15.2	At the time of submission of bills, the contractor shall properly account for the material issued to him as specified herein to the satisfaction of BHEL certifying that the balance materials are available with contractor's custody at site.		
5.15.3	If it is noticed by BHEL that the wastage is high and calls recovery at the penal rate, then BHEL will proceed for recovery for the excess wastage as per penal recovery rates as specified.		
5.15.4	The approved drawings/ bar bending schedules are to be considered for the purpose of reconciliation of materials.		
5.16.0	RECOVERY OF MATERIAL		
5.16.1	If wastage exceeds the specified limit, the recovery of excess wastage shall be made from monthly RA bill at the penal rate stipulated below.		
5.16.2	PENAL RATE OF MATERIALS		
	Item	Penal rate (BDT)	
	Reinforcement steel etc.	BDT 109000 /- per MT.	
	Structural steel/GI Flat	BDT 170040 /- per MT.	
	Tined Copper Strip/Bar/Conductor/SS Plate	BDT 981000 /- per MT.	
	Ready Mix Concrete (RMC)	105% of BHEL purchase cost of Grade Of Concrete having the highest rate amongst the grade of concrete consumed.	
5.16.3	The contractor shall ensure that all wastage material (reinforcement & structural steel, GI Flats, Copper strips & bars, SS plates, conductors) shall be deposited to BHEL store with proper weightment certification as per instruction of BHEL. The total wastage quantity is the property of BHEL and non-return of such quantity shall attract penal recovery as		

	per above. BHEL shall inspect contractors work area & storage yard to ensure that no scraps are lying unreturned to BHEL.
6.0	INSPECTION, TESTING AND INSPECTION CERTIFICATES
6.1	The engineer, his duly authorized representative and / or an outside inspection agency acting on behalf of BHEL / owner shall have access at all reasonable times to inspect & examine the materials & workmanship of the works during its manufacture and if part of the works is being manufactured or assembled on other premises or works, the vendor shall obtain for the engineer and for their duly authorized representative permission to inspect as if the works were manufactured or assembled on vendor's own premises or works. Necessary arrangement for carrying out inspection including supply of labour, IMTEs, area illumination and scaffolding, if required will be vendor's responsibility and same has to be carried out within the quoted price.
6.2	To facilitate advance planning of inspection in addition to giving inspection notice the vendor shall furnish quarterly inspection program indicating schedule dates of inspection at customer hold point and final inspection stages. Updated quarterly inspection plans will be made for each 3 consecutive months and shall be furnished before beginning of each calendar month.
6.3	Before any plant / equipment leaves the place of manufacture, BHEL shall be given the option of witnessing inspections & tests for compliance with specifications & related standards. The vendor shall give the engineer/ inspector 15 days written notice of any material being ready for testing. Such test shall be to the vendor's account except for the expenses of the inspector. The engineer / inspector, unless the inspection is waived will attend such tests within 15 days of the date on which the equipment is notified as being ready for test / inspection, failing which the vendor may proceed with test which shall be deemed to have been made in the inspector's presence and he shall forthwith forward to the Inspector duly certified copies of test reports.
6.4	The engineer or inspector shall within 15 days from the date of inspection as defined herein give notice to the vendor of any objection w.r.t. drawing / equipment / workmanship which in his opinion not in accordance with the specification / contract. The vendor shall either make modification as may be necessary to meet the said objection or explain to the engineer/ inspector giving reasons that no modifications are necessary to comply with the contract.
6.5	When the factory tests have been completed at the vendor's or sub-vendor's works, the engineer or inspector shall issue a certificate to this effect within reasonable time after completion of tests but if the tests are not witnessed by the engineer or Inspector the certificate shall be issued within 15 days of the receipt of vendor's test certificate by the engineer inspector. Completion of these tests or the issue of the certificates shall not bind BHEL to accept the equipment should it on further tests after erection be found not to comply with the contract.
6.6	In all cases where the vendor provides the tests at the premises of the vendor or any sub-vendor, the vendor except where otherwise specified shall provide free of charge such items as labour, materials, electricity, fuel, water, stores, apparatus and instruments as may be reasonably demanded by the engineer/ inspector to carry out effectively such tests on the equipment in accordance with the contract and shall give facilities to the engineer/ inspector to accomplish testing.
7.0	INSURANCE
	The contractor shall make available the original insurance cover(s) taken by him, against his T&P, assets and workmen compensation and any other cover as may be pertinent to his works and obligatory in terms of law, to BHEL for necessary verification in regard to their adequacy, before commencement of work. However, irrespective of such verification/ acceptance, the responsibility to maintain adequate insurance coverage at

all times during the period of the contract shall be of the contractor alone. Such insurance covers to be taken shall be in the joint names of the owner and the contractor. The contractor shall however be authorized to deal directly with the Insurance company(s) and shall be responsible in regard to maintenance of such insurance covers. Insurance covers to be taken by BHEL / Customer shall be as stipulated under relevant clause of Volume-IB.

8.0 DEVIATIONS/ CLARIFICATIONS

8.1 Normally no deviation with respect to tender is acceptable to BHEL. However, in case of unavoidable circumstances, the bidder may submit their query for seeking clarifications of BHEL as per modality stipulated in NIT or may submit the same along with his offer as per prescribed schedule/ format without any ambiguity. Any assumptions, presumptions, deviations etc. indicated or implied anywhere by the bidder except those indicated in the deviation schedule/ format will not be recognized and will not form a part of consideration/ offer. In the absence of such filled-up schedule/ format it will be understood and agreed that the bidder's offer is based on strict conformance to the specification and no negotiation would be allowed in this regard. BHEL reserve the right not to recognize any/ all deviations submitted after opening of the bid.

9.0 DEWATERING

9.1 Contractor shall ensure at all times that his work area & approach / access roads are free from accumulation of water, so that the materials are safe and the erection / progress schedule are not affected. No separate claim in this regard shall be admitted by BHEL. No separate payments for dewatering of subsoil, surface water or catchments water, if required, at any time during execution of the work including monsoon period shall be considered by BHEL. All dewatering pumps including high capacity pumps and diesel engine driven pumps are to be provided by successful bidder within finally accepted rates.

10.0 TIME SCHEDULE/ COMPLETION PERIOD

10.1 The entire work under the scope of work shall be successfully completed in all respect within 6 (six) months from date of start of work, as certified by Construction Manager, BHEL.
Mobilization at site shall be done within 15 days from date of written intimation from BHEL. The exact date of start of work shall be reckoned based on certificate of Construction Manager, BHEL.

Sl No	Structure / Area	Broad completion Schedule (from Date of start of work)
1	Construction Shed (5 Nos)	Within 3 Months
2	Construction Shed (Balance)	Within 6 Months
3	Roof Treatment & misc civil works	Within 5 months
4	STP network civil works	Within 5 months
5	Balance works including Handing over and Contract Closing	6 months

NOTE:(1) The above broad schedule have been prepared in line with L2 schedule of BHEL & BIFPCL. Contractor shall also responsible to complete the

	<p>foundations/structures in their scope of contract within schedule time frame as prescribed/finalized by BHEL/BIFPCL.</p> <p>The purpose of the schedule is timely commencement of work in identified critical areas and completion of the is as per time duration specified in the contract document as above. If for any reasons, the successful vendor fails to progress satisfactorily or the priorities of the structures changes or BHEL feels that a particular structure cannot be completed in line with the project requirement/schedule, in such cases BHEL reserves the right to exclude part or full scope of those critical/priorities structures from the vendor's scope of work and decision of BHEL shall be final and binding to the Vendor. However, BHEL shall ensure minimum 50% of the contract value to be executed within the provision of the contract.</p> <p>(2) Minimum 50 Nos Civil workmen at site is to be mobilized at site initially which shall be progressively increased to 150 Nos within two months and subsequently increased based on monthly L-3 / L-4 schedule of programme.</p> <p>(3)Minimum labour as mentioned is to be deployed to start work in multiple work front as required by BHEL.</p> <p>(4) Procurement of BOIs/imported items to be ensured on time for timely completion. Minimum 4 sets of formwork materials and resources to be mobilized for parallel working in the sheds.</p>
11.0	PRICE BID
11.1	Bidders should quote prices in BDT as per format, Volume-III-Price Schedule provided in the tender. Bids shall be evaluated based on total price quoted. Quoted price must be including taxes.
12.0	TERMS OF PAYMENT
12.1	<p>The contractor shall submit his running bill (RA bill) once in a month at the end of each month in line with payment terms/ billing schedule indicated below. The RA bill complete in all respects accompanied by BHEL engineers certified/ measurement sheet, jointly signed, will be paid after passing of the bill subject to completeness & correctness. The measurement will be taken as specified in terms & conditions of contract and certified by the BHEL engineer of actual work. However, no extra payment shall be made in the event of delay in release of payment.</p> <p>95% pro-rata monthly RA payment shall be considered for payment based on monthly work completion certificate to be issued by BHEL engineer as per approved BBU/Price Schedule.</p> <p>The payment shall be released within 30 days from the date of receipt of complete invoice along with all necessary documents including Engineering Certificate.</p>
12.2	Out of above 95%, 1.5 % of gross bill amount shall be paid in the following manner on certification by BHEL engineer after compliance of each of following activity in each month. In case of non-fulfilment of respective activity by contractor in each month, no payment shall be made by BHEL against corresponding activity and no claim of bidder at a later date, whatsoever, in this regard shall be entertained by BHEL.
12.2.1	0.7 % shall be paid on compliance of housekeeping of contractor's working area and store/ office areas.

12.2.2	0.3 % shall be paid on compliance of general illumination of contractor's working area and stores, office area.
12.2.3	0.2 % shall be paid on compliance of applicable OHSAS requirement as per guidelines of BHEL/ PSER and as specified in the tender.
12.2.4	0.3 % shall be paid on compliance of applicable safety requirement as per guidelines of BHEL/ PSER and as specified in the tender.
12.3	Balance 5% of contract value shall be paid against FAC (Final Acceptance Certificate) to be issued by BHEL / BIFPCL after completion of warranty period. However, if desired by vendor, this 5% may be released by BHEL against submission of equivalent amount bank guarantee as per Performance Bank Guarantee format, to be kept valid till warranty period, subject to the followings:
12.3.1	(i) Receipt of certificate that all works are completed in all respects;
12.3.2	(ii) Reconciliation of materials / T&P / MMD;
12.3.3	(iii) Completion of final bill formalities and
12.3.4	(iv) Handing over to BHEL.
12.4	Contractor shall make their own arrangement for making payment of impending labour wages and other dues in the meanwhile.
12.5	Contractor have to submit BHEL entry gate pass of steel, and other materials required for the work, in absence of which their corresponding RA bills shall not be processed.
12.6	Subject to any deduction which BHEL may be authorized to make under the contract, the contractor shall on the certification of the BHEL engineer at site, be entitled to payment explained hereunder.
12.7	The bills will be sent to BHEL, Site Finance for scrutiny and payment will be made after processing / verification only.
12.8	The measurement will be taken by BHEL engineer as per relevant clause of GCC and certify regarding actual work executed in measurement book and bills for work. However no additional payment shall be made in the event of delay in release of payment beyond the stated period.
12.9	All admissible recovery / adjustment, etc. shall be made from interim payable amount.
12.10	BHEL site at its discretion may split up percentage break up and effect payment to suit the site condition, cash flow requirement, according to the progress of work.
12.11	DELETED
13.0	DELETED
14.0	TAXES, DUTIES ETC
14.1.0	IMPORT DUTIES: Exemption of Duties/Taxes imposed on imported goods/equipment for implementing Rampal 1320 MW (Coal-based) Friendship super Thermal power project under Bagerhat district of Khulna Division operated by Bangladesh-India Friendship Power Company (Pvt) Limited (BIFPCL)
14.1	<p>As per Special Regulatory Order # 126 of 2021 dtd 24.05.2021 it is to be noted that all imported goods/ equipment for implementation of the 1320 MW Rampal project shall be exempted from imposable import duties, VAT and supplementary customs duty. (For clear understanding of exemption available, bidder may refer to SRO 126 dated 24th May 2021).</p> <p>During importing temporarily imported erection materials, equipment and spare parts and permanently imported plant and equipment exempted under this order will not be sold or otherwise transferred without payment of duties and taxes imposable on those.</p> <p>Exemption shall not be extended to such goods which the bidder might import for support of their operational activities but not directly attributable for execution of the project such as air conditioner, refrigerators, vehicles, household materials etc.</p> <p>Any documentation needed for availing of Duty Free Imports will be submitted by the bidder in reasonable time having regard to the time for delivery of the work and the time for completion.</p>
14.1.2	DELETED

14.1.3	Temporarily imported erection materials, machineries and spare parts during construction period of Project are exempted from payment of Customs Duty and VAT. Such items shall be exported within six months from the commercial operation date. Documentation for the same to be submitted / maintained by the bidder.
14.1.4	Any Taxes for exporting material from source country & as applicable in the source country shall be on bidder's account. However, bidder to take into consideration Duty Free Export Provisions in source country, as applicable, including that in GST in case of exports from India. As such, while offering the rates, the bidder may take into account the benefit of above provisions, as the cost of input to the bidder will be net of such taxes and adjust their offer price accordingly to make it more competitive.
14.1.5	Bidder may import the material required for permanent works for which exemption of Custom Duty as per local law shall be applicable provided necessary documents are submitted.
14.2.0	BANGLADESH VAT
14.2.1	The Bidder shall submit copy of VAT registration Certificate Musak-2.3, TIN Certificate, Trade License to the BHEL site office immediately after receiving the Order but before raising the first Tax Invoice against this tender.
14.2.2	As per the provisions laid down U/S49(5) of Bangladesh VAT Act 2012, Output Services of the Bidder shall attract ZERO (0) VAT. Thus BHEL shall not do any VDS. Hence Bidder shall not load any VAT on Output Services.
14.2.3	Adequate documents for not charging/ claiming VAT from BHEL shall be made available to the Bidder.
14.2.4	The bidder shall raise Tax Invoice (Challan Patra) as per Rule 40(d)(v) (Musak-6.3) of the Bangladesh VAT and supplementary Duty Rule,2016 mentioning Name, Address and VAT Registration Number of BHEL site office.
14.2.5	Bidder shall note that the Tax Invoice complying with Rule 40(d)(v) of the Bangladesh VAT and supplementary Duty Rule,2016 must contain the 'Bill to' and 'Ship to' details as below: BHEL Bangladesh VAT Regn. No. 000761853-0208 Bharat Heavy Electricals Limited Power Sector Eastern Region, 2x660 MW Maitree Super Thermal Power Project, Moidara Village, Rampal Upazila, Bagerhat District, Bangladesh
14.2.6	Bidders shall quote price excluding Bangladesh VAT envisaging VAT exemption on the same. In this connection please note that VAT, if and as applicable, on Bidders Quoted Price and in case BHEL is unable to provide exemption documents shall be payable extra.
14.2.7	Value Added Tax Deduction at Source:
14.2.7.1	BHEL will not deduct any VAT from Bidder's Gross Bill and such bidder need not to load any Output VAT in Bidder's quoted price
14.3.0	INCOME TAX DEDUCTION AT SOURCE:
14.3.1	Bidder should have valid 12-digit TIN number in Bangladesh prior to start of work. Advance Income Tax (AIT) under the Income Tax Act 2023 (and rules made thereunder) shall be deducted at prevailing rates on Gross Invoice value from the bills unless Exemption Certificate from the appropriate authority/ authorities is/ are furnished under Income Tax Laws of Bangladesh
14.3.2	Since payment shall be made in Bangladesh. Bangladesh Income Tax (AIT) shall be deducted, if applicable.
14.4.0	The Bidder shall carry out their own tax diligence to get acquainted with the relevant rules and regulations of Bangladesh pertaining to the subject job.

14.5.0	Except otherwise mentioned above bidder shall quote their rates/ price inclusive of all taxes, duties, cess, any State or Central Levy, social security contribution and other Taxes in or outside Bangladesh (but excluding Bangladesh VAT & Import Duties) in line with provisions as mentioned above etc. together with variation thereto during contract period including extension, if any. BHEL shall not release any additional payment in this regard.
14.6.0	The bidder is responsible for compliance of all relevant Tax Laws of Bangladesh and all other related places outside Bangladesh in connection with this contract and BHEL will not bear any such liability. Non Bangladeshi Bidder shall have to obtain Registration under BIDA and shall have to mandatorily comply the norms , as may be prescribed.
14.7.0	New tax & duties, if imposed subsequent to latest due date of offer submission, as per NIT & TCN, as applicable, by statutory authority after due date of submission of latest price offer and within the contract period including extension, if any (provided reason for extension is not attributable to vendor), shall be reimbursed by BHEL at actual on production of relevant supporting document to the satisfaction of BHEL. However, the vendor shall obtain prior approval from BHEL before depositing new taxes & duties. Benefits and/or abolition of all existing taxes must be passed on to BHEL against new Taxes, if any, proposed to be introduced at a later date.
15.0	PROJECT MANAGEMENT/ CONSTRUCTION MANAGEMENT To meet the need of construction management at site, contractor shall provide the following services within quoted/ accepted rates.
15.1	CUSTOMS CLEARANCE The Contractor shall be responsible for Bangladesh customs clearance of all materials, supplies, equipment, tools and other articles shipped into Bangladesh by him for the implementation of his works, including the food and the personal effects of the Contractor's personnel. All payment for clearance charge, storage charge, etc. which are imposed by the relevant agencies of the Government of Bangladesh, relating to the clearance of equipment, materials and Plant that will be incorporated in the Permanent Works or relating to the Temporary Works shall be borne by the Contractor. Further, if the Contractor is delayed in submitting necessary shipping documents to the Employer, the demurrage charges by the Port Authority will be borne by the Contractor. Tools and equipment and other equipment of the Contractor for use during construction but which are to remain the property of the Contractor and which are to be exported by the Contractor from Bangladesh at the completion of the Work shall be carefully documented and specially listed to facilitate both import and export. The Contractor shall determine prior to shipment the customs regulations applicable to this special case as well as normal import rules and regulations applicable. The Contractor shall also be responsible for inland transport by barge/ truck/train to the Site.
15.2	RECEIVING, TRANSPORTING, HANDLING AND STORAGE The Contractor shall receive, transport, handle, store and install all materials and equipment furnished under these specifications, or otherwise involved in the implementation of this Contract. It shall be the responsibility of the Contractor to determine the availability and capacity of transportation and unloading facilities (including for the transportation, delivery and receipt of all equipment, materials, Plant to the Site) and to make the required arrangements to secure the necessary facilities for the same. The Contractor shall be responsible for the prompt unloading of all equipment or materials. The Contractor shall pay any demurrage incurred due to delay in unloading and for any other reasons.

	<p>The Contractor shall handle materials and equipment carefully to prevent damage or loss. The use of bare rope slings for handling will not be permitted unless specifically approved by the Engineer. Special handling devices shall be used when necessary to avoid damage.</p> <p>In addition, the Contractor shall also comply with the requirements of Technical Specification with respect to the receipt, transportation, handling and storage.</p> <p>If BHEL has to unload of RS, SS, Copper or any other free issue materials before mobilization of the contractor for the interest of the project or If contractor fails to unload the BHEL free issue materials at site for any reason then BHEL shall be unloading the same and the cost of unloading with following rates shall be deducted from contractor RA Bill.</p> <p>i) For RS, SS, Copper or any other materials:- BDT 436/- per MT or actual cost , whichever is higher.</p>
15.3	<p>PLATFORMS</p> <p>Open platforms shall be constructed by the Contractor at least 50cm above grade and shall have adequate flooring and base structure to support the stored materials and equipment.</p>
15.4	<p>INDOOR STORAGE</p> <p>Indoor storage sheds shall be constructed by the Contractor by suitable means for keeping materials and equipment from contact with the ground and to protect it from the environment and outside atmosphere. Sensitive equipment (including inter-alia, electrical, I&C and other equipment) must be kept in dustproof and ventilated rooms and means have to be provided to maintain the moisture content at required levels, in accordance with Good Industry Practices.</p>
15.5	<p>SHORING</p> <p>Shoring shall be provided by the Contractor to safely support materials and equipment not less than 30cm above the ground. The ground shall be compacted and concreted or asphalted.</p>
15.6	<p>WEATHERPROOF COVERINGS</p> <p>Weatherproof and flame resistant sheeting of sufficient size for outdoor storage shall be provided by the Contractor. The sheeting shall be carefully placed and tied down to prevent moisture and wind from entering underneath the sheeting and to otherwise protect the equipment, materials and other Plant.</p>
15.7	<p>IDENTIFICATION OF CONTRACTOR'S EMPLOYEES, VEHICLES & BUILDINGS</p>

	<p>The Contractor shall provide each of his employees and his Subcontractor's employees with a name tag bearing the picture, the name or initials of the employee, a serial number and the name of the Contractor. Each employee shall wear his badge visibly to the security personnel at any time.</p> <p>Subcontractor's employees with a name tag bearing the picture, the name or initials of the employee, a serial number and the name of the Contractor. Each employee shall wear his badge visibly to the security personnel at any time.</p> <p>All vehicles and large equipment furnished and used by the Contractor or his Subcontractors on the Work shall be clearly marked with the Contractor's or Subcontractor's business name. The Contractor's offices, stores, depots and other facilities shall also be clearly identified. The detailed requirements are defined in the Health, Safety and Environment (HSE) Plan of BHEL.</p> <p>Around-the-clock security presence and operational routine shall be maintained throughout the year. Passes and temporary identification permits shall be issued and examined and access to any part of the Site, the site offices and living accommodation shall be controlled and limited to those who have an authorization.</p>
15.8	<p>EXPATRIATE PERSONNEL</p> <p>The Contractor shall submit to Employer data of all personnel he intends to bring into Bangladesh for the performance of the Work. This data shall include the name and present address of each person, his intended assignment and responsibility in connection with the Work and a concise resume of his experience in the type of work to which he will be assigned. This data shall be submitted to the Employer at least thirty (30) days prior to their expected arrival in Bangladesh.</p> <p>Any expense associated with illness of the Contractor's personnel, including replacement thereof, shall be to the Contractor's account.</p> <p>Costs of passports, visas, travel documents, inoculations and other incidental expenses incurred by the Contractor's non-Bangladesh employees and their dependents occasioned by travel to and from Bangladesh shall be borne by the Contractor.</p> <p>All accommodations and amenities for the Contractor's personnel and families (including all staff and labour) must be provided by the Contractor, and the Employer shall not have any liability for the same.</p>
15.9	<p>SAFETY</p> <p>The Contractor shall comply with all ordinances and regulations including, but not limited to, National, State, Municipal laws and Department of Labour, Transmigration and Co-operation Regulations, and other Applicable Laws that are in force in the locality of the Works and shall comply with any instructions that may be from time to time issued by Employer. The safety rules and regulations laid down in the Health, Safety and Environment (HSE) Plan are to be strictly adhered to.</p>
15.10	<p>CONTRACTPLANNING AND CONTROL</p> <p>Before starting the Work at the Site, the Contractor shall submit the detail site management organization for approval by the Employer. Such proposals shall show</p>

	<p>clearly the Contractor's key personnel, classification and qualification with the detailed information and curriculum vitae for above key personnel.</p> <p>The Contractor's Representative, site manager and senior key personnel who will be responsible for working closely with the Employers staff to achieve efficient execution of the Contract shall be competent to conduct meetings and communications in the English language.</p> <p>The management organization shall include a planning and programming tools covering the Work, and shall apply the latest techniques in communication and analysis. The Contractor shall nominate a planning engineer to co-ordinate all planning activities.</p>
15.11	<p>RELEASE OF INFORMATION</p> <p>The Contractor shall not communicate or use in advertising, publicity, or sales release, photographs or other reproductions of the Work under this Contract, or descriptions of the size, dimensions, quantity, quality, or other information concerning the Work unless prior written permission has been obtained from the Employer.</p>
15.12	<p>SAFETY AND ACCIDENT PREVENTION</p> <p>It shall be the Contractor's responsibility to maintain throughout the construction period, a safety and accident prevention program satisfactory to the Employer which meets the requirements of Applicable Laws and of all other Governmental Authorities authority having jurisdiction over the Works. The rules and regulations laid down in the Health, Safety and Environment (HSE) Plan must be adhered to at all times.</p>
15.13	<p>SECURITY</p> <p>The Contractor shall be solely responsible for the security of all equipment and materials incorporated or to be incorporated in the Work by him and all equipment, materials, tools, supplies, structures, facilities and others properly used in the execution of the Work while in his care and custody.</p> <p>The Contractor shall conform also to any specific security requirements of Employer but such compliance shall not relieve the Contractor from the total responsibility for security.</p>
15.14	<p>HOUSING & TRANSPORT</p> <p>The Contractor shall arrange for suitable housing units together with furnishing and utilities in the close proximity of the construction Site for accommodation of all his expatriate personnel. If the services of any expatriate personnel of the Contractor or its Subcontractors</p> <p>If the Contractor decides in consultation with the Employer that the health or safety of any of his personnel is or might be jeopardized by political or health hazards in Bangladesh, the Contractor may, after forty-eight (48) hours' notice, order its employees and the employees of its Subcontractors and suppliers to return to their headquarters or other safe location, in which case the Work will be deemed to be suspended for the duration.</p> <p>The Contractor shall provide to the extent agreed transport vehicles for use during construction period by the expatriate as well as local personnel.</p>

15.15**PROPRIETARY NAMES**

Whenever a material or article is specified or described on the plants by using the name of a proprietary product or by using the name of a particular manufacturer or vendor, the specific item mentioned shall be understood as establishing the type, function and quantity desired. Unless otherwise specified, other manufacturers' products which in the opinion of the Employer are equivalent of those specified will be accepted. Such items shall be submitted for approval prior to their incorporation in the Works.

15.16**PERFORMANCE OF THE WORK**

The Contractor shall conduct all Works in such a manner as to cause the least possible disturbance or damage to the environment. In cases where some temporary disturbance or damage is unavoidably caused due to the nature of the work, the Contractor shall, as soon as possible, remove the cause of such temporary disturbance, repair the damage and, in general, restore the affected areas to their original condition to the extent possible, and in a manner satisfactory to the Employer, the landowner and any authorities.

Prior to commencement of the Work, the Contractor shall provide details of its EMP specifically addressing the following:

- Environmental management system and manual – policies, standards and procedures, and programs; organization / responsibilities;
Training
Incident and accident investigation;
Management support;
Environmental protection, mitigation and restoration;
Emergency preparedness and response;

Socio-economic plans, including historical and cultural resources;

audit, monitoring and corrective action;

information and records management; and,

Integration of safety & health requirements with the EMP.

All aspects of the EMP and the environment work requirements are the Contractor's accountability and the Contractor, its management and its Site supervisory staff will be held responsible for its implementation.

All relevant Health, Safety and Environment (HSE) issues, results of audit and monitoring plans and programs, and HSE performance indicators will be communicated to the Contractor's management and the Employer through daily inspection meetings and reports, weekly construction meetings, monthly meetings, and in terms of the monthly project report.

The Contractor shall ensure that he has complete knowledge of all the laws, statutes, statutory instruments, regulations, rules, treaties and conventions (by whatever name or title), environmental protection regimes and other Applicable Laws, in each of the jurisdictions where he shall perform the Work. The Contractor shall also take all necessary measures to protect the atmosphere, ocean, rivers, groundwater, seaports

and land from pollution. In any event the Contractor shall promptly use its best efforts to eliminate and clean up any pollution caused, directly or indirectly, by the Contractor or which occurs at the Site, or other sites associated with this Work.

The Contractor shall cooperate in all respects with any participant environmental representatives and with governmental persons, and allow them to inspect any and all equipment or operations that they wish to observe. The Contractor shall, at all times, be ready to discuss the implementation of the Contractor's safety, health and environmental protection program.

15.17 INSTRUCTION TOWORKERS(ORIENTATION/ INDUCTION)

The Contractor shall ensure that all employees, subcontractors, servants and agents (and employees, servants and agents of all Subcontractors) participating in the Work, are advised about the strategy and plan for managing the environmental-social issues related to the work, and on their role and responsibility; instructed on the requirements of environmental laws, rules, regulations and specific permit conditions applicable to the area and the Work; instructed on the application and use of the required personal protective equipment (PPE) for their job duties and functions; and, have received the appropriate training in the use, application and maintenance of PPE.

15.18 RISKMANAGEMENT

The Contractor shall clearly state the management methods and techniques to be used to identify potential hazards and risks at any stage prior to the execution of a particular activity. If required, specific procedures shall be developed by the Contractor to eliminate or mitigate the hazard to a safe level prior to the work being authorized. All requirements of the project's environmental impact assessments ("EIA") and other relevant assessments and conditions of approvals accorded by the relevant Governmental Authorities must be considered by the Contractor in the development of the Contractor's Health, Safety and Environment (HSE) Plan, EMP and other related/relevant plans. The Contractor is required to implement a system whereby all risks associated with hazardous substances, whether chemicals, by-products, effluents or waste materials, are minimized and/or eliminated. In conjunction with its emergency plans and procedures, the Contractor shall develop and submit to the Employer's Representative a "Safety Philosophy Document" that details the strategy to be adopted for control and shutdown systems, including alarms and programmable electronic control systems.

15.19 EMERGENCY PREPAREDNESS, RESPONSE & CONTINGENCY PLAN

The Contractor shall prepare an Emergency Preparedness, Response and Contingency Plan (a detailed program of action to minimize the effects of an abnormal event requiring prompt actions beyond normal procedures to protect human life, minimize injury and safeguard the environment) for environmental and personal safety emergencies or incidents. This plan shall be found within the Contractor's Safety & Health and/or Environmental Programs. The purpose of the plan shall be to limit insurance and damage to people, property and the environment respectively. The plans, procedures, and trained personnel shall be in place for the duration of the Contract to manage and control emergency situations and incidents in a proper and expeditious manner.

15.20	<p>SERVICING AND FUELLING</p> <p>To ensure adequate response capability in the event of a fuel, ground spill or other spill, all fuel transport vehicles and the Contractor's foreman vehicles shall carry a suitable amount of commercial absorbent material. In addition, floating absorbent pads and booms for spill clean-up on open water shall be kept accessible on the construction Site.</p> <p>All service vehicles and/or equipment utilized for re-fuelling must be equipped with automatic shut-off valves. All equipment or servicing activities with the potential for accidental spills (e.g., oil changes, hydraulic repair, coolants) will require appropriate containment methods to be in place (i.e., storage containers, impervious liners, absorbent materials, etc.) prior to the start of the activity.</p>
15.21	<p>SOIL AND GROUNDWATER PROTECTION</p> <p>The Contractor shall develop and implement soil and groundwater protection measures. Protection measures shall include building and impervious floors, where appropriate. The Contractor shall make an assessment of groundwater quality prior to the start of construction and prior to commissioning to demonstrate to Employer's Representative that construction activities have not adversely affected the environment. Groundwater quality shall be monitored throughout the construction phase.</p>
15.22	<p>HEALTH HAZARDS</p> <p>Worker and public health is a critical part of any HSE management program. The Contractor shall control substances and materials that may be a hazard to worker's health. These controls shall be a combination of hazard communication, safe work systems and the controlled handling and disposal of hazardous materials. The Contractor's controls shall commence at contract preparations and procurement stages, where all vendors and subcontractors shall be required to submit Material Safety Data Sheets ("MSDS") for all hazardous materials that will be supplied, provided or brought onto the Site. These MSDSs shall be forwarded to Contractor's HSE Manager for review and records management.</p> <p>In the event hazardous materials are to be used, the Contractor shall carry out assessments according to recognized international standards, to determine if there are any more suitable or less hazardous materials that could be substituted for the original materials. Only when the Project Manager, Employer and his Engineer and the Contractor are satisfied that assessments have been completed, and control measures are adequate to protect worker health, the materials shall be allowed on the project worksite. The Contractor's control measures shall include:</p> <ul style="list-style-type: none"> <input type="checkbox"/> Material transport, storage, labelling, packaging, and disposal, <input type="checkbox"/> Personnel protective equipment (PPE), <input type="checkbox"/> Health surveillance and monitoring, and <input type="checkbox"/> Emergency procedures and training. <p>All explosive materials to be used for blasting during Site preparation shall only be</p>

handled by approved and qualified personnel. All explosive materials shall be stored in a secure, limited access sites, protected from workers and the public, and removed from the site every day and immediately after use.

All radioactive equipment and materials shall only be used by qualified, approved and permitted personnel. Radioactive materials must be stored in approved and protected container. Radioactive materials and waste products shall not be disposed of on-site but removed in protective containers and disposed at government approved storage and disposal sites

15.23**WASTEMATERIALMANAGEMENT**

The Contractor shall ensure that waste management identification, handling, transport and disposal are addressed in the development of their HSE management plans.

The Contractor's employees responsible for handling hazardous materials (including wastes) shall receive training and certification in the handling, transport, storage and disposal of chemicals and regulated or hazardous materials. Where applicable, Workplace Hazardous Materials Information System ("WHMIS") certification and training, or its equivalent, shall be made available to employees. Regular written updates shall be included for continued employee awareness.

The Contractor shall ensure proper segregation and isolation for wastes that could react together in the event of a leak or other incident. These facilities shall include lockable, fire proof cabinets or storage in shelving units separated by fireproof barriers or walls.

The Contractor shall dedicate a space for waste and drum storage. The storage area must be easily accessible for spill containment and emergency response and not be susceptible to flooding.

For any waste storage area which could accumulate hazardous gases, vapors, or dust due to the nature of the wastes stored, the Contractor must supply suitable ventilation or other controls to ensure exposure by employees is kept below required minimum standards. Storage areas for hazardous wastes shall be designated as restricted areas and shall be suitably equipped to control an incident involving a leak or spill.

The Contractor shall make available suitable fire extinguishing equipment and proper electrical bonding equipment in all areas involving the handling and storage of flammable and reactive wastes.

Disposal of wastes by burning will not be allowed on the construction site.

Sumps and waste pits shall not be used for waste storage at the work site. Sumps should only be used for temporary control and containment of spills, equipment leaks, etc. If the Contractor encounters former sump sites or waste pits during ground surveys, the Contractor shall identify and investigate the same. If any contamination is suspected, the Contractor shall excavate, remove and where required replace with an approved sump container system.

The Contractor shall develop and implement a waste disposal control system. This system shall control every load of waste leaving the worksite, detailing the type of waste disposal, waste origin and destination, approximate weight, date and transport details

	on a waste manifest/document. These documents shall be audited.
15.24	<p>SPILL RESPONSE AND CONTROL</p> <p>All spills shall be stopped and cleaned up immediately to avoid potential impact to water and soil quality. All spills shall be reported using the Incident Management Process. Under no circumstance contaminated material may be “stored” on the work site. All spills shall be rapidly stopped and appropriately eliminated as defined in the Contractor’s Emergency Preparedness, Response and Contingency Plan. Spills shall be contained in a way that will prevent their redistribution. All ground spills shall be contained as quickly as possible through diking, suction methods, excavation and the use of absorbents or other appropriate recovery techniques.</p> <p>A list including the type, quantity and location of the storage of retaining and clean up equipment to be used during construction shall be prepared. The list shall include the procedures and mitigation measures to be used in case of a spill. A written inventory will also be prepared, before starting construction works, including lubricants, fuels, solvents, chemicals and other materials that might be accidentally discharged during construction.</p> <p>All on-site fuel storage tanks shall be located in an impermeable secondary containment area with a holding capacity equal to 110% of the largest tank within the berm. For above ground tanks, the tanks shall be surrounded by a berm, the entire area covered with a suitable commercial absorbent material and with a sealed plastic liner to form an area that can be pumped out in the event of a leak in the tank. A waste handling plan shall be made with the purpose of identifying the procedures necessary for cleaning and disposing of residues from a major spill. In the event of a spill, the Contractor shall make all resources available to contain and clean up the spill. Traffic shall be minimized in and around the spill site.</p>
15.25	<p>NOISE CONTROL</p> <p>Noise level specifications to be followed by the Contractor in design, assessment and monitoring activities are based upon the maximum (acceptable) levels which plant personnel may be exposed during their normal working duties. The Contractor shall be familiar with and comply with the environmental guidelines as issued by the relevant Governmental Authorities in Bangladesh, including the Department of Environment, Government of Bangladesh and other relevant Applicable Laws.</p> <p>All internal combustion motors of vehicles, machinery and equipment used during the construction phase, shall have adequate noise silencers, and shall be kept in good operating conditions, during the entire construction period. Where temporary noise pollution of greater than 85 dB will occur, temporary silencers shall be used. Equipment noise should not exceed the specified limits at accessible locations.</p>
15.26	<p>CONSTRUCTION TRAFFIC PLANNING</p> <p>The Contractor shall ensure that the construction Site is organized in such a way that pedestrians can move safely and without risk. The Contractor shall firstly select the lowest period of traffic flow for equipment crossings; and secondly, ensure that traffic patterns and entrances to private and public roads for access are not obstructed during construction activities. All site entry will be controlled by vehicular passes. Road closures, on-site and off-site, shall be with the approval of the Contractor’s site manager</p>

	and/or road closure permit. Site traffic shall be minimized and speed limits posted and enforced.
15.27	<p>HOUSEKEEPING</p> <p>All construction debris and other garbage shall be continuously collected and disposed at an approved facility. At the end of each day, all waste material shall be removed from the construction Site and deposited at the approved allocated area. The approved procedures to manage waste shall be specified in the Contractor's waste management plan. All empty hazardous material containers shall be removed from the work area as soon as is practicable. All empty gas containers and bottles shall be returned to their storage area and secured properly.</p> <p>The Contractor's shall prepare a pest and vector control program to address specific site conditions, including a mosquito control program.</p>
15.28	<p>CONSTRUCTION CAMPS</p> <p>The location of work places, camps, areas of storage and installation of works, compression, regulation and communication stations shall be located on levelled land, avoiding areas with non-cohesive soils to avoid erosive processes.</p> <p>Health conditions in the camp shall be controlled in order to prevent contamination of adjacent groundwater or surface water resources. Domestic sewage generated at the construction sites shall be eliminated by two systems of septic/absorption tanks or chemical toilets located on the sites.</p> <p>Solid combustible garbage shall be collected and secured daily, until disposal, to prevent the attraction of livestock, vermins and wild animals. Residue shall be disposed of, along with non-combustible garbage, in a disposal location approved by the Authorities.</p> <p>Upon abandonment, the camp site area shall be cleared of all trailers, piping, cable, insulation, lumber, blockage, metal wastes, etc., and re-graded according to the landscaping concept. These guidelines and procedures for the management of domestic and other waste shall be specified in a plan.</p>
15.29	<p>SITEREGULATION MANUAL</p> <p>The Contractor shall thirty (30) days prior starting any Work at the Site furnish a detailed and comprehensive site regulation manual for its proposed operation and works on the Site, which shall be based on the site related regulations and requirements in the Contract and which shall be subject to Employer's approval. All work on the Site, shall be carried out in compliance with the so approved site regulation manual.</p>
15.30	<p>PLANNING & MONITORING</p>
15.30.1.1	<p>Within 7 days of placement of order/ LOI by BHEL, successful bidder shall interact with BHEL site for kick-off meeting to discuss & firm up item-wise/ activity-wise schedule of construction so as to complete the entire job within the stipulated completion period, matching with project schedule.</p> <p>The bidder shall prepare detail construction schedule (L-3) as per completion dates given in this document. This schedule must include all milestone and key activities for each sub-system / components in the areas of engineering (wherever applicable), procurement, manufacture (wherever applicable), excavation / construction / erection. This network must conform to the overall project schedule. The bidder should also ensure monitoring of these activities at least weekly basis to start with and on daily basis whenever required by BHEL.</p>

15.30.1.2	The bidder shall also prepare progress report indicating progress on key activities, management summary for critical activities and list of actions requiring attention of BHEL. This schedule is to be preferably made in PRIMAVERA / MS PROJECTS, so that the same is compatible with BHEL's project management software.
15.30.1.3	You shall also provide 2 (Two) number service staff for miscellaneous service for BHEL's use at site/ Kolkata for reconciliation, progress review & day-to-day planning purpose, documentation, supervision, etc. These facilities are to be provided within 30 days from LOI date or from the date of requirement communicated in writing by BHEL whichever is later till completion of scheduled contract period or up to extended period for the completion of the contract whichever is later. If BHEL do not availed the service of computer/ printer/ personnel as per requirement, BHEL shall have the right to deduct the amount as per following rates on prorated basis, from your RA bill or any other dues.
15.30.1.4	Deleted
15.30.1.5	@ BDT 30000/-per month for each service staff.
15.30.1.6	Deleted
15.30.1.7	DELETED
15.30.1.8	The contractor's site office must have facilities of communications like Fax, E-mail, and telephone with STD facility within a month from LOI.
15.30.2	PROGRESS REPORTING
15.30.2.1	DELETED
15.30.2.2	The progress report shall indicate the progress achieved against planned with reasons indicating delays, if any, and shall give the remedial actions which the contractor intends to take to make good the slippage or lost time, so that further works again proceed as per the original program and the slippages do not accumulate and effect the overall program.
15.30.2.3	The daily work force reports shall clearly indicate the work force deployed, category-wise specifying also the activities in which they are engaged.
15.30.2.4	Weekly progress review meetings will be held at site during which actual progress during the week vis-à-vis scheduled program shall be discussed or actions to be taken for achieving targets. For discussions, the contractor shall present program of subsequent week. The contractor shall constantly update/revise his work program to meet the overall requirement.
15.30.2.5	Periodic progress reviews on the entire activities of execution in respect of supply and works in scope of bidder will be held once in a month at Kolkata / site. These meetings will be attended by reasonably higher officials of the contractor and will be used as a forum for discussing all areas where progress needs to be speeded up. The contractor shall be further responsible for ensuring that suitable steps are taken to meet various targets decided upon such meetings.
15.30.2.6	Deleted
15.30.2.7	Successful bidder has to provide for electronic/ computerized storing and re-production / printing / plotting of various data, log sheets, protocols, measurements etc. These may be stored in CD (as per requirement) and handed over to BHEL as per requirement.
15.30.2.8	PHOTOGRAPHS
	DELETED
15.30.3	SITE ORGANIZATION
15.30.3.1	The contractor shall maintain a site organization of adequate strength in respect of manpower, construction machinery and other implements at all time for smooth execution of the contract headed by a competent construction manager for site operations with

	sufficient level of authority to take site decisions. The vendor will submit organization chart (showing the name of SITE-IN-CHARGE) with individual bio-data indicating various levels of experts to be posted for supervision in the fields of supervision and execution, quality, material management, planning, safety, etc. The organization shall be reinforced from time to time, as required to make up slippage (if any) from the schedule without any commercial implication to BHEL. The organization chart is to be submitted within 10 days from the date from start of work.	
15.30.3.2	Following (minimum) engineering manpower with power plant construction background to be deployed at site by the successful vendor for their day to day supervision etc.	
15.30.3.2.1	Qualified safety officers with assistants (exclusive for safety supervision for project jobs).	Officer/Assistant – Minimum One No. Manpower and Infrastructure details available in Annexure B. Contractor shall implement / deploy Manpower at site as mentioned in Annexure B.
15.30.3.2.2	Engineer & Supervisors for quality inspection.	Engineer-One Number Two supervisor
15.30.3.2.3	Site supervising engineer and supervisors for civil works	Every work area to have minimum one qualified supervisor.
15.30.3.2.4	Quality engineer for Civil Supervision	One no.
15.30.3.2.5	Planning Engineer (exclusively for planning)	One no. Engineer
15.30.3.3	Deputation of above man-power shall be jointly decided at site in line with construction schedule.	
15.30.3.4	Engineer / supervisor for other functions like store & purchase, material management, fin, administration etc. are to be provided as per site requirement and not considered above.	
15.30.3.5	In the event of non-deputation of engineer/ supervisor by the bidder as per above agreed schedule, BHEL shall reserve the right to deduct BDT 114450/- per man-month for engineer, BDT 70850/- per man-month for the supervisor / safety officer / chemist and BDT 70850/-per man-month for safety supervisor from RA bills. Further induction of manpower regarding site supervisor & site engineer will be decided at site as per requirement without any financial implication.	
15.30.3.6	BHEL reserves the right to reject or approve the list of personnel proposed by the contractor. The persons whose bio-data have been approved by BHEL will have to be posted at site and deviation in this regard will not be permitted unless specific & reasonable justification is made.	
15.30.3.7	In addition to above, a well experienced qualified engineer to be designated, as 'Project Co-coordinator', shall be deployed by the contractor. Such engineer shall have adequate exposure on the job and shall remain fully involved in all planning activities, guidance etc. to contractor's own team during the complete execution period of contract.	
15.30.3.8	The contractor should also submit to BHEL for approval a list of T&Ps along with their fitness certificates. The tools & tackles shall not be removed from site without written permission of BHEL.	
15.30.3.9	The contractor should also submit network programs for the erection of various items. These networks shall show the BIFCL/ BHEL hold points, which have to be cleared by BIFCL/ BHEL, or their authorized representatives before further erection can take place. These programs for the erection would clearly identify responsibilities of the contractor and BIFCL/ BHEL. It is the responsibility of the contractor to get the Networks approved by BHEL within four weeks of the date of finalization of award of work/ placement from start of work.	

16.0	QUALITY CONTROL & QUALITY ASSURANCE
16.1	Contractor's engineers & supervisors shall be adequately qualified and also inclined to do a quality job. The quality assurance engineer shall co-ordinate all aspects of quality control, inspection, implementation of quality assurance procedures laid down in Quality Plan and technical specification by BHEL. He shall fill up quality assurance log sheets / formats and submit to BHEL for joint inspection and acceptance. The contractor shall fill up, maintain & preserve the quality records in computerized media. BHEL's authorized representative shall be given free access at all time to such quality related records etc. for inspection, review etc.
17.0	QUALITY ASSURANCE PROGRAMME
17.1	The contractor shall arrange for suitable quality assurance programme to control all activities pertaining to the scope of work, as necessary. Such programs shall be outlined by the contractor & shall be finally accepted by BHEL. A quality assurance programme of the contractor shall generally cover the following
17.2	Organization structure and qualification data for key personnel of the contractor for the management and implementation of proposed quality assurance programme
17.3	The procedure for source inspection, incoming raw material inspection, verification of material purchased etc.
17.4	System for maintenance of records.
18.0	GENERAL REQUIREMENTS – QUALITY ASSURANCE
18.1	All materials, components and equipment covered under the specification shall be procured, manufactured, erected, commissioned and tested, as applicable, at all stages as per comprehensive quality assurance program. An indicative program for inspection / test, to be carried out by the contractor, for some of the major items is given in the respective technical specification.
18.2	Field quality plan will detail out the quality practices and procedures etc. to be followed by the contractor's site quality control organization, during various stages of site activities from receipt of material / equipment at site.
18.3	BHEL reserves the right to carry out quality audit and quality surveillance of the systems and procedures of contractor's quality management. Contractor shall provide all necessary assistance to enable BHEL to carry out such audit.
18.4	Quality audit / approval of the results of test & inspection will not prejudice the right of BHEL to reject an equipment service not giving desired performance and shall not in any way limit the liabilities and responsibilities of the contractor in earning satisfactory performances of equipment/ service as per specification.
18.5	Repair / rectification procedure to be adopted to make any job acceptable shall be subject to the approval of BHEL.
18.6	All the latest relevant codes as per technical specification should be available with the contractor at site within 15 days from the date of placement from start of work or otherwise specified by Construction Manager/ Project Manager, BHEL.
19.0	HEALTH, SAFETY & ENVIRONMENT
19.1	REFER DOCUMENT NUMBER :-HSEP:14-MAITREE:VENDOR: DATE: 05.05.16
	DOCUMENT TITLE:-HEALTH, SAFETY AND ENVIRONMENT PLAN FOR 2X660MW MAITREE SUPER THERMAL POWER PROJECT
20.0	SPECIFIC REQUIREMENTS FOR ISO 9002
20.1	Contractors shall ensure that all their staff / employees are exposed to periodical training programs conducted by qualified agencies/ personnel on ISO 9002 Standards.
20.2	Contractor shall ensure that the quality is maintained in all the works connected with this contract at all stages of the requirement of BHEL.
20.3	Contractor shall ensure that all MMDs that are used, whether owned by the contractors or used on loan, are calibrated by the authorized agencies and the valid calibration

	certificate will be available with them for verification by BHEL. A list of such instruments possessed by the contractor at site with its calibration status is to be submitted to BHEL Engineer for control.
20.4	Contractor shall ensure that fitness certificate of the tools & plants, that are in use, whether owned by contractor or issued on loan, are tested by authorized agency and the valid fitness certificate is available for verification by BHEL.
20.5	Contractors shall arrange for the inspection of the works at various stages as required by BHEL. The contractors shall take immediate corrective action for the non-conformances if any, observed and pointed out by BHEL.
21.0	INTEREST BEARING RECOVERABLE ADVANCE/ MOBILISATION ADVANCE
21.1	Not applicable for this tender.
22.0	OVER RUN CHARGES----- NOT APPLICABLE
23.0	REVISION ON ACCEPTED CONTRACT RATE
23.1	Not applicable in this tender
24.0	PRICE VARIATION CLAUSE / ESCALATION
24.1	Not applicable for this tender.
25.0	LIQUIDATED DAMAGE
25.1	Intermediate Milestones----- Not Applicable
25.2	Overall Completion
25.2.1	If the contractor fails to maintain the required progress of work which results in delay in the completion of the works as per the contractual completion period, BHEL shall have the right to impose Liquidated Damage / Penalty at the rate of 0.5% of the contract value, per week of delay or part thereof subject to a maximum of ceiling specified below. For this purpose, the period of delay shall be the delay attributable to the Contractor for the completion of work as per contract. Contract Value for this purpose, shall be the final executable value exclusive of ORC, Extra Works executed, Supplementary / Additional Items and PVC.
25.2.2	If Completion of work goes beyond specified contract period of 6 (six) months from date of start of work for reasons attributable to contractor, as certified by Construction Manager, BHEL, LD will be imposed with maximum LD amount shall be 10 % of total contract value.
25.2.3	BHEL shall deduct the amount of such compensation from any money due or which may become due to the contractor and/or recover such compensation from the bank guarantees / security deposit of the contractor. To be entitled to impose such compensation, BHEL will not be required to prove that he has incurred such amount as actual damage.
25.2.4	BHEL reserve the right to cancel the order/ contract or a portion thereof at the risk & cost of the contractor and the contractor shall be liable to BHEL for any excess costs thereof.
Note:-	*Executable Contract value-Value of work for which inputs/fronts were made available to contractor and were scheduled for execution till the date of achievement of that milestone.
26.0	GUARANTEE / WARRANTY
26.1	The contractor will be responsible for the quality of workmanship, quality of materials/ items and design for which the contractor is responsible. Even though the work will be carried out under supervision of BHEL, the successful bidder will be responsible for the above.
26.2	Guarantee / warranty period shall be 12 months from the date of issue of work completion certificate. Commencement of guarantee period shall be from the date completion of work under the contract as certified by BHEL.

27.0	EXTENSION OF TIME FOR COMPLETION
27.1	If the completion of work as detailed in the scope of work gets delayed beyond the contract/ completion period due to reasons not attributable to contractor, the contractor shall make request for an extension of the contract and BHEL at its discretion may extend the contract. However such extension shall not entitle the vendor for price revision or price compensation as this being FIRM price contract.
27.2	Based on review of agreed & jointly signed L-2 / construction schedule (as enumerated in the tender), the balance work at the end of original contract period less the backlog attributable to the contractor shall be quantified, and the number of months of 'Time extension' required for completion of the same shall be jointly worked out. Within this period of 'Time extension', the contractor is bound to complete the portion of backlog attributable to contractor. Further 'Time extension' or 'Time extensions' at the end of previous extension shall be worked out similarly.
27.3	However, if any 'Time extension' is granted to the contractor to facilitate continuation of work and completion of contract, due to backlog attributable to the contractor alone, then it shall be without prejudice to the rights of BHEL to impose penalty / LD for the delays attributable to the contractor, in addition to any other actions BHEL may wish to take at the risk and cost of contractor.
27.4	A joint program shall be drawn for the balance amount of work to be completed during the period of 'Time Extension', along with matching resources to be deployed by the contractor as per specified format. Review of the programme and record of shortfall shall be done.
27.5	During the period of 'Time extension', contractor shall maintain their resources as per mutually agreed program
27.6	At the end of total work completion as certified by BHEL engineer, and upon analysis of the total delay, the portion of time extensions attributable to (i) Contractor, (ii) Force majeure conditions, and (iii) BHEL, shall be worked out and shall be considered to be exhausted in the same order. The total period of time extensions shall be the sum of (i), (ii) and (iii) above and shall be equal to period between the scheduled date of completion and the actual date of completion of contract. LD shall be imposed/ levied for the portion of time extensions attributable solely to contractor after adjusting delay attributable to BHEL & Force majeure and shall be recoverable from the dues payable to the contractor.
28.0	EARNESTMONEYDEPOSIT(EMD / SECURITY DEPOSIT (SD) / PERFORMANCE BOND (PB)
28.1	EARNESTMONEYDEPOSIT(EMD)
28.1.1	EMD is to be paid by tenderers for securing fulfilment of any obligations in terms of the NIT.
28.1.2	EMD & Tender cost amount can be submitted Bidders to the followings Bharat Heavy Electricals Limited bank account in Bangladesh- 1. SBI (Branch Address:-Khulna, Bangladesh), A/C No. 05620257520201 , BDT Account., SWIFT: SBINBDDH056, Routing number : 220471543
28.1.3	EMD & Tender cost amount can also be submitted directly by Indian Bidders to the followings Bharat Heavy Electricals Limited bank account in India- 1. SBI(Branch Address:-Commercial Branch, Saltlake, Sector V, Kolkata ,Branch Code SBIN0004289),A/C No. 11107800029,INR Account.

28.1.4	Amount of EMD exceeding INR 20 Lakh may be submitted in the form of Bank Guarantee (INR or eqv. USD/ BDT).In case of any Non-Indian Bank BG of local Bangladesh Bank, the same is to be countered guaranteed from any scheduled Bank from India.
28.1.5	Bidder may also deposit EMD in the form of Fixed Deposit Receipt (FDR) issued from the following banks valid for six months, as an additional mode of EMD submission. (a)AB Bank Limited (b)Citibank N.A. (c) Sonali Bank Limited (d)Standard Chartered Bank (e)The Hong Kong Shanghai Banking Corporation Ltd (f)Woori Bank (g) State Bank of India.
28.1.6	All other terms & conditions shall be as per GCC.
28.2	SECURITY DEPOSIT(SD)
28.2.1	The total amount of Security Deposit will be 5% of the contract value. EMD of the successful tenderer shall be converted and adjusted towards the required amount of Security Deposit.
28.2.2	At least 50% of the required Security Deposit, including the EMD,shall be collected in before start of the work. Balance of the Security Deposit shall be collected by deducting 10% of the gross amount in BDT progressively from each of the running bills of the Contractor till the total amount of the required Security Deposit is collected. If the value of work done at any time exceeds the contract value, the amount of Security Deposit shall be correspondingly enhanced and the additional Security Deposit shall be immediately deposited by the Contractor or recovered from payment/s due to the Contractor. The recoveries made from running bills (cash deduction towards balance SD amount) can be released against submission of equivalent Bank Guarantee in acceptable form, but only once, before completion of work, with the approval of the authority competent to award the work.
28.2.3	All other terms & conditions shall be as per GCC.
28.3	PERFORMANCE BOND
28.3.1	Not Applicable
29.0	CERTIFICATE TOWARDS COMPLETION
29.1	The work under the scope of the contractor shall be deemed to have been completed in all respects only when so certified by BHEL / owner. The decision of BHEL in this regard shall be final and binding on the contractor.
30.0	CIVIL LABORATORY
30.1	Deleted
31.0	CONSTRUCTION SCHEDULE
31.1	Entire work shall be carried out in accordance with the broad construction schedule given in CL No.10.1 above. Within 7 days from start of work, the contractor shall discuss with BHEL site engineer & furnish detail construction schedule (L-3/ L-4) indicating all milestones on the basis of major activities and get it approved from BHEL engineer. This schedule will undergo review and based on progress vis-à-vis project requirement, contractor shall have to submit revised schedule for approval of BHEL.
31.2	Deleted

31.3	The contractor shall plan his work in such a manner so as to meet the overall project schedule, in consultation with BHEL/ BIFCL engineer.	
31.4	Contractor shall submit daily work program based on above construction schedule. Deferment of above schedule is not acceptable. Contractor will adhere to schedule and resource planning to be augmented to ensure completion as per schedule.	
31.5	Periodic progress reviews on the entire activities of execution in respect of supply & works in scope of contractor will be held once in a month at Kolkata / site. These meetings will be attended by reasonably higher officials of the contractor and will be used as a forum for discussing all areas where progress needs to be speeded up. The contractor shall be further responsible for ensuring that suitable steps are taken to meet various targets decided upon such meetings.	
31.6	Above schedule is indicative. The contractor shall plan his work in such a manner so as to meet the overall project schedule, in consultation with BHEL/BIFCL Engineer.	
32.0	PAYMENT FOR ADDITIONAL/EXTRA ITEMS FOR CIVIL FOUNDATION WORKS	
32.1	It shall be as per relevant clause of the GCC. However, "BPWD Schedule of Rates 2018" as mentioned in the price schedule will be considered.	
33.0	DELETED	
34.0	TOOLS & PLANTS (TO BE PROVIDED BY CONTRACTOR)	
34.1	Tentative list of T&P to be deployed by contractor for successful completion of work is detailed below.	
34.2	It may be noted that the list is not exhaustive and is only for general guidance. The contractor is required to provide all necessary T&P (other than those specified to be provided by BHEL, if any) measuring (calibrated) instruments & handing equipments to maintain work progress for timely completion of total work as per contract. In case of project requirement, some activities may have to be pre-poned. In such cases the contractor may have to deploy additional T&P. Quoted rate shall be inclusive of such emerging requirements. However, contractor shall submit deployment plan of all T&P along with tender bid.	
34.3	In the event of any failure on the part of the contractor to deploy T & P to sustain desired work progress, BHEL may at his discretion also terminate the contract on this ground and take out any or whole amount of the contract from the scope of the contractor. In the event of failure of contractor to deploy necessary and sufficient T&P/ IMTEs to maintain work progress, BHEL will be at liberty to arrange the same at the risk & cost of contractor including transportation cost of same from any of BHEL site/ other agency & charges as applicable shall be deducted from contractor's RA bill. Decision of BHEL in this regard will be final & binding on contractor.	
34.4	Following Major T&Ps to be arranged by contractor within the indicated time	
	Major T&P items	Broad Mobilizing time from date of start of work
34.4.1	1 no. TRX Hydra10/12 T capacity	As per requirement
34.4.2	2 No. hydraulic excavator / Poclain With Long Boom arrangement	1 st – Within 20 days 2 nd – As per requirement
34.4.3	1 No. JCB / Pay Loader	As per site requirement
34.4.4	2 nos. transit mixer (4.5/5/6 M3 capacity)	1 st – Within 15 days 2 nd – As per requirement
34.4.5	1 nos. concrete pump (20/30 cum/ hr min capacity & lift 30 M)	Within 15 days
34.4.6		
34.4.7	2 nos. self priming dewatering pump 5 HP (diesel/ electric)	1 st – within 15 days 2 nd -As per requirement

34.4.8	2(Two) Nos.10 HP submersible mono-block electric pump (KOS-1040+ of Kirloskar or equivalent),	As per requirement.
34.4.9	1 nos. self priming dewatering pump 2 HP (diesel/ electric)	As per requirement
34.4.10	2 nos. curing pump – 1.5 /2 HP (pump for curing at heights)	1 st –within 30 days 2 nd – as per requirement
34.4.11	Dozer.	As per requirement
34.4.12	2 nos Dumper	1 st –within 30 days 2 nd -as per requirement
34.4.13	2 nos. reinforcement bending machine	As per requirement
34.4.14	2 nos. reinforcement cutting machine	As per requirement
34.4.15	2 nos. power driven earth rammer	As per requirement
34.4.16	1 no. vibromax (earth compacter)	As per requirement
34.4.17	2 nos. Vibro compactor/ plate compactor – drum width 750mm	1 st – within 30 days 2 nd -As per requirement
34.4.18	1 no total station with adequate arrangement for Surveyors	Within 15 days.
34.4.19	1 no. auto level & staff + 2 nos as required	Within 15 days.
34.4.20	20 nos concrete cube moulds	Within 15 days.
34.4.21	Adequate no. of small trucks 2T/5T for movement within site	As per requirement.
34.4.22	Adequate no of drinking water tank – 500 / 1000 lit.	As per requirement.
34.4.23	1 no trailer / tractor trailer for carrying of RS material within plant premises	As per requirement
34.4.24	Adequate no of Concrete vibrator with adequate needle (diesel driven + electric driven)	5 Nos within 30 Days. Balance diesel/electric as per requirement
34.4.25		
34.4.26		
34.4.26	Portable fire extinguishers as below: Soda acid– 10 sets. Dry chemical powder – 02 sets CO2 – 2 sets. Water & sand bucket (4 buckets in one stand) – 5 sets. Fire hose with nozzle (50 M length) – 2 sets.	As per requirement
34.5	<p>T&P shown in the above mentioned list are tentative based on planned progress requirement.</p> <p>Actual Mobilization schedule, based on front availability, drawings, construction schedule and material availability at site is to be reviewed and mutually agreed with BHEL site periodically from time to time for mobilization of major T&Ps, and the same have to be adhered to. No change will be permitted without written approval of Construction Manager, BHEL site.</p> <p>Further requirement will be reviewed time to time at site and contractor will provide additional T&P/equipment to ensure completion of entire work within schedule time without any financial implication to BHEL. All other T&Ps shall be provided by the contractor without any extra cost to BHEL. Vendor will give advance intimation & certification regarding capacity etc prior to dispatch of heavy equipments.</p>	

34.6	All T&P and all IMTEs, which are required for successful and timely execution of the work covered within the scope of this tender, shall be arranged and provided by the contractor at his own cost in working condition.	
34.7	In the event of non mobilisation of any T&P by the successful bidder and as a result progress of work suffered, BHEL reserves the right to deduct suitable amount from the dues of the bidder, with assigning reasons thereof at the following rates	
	Major T&P items	Recovery rates
34.7.1	Deleted	Deleted
34.7.2	TRX of Escorts group or equivalent (10/ 12 T cap	BDT 5450/- per week or part thereof
34.7.3		
34.7.4		
34.7.5		
34.7.6	Hydraulic excavator / Poclain	BDT 87200/- per week or part thereof
34.7.7	JCB / Pay Loader	BDT 87200/- per week or part thereof
34.7.8	Transit mixer (4.5/5/6 M3 capacity	BDT 10900/- per week or part thereof
34.7.9	concrete pump (20 cum/ hr min capacity & lift 70M)	BDT 32700/- per week or part thereof
34.7.10		
34.7.11	self-priming dewatering pump 5 HP (diesel/ electric)	BDT2725/- per week or part thereof
34.7.12	10 HP submersible mono-block electric pump (KOS-1040+ of Kirloskar or equivalent),	BDT 2725/- per week or part thereof
34.7.13	self-priming dewatering pump 2 HP (diesel/ electric)	BDT 2725/- per week or part thereof
34.7.14	curing pump – 1.5 /2 HP (pump for curing at heights)	BDT 2725/- per week or part thereof
34.7.15	dozer	BDT 68125/- per week or part thereof
34.7.16	dumper	BDT 7630/- per week or part thereof
34.7.17	reinforcement bending machine	BDT 7630/- per week or part thereof
34.7.18	reinforcement cutting machine	BDT 7630/- per week or part thereof
34.7.19	power driven earth rammer	BDT 109/- per week or part thereof
34.7.20	vibromax (earth compacter)	BDT 68125/- per week or part thereof
34.7.21	Vibro compactor/ plate compactor – drum width 750mm	BDT 32700/- per week or part thereof
34.7.22	Total station with adequate arrangement for Surveyor	BDT 7630/- per week or part thereof
34.7.23	Auto level & staff + 1 nos if required	BDT 7630/- per week or part thereof
34.7.24	drinking water tank – 5000 lit.	BDT 7630/- per week or part thereof
34.7.25	Concrete vibrator with adequate needle (3 Nos. diesel driven + 6 Nos. electric driven)	BDT 5450/- per week or part thereof
34.7.26	Any other instrument	As per discretion of the BHEL engineer
35.0	T&P TO BE PROVIDED BY BHEL	
35.1	BHEL shall not provide any T&P to contractor. Contractor shall arrange the required T&P for construction of the structures.	
36.0	OTHER TERMS	
39.1	All other term & conditions of this specification shall be governed by the pertinent provisions of GCC and other volumes of this tender, as applicable.	

ANNEXURE B
HSE REQUIREMENTS-MAITREE PROJECT

MANPOWER AND INFRASTRUCTURE

<u>SL NO.</u>	<u>ITEM</u>	<u>REQUIREMENTS</u>	<u>REMARKS</u>
2	Shift HSE Officer	Min 1 for every 500 workers or part thereof. Any sub-contractors with more than 20 workers must have a HSE officer. Each major work area must have a dedicated shift HSE officer as advised by BHEL HSE manager/officer.	Candidate should have <ul style="list-style-type: none"> • Degree/ diploma in Engg/Technology • Degree/ Diploma in H&S, min 2 years' experience in field of safety for Degree holder in Engg or Min 3 years with Diploma holder in Engg
3	Shift HSE stewards	Min 1 Steward for every 100 workers or part thereof. Deployment to be approved by BHEL HSE manager.	Candidate should have passed HSC(12 th standard) and attended a certificate course on construction safety or allied subjects
4	First aid box	1 in each office and major work area/floor	Items as per clause 76(2) of Bangladesh labour Rules and clause 7.4.5.3 of HSE plan for sub-contractors
5	Shift First aider	1 for each 150 worker Minor contractors may have tie up with major contractor with permission of BHEL HSE manager in this regard.	The candidate must have passed HSC and have a certificate from Bangladesh Red-cross society or as recognized by Govt. (PI refer 7.4.5.2 of HSE Plan for sub-contractors)
6	Ambulance	Deleted	Deleted
7	Sick room	Shall be available at site, being provided by other agency.	PI refer 7.4.5.1 of HSE Plan for sub-contractors for details. Running cost & construction cost to be shared among all sub-contractor Modalities to be worked out by site team
8	Emergency vehicle	To be available in all shifts of work	Must be a 4-wheeler.
9	Walky-talky	Deleted	
10	Binoculars	Deleted	
11	Height Rescue-kit	Deleted	
12	HSE related instruments	<ol style="list-style-type: none"> 1. Lux meter- 1no, 2. ELCB Tester-1 no.- 3. Earth Megger- 1 No. 4. Anemometer-1 no- 5. Alcohol Breath Analyser-1 	To be made available to BHEL as and when demanded or to be shared with other sub-contractors as instructed by BHEL

TENDER NO – Ref: BHEL: MSTPP: C- RW:CSD:22:10:06		
VOLUME-IF-CML- REV-0	TECHNICAL CONDITIONS OF CONTRACT (TCC)	PAGE 35 OF 35

Special Notes:

1. The following welfare measures, in addition to those covered above, are to be taken at the site :
 - a. Adequate Drinking Water
 - b. Adequate no of toilets and washing area
 - c. Canteen
 - d. Rest Shed
 - e. Hygienic Accommodation (Labour Colony) and allied facilities
2. It must be ensured that no contaminated water including those discharged from Toilets, Canteen, Office and Labour Colony shall be discharged to under-ground water table and river water
3. AS THIS SITE IS LOCATED IN A CYCLONE-PRONE AREA, ALL BUILDINGS AND SHED MUST BE CONSTRUCTED STRONG ENOUGH TO WITHSTAND ADVERSE WEATHER CONDITION
4. FURTHER TO POINT# 5, MASS EVACUATION OF PEOPLE FROM SITE MAY BE CALLED FOR, IF ADVISED SO, BY GOVT AGENCIES. AS IT WILL BE EXTREMELY DIFFICULT TO FIND A REST SHELTER FOR A FEW THOUSAND PEOPLE, IT IS FURTHER EMPHASISED THAT ACCOMMODATION MUST BE STRONG ENOUGH TO SURVIVE SUCH EXTREME WEATHER CONDITION.
5. BHEL shall provide drawing for labour accommodation and contractor shall construct the same in line to BHEL drawing with contractor's own contribution/expenses.
6. It is assumed that First aider will be sitting in a porta-cabin.
7. The initial shelter in labour colony for one month till Vendor is able to construct their own labour accommodation may be available in the existing colony on rental basis , based on availability in the existing labour colony.
8. Adequate Quarantine Facility for isolation of workmen of 14 days during induction is to be arranged by the Bidder due to Pandemic COVID-19. All sort of sanitization, hand gloves, nose mask social distancing at labour colony is to be maintained and ensure due to pandemic of COVID-19 as per SOP attached with this Tender.It shall be in practice till such time as demanded by Project Authorities.

VOLUME-III PRICE SCHEDULE, REV-0	
PACKAGE 10W: PILE CAP (EXCEPT PILING), CIVIL FOUNDATION & SUPERSTRUCTURE, ARCHITECTURAL WORKS OF CONSTRUCTION SHED AND PART BALANCE WORKS OF ROOF WATER PROOFING FOR AUX & BOP BUILDINGS FOR 2 X 660 MW MAITREE STPP, RAMPAL, BANGLADESH	
TENDER NO: Ref: BHEL: MSTPP: C- RW:CSD:22:10:06	
PREAMBLE	
1	This preamble forms part of tender document and schedule of items. The tenderer should read this preamble carefully before filling in rates for various items. Clauses under this preamble shall be read in conjunction with various volumes of tender and other tender sections as applicable and shall have precedence over any contrary statement mentioned any where in this document.
2	The work shall be carried out strictly as per specifications, description of the items in these schedule and / or engineer's instructions. Drawings enclosed with the tender are only preliminary and for tender purposes and giving some idea of the work involved. The work is to be executed as per drawings & documents, which shall be furnished during execution.
3	Items of work provided in this schedule but not covered in this specification shall be executed strictly as per instruction of the engineer.
4	Unless specifically mentioned otherwise in the tender document, the tenderer shall quote for the finished items and shall provide for the complete cost towards power, fuel, tools, tackles, equipment, constructional plants, temporary works, labour, dismantling of all temporary piping, structures, valves, pumps, tanks & other misc. equipment, strengthening of roads/culverts/bridges etc. including arranging all clearances etc. required for carrying out different activities & tests, materials, levies, taxes (except service tax), transport, layout, repairs, rectification, maintenance till handing over, supervisions, colonies, shops, establishments, overheads, profits and all incidental items not specifically mentioned but reasonably implied and necessary to complete the work according to the complete tender document and this schedule.
5	The rate is inclusive of making quarantine facility, deployment of safety officer, safety appliances like helmet, full body harness wherever required, safety goggles, safety shoe, safety vest, platform by pipes for erection as per sketch, bolt tightening Torque machine, fitness certificate of deployed T&P, specified forged clamps instead of ordinary clamps, plates for movement of cranes if required, test certificate for clamps, slings etc. The further detail are to be referred from respective specification.
6	Fabrication drawings, if required are to be prepared by the Bidder. FQP is to be followed strictly. Non destructive test like DP Test, RT, UT, LPI, welder qualification test are to be conducted. The further detail are to be referred from respective specification & FQP.
7	The quantities of the various items mentioned in this schedule of items are approximate, based on very preliminary information and may vary to any extent or be deleted altogether. The quoted rates of each item will remain firm throughout the period of execution including extension, for reasons whatsoever, as long as variation in the total value of work executed under any part of this contract including extra items, if any but excluding any price variation remains, within plus minus thirty percent ($\pm 30\%$) of the awarded price as per LOI.
8	Prior written approval of BHEL shall be sought by the contractor in case quantity variation of any item crosses +50% (plus fifty percent) limit during execution and approval to be obtained before execution of further quantity for this item.
9	In case Sealed / Paper Price Bids are opened for finalisation of the tender, for any Item Rate/BOQ based contract, possibility of variation of quantity/ addition/deletion of items can not be ruled out. Under such circumstances, after execution of work, if it is observed that standing as L-1 is changed based on actual quantity executed, the bidder shall give suitable rebate to maintain your standing as L-1. Since this aspect can be assessed at the end of execution, necessary adjustment will be effected at the end of execution in final bill. This condition shall not be applicable where the tender is finalised through Reverse Auction.
10	BHEL reserve the right to rationalize the rates, quoted by L-1 bidder against unit rate items and/ or other optional items with respect to item-wise lowest rates (amongst the participating bidders), before placement of order.
11	The rates quoted shall be inclusive of cleaning of site of any vegetation, dressing, clearing of old structures and leveling etc. including fixing of grid pillars, benchmarks etc. required for commencement of site activities. No separate payment will be made towards the same. However, if separate rate for such item is available in the rate schedule, the same shall be considered.
12	Rates shall be quoted in figures and in words in clear legible writing. No overwriting is allowed. All scoring and cancellations should be countersigned and in case of illegibility the interpretation of engineer shall be final. All entries shall be in English language.
13	All works item wise shall be measured upon completion and paid for at the rates quoted and accepted as per BHEL approved payment schedule/billing break-up.
14	The tender shall be deemed to have visited site and made himself aware of all the site conditions, studied the specifications and details of work to be done within the time schedule attached and to have acquainted himself of the conditions prevailing at site.
15	No splitting of the job is envisaged. Decision of BHEL in this regard shall be final and binding to the bidders.
16	Bidders are not allowed to alter the Price Schedule format including item description, quantity etc. and the offer is liable for rejection if the bidders submit their prices in Price Schedules modified by them. BHEL reserves the right to reject the offers of bidders who submit offers in Price Formats which are modified/altered by them. Also putting any comments instead of rates/price in the designated column of the rate schedule shall make the offer liable for rejection.
17	Bidders to note that for Civil &/Structural packages, against a particular item against a ST No. appearing in more than one schedule of the BOQ, same rate must be quoted in all schedules for that particular items with same descriptions. If by error, different rates are quoted in different schedules for same ST No. (i.e. item with same description), then the higher of the rates shall be considered for evaluation but awarding shall be done with the lower rate, if the bidder becomes L-1."
18	For Lumpsum Service Contract : The items/components indicated in the tender is indicative and may vary to any extent. No compensation shall be payable in case of any variation in the items/components listed in the bill of quantities if the executed weight remains within the variation limit. However, in case of deletion of any item or addition of new items over and above the items listed or variation of existing quantity beyond variation limit specified, adjustment (i.e. Payment or recovery as the case may be) shall be done on pro-rata basis based on the Rate per MT worked out from the quoted lump-sum Price and the total weight of components listed /indicated in price schedule plus 15% weight variation limit.
19	The quantities of the various items mentioned in this schedule of items are approximate, based on very preliminary information and may vary to any extent or be deleted altogether. The quoted rates of each item will remain firm throughout the period of execution including extension, for reasons whatsoever, as long as variation in the total value of work executed under any part of this contract including extra items, if any but excluding any price variation remains, within thirty percent ($\pm 30\%$) of the awarded price as per LOI.
20	Engineer's decision shall be final and binding on the contractor regarding clarification of items in the schedule with respect to the other sections/volumes of the contract.
21	In case of tender for Civil and/or Structural works, if the Non-schedule items are not quoted by the bidder, it will be treated at par with rate of corresponding item of CPWD/PWD/DSR/BPWD schedule as prescribed in the tender/BOQ cum Rate Schedule.
22	No interest, whatsoever, shall be payable by BHEL on the security deposit, any bank guarantee submitted or any amount due to successful bidder/contractor.
23	Size and weights of various items are mentioned in the attached BOQ cum rate/price schedule for reference purpose only & these shall not be taken into consideration for quoting/calculating amount in the rate schedule. These shall be utilised as per relevant sections of tender. Bidders shall quote for each item in the rate column, taking unit as mentioned in the quantity column. Rates shall be filled in both figures and words. Amount shall be calculated based upon these rates multiplied by the mentioned quantity for the respective items.
24	Bidder's Total price shall be considered for evaluation unless stated otherwise.
25	In case of BOP packages, if Bidder does not quote/indicate the price for freight charges against indicated rate schedule, the same shall be considered as 2% of basic price and adjusted with the total quoted price against each item keeping the total quoted price unaltered.

**VOLUME-III
PRICE SCHEDULE, REV-0**

**PACKAGE 10W: PILE CAP (EXCEPT PILING), CIVIL FOUNDATION & SUPERSTRUCTURE, ARCHITECTURAL WORKS OF CONSTRUCTION SHED AND PART
BALANCE WORKS OF ROOF WATER PROOFING FOR AUX & BOP BUILDINGS FOR
2 X 660 MW MAITREE STPP, RAMPAL, BANGLADESH**

TENDER NO: Ref: BHEL: MSTPP: C- RW:CSD:22:10:06

SCH-1 : TOTAL PRICE

SL NO	DESCRIPTION	PRICE SCHEDULE	TOTAL QUOTED PRICE (IN BDT) (Including AIT but excluding VAT)
		REF	
1.0	PACKAGE 10W: PILE CAP (EXCEPT PILING), CIVIL FOUNDATION & SUPERSTRUCTURE, ARCHITECTURAL WORKS OF CONSTRUCTION SHED AND PART BALANCE WORKS OF ROOF WATER PROOFING FOR AUX & BOP BUILDINGS FOR 2 X 660 MW MAITREE STPP, RAMPAL, BANGLADESH	SCH 2 - BREAK UP OF TOTAL PRICE	<u>IN FIGURES</u>
			<u>IN WORDS</u>

NOTE	
1.0	Bidder shall quote total price for total price of SCH-1- Part only at sl no 1 above. All other amounts/ rates of each item of works in respective schedules/ parts will be derived based on allocated percentages. As such, any uncalled figure/ amount noted at any other place/ schedule of Volume-III will not be recknoed & will stand null & void.
2.0	Bidder to note that total price at sl no 1.0 above shall be considered for evaluation & awarding. As such grand total price should be complete in all respect for the full scope defined and considering all terms and conditions.
3.0	Bidder to note that SCH-2 is Break-up of Total Price.
3.1	Bidder to note that SCH-3 covers SERVICE of respective items, unless specified otherwise in the description of items.
3.2	Bidder to note that SCH-4 is Break-up of SUPPLY unless specified otherwise in the description of items.
4.0	Bidder's quoted total price at Sl. no 1 above respectively shall be apportioned into amount of various items of works based on allocated percentages against respective item, in respective schedules/ parts. As such, bidder shall not indicate/ quote any amount/ rate in these schedules/ parts and any amount/ rate quoted against any item shall not be taken into cognizance/ account and offer may be liable for rejection.
5.0	Based on the itemwise percentage allocations, the amount for the individual items of the Bill of Quantity shall be arrived at. The rates of individual items shall be derived from the amount against each items after rounded off.
6.0	Bidders to note that this is an item rate contract. Payment shall be made for the actual quantities of work executed at the unit rate arrived at as per Sl No.7 below.
7.0	Unit rates of each item of works of respective schedules/ parts will be derived by dividing derived amount by corresponding quantities. In deriving the unit rates of each item in this manner, figures only upto 4 decimal places will be taken into account. Any adjustment, if required, due to such methodology, will be effected in final bill.
8.0	Successful bidder shall draw a schedule of quantities of various items of work of SCH-4 and obtain BHEL's approval/ clearance in writing before procurement, supply, etc.
9.0	Any item as per scope of work, if not included in the price quoted above and shown separately will not be taken cognizance of and the offer shall be liable for rejection.
10.0	Price format shall not be changed by bidder in any case and it may lead to cancellation of their offer.
11.0	The quantity of items may vary during execution mainly due to actual requirement etc. The unit rates work out from the overall amount quoted & accepted by BHEL shall be considered and no separate unit rates shall be allowed. Unit rates shall be valid throughout the contract period.
12.0	For payment of non schedule items, the rate shall be derived from Schedule of Rates 2022, PWD, Govt. of Bangladesh.

**VOLUME-III
PRICE SCHEDULE, REV-0**

PACKAGE 10W: PILE CAP (EXCEPT PILING), CIVIL FOUNDATION & SUPERSTRUCTURE, ARCHITECTURAL WORKS OF CONSTRUCTION SHED AND PART BALANCE WORKS OF ROOF WATER PROOFING FOR AUX & BOP BUILDINGS FOR 2 X 660 MW MAITREE STPP, RAMPAL, BANGLADESH

TENDER NO: Ref: BHEL: MSTPP: C- RW:CSD:22:10:06

SCH-2 : BREAK UP OF TOTAL PRICE SCHEDULE

SL NO	DESCRIPTION	PRICE SCHEDULE REF	TOTAL
1.0	SERVICE	SCH 3 -SERVICE	0.99571958
2.0	SUPPLY	SCH 4 -SUPPLY	0.00428042
	TOTAL		1

**VOLUME-III
PRICE SCHEDULE, REV-0**

**PACKAGE 10W: PILE CAP (EXCEPT PILING), CIVIL FOUNDATION & SUPERSTRUCTURE, ARCHITECTURAL WORKS OF CONSTRUCTION SHED AND PART BALANCE WORKS OF ROOF WATER PROOFING FOR AUX & BOP BUILDINGS FOR
2 X 660 MW MAITREE STPP, RAMPAL, BANGLADESH**

TENDER NO: Ref: BHEL: MSTPP: C- RW:CSD:22:10:06

SCH-3 : SERVICE PART

ST. NO	DESCRIPTION OF ITEM	UNIT	QUANTITY	WEIGHTAGE (Nearest to the 8 decimal points) W.R.T THE TOTAL value
	100 EARTH WORK			
	Earth work In excavation, backfilling and disposal including necessary men/women, materials, equipment, loading, transportation, unloading, dewatering etc as per specification, drawing, relevent laws of Bangladesh, relevant BS (or equivalent international standard) Standards approved by BIFPCL/BHEL and as directed by engineer- in-charge for the following.			
A101	Earth work in excavation in all types of soil including ash which can be excavated by any means including setting out, levelling, dewatering (but excluding special type of dewatering viz. well point method), shoring & strutting (wherever required), dressing the sides & bottom, all lifts, ramming/compacting the excavated bottom, stacking, disposal of surplus excavated materials within a lead upto 1 km, spreading/levelling of disposed materials etc all complete for following depths below ground level.			
a	Depth from ground level but not exceeding 2 m	CUM	6000.00	0.01677109
b	Depth exceeding 2 m but not exceeding 4 m	CUM	700.00	0.00254099
c	Depth exceeding 4 m but not exceeding 6 m	CUM	170.00	0.00094924
A108	Earthwork in Back filling upto any depth below ground level around foundations, plinths, trenches, drains etc to proper grade and level in layers not exceeding 250 mm thickness using/with selected earth directly from excavation within a lead upto 1 Km and compacted as specified including watering, ramming/compaction by manual/mechanical means, dressing etc all complete for the following.			-
e	Each layer compacted so as to achieve at least 85% relative density as per ASTM D-4253 & ASTM D-4254	CUM	2000	0.00151536
A109	Extra over ST No. 101, 103 to 108 and 2401 for carriage of material/earth for every 500 m or part thereof beyond an initial lead of 1 Km.	CUM	200	0.00002652
C 200	CONCRETE WORKS			-

	Placing of concrete work including cost of labour, materials (unless otherwise specified in BOQ/contract specification) and equipment for handling, transportation, placing, vibrating and curing, cleaning and rendering the exposed surface with cement sand mortar to give a smooth and even surface (excluding cost of centering, shuttering and reinforcement) with mechanised equipments like transit mixer, concrete pump etc, preparation of scheme for concreting, getting it approved by engineer, maintaining and submitting records of concreting. complete as per drawing, specifications, relevant laws of Bangladesh, manufacturer's recommendation, relevant BS standards/equivalent international standards and as approved by BIFPCL/BHEL and as per direction of engineer in charge for the following.(RMC SHALL BE PROVIDED BY BHEL AT BATCHING PLANT IN PROJECT PREMISES . TRANSPORTATION FROM THE BATCHING PLANT UP TO THE POURING POINT SHALL BE UNDER THE SCOPE OF CONTRACTOR)			
C201	Concrete of grade C8/10 as per BS EN-206 and BS 8500 or equivalent international standard (with 40 mm graded aggregate) as mass filling course, lean concrete, leveling course, mud mat, under and around foundation/floors at any depth below finished floor level etc.	CUM	20	0.00032409
C203	Concrete of grade C12/15 as per BS EN-206 and BS 8500 or equivalent international standard (with 40 mm graded aggregate) as lean concrete, leveling course, mud mat, under and around foundation/floors at any depth below finished floor level etc.	CUM	220	0.00374834
C204	Concrete under floors, paving, plinth protection, pipe encasing etc complete with 20 mm nominal size graded aggregate at any depth below finished floor level for the following grades.			-
b	Grade C16/20 as per BS EN-206 and BS 8500 or equivalent international standard	CUM	80	0.00176384
C205	Laying Design Mix cement concrete conforming to BS EN-206 and BS 8500 or equivalent international standard for reinforced concrete works with coarse sand and graded hard stone aggregate of 20mm nominal size in foundations/substructure, grade slab, paving, drains, under floors etc at any level below finished floor level, any shape, position or thickness etc complete including use of plasticizer/ superplasticizer conforming to BS EN 934 (latest) or equivalent international standard to achieve required slump in concrete all complete as per specification & drawing for the following.			-
a	Grade C20/25	CUM	80.00	0.00195324
b	Grade C25/30	CUM	20.00	0.00050233
c	Grade C30/37	CUM	120.00	0.00309694
C206	Laying Design Mix cement concrete conforming to BS EN-206 and BS 8500 or equivalent international standard for reinforced concrete works with coarse sand and graded hard stone aggregate of 20mm nominal size in superstructure at all level above finished floor level, any shape, position or thickness etc complete including use of plasticizer/ superplasticizer conforming to BS EN 934 (latest) or equivalent international standard to achieve required slump in concrete all complete as per specification & drawing for the following.			-
a	Grade C20/25	CUM	20.00	0.00051161

b	Grade C25/30	CUM	20.00	0.00050423
c	Grade C30/37	CUM	300.00	0.00829214
C212	Screed concrete conforming to relevant BS code or equivalent international code with coarse sand and graded hard stone aggregate 12.5mm/6 mm nominal size on the roof at any level or thickness, drains etc complete as per following.			-
a	1:2:4 (1 part cement, 2 part sand, 4 parts of aggregate by volume)	CUM	125.00	0.00273614
C213	Laying Design Mix cement concrete as per BS 8500 and BS EN 206 or equivalent International code for reinforced concrete works using graded aggregate for Concrete in precast works like roof slabs/trench covers, fins, lintels, chajas, beams, columns, wall panels, facias etc.at all levels in all kinds of work including formwork/moulds, curing, rendering the top exposed surface with cement sand mortar (1:3), handling, storing, transporting, all leads, erection without damage, setting in position with cement sand mortar (1:3), filling the gaps between adjacent precast units with concrete or cement sand mortar (1:3) and including making of holes for bolts for fixing, welding etc.complete with graded aggregate and as per specification and drawing for following grades.			-
c	C 40/50 grade	CUM	20	0.00066609
	MISC. CONCRETE RELATED WORKS			-
215	Dismantling concrete work for all types of structures at all levels including stacking of servicable material to a lead of 500 m and disposal of unservicable material upto a lead of 2 km, cutting of reinforcement, labour, equipment, safety precautions etc all complete as per drawings, specification and instructions of engineer in charge.			-
a	Plain cement concrete of all grades	CUM	15.00	0.00027491
b	Reinforced cement concrete of all grades	CUM	15.00	0.00041861
	300 FORM WORKS			-
	Providing, fixing and removing formwork at any elevations for all structures, as per specifications and including all labour, material, scaffoldings and centering complete including pockets, rubbing the fairfaced concrete with carborundum stone to make smooth finish etc. complete as per drawing, specifications, relevant laws of Bangladesh, relavant BS Standards or Equivalent International standards approved by BIFPCL/BHEL and as per direction of engineer in charge for the following.			-
A301	Fairface form work with good quality water proof ply wood (Plywood lining for form shall be of timber, which is resin bonded and water repellant) of minimum 12 mm thickness and smooth surface below finished ground floor level for foundations, footings, base of columns, walls, columns, pilasters, beams, mass concrete, trenches etc including providing 25mmx25mm chamfer at all exterior corners.	SQM	2,000.00	0.0172368

A302	Fairface form work with good quality water proof ply wood (Plywood lining for form shall be of timber, which is resin bonded and water repellent) of minimum 12 mm thickness and smooth surface above finished ground floor level for columns, beams, suspended floors, roofs, lintels, cantilevers, staircases, landings, balconies etc. for all heights including providing 25mmx25mm chamfer at all exterior corners.	SQM	7,590.00	0.08223437
	400 REINFORCEMENT			-
	Reinforcement work including all labour, material (unless otherwise specified in BOQ/contract specification), equipment, transportation, handling etc at all level as per specification, relevant laws of Bangladesh, relevant BS Standards or Equivalent International standards approved by BIFPCL/BHEL drawings and as directed by engineer - in - charge for the following			-
402	Straightening, cutting, bending, placing in position at any level, binding in position of steel reinforcements of grade B500B confirming to BS 4449:2005+A:2009 including cost of reinforcement steel, binding wire, labour, scaffolding, transportation to & from stores etc complete all as per specifications, drawings and as directed by Engineer. (REINFORCEMENT STEEL SHALL BE PROVIDED BY BHEL AS PER TCC)	MT	150.00	0.02176949
	500 WATER PROOFING WORKS			-
	Water proofing works including all labour, material, (unless otherwise specified in BOQ/contract specification) equipment, transportation, handling, curing, sampling, testing etc at any level as per specification, drawings, relevant laws of Bangladesh, relevant BS Standards or Equivalent International standards approved by BIFPCL/BHEL and as directed by engineer - in -charge.			-
501	Providing and laying underbed grading plaster with cement mortar 1:4 (1 cement : 4 sand) and average thickness of 15 mm including preparation of surface, batching, mixing, leveling etc. all complete.	SQM	500.00	0.00105351
506	Providing and applying PU based water proofing treatment with one coat of polyurethane or any other equivalent material based primer with an application rate of minimum 6 sq.m per litre and two successive liquid coatings of high solids content (min. 90%) urethane pre-polymers or equivalent material based finish coats as per relevant ASTM standards to form an elastomeric membrane with overall dry film thickness 1.5 mm subject to minimum 500 gm/sqm/coat application rate. Item includes surface preparation, polyscrim cloth /fabric, polymerised mortar base preparation etc all complete as per specifications and directions of engineer in charge. The water proofing compound should have low VOC(Volatile organic content) content as per recommended by green building norms. All necessary documentation (certificates, manufacturer declarations) should be provided by the contractor to green building consultant.	SQM	9,175.00	0.13305382

507	Providing and laying wearing course consisting of 25mm thick plain cement concrete (1 part cement, 2 part sand, 4 parts of aggregate by volume) with graded aggregate of 12.5mm size cast in panels of maximum size 1.2mx1.2m and reinforced with 0.56 mm dia. galvanised chicken wire mesh and sealing of joints (in grooves of 6mm X 6mm) using polysulphide compound etc all complete.	SQM	9,175.00	0.07096177
A509	Providing and applying two coats of bitumen of suitable grade as per relevant BS or equivalent international code @ 1.7kg/sqm with 1% antistripping compound in foundation, wall, column etc on concrete surfaces exposed to soil / ash including surface preparation etc. all complete.	SQM	950.00	0.00414806
600 JOINTS AND FILLERS				
	Joints & fillers including all labour, material, equipment, transportation, handling etc at any level as per specification, drawings, relevant laws of Bangladesh, relevant BS Standards or Equivalent International standards approved by BIFPCL/BHEL and as directed by engineer - in - charge.			-
601	Supplying & installation of bitumen impregnated fibre board conforming to relevant BS code or equivalent international code as joint filler at joints in concrete including nailing, coating of both faces with coal tar pitch/bitumin etc. all complete			-
a	12 mm wide joints.	SQM	15.00	0.0001478
c	25 mm wide joints	SQM	15.00	0.00028409
700 MS EMBEDMENTS				
	Embedments including all labour, material (unless otherwise specified in BOQ/specification), equipment, transportation, handling etc. at any level as per specification, drawings, relevant laws of Bangladesh, relevant BS Standards or Equivalent International standards approved by BIFPCL/BHEL and as directed by engineer - in - charge.			-
702	Fabrication, transportation, delivery at site and erection, installation and alignment of mild steel foundation bolt assembly conforming to relevant BS or equivalent international code in concrete along with nuts, lock nuts (as per relevant BS or equivalent international code), washers, anchor plates, stiffner plates, protective tape, pipe sleeves, templates etc. including welding, cutting, grinding, threading, drilling etc. all complete.	MT		-

703	Fabrication, transportation, delivery at site and erection, installation and alignment of mild steel foundation bolt assembly conforming to relevant BS or equivalent international code in concrete along with nuts, lock nuts (as per relevant BS or equivalent international code), washers, anchor plates, stiffner plates, protective tape, pipe sleeves, templates etc. including welding, cutting, grinding, threading, drilling etc. all complete with BHEL supplied material free of cost including loading, transportation, unloading etc. all complete from BHEL store to plant site.			-
a	Mild steel embedments, inserts, pipe sleeves, angle pieces, rungs of various diameters, plates of dimensions as required etc.	MT	0.8	0.00021938
704	Fabricating, erecting and installing following items in concrete/brickwall for all kind of works, including setting material in concrete, layout, scaffolding, cutting, forming, grinding, drilling, bolting, welding, jointing, testing etc. all complete.			-
e	Expansion fasteners (mechanical galvanised) of HILTI make or equivalent of safe tensile capacity as specified below for concrete work with expansion sleeve of stainless steel:			-
iii	HST M12	EACH	50	0.0002074
iv	HST M16	EACH	50	0.00036187
	800 GROUTING			-
	Grouting including all labour, material (unless otherwise specified in BOQ/specification), equipment, roughening surface, cleaning, ramming, curing etc. at any level unless otherwise specified as per specification, drawings, relevant laws of Bangladesh, relevant BS Standards or Equivalent International standards approved by BIFPCL/BHEL and as directed by engineer - in - charge.			-
803	Providing & grouting of pocket holes, pipe sleeves and under base plate of structural steel work/ machinery/ pipe supporting structures including roughening of surface, cleaning, ramming, curing etc. all complete with mix 1:1:2 (1 cement : 1 coarse sand : 2 aggregate of 6 mm down graded stonechips) using non shrink admixture. (Cost of all material and cleaning the pocket by compressed air shall be in the scope of the contractor).	CUM	1	0.00044004
	900 DOORS, WINDOWS, VENTILATORS, LOUVERS			-
	Doors (including master key system), windows, ventilators, louvers, roof ventilators, rolling shutters, partitions including all labour, material (unless otherwise specified in BOQ/specification), equipments, transportation, handling, preparation of working drawings etc. at any level as per specification, drawings, relevant laws of Bangladesh, relevant BS Standards or Bangladesh National building code or Equivalent International standards approved by BIFPCL/BHEL and as directed by engineer - in -charge.			-

904	Fixing single or double steel door shutters with 45mm thk flush design shutter comprising of two outer sheets of 18 gauge steel sheets rigidly connected and reinforced inside with continuous vertical 20 gauge stiffeners, spot welded in position at not more than 150mm on centres including void filled with mineral wool (density as per specification), all fittings, Godrej or equivalent make mortice lock with handle on both sides, shop and final painting etc all complete as per specification. stiffened with semitubular edge and central stiffening rail which shall convey the lock including fixtures, Godrej or equivalent make mortice lock with handle on both sides, shop and final painting etc all complete as per specification.	SQM	60.00	0.00061502
A909	Providing and fixing anodised aluminium work of Jindal, Hindalco or other equivalent approved make for door frames, doors, windows, ventilators, partitions, railing, skylight frames etc with extruded standard tubular and other sections including all fittings & fixtures and accessories of approved make conforming to relevant BS standard or equivalent international standard anodised and electro color dyed to required shade according to relevant BS standard or equivalent international standard (minimum anodic coating of grade AC15), fixed with rawl plugs, expansion fasteners, SS screws or with fixing clips, including necessary filling of gaps at junctions, at top, bottom and sides with required PVC/neoprene felt for bi-metallc protection etc.including preperation of working drawings, aluminium cleat angle, aluminium snap-on-beading for glazing/panelling, stair case tread nosing, with all fittings and fixtures (like tower bolts, handles, door stopper with rubber shoes, 'L' drops, stays, floor springs, hydraulic door closures etc.), CP brass/stainless steel screws, providing and fixing hinges/pivots, and making provision for fixing of fitting wherever required including cost of PVC/neoprene gasket, all complete as per drawing, specification and instructions of engineer in charge (Glazing and panelling shall be paid seperately).Weight of aluminium section only shall be measure.	KG	3,572.00	0.04661135
911	Providing and fixing of door closers as per relevant BS code or equivalent international code of approved make & quality all complete of following type :			-
a	Over head hydraulic door closures	Each	45.00	0.00074687
b	Floor mounted Hydraulic door closers	Each	4.00	0.00020507
A912	Fixing pressed steel frames fabricated from 16 gauge M.S sheet mortised, reinforced drilled and tapped for hinges and locks bolts strikes, hold fasts adjustable floor anchors, floor tiles/weather bars, paintings etc all complete as per specifications	Kg	390.00	0.00019463
914	Providing and fixing solid core PVC Frame with solid core PVC door Shutters (25 thk) of sintex or equivalent make including all fitting & fixtures as per specification, drawing and instructions of engineer in charge.	SQM	40.00	0.00228643
915	Providing, fixing and fitting of glazing of first grade class in steel/aluminium/wooden frames, where ever required, cleaning after fixing including hardware, gaskets, clips, beadings etc. all complete.			-
c	5.5 mm thick clear float glass	SQM	50.00	0.00136353
f	4 mm thick ground glass	SQM	13.00	0.00032876
hA	Two nos. 4 mm thick clear float glass hermetically sealed and separated by 16 mm thick air gap for thermal insulation (only single elevation area to be measured)	SQM	255.00	0.01290284
	1000 BRICKWORK			-

	Brickwork masonry including all labour, material (unless otherwise specified in BOQ/specification), equipment, transportation, handling, scaffolding etc. at all levels as per relevant laws of Bangladesh, relevant BS Standards or Equivalent International standards approved by BIFPCL/BHEL, specification, drawings and as directed by engineer - in - charge.			-
1001	Providing brick work in cement mortar 1:6 (1 part cement 6 parts coarse sand) in walls, chambers etc. in thickness varying from 230mm to 460mm at all depths, places and positions below plinth including raking out joints, curing, scaffolding etc. complete excluding plastering and painting.			-
c	Using burnt clay bricks as per relevant BS code or equivalent international code with crushing strength of 75 Kg/cm2	CUM	80.00	0.0102177
1002	Providing brick work in cement mortar 1:6 (1 cement 6 coarse sand) in walls, chambers etc. in thickness 230mm at all heights, places and position above plinth including raking out joints, curing, scaffolding etc complete excluding plastering and painting.			-
c	Using burnt clay bricks as per relevant BS code or equivalent international code with crushing strength of 75 Kg/cm2	CUM	235.00	0.03308174
1002AA	Providing masonry work with Autoclaved Aerated Concrete (AAC) block [600 mm x 200 mm, thickness ranging from 201 mm to 400 mm, maximum thermal conductivity of 0.18 W/(mK) and conforming to Category I of BS EN 771-4] in cement mortar 1:6 (1 part cement, 6 part sand of fineness 1.1) in walls, chambers etc. at all depths, places and positions above plinth including raking out joints, curing, scaffolding etc complete (excluding plastering and painting) complete as per relevant BS or equivalent international standards, drawings, specifications, manufacturer's recommendations.	CUM	500.00	0.09105758
1003	Providing brick work in cement mortar 1:4 (1 cement 4 coarse sand) in partition walls , chambers etc. in thickness 115mm at all heights, places and position above or below plinth/graded level including raking out joints, curing, scaffolding etc complete excluding plastering and painting as per specification.			-
c	Using burnt clay bricks as per relevant BS code or equivalent international code with crushing strength of 75 Kg/cm2	SQM	912.00	0.01598774
	1100 DAMP PROOF COURSE			-
	Damp proof course including all labour, material (unless otherwise specified in BOQ/specification), equipment, transportation, handling, shuttering, centering, curing etc at any level as per relevant laws of Bangladesh, relevant BS Standards or Equivalent International standards approved by BIFPCL/BHEL, specification, drawings and as directed by engineer - in - charge.			-
1101A	Providing Damp Proof Course 40mm thick 1:1.5:3 concrete (10mm and down graded aggregate) with 2% of approved admixture of water proofing compound all complete. Two layers of hot bitumen coating conforming to BS 6398 or equivalent international code shall be applied one before & one after the DPC.	SQM	220.00	0.00211052

	1200 CEMENT MORTAR PLASTER			-
	Cement mortar plaster including making grooves wherever required including all labour, material (unless otherwise specified in BOQ/specification), scaffolding, curing etc at any level as per relevant laws of Bangladesh, relevant BS Standards or Equivalent International standards approved by BIFPCL/BHEL, specification, drawings and as directed by engineer - in -charge			-
1201	Providing 18mm thick plaster in two layers outside the building/boundary wall in cement mortar 1:6 on walls, finished to a smooth finish including providing 3mmx3mm size grooves at junctions of two dissimilar materials all complete.	SQM	4,700.00	0.0186456
1202	Providing 12mm thick plaster inside the building/boundary wall in cement mortar 1:6 on walls finished to a smooth finish as per specification all complete.	SQM	4,000.00	0.0111281
1208	Providing drip coarse on plastered surface at all elevations for all type of work such as chajjas, parapet, projections etc. including scaffolding, finishing etc. complete with all labour, tools and plants as per specification, drawing and instructions of engineer in charge.	RM	1,044.00	0.00045574
	1300 FINISHES TO CONCRETE / PLASTERED SURFACES			-
	Finishes, painting to concrete, plastered surfaces including all primer, labour, material (unless otherwise specified in BOQ/specification), equipment, surface preparation, scaffolding etc. at any level as per relevant laws of Bangladesh, relevant B Standards or Equivalent International standards approved by BIFPCL/BHEL, specification, drawings and as directed by engineer - in - charge.			-
1304B	Two or more coats of acrylic distemper of approved brand and manufacture to give an even shade including a priming coat with distemper primer complete.	SQM	3,000.00	0.00407942
1305	Providing and applying two or more coats of acrylic emulsion paint of approved brand, shade and manufacture to give smooth, hard,durable & glossy finish including a coat of primer over prepared plaster surface as per manufacturers guideline.	SQM	2,000.00	0.00389253
1312A	Providing and applying 2 mm thick polymer based water resistant putty (wall putty) on walls including preparation of surface, staging, etc. to achieve a smooth even surface all complete as per specification and as directed by Engineer.	SQM	5,100.00	0.00731688
1313	Providing and applying ready made Epoxy Paint over areas other than steel structure with suitable pigments of approved shade as per specification and direction of Engineer. The epoxy paint shall be a two pack material and shall be resistant to water, splash, spillage & acidic environment. The epoxy paint coating shall be of 150micron thickness over epoxy primer.	SQM	1,590.00	0.00834902

1315	Providing and applying two or more coats of Acrylic based weather coat paint of approved brand and manufacture and required shade including one coat of primer after necessary cleaning/ washing, preparing the surface using coir brush/ wire brush, sand paper, including filling of cracks with putty wherever required etc. all complete to give smooth, hard, durable & glossy finish over a coat of primer over prepared plaster surface as per manufacturers guidelines. The final finished coating shall be fungus resistant, UV resistant, water repellent and extremely durable with color fastness as per specification.	SQM	7,120.00	0.01589929
1400 FLOORING AND SKIRTING				
	Flooring and skirting at any level including base layer, labour, material (unless otherwise specified in BOQ/specification), equipments, transportation, handling, curing, polishing etc. at any level as per relevant laws of Bangladesh, relevant BS Standards or Equivalent International standards approved by BIFPCL/BHEL, specification, drawings and as directed by engineer - in - charge.			-
1401	Providing and laying 50 mm thick heavy duty cement concrete in flooring with metallic hardener pigmented topping 12mm thick uniform graded treated iron particles in flooring. Under layer of 38mm thick cement concrete mix 1:2:4 (1 cement: 2 sand : 4 stone aggregates 12.5mm well graded) and top layer of 12mm thick metallic concrete of mix 1:2 (1 cement hardner mix with approved quality metallic hardening compound :2 stone aggregate 6mm nominal size) by volume including cement slurry, rounding off edges, aluminium strips etc. all complete for following (Quoted item rate shall be inclusive of providing glass joint strips):	SQM	1,050.00	0.01429106
1403	Providing and laying precast polished heavy duty cement concrete tiles (Carborundum topping pigment content is 3.5 kg per 50 kg of cement) of size 300X300X25 thick of approved shade as per relevant BS or equivalent international code including minimum 20 mm cement mortar bedding of 1:3 (1 cement : 3 sand) jointed with neat cement slurry @4.4 kg/sqm labour, material etc. all complete with pigment to match the shade of the tiles including rubbing, curing, grinding and polishing complete with laying as per relevant BS or equivalent international code etc. all complete for following:			-
a	Laid in floors	SQM	1,590.00	0.06426738
b	Laid in skirting	SQM	20.00	0.00088002
1404	Providing and laying interlocking C25/30 Grade concrete blocks in paving with approved colour and pattern including jointing sand, bedding layer of sand (35 mm thick) as per specifications and recommendations of manufacturer inclusive of cost of cement for paver manufacturing.	SQM	5,050.00	0.0703541
1416	Providing and laying vitrified ceramic tiles of polished variety from reputed / approved manufacturer, complete including epoxy grout, underbed of cement mortar 1:3 minimum 20mm thick underbed for flooring and 12mm thick underbed for dado/skirting with neat cement slurry @3.3Kg/sqm etc. all complete for following			-
a	600x600x10 mm thick tiles In flooring	SQM	426.00	0.01465644
b	600x600x10mm thick tiles In skirting and dado upto specific height	SQM	128.00	0.00438862

1417	Providing and laying vitrified ceramic tiles of matt finish from reputed / approved manufacturer including epoxy grout, underbed of cement mortar 1:3 minimum 20mm thick underbed for flooring and 12mm thick underbed for dado/skirting with neat cement slurry @3.3Kg/sqm etc. all complete for following			-
c	300x300X7 mm thick tiles In flooring	SQM	125.00	0.00330536
1427	Providing and fixing glazed ceramic tiles of approved color and design of size 200x300mm / 300x300mm / 300x400mm in dado of approved size, projecting 6mm uniformly from adjacent plaster or wall finish. The mix for 20 mm thick underbed plaster shall consist of 1part cement and 3 parts sand by weight. fairly moist but firm, tiles shall be pressed over under bed by applying cement slurry @3.3 kg/sqm including pigments, curing etc all complete for following thicknesses:			-
b	7mm thick	SQM	587.00	0.01093521
1700 RAIN WATER DOWN TAKE PIPES				
	Rain water down take pipes including all labour, material (unless otherwise specified in BOQ/specification), transportation, 2 coats of approved paint over one primary coat, fixtures, accessories etc at any level as per relevant laws of Bangladesh, relavant BS Standards or Equivalent International standards approved by BIFPCL/BHEL, specification, drawings and as directed by engineer - in - charge.			-
1706	Providing and fixing UPVC down take pipes of 160mm diameter- Class C as per BS 3505:1986 or equivalent international code all complete.	RM	400.00	0.0042965
1800 MISCELLANEOUS WORKS				
	Miscellaneous works including all labour, material (unless otherwise specified in BOQ/specification), equipment etc. at any level unless otherwise specified as per relevant laws of Bangladesh, relavant BS Standards or Equivalent International standards approved by BIFPCL/BHEL, specification, drawings and as directed by engineer - in - charge.			-
1801	Providing and Filling in trenches, plinths, area paving and other underground structures with graded stone aggregate of size range 63 mm to 45 mm in layers not exceeding 230 mm in thickness including breaking of stone boulders to required sizes, filling the interstices with selected sand and compacting to 85 % of original volume of stone stack for all lifts etc. all complete. Payment shall be made for the measurement of the volume of the compacted fill.	CUM	750.00	0.04489141
1801A	Providing and Filling in trenches, plinths, area paving and other underground structures with 50 mm downgraded jhama brick aggregate mixed with selected sand (F.M. 1.2) in (2:1) (Brick aggregate: sand) proportion to achieve minimum dry density of 90% with optimum moisture content (Modified proctor test) in layers not exceeding 150 mm in thickness including breaking and screening chips, laying and spreading etc. all complete. Payment shall be made for the measurement of the volume of the compacted fill.	CUM	525.00	0.0315117

AA1812	Laying of earthing mats/rods/plates/flats of "Galvanized steel" or "Stainless steel" inside concrete members (pile, pile cap, pedestals, columns, slabs, beams etc.) including risers, transportation from yard stores, loading, unloading, cutting to length, welding, connection to reinforcement using connectors, protective painting of joints etc. all complete. (Excavation & Back filling shall be paid separately under respective item of earth work. Earthing mats/rods/plates/flats, connectors shall be supplied by BHEL free of cost)	MT	1.00	0.00015787
2006	Supplying and fixing 600mm high concertina on top of boundary wall including GI tension wires, clips, anchors, accessories etc. all complete. Concertinal shall be from tensile serrated galvanised wire (HTSW) made with wire diameter of 2.5 mm which will be stretched to 6m and attached on two strands of galvanised HTSSW (high tensile spring steel wire) of 2.5mm dia by means of clips at 1m interval. These two HTSSW strands will be attached to the fence posts/ angles with 12 mm security fasteners. (Structural post shall be separately)	RM	650.00	0.00392323
	2100 WATER SUPPLY			-
	Water supply work including men, material (unless otherwise specified in BOQ/specification), equipment etc. at any level as per relevant laws of Bangladesh, relevant BS Standards or Equivalent International standards approved by BIFPCL/BHEL, specification, drawings and as directed by engineer - in - charge.			-
2101	Providing and fixing in position tested heavy duty type chromium plated (CP) brass long neck bib cocks including sockets, union, nuts etc all complete - Nominal size 1/2	Each	22.00	0.0004276
2102	Providing and fixing in position heavy duty brass stop cock of approved quality including all specials etc all complete - Nominal size 1/2	Each	22.00	0.00028128
2103	Providing and fixing in position heavy duty brass full way valve with wheel of approved quality including all specials etc all complete for following sizes:			-
a	Nominal size 1	Each	12.00	0.0000924
b	Nominal size 2	Each	12.00	0.00024182
2104A	Providing and fixing uPVC pipes conforming to BS:3505 pipes shall be concealed, complete for internal works with sockets, unions, elbows, tees, nipples etc conforming to BS 4346 or equivalent and clamps including cutting and making good the walls etc all complete for following sizes:			-
a	Nominal size 1/2	RM	90.00	0.00015728
b	Nominal size 3/4	RM	45.00	0.00010541
c	Nominal size 1	RM	15.00	0.00004387
d	Nominal size 1 1/4	RM	15.00	0.0000528
e	Nominal size 1 1/2	RM	15.00	0.00006154
2105A	Providing and fixing uPVC pipes conforming to BS:3505 for external work with sockets, unions, elbows, tees, nipples etc conforming to BS 4346 or equivalent including trenching & refilling etc all complete for following sizes:			-
a	Nominal size 1/2	RM	25.00	0.00004371
b	Nominal size 3/4	RM	12.00	0.00002812
c	Nominal size 1	RM	12.00	0.0000351

d	Nominal size 1 1/4	RM	12.00	0.00004224
e	Nominal size 2	RM	12.00	0.00005622
f	Nominal size 3	RM	12.00	0.00007035
2106	Providing and fixing 700mmx500mmx6mm thk mirror from reputed mirror manufacturer. Mirror shall be mounted with glass adjustable revolving CP brackets with CP screws etc all complete.	Each	22.00	0.00035046
2107	Providing and fixing 700mmx127mmx6mm thk clear glass with C.P Guard rails and mounted on C.P. brackets etc all complete.	Each	22.00	0.00041338
2108	Providing and fixing 25 mm diameter stainless steel towel rails (600mm X 25mm) with CP mounting brackets all complete.	EACH	10.00	0.00012286
2109	Providing and fixing 20mm dia chromium plated M.S. pipes wall mounted towel rod with C.P. Brackets etc all complete.	Each	22.00	0.00023505
2110	Providing and fixing C.P. soap holder mounted with C.P. screws etc all complete.	Each	22.00	0.00017427
2111	Providing and fixing stainless steel / C.P. liquid soap dispenser . Dispenser shall be round and easily revolving with removable threaded nozzle and mounted on C.P. brackets etc all complete.	Each	22.00	0.00036083
2112	Providing and fixing glazed vitreous wall mounted paper holder with suitable cover cum cutter fitted with CP screws etc. sll complete.	Each	22.00	0.0001845
2114	Providing & fixing in position HDPE/LDPE PVC water tank of approved make conforming to relevant BS or equivalent international code including making all necessary inlet & outlet pipes, fixture, ball cocks, valves, visible outside water level gauge etc all complete as per specification for following capacities . Pipes shall be paid separately under ST No. 2105A.			-
aA	500 liters capacity	Each	5.00	0.00054668
a	1000 litres capacity	Each	18.00	0.0038015
	2200 SANITARY WORKS			-
	Sanitary work including all labour, material (unless otherwise specified in BOQ/specification), equipment etc. at any level as per relevant laws of Bangladesh, relevant BS Standards or Equivalent International standards approved by BIFPCL/BHEL, specification, drawings and as directed by engineer - in - charge.			-
2201	Supply and fixing glazed vitreous china Wash Basin (minimum size 580x450 mm) conforming to relevant BS code or equivalent international code of approved shape with R.S. or C.I. brackets painted white, nominal size 1/2 chromium plated brass hot & cold mixing faucets with nylon washers, chromium plated brass chain with rubber plug, nominal size 1 1/4 chromium plated brass bottle trap and waste of standard pattern, nominal size 1 1/4 dia chromium plated brass trap unions, plastic connection pipe with chromium plated nuts, fittings, cutting and making good the walls where required etc all complete.			-
a	White	Each	22.00	0.00209714

2204	Providing and fixing colour glazed vitreous china European type water closet conforming to relevant BS code or equivalent international code with siphon, open front solid plastic seat and plastic cover, low level 12.5 litre PVC flushing cistern (same colour as WC) with valveless fittings, hand spray with angle valve and hand trigger, 100 cm long hose, toilet roll holders, necessary C.P connections etc all complete.			-
a	Floor mounted	Each	22.00	0.00402759
2206	Providing and fixing colour flat back glazed vitreous china urinals of size 440x265x355 mm with photo voltaic control flushing system as per relevant BS code or equivalent international code with flush pipes, lead pipes, gratings, traps and necessary C.P. fittings etc. all complete.	Each	12.00	0.00161734
2207	Supply, laying and jointing UPVC pipes conforming to BS EN 13476 or equivalent international code including bends, branches and all other necessary fittings, M.S holder bats/clamps, cutting and making good the walls and floors, jointing, testing etc all complete for following.:			-
a	75mm dia pipes	RM	59.00	0.00034589
b	110mm dia pipes	RM	50.00	0.00038734
c	160mm dia pipes	RM	4.00	0.00003897
d	200mm dia pipes	RM	60.00	0.00088423
2208A	Providing, laying circular RCC pipes for use in trench construction conforming to BS 5911 or equivalent international code with collars jointed with stiff mixture of cement mortar including testing of joints etc. all complete for following.			-
a	225mm dia	RM	100.00	0.00199552
b	300mm dia	RM	100.00	0.00256772
c	450mm dia	RM	100.00	0.00358131
2212	Providing and fixing circular heavy duty C.I. manhole cover of 600 mm dia with frame etc. all complete.	Each	9.00	0.00046105
2213	Providing and fixing square mouth S.W Gully trap grade 'A' complete with CI grating, brick masonry chamber and water tight CI cover with 300x300mm (inside). The weight of cover to be not less than 4.53 Kg and frame to be not less than 2.72 Kg etc all complete for following sizes:			-
a	100x100mm P or S Type.	Each	25.00	0.00092877
2215	Providing and fixing C.I. floor traps size 100 mm Inlet and 100 mm Outlet Sand Cast Iron S&S as per relevant BS code or equivalent international code with C.P jalli all complete	Each	25.00	0.00041823
2219	Providing and fixing white/colored vitreous urinal partitions of size 675x325x85mm all complete.	Each	15.00	0.00038048
	2300 STRUCTURAL STEEL			-
	Structural steel works including all labour, material (unless otherwise specified in BOQ/specification), equipments, transportation, handling etc. at any level as per relevant laws of Bangladesh, relevant BS Standards or Equivalent International standards approved by BIFPCL/BHEL, specification, drawings and as directed by engineer - in - charge.			-

	Structural steel works including all labour, material (unless otherwise specified in BOQ/specification), equipments, transportation, handling etc. at any level as per relevant laws of Bangladesh, relevant BS Standards or Equivalent International standards approved by BIFPCL/BHEL, specification, drawings and as directed by engineer - in - charge.			-
2301	Fabrication, erection and alignment of structural steel with mild steel of grade E350/S355 or equivalent conforming to IS2062/BSEN10025 or equivalent, pipes/chequered plate, mild steel rounds, monorails, stays, safety chains, ladders, MS grating etc. in columns, beams, gantry girders, bunkers, silos, hoppers, roof trusses, portals, laced purlins, space frames, hangers, struts, monorails, galleries, stiffeners, wall beams, sheeting runners, brackets, stub columns, bracings, cleats, trestles, base plates, splice plates, chequered plate flooring, decking and seal plates, steel frame grid over false ceiling, walkway platforms, ladders, stairs, stringers, treads, landings etc including 1 coat of redoxide zinc-chromate primer (one coat at shop), connection design & preparation of fabrication drgs,			-
	collection of steel from stores, fabrication, straightening, cutting, bending, rolling, grinding, machining, drilling, welding, electrodes and other consumables, preassembly, erection, bolting/welding (field connections will be mostly bolted type or as directed by Engineer in charge) alignment, erection bolts & nuts (weight of erection bolts, nuts and welds not payable), assembly, edge preparation, preheating, post heating, testing of welders, inspection of welds, visual inspection, non destructive and special testing, rectification and correction of defective welding works, production test plate, inspection and testing, erection scheme, protection against damage in transit, stability of structures, installation of temporary structures, setting column bases, surface preparation by means of manual or mechanical power tools, touch-up painting, rectification, dismantling and removal of all temporary structures (weight of temporary structures not payable), return of surplus / waste steel materials to store etc all complete as per specification, relevant BS code or equivalent international code. Including appointment of a separate agency, approved by BHEL, for review and approval of fabrication drgs, in consultation with BHEL. (Supply and fixing of permanent connection bolts & nuts are not included in this item and their weight shall not be considered for payment under this item.) (STRUCTURAL STEEL SHALL BE PROVIDED BY BHEL)			-
a	For Built up sections composed of Structural plates only including stiffeners e.g. plated columns, girders, etc. (other than coal bunker)	MT	5.00	0.00220284
b	For built up section composed of "rolled sections" or "rolled sections and plates" including stiffeners (other than coal bunker)	MT	5.00	0.002313
d	For all other items not covered above e.g. rolled sections, pipes, chequered plate etc	MT	5.00	0.00220284
e	For miscellaneous steel structures with surplus crate material / packing boxes available with BHEL store yard including cutting, gauging out required steel members from packing boxes / crate, shifting from store yard to site for fabrication / erection, return of surplus / unused materials, labour, consumables, etc. all complete except painting	MT	15.00	0.00784683

2301A	Erection and alignment of structural steel with mild steel of grade E350/S355 or equivalent conforming to IS2062/BSEN10025 or equivalent, pipes/chequered plate, mild steel rounds, monorails, stays, safety chains, ladders, MS grating etc. in columns, beams, gantry girders, bunkers, silos, hoppers, roof trusses, portals, laced purlins, space frames, hangers, struts, monorails, galleries, stiffeners, wall beams, sheeting runners, brackets, stub columns, bracings, cleats, trestles, base plates, splice plates, chequered plate flooring, decking and seal plates, steel frame grid over false ceiling, walkway platforms, ladders, stairs, stringers, treads, landings etc including collection of prefabricated steel from stores, rectification in prefabricated members (if any), preassembly, erection, bolting/welding (field connections will be mostly bolted type or as directed by Engineer in charge), electrodes and other consumables, alignment, erection bolts & nuts (weight of erection bolts, nuts and welds not payable), assembly, edge preparation, preheating, post heating, testing of welders, inspection of welds, visual inspection, non destructive and special testing, rectification and correction of defective welding works, production test plate, inspection and testing, erection scheme, protection against damage in transit, stability of structures, Supply and installation of temporary structures, setting column bases, surface preparation by means of manual or mechanical power tools, touch-up painting, rectification, dismantling and removal of all temporary structures (weight of temporary structures not payable), return of surplus / waste steel materials to store etc all complete as per specification, relevant BS code or equivalent international code. (Supply and fixing of permanent connection bolts & nuts are not included in this item and their weight shall not be considered for payment under this item)			
a	For Built up sections composed of Structural plates only including stiffeners e.g. plated columns, girders, etc. (other than coal bunker)			-
	Placement in Position(70%)	MT	5.00	0.00061683
	Alignment, Grouting, Welding,NDT,Bolt Tightening(30%)	MT	5.00	0.00026435
b	For built up section composed of "rolled sections" or "rolled sections and plates" including stiffeners (other than coal bunker)	MT		-
	Placement in Position(70%)	MT	5.00	0.00064761
	Alignment, Grouting, Welding,NDT,Bolt Tightening(30%)	MT	5.00	0.00027754
d	For all other items not covered above e.g. rolled sections, pipes, chequered plate etc	MT		-
	Placement in Position(70%)	MT	20.00	0.00246728
	Alignment, Grouting, Welding,NDT,Bolt Tightening(30%)	MT	20.00	0.00105741
2305	Providing and applying one coats of epoxy high solid finish paint with minimum 80 micron total dry film thickness (DFT) of approved make and shade to achieve an even shade over steel sections already having primer coats and keeping overall DFT with primer not less than 160 microns including protection, cleaning, rectification of damaged primer, scaffolding etc. all complete as per specification.	MT	10.00	0.00042722
2305A	Providing and applying two coats of epoxy high solid intermediate paint with minimum 80 micron total dry film thickness (DFT) of each coat (total 160 micron DFT of both the coats) of approved make and shade to achieve an even shade over steel sections already having primer coats and keeping overall DFT with primer not less than 240 microns including protection, cleaning, rectification of damaged primer, scaffolding etc. all complete as per specification.	MT	5.00	0.00029907
2305B	Providing and applying 1 coat of 2-comp polyurethane finish paint with minimum 50 micron total dry film thickness (DFT) of approved make and shade to achieve an even shade over steel sections already having epoxy high solid intermediate paint including protection, cleaning, rectification of existing damaged primer/paint, scaffolding etc. all complete as per specification.	MT	10.00	0.00034392

2310A	Fixing in position of permanent mild steel bolts (class 4.6 as per relevant BS code or equivalent international code) and nuts, washers etc. up to and inclusive of 39 mm diameter and upto 300mm long for structural steel work etc all complete.	Quintal	2.00	0.00020617
2311A	Fixing in position of high strength structural bolts (of property class 8.8, 10.9 as per relevant BS code or equivalent international code) and high strength structural hardened and tempered nuts conforming to relevant BS code or equivalent international code with hardened and tempered washers etc. up to and inclusive of 39 mm diameter and upto 300 mm long for structural steel work etc all complete.	Quintal	10.00	0.00212035
2312	Dismantling of steel structure, lowering of material and carriage of the dismantled material up to field fabrication shop / projects storage including temporary dismantling, cutting, re-welding, supporting, and restoring to correct position all temporarily dismantled members, re-alignment of all adjacent connected members to their correct positions (weight of such adjacent members and temporarily dismantled members not payable), scaffolding, staging, tools & tackles, gas cutting, welding, consumables etc all complete.	MT	1.00	0.00011232
2320	Supply, fabrication and fixing of GI pipe hand railing of 32 mm/40 mm dia (Medium Grade) including transportation, loading/unloading, painting etc. all complete..	MT	0.50	0.00144966
2320A	Fixing of GI pipe hand railing of 32 mm/40 mm dia (Medium Grade) including transportation, loading/unloading, painting etc. all complete..(PIPE SHALL BE ISSUED BY BHEL AS FREE OF COST AS PER TCC)	MT	2.50	0.00181252
M-05	Providing and Fixing MS Cage Ladder in concrete wall / brick wall including fasteners, all materials, labour complete	MT	5.20	0.0073416
	TOTAL FOR SCH-3	a		0.99571958
	TOTAL FOR SCH-4	b		0.00428042
	TOTAL COST IN BDT (a+b)			1

**VOLUME-III
PRICE SCHEDULE, REV-0**

PACKAGE 10W: PILE CAP (EXCEPT PILING), CIVIL FOUNDATION & SUPERSTRUCTURE, ARCHITECTURAL WORKS OF CONSTRUCTION SHED AND PART BALANCE WORKS OF ROOF WATER PROOFING FOR AUX & BOP BUILDINGS FOR 2 X 660 MW MAITREE STPP, RAMPAL, BANGLADESH

TENDER NO: Ref: BHEL: MSTPP: C- RW:CSD:22:10:06

SCH-4 : SUPPLY PART

ST. NO	DESCRIPTION OF ITEM	UNIT	QUANTITY	WEIGHTAGE (Nearest to the 8 decimal points) W.R.T THE TOTAL value
S900	DOORS, WINDOWS, VENTILATORS, LOUVERS			
	Doors (including master key system), windows, ventilators, louvers, roof ventilators, rolling shutters, partitions including all labour, material (unless otherwise specified in BOQ/specification), equipments, transportation, handling, preparation of working drawings etc. at any level as per specification, drawings, relevant laws of Bangladesh, relevant BS Standards or Bangladesh National building code or Equivalent International standards approved by BIFPCL/BHEL and as directed by engineer - in - charge.			
S904	Providing of single or double steel door shutters with 45mm thk flush design shutter comprising of two outer sheets of 18 gauge steel sheets rigidly connected and reinforced inside with continuous vertical 20 gauge stiffeners, spot welded in position at not more than 150mm on centres including void filled with mineral wool (density as per specification), all fittings, Godrej or equivalent make mortice lock with handle on both sides, shop and final painting etc all complete as per specification.	SQM	60.00	0.00350733
S912	Providing of pressed steel frames fabricated from 16 gauge M.S sheet mortised, reinforced drilled and tapped for hinges and locks bolts strikes, hold fasts adjustable floor anchors, floor tiles/weather bars, paintings etc all complete as per specifications.	Kg	390.00	0.00077309
	TOTAL			0.00428042

UNPRICE SCHEDULE

**PACKAGE 10W: PILE CAP (EXCEPT PILING), CIVIL FOUNDATION & SUPERSTRUCTURE, ARCHITECTURAL WORKS OF CONSTRUCTION SHED AND PART
BALANCE WORKS OF ROOF WATER PROOFING FOR AUX & BOP BUILDINGS FOR
2 X 660 MW MAITREE STPP, RAMPAL, BANGLADESH**

TENDER NO: Ref: BHEL: MSTPP: C- RW:CSD:22:10:06

SCH-1 : TOTAL PRICE

SL NO	DESCRIPTION	PRICE SCHEDULE	TOTAL QUOTED PRICE (IN BDT) (Including AIT but excluding VAT)
		REF	
1.0	PACKAGE 10W: PILE CAP (EXCEPT PILING), CIVIL FOUNDATION & SUPERSTRUCTURE, ARCHITECTURAL WORKS OF CONSTRUCTION SHED AND PART BALANCE WORKS OF ROOF WATER PROOFING FOR AUX & BOP BUILDINGS FOR 2 X 660 MW MAITREE STPP, RAMPAL, BANGLADESH	SCH 2 - BREAK UP OF TOTAL PRICE	<u>IN FIGURES</u>
			<u>IN WORDS</u>

NOTE	
1.0	Bidder shall quote total price for total price of SCH-1- Part only at sl no 1 above. All other amounts/ rates of each item of works in respective schedules/ parts will be derived based on allocated percentages. As such, any uncalled figure/ amount noted at any other place/ schedule of Volume-III will not be recknoed & will stand null & void.
2.0	Bidder to note that total price at sl no 1.0 above shall be considered for evaluation & awarding. As such grand total price should be complete in all respect for the full scope defined and considering all terms and conditions.
3.0	Bidder to note that SCH-2 is Break-up of Total Price.
3.1	Bidder to note that SCH-3 covers SERVICE of respective items, unless specified otherwise in the description of items.
3.2	Bidder to note that SCH-4 is Break-up of SUPPLY unless specified otherwise in the description of items.
4.0	Bidder's quoted total price at Sl. no 1 above respectively shall be apportioned into amount of various items of works based on allocated percentages against respective item, in respective schedules/ parts. As such, bidder shall not indicate/ quote any amount/ rate in these schedules/ parts and any amount/ rate quoted against any item shall not be taken into cognizance/ account and offer may be liable for rejection.
5.0	Based on the itemwise percentage allocations, the amount for the individual items of the Bill of Quantity shall be arrived at. The rates of individual items shall be derived from the amount against each items after rounded off.
6.0	Bidders to note that this is an item rate contract. Payment shall be made for the actual quantities of work executed at the unit rate arrived at as per Sl No.7 below.
7.0	Unit rates of each item of works of respective schedules/ parts will be derived by dividing derived amount by corresponding quantities. In deriving the unit rates of each item in this manner, figures only upto 4 decimal places will be taken into account. Any adjustment, if required, due to such methodology, will be effected in final bill.
8.0	Successful bidder shall draw a schedule of quantities of various items of work of SCH-4 and obtain BHEL's approval/ clearance in writing before procurement, supply, etc.
9.0	Any item as per scope of work, if not included in the price quoted above and shown separately will not be taken cognizance of and the offer shall be liable for rejection.
10.0	Price format shall not be changed by bidder in any case and it may lead to cancellation of their offer.
11.0	The quantity of items may vary during execution mainly due to actual requirement etc. The unit rates work out from the overall amount quoted & accepted by BHEL shall be considered and no separate unit rates shall be allowed. Unit rates shall be valid throughout the contract period.
12.0	For payment of non schedule items, the rate shall be derived from Schedule of Rates 2022, PWD, Govt. of Bangladesh.

Currency Matrix for BOP Package

Sl no	Nature	Mode	Currency	Place of Deposit/ Return	Exchange Rate as on date of	Rate Published by	Payable
1	Cost of tender	DD/NEFT/RTGS	Indian Rupees (INR)	India	Not Applicable	Not Applicable	Not Applicable
		DD/ Telegraphic Transfer	United States Dollars(USD)	India	Tender floating	SBI Card Rate	INR/USD [SBI Card Rate -- Bank TT Buying Rate]
		DD/ Telegraphic Transfer	Bangladesh Taka (BDT)	India	Tender floating	SBI Card Rate	INR/BDT [SBI Card Rate -- Bank TT Buying Rate]
		DD/ Telegraphic Transfer	Other Foreign Currency	India	Tender floating	SBI Card Rate	INR/ Other Foreign Currency [SBI Card Rate --Bank TT Buying Rate]
2	EMD by Bidder [Upto INR 20 Lakhs--- Compulsory] [More than INR 20 Lakhs --- Optional]	DD/NEFT/RTGS	Indian Rupees (INR)	India	Not Applicable	Not Applicable	Not Applicable
		DD/ Telegraphic Transfer	United States Dollars(USD)	India	Tender floating	SBI Card Rate	INR/USD [SBI Card Rate -- Bank TT Buying Rate]
		DD/ Telegraphic Transfer	Bangladesh Taka (BDT)	India	Tender floating	SBI Card Rate	INR/BDT [SBI Card Rate -- Bank TT Buying Rate]
		DD/ Telegraphic Transfer	Other Foreign Currency	India	Tender floating	SBI Card Rate	INR/ Other Foreign Currency [SBI Card Rate --Bank TT Buying Rate]
3	EMD by Bidder [More than INR 20 Lakhs - Optional]	Bank Guarantee from Scheduled Bank in India.	Indian Rupees (INR)	India	Not Applicable	Not Applicable	Not Applicable
		Bank Guarantee from Scheduled Bank in India. In case of Bank Guarantee by Foreign Bank, the bank Gurantee should be counter Guranteed / Confirmed by any Scheduled Bank in India	United States Dollars(USD)	India	Tender floating	SBI Card Rate	INR/USD [SBI Card Rate -- Bank TT Buying Rate]
			Bangladesh Taka (BDT)	India	Tender floating	SBI Card Rate	INR/BDT [SBI Card Rate -- Bank TT Buying Rate]
			Other Foreign Currency	India	Tender floating	SBI Card Rate	INR/ Other Foreign Currency [SBI Card Rate --Bank TT Buying Rate]
4	Offer by Bidder		INR Compulsorily (If inadvertently the same is quoted in any foreign currency , it will be converted to INR at TT Selling rate of SBI as on latest date of Part-I Bid opening). In case of bank holiday , forex rate of previous SBI Working day.				

Sl no	Nature	Mode	Currency	Place of Deposit/ Return	Exchange Rate as on date of	Rate Published by	Payable
5	Reverse Auction		INR				
6	Price Bid Evaluation		INR Compulsorily (If inadvertently the same is quoted in any foreign currency , it will be converted to INR at TT Selling rate of SBI as on latest date of Part-I Bid opening). In case of bank holiday , forex rate of previous SBI Working day.				
7	Order by BHEL		Supply (for the % as mentioned in tender)--In INR / Evaluated INR Services (for the % as mentioned in tender)--In USD -- At TT selling rate of SBI as on latest date of Part-I Bid opening). In case of bank holiday , forex rate of previous SBI Working day				
8	Return of EMD to unsuccessful Bidder [Net of Bank Charges]	DD/NEFT/RTGS	Indian Rupees (INR)	India	Not Applicable	Not Applicable	At the Actual amount received in INR
		DD/ Telegraphic Transfer	United States Dollars(USD)	India	Not Applicable	Not Applicable	At the Actual amount received in USD
		DD/ Telegraphic Transfer	Bangladesh Taka (BDT)	India	Not Applicable	Not Applicable	At the Actual amount received in BDT
		DD/ Telegraphic Transfer	Other Foreign Currency	India	Not Applicable	Not Applicable	At the Actual amount received in Other Foreign Currency

Sl no	Nature	Mode	Currency	Place of Deposit/ Return	Exchange Rate as on date of	Rate Published by	Payable
9	Conversion of EMD to SD for successful Bidder	Book Adjustment in BHEL	If submitted in Indian Rupees (INR)	India (Against Supply contract for the 100% amount of EMD)	Not Applicable	Not Applicable	Not Applicable
			If submitted in United States Dollars(USD)	India (Against Supply contract for the whole amount of EMD)	At the actual converted value to INR	At the actual converted value to INR	At the actual converted value to INR
			If Submitted in Bangladesh Taka (BDT)	India (Against Supply contract for the whole amount of EMD)	At the actual converted value to INR	At the actual converted value to INR	At the actual converted value to INR
			If submitted in Other Foreign Currency	India (Against Supply contract for the whole amount of EMD)	At the actual converted value to INR	At the actual converted value to INR	At the actual converted value to INR
10	Billing	By Sub-contractor (Hord Copy)	INR -- For Supply portion United States Dollars(USD) -- For Services portion	India -For Supply Bangladesh - For Services	Not Applicable	Not Applicable	Not Applicable
11	Payment against contract execution	Cheque/ EFT / SWIFT	Indian Rupees (INR)- for supply	India	Not Applicable	Not Applicable	Not Applicable
			United States Dollars(USD) - for services	Bangladesh	Not Applicable	Not Applicable	Not Applicable
			Any other Currency -For Supply --- (In case of foreign vendor, if INR payment is not preferred)	India	Date of Payment	TT Selling Rate of Banker of BHEL	INR/ Other currency [BHEL Indian Banker's TT Selling Rate]
			Bangladesh Taka (BDT) -For Services --- (At the discretion of BHEL only if payment in USD is not possible)	Bangladesh	Date of Payment	Buying Rate of Banker of BHEL	USD / BDT [BHEL's Bangladesh Banker's Buying Rate]

Sl no	Nature	Mode	Currency	Place of Deposit/ Return	Exchange Rate as on date of	Rate Published by	Payable
12	Balance SD	As per Tender (Deposit before start of work / Recovery from RA Bills)	INR -- For Supply portion (after adjusting of 100% EMD in cash) United States Dollars(USD) -- For Services portion	India -For Supply Bangladesh - For Services	Not Applicable	Not Applicable	Not Applicable
13	Performance Bank Guarantee (where applicable)	Bank Guarantee from Scheduled Bank in India. In case of Bank Guarantee by Foreign Bank, the bank Guarantee should be counter Guaranteed / Confirmed by any Scheduled Bank in India	INR -- For Supply portion United States Dollars(USD) -- For Services portion	India (Separate for both Supply & Services portion)	Not Applicable	Not Applicable	Not Applicable
14	Financial Evaluation of Pre Qualification Criterion		Indian Rupees (INR)	India	Not Applicable	Not Applicable	Not Applicable
			United States Dollars(USD)	India	Tender floating	SBI Card Rate	INR/USD [SBI Card Rate -- Bank TT Buying Rate]
			Bangladesh Taka (BDT)	India	Tender floating	SBI Card Rate	INR/BDT [SBI Card Rate -- Bank TT Buying Rate]
			Other Foreign Currency	India	Tender floating	SBI Card Rate	INR/ Other Foreign Currency [SBI Card Rate --Bank TT Buying Rate]

Note: Currency matrix shall prevail over any other similar clause mentioned elsewhere in the tender document.

INTEGRITY PACT

Between

Bharat Heavy Electricals Ltd. (BHEL), a company registered under the Companies Act 1956 and having its registered office at "BHEL House", Siri Fort, New Delhi — 110049 (India) hereinafter referred to as "The Principal", which expression unless repugnant to the context or meaning hereof shall include its successors or assigns of the ONE PART

and

----- description of the
party along with address), hereinafter referred to as The Bidder/ Contractor" which expression unless repugnant to the context or meaning hereof shall include its successors or assigns of the OTHER PART'

Preamble

The Principal intends to award, under laid-down organizational procedures, contract/s for

_____ The Principal values full compliance with all relevant laws of the land, rules and regulations, and the principles of economic use of resources, and of fairness and transparency in its relations with its Bidder(s)/ Contractor(s).

In order to achieve these goals. the Principal will appoint Independent External Monitor(s), who will monitor the tender process and the execution of the contract for compliance with the principles mentioned above.

BHEL

BIDDER

Section 1- Commitments of the Principal

1. 1 The Principal commits itself to take all measures necessary to prevent corruption and to observe the following principles: -

1.1.1 No employee of the Principal, personally or through family members, will in connection with the tender for, or the execution of a contract, demand, take a promise for or accept, for self or third person, any material or immaterial benefit which the person is not legally entitled to.

1.1.2 The Principal will, during the tender process treat all Bidder(s) with equity and reason. The Principal will in particular. before and during the tender process, provide to all Bidder(s) the same information and will not provide to any Bidder(s) confidential /additional information through which the Bidder(s) could obtain an advantage in relation to the tender process or the contract execution.

1. 1 .3 The Principal will exclude from the process all known prejudiced persons.

1.2. If the Principal obtains information on the conduct of any of its employees which is a penal offence under the Indian Penal Code 1860 and Prevention of Corruption Act 1988 or any other statutory penal enactment, or if there be a substantive suspicion in this regard, the Principal will inform its Vigilance Office and in addition can initiate disciplinary actions.

Section 2 - Commitments of the Bidder(s)/ Contractor(s)

2.1. The Bidder(s)/ Contractor(s) commit himself to take all measures necessary to prevent corruption. He commits himself to observe the following principles during his participation in the tender process and during the contract execution.

2.1.1. The Bidder(s)/ Contractor(s) will not, directly or through any other person or firm, offer, promise or give to the Principal or to any of the Principal's employees involved in the tender process or the execution of the contract or to any third person any material , immaterial or any other benefit which he / she is not legally entitled to, in order to obtain in exchange any advantage of any kind whatsoever during the tender process or during the execution of the contract.

2.1.2. The Bidder(s)/ Contractor(s) will not enter with other Bidder(s) into any illegal or undisclosed agreement or understanding, whether formal or informal. This applies in particular to prices, specifications, certifications, subsidiary contracts, submission or non-submission of bids or any other actions to restrict competitiveness or to introduce cartelization in the bidding process.

2.1 .3 The Bidder(s)/ Contractor(s) will not commit any penal offence under the relevant IPC/PC Act; further the Bidder(s)/ Contractor(s) will not use improperly, for purposes of competition or personal gain, or pass on to others, any information or document provided by the Principal as part of the business relationship, regarding plans, technical proposals and business details, including information contained or transmitted electronically.

2.1.4 The Bidder(s)/ Contractor(s) will, when presenting his bid, disclose any and all payments he has made, and is committed to or intends to make to agents, brokers or any other intermediaries in connection with the award of the contract.

2.2 The Bidder(s)/ Contractor (s) will not instigate third persons to commit offences outlined above or be an accessory to such offences.

Section 3 - Disqualification from tender process and exclusion from future contracts

2.1.2 The If the Bidder(s)/ Contractor(s), before award or during execution has committed a transgression through a violation of Section 2 above, or acts in any other manner such as to put his reliability or credibility in question, the Principal is entitled to disqualify the Bidder(s)/ Contractor(s) from the tender process or take action as per the separate "Guidelines on Banning of Business dealings with Suppliers/ Contractors". framed by the Principal.

Section 4 - Compensation for Damages

4.1 If the Principal has disqualified the Bidder from the tender process prior to the award according to Section 3, the Principal is entitled to demand and recover the damages equivalent Earnest Money Deposit/Bid Security.

4.2 If the Principal has terminated the contract according to Section 3, or if the Principal is entitled to terminate the contract according to section 3, the Principal shall be entitled to demand and recover from the Contractor liquidated damages equivalent to 5% of the contract value or the amount equivalent to Security Deposit/Performance Bank Guarantee, whichever is higher.

Section 5 - Previous Transgression

5.1 The Bidder declares that no previous transgressions occurred in the last 3 years with any other company in any country conforming to the anti-corruption approach or with any other Public Sector Enterprise in India that could justify his exclusion from the tender process.

5.2 If the Bidder makes incorrect statement on this subject, he can be disqualified from the tender process or the contract, if already awarded, can be terminated for such reason.

Section 6 - Equal treatment of all Bidders/ Contractors / Sub-contractors

6.1 The Bidder(s)/ Contractor(s) undertake(s) to obtain from all subcontractors a commitment consistent with this Integrity Pact and report Compliance to the Principal. This commitment shall be taken only from those sub-contractors whose contract value is more than 20 % of Bidder's/ Contractor's contract value with the Principal. The Bidder(s)/ Contractor(s) shall continue to remain responsible for any default by his Sub-contractor(s).

6.2 The Principal will enter into agreements with identical conditions as this one with all Bidders and Contractors.

6.3 The Principal will disqualify from the tender process all bidders who do not sign this pact or violate its provisions.

Section 7 - Criminal Charges against violating Bidders/ Contractors /Subcontractors

If the Principal obtains knowledge of conduct of a Bidder, Contractor or Subcontractor, or of an employee or a representative or an associate of a Bidder, Contractor or Subcontractor which constitutes corruption, or if the Principal has substantive suspicion in this regard, the Principal will inform the Vigilance Office.

Section 8 -Independent External Monitor(s)

8.1 The Principal appoints competent and credible Independent External Monitor for this Pact. The task of the Monitor is to review independently and objectively, whether and to what extent the parties comply with the obligations under this agreement.

8.2 The Monitor is not subject to instructions by the representatives of the parties and performs his functions neutrally and independently. He reports to the CMD, BHEL.

8.3 The Bidder(s)/ Contractor(s) accepts that the Monitor has the right to access without restriction to all contract documentation of the Principal including that provided by the Bidder(s)! Contractor(s). The Bidder(s)/ Contractor(s) will grant the monitor. upon his request and demonstration of a valid interest, unrestricted and unconditional access to his contract documentation. The same is applicable to Sub-contractor(s). The Monitor is under contractual obligation to treat the information and documents of the Bidder(s)/Contractor(s) / Sub-contractor(s) with confidentiality,

8.4 The Principal will provide to the Monitor sufficient information about all meetings among the parties related to the contract provided such meetings could have an impact on the contractual relations between the Principal and the Contractor. The parties offer to the Monitor the option to participate in such meetings.

8.5 As soon as the Monitor notices, or believes to notice, a violation of this agreement, he will so inform the Management of the Principal and request the Management to discontinue or take corrective action, or heal the situation, or to take other relevant action. The Monitor can in this regard submit non-binding recommendations. Beyond this, the Monitor has no right to demand from the parties that they act in a specific manner, refrain from action or tolerate action.

8.6 The Monitor will submit a written report to the CMD BHEL within 8 to 10 weeks from the date of reference or intimation to him by the Principal and, should the occasion arise, submit proposals for correcting problematic situations.

8.7 The CMD, BHEL shall decide the compensation to be paid to the Monitor and its terms and conditions.

8.8 If the Monitor has reported to the CMD, BHEL, a substantiated suspicion of an offence under relevant IPC / PC Act , and the CMD , BHEL has not , within reasonable time, taken visible action to proceed against such offence or reported it to the Vigilance Office, the Monitor may also transmit this information directly to the Central Vigilance Commissioner, Government of India.

8.9 The number of Independent External Monitor(s) shall be decided by the CMD BHEL.

8.10 The word 'Monitor' would include both singular and plural.

Section 9 - Pact Duration

9.1 This Pact begins and shall be binding on and from the submission of bid(s) by bidder(s). It expires for the Contractor 12 months after the last payment under the respective contract and for all other Bidders 6 months after the contract has been awarded.

9.2 If any claim is made / lodged during this time, the same shall be binding and continue to be valid despite the lapse of this pact as specified as above, unless it is discharged/ determined by the CMD, BHEL.

Section 10 - Other Provisions

10.1 This agreement is subject to Indian Laws and jurisdiction shall be registered office of the Principal, i.e. New Delhi.

10.2 Changes and supplements as well as termination notices need to be made in writing. Side agreements have not been made.

10.3 If the Contractor is a partnership or a consortium, this agreement must be signed by all partners or consortium members.

10.4 Should one or several provisions of this agreement turn out to be invalid, the remainder of this agreement remains valid. In this case, the parties will strive to come to an agreement to their original intentions.

10.5 Only those bidders / contractors who have entered into this agreement with the Principal would be competent to participate in the bidding. In other words, entering into this agreement would be a preliminary qualification.

For & On behalf of the Principal
(Office Seal)

For & On behalf of 'the Bidder/ Contractor
(Office Seal)

Place-----

Date-----

Witness: Witness: -----

(Name & Address) -----

Witness: Witness: -----

(Name & Address)-----
