



BHARAT HEAVY ELECTRICALS LIMITED

BAP – Ranipet, 632406

MM – PURCHASE Department (FGD)

NIT

BHEL Ranipet Enq for.: PTFE Mauda
Enq No: 3820046E

Date: 11-04-2022

Sub: Requirement for "Supply of PTFE Gaskets" as per BHEL Drg 4-FW-000-01471 Rev 00 dt 22-01-2022 for BHEL Site NTPC-Mauda, by BHEL-Ranipet.

Scope of supply: As subjected above below listed, suitable for fluid temperatures range 30 deg C to 150 deg C, in confirmation with Quality plan and relevant standard as per drawing.

Enq sl no	BHEL Material code	Description	Unit	Qty	Quoted/Not Quoted
1	RFW216510001	NB 250 PTFE Gasket as per item sl 7 of drg 4-FW-000-01471	No	6	

Destination: BHEL Site NTPC Mauda

Delivery required date: 31-05-2022 or within 45 days from the date of manufacturing clearance, whichever is later. Bidder to quote the best possible delivery from the date of manufacturing clearance. Abnormal quoted delivery, liable for rejection of offer.

Pre-Qualification requirement (PQR): Any manufacturer, Trader or authorised dealer may participate in the enquiry.

Technical requirement

- (a). **Manufacturing: Document Submission-**Drawing, Data sheet and quality plan shall be submitted upon ordering for approval by BHEL. **Manufacturing clearance** will be provided upon approval of drawing with data sheet and QAP. Manufacturing shall be as per attached technical specification in the bid, Approved drawing, Quality plan and Data sheet. **Inspection:** as per Cl (b) below stated. **Dispatch Clearance:** Upon submission of inspection reports along with test certificates in original and Packing list dispatch clearance will be provided by BHEL.
- (b). **Inspection:** Inspection (call to be raise by supplier at BHEL COIR portal) before despatch at supplier's works (as per Quality terms and Quality plan) by BHEL/authorised agency (TPI-Third Party Inspection) for indigenous supplies at BHEL cost. Inspection includes for painting and packing also, as applicable. All the Test and inspection reports shall be sent to BHEL-Ranipet for review and dispatch clearance.
- (c). **Packing requirement:** Packing shall be waterproof. All item shall be packed in such a way that transit damage and weather deterioration may be avoided. Material code with description & Supplier name shall be marked on the packing.
- (d). **Documents:** Accepted IR copy along with relevant test certificates (in original) before despatch to be given to BHEL. This is required for Dispatch clearance.
- (e). **Reverse Auction** shall not be conducted, bidders are requested to quote best competitive rates during price bid itself.



BHARAT HEAVY ELECTRICALS LIMITED

BAP – Ranipet, 632406

MM – PURCHASE Department (FGD)

(f). Delivery Location: FOR destination (BHEL Site), as per bid

Note:

1. Quote shall be in INR only
2. Quoted rate shall be exclusive of GST (GST shall be paid extra)
3. Non Submission of any of required documents as listed below, attracts for offer rejection.

List of documents to be attached (signed and stamped copy, filled in wherever applicable):

1. NIT
2. Drawing
3. CQR, Quality plan along with filled in Annexure Q
4. Filled in Annexure C
5. Signed copy of annexure B
6. Filled-in Make in India declaration on Letter head (format attached-Form 1 and 2 both)
7. Udyam portal registration copy if MSE bidder

For any query: Kindly provide the “Enq 3810959E - PTFE Gskt-Mauda” in the subject of mail.

mail: ckbharti@bhel.in; jecashish@bhel.in

Ph: 9488 58 9287 / 7010 75 1675

CAUTION: The information on this document is the property of BHARAT HEAVY ELECTRICALS LTD. It must not be used directly or indirectly in any way detrimental to the interest of the company.

REV	DATE	ALTERED
		CHECKED

ALL DIMENSIONS ARE IN MILLIMETRES

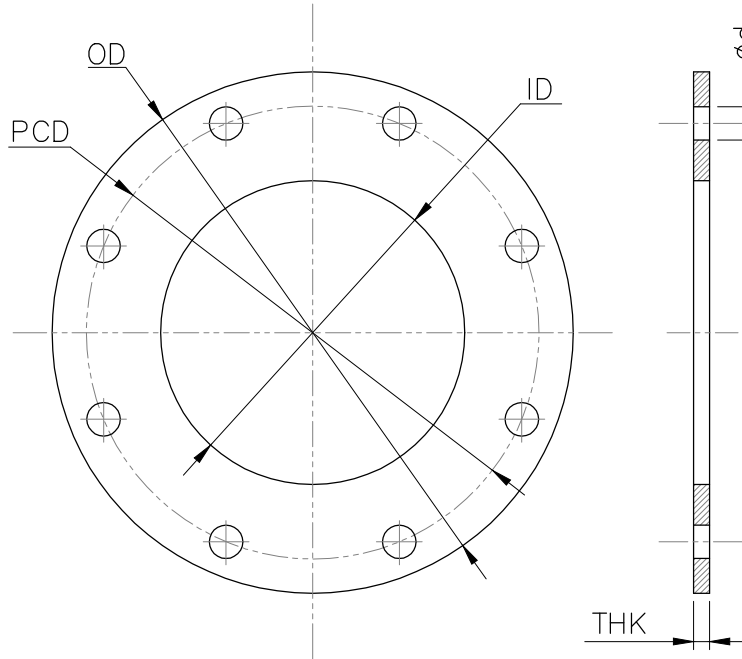

PTFE GASKET

DIMENSION DETAILS

ITEM NO	SIZE (NB)	ID (MM)	OD (MM)	PCD (MM)	HOLE DIA	HOLE NOS.	THK (MM)	DRILLING STANDARD
1	50	62	150	120.7	19	4	4	ASME B16.5 #150.
2	80	91	190	152.4	19	4	4	ASME B16.5 #150.
3	100	114	230	190.5	19	8	4	ASME B16.5 #150.
4	125	141	254	215.9	22	8	4	ASME B16.5 #150.
5	150	168	279	241.3	22	8	4	ASME B16.5 #150.
6	200	221.5	343	298.5	22	8	4	AWWA C207 CLASS D
7	250	276	406	362	26	12	4	AWWA C207 CLASS D

NOTES

1. MATERIAL: PTFE (ANTI-CORROSION, COMPRESSED, NON-ASBESTOS TYPE).
2. OPERATING TEMP. OF FLUID SHALL BE 30° C TO 150° C.

FOR TENDER PURPOSE ONLY

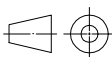
	BHARAT HEAVY ELECTRICALS LTD., UNIT: BOILER AUXILIARIES PLANT. RANIPET - 632 406.		DRN	NAME	SIGN	DATE	NO. OF VAR
			CHD	M.VIGNESH		22.01.22	
			APPD	DHEERAJ KR		22.01.22	
DEPT WS	GRADE OF UNTOL.DIM		SCALE	WEIGHT (KG).	REF. TO ASSY./OLD DRG.		ITEM NO.
CODE 9776	PR: QA: 500		NTS	---			
TITLE			CARD CODE	DRAWING NO.			REV
PTFE GASKET			U 01	4-FW-000-01471			00

SI	Terms and condition	BHEL requirement	Bidder response
1	Delivery Location - FOR BHEL Site NTPC Mauda. Packing & Forwarding, Freight & Insurance are in Supplier's scope i.e. included in the quoted prices. Unloading at BHEL Stores would be to the account of BHEL only. Material receipt date at stores will be considered for LD calculation purpose.	No Deviation	
2	Delivery Period: To mention clearly the exact delivery period as it attracts contractual penalty on delays. Delivery is the essence of the contract. The contractual delivery period will be reckoned from the date of manufacturing clearance, which shall be binding on the contract. To be indicated in days from date of receipt of manufacturing clearance for each item. Before opening the Price Bid, based on the commercial bids received, if required, BHEL shall fix a reasonable delivery period, which would be generally the modal value of the deliveries quoted by the tenderers in the Bid. DELIVERY PERIOD INDICATED IS TENTATIVE ONLY. SUPPLY IS TO BE MADE AFTER CLEARANCE by BHEL ONLY. HENCE PLS QUOTE THE MINIMUM TIME REQUIRED FOR SUPPLY, AFTER GETTING CLEARANCE FROM BHEL. BHEL requirement: Within 45 days from the date of manufacturing clearance - Please indicate clearly. The offer is liable for rejection, if the quoted delivery period is found to be abnormal for BHEL.	Within 45 days from Manufacturing clearance	
3	Terms of Payment -Terms of payment for Indigenous Suppliers: 100% payment will be made directly thru' EFT within 45 day for MSE (Micro and Small Enterprise) Vendors and 90 days for Non-MSE Vendors from the date of receipt and acceptance of materials at BHEL Site. GST compliance inv, Inspection and Test reports/certificate and proof of delivery shall be submitted along with invoice. All bank charges are to seller's account. For MSE, pls provide the certificate from UDYAM PORTAL.	No Deviation	
4	Reverse Auction (RA) will not be conducted for this tender. Bidder is requested to best quote during price bid.	Pls confirm	
5	Tender Evaluation: Tender shall be evaluated on package wise. All the items of the tender shall be ordered to same vendor.	Pls confirm	
6	OFFER Validity: Supplier to mention clearly the validity date of the offer. Minimum 90 days from the date of Technical Bid (Part-I) opening or 30 days from the price bid opening (whichever occurs later). The specific acceptance for this offer validity is must. -Pls confirm.	Pls confirm	
7	Test Certificate: To be submitted as per approved MQP alongwith Chemical and Mechanical properties and dimensions as per Standards and our Technical Delivery Conditions-Pls confirm	Pls confirm	



SI	Terms and condition	BHEL requirement	Bidder response
8	Guarantee Certificate: The Bidder warrants that the equipment's/items shall be free from defects in the design, engineering, materials and workmanship of the Plant and Equipment supplied and of the work executed. The Guarantee Period shall be Eighteen (18) months from the date of supply. If during the Guarantee/ Warranty/Defect Liability Period any defect should be found in the design, engineering, materials and workmanship of the Plant and Equipment supplied or of the work executed by the Bidder, the Bidder shall promptly, in consultation and agreement with BHEL regarding appropriate remedying of the defects, and at its cost, repair, replace or otherwise make good (as the Bidder shall, at its discretion, determine) such defect as well as any damage to the Facilities caused by such defect. In case of failure of the equipment to meet the guarantee, BHEL reserves the right to reject the equipment. However, BHEL reserves the right to use the equipment until new equipment supplied by bidder meets the guaranteed requirement - Pls confirm	Pls confirm	
9	"Inspection before despatch: Inspection before despatch (including stage-wise inspection) at supplier's works as per MQP by BHEL/authorised agency at BHEL cost." In case of foreign supplies, vendor shall engage and appoint any internationally reputed third party inspection agencies at their cost and send the inspection report for BHEL/customer's review and clearance / acceptance. List of inspection agencies are provided in Annexure - Q	Pls confirm	
10	Taxes and duties : GST in % (for Indigenous supplier): "Please indicate the exact percentage of GST/SGST/UTGST/IGST (whichever is applicable) is quoted as per the existing tariff on the date of the offer and all benefits as per existing laws have been considered. It is the responsibility of the seller to issue the Tax Invoice strictly as per the format prescribed under the relevant applicable GST law (CGST Act/SGST Act/UTGST Act/IGST Act). GST invoice is required for availing Input Tax Credit.	Bidder to provide detail	
11	GSTIN of the supplier/ works - attach the GST registration copy – Vendor to provide detail	Y/N	
12	HSN CODE(s) of the items offered.- Vendor to provide detail	Pls furnish	
13	PAN No - Attach the Copy of PAN card- Vendor to provide detail	Pls furnish	

SI	Terms and condition	BHEL requireme nt	Bidder response
14	"Liquidated Damages (LD) : The applicable LD shall be at the rate of 0.5% per week to maximum of 10% for the full order value and for the deliveries made beyond the agreed Delivery Period. Delivery being the essence of BHEL's contract requirements, in the event that a Supplier does not accept the above LD condition, the offer would be loaded to the extent of the shortfall with respect to upper limit specified above. " - Pls confirm. Deviation, if any, shall be brought.	Pls confirm	
15	Risk Purchase Clause (as per clause-I of Annexure-B) (Supplier Confirmation Required) - Pls accept the terms. Otherwise, liable for rejection	Pls confirm	
16	"Firm Price: Prices shall be kept firm and unchanged till completion of supplies."- Offers with firm/constant price only will be considered.	Pls confirm	
17	Supplier Registration Form (for new bidders/vendors)- Online submission is to be done and soft copy of the same as per annex F to be uploaded along with Technical Bid by new vendors.	Reqd for new vendors	
18	"MSE / Non MSE Status with proof MSE Proof to be submitted. UDYAM Portal registration certificate with date of filing and registration shall be submitted along the offer Otherwise, it will be treated as Non MSE"	Pls furnish	
19	For this procurement, public procurement (preference to make in India) , order 2017 dt 15.06.2017, 28.05.2018, 29.05.2019, & 04-06-2020 and subsequent order issued by the restrictive nodal ministry shall be applicable even if issued after issue of this NIT but before finalization of contract/PO/WO against this NIT. In the event of any nodal ministry prescribing higher or lower percentage of purchase preference and/ or local content in respect of this procurement, same shall be applicable. Pls ensure to submit the Make in India format submission.	Pls confirm	
20	Minimum Local content shall be 20%. Please furnish details of location where this value addition has been done (.....)	Pls furnish	
21	Margin of purchase preference to make in India shall be 20%	Pls furnish	
22	Acceptance to our General Terms & Conditions (Annexure B ver 22)	Pls furnish	
23	Acceptance for submission of signed MQP as per sample format enclosed, in the event of ordering, MQP to be submitted.	Pls furnish	

SI	Terms and condition	BHEL requireme nt	Bidder response
24	Annexure F - to be filled in by all New Indian vendors and to be uploaded	Pls furnish	
25	Contact details of bidders for technical queries – Provide details	Y/N	
26	Name of person	Pls furnish	
27	Designation	Pls furnish	
28	Mobile No / Telephone No.	Pls furnish	
29	e-mail id	Pls furnish	
30	"False declaration will be in breach of the code of integrity under Rule 175 (i)(h) of the General Finance Rule for which a bidder or its successors can be debarred for up to two years as per Rule 151(iii) of the General Finance Rules along with such other actions as may be permissible under Law"-Pls confirm	No deviation	
31	GeM seller id	Pls furnish	

 बी एच ई एल Ranipet		MANUFACTURER'S NAME & ADDRESS BHEL/ BHEL APPROVED SOURCE		STANDARD QUALITY PLAN				PROJECT: AS PER PO.						
				ITEM: PTFE GASKETS		QP. NO.: PTFE GASKET :393 Rev No. :01 Date: 10.12.2020 Page 1 of 2								
SL NO	COMPONENT & OPERATION	CHARACTERISTICS	CLASS OF CHECK	TYPE OF CHECK	QUANTUM OF CHECK		REFERENCE DOCUMENTS	ACCEPTANCE NORMS	FORMAT OF RECORD		Agency			REMARKS
					M	B/C			M	B	C			
1	2	3	4	5	M	B/C	7	8	9	D	**10			11

1.0 RAW MATERIALS (Polytetrafluoroethylene)													
1.1	PTFE	Appearance and Density	Major	Visual & Measurement	One Sample / Batch		Manufacturer Plant Procedure/ Relevant Standard/ Approved Datasheet/ Drawing	TC	√	P	V	-	
1.2	PTFE	Tensile Strength & Elongation	Major	Measurement	One Sample / Batch		Manufacturer Plant Procedure/ Relevant Standard/ Approved Datasheet/ Drawing	TC	√	P	V	-	
1.3	PTFE	Hardness	Major	Measurement	One Sample / Batch		Manufacturer Plant Procedure/ Relevant Standard/ Approved Datasheet/ Drawing	TC	√	P	V	-	
2.0 INPROCESS CONTROL													
2.1	Machining	Cutting/Machining	Major	Dimension Measurement	100%	100%	Datasheet/ Drawing	Report	√	P	V	-	
3.0 FINAL INSPECTION													
3.1	Final Testing of PTFE Gasket	Visual & Dimension	Major	Visual & Measurement	100%	100%	P.O. / Material Specification/ Relevant Standard/ Approved Datasheet/ Drawing	Report	√	P	W	-	
3.2	Identification, Packing & Preservations	Visual	Major	Visual	100%	100%	P.O. / Material Specification/ Relevant Standard/ Approved Datasheet/ Drawing	COC	-	P	V	-	

Manufacturer/ Supplier Sign & Stamp with date	Legends: M – Manufacturer / Subcontractor, B - BHEL /BHEL Authorized Inspection Agency, C – Customer/ Customer Authorized Inspection Agency, P - perform, V - Verification of reports W - Witness, TC - Test certificate “D” – Record, identified with tick (√) shall be essentially included by Supplier in QA documentation. COC- Certificate of Conformance.	Prepared by	Reviewed and Approved by
		 Rakesh Kr Madhu/Dy Mgr(QA)	 K Renjith (Mgr/QA)

 Ranipet		MANUFACTURER'S NAME & ADDRESS BHEL/ BHEL APPROVED SOURCE		STANDARD QUALITY PLAN				PROJECT: AS PER PO.						
				ITEM: PTFE GASKETS		QP. NO.: PTFE GASKET :393 Rev No. :01 Date: 10.12.2020 Page 2 of 2								
SL NO	COMPONENT & OPERATION	CHARACTERISTICS	CLASS OF CHECK	TYPE OF CHECK	QUANTUM OF CHECK		REFERENCE DOCUMENTS	ACCEPTANCE NORMS	FORMAT OF RECORD		Agency			REMARKS
					6				9	D	M	B	C	
1	2	3	4	5	M	B/C	7	8	9	D	**10			11



Note:

1. Materials shall be procured in compliance to Functional Technical Specification/Drawing.
2. Gauges and measuring Instruments, with valid calibration only shall be used
3. Finished Products shall be packed to comply with approved Packing Schedule..
4. All the inspection report as per P.O. shall be submitted to BHEL for Review and record purpose.

**** This QP Shall be read along with relevant P.O. and BHEL Drawing/Specification.**

Record of revision

REV NO	DATE	DESCRIPTION
00	14.03.2020	Original Issue
01	10.12.2020	Reviewed and totally revised

Manufacturer/ Supplier Sign & Stamp with date	Legends: M – Manufacturer / Subcontractor, B - BHEL /BHEL Authorized Inspection Agency, C – Customer/ Customer Authorized Inspection Agency, P - perform, V - Verification of reports W - Witness, TC - Test certificate "D" – Record, identified with tick (√) shall be essentially included by Supplier in QA documentation. COC- Certificate of Conformance.	Prepared by 	Reviewed and Approved by 
		Rakesh Kr Madhu/Dy Mgr(QA)	K Renjith (Mgr/QA)

Annexure to Enquiry no:		Date	##Specific confirmations by the manufacture
Sl.No	BHEL / Customer Requirement		
1	Quality Plan Requirement:		
1a	MQP (Manuafcutering Quality Plan) shall be submitted in attached format for BHEL/Customer review & approval. Typical MQP is attached for indicative purposes for guidance & use.		
1b	MQP shall invariably cover w.r.t Inward inspection including on Raw materail Procurement, In process and Final inspection in elaborated way/details.		
1c	Bidder shall also to give specific confirmation that on need basis, their competent officials shall visit to BHEL/customer for finalization of Quality plan including test procedure/methodology during preaward / post award approval / detailed engineering in the event of an order.		
1d	No deviation on BHEL/Customer approved MQP is acceptable.		
1e	Bidder shall agree to submit all cross referred documents other than codes/standrads to BHEL/Customer/Consultant.		
2	Important Notes shall be included in MQP : (a) Latest revision of Standard s & Specification shall apply. Only International Standards are applicable. Indian & Chinese Standards are not applicable. (b) Materials shall be procured in compliance to Functional Technical Specification. (c) Inspection shall be in compliance with Approved Quality Control Procedure for the Product. (d) NDT shall be carried out by Qualified Personnel with compliance to Approved NDT Procedures and Acceptance Norms, as per ASME Section V. (e) Gauges and measuring Instruments, with valid calibration only shall be used. (f) Cleaning and Painting of products shall be carried out as per Approved Painting Schedule. (g) Finished Products shall be packed to comply with Approved Packing Schedule. (h) Welding shall be carried out by Qualified Personnel with compliance to Approved NDT Procedures and Acceptance Norms, as per ASME Section V.		
3	Domestic / Inland Inspection will be carried out by BHEL/BHEL apointed Third Party Inspection Agency (TPIA) / Customer/Customer Apointed Inspection Agency/Consulatnat. This is applicable for all Stage inspection and Final Inspection identified as "W" - Witness or "CHP" - Customer Hold Point as per customer approved Quality Plan/ Technical specification / Approved Drawing/ Approved Data sheet / Scheme / PID / PFD / SLD (Process Instrumentaion Diagram / Process Flow Diagram / Single Line Diagram) etc (As applicable). "The inspection charges at actuals incurred by BHEL will be loaded to compare with foreign suppliers".		
4	Inspection Agency for Foreign Bidders and also for Indian Bidder but importing from Forgign Sources: (1) Any one of the flollowing Third Party Inspection Agency (TPIA) shall be appointed by the bidder and same shall be furnished by the bidder in techno commercial bid itself. (2) The details of TPIA with contact details like Name of the official, Phone no, Email id shall also to be submitted during pre/post award. However cost for such inspection agency shall be borne by the bidder only. Inspection charges for such inspection agency shall be indicated separately so that if BHEL/Customer is undertaking the inspection by on their own , then these charges non claimable by the bidder. List of TPIA (1). M/s Bureau Veritas, (2). M/s TUV-Nord, (3). M/s TUV-SUD, (4). M/s TUV Rheinland, (5). M/s Lloyds Register, (6). M/s SGS, (7). M/s Germanischer Lloyds, (8). M/s QUEST, (9). M/s Certification Engineers International, (10). M/s Intertek, (11). M/s IR Class Systems and Solutions, (12). M/s DNV, (13). M/s Fichtner, (14). M/s ABS Inspection Services.		
5	Stage Inspection during manufacturing Process : Stage Inspection during manufacturing shall be carried out as per approved quality plan and all necessary documents shall be provided for review,verification and clearanace for further processing. This inspection call shall be given well in advance (atleast 2 weeks before) to TPI/Bidder's own inspection agency to avoid delay in the manufacturing processes.		
6	Inspection before despatch for domestic supplier : Inspection before despatch at supplier's works shall be carried out by BHEL/BHEL appointed Inspection agency. Inspection shall be done as per approved Quality plan/ Technical specification/ Approved Drawing/ Approved Data sheet .		

Sl.No	BHEL / Customer Requirement	##Specific confirmations by the manufacture
7	<p>Inspection at Foreign Source/Supplier: (a) As in sl no: 3. shall be ensured without fail, (b) No materail / items shall be despatched without getting the written communication from BHEL / Customer inspection carried out by BHEL/BHEL apointed Third Party Inspection Agency (TPIA) / Customer/Customer Apointed Inspection Agency/Consulatnat. This is applicable for all Stage inspection and Final Inspection identified as "W" - Witness or "CHP" - Customer Hold Point as per customer approved Quality Plan/ Technical specification / Approved Drawing/ Approved Data sheet / Scheme / PID / PFD / SLD (Process Instrumentaion Diagram / Process Flow Diagram / Single Line Diagram) etc (As applicable). (c) Inspection before despatch at supplier's works shall be carried out by bidder appointed inspection agencies having international presence at vendors and or vendor's sub vendor works. Inspection shall be done as per approved Quality plan/ Technical specification/ Approved Drawing/ Approved Data sheet by TPIA mentioned in Sl no: 03 at supplier's cost.</p>	
8	<p>Painting shall be done strictly as per BHEL/Customer approved painting schedule / scheme only. Paint Thickness / Paint shade shall be ensured as per BHEL / Customer approved painting schedule / specification / data sheet etc. No deviation is acceptable unless otherwise accepted by BHEL/Customer in writing. Any conflict if any among BHEL / Customer approved painting schedule / Spec / data sheet etc shall be brought to the notice to BHEL well in advance before proceding including the BOI being procured for assy / skid like motors etc</p>	
9	<p>Specific conformation for document package in the event of an order (2 Hard copies & soft copy in PDF file) is to be given containing the following with proper linkages (i) Index Sheet, (ii) MQP/RQP/Endorsement Sheet (As applicable), (iii) TCs identified by BHEL/ Customer for record for "CHP" / "W" and Verification portion ("V") as given in approved QP, (iv) Final inspection report + TC including Chemical + Mechnaical + HT + NDT etc, (v) Third party Inspection report + TC, (vi) Customer CHP/ MDCC, (vii) Type test / Performance Test reports conducted, (viii) Type test / Performance Test approval/ clearance obtained from BHEL/Customer, (ix) BOM with As Build Drgs with actual make / rating used with BHEL/customer approved drawings.</p>	
10	<p>Packing / Seaworthy Packing shall be as per BHEL Packing schedule / approved drg / sketch. This shall be ensured to take care tarnsit / handling / transhipment in Road / Sea / Air. Photographs are to be submitted for BHEL review before despatching the material as per contract conditions.</p>	
10	<p>Packing shall be as per BHEL Packing schedule / approved drg / sketch. This shall be ensured to take care tarnsit / handling / transhipment in Road / Sea / Air. Photographs are to be submitted for BHEL review before despatching the material as per contract conditions.</p>	
11	<p>Outsourcing of test facilities: Bidder shall ensure all the testing facilities in house. However If any of the test facilities are not available with successful bidder, then bidder shall ensure the same at NABL accreadted third party lab / Govt / Govt Lab for major testing such as NDT, Electrical & Mechanical testing.</p>	
12	<p>Important Note: No deviation on the above requirement 01 to 11 is acceptable w.r.t Quality Requirement and those offers not meeting these specific customer requirement is liable for rejection and hence the bidder shall submit all the required documentary evidances in the offer itself.</p>	
13	<p>## Necessorily to be filled up by the bidder at the time of offer itself otherwise the offer may not be considered w.r.t Quality Requirement being customer specific requirement.</p>	

Tender Inviting Authority: Dy Manager/PURCHASE

Name of Work: SUPPLY OF PTFE Gasket to BHEL site NTPC Mauda

Contract No: 3820046E DATED 11-04-2022

Name of the Bidder/ Bidding Firm / Company :	
--	--

PRICE SCHEDULE

(This BOQ template must not be modified/replaced by the bidder and the same should be uploaded after filling the relevant columns, else the bidder is liable to be rejected for this tender. Bidders are allowed to enter the Bidder Name and Values only)

NUMBER #	TEXT #	TEXT #	NUMBER #	TEXT #	NUMBER #	NUMBER	NUMBER #	NUMBER #	TEXT #	
Sl. No.	Item Description	Item Code / Make	Quantity	Units	BASIC RATE PER UNIT(Inclusive of packing & forwarding, freight and insurance) to be entered by the Bidder in INR Rs. P	GST on Basic price to be entered by the Bidder in percentage	TOTAL AMOUNT Without Taxes in Rs. P	TOTAL AMOUNT With Taxes in Rs. P	TOTAL AMOUNT In Words	
1	2	3	4	5	13	14	53	54	55	
0	PTFE Gaskets As below listed, suitable for fluid temperatures range 30 deg C to 150 deg C, in confirmation with Quality plan and relevant standard as per drawing.									
1	NB 250 PTFE Gasket as per drg item sl 7 of drg 4-FW-000-01471	RFW21651 0001	6	Nos			0.00	0.00	INR Zero Only	
Total in Figures								0.00	0.00	INR Zero Only
Quoted Rate in Words		INR Zero Only								

***(To be submitted In the company letter head by supplier)**

Form – 2

I/we are bidder from _____ (Address with country). We do not belong to any of the below category mentioned.

1. Any of entity/office/workshop of your organisation/incorporation, established in a country sharing land border with India, If yes, provide the full address of all such locations.
2. Any of subsidiary of your organisation/incorporation, established in a country sharing land border with India, If yes, provide the full address of all such locations.
3. Any of entity/office/workshop of your organisation/incorporation, controlled in a country sharing land border with India, If yes, provide the full address of all such locations.
4. Any of entity whose beneficial owner is situated in a country sharing land border with India, If yes, provide the full name, address of all such locations.
5. Any Indian Agent available, If so, Provide details of address and contacts.
6. Any employee/directors who is/are citizen of country sharing land border with India, If yes, provide the full name, employee code and address of all such locations.
7. Any of consortium/joint venture of your organisation/incorporation, established in a country sharing land border with India, If yes, provide the full address of all such locations.

Meaning of beneficial owner

- 1) In case of a company or limited liability partnership, beneficial owner is the natural person, who, whether acting alone or together, or through one or more judicial person, has a controlling ownership interest or who exercises control through other means.

Explanation

- a) Controlling ownership interest means ownership of or entitlement to more than twenty-five percent of shares or capital or profits of the company.
 - b) “control” shall include the right to appoint majority of the directors or to control the management rights or shareholder’s agreement or voting agreement.
- 2) In case or a partnership firm the beneficial owner is the natural person (s) who whether acting alone or together or through one or more judicial person, has ownership of the entitlement to more than fifteen percent of capital or profits of the partnership.
 - 3) In case of an unincorporated association or body of individuals, the beneficial owner is the natural person(s), who, whether acting alone or together or through one or more judicial person, has ownership of the entitlement to more than fifteen percent of the property or capital or [profits of such association or body of individual.
 - 4) Where no natural person is identified under (1) or (2) or (3) above, the beneficial owner is the relevant natural person who holds the position of senior managing official.
 - 5) In case of a trust, the identification of beneficial owner (s) shall include identification of the author of the trust, the trustee, the beneficiaries with fifteen percent or more interest in the trust and any other natural person exercising ultimate effective control over the trust and any other

***(To be submitted In the company letter head by supplier)**

natural person exercising the ultimate effective control over the trust through a chain of control of ownership.

- 6) An agent is a person employed to do any act for another, or to represent another in dealing with third person.

We have read the clause regarding restriction on procurement from a bidder of a country which shares a land border with India, we hereby declare that we do not belongs to any such country and are eligible to be considered.

In case, any of information is found to be false, even after bid acceptance, immediate termination may happen and action will be taken as per law.

Format is being filled without altering any of the clause mentioned in the given format**

Dated: _____

Authorised Sign and stamp_____

*(To be submitted In the company letter head by supplier)

Form - 1

Subject: Public Procurement (Preference to Make In india)

References:

- 1.P-45021/2/2017-B.E-II dated. 15th June-2017,
- 2.P-45021/2/2017-PP(BE-II) dated. 28th May-2018 ,
- 3.P-45021/2/2017-PP(BE-II) dated. 29th May-2019.
- 4.P-45021/2/2017-PP(BE-II) dated. 4th June-2020

We hereby declare with reference to above subject and references that M/s --
------(Tick whichever is applicable as below)

"Class-I local supplier" meeting the requirement of minimum local content equal to 50%(fifty percent) or more defined in the above government notification for the goods and services (or)

"Class-II local Supplier" meeting the requirement of local content 20% to less than 50%(fifty percent) defined in the above government notification for the goods and services

Please mention the details against the following:

Enquiry no:----- dated. -----

Type of Supplier (Class-I/Class-II)

Product:-----

Project:.....

Details of location at which local value addition will be made is as follows:

We also understand that the false declarations will be in breach of the code of Integrity under rule 175(1)(i)(h) of the General financial rules for which a bidder or its successors can be debarred for up to two years as per Rule 151(iii) of the General Financial Rules along with such other actions as may be permissible under law.

Authorized Signature M/s _____

(Signature and seal)

Place:.....

Date:.....

From.

M/s _____

Address: _____



ANNEXURE –B
GENERAL TERMS & CONDITIONS
(FOR GUIDANCE TO THE SUPPLIERS)

A] Submission of Offer

a) Invitation for bid

Tenders are invited through electronic mode from eligible suppliers in case of open tenders and from suppliers to whom the enquiry is addressed in case of Limited / Single Tender.

The offers shall be posted into the system before the date and time specified in the tender.

The offer shall be sent on single part / two part / three part basis as specified in the main tender document.

Bids shall be submitted through e-Procurement portal, <https://bhel.abcprocure.com> of M/s e-Procurement Technologies, Ahmedabad who is our solution provider.

b) Hardware and Software requirements for participating in e-tender

Requirement for participating in e-Procurement is as under:

- i) A Computer with internet connectivity (Internet Explorer 9.0 (32.bit Browser only) & above)
- ii) Digital Signature Certificate (Class 3- SHA2-2048 BIT- with both Signing and Encryption component separately).
- iii) JAVA (Version 1.8 Update 45).

iv) Steps for Hardware and software configuration is detailed at <https://bhel.abcprocure.com/EPROC/> under title “Minimum system requirements and Settings Document for BHEL User and Bidders”. *c) Instructions for Registered Suppliers*

For all types of tenders (Single / Limited / Open) an automated email alert regarding issue of the Tender will be sent by the e-procurement portal to all Suppliers registered with BHEL, Ranipet for the item/s for which the tender is issued.

In case of open tenders, Registered suppliers with registered DSC will have to login with their user id/password & DSC and search for the Open Tender. To participate in event and to submit bid, a bidder needs to agree the terms and conditions.

Registered suppliers without DSC will have get their profiles approved by mapping DSC after login.

To know the procedure for obtaining Digital Signature Certificate (DSC), suppliers who are not having the DSC are advised to visit our website www.bhel.com →Tender Notifications →Sample Checklist. *d) Instructions for new suppliers wishing to bid against open tenders*

New, unregistered suppliers wanting to bid against open tender/s will have to first register themselves in <https://bhel.abcprocure.com> as new supplier by clicking the “Register” button.

After entering the Income Tax Permanent Account Number (PAN) details and pressing “Enter”, they have to select the respective BHEL Unit for which they want to participate in the Open Tender and also fill up other relevant Company information as a one-time activity. On successful registration, your profile will be approved by the authorized officer and you can login to portal and can participate in the procurement event.



To participate in a tender, you need to login to the portal. You must be an approved registered user. If you are not a registered user, you can register yourself by clicking upon the “Register” link. You need to have a valid vendor code and password to login to the portal. Enter your Vendor code, password and click on Login button after Login, you need to select your digital signing and encryption certificates certificate. The DSC will be approved by M/s e-Procurement Technologies/ Authorised officer of BHEL.

As required by the tender, the necessary documents have to be filled-in online, in the provided template. Additional documents required are to be scanned and uploaded as .pdf file. Suppliers are advised to take note that the maximum space that is provided for uploading the documents that are to be attached is 300 MB. However the size of an individual document cannot exceed 10 MB. For any clarification on submission of offer on line, attention of the Supplier/s is invited to our document “Bidder Manual for BHEL Bidders” hosted in the home-page of the e-procurement portal. During normal business hours, helpline maintained by the service provider M/s e-Procurement Technologies is available for clarifying any doubts of supplier/s. The helpline numbers are +91-79-40270599/508/560/590/513 and email id is: Bhel.Support@abcProcure.com . Bidder can also refer to “Bidder Manual for BHEL Bidders” hosted in the home-page of the e-procurement portal <https://bhel.abcprocure.com>.

Typical documents that would be required as part of tender submission would be a)

Complete technical Offer with details, catalogues, as applicable.

b) **Un-priced bid** (i.e. Bid without the Price) as per given format, if any.

c) **Filled-in BHEL’s Standard Terms & Conditions** as per Annexure enclosed with the Tender Document,

d) **Deviation summary** submitted in two parts – giving the summary of technical deviations separately and the commercial deviations separately, if any and

e) **Supporting documents** to substantiate equivalent material specifications / sections, where quoted for.

f) Where asked for, **Client list** with their full address including detail of contact person with phone no., fax no. & e-mail ID (if any) to whom the same / similar items are supplied in the past two years. The date of supply may also be indicated, against each client.

g) Suppliers can also upload their credentials by way of submission of Performance certificate/s issued by their customer/s detailing the quantity supplied and specification along with the un-priced PO copies and proof of supply along with the offer.

Technical acceptance of offer by BHEL shall be based on the evaluation of offer and the submitted documents.

h) **Bidders who are not already registered with BHEL Ranipet** are requested to submit the Supplier Registration Form (SRF) online (<http://supplier.bhel.in/>) for evaluating and registering as an approved vendor. The Supplier Development Cell (SDC) of BHEL, Ranipet would process the SRF for evaluation / registering the Supplier. Don’t send hardcopies of SRF to BHEL-Ranipet, **only** online submission is accepted. This registration process is a separate / parallel activity and do not mix-up with submission offers.



Note

- (i) The materials offered, shall conform to the specification and scope attached in the tender.
- (ii) In case the offered materials are not conforming to the Enquiry material Specification, such offers would not be considered for evaluation and would be rejected.

Where equivalent specifications are offered, considering such offers will be at the sole discretion of BHEL. Wherever alternative standards / specifications are offered by Bidder, the Bidder shall provide sufficient documentary evidence to ensure equivalence to the designated standards / specifications, failing which the offer would be considered as not technically acceptable and hence shall stand rejected.

- (iii) All taxes and duties payable as extra to the quoted price should be specifically stated in offers (as appearing in the online template).

Offer/s from within India shall be submitted along with the applicable HS Number and the applicable Goods & services Tax (GST) for each quoted item, failing which the purchaser will not be liable for payment of such taxes and duties. Our GST No: **33AAACB4146P2ZL**.

- (iv) The un-priced bid shall be used to indicate relevant commercial terms such as scope of freight and insurance, applicability of duties and taxes etc. All Commercial terms are to be indicated clearly in the offer.

- (vi) No changes shall be entertained once the bid is opened unless otherwise specifically agreed to in writing by BHEL.

- (vii) Money values other than for those items appearing in the un-priced bid template shall not be indicated anywhere in the un-priced bid.

- (viii) Time required for inspection (at Supplier's works), should be clearly given in terms of numbers of working days.

- (x) **Offers sent by FAX / E-mail:** would not be entertained.

- (xi) Bid should be free from correction, overwriting, using corrective fluid, etc. Any interlineation, cutting, erasure or overwriting shall be valid only if they are attested under full signature(s) of person(s) signing the bid else bid shall be liable for rejection.

- (xii) Registration process for items required by BHEL is always open at <https://supplier.bhel.in>. Prospective suppliers (including MSEs & owned by SCs/STs) may visit this site and apply for registration in the respective Unit.

Price Bid in conformance with the specification and terms as given in the Un-Priced bid document.

Caution on submission of price bids thru EPS:

The suppliers are severely cautioned to note that the price bid document accepts the price in figures only. It does not allow the supplier to write the value by words. Therefore all care shall be exercised by the supplier while filling in the figures. Once the price bid is opened no option is available for the supplier to retract the offer under any grounds. If a supplier, for any reason whatsoever approaches BHEL with a request for change in the price, it would be treated as going back on the offer submitted. In such cases, action would be initiated by BHEL for suspending further business dealings with such suppliers as per policy of BHEL which prevails at that point of time.



Foreign / Overseas suppliers are hereby informed that offers with differential currencies are not permitted for a given tender document.

Note

- (i) The price break-up should be in line with technical specification / scope of the tender. (Cost of material, packing charges, forwarding charges, freight and insurance charges shall be shown appropriately, as applicable).
- (ii) Unless otherwise specified as a part of the tender condition, No Price Variation Clause will be entertained and No advance payment will be made by BHEL.
- (iii) In case, there is a discrepancy in the term quoted in techno-commercial bid and price bid, the term as per the techno-commercial bid (Part I) shall hold good and the commercial term quoted in the Price Bid (Part II) shall not be considered.
- (iv) In their own interest, all Tenderers are advised to double check their prices, applicable duties and taxes.
- (v) The quotation should be valid at least for a period of 90 days from the tender opening date.
- (vi) Indian bidders should submit the prices in Indian Rupees only.
- (vii) Foreign bidders may submit their bid in foreign currency. The currency for quoting shall be selected from the drop-down menu provided.
- (x) Indian Suppliers shall quote on FOR Destination basis only. Destination is BHEL, Ranipet Stores or BHEL Project Site as specified in the tender requirement. Foreign Suppliers shall quote on CFR Chennai Seaport Delivery and Insurance will be in BHEL's scope. No other delivery terms shall be acceptable. Shipment shall be arranged by the Seller on *Liner in / Liner out basis*. As per Government of India guidelines, BHEL Ranipet being a Government of India Undertaking the Bill of Lading shall be made with the Shipper as "Government of India". This shall be specifically confirmed by the Bidder.
- (xi) Where the cargo is containerized, Container washing charges, stuffing charges and / or any other such charges would be to the account of the supplier, where the containers are to be stuffed at the works of the supplier.

B] Opening of Offers

- a) **Tenders can be submitted up to 1400 Hours on tender opening due date. Part I will be opened on the same day at 1430 Hours. Results of the tender opening will be available for viewing for upto 7 days from the date of opening.**
- b) **Requests by Bidders for extension of due date will not be entertained by BHEL.**
- c) Price Bid opening will be done through e-mode / Reverse Auction method (English method) which will be decided after techno-commercial bid evaluation is completed. All tenderers would have to specifically give their acceptance for this in their bid/s.

Note

- (i) Bids including all enclosures and supporting documents like catalogues, pamphlets, etc., shall be provided in ENGLISH language only.



(ii) In exceptional circumstances, at its option, BHEL may consider extending the due date/s for the tender openings for reasons such as (but not limited to) paucity of offers etc. However, sufficient notice would be given by BHEL for such extension.

(iii) Deviations shall be summarized and provided in a “Deviation Statement”, listing the points and the deviation against each point.

(iv) BHEL reserves the right to increase or decrease the tendered quantity and to order on more than one vendor at the lowest acceptable price to BHEL. In ordering on more than one source, the ratio of quantity split will be as specified in the tender terms.

If not explicitly specified, BHEL reserves the right to split the quantity of the enquiry as follows: 70% quantity being ordered on the original lowest bidder (L1) and balance 30% on the next higher bidder/s excluding H1, who accepts the L1 price. However, the final decision to split the order rests with BHEL only.

In the event that the other than L1 suppliers do not accept the L1 price, then the balance will be reverted to the original L1 and the original L1 shall be bound to accept the balance of the enquiry quantity kept reserved for order splitting. This decision would be given by BHEL within 60 days of the price bid opening.

Notwithstanding the quantum of split that may be indicated in the main body of the enquiry, bidders are advised to note that the splitting of the orders will be decided by BHEL after the evaluation of the techno-commercial and price bids.

(v) Offers for part quantities on item level basis are not acceptable to BHEL. While tenderers can quote for some or all the tendered items, no supplier shall quote for partial quantity of any given enquiry item. Such partial offer would not be considered in the enquiry for that item. Suppliers are to note that the evaluation unless otherwise specified will be on item level and not for the tendered items as a whole.

C] Evaluation of Offers

a) The price bids including the impact price (if any) of the technically acceptable offers alone shall be opened.

b) Offers with pre-conditions (like conditional discounts) for price are liable to be not considered / rejected. For evaluation such conditions would be removed and only the base offer would be considered for evaluation and comparison.

d) In the event of any change in scope / quantity arising out of the discussions, offerers would be given a chance to submit their revised offer / Impact bids. The option for the revised offer / impact offer will be triggered by BHEL. The Supplier then will have the facility to feed-in the revised price / impact price as per the provision given by BHEL. The impact price can be positive or negative (or nil). The impact price option shall contain only the price addition / deletion for such change in the scope / quantities, over and above the original scope and price quoted. The original price quoted would remain unchanged. The total price would then be computed by the arithmetic addition of the original price and the impact price. Where BHEL gives the option of submitting the revised offer, the impact would be computed as the arithmetic difference of the revised price and the original price.



- e) For evaluating the overseas offers, CFR Chennai Sea Port price quoted will be taken into account. The cost to BHEL will be arrived at by loading the applicable customs duty project wise, insurance charges, inland transportation charges to BHEL stores and LC charges etc., f) Deleted.
- g) BHEL reserves the right to reject without assigning any reasons / load any offer with factors other than already specified for such offers having deviations to BHEL Specifications, Standard Terms & Conditions at its discretion. The decision of BHEL in this regard shall be final.
- h) BHEL reserves the right to reject an offer due to unsatisfactory performance during tender finalisation / execution of a contract at any of BHEL projects / units in the past or if unsatisfactory performance report is received from the party/s referenced by the supplier at any time during tender finalisation.
- i) BHEL reserves the right to operate Purchase / Price preference to Government of India Undertakings, which shall be given as per the guidelines of Government of India given from time to time and / or relax the Terms and Conditions of the tender.
- j) For the purpose of comparing prices, tender prices shall be converted to Indian rupees and the conversion shall be made by using the TT Selling rate of State Bank of India (SBI) prevailing on the date of opening of Techno-Commercial / Unpriced bids. If the relevant day happens to be a bank holiday, then the forex rate as on the previous bank (SBI) working day shall be taken. This exchange rate will be followed till placement of order. Tenderers may please note that even if an impact price is taken as in (d) for purpose of price evaluation and arriving at the rank; the exchange rate will be taken as explained above.
- k) Unless otherwise specified, evaluation will be on individual line item basis only and ordering will be on respective L1 vendors.
- l) BHEL reserves the right to conduct negotiations on the “Price” and “Other Commercial Terms and Conditions” with the lowest ranked offerer at any time after the bid opening but before the release of the Purchase Order and If so required by BHEL, Supplier may have to share their costing sheet with BHEL.
- m) Bidders are required to confirm in writing in their techno-commercial document that other than themselves (the bidder) none of its group companies, concerns or affiliates etc., are participating in the tender either directly or indirectly or through any other agency under the same proprietor / common partner(s)/ common Directors. If during the evaluation of the bids it is found that the bidder has submitted the offer in violation of this condition then all the offers received from the group companies would stand rejected. If such relationship is found at a later date where the Purchase Order has been issued, then BHEL would cancel the Purchase Order and initiate suitable action/s under the contract/s including but not limited to invoking the Risk Purchase clause of the order and other applicable legal provisions / guidelines of BHEL including guidelines on suspension of business dealings. (Please see clause L sub-clause c).
- n) For this procurement, Public Procurement (Preference to Make in India), Order 2017 dated 15.06.2017, 28.05.2018, 29.05.2019 & 04.06.2020 and subsequent Orders issued by the respective Nodal Ministry shall be applicable even if issued after issue of this NIT but before finalization of contract/ PO/ WO against this NIT.

In the event of any Nodal Ministry prescribing higher or lower percentage of purchase preference and/ or local content in respect of this procurement, same shall be applicable.”



Preference to Make in India including counter offering will be as per the Public Procurement (Preference to Make in India), Order 2017 available in the following links <https://dipp.gov.in/public-procurements>

http://dipp.nic.in/sites/default/files/publicProcurement_MakeinIndia_15June2017.pdf

http://dipp.nic.in/sites/default/files/Revised-PPP-MII-Order-2017_28052018.pdf

https://dipp.gov.in/sites/default/files/PPP-MII%20Order%20dt%2029th%20May%2019_0.pdf

<https://dipp.gov.in/sites/default/files/PPP%20MII%20Order%20dated%204th%20June%202020.pdf>

D] Execution of the Order

a) BHEL will have the option to pre-inspect the materials at Supplier's works by BHEL's own inspector or by third party agency appointed by BHEL or BHEL's end customer/s. The mere act of the pre-dispatch inspection (PDI) does not absolve the Supplier from giving the specifications as agreed upon in the Purchase Order. In the case of inspection being carried out by a third party inspector (TPI) as per the extant practice, the TPI would forward the Inspection Report (IR) along with Test Certificates and other related documents to the Quality Assurance (QA) Department of BHEL. The QA department after scrutinising the report/s submitted by the TPI would issue the Material Dispatch Clearance Certificate (MDCC). Suppliers are hereby informed that materials should be dispatched only after getting the MDCC, failing which the materials may be rejected on receipt at BHEL Stores.

b) In the case of overseas suppliers Inspection call for carrying out the inspection shall be given 30 days before the scheduled contract delivery date. The Inspection date/s given by the Supplier shall be on firm basis. For local Suppliers the Notice period of Inspection shall be 10 working days.

c) Deviations, if any pointed out by the visiting Inspection team of BHEL shall be corrected and the items as per specification shall be dispatched on or before the contract delivery date after getting the MDCC.

d) The final inspection for acceptance will, however be carried out at BHEL's works at Ranipet.

e) The contract delivery date is the date of receipt at BHEL Stores for suppliers in India, applicable in the case of FOR Destination Contracts.

For ex-works contracts or FOR dispatching station indigenous contracts, the date of the Lorry way bill issued by the authorised transport carriers of BHEL / Railway Receipt / Courier Way bill / Airway bill or any such dispatch documents of carriage approved by BHEL would be considered as the Contract Delivery Date. In the case of CFR contracts with overseas suppliers, the B/L date shall be taken as the Contract Delivery Date

f) Travel & other local stay cost for the Inspectors sent by BHEL will be to BHEL account, but other Inspection Charges, if any shall be to the account of the Seller only.

g) The supplier shall arrange for packing suitably in all respects for normal transport by sea / rail / road and Materials shall be suitably protected against effect of tropical salt laden atmosphere in the event of shipment being delayed at ports / store yards and as per BHEL TDC.



h) Foreign suppliers shall dispatch on CFR agreed Sea-Port basis, according to the contract conditions. Indian suppliers shall dispatch on free delivery (door-delivery) at BHEL stores basis only. Unloading the materials at BHEL Stores would be to the account of BHEL only.

i) In the event of any short supply, it shall be the responsibility of the supplier to deliver such short supplied/ missing items on Free-of-Cost basis at BHEL stores, including customs clearances at Indian Ports in the case of foreign suppliers.

k) Terms of payment:

k.1) For Indigenous Suppliers: Unless otherwise agreed to by BHEL, the standard payment terms of BHEL shall be: For non-MSE suppliers 100% payment made directly through EFT within 90 days from the date of receipt and acceptance of materials at BHEL Stores, Ranipet or 90 days from the date of acknowledgement of receipt of materials at destination specified. If any supplier asks for payment terms other than the above specified, then suitable loading on cost will be considered. **Loading of any deviation in the payment terms**

w.r.t tender terms will be “Base rate of State Bank of India (SBI) (as applicable on the date of bid opening: Techno-commercial bid opening in case of two part bids) + 6%, will be considered for loading for the periods of relaxation sought by bidders.

k.2) For MSE vendors (under Micro & Small category alone) 100% payment will be made within 45 days from the date of receipt and acceptance of materials at BHEL Stores, Ranipet or 45 days from the date of acknowledgement of receipt of materials at destination specified. Vendors to get themselves registered in Udyam registration Portal. The existing Micro & Small vendors are to submit copy of CA certificate along with Udyog Adhar Registration Certificate.

l) NOTE:

Where the destination specified is other than BHEL Stores Ranipet, for claiming payment, Supplier has to submit proof of receipt of the materials at the destination by furnishing a copy of the acknowledged despatch document (LR/RR/Courier receipt etc.) .

If the Bidder is bidding for the first time and wants to be considered as an MSE then, the Bidder shall submit document evidencing that they are an MSE along with a certificate from a Chartered Accountant certifying the status of their Unit / Works clearly specifying the address of the works which is to be considered as MSE and send the same to BHEL, Ranipet either before the tender opening date or upload it as a part of the tender document in the e-procurement portal. Where the document is submitted electronically a hard copy shall invariably be sent within a reasonable period (not exceeding 30 days) from the bid opening date for the purpose of BHEL's records. If the hard copy is not received within this specified time, then the supplier would be treated as a non-MSE. BHEL will not be responsible for any postal / courier / delivery delays.

For approved vendors the status as on the date of the bid opening as available with BHEL Ranipet's records shall be used for reckoning the status of the Bidder as an MSE or otherwise.

Offer/s received without these documents will be treated as non-MSE and order finalization will be done based on this premise. Documents submitted after Bid-opening will not be considered in this tender. This provision for MSE will apply subject to the condition that the participating MSE meets the tender requirements.



For approved suppliers, in case of any change in the MSE status, it shall be the responsibility of the Bidder to notify the change as a part of the Bid document. If at a later date it comes to the knowledge of BHEL, Ranipet that the change in the status has not been intimated by the Bidder and the order is obtained under the premise of an MSE then BHEL would cancel the pending order against this tender and take necessary steps for suspension of the business dealing with the Bidder as per the procurement policy of BHEL. Similarly if a supplier claims MSE status after the Part I bid opening, then the same would not be considered in the tender.

In case after the bid opening it is seen that no MSE has become L1, then depending on the nature of the item, if it is not possible to split the tendered items / quantities on account of reasons like customer contract requirements of supplying one make for a given project or technical reasons like the tendered item being a system etc. then BHEL would not counter offer the L1 prices even though there may be MSE bidders within the +15% band of L1.

Other concessions for MSEs / Reserved sectors (Also for women owned MSEs and MSEs owned by SC/STs)

In addition to the concessions specified above, MSE suppliers will be eligible for such other concessions as per the MSME Act 2006 and any other benefits / concessions that may be announced by the Government of India from time to time.. However, such concessions as applicable at the time of tender opening alone will be applicable. Any concessions advised after tender opening will not be considered for the current tender.

Items that are reserved for MSE and for any other items for which reservations for Indian manufacturers are notified by the Govt. Of India, such concessions as prevailing on the date of tender opening shall apply as a part of this tender conditions. ii) Foreign Suppliers “100% thru’ irrevocable & unconfirmed LC at sight within 3 weeks from the PO date through any one of our Bankers listed elsewhere in the tender conditions for 100% value (less Agency

Commission, if any) valid up to the PO delivery period and 15 days thereafter for negotiation. All bank charges in India to BHEL's account and all other charges outside India to Supplier's account. **BHEL would load the price of foreign suppliers in order to bring them on common platform as per Indigenous Suppliers on the account of differential payment terms to Indigenous Suppliers. Loading of payment terms will be “Base rate of State Bank of India (SBI) (as applicable on the date of bid opening: Techno-commercial bid opening in case of two part bids) + 6%, will be considered for loading for the periods of relaxation compared to indigenous suppliers i.e. 90 days.**

m) Any incidence of tax like Income tax, Goods & Services Tax (GST) and Withholding any other similar tax / duties /levies imposed by the Government of India, or the State Government, where the BHEL Unit is located, deductible at Source, during the tenure of the Order shall be deducted by BHEL and necessary certification of the deduction (Tax deduction at Source) would be given. This is subject to the supplier fulfilling the necessary documentation as specified by the Government of India. (e.g. Tax Residency Certificate, PAN Number etc.)

n) The Guarantee period shall start from the “Date of receipt and acceptance of the materials at BHEL Stores.”

E] Liquidated Damages Clause:

BHEL will levy penalty as Liquidated Damages (LD), for delay in delivery. The damages shall be at the rate of ½% per week or part thereof subject to a maximum of 10% PLUS applicable Goods & Services Tax



(GST). The contract delivery date for purpose of L.D is the date of receipt at BHEL Stores for suppliers in India for F.O.R. Destination Contract and the date of dispatch clearance given by BHEL for overseas suppliers. For ex-works or F.O.R dispatching station contracts, the date of the dispatch document will be reckoned as the date of delivery for computing the LD. Supplier shall deduct the applicable LD from the first payment when raising the claim for the same. The applicable LD if any would be communicated by BHEL along with the dispatch clearance. It is taken by BHEL that Foreign Suppliers have confirmed their acceptance to BHEL for opening the LC for value which is the value of the order reduced by the applicable LD. The LD would apply on the undelivered portion only. In case of reasons attributable to BHEL for the delay in delivery (for e.g. delay in arranging the pre-inspection) then the delivery time would be reset to the extent of the time delay attributable to BHEL, with waiver of the LD. Delivery being the essence of BHEL's contract requirements, unless otherwise specified the LD would apply on the undelivered portion of the contracted items. **In the event that a Supplier does not accept the LD condition above, the offer would be loaded to the extent of the shortfall with respect to upper limit specified above.**

F) Miscellaneous

i) Role of Principals and Agents:

BHEL will deal directly with indigenous manufacturers only.

BHEL strongly discourages the engagement of Agents in India by foreign principals, to deal with BHEL, in BHEL's tenders.

BHEL will not enter into any correspondence with an Indian Agent.

The Indian Agent will not be extended the privilege given to the principals, such as that of attending the tender openings, attending technical discussions, commercial discussions or price negotiations and such like.

In case, in spite of the above, a foreign principal insists on engaging an Indian Agent, It is made clear by BHEL that:

It is the sole responsibility of the foreign principal to ensure the Agent does not represent any other foreign principal in a given tender.

An undertaking to this effect shall be given by the foreign principal that his / her Agent does not represent any other foreign principal in the tender. This document shall form a part of the techno-commercial offer.

A Principal shall authorise only one Agent to quote against each BHEL's tender. In the event a Principal authorises more than one agent to quote against a BHEL's tender, then all such offers will be rejected by BHEL in that tender. Principals are also advised to include BHEL's tender Number / Reference in their authorisation issued to the Agent.

If at any stage of the tender, BHEL finds that an Indian Agent has represented more than one foreign principal, all such offers of and all the foreign principals would be disqualified summarily in the tender inquiry.

BHEL will only give an intimation of notice of the disqualification. No correspondence would be entertained by BHEL, on their decision. Such decision of BHEL shall be irrevocable, firm and final and shall be binding on the tenderer.



BHEL, due to business reasons would ban, would have banned Indian agents from dealing with BHEL.

Any foreign principal who engages such a banned agent, or an employee of the banned agency, or any other person connected with the banned agency, at any time during the tender proceedings, would be disqualified from the tender proceedings. The decision of BHEL in this regard shall be final and be binding on the OEM.

Hence in their own interests, prospective tenderers may check with BHEL, the status of their proposed agent vis-à-vis BHEL.

In view of the requirement of BHEL, it is strongly suggested that in their own interest, foreign principals may desist from engaging any Indian agent and deal with BHEL directly and it is stressed that any Main producer proposing to deal with BHEL by engaging and through an Indian Agent does so at their own risk.

BHEL shall in no way be responsible for any consequences that may arise to the foreign principal on account of the antecedents / actions of their Indian Agent.

In the event of the foreign principal engaging an Indian Agent:

a) The Supplier shall furnish an authenticated copy of the Agency Agreement with his agent detailing the precise relationship between them and their mutual interest in the business along with techno commercial bid.

b) The Supplier shall furnish original authorization letter for the Indian Agent. The letter shall contain name, contact person, complete postal address including phone, fax and e-mail ID. It shall also spell out the type of services to be rendered by Indian Agent.

c) Indian Agent & Agency commission: An Indian Agent can represent only one Foreign Manufacturer against a particular Tender. The CFR price quoted by the foreign bidder shall include the agency commission. However, the agency commission component payable to their Indian Agents shall be shown separately in the Offer, either as a lump-sum or as a percentage of the quoted price. This will be paid by BHEL in Indian Rupees, on satisfactory receipt & acceptance of the materials. For calculation of Rupee equivalent of Agency Commission, exchange rate as prevailing on the date of Purchase Order will be taken and

d) For all discussions, technical clarification and negotiations etc. only the principal would be authorized for interaction with BHEL. The Agent shall not be a party to the discussions / negotiations and would not be normally allowed to participate.

ii) Terms & Conditions of Letter of Credit (L/C) for overseas suppliers (indicated for acceptance).

a) Unconfirmed irrevocable Letter of Credit at Sight only will be opened by BHEL. Confirmation of L/C is not preferred by BHEL. Also L.C will be opened in Lots in line with the staggered delivery.

b) All Bank charges out side India are to the Supplier's account and within India to BHEL's account.

c) In case of L/C extension caused by delays attributable to the Supplier, the L/C extension / commitment charges are to be borne by the Supplier.



iii) Other terms & conditions for letter of credit: - Documents for negotiation

- a) Signed Commercial invoice in quadruplicate, for a value not exceeding the draft amount, quoting the import Licence No and certifying goods evidencing shipment of the merchandise are as per Applicant's Purchase Order. The amount of invoice after deducting Indian Agent's commission, if any, should not exceed the Credit amount. (The Indian agent's commission, if any, is payable in India in Indian rupees only.)
- b) Certificate of Country of Origin, from the country of manufacture, issued by the Chamber of Commerce.
- c) One set of Original and two sets of Non-negotiable copies of 'signed', 'unmarked', 'clean on board' Ocean Bill of Lading, showing Shipper as "Government of India" Account M/s. Bharat Heavy Electrical Ltd, Unit: BHEL, Ranipet as consignee (The opening bank should not be notified as consignee), marked freight payable / prepaid at destination.
- d) Packing list in 4 copies in English, indicating Size wise Number of bundles / pieces shipped and weight.
- e) Certified copy of the fax / e-mail sent by the beneficiary to the applicant giving the following particulars of shipment, as the insurance is to be arranged by the Applicant in India: (a) Purchase Order Number & date; (b) Bill of Lading Number & date (c) Name of vessel; (d) Port of Loading; (e) Number of bundles / pieces and weight; (f) Invoice Number, date and value (g) Purchase Order item number's despatched. The cable / fax is to be sent within 2 working days of shipment.
- f) Beneficiary's certificate showing the relevant airmail / courier reference no. and date that the following clauses have been complied with:
 - 1] Beneficiary to forward by Registered Airmail / Courier one complete set of original documents and one set of non-negotiable documents within 3 working days of obtaining shipping documents to Regional Manager (ROD), Bharat Heavy Electricals Ltd, 6th Floor, EVR Periyar Bldg. No 690 (Old 474), Anna Salai, Nandanam, Chennai-600035. India. (Phone: +91-24330931, 24330253; e-mail: pbpwar@bhel.in)
 - 2] Beneficiary to courier at his cost 3 copies of complete set of non-negotiable documents to the Officer who released the Purchase Order.
 - 3] Declaration by the Supplier certifying that the contents in each case are not less than those entered in the invoices / packing list and that the invoicing for the supplies effected is strictly in accordance with agreed rates as stipulated in the Purchase Order.
 - 4] Declaration to the effect that all other documents as per purchase order has been couriered to the Purchase order releasing authority
 - 5) The carrying steamer should be seaworthy, less than 25 years of age and approved by Lloyds / Classification Societies / General Insurance Corporation of India from time to time and
 - 6) Copy of Dispatch Clearance / Instruction issued by BHEL.

iv) Documents to be sent directly to the Purchaser prior to shipment

- a) Manufacturer's Original Internal Inspection / Test certificate in triplicate.
- b) Manufacturer's Original Guarantee certificate as per Purchase Order. The material shall be guaranteed for a period of 12 months from the date of acceptance of the materials at BHEL stores or 18 months from the



date of dispatch whichever is earlier. The acceptance would be evidenced by the Stores Receipt Voucher (SRV) which will be raised by BHEL.

- c) Inspection / Test Certificate issued by BHEL / Inspection agency specified in the Purchase Order. In the event that Inspection prior to dispatch is not carried out by the Engineers of BHEL, the Inspection certificate of the third party so authorized by BHEL and
- d) Any other documentation as specified in the Purchase Order.

v) Conditions for transportation:

- a) All shipping documents shall show the Purchase Order Number & Date, Import Licence Number & Date, and Letter of Credit Number & Date. b) Transshipment is to be avoided.
- c) Loading on deck is not permitted. The transport document must not contain a provision that goods may be carried on deck.
- d) A transport document which is produced or appearing to have been produced by reprographic, automated or computerized systems or as carbon copy will be accepted as an original document provided that it is marked as original and is ink-signed.
- e) The transport document must contain all the conditions of carriage on the original document.
- f) The transport document must not indicate the place of destination as being different from the port of discharge.
- g) The transport document must not contain the indication 'intended' or similar qualification in relation to the vessel or other means of transport or port of loading or port of discharge.
- h) The transport document must be issued by the carrier or his agent and not by any freight forwarder.
- i) Transport documents bearing reference by stamp or otherwise, to costs additional to the freight charges are not acceptable.
- j) The Bills of Exchange must be dated and presentation of documents for negotiation must not be later than 15 days after the date of shipment and in any case not later than the expiry date of the Credit.
- l) Indian suppliers shall dispatch the materials on freight prepaid and on door-delivery basis (FOR Destination – Destination: BHEL Stores) and
- m) In the event there is a delay by the Supplier in negotiating / submitting the document, any demurrage / wharfage arising out of the same shall be to the account of the Supplier and shall be deducted from the final payment. Also, in such cases, the Supplier shall authorize the Steamer / Shipping agent / transporter to freely release the consignment to BHEL by providing a “Surrender Bill of Lading”. Over-seas Suppliers have to give a No-Objection Certificate to BHEL, authorizing BHEL to get the Delivery Order from the Steamer Agent without producing the Original Bill of Lading. This is required to ensure avoidance of incidence of demurrage at Chennai Sea-port that may arise in case of delayed presentation of documents by the Seller.



G) Reverse auction (RA) / on-line bidding on internet:

1. Decision to go for RA would be taken before floating of the tender. In case it is decided to go for RA, same shall be declared upfront in NIT by inserting the following clause:
“BHEL shall be resorting to Reverse Auction (RA) (Guidelines as available on www.bhel.com) for this tender. RA shall be conducted among all the techno-commercially qualified bidders. Price bids of all techno-commercially qualified bidders shall be opened and same shall be considered as initial bids of bidders in RA. In case any bidder(s) do(es) not participate in online Reverse Auction, their sealed envelope price bid along with applicable loading, if any, shall be considered for ranking.”
2. Those bidders who have given their acceptance to participate in Reverse Auction will have to necessarily submit ‘Process compliance form’ (to the designated service provider) as well as ‘Online sealed bid’ in the Reverse Auction. Non-submission of ‘Process compliance form’ or ‘Online sealed bid’ by the agreed bidder(s) will be considered as tampering of the tender process and will invite action by BHEL as per extant guidelines for “Suspension of Business Dealings with Suppliers/ Contractors (as available on www.bhel.com).”
3. The philosophy followed for reverse auction shall be English Reverse (No ties).
4. For the proposed reverse auction, technically and commercially acceptable bidders only shall be eligible to participate.
5. BHEL will engage the services of a service provider who will provide all necessary training and assistance before commencement of on line bidding on internet.
6. In case of reverse auction, BHEL will inform the bidders the details of Service Provider to enable them to contact & get trained.
7. Business rules like event date, time, bid decrement, extension etc. also will be communicated through service provider for compliance.
8. Bidders have to fax the Compliance form (annexure IV) before start of Reverse auction. Without this, the bidder will not be eligible to participate in the event.
9. Reverse auction will be conducted on scheduled date & time.

Note: Decision to go for RA or not will be on case to case basis and shall be informed in the NIT conditions .

1. At the end of Reverse Auction event, the lowest bidder value will be known on auction portal.
2. The lowest bidder has to fax/e-mail the duly signed and filled-in prescribed format for price breakup including that of line items, to the Service provider within two working days of Auction without fail.
3. Bidders are be required to read the “Terms and Conditions” section of the auctions site of Service provider, using the Login IDs and passwords given to them by the service provider before reverse auction event. Bidders should acquaint themselves of the „Business Rules of Reverse Auction“, which will be communicated before the Reverse Auction.
4. If the Bidder or any of his representatives are found to be involved in Price manipulation/ cartel formation of any kind, directly or indirectly by communicating with other bidders, action as per extant BHEL guidelines, shall be initiated by BHEL and the results of the RA scrapped/ aborted.



5. The Bidder shall not divulge either his Bids or any other exclusive details of BHEL to any other party.
 6. The bidders have to necessarily submit online sealed bid less than or equal to their envelope sealed price bid already submitted to BHEL along with their offer. The envelope sealed price bid of successful L1 bidder in RA, if conducted, would also be opened after the RA and the order will be placed on lower of the two bids (RA closing price & envelope sealed price) thus obtained. It is considered that the bidder having submitted their offer specifically agrees to this condition and undertakes to execute the contract on thus awarded rate/s.
 7. If it is found that L1 bidder has quoted higher in the online sealed bid in comparison to the envelope sealed bid for any item(s), the bidder will be issued a warning letter to this effect. However, if the same bidder again defaults on this count in any subsequent tender, it will be considered as fraud and will invite action by BHEL as per extant guidelines for suspension of business dealings with suppliers/ contractors (as available on www.bhel.com).”
 8. The calculation sheet e.g. excel sheet (which will help to arrive at ‘Total Cost to BHEL’) will be communicated to respective bidders of RA by BHEL. In line with the NIT terms, BHEL will provide the calculation sheet (e.g., EXCEL sheet) which will help to arrive at “Total Cost to BHEL” like Packing & forwarding charges, Taxes and Duties, Freight charges, Insurance, Goods & Services Tax (GST) and loading factors (for non-compliance to BHEL standard Commercial terms & conditions) for each of the bidder to enable them to fill-in the price and keep it ready for keying in during the Auction.]
 9. This calculation sheet will be finalized based on the evaluation criteria specified in the NIT.
 10. Suppliers are required to submit their best price bid in a separate sealed cover along with techno commercial bid. After evaluation of Techno-Commercial Bids:
 - a) In case BHEL decides not to conduct RA, the envelope (sealed electronic price bid) sealed price bids of all techno-commercially qualified bidders, along with price impact, if any, would be opened and processed as per extant the internal Purchase/ Works Policy as applicable to BHEL.
 - b) In case BHEL decides to conduct RA, business rules of RA will be sent to service provider. (See Annexure for Model General Business Rules of RA.)
 12. Generally the start price for the RA would be the lowest of
 - a) Lowest envelope (sealed electronic price bid) sealed bid and
 - b) Internal Estimate of BHEL
- Note: Wherever more than one lowest online sealed bids are identical and lower than the estimate, the start price, would be that price arrived by reducing the lowest online sealed bid by maximum of one decrement.*
21. The start price & bid decrement will be decided by RA committee of BHEL and the same would be communicated to the service provider, to start the bidding process.
 22. Only those bidders who have submitted the ‘Process compliance form’ duly signed and within the scheduled time would be eligible to participate further in RA process.



23. RA will be conducted if three or more bidders are techno- commercially qualified . In case of more than four techno commercially qualified bidders , H1 bidder (whose quote is highest in sealed envelope (eps) price bids) will not be allowed to participate in further RA process. However there will be no H1 removal in case , H1 bidder happens to be MSE or qualifying under PPP-MII , order 2017 irrespective of the number of bidder qualifying techno commercially.
24. In case multiple H1 bidders, all H1 bidders (excluding MSEs and bidders qualifying under PPP- M11 Order 2017) shall be removed provided three bidders remain in fray, else no H1 removal.
25. If the lowest sealed envelope (eps) price bids is the starting price, then the lowest bidder in sealed envelope (eps) price bids shall be shown as current L1 automatically by the system. System would have the provision to indicate this bid as current L1 for further bidding.
26. If the start price is lower than the lowest sealed envelope (eps) price bids , on acceptance of such start price by any bidder, this bid would be indicated as current L1 for further bidding.
27. In case of no further bidding, RA will be deemed to have been successful with current L1 bidder.
28. All bidders who had given their bids would be able to see their rank and L1 price and their ranking L1, L2 etc. on the screen. Once the RA is done, the ranking status would be based on the last quoted price irrespective of quote received in RA or sealed envelope (eps) price bid.
29. RA shall be treated as failed in the following scenarios:
- In cases where the start price is (a) estimate or (b) one decrement (maximum) lower than the lowest of the online sealed bids and no bidder accepts the start price.
 - In cases where the number of online sealed bids are less than three.
- Wherever, the evaluation is done for individual line items, RA shall be treated as failed only for those line item(s) for which any of the above a) or b) satisfies.
29. In cases of failure of RA, retendering shall be resorted to without conducting RA in the subsequent tender
30. Whenever the evaluation is done on total cost basis, after RA, prices of individual line items shall be reduced on pro-rata basis.
31. In case of splitting requirement, H1 bidder(s) who were removed from participation in RA may also be considered for counter offer if the pre-stated (NIT) number of suppliers do not accept the counter offer. However the principle of splitting to N-1 bidder shall be maintained in line with extant Purchase Policy / Work Policy
32. In case BHEL decides not to go for Reverse Auction for the tender enquiry, the Price bids and price impacts, if any, already submitted and available with BHEL would be opened as per BHEL's standard practice.
33. In case of enquiry through e-Procurement, the sealed electronic price bid (e-bid) would be treated as sealed envelope price bid.



Note: In order to bring more transparency and to address any queries of Bidders on Reverse Auction, an abridged version of BHEL's "Common Guidelines for conducting Reverse Auction (RA)" has been hosted in BHEL's web site www.bhel.com under the links "Supplier Registration Page" and "Tender Notification". All Bidders are requested to visit the link and familiarize themselves with BHEL's RA procedures and guidelines before submission of their bid/s. Submission of Bid shall mean that the Bidder has read and understood BHEL's RA procedures and the bid is in agreement with the same.

H] Force Majeure

If at any time during the currency of this contract, the performance in whole or in part, by either party of any obligations under this contract shall be prevented or delayed by reason, of any war, hostilities, acts of the public enemy, civil commotion, sabotage, fires, explosions, epidemics, quarantine, restrictions or acts of GOD (hereinafter referred to as events), then provided notice of happening of any such events is given by either party to other within ten days from the date of occurrence thereof, neither party shall reason of such events be entitled to terminate this contract nor shall either party have any such non performance and delay is resumed as soon as practicable after such events has come to an end or ceased to exist. If the performance in whole or part of any obligation under this contract is prevented or delayed by reason or any such event claims for extension of time shall be granted for period considered reasonable by the purchaser subject to prompt notification by the seller to the purchaser of the particulars of the events and supply to the purchaser if required of any supporting evidence. Any waiver of time in respect of partial installment shall not be deemed to be a waiver of time in respect of remaining deliveries.

I] Cancellation of Order:

In the event of non-performance of the contract by the Supplier, BHEL reserves the right to cancel the order with issue of a written notice. BHEL would provide a curing period of 30 days, for the Supplier to rectify the situation. If the Supplier fails to rectify the reason/s that led to the issue of cancellation notice by BHEL, then the cancellation order would be issued automatically by BHEL, without further recourse to the Seller. BHEL will not pay any cancellation charges or any other charges / damages to the Supplier, arising out such cancellation. In the event of the non-performance of the supply contract, by the Supplier, the rights of BHEL include, in addition to cancelling the order, to take alternate purchase action at the cost and risk of the supplier. The additional expenditure to be incurred by BHEL in such alternate purchase would be to the account of the supplier. (Risk Purchase). This remedy would be in addition to the invoking of the CEBG on grounds of failure of the Supplier in executing the Contract and any other legal remedies." BHEL reserves the right to initiate the alternate purchase action at the cost and risk of the erring supplier by issue of a simple notice of intention for the alternate purchase action duly sent by any electronic means and / or by a letter. The cancellation of the order would not be a pre-condition for initiation of the alternate purchase action.

J] Contract Execution Bank Guarantee:

To demonstrate the fidelity of the successful bidder, in executing the Contract, on receipt of the Letter of Intent / Purchase Order, the Supplier shall arrange to provide a contract execution bank guarantee (CEBG). The format of the CEBG is a part of this enquiry. The format may be downloaded and necessary stamping may be obtained from the Banker towards submission of the CEBG. The indigenous suppliers have to provide the CEBG from any one of the Nationalized Banks, listed in the annexure to these terms. Overseas suppliers can submit the CEBG from any of the reputed International / National Bankers. However the



CEBG is to be confirmed by any of the Bankers listed by us. In the event of failure by the Supplier to execute the contract either fully or partially, BHEL would encash the entire CEBG. The CEBG shall be valid for the period covering the agreed delivery date of the order with a further claim period of 3 months on the last specified delivery date. In the event of the failure of delivery BHEL would proceed with encashing the CEBG without reference to the Supplier. In the event of BHEL granting extension of the delivery dates, then the CEBG validity shall also be got extended by the Supplier to the extent of the extended delivery times together with the claim period as specified elsewhere. **The CEBG shall be for a value of 2% of the Purchase order.**

Suppliers who are all already registered with BHEL and having a vendor performance rating of A or A+ grade would be exempted from submission of CEBG.

Performance Bank Guarantee

Where ever so required, the Supplier shall arrange to provide a Performance bank guarantee (PBG). The indigenous suppliers have to provide the PBG from any one of the Nationalized Banks, listed in the tender terms. Overseas suppliers can submit the PBG from any of the reputed International / National Bankers. However the PBG shall be confirmed by any of the Bankers listed by us. The PBG shall guarantee the performance of the equipment / materials / items supplied and shall cover the guarantee period. The PBG shall have a claim period of 3 months in addition to the guarantee period. In the event of failure of the supplies made within the guarantee period, BHEL would encash the entire PBG. **The PBG shall be for a value of 10% of the Purchase order.**

The supplier/s have to get the PBG format (pre-printed) from BHEL and get the same stamped by the Banker. Change of PBG terms either by the supplier's Banker or by the supplier, after servicing of the order is not acceptable. Similarly PBG prepared by the supplier (typed by them) will also not be acceptable to BHEL. The pre-printed form issued by BHEL shall be used for making the PBG.

K] Post-order submission of documents for approval

In the event of the release of Letter of Intent (LoI) / Purchase order/s (PO) against this tender, Bidders have to submit the applicable documents as called for in the tender / LoI / PO/s, such as drawings, data sheets, design calculations etc. These documents for approval have to be submitted within the agreed timelines between BHEL and Bidder. Normally the time period for submission for approval is 15 days from the date of receipt of the LoI / PO by the supplier. The actual time period within which the documents have to be submitted for approval would be specified in the LoI / PO.

Such documents would be subjected to evaluation and approval by BHEL and / or by BHEL's customer / Consultant / Customer's Consultant. Bidders have to give their specific acceptance for this.

After approval of such documents and after getting clearance from BHEL, only the items ordered can be taken up for manufacture.

Any changes required by BHEL / Customer etc. in the documents submitted for approval shall be incorporated by the Bidder and no extra cost would be payable by BHEL for such changes.

In the event that the Bidder does not carry out the required corrections, then the LoI / PO would be liable for cancellation by BHEL and BHEL would resort to alternate purchase action at the risk and cost of the Bidder under the Risk Purchase Condition of the Purchase Order.

Note: After receiving the LoI / PO, supplier shall also forward the acknowledgement / acceptance of the LoI / PO by signing and returning the second copy of the LoI / PO as the token of acceptance.



L] Others

a) In case of any contradiction in the terms and conditions given here and elsewhere in the other documents of the tender, it shall be the responsibility of the tenderer to get it clarified from BHEL. The officer authorized to provide such clarifications is the tender issuing officer.

b) Alterations to the conditions of the Tender can be done only by the authorized officer, at any time before the date and time of tender opening and would be duly communicated through a corrigendum. c)

Suspension of Business dealings with Suppliers:

(i) Before submitting offer, prospective bidders are advised to visit our web-site www.bhel.com / supplier registration to familiarize themselves with BHEL's policy and procedures of Suspension of Business Dealings with Suppliers.

Submission of offer shall be deemed to be evidence of the Bidder to have read and understood the above said policy.

ii) Treatment of Banned / Under-performing Vendors:

Any supplier who has been put on "Hold" or "Banned" from having business dealings with BHEL, Ranipet or any other unit of BHEL shall not submit their offer against this tender. If any such offers are received they would be summarily rejected and sent back. During the processing of tender, if any unit of BHEL puts a supplier on "Ban" then further processing of the offer will not be taken up and in case an order is placed, BHEL, Ranipet may resort at their discretion to cancel the PO either fully or partially.

If any of the supplier who is supplying similar material to BHEL, Ranipet has a Vendor Performance Rating (VPR) score of 'C' or below, then offer given by such parties will not be considered for ordering in this tender.

If any of the Bidders have unexecuted order/s with BHEL and if in such orders, the deliveries have been delayed beyond a reasonable period (say 30 days of agreed delivery period), the offer of such Bidders will also be liable for rejection.

Offers of such of those bidders against whom action for suspension of business dealings has been initiated by BHEL, Ranipet or any other Units/Division of BHEL will also not be considered in this tender.

d) Fraud Prevention Policy:

The Bidder along with its associate/ collaborators/ sub-contractors/ sub-vendors/ consultants/ service providers shall strictly adhere to BHEL Fraud Prevention Policy displayed on BHEL website <http://www.bhel.com> and shall immediately bring to the notice of BHEL Management about any fraud or suspected fraud as soon as it comes to their notice.

e) Applicability of Integrity Pact:-

IP is a tool to ensure that activities and transactions between the Company and its Bidders/ Contractors are handled in a fair, transparent and corruption free manner. A panel of Independent External Monitors (IEMs) on the present panel have been appointed by BHEL with the approval of CVC to oversee implementation of IP in BHEL.



Sl.No	IEM	Email
1.	Shri Arun Chandra Verma, IPS (Retd.)	acverma1@gmail.com
2.	Shri Virendra Bahadur Singh, IPS (Retd.)	vbsinghips@gmail.com

The IP as enclosed with the tender is to be submitted (duly signed by authorized signatory) along with techno-commercial bid(Part-I, in case of two/three part bid). Only those bidders who have entered into such an IP with BHEL would be competent to participate in the bidding. In other words, entering into this Pact would be a preliminary qualification.

Please refer Section-8 of IP for Role and Responsibilities of IEMs. In case of any complaint arising out of the tendering process, the matter may be referred to the IEM(s).All correspondence with the IEMs shall be done through email only.

Note:

No routine correspondence shall be addressed to the IEM (phone/ post/ email) regarding the clarifications, time extensions or any other administrative queries, etc on the tender issued. All such clarification/ issues shall be addressed directly to the tender issuing (procurement) department's officials whose contact details are provided below:

For all clarifications/ issues related to the tender, please contact:

Name: (1) (2)

Dep't: Address:

.....

.....

Phone:(Landline/Mobile) (1) (2)

Email:

Fax:

Integrity Pact are applicable for all the BHEL enquiries whose estimated value is equal to or more than Rupees 05 Crores.

Copy of Integrity Pact with applicable nominated IEM is attached along with the tender documents for ready reference of Suppliers.

f) If any Supplier attempts to bribe, or pay commission, gift or any advantage or bring in undue influence either by himself or on his behalf any one including a stranger to the tender, in addition to instituting legal proceedings as per the extant laws prevailing, will disqualify the supplier from this tender and all future tenders of BHEL. Decision of the Purchaser would be final in this matter.

g) The laws governing this transaction shall be the laws in India.

h) Wherever not specified, Inco terms 2010 shall be used to interpret the Commercial terms and conditions and

i) In the event of an order, Supplier shall agree to settlement of disputes or differences, if any, by way of arbitration, in accordance with the "Rule of Arbitration" of the Indian Council of Arbitration.



The language in the tender documents downloaded by the Bidders shall at no point of time be changed, altered or modified in any manner by the Tenderer. If such changes are made by any tenderer, it shall be considered as tampering with BHEL's terms and the offer shall be summarily rejected, whenever it is noticed by BHEL. Such Bidders would be disqualified from the Bidding Process and their offers would be forfeited / Bank Guarantees invoked. They would also not be allowed to participate in future tenders of BHEL.

M. Conditions for rejection of offers:

Following is the list of situations which would lead to rejection of offer/s.

This list is not exhaustive but only indicative.

BHEL reserve the right to reject one or all offers without assigning any reason. The decision of BHEL will be final in this regard.

- 1. If the offer fails to meet the technical requirements/specifications of the tendered item/s.*
- 2. If the offer does not meet the commercial terms & conditions, such as but not limited to delivery period specified in the tender, Delivery terms, payment terms, Liquidated damages, Risk Purchase, cancellation clause etc., including the load factors specified in the tender.*
- 3. If the bidder fails to respond to clarification sought, within a reasonable period. In case of doubts / lack of clarity on the technical and commercial offer of the bidder, BHEL will seek clarifications. Bidders are required to respond completely to such BHEL's queries within 3 working days unless otherwise agreed to in writing by BHEL for period beyond 3 days. If supplier fails to respond within 3 working days or maximum 2 working days on a reminder thereon, the offer of such bidders will be automatically dis-qualified in the tender without further recourse to informing the bidder.*

- 4. If any of the conditions listed below are applicable to the bidder, the offer is liable to be rejected:*

If any

- Debt recovery / Winding up Proceedings are initiated against the Company in Courts / Debt Recovery Tribunals (DRTs),
 - Proceedings are there against the Company in National Company Law Tribunal (NCLT) with respect to Insolvency and Bankruptcy Code (IBC) or otherwise,
 - Any proceedings are there against the Company under the "Securitization and Reconstruction of Financial Assets and Enforcement of Security Interest (SARFAESI) Act,
 - Any restructuring proceedings are underway for the Company under Corporate Debt Restructuring (CDR), Strategic Debt Restructuring (SDR) or otherwise,
 - Divestment / demerger proceedings are underway for the Company under the Companies Act.
 - If action under guidelines of suspension of business dealings (Ref AA/MM/SB/01 Rev 02 dt 22.07.2016) and its latest revisions has been initiated against the company/bidder.
- 5. Failure to sign & accept the Integrity Pact (where applicable). Bidders are hereby informed that the contents of the Integrity Pact are firm and fixed and cannot be changed.*

The above list is not exhaustive but is indicative only.

N. Special Note:

BHEL is a Government of India Undertaking. Its procurement practices are governed by the (Internal) Purchase Policy issued by the management of the company and as per Annexure B applicable at the time of finalising the order against this tender.

-O-

Record of Revisions:

Revision No.	Revision Date	Modification
01	17.08.2016	Payment terms for Foreign suppliers modified wrt loading- Clause k.ii
02	29.08.2016	Treatment of banned vendors – Para 3 added - Clause L.ii
03	14.09.2016	Opening of offers – clause B – sub clause ‘b’ included and existing clause ‘b’ renamed as ‘c’.
04	14.09.2016	Opening of offers – Note – sub clause (ii) modified
05	12.10.2016	Clause N. Special Note added
06	22.10.2016	Clause G Reverse Auction modified. Annexure on General Business Rules for Reverse Auction appended Role of Principals added under ‘Miscellaneous’
07	20.01.2017	Clause L (e) is modified. Clause L (f ,g ,h) renumbered.
08	24.02.2017	Clause F(c) modified.
09	08.07.2017	Clause M, Point 4 is added – regarding the financial health of the Bidder - as a criterion for disqualification.
10	20.07.2017	Duties and Taxes replaced with GST; Applicability of GST for LD inserted in Clause E; Treatment of poor performing current vendors inserted in clause L.c.(ii)
11	25.07.2017	Clause A.Note (iii) CST etc., replaced with GST; Clause C.f Deleted;
12	15.09.2017	Clause M, Point 5 inserted regarding Integrity Pact
13	21.03.2018	Clause A, Point xi inserted regarding Overwriting in Price Bids
14	28.05.2018	Clause A, a),b),c),d) amended for M/s E-Procurement technologies, https://bhel.abcprocure.com . Clause A, (f, g, h) – modified. Clause M, Point 4, - regarding suspension of business dealings inserted.
15	23.07.2018	Clause L,(e)- Applicability of Integrity Pact – modified.
16	31.08.2018	Clause C,(n)- Preference to Make in India – added.
17	04.12.2018	Clause C,(n)- Preference to Make in India & Clause K.2 Note - MSE concessions– modified.
18	13.02.2019	Clause C,(n)- Preference to Make in India – modified. Page no 9 Clause o – Extended credit period - removed.
19	24.09.2019	Clause C,(n) - Preference to Make in India – modified. Clause L,(e) - New IEMs Updated
20	11.03.2020	Clause L,(e) – IEM’s address removed



21	11.06.2020	Clause G – Reverse Auction modified
22	22.07.2020	Clause C,(n) - Preference to Make in India – modified. Clause k (2) - MSE registration modified



ANNEXURE

Model General Business Rules for Reverse Auction

This has reference to tender no {tender number....date...}. BHEL shall finalise the Rates for the supply of {item name} through Reverse Auction mode. BHEL has made arrangement with M/s. {Service provider}, who shall be BHEL's authorized service provider for the same. Bidders should go through the instructions given below and submit acceptance of the same.

The technical & commercial terms are as per (a) BHEL Tender Enq. No. {...} dated {...}, (b) Bidders' technical & commercial bid (in case of two part bid) and (c) subsequent correspondences between BHEL and the bidders, if any.

1. Procedure of Reverse Auctioning

- i. Online Sealed Bid: This duration of online sealed bid will be {...} minutes. All bidders to submit their online sealed bids during this period.
- ii. Online Reverse Auction: The 'opening price' i.e. start price for RA and 'bid decrement' will be decided by BHEL.
- iii. If BHEL decides the lowest online sealed bid as the starting price, then the lowest bidder in online sealed bid shall be shown as current L1 automatically by the system and no acceptance of that price is required. System shall have the provision to indicate this bid as current L1.
- iv. Bidders by offering a minimum bid decrement or the multiples thereof can displace a standing lowest bid and become "L1" and this continues as an iterative process.
- v. After the completion of the online reverse auction, the Closing Price (CP) shall be available for further processing.

2. Schedule for Reverse Auction: The Reverse Auction is tentatively scheduled on {date}:

and the duration of online sealed bid will be {...} minutes. All bidders to submit their online sealed bids during this period. - **Online Sealed Bid:-**

- {Start Time:
- Close Time: }

- **Online Reverse Auction:-**

- {Start Time:
- Close Time: }

3. Auction extension time:

If a bidder places a bid in the last {...} minutes of closing of the Reverse Auction and if that bid gets accepted, then the auction's duration shall get extended automatically for another {...} minutes, for the entire auction (i.e. for all the items in the auction), from the time that bid comes in. Please note that the autoextension will take place only if a bid comes in those last {...} minutes and if that bid gets accepted as the lowest bid. If the bid does not get accepted as the lowest bid, the auto-extension will not take place even if that bid might have come in the last {...} minutes. In case, there is no bid in the last {...} minutes of closing of Reverse Auction, the auction shall get closed automatically without any extension. However, bidders are advised not to wait till the last minute or last few seconds to enter their bid during the auto-extension period to avoid complications related with internet connectivity, network problems, system crash down, power failure, etc. The above process will continue till completion of Reverse Auction.

Complaints/ Grievances, if any, regarding denial of service or any related issue should be given in writing thru e-mail/ fax to M/s. {Service provider} with a copy to BHEL within 15 minutes prior to initial closing time of Online Reverse Auction.



4. **Bid price:** The Bidder has to quote the {.....} Price inclusive of Packing & Forwarding charges, all the routine & type tests as per tender scope, GST, Freight (bidder to provide original Freight paid receipt), insurance charges, etc. including loading (if indicated by BHEL due to deviations in technical/ commercial terms) for the Items specified. Details are as shown in Excel Sheet for calculation of total cost to BHEL.(To be specified by Unit as per NIT conditions).

5. Bidding currency and unit of measurement:

Bidding will be conducted in *Indian Rupees per Unit* of the material as per the specifications {...}

In case of foreign currency bids, exchange rate (TT selling rate of State Bank of India) as on scheduled date of tender opening (Part-I bid) shall be considered for conversion in Indian Rupees. If the relevant day happens to be a Bank holiday, then the forex rate as on the previous bank (SBI) working day shall be taken.

6. **Validity of bids:** Price shall be valid for {... days} from the date of reverse auction. These shall not be subjected to any change whatsoever.

7. **Lowest bid of a bidder:** In case the bidder submits more than one bid, the lowest bid at the end of Online Reverse Auction will be considered as the bidder's final offer to execute the work.

8. Bidders shall be assigned a **Unique User Name & Password** by M/s. {Service provider}. Bidders are advised to change the Password and edit the information in the Registration Page after the receipt of initial Password from M/s. {Service provider} to ensure confidentiality. All bids made from the Login ID given to the bidders will be deemed to have been made by the bidders/ bidders 'company.

9. Post auction procedure: BHEL will proceed with the Lowest Bid in the Reverse Auction for further processing.

10. Any commercial/ technical loading shall be intimated to bidders prior to RA. The excel sheet provided in this regard shall cover all these aspects. Commercial/ technical loading if any, shall be added by the respective bidder in its price during online sealed bid & Online Reverse Auction. Modalities of loading & de-loading shall be separately intimated to the bidders. The responsibility for correctness of total cost to BHEL shall lie with the bidders.

11. Computerized reverse auction shall be conducted by BHEL (through M/s. {Service Provider}), on prespecified date, while the bidders shall be quoting from their own offices/ place of their choice. Internet connectivity shall have to be ensured by bidders themselves.

During the RA process if a bidder is not able to bid and requests for extension of time by FAX/ email/ phone then time extension of additional 15 minutes will be given by the service provider provided such requests come before 5 minutes of auction closing time. However, only one such request per bidder can be entertained. Despite this extension if bidder fails to upload his prices due to extreme case of failure of Internet connectivity, (due to any reason whatsoever may be) it is the bidders' responsibility/ decision to send fax communication immediately to M/s. {Service provider}, furnishing the price the bidder wants to bid online with a request to the service provider to upload the faxed price online so that the service provider will upload that price online on behalf of the Bidder. It shall be noted clearly that the concerned bidder communicating this price to service provider has to solely ensure that the fax message is received by the service provider in a readable/ legible form and also the Bidder should simultaneously check up with service provider about the clear receipt of the price faxed. It shall also be clearly understood that the bidder shall be at liberty to send such fax communications of prices to be uploaded by the service provider only within the closure of Bid time and under no circumstance it shall be allowed beyond the closure of Bid time /reverse auction. It shall also be noted that the service provider should be given a reasonable required time by the bidders, to upload such prices online and if such required time is not available at the disposal of the Service



provider at the time of receipt of the fax message from the bidders, the service provider will not be uploading the prices and either BHEL or the service provider are not responsible for this unforeseen circumstances. In order to ward-off such contingent situation bidders are requested to make all the necessary arrangements/alternatives whatever required so that they are able to circumvent such situation and still be able to participate in the reverse auction successfully. Failure of power or loss of connectivity at the premises of bidders during the Reverse auction cannot be the cause for not participating in the reverse auction. On account of this, the time for the auction cannot be extended and neither BHEL nor M/s. {Service provider} is responsible for such eventualities.

12. Proxy bids: Proxy bidding feature is a pro-bidder feature to safeguard the bidder's interest of any internet failure or to avoid last minute rush. The proxy feature allows bidders to place an automated bid in the system directly in an auction and bid without having to enter a new amount each time a competing bidder submits a new offer. The bid amount that a bidder enters is the minimum that the bidder is willing to offer. Here the software bids on behalf of the bidder. This obviates the need for the bidder participating in the bidding process until the proxy bid amount is decrementally reached by other bidders. When proxy bid amount is reached, the bidder (who has submitted the proxy bid) has an option to start participating in the bidding process.

The proxy amount is the minimum amount that the bidder is willing to offer. During the course of bidding, the bidder cannot delete or change the amount of a proxy bid. Bids are submitted in decrements (decreasing bid amounts). The application automates proxy bidding by processing proxy bids automatically, according to the decrement that the auction originator originally established when creating the auction, submitting offers to the next bid decrement each time a competing bidder bids, regardless of the fact whether the competing bids are submitted as proxy or standard bids. However, it may please be noted that if a manual bid and proxy bid are submitted at the same instant manual bid will be recognized as the L1 at that instant. In case of more than one proxy bid, the system shall bid till it crosses the threshold value of 'each lowest proxy bid' and thereafter allow the competition to decide the final L1 price. Proxy bids are fed into the system directly by the respective bidders. As such this information is privy only to the respective bidder(s).

13. Bidders are advised to get fully trained and clear all their doubts such as refreshing of screen, quantity being auctioned, tender value being auctioned etc. from M/s. {Service provider}.

14. M/s. {Service provider}, shall arrange to demonstrate/ train the bidder or bidder's nominated person(s), without any cost to bidders. M/s. {Service provider}, shall also explain the bidders, all the business rules related to the Reverse Auction. Bidders are required to submit their acceptance to the terms/ conditions/modalities before participating in the Reverse Auction in the process compliance form as enclosed. Without this, the bidder will not be eligible to participate in the event.

15. Successful bidder shall be required to submit the final prices (L1) in prescribed format (Annexure-VI) for price breakup including that of line items, if required, quoted during the Online Reverse Auction, duly signed and stamped as token of acceptance without any new condition (other than those already agreed to before start of auction), after the completion of auction to M/s. {Service provider} besides BHEL within two working days of Auction without fail.

16. Any variation between the final bid value and that in the confirmatory signed price breakup

Document will be considered as tampering the tender process and will invite action by BHEL as per extant guidelines for suspension of business dealings (as available on www.bhel.com).

17. Bidders' bid will be taken as an offer to execute the work/ supplies of the item as per enquiry

No. {...} dt. {...}. Bids once made by the bidder, cannot be cancelled/ withdrawn and bidder shall be bound to execute the work as mentioned above at bidder's final bid price. Should bidder back out and not execute the contract as per the rates quoted, BHEL shall take action as per extant guidelines for suspension of business dealings (as available on www.bhel.com).



- 18.** Bidders shall be able to view the following on their screen along with the necessary fields during Online Reverse Auction:
- Leading (Running Lowest) Bid in the Auction (only total price of package).
 - Bid Placed by the bidder.
 - Start Price.
 - Decrement value.
 - Rank of their own bid during bidding as well as at the close of auction
- 19.** BHEL's decision on award of contract shall be final and binding on all the Bidders.
- 20.** BHEL reserves the right to extend, reschedule or cancel the Reverse Auction process at any time, before ordering, without assigning any reason, with intimation to bidders.
- 21.** BHEL shall not have any liability to bidders for any interruption or delay in access to the site irrespective of the cause. In such cases, the decision of BHEL shall be binding on the bidders.
- 22.** Other terms and conditions shall be as per bidder's techno-commercial offers and other correspondences, if any, till date.
- 23.** If there is any clash between this business document and the FAQ available, if any, in the website of M/s. *{Service provider}*, the terms & conditions given in this business document will supersede the information contained in the FAQs. Any changes made by BHEL/ service provider (due to unforeseen contingencies) after the first posting shall be deemed to have been accepted if the bidder continues to access the portal after that time..
- 24.** Bidder shall not divulge either his Bids or any other exclusive details of BHEL to any other party. If the Bidder or any of his representatives are found to be involved in Price manipulation/ cartel formation of any kind, directly or indirectly by communicating with other bidders, action as per extant BHEL guidelines for suspension of business dealings (as available on www.bhel.com), shall be initiated by BHEL.



RA price confirmation and breakup
(To be submitted by L1 bidder after completion of RA)

To
- M/s. Service provider
- Postal address

CC: M/s BHEL

BOILER AUXILIARIES PLANT
INDIRA GANDHI INDUSTRIAL COMPLEX
RANIPET – 632406
TAMILNADU
INDIA.

Sub: Final price quoted during Reverse Auction and price breakup

Dear Sir,

We confirm that we have quoted.

Rs. { _____ in value & in words _____ } for item(s) covered under tender enquiry No. {...} dt. {...}

Total price of the items covered under above cited enquiries is inclusive of {Packing & forwarding, GST, freight and insurance charges up to {.....}
District, {.....} State and Type Test Charges etc., [exclusive of Goods & Services tax (GST)], other as per NIT}

as our final landed prices as quoted during the Reverse Auction conducted today {date} which will be valid for a period of { ___ in nos. & in words ___ } days.

The price break-up including that of line items is as given below.

Total =====
- Rs.in value & in words
=====

Thanking you and looking forward to the valuable order from BHEL.

Yours sincerely, For

Name:
Company:
Date: Seal: