



**Bharat Heavy Electricals Limited**  
Industrial Valves Plant  
Goindwal Sahib (Punjab)

**Enquiry No.**  
**2324-025E**

**Date:**  
**05.07.2023**

**NOTICE INVITING TENDER (NIT)**

Dear Sir / Madam,

BHEL Goindwal Sahib (Punjab) invites offers from interested bidders / suppliers for submission of their offer through e-procurement mode at <https://eprocurebhel.co.in/>. Offers in any other mode will not be accepted. In case of any difficulty faced while registering on BHEL's e-Procurement portal developed by NIC, queries may be addressed to 0120-4001002, 0120-4001005 and 0120-6277787; email: [support-eproc@nic.in](mailto:support-eproc@nic.in). These details are also available on 'Contact Us' page of the portal.

<b>Tender enquiry no. &amp; date</b>	2324-025E dated 05.07.2023
<b>Form of contract</b>	Supply
<b>Tender / Item description</b>	High Strength Friction Grip (HSFG) Fasteners (Bolts, Nuts and Washers)
<b>Material standard / Drawings</b>	As per attached TDC(s) and Drawings
<b>Location(s) of Supply / Work</b>	BHEL, HPBP, Trichy, Tamilnadu, India – 620014.
	NTPC Talcher, Distt. Angul, Odisha, India – 759107.
<b>Unloading of Material</b>	At BHEL Trichy by the SUPPLIER.
	At NTPC Talcher Site by BHEL Site.
<b>Earnest Money Deposit (EMD)</b>	Not Applicable
<b>Quotation parts</b>	Two Part Bid
<b>Tender download / Bid submission start date</b>	<b>05.07.2023 (17:00 Hrs. IST)</b>
<b>Tender download / Bid submission end date</b>	<b>17.07.2023 (12:00 Hrs. IST)</b>
<b>Tender / Bid opening date</b>	<b>17.07.2023 (15:30 Hrs. IST)</b>
<b>Validity of offer (In days)</b>	70 days from techno commercial bid opening (Part I)
<b>Quantity variation</b>	+/- 10% of tender quantity
<b>Delivery schedule</b>	Within 90 days from the date of PO placement / LOI
<b>Tender evaluation</b>	Item - Wise
<b>Reverse auction</b>	Applicable
<b>Contact person details</b>	Sumeet Bansal, Sr. Manager 01859-224 628, <a href="mailto:sbansal@bhel.in">sbansal@bhel.in</a>
	Pranshu, Dy. Manager 01859-224 685, <a href="mailto:pranshu@bhel.in">pranshu@bhel.in</a>

**PART-I (TECHNO-COMMERCIAL BID)**

(To be filled by bidder &amp; submit with offer as pdf file only)

**Tender Enquiry No. & Date****2324-025E Dt. 05.07.2023****Tender Description****Supply of HSE Fasteners**

Bidder must note following points:

1. This workbook is protected, except for cells where comments / confirmation is to be given by bidder.
2. Bidder is advised not to unprotect / tamper the sheet / alter the terms mentioned in the sheet.
3. Any alteration to terms mentioned by BHEL will be considered as tampering and bidder's offer shall be liable for rejection.
4. Bidders are advised to only fill the unprotected cells (shaded cells) by dropdown or writing the comments as applicable as their confirmation. **Bidders are advised to submit duly filled & signed 'PDF' file as techno-commercial (Part-I) bid**. Failure on the part of bidder in not returning this duly filled-up techno-commercial bid and / or submitting incomplete replies may lead to rejection of bidder's quotation.
5. All the commercial terms and conditions shall be indicated by vendor in this format only and nowhere else in his quotation. However, in case the space for vendor's reply is not sufficient against a particular question, the vendor shall furnish same by way of separate annexure / sheet attached to this questionnaire, indicating cross-reference of respective clauses.

**BIDDER'S DETAILS**

Sr. No.	Elements	Remarks
1	Bidder's Name/Name of the Firm	
2	Quotation reference no. & date	
3	Contact Person Name/Number/Designation	Name: Contact No: Designation:
4	Email ID (s)-(Can be provided more than one)	
5	Mobile No. (s)	
6	Tel. No. (s)	
7	Fax No.	
8	Registered Address	
9	Address for Correspondence	
10	Bidder Type (Indian / Foreign):	
11	Company's Establishment Year	
12	Company's Nature of Business (Tick the relevant option <input type="checkbox"/> )	<input type="checkbox"/> Manufacturer <input type="checkbox"/> Dealer/ Trader/ Stockist/Channel Partner/Agent/etc.
13	Company Category (Micro unit as per MSME / Small unit as per MSME /	
14	Status of the Company / Firm * (Relevant documents must be enclosed) (Tick the relevant option <input type="checkbox"/> )	<input type="checkbox"/> Public Limited; <input type="checkbox"/> Private Limited <input type="checkbox"/> Partnership Firm; <input type="checkbox"/> Single Ownership
15	Name of Owner / Partner's of Firm	
16	GST No.	

**TECHNICAL CONDITION DETAIL**

Sr. No.	Elements	Response	Remarks
1	Technical : Supply of HSE Fasteners as per tender documents (if selected 'Accepted with deviation', please mention the deviation clearly)	Select from the drop down list	

**COMMERCIAL CONDITIONS & DETAILS**

Sr. No.	Elements	Response	Remarks (if any)
1	IGST supply (%)	Select from drop down list	
2	SGST supply (%)	Select from drop down list	
3	CGST supply (%)	Select from drop down list	
4	Validity: 70 days from techno commercial bid opening. (refer tender terms & conditions)	Select from the drop down list	
5	Delivery period: Within 90 days from placement of PO / LOL. (refer tender terms & conditions)	Select from the drop down list	
6	Delivery Destination (refer tender special term S1 and S4)	For Item at Sr.no. 1 to 3, Delivery will be at BHEL Trichy, Tamilnadu	Select from the drop down list
		For Item at Sr.no. 4 to 8, Delivery will be at NTPC Talcher Site, Odisha	Select from the drop down list
7	Unloading (refer tender special term S1 and S4)	For Item at Sr.no. 1 to 3, Unloading at BHEL Trichy is to done by Supplier.	Select from the drop down list
		For Item at Sr.no. 4 to 8, Unloading at Talcher Site to be arranged by BHEL Site.	Select from the drop down list
8	Please attach Declaration for proof as a manufacturer (Refer special terms S2.1)	Select from drop down list	

## PART-I (TECHNO-COMMERCIAL BID)

(To be filled by bidder & submit with offer as pdf file only)

**Tender Enquiry No. & Date**

**2324-025E Dt. 05.07.2023**

**Tender Description**

**Supply of HSE Fasteners**

Bidder must note following points:

1. This workbook is protected, except for cells where comments / confirmation is to be given by bidder.
2. Bidder is advised not to unprotect / tamper the sheet / alter the terms mentioned in the sheet.
3. Any alteration to terms mentioned by BHEL will be considered as tampering and bidder's offer shall be liable for rejection.
4. **Bidders are advised to only fill the unprotected cells (shaded cells) by dropdown or writing the comments as applicable as their confirmation. Bidders are advised to submit duly filled & signed 'PDF' file as techno-commercial (Part-I) bid'. Failure on the part of bidder in not returning this duly filled-up techno-commercial bid and / or submitting incomplete replies may lead to rejection of bidder's quotation.**
5. All the commercial terms and conditions shall be indicated by vendor in this format only and nowhere else in his quotation. However, in case the space for vendor's reply is not sufficient against a particular question, the vendor shall furnish same by way of separate annexure / sheet attached to this questionnaire, indicating cross-reference of respective clauses.

9	Documents regarding Purchase Order/s of 'similar item' from any customer with minimum cumulative value of Rs. 35,00,000 along with the proof of execution (Refer special terms S2.2)	Select from the drop down list	
	Details of Submitted PO and their Proof of Execution has been filled in <b>Annexure -P</b> , as per above stated PQC term at Sr. no. S2.2.)	Select from drop down list	
10	Confirmations of Special terms as per <b>Annexure-Q</b> (Refer special term S3 (e))	Select from drop down list	
11	Conflict of Interest among Bidders / Agents (Refer clause no. 7 of General Contract conditions (GCC))	Not having Conflict of Interest with other Bidders	
12	LD clause: Penalty for late delivery will be applicable @ 0.5% per week or part thereof subject to a maximum of 10.0 %. (Refer Clause 11 of General Contract Conditions (GCC)).	Select from the drop down list	
13	Payment term: (Refer clause no. 13 of General Contract conditions (GCC))	Select from the drop down list	
14	<b>Warranty Period:</b> Supplier shall give a warrantee for a period of 18 months from the date of receipt. In case of non-acceptance of this term bid will be rejected. (Refer clause no. 18 of GCC)	Select from the drop down list	
15	Risk purchase: If the supplier fails to deliver the goods within the delivery specified in the Purchase Order, BHEL will be entitled to terminate the contract and to Purchase elsewhere at the risk and cost of the seller either the whole of the goods or any part which the supplier has failed to deliver or despatch within the delivery period mentioned in the Purchase Order. (Refer Cl. 21 of GCC in Tender Terms & Conditions)	Select from the drop down list	
16	Please attach valid MSE certificate latest MSME Guidelines (Refer clause no. 25 of GCC)	Select from drop down list	
17	Make in India (MII) (Refer clause no. 26 of GCC)	Local Content Declaration	Select from drop down list
		Details of location at which local value addition will be made is as follows:	Select from drop down list
18	Firm Price: The quoted / finalised rates shall be firm till execution of the supplies.	Select from the drop down list	
19	I have thoroughly gone through the attached tender terms & conditions and understood the above techno-commercial requirements	Select from drop down list	

### Item detail

Item Sl. no.	Material Code	Description	Qty in no	Quoted / not quoted
1	414190002000	M20 WASHER Grade 10.9	<b>2,00,000</b>	
2	414180002400	M24 WASHER Grade 8.8	<b>6,00,000</b>	
3	414190003000	M30 WASHER Grade 10.9	<b>2,00,000</b>	
4	412403013001	M30X130 EXTENDED HSEFG BOLTS and NUTS Grade 10.9	<b>17,000</b>	
5	412403017001	M30X170 EXTENDED HSEFG BOLTS and NUTS Grade 10.9	<b>7,000</b>	
6	412403020001	M30X200 EXTENDED HSEFG BOLTS and NUTS Grade 10.9	<b>2,000</b>	
7	414180002400 (Same as Sr. no. 2)	M24 WASHER Grade 8.8	<b>4,00,000</b>	
8	414190003000 (Same as Sr. no. 3)	M30 WASHER Grade 10.9	<b>50,000</b>	

**PART-I (TECHNO-COMMERCIAL BID)**

(To be filled by bidder & submit with offer as pdf file only)

**Tender Enquiry No. & Date**

**2324-025E Dt. 05.07.2023**

**Tender Description**

**Supply of HSE Fasteners**

Bidder must note following points:

1. This workbook is protected, except for cells where comments / confirmation is to be given by bidder.
2. Bidder is advised not to unprotect / tamper the sheet / alter the terms mentioned in the sheet.
3. Any alteration to terms mentioned by BHEL will be considered as tampering and bidder's offer shall be liable for rejection.
4. **Bidders are advised to only fill the unprotected cells (shaded cells) by dropdown or writing the comments as applicable as their confirmation. Bidders are advised to submit duly filled & signed 'PDF' file as techno-commercial (Part-I) bid**. Failure on the part of bidder in not returning this duly filled-up techno-commercial bid and / or submitting incomplete replies may lead to rejection of bidder's quotation.
5. All the commercial terms and conditions shall be indicated by vendor in this format only and nowhere else in his quotation. However, in case the space for vendor's reply is not sufficient against a particular question, the vendor shall furnish same by way of separate annexure / sheet attached to this questionnaire, indicating cross-reference of respective clauses.

We further, confirm that we have quoted the rates in the tender considering Inter-alia the

1. Tender Document(s)
2. Additional Document(s) (if any)
3. BOQ Document (Price Bid Format-Part-II)
4. Corrigendum (if any)
5. Pre Bid Meeting Minutes (if any)

We hereby certify that we have fully read and thoroughly understood the tender requirements and accept all terms and conditions of the tender including all corrigendum/addendum issued (if any). Our offer is in confirmation to all the terms and conditions of the tender including all corrigendum/addendum (if any) and minutes of the pre-bid meeting (if any). In the event our offer is found acceptable and Order is placed /Contract is awarded to us, the complete tender document shall be considered for constitution of Order / Contract Agreement.

Validate

Print

Help

**Item Wise BoQ**

Tender Inviting Authority: BHEL IVP Goindwal Sahib

Name of Work: Supply of HSFSG Fasteners

Contract No: 2324-025E dated 05.07.2023

Name of the Bidder/ Bidding Firm / Company :

**PRICE SCHEDULE**

(This BOQ template must not be modified/replaced by the bidder and the same should be uploaded after filling the relevant columns, else the bidder is liable to be rejected for this tender. Bidders are allowed to enter the Bidder Name and Values only )

NUMBER #	TEXT #	TEXT #	NUMBER #	TEXT #	NUMBER #	NUMBER #	TEXT #
Sl. No.	Item Description <i>For item sl. nos. 01 to 03 delivery destination is BHEL Trichy</i> <i>For item sl. nos. 04 to 08 delivery destination is NTPC Talcher site</i>	Item Code / Make	Quantity	Units	BASIC RATE In Figures To be entered by the Bidder in Rs. Per piece	TOTAL AMOUNT excluding taxes in Rs. P	TOTAL AMOUNT In Words
1	2	3	4	5	7	11	13
1	M20 WASHER Grade 10.9	414190002000	2,00,000	Number		0.00	INR Zero Only
2	M24 WASHER Grade 8.8	414180002400	6,00,000	Number		0.00	INR Zero Only
3	M30 WASHER Grade 10.9	414190003000	2,00,000	Number		0.00	INR Zero Only
4	M30X130 EXTENDED HSFSG BOLTS and NUTS Grade 10.9	412403013001	17,000	Number		0.00	INR Zero Only
5	M30X170 EXTENDED HSFSG BOLTS and NUTS Grade 10.9	412403017001	7,000	Number		0.00	INR Zero Only
6	M30X200 EXTENDED HSFSG BOLTS and NUTS Grade 10.9	412403020001	2,000	Number		0.00	INR Zero Only
7	M24 WASHER Grade 8.8	414180002400 (Same as Sr. no. 2)	4,00,000	Number		0.00	INR Zero Only
8	M30 WASHER Grade 10.9	414190003000 (Same as Sr. no. 3)	50,000	Number		0.00	INR Zero Only



## SPECIAL TERMS AND CONDITIONS

Tender Enquiry No. 2324-025E Dated 05.07.2023 **Due date 17.07.2023**

**Tender Description:** Supply of HSFG Fasteners

### S1. SCOPE OF SUPPLY

Material shall be supplied as per the applicable Technical Delivery Condition (TDC) / Drawing as mentioned in the Table – 1, at the respective Delivery Destinations. National & International material standards shall have to be arranged by bidders themselves.

**Table 1 : List of Items along with Quantity; Drawing Number and Delivery Destination**

Sl. No.	Material Code	Description	Quantity (Nos.)	Bolt Drawing No.	Delivery Destination
1	414190002000	M20 WASHER Grade 10.9	2,00,000	--	BHEL Trichy
2	414180002400	M24 WASHER Grade 8.8	6,00,000	--	BHEL Trichy
3	414190003000	M30 WASHER Grade 10.9	2,00,000	--	BHEL Trichy
4	412403013001	M30X130 EXTENDED HSFG BOLTS and NUTS Grade 10.9	17,000	3-35-700-09999 Rev 00	NTPC Talcher
5	412403017001	M30X170 EXTENDED HSFG BOLTS and NUTS Grade 10.9	7,000	3-35-700-09999 Rev 00	NTPC Talcher
6	412403020001	M30X200 EXTENDED HSFG BOLTS and NUTS Grade 10.9	2,000	3-35-700-09999 Rev 00	NTPC Talcher
7	414180002400 (Same as Sr. no. 2)	M24 WASHER Grade 8.8	4,00,000	--	NTPC Talcher
8	414190003000 (Same as Sr. no. 3)	M30 WASHER Grade 10.9	50,000	--	NTPC Talcher

#### **Additional Information :**

A. For item Sr. no. 4 to 6, where Material Description is 'EXTENDED HSFG BOLTS and NUTS'

- (i) "1 number" of Quantity = 1 Bolt + 1 Nut.
- (ii) Applicable TDC is TDC : 5 : 215 Rev 01.
- (iii) Bolts are to be supplied as per Drawings & TDCs.

B. For item Sr. no. 1 to 3, 7 and 8, where Material Description is 'WASHER'

- (i) "1 number" of Quantity = 1 Washer.
- (ii) Applicable TDC is TDC:5:211 Rev 02.
- (iii) Washers to be supplied as per relevant TDC only.

Applicable 'Standard Quality Plan' for all the items: SQP: HSFG:01 Rev: 00 dated 28.09.2020.



## SPECIAL TERMS AND CONDITIONS

Tender Enquiry No. 2324-025E Dated 05.07.2023 **Due date 17.07.2023**

**Tender Description:** Supply of HSFG Fasteners

**Minimum 50% and 20% Local Content required for qualifying as Class 1 and Class 2 Local Supplier respectively.**

Bidders will submit TPI (Third party inspection) / BHEL Inspection report to BHEL IVP after inspection. Then based on Inspection report, BHEL will give dispatch clearance and then only the material shall be supplied to the respective consignee address.

### **S2. PRE-QUALIFICATION CRITERIA (POC)**

1. Supplier shall be manufacturer of Fasteners. Offers from Traders/Dealers/Stockists/agents will summarily be rejected. Submission of Certificate of Registration or UDYAM Certificate or Declaration from bidder for proof as a manufacturer is required to fulfil this criterion.
2. Bidder has to submit one or more purchase order/s of 'similar item' from any customer with minimum cumulative value of Rs. 35,00,000 (Thirty-Five Lacs Rupees) along with the proof of execution like Invoice / Consignee Receipt Note / Completion Certificate, from any customer(s). PO date should be 01.07.2020 or afterwards till bid opening date". PO value mentioned above is net of taxes. The details of the submitted POs along with its proof of execution must be filled as per attached Annexure - P. **Also, please note that the proof of execution like Invoice / Consignee Receipt Note / Completion Certificate must include the Purchase Order reference number, otherwise that PO will not be considered for the fulfilment of this tender term.**

"Similar item" has been defined as "Bolts, Nuts or Washers (Bolt Grade 8.8 or above as per IS1367 (Latest Revision), IS3757(Latest Revision) or equivalent; Nut Grade 8 or above as per IS6623(Latest Revision) or equivalent; Washer Grade 8 or above as per IS 6649(Latest Revision) or equivalent", refer TDC:5:211 Rev:02 for more details.

Start-ups shall be exempted from this criterion of Purchase order and invoice submission without any relaxation in quality standards or technical parameters as per D.O. No. 5(4)/2016-BE-I dated 15.02.2017. For claiming Start-Up exemption, vendors have to submit DPIIT (Dept. of Promotion of Industry and Internal Trade)/DIPP (Department for Industrial Policy and Promotion) recognition certificates.

BHEL may carry out evaluation of bidder's capability. BHEL reserves the right to accept/reject any offer based on evaluation of bidder's capability. For verification of data presented for pre-qualification bid, BHEL may decide to visit the bidder(s) works. Any fact found deviating from bids during evaluation shall make the bidder liable to be dis-qualified.

### **S3. PART-I: TECHNO-COMMERCIAL BID**

**Techno - Commercial Bid should contain *all the documents/confirmations as per following details:***

- a) Acceptance of Techno-Commercial terms and conditions shall be attached along with bid document. This can be attached either by signing each page of terms and conditions or a confirmation statement.



## SPECIAL TERMS AND CONDITIONS

Tender Enquiry No. 2324-025E Dated 05.07.2023 **Due date 17.07.2023**

**Tender Description:** Supply of HSFG Fasteners

*IF THE OFFER IS NOT ACCOMPANIED WITH ACCEPTANCE OF TERMS AND CONDITIONS, IT SHALL BE CONCLUDED THAT ALL THE TERMS AND CONDITIONS ARE ACCEPTABLE AND NO CLAIM WHATSOEVER SHALL BE ENTERTAINED LATER ON.*

- b) MSE vendors should submit **UDYAM Registration Certificate** for availing applicable benefits for MSE vendors as per tender terms. Validity of document shall be considered as on date of Part I opening as per the latest available notification from Government.
- c) Documents as per pre-qualification terms.
- d) Duly filled Annexure - P (Details of Submitted PO and their Proof of Execution, as per above stated PQC term at Sr. no. S2. Cl. 2.)
- e) Duly filled Annexure – Q (Confirmations of Special terms)

### **S4. DELIVERY DESTINATION and SCOPE OF UNLOADING**

- (i) For Items at Enquiry Sr. no. 1 to 3, where Delivery Destination is BHEL Trichy, the material is to be supplied at following address:

Manager / Stores – 11  
Fossil Boilers, BHEL  
Boiler Plant Project P.O.  
Tiruchirapalli - 620 014.  
Tamilnadu, India.

**Unloading** of Material at BHEL Trichy Stores is in the Scope of SUPPLIER.

- (ii) For Items at Enquiry Sr. no. 4 to 8, Delivery Destination is NTPC Talcher. The material is to be supplied to NTPC Talcher Site at following address:

NTPC Talcher  
Project Site Address:  
Construction Manager,  
BHEL Site Office,  
2X660 MW NTPC Talcher,  
Distt. Angul – 759107  
Odisha, India

Contact Person:  
Sh. Mahesh Kumar  
Deputy Engineer  
Material Management  
NTPC Talcher Site  
Mobile: 95742 44431

**Unloading** of Material at NTPC Talcher Site is in the Scope of BHEL Site Office.

### **S5. REVERSE AUCTION**

Reverse auction will be conducted in this tender enquiry.



## SPECIAL TERMS AND CONDITIONS

Tender Enquiry No. 2324-025E Dated 05.07.2023 **Due date 17.07.2023**

**Tender Description:** Supply of HSFG Fasteners

### **S6. DIFFERENTIAL FREIGHT CLAUSE (Applicable for Item Sr. No. 4 to 8)**

The rates finalized against each schedule shall include cost of transporting finished products from Vendor's Works to delivery location specified in the tender.

All the consignments are normally envisaged for dispatch from Vendor's Works to specified location in the tender. However, in exceptional cases (in case of Project hold/ any unforeseen conditions), BHEL may permit Vendor(s) on case to case basis for handing over the consignments to some new location. BHEL's decision shall be final in this regard. In such case, differential freight charges shall be deducted or paid based on applicable distance.

#### **Differential Rates will be calculated as below:**

If BHEL advises to despatch material at any other location, then BHEL will calculate freight portion from vendor works to Location specified in tender (say it comes out amount 'X') and from vendor works to New location specified by BHEL (say it comes out amount 'Y'). Then differential freight cost will be calculated by subtracting both freight cost (Y-X). If it comes out to be positive, then this differential cost shall be given extra to vendor. If it comes out to be negative, then this differential amount shall be deducted from vendor. Kindly note that this extra payment to vendor/deduction from vendor shall be amended suitable in Purchase order before despatch.

For Calculation of Transportation freight, BHEL has mentioned Rate/KM/MT in INR from anywhere to anywhere in India. For calculating total cost, this needs to be multiplied by distance in KM & weight in MT.

#### **Rate/KM/MT from anywhere to anywhere is mentioned below:**

Relevant category	Freight Rate per MT per KM	Remarks
TAAA2	4.18	Anywhere to anywhere

Distance shall be taken in KM as shortest distance from Google map.

**Example:** Suppose one vendor is located in Ludhiana (Punjab). Distance from Ludhiana to BHEL Goindwal is approx. 150 KM & distance from Ludhiana to Talcher site is approx.1900 KM. The specified destination in tender is Talcher and the new location specified for delivery of material is Goindwal. Suppose weight of consignment is 60 MT Then freight from Ludhiana to Goindwal (Y) comes out to be Rs.  $4.18 \times 150 \times 60 = 37,620.00$ . The freight from Ludhiana to Talcher (X) comes out to be Rs.  $4.18 \times 1900 \times 60 = 4,76,520.00$ . Now differential cost (Y-X) comes out to be Rs.  $(- )4,38,900.00$ . Hence this differential amount will be deducted from vendor.



## SPECIAL TERMS AND CONDITIONS

Tender Enquiry No. 2324-025E Dated 05.07.2023 **Due date 17.07.2023**

**Tender Description:** Supply of HSFG Fasteners

### **S7. INSPECTION**

Bidders will submit TPI (Third party inspection) / BHEL Inspection report to BHEL IVP after inspection. Then based on Inspection report, BHEL will give dispatch clearance and then only the material shall be supplied to the respective consignee address.

### **S8. QUANTITY VARIATION**

+/-10% Variation in the quantity is applicable in this tender enquiry.

### **S9. DELIVERY SCHEDULE**

Delivery shall be within 90 days from date of Purchase Order/ Letter of Intent.

**These Special terms & conditions and General Contract Conditions (GCC) collectively are the part of tender terms and conditions.**



## General Conditions of Contract (GCC) of MM Tenders

**BHARAT HEAVY ELECTRICALS LIMITED**

Industrial Valve Plant: 433, Industrial Complex,  
Goindwal Sahib, Dist. Tarn Taran,  
Punjab-143422 (INDIA)

### TABLE OF CONTENTS

1. Instruction to Bidder .....	2
2. Scope of Supply .....	2
3. Price Basis.....	3
4. Discrepancy in Words And Figures.....	3
5. Evaluation in Case of More Than One L-1 Bidder.....	3
6. Reverse Auction.....	4
7. Conflict of Interest among Bidders / Agents .....	4
8. Validity of Offers.....	5
9. Supplied Material Adjustment.....	5
10. Delivery Schedule.....	5
11. Liquidated Damaged (LD).....	5
12. Acceptance of Material Supplied.....	5
13. Payment Terms .....	6
14. Taxes & Duties .....	7
15. Liability Under Reverse Charge (RCM).....	7
16. Access to Manufacturing Premises.....	7
17. Inspection.....	7
18. Warrantee and Corresponding Repair / Replacement of Goods.....	8
19. LOI (Letter of Intent).....	9
20. Sub-Contract .....	9
21. Risk Purchase.....	9
22. Force Majeure .....	9
23. Non-Disclosure Agreement .....	10
24. Clarifications.....	10
25. Preferences for Micro and Small Enterprises (MSEs).....	10
26. Preference to Make in India.....	11
27. Restrictions Under Rule 144(XI) of The General Financial Rules (GFR), 2017 .....	11
28. Resolution of Disputes.....	12
29. Fraud Prevention Policy.....	13
30. Preventive Checks to Eliminate Suspected Cartel Formation .....	13
31. Suspension of Business Dealings with Suppliers / Contractors .....	14
32. General.....	14
Annexure-X.....	17
Appendix-I of Annexure-X.....	23
Appendix-II of Annexure-X .....	24
Appendix-III of Annexure-X .....	25





## General Conditions of Contract (GCC) of MM Tenders

**BHARAT HEAVY ELECTRICALS LIMITED**

Industrial Valve Plant: 433, Industrial Complex,  
Goindwal Sahib, Dist. Tarn Taran,  
Punjab-143422 (INDIA)

### 1. Instruction to Bidder

Quotations shall be submitted before due date and time. Late offers are liable to be rejected, so please ensure to submit bid well within due date and time. Techno-commercial part will be opened on due date.

**Based on evaluation of techno-commercial offers, Price bids of bidders who qualify from techno-commercial evaluation shall be opened. BHEL may decide to open the Price bid same day at 1700 hrs. If not opened on the same day, all qualifying bidders shall be notified for date of opening of Price bids by email/fax/post/courier/E-procurement system generated email.**

#### 1.1 Instruction to Bidder (In case of Non-E-Procurement / Paper/ Manual/ Hard Copy based tenders)

Sealed Tenders can be dropped in the tender box labeled as 'Tender box for MM contracts'. This tender box is located at the entrance of Admin block BHEL Goindwal. Quotations can also be submitted through e-mail at [tendermm\\_ivp@bhel.in](mailto:tendermm_ivp@bhel.in). Offers received in time shall be considered only when offers are complete in all respects. In case of bulky tenders, please handover quotation to Sh. Rakesh Kumar/SDGM - Head-MM or Sh. Sumeet Bansal / Sr. Manager - MM [Contact: 01859 224 615 / 628]. Bid can be sent to following address:

**BHEL, Industrial Valve Plant,  
#433, Industrial Complex,  
Goindwal Sahib, Distt. Tarn Taran,  
Punjab-143422.**

#### 1.2 Instruction to bidder (In case of E-Procurement)

- Interested bidders / suppliers shall submit their offer through e-procurement mode at <https://eprocurebhel.co.in/>.
- Offers in any other mode will not be accepted.**
- Procedure for submission of tender is available in the "Bidder Manual Kit" at e-tender portal <https://eprocurebhel.co.in/>.
- In case of any difficulty faced while registering on BHEL's e-Procurement portal developed by NIC, queries may be addressed to 0120-4001002, 0120-4001005 and 0120-6277787; email: [support-eproc@nic.in](mailto:support-eproc@nic.in). These details are also available on 'Contact Us' page of the portal.
- Before uploading scanned documents if any, the bidders shall sign on all the statements, documents, certificates uploaded by him, owning responsibility for their correctness / authenticity.
- Disclaimer clause:** Neither the Organization (Bharat Heavy Electricals Ltd.) nor the service provider is responsible for any failure of submission of bids due to failure of internet or other connectivity problems or reasons thereof.

### 2. Scope of Supply

Material shall be supplied as per the applicable latest Technical Delivery Conditions (TDC)/ Material Standard requirements/BPS/Drawing and other requirement as given in the Tender Enquiry. National & International material Standards shall have to be arranged by vendors themselves. Latest applicable revisions of standards/procedures to be referred.





## General Conditions of Contract (GCC) of MM Tenders

### BHARAT HEAVY ELECTRICALS LIMITED

Industrial Valve Plant: 433, Industrial Complex,  
Goindwal Sahib, Dist. Tarn Taran,  
Punjab-143422 (INDIA)

All required tests as called in referred material standard/BHEL/TDC/drawing etc. shall be carried out by vendor at no extra cost. Material Test Certificates (MTC), inspection reports and Compliance/Guarantee Certificate are to be provided along with the supplies.

### 3. Price Basis

1. Order of enquiry item sl. no. shall be maintained in the quotation.
2. The rates quoted shall be firm and fixed. No price variation is proposed and allowed.
3. Rates quoted should be FOR BHEL Goindwal basis. The offers quoted on other than FOR Goindwal basis are liable to be rejected.

In case bidder has quoted Ex-works prices, then he/she will be given an opportunity to accept price basis as FOR Goindwal either by accepting delivery as FOR Goindwal in same quoted price or by providing loading factor on his/her quoted ex-works prices to make them FOR prices.

**Variation in GST or any other statutory levies during contractual delivery period shall be to BHEL's account.**

### 4. Discrepancy in Words And Figures

1. If, in the price structure quoted for the required goods/ services/ works, there is discrepancy between the unit price and the total price (which is obtained by multiplying the unit price by the quantity}, the unit price shall prevail and the total price corrected accordingly, unless in the opinion of the purchaser there is an obvious misplacement of the decimal point in the unit price, in which case the total price as quoted shall govern and the unit price corrected accordingly.
2. If there is an error in a total corresponding to the addition or subtraction of subtotals, the subtotals shall prevail and the total shall be corrected; and
3. If there is a discrepancy between words and figures, the amount in words shall prevail, unless the amount expressed in words is related to an arithmetic error, in which case the amount in figures shall prevail subject of (a) and (b) above.
4. If there is such discrepancy in an offer, the same shall be conveyed to the bidder with target date upto which the bidder has to send his acceptance on the above lines and if the bidder does not agree to the decision of the purchaser, the bid is liable to be ignored.
5. Bids should be free from correction, overwriting, using corrective fluid, etc. Any interlineation, cutting, erasure or overwriting shall be valid only if they are attested under full signature(s) of person(s) signing the bid else shall be liable for rejection.
6. All overwriting/cutting, etc will be numbered by bid opening officials and announced during bid opening.

### 5. Evaluation in Case of More Than One L-1 Bidder

In the course of evaluation, if more than one bidder happens to occupy L1 status, effective L1 will be decided by soliciting discounts from the respective L1 bidders.

In case more than one bidder happens to occupy the L1 status even after soliciting discounts, the L1 bidder shall be decided by a toss / draw of lots, in the presence of the respective L1 bidder(s) or their representative(s).

Ranking will be done accordingly. BHEL's decision in such situations shall be final and binding.

Signature Not Verified  
Signed By: RAKESH  
KUMAR  
Location: BHEL, Goindwal  
Signing Date: 05.04.2023





## General Conditions of Contract (GCC) of MM Tenders

**BHARAT HEAVY ELECTRICALS LIMITED**

Industrial Valve Plant: 433, Industrial Complex,  
Goindwal Sahib, Dist. Tarn Taran,  
Punjab-143422 (INDIA)

### 6. Reverse Auction

In case, it is declared in special terms & conditions of tender enquiry that RA is applicable for the NIT, then RA will be conducted as per following clause:

BHEL shall be resorting to Reverse Auction (RA) (Guidelines as available on <https://www.bhel.com/>) for this tender. RA shall be conducted among the techno-commercially qualified bidders as per RA guidelines.

Price bids of all techno-commercially qualified bidders shall be opened and same shall be considered for RA. In case any bidder(s) do(es) not participate in online Reverse Auction, their sealed envelope price bid along with applicable loading, if any, shall be considered for ranking.

### 7. Conflict of Interest among Bidders / Agents

A bidder shall not have conflict of interest with other bidders. Such conflict of interest can lead to anti-competitive practices to the detriment of Procuring Entity's interests. ***The bidder found to have a conflict of interest shall be disqualified.*** A bidder may be considered to have a conflict of interest with one or more parties in this bidding process, if:

- a) they have controlling partner (s) in common; **or**
- b) they receive or have received any direct or indirect subsidy/ financial stake from any of them; **or**
- c) they have the same legal representative/agent for purposes of this bid; **or**
- d) they have relationship with each other, directly or through common third parties, that puts them in a position to have access to information about or influence on the bid of another Bidder; **or**
- e) Bidder participates in more than one bid in this bidding process. Participation by a Bidder in more than one Bid will result in the disqualification of all bids in which the parties are involved. However, this does not limit the inclusion of the components/ sub-assembly/ Assemblies from one bidding manufacturer in more than one bid. **or**
- f) In cases of agents quoting in offshore procurements, on behalf of their principal manufacturers, one agent cannot represent two manufacturers or quote on their behalf in a particular tender enquiry. One manufacturer can also authorise only one agent/dealer. There can be only one bid from the following:
  1. The principal manufacturer directly or through one Indian agent on his behalf; and
  2. Indian/foreign agent on behalf of only one principal.**or**
- g) a Bidder or any of its affiliates participated as a consultant in the preparation of the design or technical specifications of the contract that is the subject of the Bid; **or**
- h) In case of a holding company having more than one independently manufacturing units, or more than one unit having common business ownership/management, only one unit should quote. Similar restrictions would apply to closely related sister companies. Bidders must proactively declare such sister/ common business/ management units in same/ similar line of business.





## General Conditions of Contract (GCC) of MM Tenders

### BHARAT HEAVY ELECTRICALS LIMITED

Industrial Valve Plant: 433, Industrial Complex,  
Goindwal Sahib, Dist. Tarn Taran,  
Punjab-143422 (INDIA)

#### 8. Validity of Offers

The offers shall be kept open for acceptance 'for number of days mentioned in special terms and conditions' from the date of opening of the tender. In case of tender extension, the bid validity shall be considered from the date of tender opening.

#### 9. Supplied Material Adjustment

Item/s pending in previous PO has to be billed in previous PO only. Otherwise, BHEL will be free to adjust the supplies in previous PO. Any implication of tax will be on supplier's account. For this it is desirable that vendor should reconcile the pending PO statement every month/frequently with BHEL. Vendor can also view these details at Portal (<https://trichy.bhel.com/mm/index.jsp>).

#### 10. Delivery Schedule

Supplies shall be affected and completed as per schedule mentioned in special terms and conditions. Commencement of delivery period shall be reckoned from the date of PO / LOI or any other agreed milestone.

#### 11. Liquidated Damaged (LD)

- Time is the essence of the contract.
- The ordered items shall be delivered as per the delivery period mentioned in the Purchase Order.
- In case the supplier supplies the ordered items beyond the delivery period specified, Liquidated Damages -LD - as detailed below shall be will be levied from the supplier without prejudice to any other relief /compensation available to BHEL, Punjab under any other condition of the contract/applicable legal provisions.
- Failure to dispatch the materials in the time as per the delivery mentioned in our Purchase Order (PO) would make the supplier liable to an un-conditional LD at the rate of 0.5% of the undelivered order value per week of the delay or part thereof subject to a maximum of 10% of the undelivered order value.
- Any deviation from the above LD clause, loading will be applied to the extent to which it is not agreed by the bidder (at offered value).
- Indigenous: In case of Ex-works delivery terms, the document date (Invoice/Challan date) in Goods Receipt (GR) document shall be reckoned for LD deduction. In case of FOR Delivery terms, the posting date in GR document shall be reckoned for LD deduction.
- Import: For CFR terms, BL date will be considered for LD calculation.

BHEL reserves the right to receive or not receive the material after the due date of PO. Applicable GST shall also be recovered from suppliers/contractors on LD amount. For this Debit note will be issued by BHEL indicating the respective supply invoice number.

#### 12. Acceptance of Material Supplied

- The supply shall strictly as per the specifications in the tender /purchase order.
- Delivery of the ordered items as per the delivery terms in the Purchase Order does not automatically constitute acceptance of the delivered items.
- Acceptance of the materials supplied will be based on the inspection and certification documents by the supplier as stipulated in the Purchase order. However, BHEL reserves the right to test the

Signature Not Verified

Signed By: RAKESH

KUMAR

Location: BHEL, Goindwal

Signing Date: 05.04.2023





## General Conditions of Contract (GCC) of MM Tenders

### BHARAT HEAVY ELECTRICALS LIMITED

Industrial Valve Plant: 433, Industrial Complex,  
Goindwal Sahib, Dist. Tarn Taran,  
Punjab-143422 (INDIA)

material supplied, if required, at BHEL Lab or any other approved/accredited lab and the result will be binding on the supplier.

4. The acceptance or otherwise of the delivered items will be separately communicated to the supplier by BHEL through B2B portal within 15 days from the delivery of items or delivery of the required test certificates /other documents whichever is later.
5. In case of rejection of the delivered items, either part or full, the vendor shall replace the rejected items as per the specification in the Purchase order/tender at their cost within 30 days of communication of rejection to the supplier. The supplier shall be given maximum two opportunities to replace the rejected items.
6. After the clearance of the 1st lot, in case of rejection of the delivered items, either part or full, if the supplier fails to replace the rejected items within 30 days of communication of the rejection, the same shall be treated as failure to execute the contract and actions as per the Guidelines for Suspension of Business Dealings with Suppliers /Contractors available in the webpage: <https://www.bhel.com> would be taken against such supplier.

### 13. Payment Terms

1. Payments shall be made to the Seller within the mentioned days (as per below table) from the date of receipt and acceptance of material.

Type of Bidder	Payment Terms (Number of days)
Micro & Small Enterprises (MSEs)	45 days
Medium Enterprises	60 days
Non MSME	90 days

To be considered as Micro, Small or Medium enterprise, bidder must be manufacturer of offer product and relevant valid certificate as per latest MSME guidelines is to be submitted along with bid.

**MSME bidders can avail benefits of payment through TReDS (Trade Receivable e Discounting System).**

In case of any deviation from standard payment term mentioned above, BHEL shall load on the item price at 'Base rate of SBI (as applicable on the date of bid opening; Techno-commercial bid opening) + 6% for the period of relaxation sought by bidders.

2. Documents to be submitted (if applicable)
  - i) Tax invoice (Invoice shall be GST compliant and should contains all the required information such as GST No, HSN code etc.)
  - ii) Transporter copy along with material/consignment.
  - iii) Material Test Certificates (MTC) and
  - iv) Compliance Certificate.
3. GST registration number is to be submitted by qualified vendor as per GST law.
4. It is mandatory to mention proper material codes in the invoices and separate invoices to be raised for different POs.
5. **BHEL releases payment through EFT mode ONLY. Necessary details may please be submitted by filling required format before release of payment.**





## General Conditions of Contract (GCC) of MM Tenders

**BHARAT HEAVY ELECTRICALS LIMITED**

Industrial Valve Plant: 433, Industrial Complex,  
Goindwal Sahib, Dist. Tarn Taran,  
Punjab-143422 (INDIA)

### 14. Taxes & Duties

Payment of GST portion will be released to vendor only upon completion of statutory requirement and further subject to following:

- Vendor declaring such invoice in his GSTR-1 and
- Receipt of goods and Tax invoice by BHEL and
- Confirmation of payment of GST thereon by vendor on GSTN portal.
- Above is subject to receipt of goods/service and tax invoice thereof along with vendor declaring invoice in his return and paying GST within timeline prescribed for availing ITC by BHEL.

Following may please be noted for availing Input Tax Credit (ITC) by BHEL:

- Since ITC can be availed only when BHEL is in possession of GST Tax invoice and after receipt of goods. Thus, vendor to ensure timely dispatch of goods and Tax invoice. It may be noted that in case of any delay in receipt of Tax Invoice and/or receipt of goods, the ITC availment by BHEL will get delayed thus entailing additional cash outflow & may even get denied if ITC availment timelines are breached.
- Further ITC can be availed only when vendor has declared such invoice in his outward supply Return GSTR-1 and after GST thereon has been paid by him at the time of filing of monthly Return.
- If GST credit is delayed/denied to BHEL due to non/delayed receipt of goods and/or tax invoice or expiry of timeline prescribed in GST law for availing such ITC, or any other reasons not attributable to BHEL, GST amount shall be recoverable from vendor along with interest levied/leviable on BHEL.
- Further, in case vendor delays declaring such invoice in his return and GST credit availed by BHEL is denied or reversed subsequently as per GST law, GST amount paid by BHEL towards such ITC reversal as per GST law shall be recoverable from vendor/contractor along with interest levied/leviable on BHEL.

### 15. Liability Under Reverse Charge (RCM)

Any GST liability arising on BHEL under Reverse Charge (RCM) before actual receipt of goods and/ or Invoice thereof would be subject to recovery of Interest leviable for the period between the date of such liability and actual date of eligibility of ITC based on receipt of goods, receipt of Invoices and other conditions specified in GST Law as applicable.

### 16. Access to Manufacturing Premises

While Purchase Orders placed on the vendor are under execution, authorized representatives of BHEL shall be allowed free access to the manufacturing facilities for the purpose of inspection or monitoring the progress of purchase orders. This access will also be extended to representatives of BHEL's customers accompanying the authorized representative/s of BHEL (which shall be intimated in advance), if our contractual requirements with our customers call for the same.

### 17. Inspection

- The seller shall give adequate notice, of 1 week or as mutually agreed period, in writing to the Purchaser about the date and place at which the goods will be ready for inspection/ testing, as provided for in the contract.





## General Conditions of Contract (GCC) of MM Tenders

### BHARAT HEAVY ELECTRICALS LIMITED

Industrial Valve Plant: 433, Industrial Complex,  
Goindwal Sahib, Dist. Tarn Taran,  
Punjab-143422 (INDIA)

2. Purchaser or his authorized representative shall be entitled to carry out inspection of material and workmanship/Surveillance Audit at Seller's premises or at his sub-contractor's premises at all reasonable times during execution of contract; Such inspection, examination and testing, if made, shall not absolve the Seller from his obligations under the contract. No additional charges shall be claimed for such inspections. Moreover, all required infrastructure (testing, tools etc) have to be arranged by supplier.
3. Any inspection carried out before supply by vendor/incoming stage at BHEL notwithstanding, if any defect/non-conformity is noted during processing, the same shall be attended/replaced by vendor at no extra cost.
4. BHEL representative from unit or CQ is authorized to carry out audits along with TPIA at vendor's works before clearing the items for dispatch.
5. Necessary tooling including thread gauges etc. have to be arranged by vendor. Only in exceptional cases, based on BHEL discretions item/nature, BHEL may consider request to provide gauges if available with BHEL. But in no case this shall be linked with delivery of material.

### 18. Warrantee and Corresponding Repair / Replacement of Goods

Goods shall comply with the specifications for material, workmanship and performance. Unless otherwise specified, vendor shall give a warrantee against design & manufacturing defects for a period of 18 months from the date of receipt. In case of non-acceptance of this term, bid shall be liable for rejection.

If the delivery is found non-compliant during the warranty period, leading to rejection, the Seller shall arrange free replacement / repair of goods, within one month from the date of intimation. Corresponding quantity shall be treated as unsupplied against respective purchase order till replacement is received at BHEL. In the event of the Seller's failure to comply, Purchaser may take action as appropriate, including repair / replenish rejected goods, at the risk & cost of the Seller.

All incidental charges like freight, insurance and customs duty in respect of return of defective items are to vendor's account only. BHEL will inform related invoice, quantity etc. to supplier. Supplier has to give advance intimation / plan (Transporter, Vehicle details) for the lifting of material. Further supplier has to provide requisite documents (such as Credit Note, e-Way Bill etc.) to lift the rejected material. Material should be lifted within one month from date of intimation. After one-month, BHEL will not be responsible for rejected material and BHEL shall have the right to dispose off such rejected material.

The defective parts and components shall be collected by your Indian agent or / authorized person, only after completing the replacement / repairs. If the supplier fails to replace / rectify the defective/ damaged items on free of cost within one month of reporting from our end, the same shall be treated as failure to execute the contract and actions as per the Guidelines for Suspension of Business Dealings with Suppliers /Contractors available in the webpage: <https://www.bhel.com> would be taken against such supplier without prejudice to the other remedies available to BHEL under the contract and law in this regard.





## General Conditions of Contract (GCC) of MM Tenders

**BHARAT HEAVY ELECTRICALS LIMITED**

Industrial Valve Plant: 433, Industrial Complex,  
Goindwal Sahib, Dist. Tarn Taran,  
Punjab-143422 (INDIA)

### 19. LOI (Letter of Intent)

BHEL may issue LOI prior to the PO for any reason whatsoever. The LOI in such cases is to be treated as PO for all practical purposes and all the Terms & Conditions of the tender shall be applicable from the date of issue of LOI.

### 20. Sub-Contract

The purchase order or any part thereof shall not be sub-contracted, assigned or otherwise transferred without previously obtaining the BHEL's consent in writing.

### 21. Risk Purchase

1. In the event of any successful Tenderer's failure to fulfil any of the tender / Contract obligations including supply of whole or any part of the ordered items as per Contract / Agreement, BHEL has the right to terminate the contract and purchase from elsewhere, at the risk and cost of the defaulted supplier, either the whole of the goods or any part which the supplier has failed to deliver or dispatch within the time stipulated in the contract or if the same were not available, the best and nearest available substitute thereof. The supplier shall be liable for the additional expenditure/difference in Cost, if any, including consequential losses which BHEL may sustain by reason of risk purchase in addition to the applicable LD as per the Purchase order/contract.
2. The decision of BHEL with regard to the additional expenditure / difference in cost and consequential losses incurred by BHEL shall be final and binding on the supplier.
3. The amount recoverable under risk purchase shall be recovered from the defaulted supplier in all or any of the following manners:
  - from dues available in the form of Bills payable to defaulted supplier, SD, BGs against the same contract.
  - from the dues payable to defaulted supplier against other contracts in the same Region/Unit /any other region/unit. In-case recoveries are not possible with any of the above available options, Legal action shall be initiated for recovery against defaulted supplier.

### 22. Force Majeure

1. Notwithstanding the provisions contained in other clauses, the supplier shall not be liable for imposition of any such sanction so long the delay and/or failure of the supplier in fulfilling its obligations under the contract is the result of an event of Force Majeure. For purposes of this clause, Force Majeure means an event beyond the control of the supplier and not involving the supplier's fault or negligence and which is not foreseeable and not brought about at the instance of the party claiming to be affected by such event and which has caused the non – performance or delay in performance. Such events may include, but are not restricted to, wars or revolutions, hostility, acts of public enemy, civil commotion, sabotage, fires, floods, explosions, epidemics, quarantine restrictions, strikes excluding by its employees, lockouts excluding by its management, freight embargoes and Acts of GOD.
2. If a Force Majeure situation arises, the supplier shall promptly notify the Purchaser/Consignee in writing of such conditions and the cause thereof within twenty-one days of occurrence of such event. Unless otherwise directed by the Purchaser/Consignee in writing, the supplier shall continue to perform its obligations under the contract as far as reasonably practical, and shall seek all reasonable alternative means for performance not prevented by the Force Majeure event.

Signature Not Verified

Signed By: RAKESH

KUMAR

Location: BHEL, Goindwal

Signing Date: 05.04.2023





## General Conditions of Contract (GCC) of MM Tenders

### BHARAT HEAVY ELECTRICALS LIMITED

Industrial Valve Plant: 433, Industrial Complex,  
Goindwal Sahib, Dist. Tarn Taran,  
Punjab-143422 (INDIA)

3. If the performance in whole or in part or any obligation under this contract is prevented or delayed by any reason of Force Majeure for a period exceeding sixty days, either party may at its option terminate the contract without any financial repercussion on either side.
4. In case due to a Force Majeure event the Purchaser/Consignee is unable to fulfil its contractual commitment and responsibility, the Purchaser/Consignee will notify the supplier accordingly and subsequent actions taken on similar lines described in above sub-paragraphs.

### 23. Non-Disclosure Agreement

All Drawing and technical documents relating to the product or it's manufacture submitted by one party to the other, prior or subsequent to the formation of contract, shall remain property of the submitting party. Drawing, technical documents or other technical information received by one party, shall not without the consent of the other party, be used for any other purpose than that, for which they were provided. Such technical information shall not without the consent of the submitting party, otherwise be used or copied, reproduced, transmitted or communicated to a third party. Patterns supplied by BHEL will remain BHEL's property which shall be returned by the bidder on demand to BHEL. Bidder shall in no way share or use such intellectual property of BHEL to promote his own business with others. ***BHEL reserves the right to claim damages from the bidder, or take appropriate penal action as deemed fit against the bidder, for any infringement of the provisions contained herein.***

### 24. Clarifications

The correspondence exchanged against the tender from both tenderer and BHEL through email/e-procurement are considered as valid document legally though it is not signed. It is treated as valid confirmations made on behalf of the respective company and very much comes under the legal ambit of the business transaction and hence it is binding on both the parties to the business. Any transaction pertaining to the tender from both the parties of business done round the clock irrespective of the office or business hours of the companies, are valid legally and binding on both the parties. This applies to the extent only in such cases where deadline time for transaction is not specifically declared by either or both the parties to the business.

### 25. Preferences for Micro and Small Enterprises (MSEs)

Preferences as mentioned in “Public Procurement Policy for Micro and Small Enterprises (MSEs) Order, 2012” & “Public Procurement Policy for Micro and Small Enterprises (MSEs) Amendment Order, 2018”, or as per latest guidelines issued by government shall be given to Micro and Small enterprises.

Main points which are mentioned in the above orders are as follows:

- 25% Procurement of the tender value shall be made from MSE (Micro, Small Enterprises) firms.
- 25% of the 25% quantity (i.e. 6.25% of the tender quantity) offered to the MSE's shall be reserved for MSE's owned by SC/STs. Failure to participate by any MSE owned by SC/ST's; this 6.25% quantity shall be procured from other MSEs.





## General Conditions of Contract (GCC) of MM Tenders

### BHARAT HEAVY ELECTRICALS LIMITED

Industrial Valve Plant: 433, Industrial Complex,  
Goindwal Sahib, Dist. Tarn Taran,  
Punjab-143422 (INDIA)

- 3% from within the 25% quantity offered to the MSE's shall be reserved for women owned MSE's. Failure to participate by any MSE owned by women; this 3% quantity shall be procured from other MSEs.
- EMD shall be exempted for MSE's. All these benefits are subject to production of all statutory documents
- In tender, participating Micro and Small Enterprises quoting price within price band of L1+15 per cent shall also be allowed to supply a portion of requirement by bringing down their price to L1 price in a situation where L1 price is from someone other than a Micro and Small Enterprise and such Micro and Small Enterprise shall be allowed to supply up to 25 per cent of total tendered value. In case of more than one such Micro and Small Enterprise, the supply shall be shared proportionately (to tendered quantity).

MSE suppliers can avail the intended benefits only if they submit **Udyam Registration Certificate** along with the offer. No other document shall be considered for availing MSE benefits. Non-submission of such document will lead to consideration of their bid at par with other bidders. No benefit shall be applicable for this enquiry if any deficiency in the above required documents is not cleared before price bid opening. If the tender is to be submitted through e-procurement portal, then the above required document is to be uploaded on the portal.

*Note: It may however be noted that MSE guidelines as on date (Date of Technical Bid Opening Part-1) shall prevail.*

## 26. Preference to Make in India

This procurement shall be governed by notification no. P-45021/2/2017-PP (BE-II) dated 16.09.2020 of Government of India issued by DPIIT and subsequent circulars issued afterwards. Accordingly, the minimum local content, the margin of purchase preference and the procedure for purchase preference to make in India shall be adhered.

## 27. Restrictions Under Rule 144(XI) of The General Financial Rules (GFR), 2017

All provisions of Order No. F.No.6/18/2019-PPD of Department of Expenditure (DoE) shall be applicable for this tender enquiry (Order copy is available at <https://doe.gov.in/procurementpolicy-divisions>). Accordingly, any bidder from a country which shares a land border with India (except the countries to which the Govt. of India has extended lines of credit or in which the Govt. of India is engaged in development projects for which list is available at <https://www.mea.gov.in/>) will be eligible to bid in this tender only if the bidder is registered with the Competent Authority as specified in Annex I of the said Order of DoE.

Updated list of the countries to which lines of credit have been extended or in which development projects are undertaken are available on the Ministry of External affairs website (<https://www.mea.gov.in/>)

For the purpose of this order, definition of Bidder from a country which shares a land border with India shall be same as defined in the Annex III of the said order.





## General Conditions of Contract (GCC) of MM Tenders

### BHARAT HEAVY ELECTRICALS LIMITED

Industrial Valve Plant: 433, Industrial Complex,  
Goindwal Sahib, Dist. Tarn Taran,  
Punjab-143422 (INDIA)

Registration with the competent authority as stipulated in the said order is responsibility of bidder.  
**Bidder has to submit a certificate certifying following along with offer:**

"I have read the clause regarding restrictions on procurement from a bidder of a country which shares a land border with India; I certify that this bidder is not from such a country or, if from such a country, has been registered with the Competent Authority. I hereby certify that this bidder fulfils all requirements in this regard and is eligible to be considered. [*Where applicable, evidence of valid registration by the Competent Authority shall be Attached*]."

### 28. Resolution of Disputes

The Parties agree that if at any time (whether before, during or after the arbitral or judicial proceedings), any Disputes (which term shall mean and include any dispute, difference, question or disagreement arising in connection with construction, meaning, operation, effect, interpretation or breach of the contract/tender which the Parties are unable to settle mutually), arise inter-se the Parties, the same may, be referred by either party to Conciliation to be conducted through Independent Experts Committee to be appointed by competent authority of BHEL from the BHEL Panel of Conciliators.

Notes:

1. No serving or a retired employee of BHEL/Administrative Ministry of BHEL shall be included in the BHEL Panel of Conciliators.
2. Any other person(s) can be appointed as Conciliator(s) who is/are mutually agreeable to both the parties from outside the BHEL Panel of Conciliators.

The proceedings of Conciliation shall broadly be governed by Part-III of the Arbitration and Conciliation Act 1996 or any statutory modification thereof and as provided in Annexure-X to this GCC.

The Annexure-X together with its appendices will be treated as if the same is part and parcel hereof and shall be as effectual as if set out herein in this GCC.

Except as provided elsewhere in this Contract, in case amicable settlement is not reached between the parties, in respect of any dispute or difference; arising out of the formation, breach, termination, validity or execution of the Contract; or, the respective rights and liabilities of the Parties; or, in relation to interpretation of any provision of the Contract; or, in any manner touching upon the Contract, then, either Party may, by a notice in writing to other Party, refer such dispute or difference to sole arbitration of an arbitrator appointed as per the Arbitration and Conciliation Act, 1996 (India) or statutory modification or re-enactment thereof and the rules made thereunder and for the time being in force.

The Arbitrator shall pass a reasoned award and the award of the Arbitrator shall be final and binding upon the parties.

This contract shall be governed, construed and interpreted in accordance with the laws of India.





## General Conditions of Contract (GCC) of MM Tenders

**BHARAT HEAVY ELECTRICALS LIMITED**

Industrial Valve Plant: 433, Industrial Complex,  
Goindwal Sahib, Dist. Tarn Taran,  
Punjab-143422 (INDIA)

Subject as aforesaid, the provisions of Arbitration & Conciliation Act 1996 (India) or statutory modification or re-enactment thereof and the rules made thereunder and for the time being in force shall apply to the arbitration proceeding under this clause.

The seat of arbitration shall be Tarn Taran, Punjab, India.

The cost of arbitration shall be borne as per the award of the Arbitrator.

Subject to arbitration in terms of clause above, the Courts at Tarn Taran, Punjab, India shall have exclusive jurisdiction over any matter arising out of or in connection with this Contract.

Notwithstanding the existence or any dispute or difference and/or reference for the arbitration, the vendor/contractor shall proceed with and continue without hindrance the performance of its obligation under this Contract with due diligence and expedition in a professional manner except where the Contract has been terminated by either Party in terms of this Contract.

### **In Case of Contract with Public Sector Enterprise (PSE) or a Government Department, the following shall be applicable:**

In the event of any dispute or difference relating to the interpretation and application of the provisions of commercial contract(s) between Central Public Sector Enterprises (CPSEs)/Port Trusts inter se and also between CPSEs and Government Departments/Organizations (Excluding disputes concerning Railways, Income Tax, Customs & Excise Departments, such dispute or difference shall be taken up by either party for its resolution through AMRCD as mentioned in DPE OM No.05/003/2019-FTS-10937 dated 14<sup>th</sup> December, 2022 and the decision of AMRCD on the said dispute will be binding on both the parties.”

Set off : BHEL shall have the right to recover any money which in the sole opinion of BHEL is due from the supplier from any money due to the supplier under this Contract or any other contract or from the Security Deposit/BG furnished by the supplier under this Contract or any other contract.

### **29. Fraud Prevention Policy**

The Bidder along with its associate / collaborators / sub-contractors / sub-vendors / consultants / service providers shall strictly adhere to BHEL Fraud Prevention Policy displayed on BHEL website <https://www.bhel.com/> and shall immediately bring to the notice of BHEL management about any fraud or suspected fraud as soon as it comes to their notice.

### **30. Preventive Checks to Eliminate Suspected Cartel Formation**

The Bidder declares that they will not enter into any illegal or undisclosed agreement or understanding, whether formal or informal with other Bidder(s). This applies in particular to prices, specifications, certifications, subsidiary contracts, submission or non-submission of bids or any other actions to restrict competitiveness or to introduce cartelization in the bidding process.





## General Conditions of Contract (GCC) of MM Tenders

### BHARAT HEAVY ELECTRICALS LIMITED

Industrial Valve Plant: 433, Industrial Complex,  
Goindwal Sahib, Dist. Tarn Taran,  
Punjab-143422 (INDIA)

In case, the Bidder is found having indulged in above activities, suitable action shall be taken by BHEL as per extant policies/ guidelines.

### 31. Suspension of Business Dealings with Suppliers / Contractors

The offers of the bidders who are under suspension as also the offers of the bidders, who engage the services of the firms debarred across BHEL, shall be rejected. The list of firms debarred across BHEL is available on BHEL web site <https://www.bhel.com/>.

### INTEGRITY COMMITMENT, PERFORMANCE OF THE CONTRACT AND PUNITIVE ACTION THEREOF:

#### 31.1. Commitment by BHEL:

BHEL commits to take all measures necessary to prevent corruption in connection with the tender process and execution of the contract. BHEL will during the tender process treat all Bidder(s) in a transparent and fair manner, and with equity.

#### 31.2. Commitment by Bidder/ Supplier/ Contractor:

31.2.1. The bidder/ supplier/ contractor commits to take all measures to prevent corruption and will not directly or indirectly influence any decision or benefit which he is not legally entitled to nor will act or omit in any manner which tantamount to an offence punishable under any provision of the Indian Penal Code, 1860 or any other law in force in India.

31.2.2. The bidder/ supplier/ contractor will, when presenting his bid, disclose any and all payments he has made, and is committed to or intends to make to agents, brokers or any other intermediaries in connection with the award of the contract and shall adhere to relevant guidelines issued from time to time by Govt. of India/ BHEL.

31.2.3. The bidder/ supplier/ contractor will perform/ execute the contract as per the contract terms & conditions and will not default without any reasonable cause, which causes loss of business/ money/ reputation, to BHEL.

If any bidder/ supplier/ contractor during pre-tendering/ tendering/ post tendering/ award/ execution/ post-execution stage indulges in mal-practices, cheating, bribery, fraud or and other misconduct or formation of cartel so as to influence the bidding process or influence the price or acts or omits in any manner which tantamount to an offence punishable under any provision of the Indian Penal Code, 1860 or any other law in force in India, then, action may be taken against such bidder/ supplier/ contractor as per extant guidelines of the company available on <https://www.bhel.com/> and/or under applicable legal provisions

### 32. General

1. BHEL will not be bound by any power of attorney granted by the vendors or by changes in the composition of the firm made subsequent to the execution of the contract. They may, however,





## General Conditions of Contract (GCC) of MM Tenders

### BHARAT HEAVY ELECTRICALS LIMITED

Industrial Valve Plant: 433, Industrial Complex,  
Goindwal Sahib, Dist. Tarn Taran,  
Punjab-143422 (INDIA)

- recognize such power of attorney and changes after obtaining proper legal advice, the cost of which will be chargeable to the vendor concerned.
2. BHEL reserves the right to extend the due date of opening, which shall be informed. Validity of offer shall be deemed to be revised accordingly.
  3. BHEL reserves the right to accept or reject any part or whole of the tender of a bidder by assigning a valid reason thereof. BHEL reserves the right to cancel the tender without assigning any reason thereof and without any obligation before any commitment.
  4. Acceptance of all terms and conditions, in the form of signed copy of T&C or confirmation separately written, shall be submitted along with quotation. If nothing is mentioned, it shall be concluded that these terms and conditions are acceptable.
  5. BHEL may increase/decrease item/s based on BHEL requirement before price bid opening. Suitable price implication may be asked from suppliers.
  6. BHEL may drop item/items from tender at any stage of tender before placing PO. BHEL may also delete PO with consent with supplier within delivery date of PO.
  7. After releasing PO, it is assumed that supplier has accepted PO if we do not receive acknowledgement from supplier within 5 days of date of PO.
  8. In case of unscheduled holiday on opening day of tender, the next working day will be treated as scheduled prescribed day of opening of tender.
  9. On the due date of tender opening, only technical bids will be opened. The opened technical bids will be evaluated by us and clarifications required, if any, will be called for from the bidders on technical and commercial points. If no reply is received from the vendor for the clarification raised by BHEL within the final cut-off date, those vendors offer will be processed with the documents available / submitted against this tender. Offers not meeting the required specification and technical condition will be summarily rejected. The price bids of technically suitable bidders will be opened on a later date with prior intimation to techno-commercially suitable bidders.
  10. Ranking L-1, L-2 etc. shall be done for individual item for the techno-commercially acceptable offers on landed cost to BHEL, IVP Goindwal basis and BHEL reserves the right to place order for individual items with different vendors.
  11. BHEL reserves the right to negotiate with L1 vendor or re-float the tender for items where, L1 price is not the lowest acceptable price; BHEL reserves the right to increase or decrease the tender quantity.
  12. If supplier is mentioning delivery destination within state/ outside state depending upon his location of factory, Free on Road etc. these are assumed as on FOR Goindwal. If supplier is wishing to give delivery on Ex works basis, then he has to clearly mention about it.
  13. The bidder has to keep track of any changes by viewing the addendum(s) / Corrigendum(s) issued by the Purchaser on time-to- time basis in the E-Procurement platform. The Company calling for tenders shall not be responsible for any claims/problems arising out of this.
  14. Unregistered suppliers, who are techno-commercially qualified against the open tender, are requested to register with BHEL as permanent supplier by submitting the Supplier Registration Form (SRF) in online supplier registration portal (<https://supplier.bhel.in/>).
  15. The General Conditions of Contract and the Special Conditions in each enquiry and the resulting purchase order constitute the entire contract between the parties. In case of any discrepancy between the provisions of General Conditions of Contract and Special Conditions of the Tender,

Signature Not Verified

Signed By: RAKESH  
KUMAR  
Location: BHEL, Goindwal  
Signing Date: 05.04.2023





**General Conditions of Contract (GCC) of MM Tenders**  
**BHARAT HEAVY ELECTRICALS LIMITED**

Industrial Valve Plant: 433, Industrial Complex,  
Goindwal Sahib, Dist. Tarn Taran,  
Punjab-143422 (INDIA)

the provisions in Special Conditions of the Tender shall prevail and interpretation of BHEL of such condition/clause will be final and binding on both the parties ..





## General Conditions of Contract (GCC) of MM Tenders

**BHARAT HEAVY ELECTRICALS LIMITED**

Industrial Valve Plant: 433, Industrial Complex,  
Goindwal Sahib, Dist. Tarn Taran,  
Punjab-143422 (INDIA)

### Annexure-X

#### **BRIEF PROCEDURE FOR CONDUCT OF CONCILIATION PROCEEDINGS**

1. The proceedings of Conciliation shall broadly be governed by Part-III of the Arbitration and Conciliation Act 1996 or any statutory modification thereof and as provided herein:
2. The party desirous of resorting to Conciliation shall send an invitation/notice in writing to the other party to conciliate specifying all points of Disputes with details of the amount claimed. The party concerned shall not raise any new issue thereafter. Parties shall also not claim any interest on claims/counter-claims from the date of notice invoking Conciliation till the conclusion of the Conciliation proceedings.
3. The party receiving the invitation/notice for Conciliation shall within 30 days of receipt of the notice of Conciliation intimate its consent for Conciliation along with its counter-claims, if any.
4. The Conciliation in a matter involving claim or counter-claim (whichever is higher) up to Rs 5 crores shall be carried out by sole Conciliator nominated by BHEL while in a matter involving claim or counter-claim (whichever is higher) of more than Rs 5 crores Conciliation shall be carried out by 3 Conciliators nominated by BHEL.
5. The Parties shall be represented by only their duly authorized in-house executives/officers and neither Party shall be represented by a Lawyer.
6. The first meeting of the IEC shall be convened by the IEC by sending appropriate communication/notice to both the parties as soon as possible but not later than 30 days from the date of his/their appointment. The hearings in the Conciliation proceeding shall ordinarily be concluded within two (2) months and, in exceptional cases where parties have expressed willingness to settle the matter or there exists possibility of settlement in the matter, the proceedings may be extended by the IEC by a maximum of further 2 months with the consent of the Parties subject to cogent reasons being recorded in writing.
7. The IEC shall thereafter formulate recommendations for settlement of the Disputes supported by reasons at the earliest but in any case, within 15 days from the date of conclusion of the last hearing. The recommendations so formulated along with the reasons shall be furnished by the IEC to both the Parties at the earliest but in any case, within 1 month from the date of conclusion of the last hearing.
8. Response/modifications/suggestions of the Parties on the recommendations of the IEC are to be submitted to the IEC within time limit stipulated by the IEC but not more than 15 days from the date of receipt of the recommendations from the IEC.
9. In the event, upon consideration, further review of the recommendations is considered necessary, whether by BHEL or by the other Party, then, the matter can be remitted back to the IEC with

Signature Not Verified  
Signed By: RAKESH  
KUMAR  
Location: BHEL, Goindwal  
Signing Date: 05.04.2023





## General Conditions of Contract (GCC) of MM Tenders

### BHARAT HEAVY ELECTRICALS LIMITED

Industrial Valve Plant: 433, Industrial Complex,  
Goindwal Sahib, Dist. Tarn Taran,  
Punjab-143422 (INDIA)

request to reconsider the same in light of the issues projected by either/both the Parties and to submit its recommendations thereon within the following 15 days from the date of remitting of the case by either of the Parties.

10. Upon the recommendations by the Parties, with or without modifications, as considered necessary, the IEC shall be called upon to draw up the Draft Settlement Agreement in terms of the recommendations.
11. When a consensus can be arrived at between the parties only in regard to any one or some of the issues referred for Conciliation the draft Settlement Agreement shall be accordingly formulated in regard to the said Issue(s), and the said Settlement Agreement, if signed, by the parties, shall be valid only for the said issues. As regards the balance issues not settled, the parties may seek to resolve them further as per terms and conditions provided in the contract.
12. In case no settlement can be reached between the parties, the IEC shall by a written declaration, pronounce that the Conciliation between the parties has failed and is accordingly terminated.
13. Unless the Conciliation proceedings are terminated in terms of para 22 (b), (c) & (d) herein below, the IEC shall forward his/its recommendations as to possible terms of settlement within one (1) month from the date of last hearing. The date of first hearing of Conciliation shall be the starting date for calculating the period of 2 months.
14. In case of 3 members IEC, 2 members of IEC present will constitute a valid quorum for IEC and meeting can take place to proceed in the matter after seeking consent from the member who is not available. If necessary, videoconferencing may be arranged for facilitating participation of the members. However, the IEC recommendations will be signed by all members. Where there is more than one (1) Conciliator, as a general rule they shall act jointly. In the event of differences between the Members of IEC, the decision/recommendations of the majority of the Members of IEC shall prevail and be construed as the recommendation of the IEC.
15. The Draft Settlement Agreement prepared by the IEC in terms of the consensus arrived at during the Conciliation proceedings between the Parties shall be given by the IEC to both the parties for putting up for approval of their respective Competent Authority.
16. Before submitting the draft settlement agreement to BHEL's Competent Authority viz. the Board Level Committee on Alternative Dispute Resolution (BLCADR) for approval, concurrence of the other party's Competent Authority to the draft settlement agreement shall be obtained by the other party and informed to BHEL within 15 days of receipt of the final draft settlement agreement by it. Upon approval by the Competent Authority, the Settlement Agreement would thereafter be signed by the authorized representatives of both the Parties and authenticated by the members of the IEC.
17. In case the Draft Settlement Agreement is rejected by the Competent Authority of BHEL or the other Party, the Conciliation proceedings would stand terminated.





## General Conditions of Contract (GCC) of MM Tenders

### BHARAT HEAVY ELECTRICALS LIMITED

Industrial Valve Plant: 433, Industrial Complex,  
Goindwal Sahib, Dist. Tarn Taran,  
Punjab-143422 (INDIA)

18. A Settlement Agreement shall contain a statement to the effect that each of the person(s) signing thereto (i) is fully authorized by the respective Party(ies) he/she represents, (ii) has fully understood the contents of the same and (iii) is signing on the same out of complete freewill and consent, without any pressure, undue influence.
19. The Settlement Agreement shall thereafter have the same legal status and effect as an arbitration award on agreed terms on the substance of the dispute rendered by an arbitral tribunal passed under section 30 of the Arbitration and Conciliation Act, 1996.
20. Acceptance of the Draft Settlement Agreement/recommendations of the Conciliator and/or signing of the Settlement Agreement by BHEL shall however, be subject to withdrawal/closure of any arbitral and/or judicial proceedings initiated by the concerned Party in regard to such settled issues.
21. Unless otherwise provided for in the agreement, contract or the Memorandum of Understanding, as the case may be, in the event of likelihood of prolonged absence of the Conciliator or any member of IEC, for any reason/incapacity, the Competent Authority/Head of Unit/Division/Region/Business Group of BHEL may substitute the Conciliator or such member at any stage of the proceedings. Upon appointment of the substitute Conciliator(s), such reconstituted IEC may, with the consent of the Parties, proceed with further Conciliation into the matter either de-novo or from the stage already reached by the previous IEC before the substitution.
22. The proceedings of Conciliation under this Scheme may be terminated as follows:
- On the date of signing of the Settlement agreement by the Parties; or,
  - By a written declaration of the IEC, after consultation with the parties, to the effect that further efforts at conciliation are no longer justified, on the date of the declaration; or,
  - By a written declaration of the Parties addressed to the IEC to the effect that the Conciliation proceedings are terminated, on the date of the declaration; or,
  - By a written declaration of a Party to the other Party and the IEC, if appointed, to the effect that the Conciliation proceedings are terminated, on the date of the declaration.
  - On rejection of the Draft Settlement Agreement by the Competent Authority of BHEL or the other Party.





## General Conditions of Contract (GCC) of MM Tenders BHARAT HEAVY ELECTRICALS LIMITED

Industrial Valve Plant: 433, Industrial Complex,  
Goindwal Sahib, Dist. Tarn Taran,  
Punjab-143422 (INDIA)

23. The Conciliator(s) shall be entitled to following fees and facilities:

Sr. No.	Particulars	Amount
1	Sitting fees	Each Member shall be paid a Lump Sum fee of Rs 75,000/- for the whole case payable in terms of paragraph No. 27 herein below.
2	Towards drafting of settlement agreement	<p>In cases involving claim and/or counter-claim of up to Rs 5crores. Rs 50,000/- (Sole Conciliator)</p> <p>In cases involving claim and/or counter-claim of exceeding Rs 5 crores but less than Rs 10 crores. Rs. 75,000 (per Conciliator)</p> <p>In cases involving claim and/or counter-claim of more than Rs 10 crores. Rs 1,00,000/- (per Conciliator)</p> <p>Note: The aforesaid fees for the drafting of the Settlement Agreement shall be paid on Signing of the Settlement Agreement after approval of the Competent Authority or Rejection of the proposed Settlement Agreement by the Competent Authority of BHEL.</p>
3	Secretarial expenses	<p>Rs 10,000/- (one time) for the whole case for Conciliation by a Sole Member IEC.</p> <p>Where Conciliation is by multi member Conciliators –Rs 30,000/- (one time)- to be paid to the IEC</p>
4	Travel and transportation and stay at outstation	As per entitlement of the equivalent officer (pay scale wise) in BHEL.
	<p>i Retired Senior Officials of other Public Sector Undertakings (pay scale wise equivalent to or more than E-8 level of BHEL)</p> <p>Others</p>	
		As per the extant entitlement of whole time Functional Directors in BHEL.

Signature Not Verified

Signed By: RAKESH

KUMAR

Location: BHEL, Goindwal

Signing Date: 05.04.2023





## General Conditions of Contract (GCC) of MM Tenders BHARAT HEAVY ELECTRICALS LIMITED

Industrial Valve Plant: 433, Industrial Complex,  
Goindwal Sahib, Dist. Tarn Taran,  
Punjab-143422 (INDIA)

5	Venue for meeting	Unless otherwise agreed in the agreement, contract or the Memorandum of Understanding, as the case may be, the venue/seat of proceedings shall be the location of the concerned Unit / Division / Region / Business Group of BHEL. Without prejudice to the seat/venue of the Conciliation being at the location of concerned BHEL Unit / Division / Region / Business Group, the IEC after consulting the Parties may decide to hold the proceedings at any other place/venue to facilitate the proceedings. Unless, Parties agree to conduct Conciliation at BHEL premises, the venue is to be arranged by either Party alternately.
---	-------------------	--

24. The parties will bear their own costs including cost of presenting their cases/evidence/witness(es)/expert(s) on their behalf. The parties agree to rely upon documentary evidence in support of their claims and not to bring any oral evidence in IEC proceedings.

25. If any witness(es) or expert(s) is/are, with the consent of the parties, called upon to appear at the instance of the IEC in connection with the matter, then, the costs towards such witness(es)/expert(s) shall be determined by the IEC with the consent of the Parties and the cost so determined shall be borne equally by the Parties.

26. The other expenditures/costs in connection with the Conciliation proceedings as well as the IEC's fees and expenses shall be shared by the Parties equally.

27. Out of the lump sum fees of Rs 75,000/- for Sitting Fees, 50% shall be payable after the first meeting of the IEC and the remaining 50% of the Sitting Fees shall be payable only after termination of the conciliation proceedings in terms of para 22 hereinabove.

28. The travelling, transportation and stay at outstation shall be arranged by concerned Unit as per entitlements as per Serial No. 3 of the Table at para 23 above, and in case such arrangements are not made by the BHEL Unit, the same shall be reimbursed to the IEC on actuals limited to their entitlement as per Serial No. 4 of the Table at Para 23 above against supporting documents. The IEC Member(s) shall submit necessary invoice for claiming the fees/reimbursements.

29. The Parties shall keep confidential all matters relating to the conciliation proceedings. Confidentiality shall extend also to the settlement agreement, except where its disclosure is necessary for purposes of its implementation and enforcement or as required by or under a law or as per directions of a Court/Governmental authority/ regulatory body, as the case may be.

30. The Parties shall not rely upon or introduce as evidence in any further arbitral or judicial proceedings, whether or not such proceedings relate to the Disputes that is the subject of the Conciliation proceedings:

Signature Not Verified

Signed By: RAKESH

KUMAR

Location: BHEL, Goindwal

Signing Date: 05.04.2023





## General Conditions of Contract (GCC) of MM Tenders

### BHARAT HEAVY ELECTRICALS LIMITED

Industrial Valve Plant: 433, Industrial Complex,  
Goindwal Sahib, Dist. Tarn Taran,  
Punjab-143422 (INDIA)

- a. Views expressed or suggestions made by the other party in respect of a possible settlement of the Disputes;
- b. admissions made by the other party in the course of the Conciliator proceedings;
- c. proposals made by the Conciliator;
- d. The fact that the other Party had indicated his willingness to accept a proposal for settlement made by the Conciliator.

31. The Parties shall not present the Conciliator(s) as witness in any Alternative Dispute Resolution or Judicial proceedings in respect of a Disputes that is/was the subject of that particular Conciliation proceeding.

32. None of the Conciliators shall act as an arbitrator or as a representative or counsel of a Party in any arbitral or judicial proceeding in respect of a Disputes that is/was the subject of that particular Conciliation proceeding.

33. The Parties shall not initiate, during the Conciliation proceedings, any arbitral or judicial proceedings in respect of a Disputes that is the subject matter of the Conciliation proceedings except that a Party may initiate arbitral or judicial proceedings where, in his opinion, such proceedings are necessary for preserving his rights including for preventing expiry of period of limitation. Unless terminated as per the provisions of this Scheme, the Conciliation proceedings shall continue notwithstanding the commencement of the arbitral or judicial proceedings and the arbitral or judicial proceedings shall be primarily for the purpose of preserving rights including preventing expiry of period of limitation.

34. The official language of Conciliation proceedings under this Scheme shall be English unless the Parties agree to some other language.





## General Conditions of Contract (GCC) of MM Tenders

**BHARAT HEAVY ELECTRICALS LIMITED**

Industrial Valve Plant: 433, Industrial Complex,  
Goindwal Sahib, Dist. Tarn Taran,  
Punjab-143422 (INDIA)

### Appendix-I of Annexure-X

#### FORMAT FOR SEEKING CONSENT FOR REFERRING THE DISPUTES TO CONCILIATION THROUGH IEC

To,

M/s. (Stakeholder's name)

**Sub: Resolution of the Disputes through conciliation by Independent Expert Committee (IEC).**

Ref: Contract No/MoU/Agreement/LOI/LOA& date \_\_\_\_\_.

Sir,

With reference to above referred Contract/MoU/Agreement/LOI/LOA, you have raised certain Disputes/claims. Vide your letter dated\_\_\_\_ you have requested BHEL to refer the Disputes/claims to IEC for Conciliation.

We are enclosing herewith Format (3) for giving consent and the terms and conditions of BHEL Conciliation Scheme, 2018 governing conciliation through IEC. You are requested to give your unconditional consent to the said terms and conditions of the Scheme by returning the same duly sealed and signed on each page. On receipt of your consent, matter will be put to the Competent Authority for consideration and decision.

Please note that BHEL has also certain claims against you (if applicable). BHEL reserves its right to agree or not to agree conciliation of the said disputes through BHEL and this letter is being issued without prejudice to BHEL's rights and contentions available under the contract and law.

Yours faithfully,

**Representative of BHEL**





## General Conditions of Contract (GCC) of MM Tenders

**BHARAT HEAVY ELECTRICALS LIMITED**

Industrial Valve Plant: 433, Industrial Complex,  
Goindwal Sahib, Dist. Tarn Taran,  
Punjab-143422 (INDIA)

### Appendix-II of Annexure-X

#### FORMAT FOR GIVING CONSENT BY CONTRACTOR/VENDOR/CUSTOMER/COLLABORATOR/CONSORTI UM PARTNERS FOR REFERRING THE DISPUTES TO CONCILIATION THROUGH IEC

To,

BHEL

.....

**Sub: Resolution of Disputes through Conciliation by Independent Expert Committee (IEC).**

Ref: Contract/MoU/Agreement/LOI/LOA No

& date \_\_\_\_

With reference to above referred contract, our following bills/invoices/claims submitted to BHEL are still unpaid giving rise to Disputes:

SL. no.	Claim Description	Bill submitted to BHEL (no. and date)	Amount of the bill/claim	Amount received from BHEL	Outstanding Amount

Accordingly, we request you to kindly refer the Disputes in respect of above claims to IEC for Conciliation.

We hereby agree and give our unconditional consent to the terms and conditions of BHEL Conciliation Scheme, 2018 governing conciliation through IEC. We have signed the same on each page and enclosed it for your consideration.

Yours faithfully,

**(Signature with stamp)**

**Authorized Representative of Contractor  
Name, with designation Date**





## General Conditions of Contract (GCC) of MM Tenders

**BHARAT HEAVY ELECTRICALS LIMITED**

Industrial Valve Plant: 433, Industrial Complex,  
Goindwal Sahib, Dist. Tarn Taran,  
Punjab-143422 (INDIA)

### Appendix-III of Annexure-X

#### STATEMENT OF CLAIMS/COUNTER CLAIMS TO BE SUBMITTED TO THE IEC BY BOTH THE PARTIES

1. Chronology of the Disputes
2. Brief of the Contract/MoU/Agreement/LOI/LOA
3. Brief history of the Disputes:
4. Issues:
5. Details of Claim(s)/Counter Claim(s):

Sl. No.	Description of claim(s)/Counter Claim	Amount (in INR) Or currency applicable in the contract	Relevant contract clause

6. Basis/Ground of claim(s)/counter claim(s) (along with relevant clause of contract)

**Note**– The Statement of Claims/Counter Claims may ideally be restricted to maximum limit of 20 pages. Relevant documents may be compiled and submitted along with the statement of Claims/Counter Claims. The statement of Claims/Counter Claims is to be submitted to all IEC members and to the other party by post as well as by email.



DRAWING NO:  
3-35-700-09999

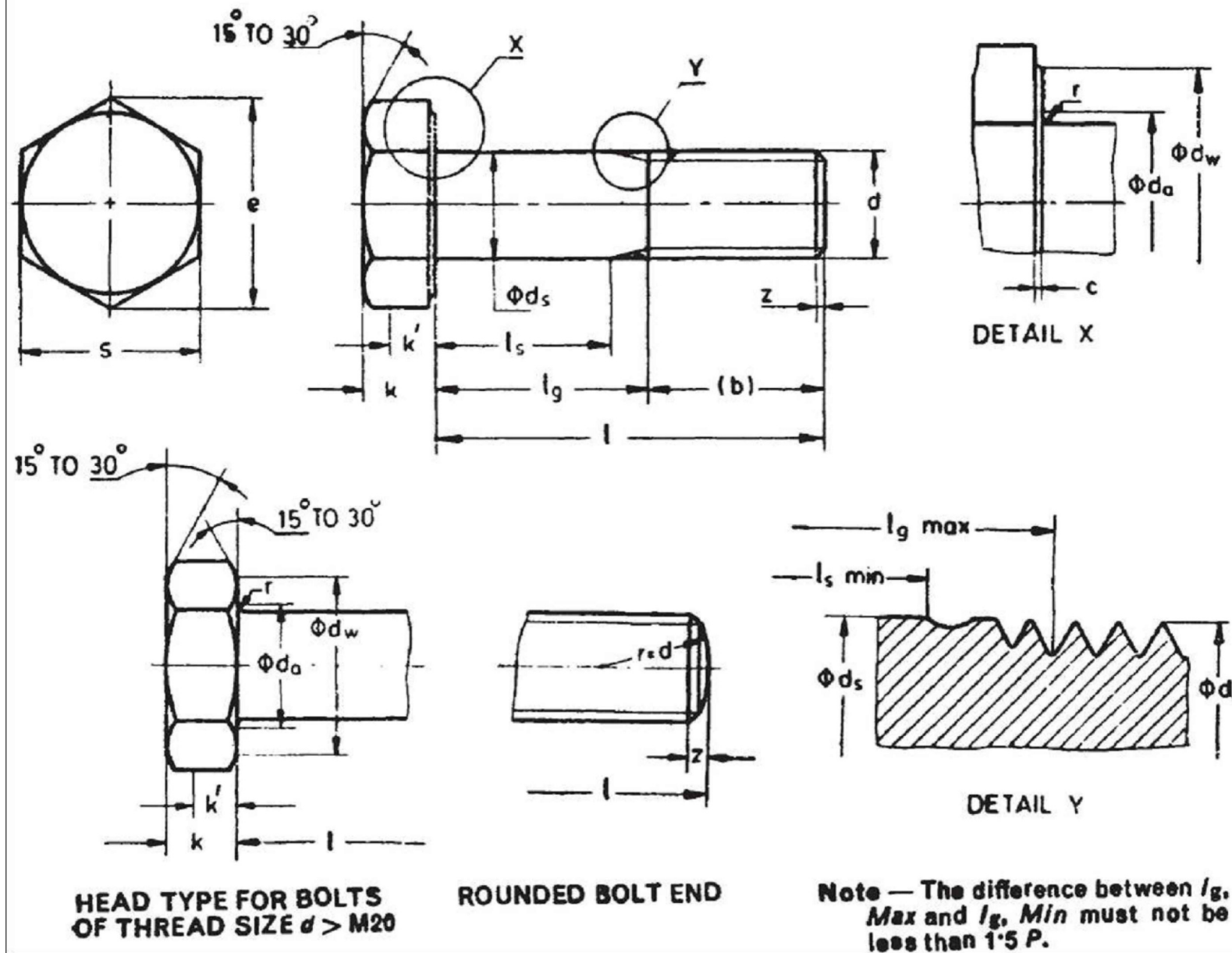

HEAD TYPE FOR BOLTS  
OF THREAD SIZE  $d > M20$

ROUNDED BOLT END

Note — The difference between  $l_g$ ,  
Max and  $l_g$ , Min must not be  
less than  $1.5 P$ .

HSFG BOLT FIGURE AS GIVEN IN IS-3757 STANDARD

Sl.No	Bolt Variant	l (mm)	b (mm)	lg (mm)	Bolt head color
1	M30X90-Extended	90	70	20	GREEN
2	M30X130-Extended	130	80	50	ORANGE
3	M30X170-Extended	170	90	80	BLUE
4	M30X200-Extended	200	80	120	YELLOW

NOTES:

1. THE THREADED PORTION AND SHANK LENGTH ARE TO BE FOLLOWED AS PER TABLE
2. OTHER DIMENSIONS ARE AS PER IS-3757 STANDARD
3. BOLTS PROPERTY CLASS 10.9.

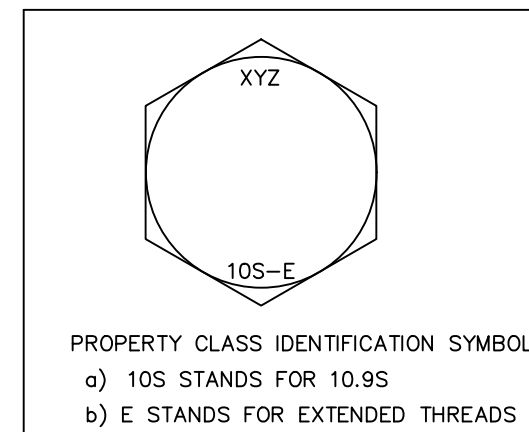

CAUTION: The information on this document is the property of BHARAT HEAVY ELECTRICALS LTD. It must not be used directly or indirectly in any way detrimental to the interest of the company.

TYPE OF PRODUCT  
OR NAME OF  
CUSTOMER/PROJECT



Bharat Heavy Electricals Ltd  
UNIT: HIGH PRESSURE BOILER PLANT  
TIRUCHIRAPALLI — 620014

DEPT  
ST

ALL  
DIMENSIONS  
ARE IN MM

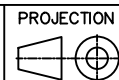

SCALE

WEIGHT (Kg)

REF TO ASSY / OLD DWG

DRN	NAME	SIGNATURE	DATE
	S.SETHUPATHI		30.04.2022
CHD	KRG/MPN/VRS/AGN/YUVA		30.04.2022
APPD	K.RAJMOHAN		30.04.2022

REV	DATE	ALTERED :
01		CHD & APPD:

TITLE  
M30X90,130,170&200-EXTENDED  
THREAD-HSFG BOLTS

DRAWING NO :  
3-35-700-09999 00

	<b>BHEL – Tiruchirappalli - 620014,</b> <b>India. Quality Assurance Department</b> <b>TECHNICAL DELIVERY</b> <b>CONDITIONS</b>	DOC No: <b>TDC:5:215 Rev: 01</b> Effective Date: <b>12/08/2022</b> Page: <b>1 of 6</b>
<b>Product: Extended Thread High Strength Friction Grip Fasteners For Structurals (Property class Bolt 8.8,10.9/ Nut 8 &amp;10)</b>		

**Revision record:**

Rev 00: Dt 14/11/2019 – Fresh issue

Rev01 : Dt 12/08/2022 –In clause 1.0,5.0,6.0, class 10.9 for bolts & 10 for nuts included, Drawing no’s removed in Clause 1.0,3.0 &6.0. Weight of bags included in Cl 6.0

**1. SCOPE:**

This technical delivery condition covers the requirements for the High strength structural steel bolts, Nuts and Washers applicable for boiler structures and shall be procured from the BHEL approved manufacturers only. The mandatory requirements, test methods and procedures from the applicable IS standards to confirm a product to its relevant latest IS standard shall be met with. TDC is in addition to specification.

**Size, Specification and Qty:** As per the BHEL Purchase order (PO) / BHEL Drawing. The bolts, nuts and washers shall be supplied in the dull black heat treated condition with residual coating of light oil.

**For Bolts:** As per BHEL drawing and revision as indicated in the Purchase order. and IS: 3757 (Latest) Property class: 8.8 ,10.9. Product Grade C of IS Specification IS: 1367 Part 2 (Latest).

**For Nuts:** IS: 6623 (Latest) Property class: 8 & 10, Product Grade B

**For Washers:** IS: 6649 (Latest) Material: 45C8, Type-A: Plain hole Circular Washers. Grade: Ordinary

**2. RAW MATERIAL:**

- **Bolts and Nuts:** Rolled/Forged bar of Carbon steel. Washer: as per IS 1571 Part 2 (Latest)
- **Chemical composition:** Shall be checked on receipt of raw material at supplier works for every heat  
**Bolts:** Plain Carbon Steel, Carbon steel with additives (e.g. Br, Mn or Cr) – As per Table 2 of IS: 1367 Part 3 (Latest)  
**Nuts:** As per Table 4 of IS 1367 Part 6 (Latest)  
**Washers:** As per IS 1570 Part 2 and Sulphur, Phosphorous <0.06% in check analysis

**3. DIMENSIONS AND TOLERANCES:**

- **Process:** Cold/Hot Forging with Dies and tools clean of loose scale and sheet particles.
- Threads on the bolts shall be checked with a properly calibrated ring gauge with a tolerance class 6g. Threads on the nuts shall be checked with a properly calibrated plug gauge with tolerance class 6H in an NABL accredited LAB.
- Dimensions of the Bolts shall be as per BHEL drawing and revision as indicated in the Purchase order.
- Dimensions of the Nuts shall be as per the table given in IS: 6623 (Latest)
- Dimensions of the Washers shall be as per the table given in IS 6649 (Latest)

**Note:** The washers shall be flat with a maximum deviation not exceeding 0.25 mm from the straight edge laid along a line passing through the center of the hole. The hole of the washer shall be concentric with the outside dimensions within 0.50 mm. washers are required to be clipped to provide clearance, the clipped edge shall not be closer to the center of the washer than 0.9 of the bolt diameter.

**4. Post Forming Heat Treatment (HT):**

- **Bolt:** After forming shall be quenched (HT at AC 3 temperature, with soaking time 30minutes per inch followed by quenching) and tempered (at 425°C min, 60 minutes per inch). There should be a sufficient hardenability to ensure a structure consisting of approximately 90 % martensitic in the core of the threaded sections for the fasteners in the as-hardened condition before tempering.
- **Nut:** Shall be hardened and then tempered (at a temperature of 425°C minimum).
- **Washer:** Shall be hardened and tempered. Carburized washers are not permitted.

	<b>BHEL – Tiruchirappalli - 620014,</b> <b>India. Quality Assurance Department</b> <b>TECHNICAL DELIVERY</b> <b>CONDITIONS</b>	DOC No: <b>TDC:5:215 Rev: 01</b> Effective Date: <b>12/08/2022</b> Page: <b>2 of 6</b>
	<b>Product: Extended Thread High Strength Friction Grip Fasteners For Structurals (Property class Bolt 8.8,10.9/ Nut 8 &amp;10)</b>	

**5. CHEMICAL & MECHANICAL & NDE: (on Heat Treated finished product)**

Sample Size for Mechanical test: & NDE: As per Sampling Plan

**BOLT :**

Sl	Test	Test Method - As per Table 3 of IS: 1367 Part 3 (Latest)	Acceptance
1	Chemistry	Spectro / Wet Analysis Method – One sample for every heat Of raw material and One sample/HT batch on product	As per Cl 2.0 of this TDC
2	Hardness Test	Note: Surface hardness shall not be more than 30 Vickers above the measured core Hardness on the product when readings of both surface and core are carried out at HV 0.30.	8.8 – Min 255 HV Max 335 HV 10.9- Min 320 HV Max 380 HV
3	Minimum Tensile Strength, %Elongation on $5.65\sqrt{A}$ , % Reduction in Area after fracture	if wedge load test is satisfactory the axial tensile test is not required	8.8 – 830N/mm <sup>2</sup> , 12 min, 52% min 10.9-1040N/mm <sup>2</sup> , 9 min, 48% min
4	Proof Load Test	<b>8.8</b> – Proof Load of M20 (147KN), M24 (212KN), M30 (337KN), M36 (490KN) <b>10.9</b> – Proof Load of M20 (203KN), M24 (293KN), M30 (466KN), M36 (678)KN	Length of the bolt after loading shall be the same as before loading within a tolerance of $\pm 12.5 \mu\text{m}$ allowed for measurement error.
5	Strength under Wedge load test	IS: 1367 Part 3 (Latest)	8.8 – 830N/mm <sup>2</sup> 10.6– 1040 N/mm <sup>2</sup>
6	Decarburization Test at 200X min magnification	Determination of the following by MICROSCOPIC Method a) Minimum Height of non decarburized thread zone – E b) Maximum depth of complete decarburization – G	E = 2/3 H1 G = 0.015 mm
7	Hardness after Retempering	IS: 1367 Part 3 (Latest) test not mandatory, to be applied in case of dispute only	Reduction of hardness 20 HV max.
8	NDE for Surface Integrity	<b>before machining –</b> For bar Diameter $\geq 40$ mm: UT as per ASTM A388. For bar Diameter $< 40$ mm: MPI as per ASTM E 709 <b>After machining –</b> MPI as per ASTM E 709 or as per ISO 6157 Part 3 (Latest)	UT – ASME SEC-VIII. Div-II Part: 3.3.4 (Latest).  MPI – Linear indications like cracks, folds & other injurious defects are not acceptable.
9	Micro Examination for Surface Integrity – Laps at threaded region.	If any defectives found in visual and NDE examinations, the extent of defect can be determined by micro examination.	Max depth of laps in thread = 0.41 mm Laps of any depth or length are not permitted in the following places: <ul style="list-style-type: none"> <li>• at the root of the thread</li> <li>• at the loaded flank of screw</li> </ul>



**Product: Extended Thread High Strength Friction Grip Fasteners For Structurals (Property class Bolt 8.8,10.9/ Nut 8 &10)**

		<p>thread below the pitch diameter, even if they start beyond the pitch diameter. The following laps are permissible :</p> <ul style="list-style-type: none"> <li>• laps in the crest of the threads of 0.25 H1 max.;</li> <li>• crest of the threads not entirely rolled out, maximum half a turn on one thread;</li> <li>• laps below the pitch diameter, if they run on the non-loaded flank towards the major diameter and not deeper than 0.25 H1 and not longer than half a turn on one thread.</li> </ul>
--	--	--

**NUT: (on Heat Treated finished product)**

SI	Test	Test Method	Acceptance Value
1.	Chemistry	Spectro / Wet Analysis Method – For every heat of raw material and, One sample/HT batch on product	As per Cl 2.0 of this TDC
2.	Hardness Test	Hardness of the test mandrel shall be minimum 45 HRC.	Min 272 HV Max 372 HV
3.	Proof Load Test	Proof Load of <b>8.8</b> – Proof Load of M20 (263.4KN), M24 (379.5KN), M30 (603.1KN), M36 (878.3KN) <b>10.9</b> -M20 (305KN), M24 (439.5KN), M30 (698.4KN), M36 (1017.2KN) shall be applied axially to the nut in a tensile testing machine for 15sec.	The nut shall resist the load without failure by stripping or rupture, and shall be removable by the fingers after the load is released.
4.	NDE for Surface Integrity	Before coating, as per IS 1367 Part 10 Cl 4.2 (Latest)	Linear indications like cracks, folds & Other injurious defects are not acceptable.

**WASHER:** As per IS 5369. The washers shall be free from cracks, burrs, pits and other defects. All sharp edges shall be removed.

SI	Test	Test Method	Acceptance Value
1.	Chemistry	Spectro / Wet Analysis Method – For every heat Of raw material and One sample/HT batch batch on product.	As per Cl 2.0 of this TDC
2.	Hardness Test	IS 1586 (latest)	Min 35 HRC Max 45 HRC

	<b>BHEL – Tiruchirappalli - 620014,</b> <b>India. Quality Assurance Department</b> <b>TECHNICAL DELIVERY</b> <b>CONDITIONS</b>	DOC No: <b>TDC:5:215 Rev: 01</b> Effective Date: <b>12/08/2022</b> Page: <b>4 of 6</b>
<b>Product: Extended Thread High Strength Friction Grip Fasteners For Structurals (Property class Bolt 8.8,10.9/ Nut 8 &amp;10)</b>		

**6. MARKING, PRESERVATION AND PACKING:**

The following to be hot stamped or embossed on the top surface of the bolt and nut:

**Bolt** – Manufacturer’s Identification Symbol and 8.8S,10.9S

**Nut** – Manufacturer’s Identification Symbol and 8S,10S

**Washers** – Shall be identified by – the provision of 2 nibs and manufacturers identification symbol being placed as near to the outer edge as possible.

The following details shall be clearly indicated in the tags tied to the bundle:

1) Customer Name 2) Manufacturer’s Name 3) Vendor Code 4) Purchase Order No and Supplier Internal W.O No 5) Quantity and Weight 6) BHEL Material Code 7) Item Description with diameter, length

**Colour coding:** To be done only on bolt head as per BHEL drawing and revision as indicated in the Purchase order.

Shall be packed in bituminous coated Polythene lined Hessian Cloth/Bag. Each bag shall contain only the same size of bolts/ nuts/ washers respectively and the same shall be indicated in the tags. The weight of the bag shall not exceed 30Kgs.

**7. INSPECTION AND CERTIFICATION:**

All the finished components shall be visually and dimensionally inspected as per sampling plan. All the test results shall be documented and maintained. Products to be inspected at works & test certificates (in English) shall be submitted with the following details counter signed by BHEL/BHEL Authorized Inspection agency as indicated in the PO. Manufacturers Test certificate (MTC) shall contain the following:

- 1) Purchase Order No. (BHEL), TDC No, Specification and Grade.
- 2) Name of raw material bar supplier.
- 3) Forming process
- 4) Dimensional reports for each product.
- 5) Chemistry including incidental elements on the raw material and final product checked in NABL lab/ suppliers own lab.
- 6) HT details of materials temperature, soaking time, ROH/ROC medium etc.
- 7) All Mechanical test result report including hardness.
- 8) MPI, Micro examination and decarburization test report with the reference & acceptance standard.
- 9) TC of raw material, UT/MPI report done on raw material shall accompany the MTC.

**8. AUDITS AT BHEL:**

BHEL reserve the right to reject any item found to be not meeting the requirements during tests at supplier works or during subsequent processing at BHEL.

	<b>BHEL – Tiruchirappalli - 620014,</b> <b>India. Quality Assurance Department</b> <b>TECHNICAL DELIVERY</b> <b>CONDITIONS</b>	<b>DOC No: TDC:5:215 Rev: 01</b> <b>Effective Date: 12/08/2022</b> <b>Page: 5 of 6</b>
	<b>Product: Extended Thread High Strength Friction Grip Fasteners For Structural (Property class Bolt 8.8,10.9/ Nut 8 &amp;10)</b>	

**TEST SAMPLING PLAN FOR HSFG BOLTS, NUTS & WASHERS FOR BHEL TDC: 5:215**

Lot Size (In nos.)	SAMPLE SIZE										Remarks	
	Visual (nos.)	Dimensional (nos.)	MPI (nos.)	Physical Tests						Decarb (nos.)		
				Total nos.	Hardness (nos.)	Hardness after Re- tempering (nos.)	Proof Load (nos.)	Wedge Load (nos.)	Min Tensile Strength (nos.)			
Upto 100	20	8	15	5	5	2	2	2	2	2	1	
101 to 300	32	13	15	5	5	2	2	2	2	2	1	
301 to 500	50	20	15	5	5	2	2	2	2	2	1	
501 to 1000	80	32	15	5	5	2	2	2	2	2	1	
1001 to 3000	125	50	25	8	8	2	2	4	2	2	1	Upto 1500 nos. 15 nos. for MPI
3001 to 10000	200	80	50	13	13	2	2	6	2	2	1	Upto 5000 nos. 25 nos. for MPI
10001 to 35000	315	125	75	20	20	4	4	10	4	4	2	Upto 15000 nos. 50 nos. for MPI
Above 35000	500	200	100	32	32	6	6	15	6	6	3	Upto 50000 nos. 75 nos. for MPI
<b>Inspection by BHEL/BHEL AIA</b>	<b>W</b>	<b>W</b>	<b>W</b>	<b>W</b>	<b>W</b>	<b>W</b>	<b>W</b>	<b>W</b>	<b>W</b>	<b>W</b>	<b>W</b>	

Inspection by BHEL / BHEL AIA shown as “W” shall be witnessed for the sample size indicated against the lot size

	<b>BHEL – Tiruchirappalli - 620014,</b> <b>India. Quality Assurance Department</b> <b>TECHNICAL DELIVERY</b> <b>CONDITIONS</b>	DOC No: <b>TDC:5:215 Rev: 01</b> Effective Date: <b>12/08/2022</b> Page: <b>6 of 6</b>
<b>Product: Extended Thread High Strength Friction Grip Fasteners For Structurals (Property class Bolt 8.8,10.9/ Nut 8 &amp;10)</b>		

Remarks:

1. Acceptance Number is zero. If the sample is having deviations in Visual, Dimensional and MPI then the entire lot shall be 100% inspected. In case of deviations in Physical tests a second sample of twice the sample size of initial sample shall be taken. The lot will get rejected if the second sample fails.
2. Preservation & Packing: The bolts shall be supplied in the dull black heat treated condition with a residual coating of light oil. Finished products shall be packed in a bituminous coated Polythene lined Hessian cloth/bag. Each bag shall contain only the same size of bolts/nuts/washers respectively and the same shall be indicated in the tags.

M. Jeyaram Manager/QA	K. Bhuvanadevi Manager/ MM	K Rajmohan SDGM/Engg	T Pandian AGM/QC	J.V.V. Aruna Kumar AGM/QA &BE
<b>Prepared</b>	<b>Reviewed</b>			<b>Approved</b>

**Revision record:**

Rev 00: 18/10/2011 Fresh Issue released and Test Sampling Plan Rev 00

Rev 01: 19/04/2012 Cl 2: Requirement if the Carbon content is below 0.6% - Added for Bolts; Mn for Nuts: limited to 0.25 min instead of 0.25 max. Cl 5: Hardness of Bolt &amp; Nut: Acceptance values changed. Cl 7: Preservation and Packing added and Test Sampling Plan Rev 01

Rev 02: 28/10/2014 Property class Bolt 10.9 and Nut 10 and its requirements added (for Neyveli 2x500MW Tower boiler) in all clauses and Test Sampling Plan Rev 02

**1. SCOPE:**

This technical delivery condition covers the requirements for the High strength structural steel bolts, Nuts and Washers applicable for boiler structures and shall be procured from the BHEL approved manufacturers only. The mandatory requirements, test methods and procedures from the applicable IS standards to confirm a product to its relevant latest IS standard shall be met with. TDC is in addition to specification.

Size, Specification and Qty: As per the BHEL Purchase order (PO) / BHEL Drawing. The bolts, nuts and washers shall be supplied in the dull black heat treated condition with residual coating of light oil.

For Bolts: IS: 3757 (Latest) Property class: 8.8 or 10.9. Product Grade C of IS Specification IS: 1367 Part 2 (Latest).

For Nuts: IS: 6623 (Latest) Property class: 8 or 10, Product Grade B

For Washers: IS: 6649 (Latest) Material: 45C8, Type-A: Plain hole Circular Washers. Grade: Ordinary

**2. RAW MATERIAL:**

- Bolts and Nuts: Rolled/Forged bar of Carbon steel. Washer: as per IS 1571 Part 2 (Latest)
- **Chemical composition:** Shall be checked on receipt of raw material at supplier works for every heat  
Bolts: Plain Carbon Steel, Carbon steel with additives (eg Br, Mn or Cr) – As per Table 2 of IS: 1367 Part 3 (Latest)  
Nuts: As per Table 4 of IS 1367 Part 6 (Latest)  
Washers: As per IS 1570 Part 2 and Sulphur, Phosphorous <0.06% in check analysis

**3. DIMENSIONS AND TOLERANCES:**

- Process: Cold/Hot Forging with Dies and tools clean of loose scale and sheet particles.
- Threads on the bolts shall be checked with a properly calibrated ring gauge with a tolerance class 6g. Threads on the nuts shall be checked with a properly calibrated plug gauge with tolerance class 6H (in an NABL accredited LAB).
- Dimensions of the Bolts shall be as per the table given in IS 3757 (Latest)
- Dimensions of the Nuts shall be as per the table given in IS: 6623 (Latest)
- Dimensions of the Washers shall be as per the table given in IS 6649 (Latest)

**Note:** The washers shall be flat with a maximum deviation not exceeding 0.25 mm from the straight edge laid along a line passing through the center of the hole. The hole of the washer shall be concentric with the outside dimensions within 0.50 mm. washers are required to be clipped to provide clearance, the clipped edge shall not be closer to the center of the washer than 0.9 of the bolt diameter.

**4. Post Forming Heat Treatment (HT):**

- Bolt: After forming shall be quenched (HT at AC 3 temperature, with soaking time 30minutes per inch followed by quenching) and tempered (at 425°C min, 60 minutes per inch). There should be a sufficient hardenability to ensure a structure consisting of approximately 90 % martensitic in the core of the threaded sections for the fasteners in the as-hardened condition before tempering.
- Nut: Shall be hardened and then tempered (at a temperature of 425°C minimum).
- Washer: Shall be hardened and tempered. Carburized washers are not permitted.

**5. CHEMICAL & MECHANICAL & NDE: (on Heat Treated finished product)**

Sample Size for Mechanical test: & NDE: As per Sampling Plan

**BOLT :**

Sl	Test	Test Method - As per Table 3 of IS: 1367 Part 3 (Latest)	Acceptance
1	Chemistry	Spectro / Wet Analysis Method – One sample for every heat Of raw material and One sample/HT batch on product	As per Cl 2.0 of this TDC
2	Hardness Test	Note: Surface hardness shall not be more than 30 Vickers above the measured core Hardness on the product when readings of both surface and core are carried out at HV 0.30. For property class 10.9, any increase in hardness at the surface which indicates that the surface hardness exceeds 390 HV is not acceptable.	8.8 – Min 255 HV Max 335 HV 10.9 – Min 320HV, Max 380HV
3	Minimum Tensile Strength, %Elongation on 5.65√A, % Reduction in Area after fracture	*if wedge load test is satisfactory the axial tensile test is not required	8.8 – 830N/mm <sup>2</sup> , 12 min, 52% min 10.9 – 1040 N/mm <sup>2</sup> , 9 min, 48% min
4	Proof Load Test	8.8 – Proof Load of M16(91KN), M20 (147KN), M24 (212KN), M30 (337KN), M36 (490KN); 10.9 – Proof Load of M16(130KN), M20 (203KN), M24 (293KN), M30 (466KN), M36 (678KN) shall be applied axially to the bolt in a calibrated tensile testing machine for 15sec.	Length of the bolt after loading shall be the same as before loading within a tolerance of ± 12.5 µm allowed for measurement error.
5	Strength under Wedge load test	IS: 1367 Part 3 (Latest)	8.8 – < 830N/mm <sup>2</sup> 10.9 – < 1040 N/mm <sup>2</sup>
6	Decarburization Test at 200X min magnification	Determination of the following by MICROSCOPIC Method a)Minimum Height of non decarburized thread zone – E b)Maximum depth of complete decarburization – G	E = 2/3 H1 G = 0.015 mm
7	Hardness after Retempering	IS: 1367 Part 3 (Latest) # test not mandatory, to be applied in case of dispute only	Reduction of hardness 20 HV max.
8	NDE for Surface Integritiy	<b>before machining –</b> For bar Diameter ≥ 40 mm: UT as per ASTM A388. For bar Diameter < 40 mm: MPI as per ASTM E 709 <b>After machining –</b> MPI as per ASTM E 709 or as per ISO 6157 Part 3 (Latest)	UT – ASME SEC-VIII. Div-II Part: 3.3.4 (Latest). MPI – Linear indications like cracks, folds & other injurious defects are notacceptable.

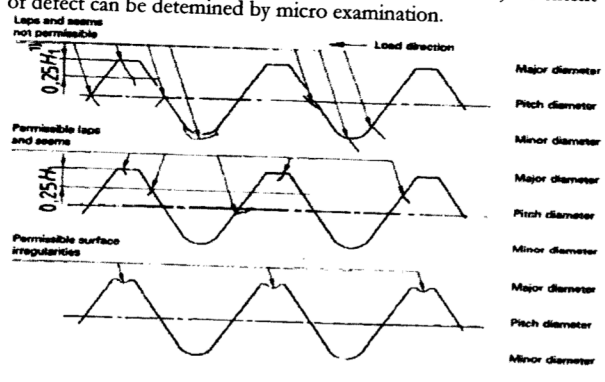
<p>9 Micro Examination for Surface Integrity – Laps at threaded region.</p>	<p>If any defectives found in visual and NDE examinations, the extent of defect can be determined by micro examination.</p> 	<p>Max depth of laps in thread = 0.41 mm Laps of any depth or length are not permitted in the following places:</p> <ul style="list-style-type: none"> <li>• at the root of the thread</li> <li>• at the loaded flank of screw thread below the pitch diameter, even if they start beyond the pitch diameter.</li> </ul> <p>The following laps are permissible :</p> <ul style="list-style-type: none"> <li>• laps in the crest of the threads of 0.25 H1 max.;</li> <li>• crest of the threads not entirely rolled out, maximum half a turn on one thread;</li> <li>• laps below the pitch diameter, if they run on the non-loaded flank towards the major diameter and not deeper than 0.25 H1 and not longer than half a turn on one thread.</li> </ul>
---	--	--

**NUT: (on Heat Treated finished product)**

Sl	Test	Test Method	Acceptance Value
1.	Chemistry	Spectro / Wet Analysis Method – For every heat Of raw material and, One sample/HT batch on product	As per Cl 2.0 of this TDC
2.	Hardness Test	Hardness of the test mandrel shall be minimum 45 HRC.	8S – Min 188 HV Max 372 HV 10S – Min 272 HV Max 372 HV
3.	Proof Load Test	Proof Load of 8S – M16(168.9KN), M20 (263.4KN), M24 (379.5KN), M30 (603.1KN), M36 (878.3KN) 10S – M16(195.5KN), M20 (305KN), M24 (439.5KN), M30 (698.4KN), M36 (1017.2KN) shall be applied axially to the nut in a tensile testing machine for 15sec.	The nut shall resist the load without failure by stripping or rupture, and shall be removable by the fingers after the load is released.
4.	NDE for Surface Integrity	Before coating, as per IS 1367 Part 10 Cl 4.2 (Latest)	Linear indications like cracks, folds & Other injurious defects are not acceptable.

**WASHER:** As per IS 5369. The washers shall be free from cracks, burrs, pits and other defects. All sharp edges shall be removed. **(on Heat Treated finished product)**

Sl	Test	Test Method	Acceptance Value
1.	Chemistry	Spectro / Wet Analysis Method – For every heat Of raw material and One sample/HT batch on product.	As per Cl 2.0 of this TDC
2.	Hardness Test	IS 1586 (latest)	Min 35 HRC Max 45 HRC

**6. MARKING, PRESERVATION AND PACKING:**

The following to be hot stamped or embossed on the top surface of the bolt and nut:  
Bolt – Manufacturer’s Identification Symbol and 8.8S/10.9S  
Nut – Manufacturer’s Identification Symbol and 8S/ 10S

Washers – Shall be identified by – the provision of 2 nibs and manufacturers identification symbol being placed as near to the outer edge as possible.

The following details shall be clearly indicated in the tags tied to the bundle:

- 1) Customer Name
- 2) Manufacturer’s Name
- 3) Vendor Code
- 4) Purchase Order No and Supplier internal W.O No
- 5) Quantum and Weight
- 6) BHEL Material Code
- 7) Item Description with diameter, length

Shall be packed in bituminous coated Polythene lined Hessian Cloth/Bag. Each bag shall contain only the same size of bolts/ nuts/ washers respectively and the same shall be indicated in the tags.

**7. INSPECTION AND CERTIFICATION:**

All the finished components shall be visually and dimensionally inspected as per sampling plan. All the test results shall be documented and maintained. Products to be inspected at works & test certificates (in English) shall be submitted with the following details counter signed by BHEL/BHEL Authorized Inspection agency as indicated in the PO. Manufacturers Test certificate (MTC) shall contain the following:

- 1) Purchase Order No. (BHEL), TDC No, Specification and Grade.
- 2) Name of raw material bar supplier.
- 3) Forming process
- 4) Dimensional reports for each product.
- 5) Chemistry including incidental elements on the raw material and final product checked in NABL lab/ suppliers own lab.
- 6) HT details of materials temperature, soaking time, ROH/ROC medium etc.
- 7) All Mechanical test result report including hardness.
- 8) MPL, Micro examination and decarburization test report with the reference & acceptance standard.
- 9) TC of raw material, UT/MPI report done on raw material shall accompany the MTC.

**8. AUDITS AT BHEL:**

BHEL reserve the right to reject any item found to be not meeting the requirements during tests at supplier works or during subsequent processing at BHEL.

Haritha.C QA	Venkanna Rupani QA	Kalyanaraman.V QA	Viswanathan.D Engineering	Sekar.S QC	Balachandran.K.S MM	Revisankaran.U QA
Prepared By			Reviewed By			Approved By

**BHEL: TRICHY - 14**

**TEST SAMPLING PLAN FOR HSFG BOLTS, NUTS & WASHERS AS PER BHEL TDC: 5:211 Rev 02**

Lot Size (In nos.)	SAMPLE SIZE										Remarks	
	Visual (nos.)	Dimensional (nos.)	MPI (nos.)	Physical Tests					Min Tensile Strength (nos.)	Decarb (nos.)		
				Total nos.	Hardness (nos.)	Hardness after Re-tempering (nos.)	Proof Load (nos.)	Wedge Load (nos.)				
Upto 100	20	8	15	5	5	2	2	2	2	2	1	
101 to 300	32	13	15	5	5	2	2	2	2	2	1	
301 to 500	50	20	15	5	5	2	2	2	2	2	1	
501 to 1000	80	32	15	5	5	2	2	2	2	2	1	
1001 to 3000	125	50	25	8	8	2	2	4	4	2	1	Upto 1500 nos. 15 nos. for MPI
3001 to 10000	200	80	50	13	13	2	2	6	6	2	1	Upto 5000 nos. 25 nos. for MPI
10001 to 35000	315	125	75	20	20	4	4	10	10	4	2	Upto 15000 nos. 50 nos. for MPI
Above 35000	500	200	100	32	32	6	6	15	15	6	3	Upto 50000 nos. 75 nos. for MPI
Inspection by BHEL/BHEL AIA	W	W	W	W	W	W	W	W	W	W	W	

**Remarks:**



- Acceptance Number is zero. If the sample is having deviations in Visual, Dimensional and MPI then the entire lot shall be 100% inspected. In case of deviations in Physical tests a second sample of twice the sample size of initial sample shall be taken. The lot will get rejected if the second sample fails.
- Preservation & Packing: The bolts shall be-supplied in the dull black heat treated condition with a residual coating of light oil. Finished products shall be packed in a bituminous coated Polythene lined Hessian cloth/bag. Each bag shall contain only the same size of bolts/nuts/washers respectively and the same shall be indicated in the tags.
- Inspection by BHEL / BHEL AIA shown as "W" shall be witnessed for the sample size indicated against the lot size.

<i>[Signature]</i> 28/10/14	R. Venkanna 28/10/2014	<i>[Signature]</i> 28/10/2014	<i>[Signature]</i> 28/10/14	<i>[Signature]</i> 28/10/14
Haritha.C QA	Venkanna Rupani QA	Kalyanaraman.V QA	Sekar.S QC	Revisankaran.U QA
Prepared By		Reviewed By		Approved By

		<b>STANDARD QUALITY PLAN</b>				<b>QP: NO:</b> SFG: HFSG:01 <b>REV. NO.</b> 00			
		Item: HSFG Fasteners(Bolts, Nuts & Washers)				<b>DATE:</b> 28/09/2020 <b>PAGE:</b> 1 of 2			
<b>BHEL: BAP: RANIPET</b>		<b>QUALITY ASSURANCE</b>		<b>Reference Document</b>		<b>Acceptance Norms</b>		<b>Remarks</b>	
Component & operation 2		Characteristics 3		Type of Check 4		Quantum of Check 5		Format Of Records 8	
1		1		1		1		1	

Sl No	Component & operation	Characteristics	Type of Check	Quantum of Check	Reference Document	Acceptance Norms	Format Of Records	Remarks
1.0	Raw Material							
1.1	Raw Material	Chemical & Mechanical	TC Verification	100%	BHEL Specification(TDC)&PO		TC	P V
2.0	In process							
2.1	Machining & Heat Treatment:NDE(UT/MPIL)	Dimension,Temp,Time,Medium, HT Chart,NDE	Report Review	100%	DO		R	P V
3.0	Final Inspection(*)							
3.1	Visual & Dimension(*)	Visual, Dimension & Thread	Measurement /Thread gauge	Sampling plant(*)	DO		R	P W
3.2	Mechanical Testing(* #)	Mechanical(Hardness, Strength under wedge load test,Minimum Tensile Strength,Proof load test,Decarburization test, Hardness after Re-Tempering)	Testing	DO	DO		R	P W
3.3	Chemical(*)	Chemical composition(\$)	Testing	DO	DO		R	P W
3.4	NDE(*)	Surface Quality	Testing (Visual & MPI)	DO	DO		R	P W
3.5	Packing & Preservation	Packing & Marking	verification		DO		R	P V

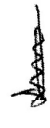
**LEGENDS:**  
 M:- MANUFACTURER/ SUBCONTRACTOR, B:- BHEL/AUTHORISED INSPECTION AGENCY, P:- PERFORMED, V:- VERIFICATION, W:- WITNESS, R:- REPORT C- CUSTOMER, CHP:- CUSTOMER HOLD POINT TC:- TEST CERTIFICATE

 Prepared By (Abdul Ghani) Sr. Engineer/QA	 Reviewed By K. Renjith MGR/QA	 Reviewed By R. Kesavan DGM/QC-Proc	Approved By R.Arunachalam DGM/QA(Mech)&OLI
--	--	---	--





<b>BHEL: BAP: RANIPET QUALITY ASSURANCE</b>		<b>STANDARD QUALITY PLAN</b>				<b>QP: NO:</b>	<b>SQP: HFSG:01</b>
<b>RANIPET</b>		<i>Item: HSFG Fasteners(Bolts, Nuts &amp; Washers)</i>				<b>REV. NO.</b>	<b>00</b>
<b>SI No</b>	<b>Component &amp; operation</b>	<b>Characteristics</b>	<b>Type of Check</b>	<b>Quantum of Check</b>	<b>Reference Documents</b>	<b>Acceptance Norms</b>	<b>Remarks</b>
<b>1.</b>	<b>2</b>	<b>3</b>	<b>4</b>	<b>5</b>	<b>6</b>	<b>7</b>	<b>10</b>
						<b>Format Of Records</b>	<b>Agency</b>
						<b>8</b>	<b>M B</b>
							<b>9</b>
							<b>2 of 2</b>
							<b>28/09/2020</b>
							<b>00</b>

**Note:** This QP shall be read along with relevant PO, TDC and applicable standards and Drawings. Requirements shall be complied.  
 \$: Chemical check by Spectro/wet method (minimum 1 no to be checked per inspection lot).

Record of Revision	
Rev. No.	Date
00	26-09-2020
Details of Revision	
1. Fresh release/ Original issue	
2. Based on the Purchase & QC(Proc) feedback, QA has released this SQP.	

<b>LEGENDS:</b> M:- MANUFACTURER/ BHEL/AUTHORISED INSPECTION AGENCY, P:- PERFORMED, V:- VERIFICATION, W:- WITNESS, R:- REPORT C:- CUSTOMER, CHP:- CUSTOMER HOLD POINT TC:- TEST CERTIFICATE	<b>Prepared By</b> (Abdul Ghani) Sr. Engineer/QA	<b>Reviewed By</b> K. Renjith MGR/QA	<b>Reviewed By</b> R. Kesavan DGM/QC-Proc	<b>Approved By</b> R.Arunachalam DGM/QA(Mech)&OLI
--	--	--	---	---

Applicable for BHEL IVP Coimdwal also,

**VIJAY**  
29/09/2021  
 1. MANUFACTURER/QUALITY ENGINEER (Quality)  
 2. SUBCONTRACTOR/INSPECTION AGENCY (Quality)  
 3. VERIFICATION/WITNESS (Quality)  
 4. REPORT CUSTOMER (Quality)  
 5. HOLD POINT (Quality)  
 6. TEST CERTIFICATE (Quality)  
 7. CUSTOMER HOLD POINT (Quality)  
 8. CUSTOMER HOLD POINT (Quality)  
 9. CUSTOMER HOLD POINT (Quality)  
 10. CUSTOMER HOLD POINT (Quality)

**Manish Singh**  
29/09/21  
 1. MANAGER (Quality)  
 2. MANAGER (Quality)  
 3. MANAGER (Quality)  
 4. MANAGER (Quality)  
 5. MANAGER (Quality)  
 6. MANAGER (Quality)  
 7. MANAGER (Quality)  
 8. MANAGER (Quality)  
 9. MANAGER (Quality)  
 10. MANAGER (Quality)

**29/09/2021**  
 1. S.R. KENNY  
 2. S.R. KENNY  
 3. S.R. KENNY  
 4. S.R. KENNY  
 5. S.R. KENNY  
 6. S.R. KENNY  
 7. S.R. KENNY  
 8. S.R. KENNY  
 9. S.R. KENNY  
 10. S.R. KENNY

Tender Enquiry No. 2324-025E Dated 05.07.2023 Due date 17.07.2023

Tender Description: Supply of HSG Fasteners

(Annexure - P)

Pre-Qualification Criteria – As per Tender Special Term S2.2						
S.N.	Executed order value (Net of Taxes) as per bidder (INR)	Purchase order no. and date [PO date should be on or after 01.07.2020 till bid opening date]	Purchase Order issued by (Client name) M/s	Item description as per PO	Documents submitted against completion /execution proof of the afore mentioned PO (Invoice / Consignee Receipt Note / Completion Certificate) [Document date should be on or after 01.07.2020 till bid opening date]	Full address of the client and contact person (Name & Details i.e. Mail ID, Mobile No. etc)
1						
2						
3						
4						
5						
6						
7						

More lines can be added, if required.

Notes : -

1. Kindly attach all the above stated documents in the Quotation.
2. All proof of execution like Invoice / Consignee Receipt Note / Completion Certificate must include the Purchase Order reference number, otherwise that PO will not be considered for the fulfilment of this tender term.
3. All the above stated purchase order(s) should be of 'Bolts, Nuts or Washers (Bolt Grade 8.8 or above as per IS1367 (Latest Revision), IS3757(Latest Revision) or equivalent; Nut Grade 8 or above as per IS6623(Latest Revision) or equivalent; Washer Grade 8 or above as per IS 6649(Latest Revision) or equivalent', refer TDC:5:211 Rev:02 for more details'.

**Tender Enquiry No. 2324-025E** Dated 05.07.2023 **Due date 17.07.2023**

**Tender Description:** Supply of HSG Fasteners

**(Annexure-Q)**

**Confirmations of Special Terms :**

<b>SPECIAL TERMS</b>	<b>Item at Sr. No. 1 to 3</b>	<b>Item at Sr. No. 4 to 8</b>	<b>Confirmation by bidder</b>
<b>Delivery Destination and Scope of Unloading as per Tender Special Term S4</b>	BHEL Trichy Unit Address:  Manager / Stores – 11 Fossil Boilers, BHEL Boiler Plant Project P.O. Tiruchirapalli - 620 014. Tamilnadu, India.  <b>Un-loading</b> of material at BHEL Trichy shall be arranged by SUPPLIER.	NTPC Talcher Project Site Address:  Construction Manager, BHEL Site Office, 2X660 MW NTPC Talcher, Distt. Angul - 759107 Odisha, India  <b>Un-loading</b> of material at Talcher Site shall be arranged by BHEL site.	<b>Yes</b>
<b>Differential Freight as per Tender Special Term S6</b>	Not Applicable	Applicable	<b>Yes</b>
<b>Rates quoted by the bidder against this tender is Net of Taxes and FOR Destination Basis</b>			<b>Yes</b>

Authorized Signatory with seal

Place:

Date: