



BHARAT HEAVY ELECTRICALS LIMITED  
HEEP, HARIDWAR-249403 (Uttarakhand)  
Fax: 01334-226084/226462, Phone: 285834/281685

E-mail: [gupta.a@bhel.in](mailto:gupta.a@bhel.in); [dinesh86@bhel.in](mailto:dinesh86@bhel.in); [manoj-s@bhel.in](mailto:manoj-s@bhel.in)

Ref: BOI/NIC-OT/22-23/CJ/01

Date: 23.04.2022.

OPEN TENDER

1. Sealed Bids are invited from the bidders for the supply of the following items as per requirement mentioned below:

S. N.	Tender No.	Item Description	Total Requirements	Project Name	Last date to get from BHEL	Opening date
<b>A. Requirement for Khurja U-1&amp;2 &amp; Sagardighi projects:-</b>						
1.	B/4180/2019/42	<b>W90313396248</b> Calibration Jig	1 No	Khurja U-1	1 day before opening date	<b>14.05.2022</b>
2.	11V1	<b>As per Drg No.31339623010 Rev-01 &amp; Spec No. ST33002 Rev: 02 &amp; ST48012 Rev-07</b>	1 No	Sagardighi U-5		

1. Tenders will be received up to 13:45 Hrs. (IST) on opening date and opened on the same day at 14:00 Hrs. (IST).
2. Kindly arrange to submit your offer within due date and time. BHEL will not be responsible for any type of delay / incomplete information from vendor.
3. Please ensure that documents submitted with the offer/bid shall be signed and stamped in each page by authorized representative of the bidder.
4. Other terms and conditions will be as per tender documents.
5. The offer of the vendors who are banned/ De-Listed/ Under Hold by BHEL, shall not be considered till the period of their Ban/ De-list/ Hold.
6. Please note that "Traders and agents should not be allowed to avail the MSE benefits. Benefits of MSE (EMD waiver, Tender Cost Exemption, splitting of tender Qty., Payment Preference, etc.) will only be given to Original Manufacturers of Offered items against the NIT. No MSE benefits shall be provided to Agents / Stockiest / Dealer / Trader".
7. "For this procurement, the local content to categorize a supplier as a Class-I supplier / class-II local supplier / Non local supplier and purchase preference to class –I local supplier, is as defined in public procurement (preference to make in India), Order 2017 dated 04.06.2020 issued by DPIIT. In case of subsequent orders issued by the nodal ministry, changing the definition of local content for the items of the NIT, the same shall be applicable even if issued after issue of this NIT, but before opening of Part-II bids against this NIT"

The local supplier at the time of tender, bidding or solicitation shall be required to provide self-certification (Format enclosed) that the item offered meets the minimum local content and shall give details of the location (s) at which the local value addition is made.

Ashish Gupta  
SDGM (PPX-BOI)



**BHEL Enquiry No.: BOI/NIC-OT/22-23/CJ/01**

**Date of issue :23.04.2022**

**Due Date/ opening date: 14.05.2022**

**M/s.....**

Sub: Tender Enquiry No. B/4180/2019/4211V1

Dear Sir,

BHEL is pleased to invite your offer in **TWO PARTS** strictly as per enclosed terms and conditions and instruction to bidders, for the under mentioned materials. Offers are to be submitted through **BHEL's e-procurement portal developed by NIC (<https://eprocurebhel.co.in/>)**. Please note that **PAPER BID or BID THROUGH e-MAIL SHALL NOT BE ENTERTAINED FOR THIS TENDER**

S. N.	Material Codes	Item Description	Total Requirements	Delivery Required	EMD (Earnest Money Deposit)
<b>C. Requirement for Khurja U-1&amp;2 and Sagardighi U-5 project</b>					
1.	<b>W90313396248</b>	Calibration Jig <b>As per Drg No.31339623010</b>	01 No	Khurja U-1	At earliest
2.		<b>Rev-01 &amp; Spec No. ST33002</b> <b>REV: 02 &amp; ST48012 Rev-07</b>	01 No	Sagardighi U-5	30-Dec-22
<b>Total Requirements</b>			<b>02 Nos</b>	<b>EMD: NIL</b>	

Please submit your lowest quotation / offer for the above requirement subject to our terms and conditions. Your offer should be reached to us on or before the due date by 13:45 Hrs. (IST).

**NOTE: The vendor should submit their best prices at this stage itself and they will not be allowed to revise their prices. Any revision / discount given by vendor subsequently will be ignored.**

"Any clarification on technical specifications/tender documents can be obtained from BHEL before tender opening. Suppliers are welcome to have pre-bid meeting with BHEL for better understanding of requirements".

**Part-I** i.e. PQR and technical offer shall be opened at 14:00 Hrs. (IST) on the due date.

**"Evaluation of tender would be done on total landed cost to BHEL up to site project wise basis".**  
**Please also refer clause no. 8 "Evaluation Criterion" of Annexure-C, for terms and conditions regarding evaluation of Order Quantity.**

**The Offers of those vendors, which would not meet our PQR requirements, would be rejected by BHEL.**

KINDLY READ "INSTRUCTIONS TO BIDDERS" **THOROUGHLY**. QUOTATION NOT IN ACCORDANCE WITH THE ABOVE INSTRUCTIONS ARE LIABLE TO BE DISQUALIFIED AND IGNORED.

1. Tender specific additional terms & Conditions and GISTC Rev. 06 is attached herewith. Please confirm each clause and submit duly ink signed and stamped additional terms & conditions and GISTC Rev. 06 along with your valuable offer.
2. Commercial Terms & Conditions
3. Any Deviation with reference to NIT to be laid down on separate sheet.
4. Un-Priced replicas of Price Bid without prices

For & ON BEHALF OF BHEL, HARDWAR

**Ashish Gupta**  
**Sr. DGM (PPX-BOI)**



**BHARAT HEAVY ELECTRICALS LIMITED**  
**HEEP, HARIDWAR-249403 (Uttarakhand)**  
Fax: 01334-226084/226462, Phone: 285834/281685  
E-mail: [gupta.a@bhel.in](mailto:gupta.a@bhel.in); [dinesh86@bhel.in](mailto:dinesh86@bhel.in); [manoj-s@bhel.in](mailto:manoj-s@bhel.in)

### INSTRUCTION TO BIDDERS

#### Clause 1.0:

The tenders shall be submitted in two parts (**Part I** consisting of Techno-Commercial Bid, quality plan, replica of price bid & pre-qualification requirements and **Part II** Original Price Bid) as described below on or before the due date.

- **The Quotation should be from the Principal / Original Manufacturer, even if it is submitted through their authorized agents, failing which the quotation is likely to be ignored.**
- **Any corrections / amendments shall be properly & fully authenticated with signature.**

BHEL will deal directly with the manufacturer and no correspondence with the agents will be entertained. The agents will not be permitted to visit / interact with BHEL on behalf of their principals. Subsequently also, no correspondence of any type will be made with any agents (all individuals / companies – representative / adviser / retainer ship basis or claimed to be part time employees for many OEMs / claiming to be channel or business partner for BHEL work / stockiest not registered specifically etc. are agents). Communications with only those agents who have submitted agency agreement with their respective principal may be done.

#### **1.PRE-QUALIFICATION REQUIREMENT (PQR)**

The Pre-Qualification Requirements have been compiled enclosed with the tender documents. All the bidders should ensure submission of complete details and documents as called for in these requirements. The Offers submitted by the bidders would be scrutinized with respect to Pre-Qualification Requirements first. Techno- Commercial offer of only those bidders shall be evaluated who meet the Pre-Qualification Requirements.

#### **2.SUBMISSION OF OFFER**

**Please note that this tender enquiry has been issued through BHEL's e-procurement portal developed by NIC (<https://eprocurebhel.co.in/>), hence PAPER BID or BID THROUGH e-MAIL SHALL NOT BE ENTERTAINED FOR THIS TENDER. Please upload your bid in BHEL's e-procurement portal developed by NIC (<https://eprocurebhel.co.in/>).**

Please registered your firm on <https://eprocurebhel.co.in/> to participate in tenders floated by BHEL. In case of any difficulty faced while registering on BHEL's e-Procurement portal developed by NIC, queries may be addressed to 0120-4001002, 0120-4001005 and 0120-6277787; email: [support-eproc@nic.in](mailto:support-eproc@nic.in). These details are also available on 'Contact Us' page of the portal.

- 2.1** Only English version or bilingual with one language as English, of all documents would be valid & binding.
- 2.2** Bidders are advised to read all the tender documents carefully. Any submission of tender by the bidder shall be deemed to have been done after careful study and examination of the tender documents and with full understanding of the implications thereof. The specifications/ Technical Requirements and terms & conditions shall be deemed to have been accepted unless otherwise specifically commented upon in 'Deviation' sheets by the bidder in his offer. Non-compliance with any of the requirements and instructions in the Tender Enquiry may result in rejection of the offer.
- 2.3** **Name of vendor's dealing person with Contact No(s), Email ID and Address of correspondence shall be provided in the bid.**
- 2.4** Tenders are to be uploaded on BHEL e-procurement portal developed by NIC ([https://eprocurebhel.co.in](https://eprocurebhel.co.in/)) in Two Parts and Part-I (Techno-Commercial Bid along with PQR, as detailed below) will be opened first. The offers are to be uploaded on or before the last date of submission of offer, as detailed on BHEL e-procurement portal for the tender:

#### **3.PART-I BID: PRE-QUALIFICATION REQUIREMENT (PQR) & TECHNO-COMMERCIAL BID**

**Following documents are an integral part of this tender enquiry and endorsed copies of these documents (duly signed and stamped on each page, as a token of acceptance) and reply for each clause of Annexure-A are to be necessarily submitted along with the 'Techno-Commercial Bid' (Part-I bid).**

**All these following documents shall be uploaded in the "Techno-commercial bid level" on BHEL e-procurement portal developed by NIC (<https://eprocurebhel.co.in/>). PAPER BID or BID THROUGH e-Mail shall not be entertained for this tender enquiry.**



**Clause 3.1:**

**PART-I (TECHNO-COMMERCIAL BID) shall comprise of following documents:**

- a) Pre-Qualification Requirements **(as defined in Annexure-A)**
- b) Complete Technical offer with relevant drawings/ datasheets/other documents /QAP etc. **(as Per Special Instructions mentioned in Annexure-B).**
- c) Catalogue of the Equipment (If applicable)
- d) Duly Filled in "Additional Terms & Conditions and **GISTC Rev. 06** of the Two Parts Tender" **(as per Annexure-C).**
- e) Deviation if any with reference to specification to be laid down on separate sheet. Cost of deviation is to be submitted along with the price bid essentially, in case vendor withdraws the deviation clauses then same will be considered for final evaluation.
- f) Replica of Price Bid/ Price sheet (without Prices).
- g) The rating of the company quoting for this tender from a third party (independent agency) preferably by DUN & BRADSTREET should be submitted (D&B NUMBER). **Compliance of this clause is mandatory in case of foreign supplier, Indigenous suppliers to submit the copy of balance sheets for last three years** in absence of D&B / third agency report.
- h) **Supplier Registration Form:** The Supplier Registration Form (SRF) duly filled will be assessed for manufacturing capability, quality systems being followed, organizational soundness and financial worthiness. This form is to be filled online at [www.hwr.bhel.com](http://www.hwr.bhel.com) or [www.bhel.com](http://www.bhel.com).

**Note:**

1. **Suppliers who are already registered at HEEP, BHEL, Haridwar in the PMD (Product Material Directory) for this item are exempted for submission of online Supplier registration form.**
2. **Please note that all details required in supplier registration form to be filled and submitted through online supplier registration portal on [www.bhel.com](http://www.bhel.com) along with complete documents.**
3. **Please ensure that documents submitted with the offer/bid shall be signed and stamped in each page by authorized representative of the bidder.**

**Clause 3.2:**

**[B] PART-II BID (PRICE-BID): BOQ**

Prescribed BOQ shall be downloaded from online tender documents and after filling the relevant columns the same shall be uploaded by bidders. Please note that file name shall not be changed.

- a). e- price bid shall be opened as per schedule given after technical evaluation.
- b). Online Part-I bid (Techno-Commercial bid along with PQR) will be opened on Due Date and time specified in the online tender enquiry, or extension thereof. Incomplete offers are liable to be rejected.
- c). **Techno-Commercial offer of only those bidders shall be evaluated who meet the Pre-Qualification Requirements mentioned in our Enquiry.**
- d). After opening of the online techno-commercial offer, the offers would be evaluated by BHEL and acceptance shall be subject to End Customer approval. Online E-Price Bid shall be opened only of those vendors who were qualified on techno-commercial grounds & approved by customer (if applicable).

Thanking You,  
Yours faithfully,

For & on behalf of BHEL, Haridwar.

**Ashish Gupta**  
**SR. DGM (PPX-BOI)**



Annexure-A1

Pre-Qualification Requirements (PQR) for **Calibration Jig** (Mat. code. W90313396248)

---

SR. NO.	PRE-QUALIFICATION REQUIREMENTS	VENDOR RESPONSE
1.	Bidder to confirm manufacturing capability of Calibration Jig; which is required for calibration of Level Switch. The chamber of Calibration Jig should be suitable for Servo prime 46 of IOC /Turbine Oil -46 of H.P. Bidder to confirm,	
2.	Bidder should have minimum One-year experience of Design, Manufacturing and Supply of Calibration Jig or similar item, on date of enquiry. Bidder to confirm along with supporting documents i.e. Catalogue/ Datasheet/ Confirmation Letter/Unpriced PO Copies / Experience List (Any one can be provided), for the same.	

Notes --

SR. NO.	NOTES	VENDOR RESPONSE
1	BHEL reserve the right to verify the information submitted by Bidder. In case the information is found to be false / incorrect, the offer shall be rejected. Bidder to confirm.	

Ashish Gupta  
SR. DGM (PPX-BOI)



BHARAT HEAVY ELECTRICALS LIMITED  
HEEP, HARIDWAR-249403 (Uttarakhand)  
Fax: 01334-226084/226462, Phone: 285834/281685  
E-mail: [gupta.a@bhel.in](mailto:gupta.a@bhel.in); [dinesh86@bhel.in](mailto:dinesh86@bhel.in); [manoj-s@bhel.in](mailto:manoj-s@bhel.in)

Annexure-B

**SPECIAL INSTRUCTIONS**

**A) GENERAL REQUIREMENTS**

**a) For Khurja U-1 and Sagardighi U-5 projects:**

1. The material is to be delivered to **Khurja U-1 and Sagardighi U-5 projects** site directly from supplier works. Quotation shall be submitted accordingly.
2. The offer shall be submitted in-line with tender documents, Specification No. **As per Drg No.31339623010 Rev-01, Spec No. ST33002 REV: 02 & ST48012 Rev-06.**
3. Duly filled and ink signed, stamped "**Additional Terms and Conditions & GISTC Rev. 06 of the Two Parts Tender**" are to be necessarily submitted along with the offer.
4. **Please note that all details required in supplier registration form to be filled and submitted through online supplier registration portal on [www.bhel.com](http://www.bhel.com) along with complete documents.**

**B) QUALITY REQUIREMENTS: -**

**1). For Khurja U-1 and Sagardighi U-5 projects: -**

- a).** Testing & certification as per ordering drawing & specification.

**Kindly ensure the timely submission of your offer (by 13:45 Hrs IST on the due date) and note that Late Offers shall not be entertained under any circumstances.**

**Ashish Gupta  
Sr. DGM (PPX-BOI)**

**Additional Terms and conditions of tender enquiry (In addition to General instructions and standard terms & conditions as enclosed)**

These terms and conditions supersede the same or similar terms and conditions if they are appearing elsewhere in the Enquiry.

Sl. No	Terms	Description	Your confirmation
1.	<b>Confirmation to General Instructions and standard terms &amp; conditions:</b>	<p>Please confirm each clause of following documents: -</p> <ol style="list-style-type: none"> <li>1. General Instructions and standard terms &amp; conditions for bidding against tender enquiry (<b>GISTC Version June-2021, Rev: 06</b>):</li> <li>2. Additional terms &amp; conditions of tender enquiry.</li> </ol> <p>Deviation to conditions mentioned in above documents, if any, shall be submitted along with offer in separate documents.</p> <p><b>Please note that in case, no- deviation sheet is received along with the offer, it will be considered that all terms and conditions mentioned in above documents are acceptable to the bidder and your offer will be processed accordingly.</b></p>	
2.	<b>Special Instruction:</b>	<p>Please note that as per BHEL's Policy, we cannot allow Price impact for the requirement / scope of supply, which is a part of specifications of our tender enquiry. Hence please read all specification / documents thoroughly and submit your offer as per specifications of tender enquiry.</p>	
3.	<b>Basis of Quotation:</b>	<p>Kindly confirm that the prices have been quoted on FOR "BHEL Project site" / "Destination basis" i.e. including all taxes, duties, local levies, freight, packing &amp; Forwarding charges etc. The goods can be dispatched through any Bank approved transporters having their branch at Hardwar. The names and addresses of transporters approved by IBA as well as BHEL are posted at our website <a href="http://www.hwr.bhel.com">www.hwr.bhel.com</a>.</p> <p><b>Pls. note that, if you dispatch the material by any BHEL un-approved transporter then you will be required to furnish the MRC (Material Receipt Certificate) from Project Site for processing of your invoice. No demurrage charges would be payable by BHEL. Kindly confirm.</b></p>	
4.	<b>Bank Charges:</b>	Kindly Confirm that Bank Charges shall be either side.	
5.	<b>Transit Insurance:</b>	Transit insurance would be arranged by BHEL. Please send your offer keeping this in view.	
6.	<b>Technical Requirement:</b>	<p>Please quote your valuable offer as per <b>BHEL specification No. ST48012 Rev.07, ST33002 Rev. 02</b> (copy enclosed) &amp; <b>Drg. No. 31339623010 Rev-01</b>.</p> <p><b>Please ensure that documents submitted with the offer/bid shall be signed and stamped in each page by authorized representative of the bidder.</b></p>	
7.	<b>Validity:</b>	<p>Confirm that your offer shall be valid for 120 days from the date of tender opening. <b>BHEL will reserve the right to reject any or all quotations, quoting validity less than 120 days.</b></p>	
8.	<b>Evaluation criteria:</b>	Evaluation of tender would be done on total landed cost to BHEL up to site, project wise basis. <b>Please quote accordingly.</b>	
9.	<b>Engineering Documents Approval:</b>	<p>Drawings/Data sheets/documents/QAP as called in the specifications shall be submitted for approval to BHEL for BHEL/customer approval within 30 days of purchase order. BHEL will arrange the approval of these drawings/data sheets/documents/QAP within 30 days of their receipt provided those are complete in all respect.</p> <p><b>Any delay in delivery on account of late submission of drawings/other documents/QAP shall be to vendor's account. Kindly confirm.</b></p>	
10.	<b>MDCC (Material dispatch clearance)</b>	<p>Please note that material shall be dispatched only after issue of Material dispatch clearance certificate (MDCC) by BHEL. For issue of MDCC, you are required to submit all test certificates (TC's) and inspection report to BHEL. BHEL will issue MDCC within 7 days of receipt TCs &amp; IR, if complete &amp; clear w.r.t. approved quality plan and comply</p>	

	<b>certificate) Clause:</b>	with approved technical documents.	
11.	<b>Quality Requirements:</b>	<b>For Khurja U-1&amp;2 and Sagardighi U-5 Project: -</b>	
		a). Testing & certification as per ordering drawing & specification. <b>At least 15 days' advance time should be given to inspection agency for carrying out inspection of material at your works w.r.t. PO delivery date. Any delay in delivery due to this reasons would be to supplier account.</b>	
12.	<b>Payment Terms:</b>	100% payment is to be made against receipt of material at BHEL site. Kindly confirm.	
		<b>Please note that in case of any deviation in the payment terms, BHEL shall evaluate your offer after loading on account of deviation in payment terms as per BHEL practice/policy/"GISTC Rev 06".</b>	
13.	<b>Guarantee/ Warranty Clause:</b>	1. Kindly confirm that Guarantee/ Warranty shall be offered for a period of 24 months from the date of shipment/ Supply or 12 months from the date of commissioning of the equipment, whichever is earlier.  2. In case of any failure or trouble reported from site, the supplier shall depute their representative immediately to attend the problem and replace the defective component/ parts if required.	
14.	<b>Deviation (if any):</b>	Kindly Confirm that there is no deviation with respect to BHEL Specifications. However, deviations, if any, are to be listed as a separate attachment. The additional price, if any, for withdrawal of these deviations must be provided. The offers that do not meet the substantial requirements of our enquiry are liable to be ignored. The bidders shall be deemed to comply with all the requirements of bidding documents except for listed deviations without any extra cost irrespective of any mention to the contrary anywhere else in the bid.	
15.	<b>Origin of quotation:</b>	a) The quotation should preferably be from the principal bidder. However tender specific authorized registered dealer / agent can also submit the bid on their behalf, failing which the quotation is liable to be ignored. BHEL prefers to deal directly with the principal manufacturers. b) An agent cannot quote on behalf of more than one principal in the same tender enquiry. <b>Please refer clause no. 2 of GISTC Rev. 06 and quote offer accordingly.</b>	
16.	<b>Submission of offer:</b>	Kindly submit your offer on NIC portal <b>"Un-Priced Bid Cum Techno-Commercial Bid + PQR documents (Part-1) &amp; "Priced Bid" (Part-2).</b>	
17.	<b>Taxes &amp; duties:</b>	Details of applicable taxes & duties are to be mentioned as per clause 11 of General Instructions and Standards Terms & Conditions for bidding against tender enquiry <b>(GISTC, Rev. 06.)</b> In this regard, following is to be specifically mentioned in the offer: a) GST Registration Number b) Address of Principal place of Business c) Type of Business d) HSN Code, its description & rate of applicable GST for the offered material e) Whether registered under Composite scheme of GST (Y/N). It should be noted that the evaluation of the offers shall be done considering the taxation/benefits as applicable under GST.  <b>Please submit your GST registration certificate.</b>	
18.	<b>Delivery :</b>	Kindly confirm that the delivery period in no. of weeks/months from the date of issue of purchase order.	

**Tender Enquiry No. B/4180/2019/4211V1 for the requirement of Calibration Jig**

19.	<b>Business Dealing:</b>	<p>Please note that BHEL will deal directly with manufacturer and no correspondence with the agent will be entertained. The ink signed offer / bid in original has to be submitted by the registered manufacturer / OEMs directly to BHEL. Subsequently also, no correspondence of any type shall be entered into with the agents.</p> <p><b>Bids submitted by agents may not be considered for evaluation and shall be returned to them only, without assigning any reason. Please note the same.</b></p> <p><b>Also the name of principal supplier should be indicated on envelope in addition to Enquiry no and due date.</b></p>	
20.	<b>Penalty Clause:</b>	<p>Kindly confirm that penalty for late delivery w.r.t to contractual delivery shall be applicable at the rate of 0.5% of the total order value per week of delay or part thereof subject to a maximum of 10% of the total order value lot wise.</p> <p><b>Date of GR/LR shall be treated as actual delivery date for all purposes.</b></p>	
		<p><b>Loading for deviation in penalty for LD clause:</b> Please note that, in case of deviation in penalty clause, BHEL will evaluate your offer after loading on account of deviation in penalty. Loading will be done to the extent by which penalty clause is not agreed.</p>	
21.	<b>Risk Purchase:</b>	<p><b>Risk Purchase:</b> In case of abnormal delays (beyond the maximum late delivery period as per Penalty clause) in supplies / defective supplies or non-fulfillment of any other terms and conditions given in Purchase Order, BHEL may cancel the Purchase Order in full or part thereof, and may also make the purchase of such material from elsewhere / alternative source at the risk and cost of the supplier. BHEL will take all reasonable steps to get the material from alternate source at optimum cost. If bidder does not agree to the above Risk Purchase Clause, BHEL reserves the right to reject the offer. In case for compelling reasons BHEL accepts the offer without acceptance of this clause by the bidder and in the eventuality of Risk Purchase, appropriate action will be taken as per BHEL extant rules. This will be without prejudice to any other right of BHEL under the contract.</p> <p><b>Please note that deviation in Risk purchase clause shall not acceptable.</b></p>	
22.	<b>Arbitration clause:</b>	<p>In case of any dispute arising out of or in connection with this contract, the same shall be referred to arbitration under Arbitration &amp; Conciliation Act 1996 of a sole arbitrator who shall be appointed by mutual consent of the parties. The seat &amp; venue of arbitration shall be Haridwar. The proceedings shall be conducted in English. The governing law of the contract shall be the substantive Law of India.</p>	
23.	<b>Right of Acceptance :</b>	<p>BHEL reserves the right to reject any or all the quotations without assigning any reasons thereof. <b>BHEL also reserves the right to Increase or decrease the tendered quantities.</b> Vendors should be prepared to accept order for reduced Quantity without any extra charges. Vendor should also be prepared for giving discount in case of Increase in Quantity.</p>	
24.	<b>General Terms:</b>	<p>Ink signed order acceptance shall be furnished within 15 days of order placement. In case, order acceptance do not received within 15 days of order placement, PO deemed to be accepted by you.</p> <p>Confirm that Approx. Weight &amp; Volume of the packages has been mentioned in techno-Commercial Offer (Part-1).</p> <p>Confirm that prices will remain firm and fixed during the entire validity and execution of the project.</p> <p>Kindly confirm no technical deviation taken in submitted offer with respect to requirements mentioned in <b>BHEL technical Specification BHEL specification No. ST48012 Rev.07, ST33002 Rev. 02 &amp; Drg. No. 31339623010 Rev-01</b> (copy enclosed).</p> <p>Please note no revision in the prices or submission of supplementary price bid will be allowed during the validity of the offer. However, if there is any change by BHEL w.r.t. original specification/requirement/scope/terms and conditions, the bidders may be asked by BHEL to submit only the price impact bid for such changes only.</p>	
25.	<b>Documents submission:</b>	<p>Kindly confirm that quoted offer have been complied all technical requirements as given in tender documents and submit all documents to BHEL as per tender specifications and drawings without any deviations.</p>	

**Tender Enquiry No. B/4180/2019/4211V1 for the requirement of Calibration Jig**

26.	<b>Special Instruction:</b>	<b>Kindly confirm the following points:</b> <b>For Sagardighi Project: -</b> a) Item shall be dispatched in suitable “wooden boxes with multiple steel strips around” which can withstand transit movement, local environment & moisture/water. b) Maximum 05 Nos of boxes are allowed to dispatch the complete quantity. c) The SL No. of packing boxes shall be indicated by vendor from Box no BHEL/HWR/BOI/1026 to 1030 on each box. d) Kindly submit the Packing list (Box Wise) for BHEL review before dispatch.	
27.	<b>Special Instruction:</b>	<b>Kindly confirm the following points:</b> <b>For Khurja U-1&amp;2 Project: -</b> a) Item shall be dispatched in suitable “wooden boxes with multiple steel strips around” which can withstand transit movement, local environment & moisture/water.	
28.	<b>Manufacturing clearance</b>	In case of ordering, vendor has to take manufacturing clearance from BHEL before starting manufacturing of material. No manufacturing is to be started without getting clearance from BHEL. Kindly confirm.	
<b>Note:</b>		Please note that Prices are to be quoted in BOQ (Price Schedule format) provided in the portal. Prices are to be quoted on FOR destination basis. Kindly confirm that price has been quoted on FOR destination basis. Basic price quoted in BOQ shall be inclusive of Packing, Forwarding & Freight charges.	

**Signature of supplier with Seal**



## BHARAT HEAVY ELECTRICALS LIMITED

HEEP-HARIDWAR, UTTARAKHAND (249403)

General Instructions and Standard Terms & Conditions for bidding against Tender Enquiry (GISTC)

For Indian Bidders (Version June-2021, Rev: 06)

### Table of Contents

1. GENERAL .....	1
2. ORIGIN OF QUOTATION .....	1
3. SUBMISSION OF TENDER .....	1
4. TENDER OPENING .....	2
5. SPECIFICATION, DRAWINGS & STANDARD .....	2
6. PRICE SCHEDULE .....	3
7. REVERSE AUCTION .....	3
8. DELIVERY TERMS .....	3
9. LD FOR LATE DELIVERY .....	4
10. PAYMENT TERMS .....	4
11. TAXES & DUTIES .....	5
12. BANK GUARANTEE .....	6
13. GUARANTEE / WARRANTY AND CORRESPONDING REPAIRS / REPLACEMENT OF GOODS .....	6
14. QUALITY REQUIREMENT .....	6
15. VALIDITY .....	6
16. RIGHT OF ACCEPTANCE .....	6
17. TRANSIT INSURANCE .....	7
18. RISK PURCHASE .....	7
19. FORCE MAJEURE CLAUSE .....	7
20. NON-DISCLOSURE AGREEMENT .....	8
21. SETTLEMENT OF DISPUTES / ARBITRATION .....	8
22. WHARFAGE / DEMURRAGE RESPONSIBILITY .....	8
23. CONDITIONS FOR AVAILING MICRO & SMALL ENTERPRISES (MSE'S) BENEFITS .....	8
24. INFORMATION TO THE BIDDERS .....	10
25. MAKE IN INDIA (GOVT-NOTIFICATION) .....	10
26. RESTRICTIONS UNDER RULE 144(XI) OF THE GENERAL FINANCIAL RULES (GFRs), 2017 .....	12

27. NOTE..... 12

### 1. GENERAL.

These general terms & conditions shall apply to all the Tender Enquiries, notice inviting tenders, request for quotations concerning the supply of goods and / or rendering of services to Bharat Heavy Electricals Ltd., HEEP, Haridwar (hereinafter referred to as BHEL or the Purchaser). In case of placement of order these conditions will become part of Purchase Order (P.O) until unless the deviations are specifically agreed by BHEL.

### 2. ORIGIN OF QUOTATION.

- a) The quotation should preferably be from the principal bidder. However tender specific authorized registered dealer/agent can also submit the bid on their behalf, failing which the quotation is liable to be ignored. BHEL prefers to deal directly with the principal manufacturers.
- b) An agent cannot quote on behalf of more than one principal in the same Tender Enquiry.

### 3. SUBMISSION OF TENDER.

- a) Bid / Quotation must be enclosed in sealed cover on which tender enquiry number and the due date MUST BE written and be invariably sent under REGISTERED POST / SPEED POST / COURIER / Dropped in the Tender Box: addressed as follows:

Quotation against Enquiry No. \_\_\_\_\_

Dated: \_\_\_\_\_

Due on: \_\_\_\_\_

To,

**THE HEAD OF MATERIALS MANAGEMENT,  
Heavy Electrical Equipment Plant,  
Bharat Heavy Electricals Limited,  
HARIDWAR-249403 (Uttarakhand), INDIA.**

- b) TENDER ROOM is located at: Room No. - 415, 4<sup>th</sup> Floor, Main Admin. Building, BHEL-HEEP, Haridwar.

## Quotations / Bids not in accordance with General Instructions and Standard Terms & Conditions are likely to be ignored.



## BHARAT HEAVY ELECTRICALS LIMITED

HEEP-HARIDWAR, UTTARAKHAND (249403)

General Instructions and Standard Terms & Conditions for bidding against Tender Enquiry (GISTC)

For Indian Bidders (Version June-2021, Rev: 06)

- c) In case of Three / Two Part Bid, technical bid containing technical offer, duly signed and un-priced copy of the Price Bid should be kept in one envelope. Price Bid containing only the price should be kept in a separate envelope. All envelopes indicating Part-1 or Part-2 or Part-3 as the case may be to be put in a bigger envelope. Please note that un-priced bid should be the exact replica of price bid but without prices.
- d) The bid / quotation must be posted before due date, keeping allowance for postal transit time. Quotations sent by any mode but not received in time will be ignored. Tender received through authorized E-mail is also acceptable. However, in time submission of tender in tender box shall be the responsibility of the bidder, sent through any mode. Documents submitted with the offer / bid shall be signed and stamped in each page by authorized representative of the bidder.
- e) Any additional documents submitted by supplier / bidder, during processing of registration application / tender or after placement of order shall not be accepted unless it is submitted with forwarding letter and duly signed and stamped.
- f) The bids of the bidders who are on the banned list and also the bids of the bidders, who engage the services of the banned firms, shall be rejected. The cutting / overwriting in the bid / offer must be duly attested by the signatories to the bid. The list of firms banned by BHEL is available on BHEL web site [www.bhel.com](http://www.bhel.com).
- g) Being PMD vendor, if you are not quoting against this tender enquiry, please send your regret letter positively for our reference with valid reasons for not participating in the tender enquiry. Repeated lack of response on the part of bidder may lead to deletion such PMD vendor from BHEL's approved vendor list.
- h) The bidders will submit Integrity Pact, duly signed by its authorized signatory, along with their bids wherever estimated tender value is Rs. 2 Crore or more.
- i) In case of open tender, technically qualified unregistered bidders may apply online for registration through <http://www.bhel.com/index.php/vender>.
- j) BHEL reserves the right to award tendered quantities among more than one bidder (after acceptance of L1 price by the other bidders). BHEL can also consider awarding of part of the tendered quantity to other than L-1 bidder at L1 counter offered rates, if the quantity offered by the L-1 bidder is less than the quantity tendered for.
- k) In case of e-Tendering (Online bidding through e-portal), offline bid submitted in hard copy or in any other form by the vendor / supplier will not be accepted and will be rejected out rightly. Only e-portal bid will be accepted.

#### 4. TENDER OPENING.

Tender opening is scheduled to start in the Tender Room at 2:00 PM, on the due date. Therefore, bid / quotations must reach this office / tender Box latest by 1:45 PM on due date. Only participating bidders are allowed to attend tender opening. **TENDERS RECEIVED AFTER THE SPECIFIED TIME OF THEIR 'SUBMISSION' WILL BE TREATED AS LATE TENDERS AND SHALL NOT BE CONSIDERED UNDER ANY CIRCUMSTANCES.** The bidders or their authorized representatives may be allowed to attend tender opening if duly authorized by their principals, through a tender specific letter on that particular day. General authorization letter is not acceptable.

***Note: - Foreign bidders willing to attend the bid opening has to provide the requisite documents to the concerned Purchase executives for arranging gate pass for them.***

#### 5. SPECIFICATION, DRAWINGS & STANDARD.

- a) Bidders must give their detailed specification in the quotation along with relevant technical literature / catalogue etc. against the tender enquiry.
- b) The Bid should be accompanied with relevant copies of catalogues, drawings or specification as per tender enquiry.

## Quotations / Bids not in accordance with General Instructions and Standard Terms & Conditions are likely to be ignored.



## BHARAT HEAVY ELECTRICALS LIMITED

HEEP-HARIDWAR, UTTARAKHAND (249403)

General Instructions and Standard Terms & Conditions for bidding against Tender Enquiry (GISTC)

For Indian Bidders (Version June-2021, Rev: 06)

If these documents are not furnished, the offer is liable to be rejected.

- c) Wherever national / international (N/IN) standards are referred, the latest N/IN standards are to be followed. Mention year & date of standard revision that shall be followed for the supply.
- d) All Drawings and Standards are proprietary of BHEL. It must not be used in anyway detrimental to the interest of BHEL or without permission of BHEL.

### 6. PRICE SCHEDULE.

- a) Kindly quote your prices in figures and words both. In case of any discrepancy in value, the prices quoted in words shall be considered for evaluation and establishing L1 status.
- b) Prices quoted should not be more than the prices quoted to any other BHEL units / offices / divisions. Vendor to submit copy of latest Purchase Order placed by any unit of BHEL for similar items in the technical bid. In case no order has been placed on such items, specific confirmation that no order has been placed on such items should be provided.
- c) Prices should be quoted on F.O.R. Destination basis. Transit insurance shall be arranged by BHEL and not to be included in the prices. The offers quoted on other than F.O.R destination basis may result in non-consideration of such bids.
- d) In case BHEL accepts the EX-Works prices, such offers will be loaded by 1.5% of EX-Works value towards freight or with actual freight charges as per BHEL freight rate contract whichever is higher.
- e) In case of Indigenous items covered by DGS & D Rate Contract, the bidders should submit latest valid copy of the rate contract along with bid / quotation
- f) Applicable **IGST / CGST / SGST** and any other statutory levy should be indicated separately and clearly in the bid / quotation.

- g) Bidders can dispatch goods through any Indian Bank Association approved transporters having their branch at HARIDWAR / destination. If material is dispatched through other than Indian Bank Association approved transporter, material to be delivered on door delivery BHEL Stores basis.
- h) In case of dispatch of material through any other unapproved transporter, payment shall be made only after receipt of material and any additional charges payable to the transporter shall be to the bidder's account.
- i) Any demurrage / godown rent payable to the transporter / or to godown's owner due to any delay attributed by the supplier shall be recovered from supplier's account.
- j) Currency of Evaluation shall be INR.

**NB: Financial evaluation of L1, L2 .....Status will be on the basis of Landed Cost to BHEL.**

### 7. REVERSE AUCTION.

**Wherever RA is declared in the special terms and conditions of tender enquiry, following shall be applicable and Bidders to confirm the same:**

"BHEL shall be resorting to Reverse Auction (RA) (Guidelines as available on [www.bhel.com](http://www.bhel.com)) for this tender. RA shall be conducted among all the techno-commercially qualified bidders.

Price bids of all techno-commercially qualified bidders shall be opened and same shall be considered as initial bids of bidders in RA. In case any bidder(s) do(es) not participate in online Reverse Auction, their sealed envelope price bid along with applicable loading, if any, shall be considered for ranking."

### 8. DELIVERY TERMS.

- a) Goods shall be delivered on 'FOR Destination' basis to the named destination unless otherwise called for in the tender enquiry.
- b) Loading on account of 3rd party inspection charges in case of Indian bidders shall be 0.20%.



## BHARAT HEAVY ELECTRICALS LIMITED

HEEP-HARIDWAR, UTTARAKHAND (249403)

General Instructions and Standard Terms & Conditions for bidding against Tender Enquiry (GISTC)

For Indian Bidders (Version June-2021, Rev: 06)

### 9. LIQUIDATED DAMAGES (LD) FOR LATE DELIVERY.

#### a) Where items of Purchase Order are independently usable.

Liquidated Damages (LD) for Late Deliveries shall be applicable @0.5% per week or part thereof on the value of respective delayed supplies subject to a maximum of 10% of the value of respective delayed supplies. Value of delayed supplies will mean the Gross Value payable to the vendor (Before LD) against such supplies excluding taxes and duties.

#### b) Where the total items are required for a main equipment and items are interdependent.

Liquidated Damages (LD) for Late Deliveries shall be applicable @0.5% per week or part thereof on total value of Purchase Order subject to maximum of 10% of the total value of Purchase Order. Purchase Order value for this purpose shall be the Total Gross Value payable to the vendor (Before LD) excluding taxes and duties.

#### c) Bidders are requested to quote the best delivery meeting the delivery requirements. BHEL reserves the right to reject the offers not meeting BHEL's delivery requirement.

#### d) Commencement of delivery period shall be reckoned from the date of PO / LOI or any other agreed milestone.

#### e) Bidder shall deliver the goods in the manner and schedule agreed under the terms and conditions of Purchase order.

#### f) DELIVERY IN CASE OF REJECTION: In case the material is rejected, then date of replacement will be considered as the actual date of delivery.

#### g) DELIVERY AGAINST BANK DOCUMENTS: In case payment terms quoted by bidder are documents through bank, and the delivery terms being "FOR Haridwar / FOR Transporter Go-down" then date of delivery will be date of intimation by transporter / bidder of delivery of material at Haridwar for the LD purpose.

#### h) Where the payments are through bank, the documents may be presented for negotiation to BHEL authorized / nominated bank.

i) Payment of Liquidated Damages (LD) shall not in any way relieve the vendor from any of its obligations & liabilities under the contract.

### 10. PAYMENT TERMS.

a) BHEL's standard payment term is Payment after receipt and acceptance of materials / items at HEEP, BHEL-Store or at desired destination unless otherwise specified in Special Terms attached to the tender enquiry.

b) BHEL reserves the right to accept or reject the offer of the bidder who quotes the payment term other than BHEL's standard payment term.

c) Loading on account of deviation in payment terms shall be done as per extant rules of BHEL-Haridwar.

d) 100% payment along with taxes, freight & insurance will be made after receipt and acceptance of material and within 75 days from the date of invoice subject to submission of non-discrepant documents within 15 days of supply as per terms and conditions of Purchase Order. In case any discrepancy found in the documents, BHEL will notify the same to vendor within 7 days of receipt. Vendor has to clear all the discrepancies in one go within 7 days thereafter else the payment of vendor may get delayed.

e) For MSEs (covered under MSME Act) which are registered and periodically renewed with BHEL, the payment will be made within 45 days or as prescribed in the relevant act.

f) Adherence to the above time schedule of payment is contingent upon Vendor complying with GST Rules w.r.t availment of Input Tax Credit by BHEL.

g) In case GST credit is delayed / denied to BHEL, due to non / delayed receipt of goods and / or tax invoice or expiry of the timeline prescribed in GST Law for availing such ITC, or any other reason not attributable to BHEL, GST amount shall be recoverable from Vendor along with interest levied / leviable on BHEL.

h) The taxes and duties that are reimbursed would be the ones applicable as on the contractual Purchase order delivery date or the amount actually paid whichever is less.

## Quotations / Bids not in accordance with General Instructions and Standard Terms & Conditions are likely to be ignored.



## BHARAT HEAVY ELECTRICALS LIMITED

HEEP-HARIDWAR, UTTARAKHAND (249403)

General Instructions and Standard Terms & Conditions for bidding against Tender Enquiry (GISTC)

For Indian Bidders (Version June-2021, Rev: 06)

i) **The loading criteria for the different payment terms shall be as under;**

Payment Terms	Days of Loading
After Receipt & Acceptance of material within 75 days of supply.	<b>No Loading</b>
Against Delivery at BHEL-Stores Haridwar.	<b>45</b>
Against documents through bank (CAD):	<b>45</b>
Letter of Credit (LC)	<b>120</b>
Usance LC	No Loading if usance period is > 120 Days.
	Loading of days' difference i.e. difference between 120 days and usance period if the usance period is < 75 days.
Advance	Delivery Period + 120 Days - Advance Payment Days.

### 11. TAXES & DUTIES.

- a) The bidder to specify in their offer (part 1 bid) the category of their registration under GST like Registered, Unregistered and composite dealer.
- b) The provisional GST registration number of Bharat Heavy Electrical Ltd, Heavy Electricals Equipment Plant, Ranipur, Haridwar is "05AAACB4146P1ZL" with state Code as "05" and State Name as "Uttarakhand".
- c) Please quote our provisional GST registration number in all invoices raised for supply of goods and services under GST regime and also ensure filing of timely return and payment of tax and compliance of other applicable provisions on supplier under GST regime.
- d) No GST will be reimbursed to unregistered or composite dealer. In the event, any GST is quoted by composite dealer, the same shall be added to the cost of supply in evaluating the bid.
- e) Since, input credit of GST will be available to BHEL-Haridwar only after correct filing of return and payment of applicable GST by supplier, reimbursement of GST shall be made by

BHEL-Haridwar on matching of vendor inputs at GST portal, ensuring availability of input credit to BHEL Haridwar. Payment of GST will be made to vendor after matching of input credit and vendor to ensure submission of their invoices along with consent to accept payment of tax after such matching in all cases where bills are submitted directly to BHEL-Haridwar or through bank or under LC or through any other mode.

- f) In the event of any disallowance of input credit or applicability of interest or any other financial liability arises on BHEL-Haridwar due to any default of supplier under GST, such implication shall be to supplier's account.
- g) In the event of any change in the status of the vendor after the submission of the bid but before the supply, GST applicable at the time of supply or in the bid, based on the registration status of the vendor, whichever is lower shall be payable.
- h) Where ever applicable If PAN (Permanent Account Number) of the recipient is not available, income tax is deductible either at the normal rate or at the rate of 20 percent, whichever is higher as per Section 206AA of Indian Income Tax Act 1961.
- i) The bidder shall clearly indicate HSN (*Harmonised System Nomenclature*) / SAC (*Service Accounting Code*), its description and applicable rate of GST for each item in his techno-commercial bid.
- j) Statutory Variation in Taxes & duties as applicable at the time of supply shall be payable. However, in the event of no change in law but bidder quoting certain tax structure in bid document which is lower than the applicable one, such amount shall be the maximum amount of tax that can be claimed by bidder.
- k) **IMPORTED GOODS OFFERED BY INDIAN BIDDERS AGAINST DEALER INVOICE:** Wherever the material being offered is imported, the bidder must quote the prices inclusive of IGST. The rate and value of IGST as included in the price must be indicated separately. In case quantum of IGST is not mentioned by the bidder the same will not be considered for



## BHARAT HEAVY ELECTRICALS LIMITED

HEEP-HARIDWAR, UTTARAKHAND (249403)

General Instructions and Standard Terms & Conditions for bidding against Tender Enquiry (GISTC)

For Indian Bidders (Version June-2021, Rev: 06)

evaluation. However, bidder will have to pass on the benefit of IGST to BHEL at the time supply.

- l) In case of directly dispatchable items to Customer's Site, BHEL-Haridwar will inform the GST registration number of the respective customer which must be mentioned on the vendor's invoice. Vendor to ensure availability of such information from BHEL-Haridwar before dispatch of any material. However, while filing GSTN-1, BHEL Haridwar GSTN number to be quoted.

Note: - Vendors must ensure compliance of all the applicable rules and procedure as envisaged in the GST Regime. Any loss to BHEL-Haridwar due to fault / non-compliance by the vendor will be to the vendor's account.

### 12. BANK GUARANTEE.

In case the bank guarantees are required to be deposited towards security deposit/performance guarantee or for any other purpose as per the terms of this tender enquiry, such bank guarantees of the requisite value in the denominated currency of the purchase order should be from one of the Indian branch of BHEL consortium banks and the bank guarantee should be in the proforma as prescribed by BHEL. The proforma of bank guarantee and the list of consortium banks are displayed at BHEL website www.bhelhwr.co.in. However, in case the bank guarantee is not from BHEL consortium banks, then the bidder has to get the bank guarantee confirmed from one of the Indian branch of BHEL consortium banks and the bank charges for such confirmation will be borne by the bidder.

### 13. GUARANTEE / WARRANTY AND CORRESPONDING REPAIRS / REPLACEMENT OF GOODS.

Goods shall comply with the specifications for material, workmanship and performance. Unless otherwise specified, the warranty shall be for a period of 18 months from the date of receipt. If the delivery is found non-compliant during the warranty period, leading to rejection, the Seller shall arrange free replacement / repair of goods, within one month from the date of intimation or any mutually agreed period. The rejected goods shall be taken away by the Seller at his cost and

replaced on Delivered Duty Paid (DDP) (FOR - BHEL Stores / designated destination basis) within such period. In the event of the Seller's failure to comply, Purchaser may take action as appropriate, including Repair / Replenish rejected goods & disposal of rejections, at the risk & cost of the Seller. In case the defects attributable to Seller are detected during processing of the goods at BHEL or at our subcontractor's works, the Seller shall be responsible for free replacement / repair of the goods as required by BHEL.

- b) **RETURN OF REJECTED MATERIAL FOR REPLACEMENT:** The bidder shall have to pay 5% incidental charges while taking back supplied material if it is found rejected on receipt. The rejected material shall be sent back only after receipt of replacement / submission of BG / refund of amount paid.

### 14. QUALITY REQUIREMENT.

Your bid / quotation should have specific confirmation regarding meeting all our quality requirements such as. (i) Test Certificate (TC), (ii) Guarantee Certificate (GC) / Warranty Certificate (WC), (iii) Quality Plan (QP) (if applicable); and (iv) Pre-Dispatch Inspection at your works (if applicable).

### 15. VALIDITY.

The quotation should be valid for a minimum period of 90 days effective from the date of opening of tender, unless otherwise specified in the tender enquiry.

### 16. RIGHT OF ACCEPTANCE.

- a) **BHARAT HEAVY ELECTRICALS LIMITED HARIDWAR** reserves the right to reject any or all the bids / quotations without assigning any reason thereof. BHEL also reserves the right to increase or decrease the tendered quantities. Bidders should be prepared to accept order for reduced quantity without any extra charges.
- b) Any discount / revised offer / bids submitted by a bidder on its own shall be considered, provided it is received on or before the due date and time of offer / bid submission (Part-1). Conditional discounts shall not be considered for evaluation of tenders.



## BHARAT HEAVY ELECTRICALS LIMITED

HEEP-HARIDWAR, UTTARAKHAND (249403)

General Instructions and Standard Terms & Conditions for bidding against Tender Enquiry (GISTC)

For Indian Bidders (Version June-2021, Rev: 06)

- c) Unsolicited discounts / revised offers / bids given after Part-1 bid opening shall not be accepted. No change in price will be permitted within the validity period asked for in the tender enquiry.
- d) In case of changes in scope and / or technical specification and / or commercial terms & conditions having price implication, techno-commercially acceptable bidders shall be asked by BHEL to submit the impact of such changes on their price bids. In case a bidder opts to submit revised price bid instead of impact called for then the latest price bid shall prevail. However, in both situations, original price bid will be necessarily opened.
- e) The bidder whose bid is technically not accepted will be informed & EMD wherever submitted shall be returned after finalization of contract. EMD shall be forfeited in the event of bidder opting out after tender opening.
- f) BHEL reserves the right to short close the existing Purchase Order / Rate Contract / Work Order or any extension thereof at any stage.

### 17. TRANSIT INSURANCE.

- a) Transit Insurance will be covered by BHEL under its open Insurance Policy. Seller shall inform dispatch particulars (Purchase Order, RR /GR, Invoice value etc.) to "Finance department (Store bill Section), BHEL Ranipur, Haridwar (Uttarakhand-India) with value of consignment to the Purchaser within 07 days of dispatch for BHEL to arrange insurance coverage in its policy. Failure on the part of seller to inform dispatch particulars will make him liable to pay for any transit damages / losses suffered by the Purchaser.
- b) If Quoted Prices are inclusive of transit insurance, no weightage shall be given while evaluating the bids for Cost of Insurance, being in BHEL Scope.

### 18. RISK PURCHASE.

In case of abnormal delays (beyond the maximum late delivery period as per LD clause) in supplies / defective supplies or non-fulfillment of any other terms and conditions given in Purchase Order, BHEL may cancel the Purchase Order in full or part thereof, and may also make the purchase of such material from elsewhere / alternative source at the risk and cost of the supplier. BHEL will take all reasonable steps to get the material from alternate source at optimum cost. If bidder does not agree to the above Risk Purchase Clause, BHEL reserves the right to reject the offer. In case for compelling reasons BHEL accepts the offer without acceptance of this clause by the bidder and in the eventuality of Risk Purchase, appropriate action will be taken as per BHEL extant rules. This will be without prejudice to any other right of BHEL under the contract or under General Law.

### 19. FORCE MAJEURE CLAUSE.

Notwithstanding any other thing contained anywhere else in the contract or PO (Purchase Order), In case the discharge of obligation under the contract by either party is impeded or made unreasonably onerous, neither party shall be considered in breach of the contract to the extent that performance of their respective obligation is prevented by an event of Force Majeure that arises after the effective date (PO date).

In the above clause, Force Majeure means an event beyond the control of the parties to the contract which prevents a party from complying with any obligation of the contract including but not limited to:

- Act of God (Such as but not limited to earthquake, drought, tidal waves, floods etc.).
- War (whether war be declared or not), Hostilities Invasion, Act of foreign enemy etc.
- Rebellion, revolution, insurrection, civil war etc.
- Contamination of Radio Activity from any nuclear fuel or from any other nuclear waste or any other hazardous materials.
- Riots, commotions, strike unless restricted to the employees of supplier.
- Acts of terrorism.



## BHARAT HEAVY ELECTRICALS LIMITED

HEEP-HARIDWAR, UTTARAKHAND (249403)

General Instructions and Standard Terms & Conditions for bidding against Tender Enquiry (GISTIC)

For Indian Bidders (Version June-2021, Rev: 06)

- g) Other unforeseeable circumstances beyond the control of the parties and which the affected party cannot avoid even by using its best efforts.
- h) Cancellation of contract by customer.
- i) Change in law / government. Regulation making the performance impossible.
- j) Pandemic or Epidemic.

The party claiming to be affected by force majeure shall notify the other party in writing immediately without delay on the intervention and on the cessation of such circumstances.

Irrespective of any extension of time, if an event of force majeure occurs and its effect continues for more than 180 days the affected party shall have right to cancel the contract.

As soon as reasonably practicable following the date of commencement of a Force Majeure Event, and within a reasonable time following the date of termination of a Force Majeure Event, either Party invoking it shall submit to the other Party reasonable proof of the nature of the Force Majeure Event and of its effect upon the performance of the Party's obligations under this Agreement.

The party shall, and shall ensure that its Subcontractors shall, at all times take all reasonable steps within their respective powers and consistent with Good Operating Practices (but without incurring unreasonable additional costs) to:

- a) Prevent Force Majeure Events affecting the performance of the party's obligations under this Agreement.
- b) mitigate the effect of any Force Majeure Event and
- c) Comply with its obligations under this Agreement.

If the war like situation has developed in a country where a seller's works is located in this P.O. or there is political instability and Indian Embassy located in that country forbids or advises for not having any business dealing with the sellers located in such zone / region/ country, then BHEL reserves the right to cancel the order.

### **20. NON-DISCLOSURE AGREEMENT.**

All Drawing and Technical Documents relating to the product or it's manufacture submitted by one party to the other, prior or

subsequent to the formation of contract, shall remain property of the submitting party. Drawing, technical documents or other technical information received by one party, shall not without the consent of the other party, be used for any other purpose than that, for which they were provided. Such technical information shall not without the consent of the submitting party, otherwise be used or copied, reproduced, transmitted or communicated to a third party. Patterns supplied by BHEL will remain BHEL's property which shall be returned by the bidder on demand to BHEL. Bidder shall in no way share or use such intellectual property of BHEL to promote his own business with others or to gain a commercial advantage. BHEL reserves the right to claim damages from the bidder, or take appropriate action as deemed fit against the bidder, for any infringement of the provisions contained herein as available under law or equity.

### **21. SETTLEMENT OF DISPUTES / ARBITRATION.**

In case of any dispute arising out of as in connection with this contract, the same shall be referred to arbitration under Arbitration & Conciliation Act 1996 of a sole arbitrator who shall be appointed by mutual consent of the parties. The seat & venue of arbitration shall be Haridwar.

The proceedings shall be conducted in English. The Governing law of contract shall be the substantive law of India.

### **22. WHARFAGE / DEMURRAGE RESPONSIBILITY.**

In the event of delay in receipt of documents by Manager (Stores-Shipping) BHEL-Haridwar and in case where dispatches are made through Unapproved Transporter the sole responsibility for wharfage / demurrage for such delay shall be that of supplier.

### **23. CONDITIONS FOR AVAILING MICRO & SMALL ENTERPRISES (MSE'S) BENEFITS.**

- a) "MSE Suppliers can avail the intended benefits only if they submit along with the offer, attested copies of either EM II certificate having deemed validity (**five years** from the date of issue of acknowledgement in EM II) or valid NSIC certificate or EM II certificate along with attested copy of a CA certificate



## BHARAT HEAVY ELECTRICALS LIMITED

HEEP-HARIDWAR, UTTARAKHAND (249403)

General Instructions and Standard Terms & Conditions for bidding against Tender Enquiry (GISTC)

For Indian Bidders (Version June-2021, Rev: 06)

(Format enclosed at annexure-1 where deemed validity of EM II certificate of five years has expired) applicable for the relevant financial year (latest audited). Date to be reckoned for determining the deemed validity will be the date of bid opening (Part 1 in case of two-part bid) or vendor has to give Udyog Adhar Memorandum (UAM). Non submission of such documents will lead to consideration of their bid at par with other bidders. No benefit shall be applicable for this enquiry if any deficiency in the above required documents is found or the requisite documents are not submitted before price bid opening. If the tender is to be submitted through e-procurement portal, then the above require document are to be uploaded on the portal. Documents should be notarized or attested by a Gazetted officer. **UAM need not required to be notarized or attested.**

**b)** Any new supplier will be eligible for registration with BHEL as MSE supplier provided at least any one of the following documents are submitted along with application for registration: -

1. Udyog Adhar Memorandum (UAM).
2. Valid National Small Industries Commission (NSIC) Certificate.
3. Entrepreneurs Memorandum part II (EM II) certificate (valid based on deemed validity of 5 years) or
4. EM II certificate along with attested copy of CA Certificate (as per prescribed format at annexure-A) applicable for the relevant financial year (latest audited), where the deemed validity of EM II is over.
5. However, credentials of all MSE suppliers will be verified before advancing the intended benefits.
6. MSE bidders claiming SC/ST status will have to submit SC/ST certificate of the Proprietor from competent authority. Attested (notarized or attested by Gazetted officer) copy to be submitted along with the offer.
7. In case techno-commercial accepted bidders include MSE source and their prices (based on landed cost – considering quoted prices) are within the price band of 15% w.r.t. L-1 bidder, then BHEL can offer **25%** of quantity of respective item (rounded off to nearest number) to MSE bidders at L-1 price and in case, more than one MSE bidder is in 15 % band and the same is accepted by more than one MSE bidders then **25%** quantities of respective items will be considered for ordering on proportionate basis amongst MSE bidders.

8. There will be minimum of **3%** reservation for women owned MSEs within the above mentioned 25% reservation.
9. The reservation for MSEs owned by SC/ST will be **6.25%** { 25% out of target of 25% - refer para 4 of Public Procurement Policy for the Micro and Small Enterprises(MSEs)}.
10. The definition of MSEs owned by Women Entrepreneurs is clarified as under:
  - a) In case of proprietary MSE, proprietor shall be Woman.
  - b) In case of partnership MSE, the Woman partners shall be holding at least 51% of share in the unit.
  - c) In case of Private Limited companies, at least 51% share shall be held by Women promoters.
11. The definition of MSEs owned by SC/ST is clarified as under:
  - a) In case of proprietary MSE, proprietor(s) shall be SC/ST.
  - b) In case of partnership MSE, the SC/ST partners shall be holding at least 51% of shares in the unit.
  - c) In case of Private Limited companies, at least 51% share shall be held by SC/ST promoters.
12. While distributing the **25%** quantity amongst MSE bidders the decimal points in quantity shall be ignored for all the bidders except the L-1 amongst MSE bidders. Balance quantity after allocating the quantity to other MSE bidders ignoring the quantities in decimal, shall be given to L-1 (amongst MSE) bidder. However, if there are more than one MSE bidder at the same price level than preference for additional quantities due to ignoring off the decimal (as mentioned above) shall be given to the bidder offering favorable terms to BHEL and if the conditions offered are also same then preference will be given to the bidder having high SPR rating.
13. In case there are more than one MSE bidders (with different landed cost to BHEL) within 15% price band of lowest bidder and quantity to be offered is 1 no. only, then preference shall be given to the MSE bidder with lowest landed cost.
14. In case there are more than one MSE bidders (with same landed cost to BHEL) within 15% price band of lowest bidder and quantity to be offered is 1 no. only, then preference shall be given first, based on the favorable terms in the bid and in case terms are also same, the bidder with high SPR rating shall be given preference.
15. If L1 bidder is MSE bidder, entire quantity will be given to such MSE bidder only.



## BHARAT HEAVY ELECTRICALS LIMITED

HEEP-HARIDWAR, UTTARAKHAND (249403)

General Instructions and Standard Terms & Conditions for bidding against Tender Enquiry (GISTIC)

For Indian Bidders (Version June-2021, Rev: 06)

16. Note: It may however be noted that MSE guidelines as on date (Date of Technical Bid Opening Part-1) shall prevail.

17. "As per the OM No. F.No. 1(2)(1)/2016-MA dtd. 09.02.2017 issued from the Office of Development Commissioner (Micro, Small & Medium Enterprises), "Traders and agents should not be allowed to avail the benefits extended under the PP Policy."

In view of this, it is clarified that benefits of MSE (such as EMD Waiver, Tender fee exemption, Price preference, Payment preference etc.) will be given only to those MSE Vendors who are manufacturers of offered items against the NIT. No MSE benefits shall be provided to Agents / Stockists / Dealers / Traders etc. for the items offered but not manufactured by themselves."

#### 24. INFORMATION TO THE BIDDERS.

a) Purchase related information is available at our Business-to-Business (B2B) Portal available on our website <https://hwr.bhel.com>. The user ID & password can be obtained by sending a request to concerned purchase executives.

b) Intimate your change in mail address or communication address or changes, if any, by email to AGM (SDX/MM) giving your bidder Code.

c) Please resolve your rejections and unexecuted overdue purchase order immediately which are posted at our B2B Portal, which can be visited through our site <https://hwr.bhel.com>

d) Copy of this Tender Enquiry is being sent through the post.

e) The Bidder declares that they will not enter into any illegal or undisclosed agreement or understanding, whether formal or informal with other bidder(s). This applies in particular to prices, specifications, certifications, subsidiary contracts, submission or non-submission of bids or any other actions to restrict competitiveness or to introduce cartelization in the bidding process.

In case, the bidder is found having indulged in above activities, suitable action shall be taken by BHEL as per extant policies/guidelines.

f) Supplier must upload digitally signed e-Invoice on B2B portal for processing of Bills.

In other cases, inked signed hard copy of Invoice to be submitted for processing of Bills.

#### 25. MAKE IN INDIA (GOVT-NOTIFICATION).

A. This tender enquiry shall be governed by notification no. P-45021/2/2017-PP (BE-II) dated 04.06.2020 of government of INDIA and subsequent circulars issued afterwards. Accordingly, the minimum local content, the margin of purchase preference and the procedure for preference to make in INDIA shall be adhered.

B. The margin of purchase preference shall be 20%.

- 'Class-I local Supplier' means a supplier or service provider, whose goods, services or works offered for procurement, has local content equal to or more than 50%, as defined under this order.
- 'Class-II local Supplier' means a supplier or service provider, whose goods, services or works offered for procurement, has local content more than 20% but less than 50%, as defined under this order.
- 'Non- local Supplier' means a supplier or service provider, whose goods, services or works offered for procurement, has local content less than or equal to 20%, as defined under this order.

C. Vendor to specifically confirm if they are Class-I or Class-II local supplier or not as per above mentioned notification. Accordingly, the 'Class-I local supplier' / 'Class-II local Supplier' at the time of tender, bidding or solicitation shall be required to indicate percentage of local content and provide self-certification that the item offered meets the local content requirement for 'Class-I local supplier' / 'Class-II local Supplier', as the case may be. They shall also give details of the location(s) at which the local value addition is made.

D. In cases of Procurement for a Value in Excess of Rs. 10 Crores, the 'Class-I local supplier' / 'Class-II local Supplier' shall be required to provide a Certificate from the Statutory Auditor or Cost Auditor of the Company (in the case of companies) or from a practicing Cost Accountant or practicing Chartered Accountant (in respect of suppliers other than companies) giving the percentage of Local Content.



## BHARAT HEAVY ELECTRICALS LIMITED

HEEP-HARIDWAR, UTTARAKHAND (249403)

General Instructions and Standard Terms & Conditions for bidding against Tender Enquiry (GISTC)

For Indian Bidders (Version June-2021, Rev: 06)

### E. Requirement of Purchase Preference:

Purchase preference shall be given to 'Class-I local supplier' in procurements undertaken by procuring entities in the manner specified hereunder -

a. In the procurements of goods or works, which are covered by para 3(b) of mentioned Govt. circular and which are divisible in nature, the 'class-I local supplier' shall get purchase preference over 'Class-II supplier' as well as 'Non-local supplier', as per following procedure:

- i. Among All qualified bids, the lowest bid will be termed as L1. If L1 is 'Class-I local supplier', the contract for full quantity will be awarded to L1.
- ii. If L1 bid is not a 'Class-I local supplier', 50% of the order quantity shall be awarded to L1. Thereafter, the lowest bidder among the 'Class-I local supplier' will be invited to match the L1 price for the remaining 50% quantity subject to the class-I local supplier's quoted price falling within the margin of purchase preference, and contract for that quantity shall be awarded to such 'Class-I local supplier' subject to matching the L1 price. In case such lowest eligible 'Class-I local supplier' fails to match the L1 price or accepts less than the offered quantity, the next higher 'Class-I local supplier' within the margin of purchase preference shall be invited to match the L1 price for remaining quantity and so on, and contract shall be awarded accordingly. In case some quantity is still left uncovered on Class-I local supplier, then such balance quantity may also be ordered on the L1 bidder".

b. In the procurements of goods or works, which are covered by para 3(b) of mentioned Govt. circular and which are not divisible in nature, and in procurement of services where the bid is evaluated on price alone, the 'class-I local supplier' shall get purchase preference over 'Class-II supplier' as well as 'Non-local supplier', as per following procedure:

- i. Among all qualified bids, the lowest bid will be termed as L1. If L1 is 'Class-I local supplier', the contract will be awarded to L1.
- ii. If L1 is not 'Class-I local supplier', the lowest bidder among the 'Class-I local supplier', will be invited to match the L1 price subject to Class-I local supplier's quoted price falling

within the margin of purchase preference, and the contract shall be awarded to such 'Class-I local supplier' subject to matching the L1 price.

- iii. In case such lowest eligible 'Class-I local supplier', fails to match the L1 price, the 'Class-I local supplier' with the next higher bid within the margin of purchase preference shall be invited to match the L1 price and so on and contract shall be awarded accordingly. In case none of the 'Class-I local supplier' within the margin of purchase preference matches the L1 prices, the contract may be awarded to the L1 bidder.

c. 'Class-II local supplier' will not get purchase preference in any procurement, undertaken by procuring entities.

F. For this procurement, the local content to categorize a supplier as a Class-I local supplier/ Class-II local supplier/ Non-local supplier and purchase preference to Class-I local supplier, is as defined in Public Procurement (Preference to Make in India), Order 2017 dated 04.06.2020 issued by DPIIT. In case of subsequent orders issued by nodal ministry, changing the definition of local content for the items of the NIT, the same shall be applicable even if issued after issue of this NIT, but before opening of Part-II bids against this NIT.

G. Procurements where estimated value to be procured is less than Rs. 5 lakhs shall be exempted from GOI order No. P-45021/2/2017-PP (BE-II) dated 04.06.2020.

H. For procurement of Goods & Services which are divisible in nature, following shall be operated for **MSE bidders** under Public procurement Policy for the Micro and Small Enterprises (MSEs) Amendment Order, 2019, Ref. No. AA:SSP: MSE: Amndt, dtd. 30.11.2018, Circular No. 44 of 2018-19;-

a. If L1 bid is not from "Class-I local Supplier" and price quoted by MSE bidder falls within the margin of Purchase preference (L1+15% for MSEs), then 25 % of total order quantity of respective item (rounded off to nearest number) shall be awarded to MSE bidder, subject to MSE bidder matching the L1 Price. Out of Remaining 75% quantity, distribution shall be operated as per below sub-clause (2) –

b. If "Class- I Local Supplier" (Next to L1, other than MSE) quoted price falling within the Margin of Purchase Preference, and "Class-I local supplier" matches the L1 price,



## BHARAT HEAVY ELECTRICALS LIMITED

HEEP-HARIDWAR, UTTARAKHAND (249403)

General Instructions and Standard Terms & Conditions for bidding against Tender Enquiry (GISTC)

For Indian Bidders (Version June-2021, Rev: 06)

then 50% of remaining Quantity (after allocation of 25% to MSE) i.e. 37.5% shall be awarded to local supplier and 37.5% shall be awarded to foreign bidder.

*Note: L1 Price refers to lowest evaluated / landed cost to Company.*

For Further details, please refer GOI order no. P-45021 / 2 / 2017 - PP (BE-II) dated 04.06.2020.

### 26. RESTRICTIONS UNDER RULE 144(XI) OF THE GENERAL FINANCIAL RULES (GFRs), 2017

All provisions of Order No. F.No.6/18/2019-PPD of Department of Expenditure (DoE) shall be applicable for this tender enquiry (Order copy is available at <https://doe.gov.in/procurement-policy-divisions>). Accordingly, any bidder from a country which shares a land border with India (except the countries to which the Govt. of India has extended lines of credit or in which the Govt. of India is engaged in development projects for which list is available at <https://www.mea.gov.in/>) will be eligible to bid in this tender only if the bidder is registered with the Competent Authority as specified in Annex I of the said Order of DoE.

Updated list of the countries to which lines of credit have been extended or in which development projects are undertaken are available on the Ministry of External affairs website (<https://www.mea.gov.in/>)

For the purpose of this order, definition of Bidder from a country which shares a land border with India shall be same as defined in the Annex III of the said order.

Registration with the competent authority as stipulated in the said order is responsibility of bidder. Bidder has to submit a certificate certifying following along with offer:

"I have read the clause regarding restrictions on procurement from a bidder of a country which shares a land border with India; I certify that bidder (.... Name of Bidder) is not from such a country or, if from such a country, has been registered with the Competent Authority. I hereby certify that bidder (.....Name of bidder) fulfils all requirements in this regard and is eligible to be considered"

If the bidder is from such country which shares a land border with India evidence of valid registration by the Competent Authority shall also be attached along with offer."

### 27. NOTE.

- a) Special conditions of enquiry, if enclosed by BHEL, will supersede the respective standard / general terms of enquiry.
- b) Any other Standard terms and Conditions of the bidder attached / referred against the tender enquiry will be treated as null and void ab initio.
- c) In order to protect the commercial interests of BHEL, it becomes necessary to take action against suppliers / contractors by way of suspension of business dealings, who either fail to perform or are in default without any reasonable cause, cause loss of business / money / reputation, indulged in malpractices, cheating, bribery, fraud or any other misconducts or formation of cartel so as to influence the bidding process or influence the price etc. Guide- lines for Suspension of Business Dealings with Suppliers / Contractors shall prevail over which is available at BHEL website <http://www.bhel.com>
- d) The bidder along with its associate / collaborators / sub-contractors / sub-vendors / consultants / service providers shall strictly adhere to BHEL Fraud Prevention Policy displayed on BHEL website <http://www.bhel.com> and shall immediately bring to the notice of BHEL-Management about any fraud or suspected fraud as soon as it comes to their notice.
- e) "BHEL shall recover the amount of compensation paid to victim(s) by BHEL towards loss of life / permanent disability due to an accident which is attributable to the negligence of contractor, agency or firm or any of its employees as detailed below;
  1. **Victim:** Any person who suffers permanent disablement or dies in an accident as defined below.
  2. **Accident:** Any death or permanent disability resulting solely and directly from any unintended and unforeseen injurious

## Quotations / Bids not in accordance with General Instructions and Standard Terms & Conditions are likely to be ignored.



## BHARAT HEAVY ELECTRICALS LIMITED

HEEP-HARIDWAR, UTTARAKHAND (249403)

General Instructions and Standard Terms & Conditions for bidding against Tender Enquiry (GISTC)

For Indian Bidders (Version June-2021, Rev: 06)

occurrence caused during the manufacturing / operation and works incidental thereto at BHEL factories/ **offices and precincts** thereof , project execution , erection and commissioning, services, repairs and maintenance, trouble shooting, serving , overhaul, renovation and retrofitting , trial operation, performance guarantee testing undertaken by the company or during any works / during working at BHEL Units/ Offices/ townships and premises/ project sites.

### 3. Compensation in respect of each of the victims:

- (i) In the event of death or **permanent disability** resulting from **Loss of both limbs**: Rs. 10,00,000/- (Rs. Ten Lakh).
- (ii) In the event of **other permanent disability**: Rs. 7,00,000/- (Rs. Seven Lakh).

4. Permanent Disablement: A disablement that is classified as a permanent total disablement under the proviso to Section 2(l) of the Employees Compensation Act, 1923.”

f) The bidder shall be in compliance with applicable laws, rules and regulations throughout the terms of the contract for conducting its business generally and to perform its obligations under this contract.

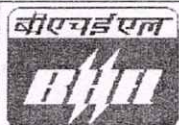
**BHARAT HEAVY ELECTRICALS LIMITED, HARIDWAR**

Control &amp; Instrumentation Engineering (CIE)

**PRE-QUALIFICATION REQUIREMENT**  
Brief Description- Calibration Jig for Steam Turbine ApplicationsDOCUMENT NO.  
CIE/CJ/PQR/20194211 R00,  
20210108 R00  
Dt: 12/02/2022

Brief Description : Calibration Jig

BHEL Material Code: W90313396248

SR. NO.	PRE-QUALIFICATION REQUIREMENTS	VENDOR RESPONSE
1.	Bidder to confirm manufacturing capability of Calibration Jig, which is required for calibration of Level Switch. The chamber of Calibration Jig should be suitable for Servo prime 46 of IOC /Turbine Oil -46 of H.P. Bidder to confirm.	
2.	Bidder should have minimum One-year experience of Design, Manufacturing and Supply of Calibration Jig or similar item, on date of enquiry. Bidder to confirm along with supporting documents i.e. Catalogue/ Datasheet/ Confirmation Letter/Unpriced PO Copies / Experience List (Any one can be provided), for the same.	

Notes --

SR. NO.	NOTES	VENDOR RESPONSE
1	BHEL reserve the right to verify the information submitted by Bidder. In case the information is found to be false / incorrect, the offer shall be rejected. Bidder to confirm.	

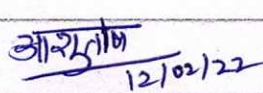
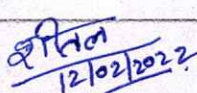
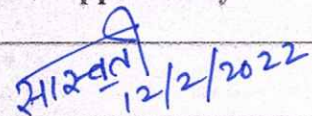
Worked by	Reviewed by	Approved by
 12/02/22	 12/02/2022	 12/2/2022
A. Srivastava Dy. Manager	Sheetal Singh Sr. Manager	Saswati Srivastava AGM

### Certificate by Chartered Accountant on letter head

This is to Certify that M/s .....  
(hereinafter referred to as 'company') having its registered office at.....is  
registered under MSMED Act 2006, (Entrepreneur Memorandum No (Part- II)  
.....dtd:.....,

Category :.....(Micro/Small). (Copy enclosed).

Further verified form the Books of Accounts that the investment of the company as  
on date .....as per MSMED Act 2006 is as follows:

1. **For Manufacturing Enterprises:** Investment in plant and machinery (i.e. original cost excluding land and  
building and the items specified by the Ministry of Small Scale Industries vide its notification No.  
S.O.1722 (E) dated October 5, 2006:

Rs.....Lacs

2. **For Service Enterprises:** Investment in equipment (original cost excluding land and building and furniture,  
fittings and other items not directly related to the service rendered or as may be notified under the MSMED  
act, 2006:

Rs.....Lacs

**(Strike off whichever is not applicable)**

The above investment of Rs .....Lacs is within permissible limit of Rs..... Lacs for  
.....micro / small (Strike off which is not applicable) Category under MSMED Act 2006.

Or

The company has been graduated from its original category (Micro / Small) **(Strike off whichever is not  
applicable)** and the date of graduation of such enterprises from its original category is .....  
(dd/mm/yyyy) which is within the period of 3 years from the date of graduation of such enterprises from  
its original category as notified vide S.O. No. 3322(E) dated 01.11.2013 published in the gazette notification  
dated 04.11.2013 by Ministry of MSME.

Date:

(Signature)

Name-

Membership Number-

Seal of Chartered Accountant

**Format for Self Certification under preference to Make in India order**

**Certificate**

In line with Government Public Procurement Order No. P-45021/2/2017-PP (BE-II) dated 04.06.2020, we hereby certify that we M/s \_\_\_\_\_ (supplier name) are local supplier. The percentage of local content in the items \_\_\_\_\_ offered by us against Enquiry No. \_\_\_\_\_ is \_\_\_\_\_% (percentage).

Details of location at which local value addition will be made is as follows:

\_\_\_\_\_  
\_\_\_\_\_

We also understand, false declarations will be in breach of the Code of Integrity under Rule 175(1)(i)(h) of the General Financial Rules for which a bidder or its successors can be debarred for up to two years as per Rule 151 (iii) of the General Financial Rules along with such other actions as may be permissible under law.

Seal and Signature of Supplier

दिनांक एवं हस्ताक्षर  
SIGN & DATE



उत्पाद मानक

ST- 48012

**PRODUCT STANDARD**  
**STEAM TURBINE ENGINEERING**

पृष्ठ 1 का 7

Page 01 of 07

सामग्री सूची संख्या  
को अधिकतम करता है।  
SUPERSEDES  
INVENTORY NO.

**VARIABLE CAPACITANCE TYPE LEVEL TRANSMITTER**  
**WITH PREAMPLIFIER AND AMPLIFIER**

**0.0 SCOPE:**

This specification covers the requirement of liquid level Transmitter with load independent 4-20 mA D.C. output Galvanically isolated in the tanks/chamber for turbine oil / fire-retardant fluid(phosphoric ester) used in power plants.

**1.0 DESIGNATION:**

The sensor with preamplifier of L=1600 (variant 001) of table 1 shall be designated as:

- 1.1 On Drawing i) Drg.No. Col. : ST 48012.001  
ii) Description Col.: Bar Probe, L = 1600 mm  
iii) Material Specn. : ST 48012

For purchase indents : Bar Probe,L=1600. ST 48012.001

- 1.2 The amplifier for Bar Probe shall be designated as:

- On Drawing i) Drg. No. Col. : ST48012.021  
ii) Description Col.: AMPLIFIER FOR BAR PROBE  
iii) Material Specn. : ST 48012

For Purchase Indents: Amplifier for Bar Probe ST48012.021

**2.0 COMPLIANCE WITH NATIONAL STANDARD:**

This standard is based on BHEL experience.

**3.0 TECHNICAL REQUIREMENT:**

The Transmitter shall be complete with sensor, preamplifier, amplifier, plug receptacle connector etc. as per detail below.

The basic measurement function shall be based on variable capacitance principle.

**COPYRIGHT AND CONFIDENTIAL**

The information on this documents is the property of Bharat Heavy Electrical Limited  
It must not be used directly or indirectly in any way detrimental to the interest of the company

स्वत्वाधिकार एवं गोपनीय

इस दस्तावेज में दी गई सूचना भारत हेवी इलेक्ट्रिकल्स की सम्पत्ति है इसका प्रयोग एवं  
अनुवाद केवल उस व्यक्ति की संज्ञा में ही होना चाहिए, जो कि कंपनी के हित में कार्य कर रहा है।

हस्ताक्षर एवं दिनांक  
SIGN & DATE

सामग्री सूची संख्या  
INVENTORY NO

				नाम NAME	दिनांक एवं हस्ताक्षर SIGN. & DATE
PSC member	S.K. Sharma	<i>[Signature]</i>	अनुवादक TRANSLATED BY		
TSX	D.L. Oberoi	<i>[Signature]</i>	निर्माणकर्ता WORKED BY	SHEETAL	<i>[Signature]</i> 04/08/06.
QAX	S.K. Chaurhan	<i>[Signature]</i>	परीक्षणकर्ता CHECKED BY	V. KUMAR	<i>[Signature]</i> 04/08/06
सहमत विभाग AGREED DEPTT.	नाम NAME	दिनांक एवं हस्ताक्षर DATE & SIGNATURE	पर्यवेक्षणकर्ता SUPERVISED BY	S.K.SHARMA	<i>[Signature]</i> 04/08/06

REAFFIRM

स्वीकृति :  
APPROVED : K.B. BATRA

GR No  
3.50

REY. NO. 07	WORKED BY	BRIJ LAL	<i>[Signature]</i> 10/10/06
DT. 10.12.19	CHECKED BY	ASHUTOSH	<i>[Signature]</i> 14/01/2020
CHANGE ADVICE NO.	STE-19-74		

निर्माण : PREPARED  
CIE

जारी : ISSUED  
TSX (HEEP) HWR

दिनांक : DATE  
19.01.93

सामग्री सूची संख्या  
INVENTORY NO.

**3.1 SENSORS:**

The sensor shall be based on variable capacitance principle consisting of rod probe with ground tube of SS-316 as per dimensions given in fig 1.

The probe and the ground tube form a capacitor whose capacitance changes on the change in level due to the difference in the dielectric constant of the liquid media and that of air.

The length of the probe for different applications is given in Table-1. The sensor, except the preamplifier shall be designed for maximum operating temperature of 150°C and pressure of 10 Bar.

**3.2 PREAMPLIFIER :**

The preamplifier shall convert the change in capacitance to a suitable electrical signal for transmission to a amplifier, which is located away to a safer distance.

The preamplifier shall be mounted on the sensor head as per mounting and connection arrangement shown in fig 2. The protection class shall be IP55(minimum) as per IS: 13947 (PART 1) and ambient temperature should be 0°C to +60° C.

**3.3 AMPLIFIER: Size No. 021 (Fig.3)**

The output signal from the preamplifier shall be amplified and processed for the desired output. The amplifier shall have provision of adjustment and calibration. The measuring range shall be adjustable so that the output can be calibrated for any range between 0-50% to 0-100% of the span L1 (ref.fig.1). Provision shall be made to shift the range above or below so as to cover the entire length of the probe

The other requirements are given below.

- 3.3.1 Measuring range : Equal to the length of the probe (Ref.fig.1&Table 1)
- 3.3.2 Output..... : 4...20 mA Galvanically isolated D.C.for burden up to 500 ohm for any range as specified at clause 3.3.
- 3.3.3 Power supply ..... : 24 V DC nom. (variation from 20 to 30 V).
- 3.3.4 Accuracy.....: +/- 0.5% of full span. or better
- 3.3.5 Protection class : IP 55 ( minimum) or better
- 3.3.6 Housing : Sheet Steel/Cast Aluminium Stoving enamel painted,weather proof, projection mounting.
- 3.3.7 Ambient temperature : 0°C to (+) 60°C

COPYRIGHT AND CONFIDENTIAL  
 The information on this documents is the property of Bharat Heavy Electricals Limited. It must not be used directly or indirectly in any way detrimental to the interest of the company.

स्वत्वधिकार एवं गोपनीय  
 इस दस्तावेज में दी गई सूचना भारत भारती इलेक्ट्रिकल्स की संपत्ति है इसका प्रयोग एवं अनुकूलन के बिना कम्पनी के हित में उपयोग करने की अनुमति नहीं दी जायेगी।

हस्ताक्षर एवं दिनांक  
SIGN & DATE  
 29.8.06

REV NO.	07			निर्माणकर्ता Worked by	Sheetal	Sheetal	04/08/06
				जांचकर्ता Checked by	V.Kumar	[Signature]	04/8/06

दिनांक एवं हस्ताक्षर SIGN & DATE		<p style="text-align: center;"><b>उत्पाद मानक</b></p> <p style="text-align: center;"><b>PRODUCT STANDARD</b></p> <p style="text-align: center;"><b>STEAM TURBINE ENGINEERING</b></p>	<p style="text-align: right;"><b>ST- 48012</b></p> <p style="text-align: right;">पृष्ठ 3 का 7</p> <p style="text-align: right;">Page 03 of 07</p>								
सामग्री सूची संख्या को अधिकारित करता है । SUPERSEDES INVENTORY NO.	<p><b>4.0 SURFACE PROTECTION OF AMPLIFIER AND PROBE HEAD:</b></p> <p>The external surface shall be so treated that it can withstand a sustained environment of phosphoric ester fume at 60° C and/or medium turbine oil at 60° C.</p> <p><b>5.0 IDENTIFICATION:</b></p> <p>A blank stainless steel tag of size 60x20 mm shall be fastened with each sensor.</p>										
स्वत्वाधिकार एवं गोपनीय इस प्रलेख में दी गई सूचना भारत भारती इलेक्ट्रिकल्स की संपत्ति है इसका प्रयोग एवं आशयका रूप से किसी भी तरह करना, जो कि कंपनी के हित में हानिकारक हो न किया जाए । COPYRIGHT AND CONFIDENTIAL The information on this documents is the property of Bharat Heavy Electrical Limited. It must not be used directly or indirectly in any way detrimental to the interest of the company.	<p><b>6.0 TESTS:</b></p> <p>6.1 <u>ROUTINE TESTS</u> : -</p> <p>Following tests should be carried out by the supplier on each piece of sensor and Indicator/Amplifier.</p> <p>6.1.1 Visual inspection and dimensional check.</p> <p>6.1.2 Functional test for adjustable range.</p> <p>6.1.3 Accuracy test.</p> <p>6.1.4 Burn in test for amplifier electronics (for 48 hrs. at 55 °C.)</p> <p>6.2 <u>TYPE TESTS</u> : -</p> <p>Type Test reports (not more than 5 year old) shall be furnished for the following additional tests on amplifier electronics as per IEC 60068.</p> <p>a. Damp Heat Test b. Temperature Cycle Test c. Dry Heat Test d. Vibration Test e. Protection Class</p> <p><b>7.0 TEST CERTIFICATE:</b></p> <p>Each piece of sensor/ preamplifier/ amplifier shall accompany with 3 copies of the tests certificate with:</p> <p>i) Name of instrument. ii) Name of manufacturer. iii) Serial no &amp; model no. of the instrument. iv) Date of testing.</p> <p>Results of the test detailed in clause 6.0</p>										
दिनांक एवं हस्ताक्षर SIGN & DATE 29.8.06	सामग्री सूची संख्या INVENTORY NO. P-5282	REV NO. 07	<table border="1"> <tr> <td>निर्माणकर्ता Worked by</td> <td>Sheetal</td> <td>Sheetal</td> <td>04/08/06</td> </tr> <tr> <td>जांचकर्ता Checked by</td> <td>V.Kumar</td> <td>[Signature]</td> <td>04/08/06</td> </tr> </table>	निर्माणकर्ता Worked by	Sheetal	Sheetal	04/08/06	जांचकर्ता Checked by	V.Kumar	[Signature]	04/08/06
निर्माणकर्ता Worked by	Sheetal	Sheetal	04/08/06								
जांचकर्ता Checked by	V.Kumar	[Signature]	04/08/06								

दिनांक एवं हस्ताक्षर SIGN & DATE		<p style="text-align: center;"><b>उत्पाद मानक</b></p> <p style="text-align: center;"><b>PRODUCT STANDARD</b></p> <p style="text-align: center;"><b>STEAM TURBINE ENGINEERING</b></p>	<p style="text-align: right;"><b>ST- 48012</b></p> <p style="text-align: right;">पृष्ठ 4 का 7</p> <p style="text-align: right;">Page 04 of 07</p>						
सामग्री सूची संख्या INVENTORY NO.	SUPERSEDES INVENTORY NO.	<p><b>8.0 GUARANTEE CERTIFICATE:</b></p> <p>Each piece of sensor /preamplifier /amplifier shall accompany a guarantee certificate for trouble free performance for 24 months from the date of shipment or 12 months from the date of commissioning, which ever is earlier.</p> <p><b>9.0 DOCUMENTS:</b></p> <p>Three copies of detail technical literatures including data sheet and drawing shall be furnished alongwith the offer. Complete technical literature including O &amp; M manual shall be furnished in hard copy (three no.s) and soft form (1 CDROM ), <del>after placement of order.</del> <i>after Placement of order.</i></p> <p><b>10.0 PACKING:</b></p> <p>Each instrument with dehydrating agent shall be sealed individually in a polythene sheet and packed in a thermocole box. Such boxes shall be packed in a carton or case with adequate cushioning material to withstand normal transit risk.</p> <p><b>11.0</b> Supplier shall enclose the list of spare parts required for 5 years normal operation and quote for the same separately.</p> <p><b>12.0 QUALITY PLAN:</b></p> <p>Detail quality plan for the tests and checks to be carried out during material induction , manufacturing and at final stage shall be submitted in BHEL's format alongwith in house standard procedures / normal for BHEL's approval.</p> <p><b>13.0 MARKING:</b></p> <p>The following details shall be marked on the packing case:</p> <p>(a) Manufacturer's name or trade mark. (b) BHEL order number.</p> <p><b>14.0 NAME PLATE:</b></p> <p>Each instrument shall have a name plate marked on it the following:</p> <p>(a) Manufacturer's name or trade mark. (b) Type of the Instrument. (c) Model NO's of the Manufacturer. (d) Range of Measurement. (e) Accuracy.</p>							
COPYRIGHT AND CONFIDENTIAL The information on this document is the property of Bharat Heavy Electricals Limited. It must not be used directly or indirectly in any way detrimental to the interest of the company.									
स्वत्वाधिकार एवं गोपनीय इस प्रतीक में की गई सूचना भारत भारती इंजीनियरिंग लिमिटेड की संपत्ति है। इसका प्रयोग एवं आशयका रूप से किसी भी तरह प्रयोग, जो कि कंपनी के हित में हाथीकरण ही न किया जाए।									
दिनांक एवं हस्ताक्षर SIGN & DATE 23.8.06									
सामग्री सूची संख्या INVENTORY NO. P-5882	REV NO. 07		<table border="1"> <tr> <td>निर्माणकर्ता Worked by</td> <td>Sheetal</td> <td>04/08/06</td> </tr> <tr> <td>जांचकर्ता Checked by</td> <td>V.Kumar</td> <td>04/8/06</td> </tr> </table>	निर्माणकर्ता Worked by	Sheetal	04/08/06	जांचकर्ता Checked by	V.Kumar	04/8/06
निर्माणकर्ता Worked by	Sheetal	04/08/06							
जांचकर्ता Checked by	V.Kumar	04/8/06							

दिनांक एवं हस्ताक्षर SIGN & DATE		<b>उत्पाद मानक</b>  <b>PRODUCT STANDARD</b>  <b>STEAM TURBINE ENGINEERING</b>	ST- 48012
			पृष्ठ 5 का 7 Page 05 of 07

सामग्री सूची संख्या को अधिकृत करता है । SUPERSEDES INVENTORY NO.	<p><b>15.0 ELECTRICAL CONNECTIONS:</b></p> <p>Input /output connections for Bar probe &amp; Amplifier should have connectors as given below &amp; marked in fig 1, 2 &amp; 3. of M/s Amphetronix Poona or of M/s Allied Bombay or equivalent.</p> <p>(a) BAR PROBE : 5 Pin Connector.</p> <p>For Output/input. Model: MS-3102R-14SL-5P. MS-3106F-14SL-5S.</p> <p>(b) AMPLIFIER : Connection as per Fig 2 &amp; 3.</p> <p>For Bar probe. 5 Pin Model: MS-3102R-14SL-5P. MS-3106F-14SL-5S.</p> <p>For Power Supply. 4 Pin Model: MS-3102R-14SL-2P. MS-3106F-14SL-2S.</p> <p>For Output. 7 Pin Model: MS-3102R-16SL-1P. MS-3106F-16SL-1S.</p> <p><b>Cross referred Standards :</b> IS 13947 , IEC 60068</p>
---	--

सामग्री सूची संख्या को अधिकृत करता है । COPYRIGHT AND CONFIDENTIAL The information on this documents is the property of Bharat Heavy Electrical Limited. It must not be used directly or indirectly in any way detrimental to the interest of the company.	स्वत्वाधिकार एवं गोपनीय इस प्रलेख में दी गई सूचना भारत हेवी इलेक्ट्रिकल्स की संपत्ति है इस्तेमाल प्रत्यक्ष एवं अप्रत्यक्ष रूप से किसी भी तरह प्रयोग, जो कि कंपनी के हित में हानिकारक हो न किया जाए ।
--	---

हस्ताक्षर एवं दिनांक SIGN & DATE P-5882 29.8.06	सामग्री सूची संख्या INVENTORY NO. P-5882	REV NO. 07	निर्माणकर्ता Worked by Sheetal	जांचकर्ता Checked by V.Kumar	01/08/06 04/8/06
---	--	---------------	--------------------------------------	------------------------------------	---------------------



# उत्पाद मानक

ST - 48012

## PRODUCT STANDARD STEAM TURBINE ENGINEERING

पृष्ठ 6 का 7

Page 06 of 07

हस्ताक्षर और दिनांक  
SIGN & DATE

सामग्री सूची संख्या  
INVENTORY NO.

COPYRIGHT AND CONFIDENTIAL  
THE INFORMATION ON THIS DOCUMENT IS THE PROPERTY OF  
BHARAT HEAVY ELECTRICALS LIMITED. IT MUST NOT BE USED  
DIRECTLY OR INDIRECTLY IN ANY WAY DETRIMENTAL TO THE  
INTEREST OF THE COMPANY.

स्वाधिकार एवं गोपनीय  
इस प्रलेख में दी गई सूचना भारत हेवी इलेक्ट्रिकल्स लिमिटेड की  
सम्पत्ति है। इसका प्रत्यक्ष या अप्रत्यक्ष रूप में किसी भी तरह  
प्रयोग नहीं किया जाए जो कम्पनी के हित में हानिकारक हो।

हस्ताक्षर और दिनांक/SIGN & DATE  
29.8.06

सामग्री सूची संख्या  
INVENTORY NO.  
P-5882

REV NO  
07

निर्माणकर्ता  
Worked by  
जांचकर्ता  
Checked by

Sheetal  
V.Kumar

Sheetal  
01/08/06  
01/08/06

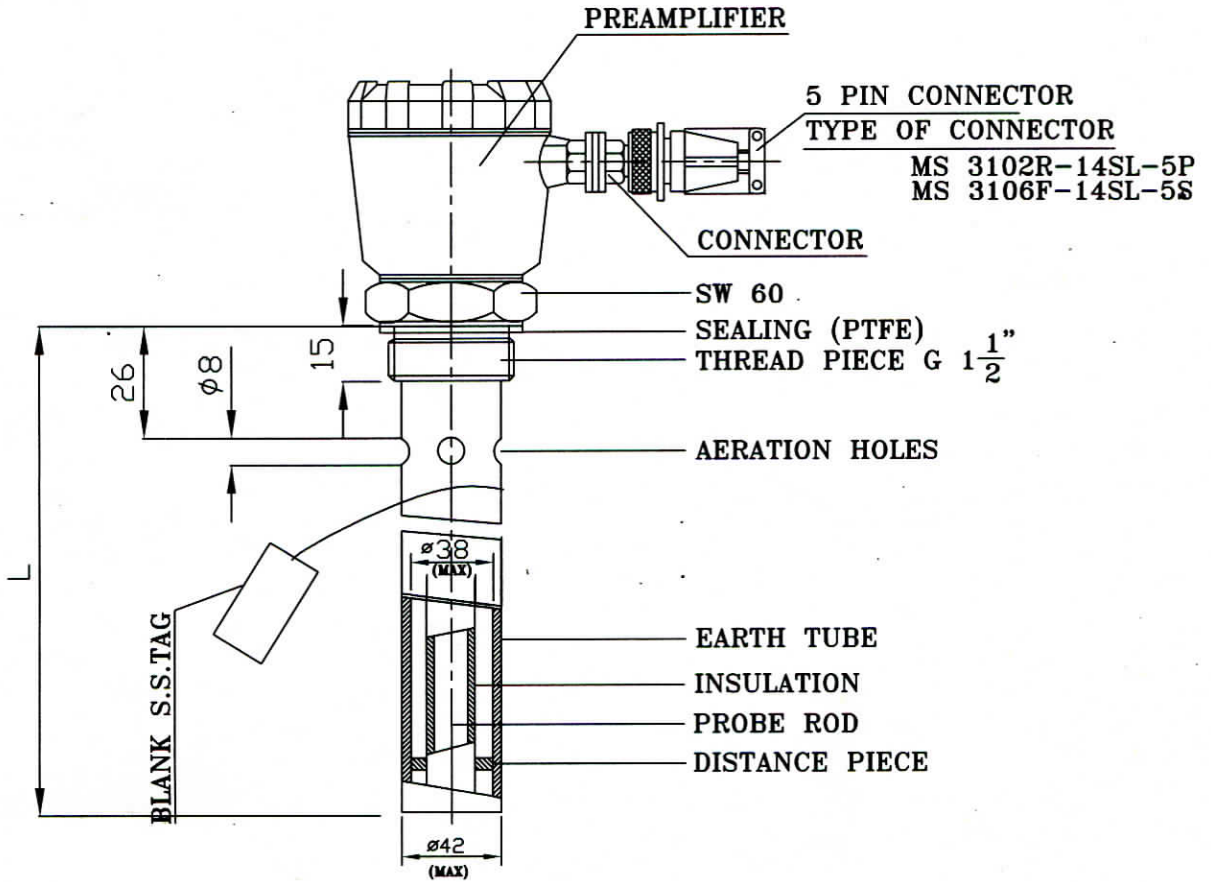

FIG. 1

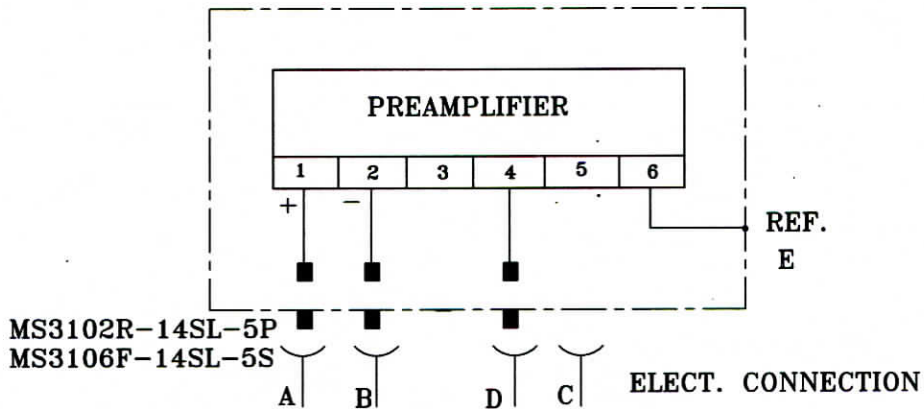

FIG 2

हस्ताक्षर और दिनांक  
SIGN & DATE



**उत्पाद मानक**

ST - 48012

**PRODUCT STANDARD**  
STEAM TURBINE ENGINEERING

पृष्ठ 7 का 7

Page 07 of 07

सामग्री सूची संख्या  
INVENTORY NO.

FIG 3

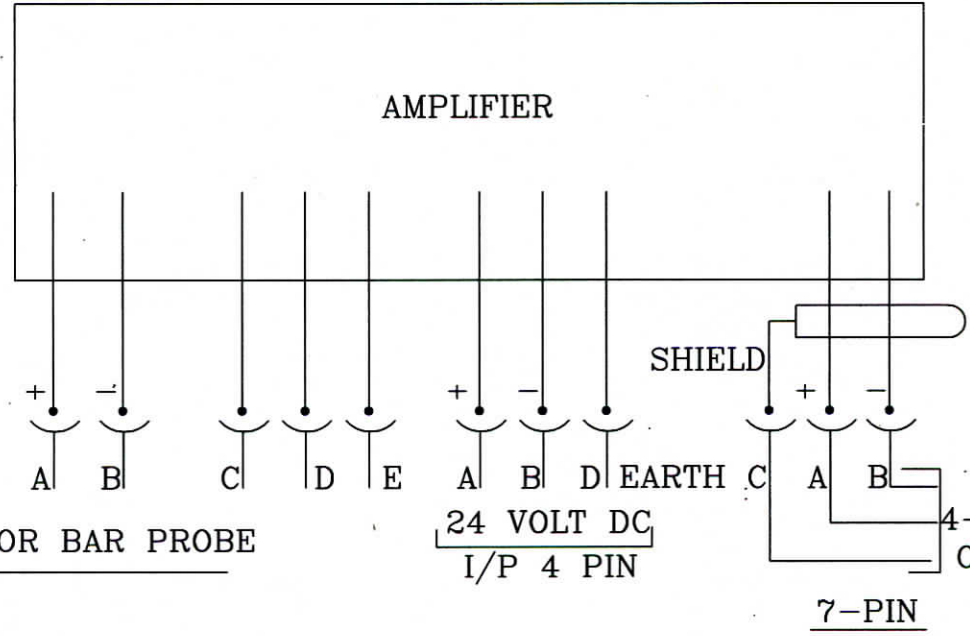

5-PIN FOR BAR PROBE

24 VOLT DC  
I/P 4 PIN

4-20mA  
OUTPUT

7-PIN

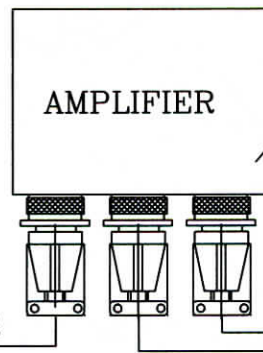

ST-48012-021

5-PIN CONNECTOR

4-PIN CONNECTOR  
7-PIN CONNECTOR

LENGTH OF THE SENSOR  
'L' IN mm  
(AS SHOWN IN FIG.1)

SIZE NO OF ST 48012  
(SENSOR WITH PREAMPLIFIER)

- 1600
- 1450
- 1300
- 1250
- 1100
- 950
- 700
- 150

- 001
- 002
- 003
- 004
- 005
- 006
- 007
- 008

TABLE-1

COPYRIGHT AND CONFIDENTIAL  
THE INFORMATION ON THIS DOCUMENT IS THE PROPERTY OF  
BHARAT HEAVY ELECTRICALS LIMITED. IT MUST NOT BE USED  
DIRECTLY OR INDIRECTLY IN ANY WAY DETERIMENTAL TO THE  
INTEREST OF THE COMPANY.

स्वाधिकार एवं गोपनीय  
इस प्रलेख में दी गई सूचना भारत हेवी इलेक्ट्रिकल्स लिमिटेड की  
सम्पत्ति है। इसका प्रत्यक्ष या अप्रत्यक्ष रूप में किसी भी तरह  
प्रयोग नहीं किया जाए जो कम्पनी के हित में हानिकार हो।

हस्ताक्षर और दिनांक/SIGN & DATE  
25.8.06

सामग्री सूची संख्या  
INVENTORY NO.  
P-5882

REV NO  
07

निर्माणकर्ता Worked by	Sheetal	04/08/06
जांचकर्ता Checked by	V.Kumar	04/08/06

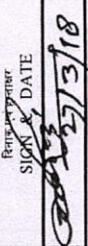
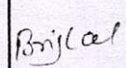
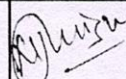

प्रारंभिक प्रमाण SIGN & DATE		<b>उत्पाद मानक (हीप : हरिद्वार)</b> <b>PRODUCT STANDARD (HEEP: HARIDWAR)</b>		ST33002	
				पृष्ठ 10 का 2 Page 2 of 10	
SUPERSEDES INVENTORY	<b>3.0 PACKAGING INSTRUCTIONS :</b>  <b>3.1 (A) GENERAL :</b>  (i) The packaging should be done in a clean, dust free packing area/room.  (ii) Wherever possible, the original packing materials like thermocol box/ chips, packing paper, board, cotton waste, rubberized coir, wood wool etc. should be used for packaging of these equipments etc.  (iii) All the items should be thoroughly checked for any possible mechanical damage/ distortion/ dents and rust/ corrosion etc. Appropriate rectification measures should be taken to remove such defects and if required engineering division should be consulted.  (iv) While packaging, all the items should be temporarily stored on raised wooden platform covered with clean parchment paper.  (v) The repacking of all the bought out items must be done in the original way as they were received from the manufacturers/ suppliers. It must be ensured that the polythene bags are properly sealed, air tight and sufficient cushioning with rubberized coir or wood wool has been provided to various items and containers/ boxes.  (vi) The packing box should be made water proof by putting a continuous barrier of water- proof bitumen paper/craft paper over the internal surfaces of the box to make it sufficiently impervious to water, and small silica gel bags suitably placed inside the packages. This can be done by using tar felt on the top of all the boxes. It should project by 50mm on all the sides and projected part should be nailed and overlap of the tar felt should be avoided.  (vii) The packaging should be done in such a way that the individual instruments/ containers/ boxes do not have relative movement inside the packing box during handling and transportation. Sufficient stiffness should be provided on the packing boxes to withstand mechanical shocks/ vibrations and other transit hazards.  (viii) Wherever necessary, threaded/ machined portion should be coated with grease and wrapped with wax paper and tied with thread. Alternatively, threaded part may be wrapped with corrugated paper.				
<b>COPYRIGHT AND CONFIDENTIAL.</b> The information on this documents is the property of Bharat Heavy Electrical Limited. It must not be used directly or indirectly in any way detrimental to the interest of the company.					
स्वत्वाधिकार एवं गोपनीय इस दस्तावेज में दी गई सूचना भारत हीवी इलेक्ट्रिकल्स लिमिटेड की संपत्ति है। इसका प्रयोग एवं प्रसारण के बिना या इससे पूर्व की अनुमति के बिना न होना चाहिए।					
प्रारंभिक प्रमाण SIGN & DATE					
मामूली सूची संख्या INVENTORY NO. <b>P-5284</b>	REV. NO. 02		निर्माणकर्ता WORKED BY BRIJ LAL RAM		23/03/18
			जांचकर्ता CHECKED BY LAXMIKANT MISHRA		23/03/18

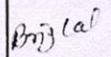
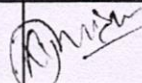

Bhanat Heavy Electrical SIGN & DATE		<b>उत्पाद मानक (हीप : हरिद्वार)</b> <b>PRODUCT STANDARD (HEEP: HARIDWAR)</b>		ST33002	
				पृष्ठ 10 का 4 Page 4 of 10	
SUPERSEDES INVENTORY	<b>3.4 (D) FITTINGS &amp; MOUNTING ACCESSORIES ETC. :</b> <ul style="list-style-type: none"> <li>(i) This category includes items like instrument valves, nipples, brackets, fasteners etc.</li> <li>(ii) Apply appropriate coating of grease on the threaded and machine portion and wrap the individual item with wax paper and tie with thread.</li> </ul>				
भारतीय भारी भारी इलेक्ट्रिकल लिमिटेड	<b>3.5 (E) IMPULSE PIPE LINES :</b> <ul style="list-style-type: none"> <li>(i) Impulse pipe lines are to be closed at both the ends by rubber plugs/ Neoprene grommets to prevent the clogging of pipelines by foreign materials/ dust, wood powder etc.</li> <li>(ii) While packing these pipelines care should be taken that no heavy material is put on top of them. This is necessary to ensure protection against mechanical damage.</li> <li>(iii) All the impulse pipe lines in a packing box should be tied with steel wires in small groups of 10-15 pipe lines</li> <li>(iv) Due care should be taken so that loose item such as above do not collide with each other causing damage to thread /machined port.</li> </ul>				
<b>COPYRIGHT AND CONFIDENTIAL</b> The information on this document is the property of Bhanat Heavy Electrical Limited. It must not be used directly or indirectly in any way detrimental to the interest of the company.	<b>4.0 SEA-WORTHY PACKING INSTRUCTIONS FOR EXPORT PROJECTS AND SEA COASTAL PROJECTS:</b>				
स्वत्वाधिकार एवं गोपनीय इस प्रलेख में की गई सूचना भारत की पर्यटन/व्यवसाय विभिन्न क्षेत्रों में उपयोग के लिए है। इसका प्रयोग अन्य किसी भी उद्देश्य के लिए, कानूनी के विपरीत है। इसमें कोई भी त्रुटि या त्रुटि हो सकती है।	<b>4.1 GENERAL</b> The standard covers guide lines for making Sea- worthy standard packing boxes to be used for transportation for export orders. Vendors shall be responsible for packing and shall meet the minimum requirements specified herein.				
भारतीय भारी भारी इलेक्ट्रिकल लिमिटेड	<b>4.2 SCOPE IN ADDITION TO CLAUSE NO. 1.0 AS ABOVE</b> The procedure specifies minimum guidelines to be complied with for packing of electrical and electronic Components /Assemblies/Equipments. This specification shall be suitable for different handling operations and the adverse conditions during transportation and during indoor/outdoor storage for period of minimum two years.				
भारतीय भारी भारी इलेक्ट्रिकल लिमिटेड	<b>4.3 WOOD SPECIFICATION FOR PACKING</b> The wood used for packing shall conform to specification ISPM NO. 15. (International Standards for Phytosanitary Measures).				
भारतीय भारी भारी इलेक्ट्रिकल लिमिटेड INVENTORY NO. <b>P-5284</b>	REV. NO. 02		निर्माणकर्ता WORKED BY BRIJ LAL RAM		28/03/18
			जांचकर्ता CHECKED BY LAXMIKANT MISHRA		28/03/18

SUPPLIERS' IDES INVENTORY  
 नमूने सूची, नमूने की संख्या/सूची क्रमांक  
**COPYRIGHT AND CONFIDENTIAL**  
 The information on this documents is the property of Bharat Heavy Electrical Limited. It must not be used directly or indirectly in any way detrimental to the interest of the company.

स्वामित्व अधिकार पूर्ण गोपनीय  
 यह दस्तावेज की कोपी न बनाए जाएं। नकल/प्रतिलिपि तैयार करने की अनुमति के बिना, इस दस्तावेज को किसी भी रूप में प्रसारित करने से बचना चाहिए।

SIGN & DATE  
 \_\_\_\_\_  
 \_\_\_\_\_

**4.4 REQUIREMENTS FOR PACKING CASE:**

- 4.4.1 All equipment and materials shall be suitably coated wrapped, or covered and boxed or crated for export shipment so as to prevent damage during handling and storage at the Site. Cardboard containers (if any) shall be enclosed in a solid wooden container to avoid damage during transit.
- 4.4.2 Equipment and process materials shall be packed and semi knocked down, to the extent possible, to facilitate handling and storage and to protect bearings and other machine surfaces from oxidation. Each container box, crate or bundle shall be reinforced with steel strapping, in such a manner that breaking of one strap will not cause complete failure of the packaging. The packing shall be of best standard to withstand rough handling and to provide suitable protection from tropical weather while in transit and while awaiting erection at the site.
- 4.4.3 Waterproof paper and felt linings shall overlap at seams at least 15mm and the seams shall be secured together.
- 4.4.4 Equipment and materials in wooden cases or crates shall be properly cushioned to withstand the abuse of handling, transportation and storage. Packing shall include preservatives suitable for tropical conditions. All machine surfaces and bearings shall be coated with oxidation preventative compounds. All parts subject to damage when in contact with water shall be coated with suitable grease and wrapped in heavy asphalt or tar impregnated paper.
- 4.4.5 Fumigation of boxes including plywood/spacers shall be carried out as per ISPM 15 to make it pest free. All wood packing in each consignment shall be free from bark and all visible signs and fungal attack at the time of shipment.
- 4.4.6 Components sub-assemblies and assemblies sensitive to climatic conditions shall be packed seal tight. All the openings of the sensitive components, sub-assemblies and assemblies shall be blanketed to prevent the ingress of dust and moisture. The components sub-assemblies and assemblies shall be completely covered with 2 layers of polyethylene sheet. Polyethylene sheet to be used shall be UV stabilized. All sharp corners and edges are to be protected by rubber mats to prevent damage the polyethylene sheet. Top surface of the case shall be free from dents to prevent rain water pockets.

नमूने सूची नम्बर INVENTORY NO. <b>P-5284</b>	REV. NO. 02		निर्माणकर्ता WORKED BY <b>BRIJ LAL RAM</b>	<i>Brijlal</i>	<b>28/03/18</b>
			जांचकर्ता CHECKED BY <b>LAXMIKANT MISHRA</b>	<i>[Signature]</i>	<b>28/03/18</b>

निर्माणक संख्या  
SIGN & DATE



# उत्पाद मानक (हीप : हरिद्वार)

ST33002

## PRODUCT STANDARD (HEEP: HARIDWAR)

पृष्ठ 10 का 6  
Page 6 of 10

SUPERSEDES  
INVENTORY

मातृ संस्था के  
संबंधित लोग हैं

**4.4.7** The four sides shall be lined, from inside with multi-layered polyethylene sheet of at least 120 GSM and tacked at suitable places.

Whenever specified in addition to the polyethylene sheet the top cover will have a layer of bitumen felt over the cover. This should project about 100 - 250 mm on all sides shall be provided between frame and planks of the end and side shoo as shown in Fig. (For reference only.)

**COPYRIGHT AND CONFIDENTIAL.**  
The information on this documents is the property of Bharat Heavy Electrical Limited. It must not be used directly or indirectly in any way detrimental to the interest of the company

स्वाधिकार एवं गोपनीय  
यह दस्तावेज भारतीय भारतीय विद्युत निगम लिमिटेड की संपत्ति है। इसका प्रयोग  
यह दस्तावेज के बिना किसी भी प्रकार से न किया जाये।

निर्माणक संख्या  
SIGN & DATE  
*[Signature]* 27/03/18

मातृ संस्था  
INVENTORY NO.  
P-5284

REV.  
NO. 02

निर्माणकर्ता  
WORKED BY  
BRIJ LAL RAM

जांचकर्ता  
CHECKED BY  
LAXMIKANT MISHRA

*Brij Lal* 29/03/18

*[Signature]* 23/03/18

### END SHOOK

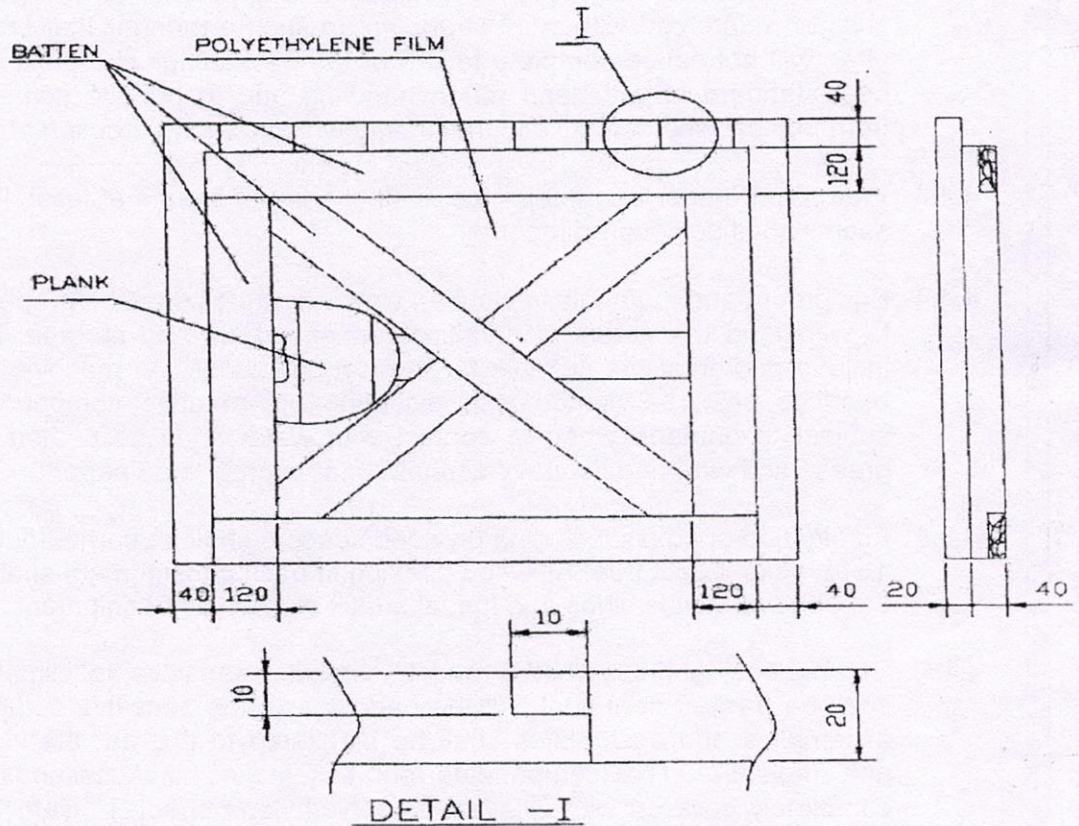



# उत्पाद मानक (हीप : हरिद्वार)

ST33002

## PRODUCT STANDARD (HEEP: HARIDWAR)

पृष्ठ 10 का 7

Page 7 of 10

निर्माण कार्य  
SIGN & DATE

SUPERSEDES  
INVENTORY

संशोधन कार्य  
अनुसंधान कार्य

**COPYRIGHT AND CONFIDENTIAL**  
The information on this document is the property of Bharat Heavy Electricals Limited. It must not be used directly or indirectly in any way detrimental to the interest of the company.

स्वत्वाधिकार एवं गोपनीय  
यह दस्तावेज कंपनी की संपत्ति है। इसमें दी गई जानकारी को बिना अनुमति के किसी भी प्रकार से प्रसारित करना या इसका उपयोग करना गैर-अनुमोदित है।

निर्माण कार्य  
SIGN & DATE

संशोधन कार्य  
INVENTORY NO

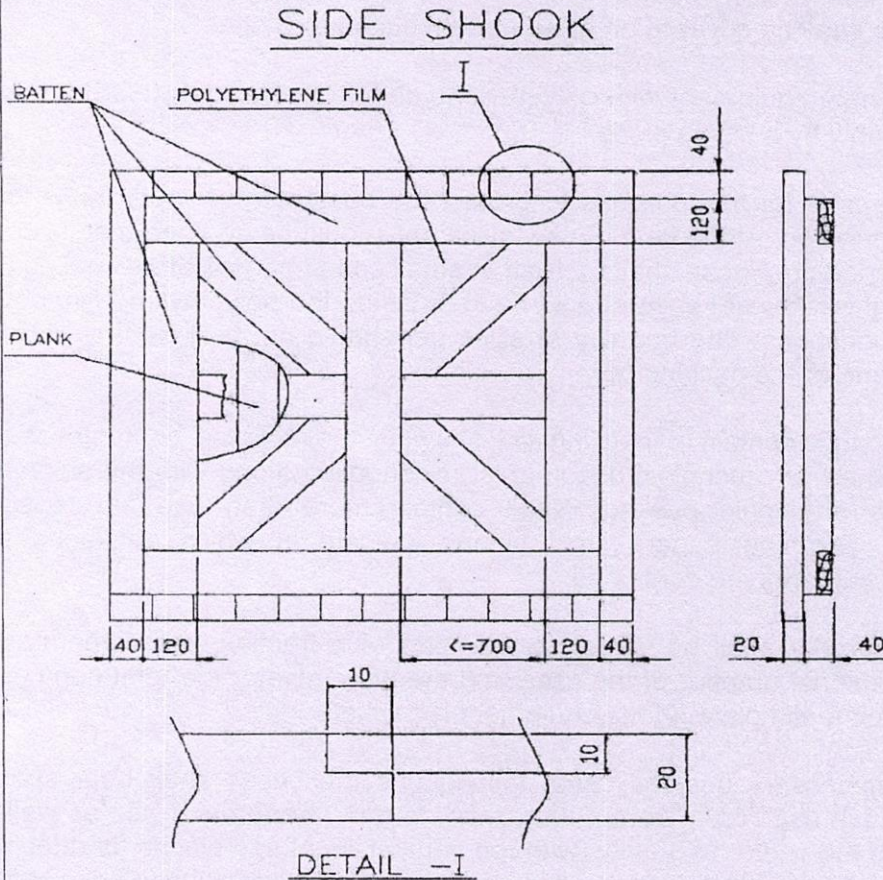

\* DIMENSIONS SHOWN IN ABOVE FIGGURE ARE INDICATIVE ONLY.

It is preferable to have a single piece of the above multi-layered polyethylene sheet fixed on the four sides. In case jointing is unavoidable, it should be done by overlapping of approximately 100 mm.

Place the Components/cartons with corrosion inhibitors duly applied wherever necessary for place suitably, thin muslin cloths bags containing minimum 100 grams (approx.) of activated Blue Silica Gel as per IS 3401-1992/ BS 3482-1991 with standard particle size of 3 to 6 mesh (5.6 to 2.8mm), wherever necessary. Alternatively, VCI Powder as per IS 6263-1972/ IEC 68-2-30:1980 or Tablet may be used. Approximately 7 m3 VCI paper is necessary for 1 m3 of packed item. VCI Paper shall not be used for components made of aluminum, aluminum alloys, Zinc, Copper, Brass, cadmium & silver. VCI powder is sprinkled inside the piping components ends and shall be protected with end cover.

REV. NO. 02

निर्माणकर्ता WORKED BY	BRIJ LAL RAM	<i>Brijlal</i>	23/03/18
जांचकर्ता CHECKED BY	LAXMIKANT MISHRA	<i>Laxmi</i>	23/03/18

P5284





हस्ताक्षर  
SIGN & DATE



उत्पाद मानक (हीप : हरिद्वार)  
PRODUCT STANDARD (HEEP: HARIDWAR)

ST33002  
पृष्ठ 10 का 10  
Page 10 of 10

सुपरसेड  
SUPERSEDES  
INVENTORY

कॉपीराइट और कॉन्फिडेंशियल  
COPYRIGHT AND CONFIDENTIAL  
The information on this document is the property of Bharat Heavy Electrical Limited. It must not be used directly or indirectly in any way detrimental to the interest of the company.

स्वायत्तिकाएँ एवं गोपनीय  
स्वतंत्रता और गोपनीयता  
This document is the property of Bharat Heavy Electricals Limited. It must not be used directly or indirectly in any way detrimental to the interest of the company.

हस्ताक्षर  
SIGN & DATE  
*[Signature]* 27/3/18

सामग्री सूची नम्बर  
INVENTORY NO.  
R-5284

4.4.18 Shipping Documentation including those covered by customs requirements:

- i. Packing List (O&M manual to be listed in packing list, if sent along with consignment).
- ii. Fumigation certificate for wooden boxes

4.4.19 THE FOLLOWING DETAILS ARE TO BE MARKED ON THE PACKING CASES:

- a) Address of consignee.
- b) Purchase Order No.
- c) Description of item or title of packing list.
- d) Case identification Number.
- e) Net Weight.
- f) Gross Weight.
- g) Dimensions of box
- h) Marking showing upright position.
- i) Marking showing umbrella (i.e. for machines/ components to be stored under covered storage).

MARKING ON PACKING BOXES

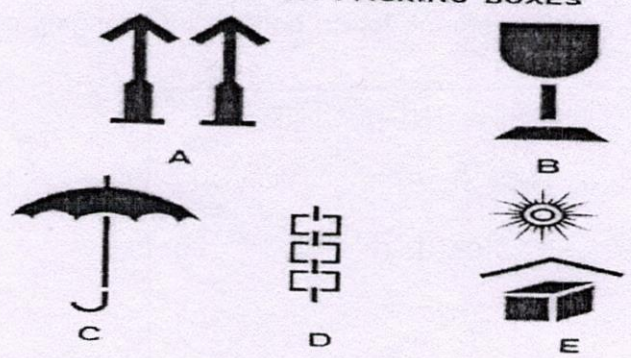

- A UPRIGHT
- B FRAGILE
- C PROTECTION FROM FALLING OR CONDENSING MOISTURE
- D SLING POSITION
- E PROTECTION FROM DIRECT RADIATION

5.0 CROSS REFERRED STANDARD:

IS 3401-1992, BS 3482-1991, IS 6263-1972 & IEC 68-2-30:1980.

REV. NO. 02

निर्माणकर्ता WORKED BY	BRIJ LAL RAM	<i>Brij Lal</i>	23/03/18
जांचकर्ता CHECKED BY	LAXMIKANT MISHRA	<i>[Signature]</i>	23/03/18

DRAWING NO. 3139623010

FIRST ANGLE PROJECTION

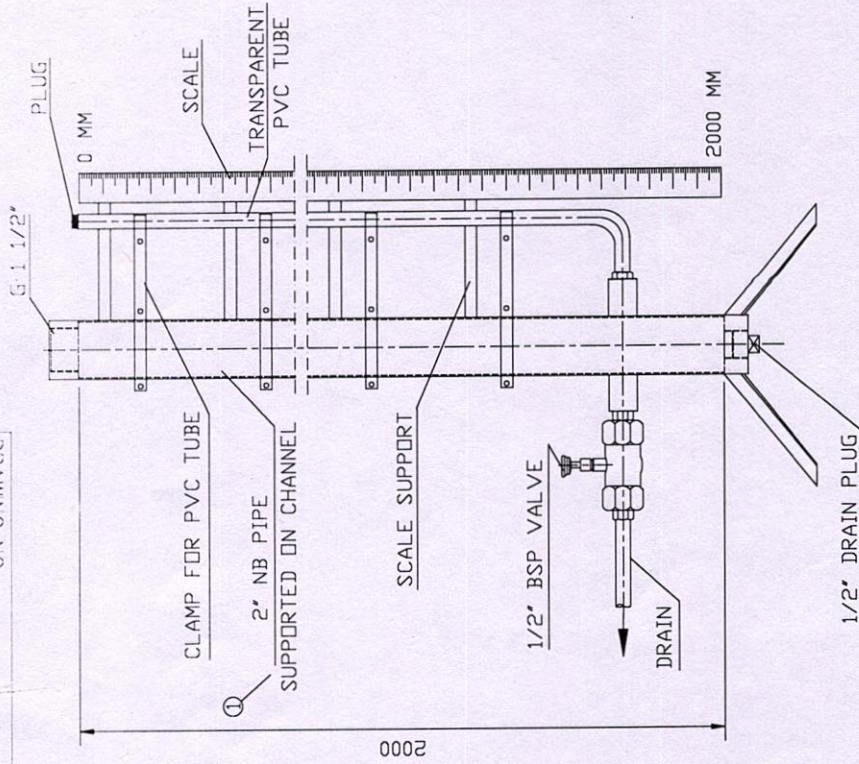

TECHNICAL REQUIREMENTS: -

1. APPLICATION- FOR CALIBRATION OF BAR PROBES OF ST48011 & ST48012. BAR PROBES ARE USED TO MEASURE LEVEL OF MAIN OIL AND CONTROL FLUID TANKS.
2. WORKING MEDIUM : SERVOPRIME-46 OF IOC/TURBINE OIL-46 OF H.P., SP GRVITY: 0.846 AT 50°C. PRESSURE : ATMOSPHERIC, TEMP. : 60±5 C.
3. MOUNTING : VERTICAL.
4. SCALE : 0-2000 MM , LINEAR, MARKED IN MM WITH A LEAST COUNT OF 1 MM.
5. MATERIAL OF ALL PARTS EXCEPT TRANSPARENT PVC TUBE, SHALL BE S.S.
6. HYDRAULIC TEST PRESSURE OF MEASURING TUBE : 2 kg/cm<sup>2</sup> (MIN.).
7. DRAWING SHOWING ,DETAIL DIMENSIONS, MATERIALS e.t.c. SHOULD BE SUBMITTED ALONG WITH THE OFFER.

THE INFORMATION ON THIS DOCUMENT IS THE PROPERTY OF BHARAT HEAVY ELECTRICALS LIMITED. IT MUST NOT BE USED DIRECTLY OR INDIRECTLY IN ANY WAY DETRIMENTAL TO THE INTEREST OF THE COMPANY.

COPYRIGHT AND CONFIDENTIAL

INVENTORY NO.		SIGN & DATE		REF. DRG. NO.	
THE INFORMATION ON THIS DOCUMENT IS THE PROPERTY OF BHARAT HEAVY ELECTRICALS LIMITED. IT MUST NOT BE USED DIRECTLY OR INDIRECTLY IN ANY WAY DETRIMENTAL TO THE INTEREST OF THE COMPANY.					
GMS NO./GR SP NO CBDM 3139623000		STATUS OF DRG AGREED DEPT.		SIGN DATE	
NAME		SIGN		DATE	
REV DATE		ALTERED		BLAL	
01/03/11		CHECKED		ASHUTOSH SELVASTAVA	
PIPE SIZE CHANGED		AS PER CHANGE ADVISE NO. STE-17-F0277.			
TYPE OF PRODUCT OR NAME OF CUSTOMER/PROJECT <b>STEAM TURBINE</b> BHARAT HEAVY ELECTRICALS LTD HARDWAR					
DEPT STE		SCALE		WEIGHT (kg) REF TO ASSY DRG.	
CODE 4011		N.T.S.		25.00	
TITLE		CARD CODE		DRAWING NO.	
CALIBRATION JIG (FOR BAR PROBE)				3139623010	
SHEET NO. 01		NO. OF SHEETS 01		SIZE A3	