

BHARAT HEAVY ELECTRICALS LIMITED
TRANSMISSION BUSINESS GROUP
SUBCONTRACTS MANAGEMENT
PLOT NO. 25, SECTOR 16A, NOIDA,
DISTT. - GAUTAM BUDDHA NAGAR
U.P. - 201301



TENDER DOCUMENTS

FOR

INSTALLATION, TESTING & COMMISSIONING OF 19/33 KV (E), 1C × 500 SQ. MM AL. CONDUCTOR, XLPE INSULATED, ARMoured MV POWER CABLE — BETWEEN ENNORE SEZ TPS MAIN PLANT AREA TO SEA WATER INTAKE PUMP HOUSE (OUTSIDE PLANT BOUNDARY, APPROX. 4 KM ROUTE LENGTH) ON CABLE TRENCH / VERTICAL SUPPORT / PIER-MOUNTED CABLE TRAY (AT HEIGHTS RANGING FROM APPROX. 5.0 M TO 12.5 M ABOVE GROUND LEVEL) / CABLE TRESTLE AT ENNORE SEZ PROJECT IN TAMIL NADU.

CUSTOMER
TAMIL NADU POWER GENERATION CORPORATION LIMITED

TENDER SPEC. No.: TBSM/33KV CABLE/ETC/TENDER/26-27
DATE: 07.05.2026

BHARAT HEAVY ELECTRICALS LIMITED
TRANSMISSION BUSINESS GROUP
SUBCONTRACTS MANAGEMENT

Index

Sl. No.	Description	No. of Pages
1	Notice Inviting Tender	6
2	Project Information/ BHEL's Contacts	1
3	Offer forwarding letter / Tender submission letter	1
4	Declaration by Authorised Signatory of Bidder	1
5	Declaration confirming knowledge about Site conditions	1
6	Authorization of representative for contacting during tendering	1
7	List of key staff to be deputed at site	1
8	No deviation certificate	1
9	Declaration for relation in BHEL	1
10	Declaration Regarding Insolvency / Liquidation / Bankruptcy Proceedings	1
11	Declaration regarding Authenticity of submitted documents	1
12	Declaration regarding minimum local content	1
13	Declaration regarding no conflict of interest	1
14	Indemnity Bond	1
15	Proforma of BG in lieu of SD	2
16	Format for e-payment	1
17	Pre-Qualifying Requirements	2
18	Health, Safety & Environment specification (Doc. No.: - TBG/HSE/NIT-01, Rev-03 Date 31.03.2026)	22
19	General Conditions of Contract for ETC Works (Document No. TB-ETC-GCC, Rev-02)	106
20	Annexure to conditions of contract for ETC Works	30
21	BHEL Conciliation Scheme	11
22	Bill of Quantity Cum price schedule (Annexure-I)	2
23	Price Bid Format: - To be filled by the Bidder Online through https://eprocurebhel.co.in	1
24	BOQ Annexures, Standard Technical Notes, Scope, Drawings & Technical Specification	23



BHARAT HEAVY ELECTRICALS LIMITED
TRANSMISSION BUSINESS GROUP
SUBCONTRACTS MANAGEMENT
PLOT NO. 25, SECTOR 16A, NOIDA,
DISTT. – GAUTAM BUDDHA NAGAR (U.P.) - 201301

REF No. TBSM/33KV CABLE/ETC/TENDER/26-27

Date : 07.05.2026

SUB : TENDER FOR INSTALLATION, TESTING & COMMISSIONING OF 19/33 KV (E), 1C × 500 SQ. MM AL. CONDUCTOR, XLPE INSULATED, ARMoured MV POWER CABLE — BETWEEN ENNORE SEZ TPS MAIN PLANT AREA TO SEA WATER INTAKE PUMP HOUSE (OUTSIDE PLANT BOUNDARY, APPROX. 4 KM ROUTE LENGTH) ON CABLE TRENCH / VERTICAL SUPPORT / PIER-MOUNTED CABLE TRAY (AT HEIGHTS RANGING FROM APPROX. 5.0 M TO12.5 M ABOVE GROUND LEVEL) / CABLE TRESTLE AT ENNORE SEZ PROJECT IN TAMIL NADU."

Dear Sir,

1 Sealed tender are invited for the following :

NAME OF WORK	TIME OF COMPLETION	EARNEST MONEY DEPOSIT	TENDER SUBMISSION DATE AND TIME DD/MM/YYYY	TENDER OPENING DATE & TIME DD/MM/YYYY
INSTALLATION, TESTING & COMMISSIONING OF 19/33 KV (E), 1C × 500 SQ. MM AL. CONDUCTOR, XLPE INSULATED, ARMoured MV POWER CABLE — BETWEEN ENNORE SEZ TPS MAIN PLANT AREA TO SEA WATER INTAKE PUMP HOUSE (OUTSIDE PLANT BOUNDARY, APPROX. 4 KM ROUTE LENGTH) ON CABLE TRENCH / VERTICAL SUPPORT / PIER-MOUNTED CABLE TRAY (AT HEIGHTS RANGING FROM APPROX. 5.0 M TO12.5 M ABOVE GROUND LEVEL) / CABLE TRESTLE AT ENNORE SEZ PROJECT IN TAMIL NADU.	2 Months from the date of LOI	Nil	21.05.2026 11.00 hrs.	21.05.2026 16.00 hrs.

2 Bidder has to submit offer directly through E-PROCUREMENT MODE. Bidder may visit <https://eprocurebhel.co.in>
Procedure for Submission of Tenders through e-tendering:

The tender is also floated online through our E-Procurement Site <https://eprocurebhel.co.in>. The bidder may respond by submitting their offer online in our e-Procurement platform at <https://eprocurebhel.co.in>

Offers are invited in two-parts only.

Documents Comprising the e-Tender

The tender shall be submitted online

- a) **Technical Bid (Un priced Tender)**
All Technical details (e.g. Eligibility Criteria requested (as mentioned below)) should be attached in e-tendering module, failing which the tender stands invalid & may be REJECTED. Bidders shall furnish the following information along with technical tender (preferably in pdf format):
- i) Earnest money Deposit (EMD) furnished in accordance with NIT Clause 4.0
 - ii) Technical Bid (without indicating any prices).
- b) **Price Bid:**
- i) Prices are to be quoted in the attached Price Bid format online on e-tender portal.
 - ii) The price should be quoted for the accounting unit indicated in the e-tender document.
 - iii) Note: It is the responsibility of tenderer to go through the Tender document to ensure furnishing all required documents in addition to above, if any. Any deviation would result in REJECTION of tender and would not be considered at a later stage at any cost by BHEL.
 - iv) A person signing (manually or digitally) the tender form or any documents forming part of the contract on behalf of another shall be deemed to warrantee that he has authority to bind such other persons and if, on enquiry, it appears that the persons so signing had no authority to do so, the purchaser may, without prejudice to other civil and criminal remedies, cancel the contract and hold the signatory liable for all cost and damages.
 - v) A tender, which does not fulfil any of the above requirements and/or gives evasive information/reply against any such requirement, shall be liable to be ignored and rejected.
 - vi) **BHEL shall not conduct Reverse Auction (RA) in this tender. Hence, bidders are requested to submit most competitive price in price bid.**
- c) Uploading of the price bid in prequalification bid or technical bid may RESULT IN REJECTION of the tender.

- d) Tenders shall be uploaded with all relevant PDF/zip format. The relevant tender documents should be uploaded by an authorized person having Class 3- SHA2- 2048 BIT- SIGNING & ENCRYPTION digital signature certificate (DSC).

Tender must be accompanied by the prescribed amount of Earnest Money Deposit (EMD) in the manner described in "Annexure to the Conditions of contract for ETC work "which shall be part of the Technical Bid.

In case of E-Tenders, no paper bids shall be accepted, therefore, the scanned copy of the Banker's Cheque/ Demand Draft/ Pay Order/ Details of payment made through Electronic Fund Transfer/ Fixed Deposit Receipt (FDR) / Bank Guarantee should be uploaded in the E-Procurement Portal and hard copy of the same should reach to following address at before the due date and time of bid submission. BHEL shall not be responsible for postal or any other delays in this regard.)

- To,
3 Ashok Kumar Meena
AGM (TBSM)
BHARAT HEAVY ELECTRICALS LIMITED,
TRANSMISSION BUSINESS GROUP,
6th Floor, BHEL SADAN, Plot no.: - 25, Sector- 16A, Noida,
Distt. – Gautam Buddha Nagar, UP-201301
TELEPHONE: 0120-221 8640, 9831038136
E-mail: akmeena@bhel.in
- 4 **Bidders may please note that no other mode of bid submission shall be considered for evaluation apart from Clause no. 02 to 03 mentioned above.**
- 5 The prospective bidders who have downloaded the tender documents from our website are requested to send their acknowledgement and willingness to participate in the tender to the undersigned, through fax or email.
- 6 Offers should be strictly in accordance with the Tender Specifications and General Instructions to Tenderer enclosed herewith.
- 7 **BHEL shall not conduct Reverse Auction (RA) in this tender. Hence, bidders are requested to submit most competitive price in price bid.**
- 8 The contractor shall give his explicit confirmation without any deviations to the HSE (Health, Safety and Environment) requirements as per enclosed specification No. TBSM/HSE/NIT-01, Rev-03 Date 31.03.2026. Contractors are also required to furnish details as per Annexure (HSE) to NIT along with their offer. Offers received without compliance & data about HSE requirements are liable to be rejected.
- 9 All documents submitted with the offer shall be signed and stamped in each page by authorized representative of the bidder.
- 10 Clarifications, if any, can be obtained from the undersigned but such requests should be submitted well before the due date for submission of tenders. Due date for submission and opening of tenders will not be extended on such grounds.
- 11 Please note that wherever there is a contradiction between the **Annexure to conditions of contract for ETC Works** and **General Conditions of Contract for ETC Works (Document No. TB-ETC-GCC, Rev-02)**, the **Annexure to conditions of contract for ETC Works** clauses shall be governing and binding on the contractor."
- 12 Drawings & FQP enclosed with the NIT (if provided) are for tender purpose only. Drawings & FQP may get change during execution stage and work to be carried as per latest RFC drawings & Field Quality Plan (FQP).
- 13 Construction/ RFC drawing/ Fronts shall be furnished progressively as per project requirement and no claim towards idling charges/ project overheads etc. borne by the contractor on account of non-availability of drawings/ fronts shall be entertained.
- 14 Completion period of the work has been envisaged under best possible conditions. Any changes/ deviation during execution shall be dealt as per relevant clauses mentioned in general/ special conditions of contract for ETC works.
- 15 "In case this tender is awarded to first time contractor*, then the bidder shall be eligible to qualify for the next tender of similar work# of BHEL, TBG; only after successful executing of 50% (fifty percent) of this work prior to the date of next tender (in which bidder desires to quote) and on satisfactory performance feedback by BHEL site Incharge."
* First time contractor: The bidders who have not successfully executed more than 50% (fifty percent) of awarded similar work by BHEL (TBG/ ISG/Power Sector/Any BHEL Unit) in last 5 years from date of NIT.
The bidders who have taken any order from BHEL under 1st time category, and desires to further participate in BHEL tenders, needs to submit a certificate/ undertaking mentioning the reason of not executing 50% of awarded work, hence the criteria under 1st time bidder shall not be applicable to them. The certificate/ undertaking shall be duly certified by Site In charge of BHEL
Similar work: Similar to nature of work of the tender under consideration.
- 16 **Before submission of offer, the tenderer is advised to inspect the work & the environments and be well acquainted with the actual working and other prevalent conditions, facilities available, sourcing of material and labour, means of transport and access to site, accommodation, etc. No claim will be entertained later on the grounds of lack of knowledge on any of these conditions/ resources.**
- 17 The offers of the bidders who are under suspension as also the offers of the bidders, who engage the services of the banned firms, shall be rejected. The list of banned firms is available on BHEL web site www.bhel.com.

- 18 Integrity commitment, performance of the contract and punitive action thereof:
- 18.1 Commitment by BHEL:
BHEL commits to take all measures necessary to prevent corruption in connection with the tender process and execution of the contract. BHEL will during the tender process treat all Bidder(s) in a transparent and fair manner, and with equity.
- 18.2 Commitment by Bidder/ Supplier/ Contractor:
- i) The bidder/ supplier/ contractor commits to take all measures to prevent corruption and will not directly or indirectly influence any decision or benefit which he is not legally entitled to nor will act or omit in any manner which tantamount to an offence punishable under any provision of the Indian Penal Code, 1860 or any other law in force in India.
 - ii) The bidder/ supplier/ contractor will, when presenting his bid, disclose any and all payments he has made, and is committed to or intends to make to agents, brokers or any other intermediaries in connection with the award of the contract and shall adhere to relevant guidelines issued from time to time by Govt. of India/ BHEL.
 - iii) The bidder/ supplier/ contractor will perform/ execute the contract as per the contract terms & conditions and will not default without any reasonable cause, which causes loss of business/ money/ reputation, to BHEL.

If any bidder/ supplier/ contractor during pre-tendering/ tendering/ post tendering/ award/ execution/ post-execution stage indulges in mal-practices, cheating, bribery, fraud or and other misconduct or formation of cartel so as to influence the bidding process or influence the price or acts or omits in any manner which tantamount to an offence punishable under any provision of the Indian Penal Code, 1860 or any other law in force in India, then, action may be taken against such bidder/ supplier/ contractor as per extant guidelines of the company available on [www. bhel.com](http://www.bhel.com) and/or under applicable legal provisions".

- 19 Also, offer of the bidders who are suspended (under hold/ delist) for business dealings by BHEL, TBG shall not be considered. Please note that lifting/ restoration of suspension (Ban/Hold/ De-list) of business dealing is not automatic after expiry of specified suspension period. Hence, vendor shall be considered as suspended for business till suspension is lifted by BHEL in writing on specific request of the vendor as per extant guidelines.
- 20 BHEL Fraud Prevention Policy, "The Bidder along with its associate/ collaborators/ sub-contractors/ sub-vendors/ consultants/ service providers shall strictly adhere to BHEL Fraud Prevention Policy displayed on BHEL website <http://www.bhel.com> and shall immediately bring to the notice of BHEL Management about any fraud or suspected fraud as soon as it comes to their notice."
- 21 Offers will be scrutinized based on the qualifying requirements and only those who are technically and financially capable to execute the Job and who fulfil the Pre-Qualifying Requirements (PQR) are eligible to quote against the above NIT. However, final acceptance of the bidder/ offer shall be subject to acceptance of our customer.
- 22 The evaluation currency for this tender shall be INR.
- 23 EMD not applicable.
- 24 In the course of evaluation, if more than one bidder happens to occupy L-1 status, effective L-1 will be decided by soliciting discounts from the respective L-1 bidders.
In case more than one bidder happens to occupy the L-1 status even after soliciting discounts, the L-1 bidder shall be decided by toss/ draw of lots, in the presence of the respective L-1 bidder(s) or their representative(s).
Ranking will be done accordingly. BHEL's decision in such situations shall be final and binding.
- 25 Technical Bid will be opened in the office of undersigned. If required, technical discussions will be held with only those bidders who have taken any deviations. The price bids will be opened subsequently, after Technical Bids of all the bidders have been evaluated and freed. Bidders should quote their most competitive rates as there will not be any price negotiation. However, if felt necessary by BHEL, price negotiation will be held with lowest bidder (L-1) only. **IT WOULD BE PREFERRED THAT YOUR OFFER IS WITHOUT ANY DEVIATION w.r.t. TENDER SPECIFICATIONS AND THE SAME MAY BE CLEARLY MENTIONED ON THE COVERING LETTER ACCOMPANYING THE TECHNICAL BID.** Offers with deviations are likely to be rejected.
- 26 In case any adverse information is received concerning performance, capability or conduct of the bidder after issue of tender enquiry, BHEL reserves the right to reject the offer at any stage as deemed fit.
- 27 **Any Bidder falling under MSE category shall furnish the following details & submit documentary evidence/ Govt. Certificate etc. in support of the same along with their techno-commercial offer.**

Type under MSE	SC/ST Owned	Women Owned	Others (excluding SC/ST & Women Owned)
Micro			
Small			

Note: If the bidder does not furnish the above in the tender, offer shall be processed construing that the bidder is not falling under MSE category.

- 28 Integrity Pact (IP): Not applicable.

- 29 Any materials (if required) for Erection works have to be procured from Customer approved sources only. It will be the bidder's responsibility to get the approval of materials and vendors for materials.
- 30 The purchase preference for central P.S.U.s shall be given as per the prevailing Government policy.
- 31 Work schedule and the deployment of manpower and T&P resources committed by the contractor in their offer, to match the scheduled completion, shall be submitted by contractor and mutually agreed with site In-charge immediately after the award of work. Further, the contractor shall mobilise at site within two weeks of award of work.
- 32 In case an offer is not being submitted by the prospective bidders against this tender, they may send their "regret" letter to this office, for information.
- 33 Details of qualifying work(s) executed by the bidder will be forwarded to the principal employer for verification of the work with respect to completion, commencement & completion date and value of the work executed. Performance feedback of the bidder will also be sought from the principal employer.
- 34 The bidder representative may be called for discussion with the committee. His originals may be verified by the committee. In addition to above their organisation chart and detail list of manpower, tools & plants and technically capability will be discussed and ascertained by the committee.
- 35 **Conflict of Interest among bidders/Agents: -**
"A bidder shall not have conflict of interest with other bidders. Such conflict of interest can lead to anti-competitive practices to the detriment of Procuring Entity's interests. The bidder found to have a conflict of interest shall be disqualified. A bidder may be considered to have a conflict of interest with one or more parties in this bidding process, if:
- a) they have controlling partner (s) in common; or
 - b) they receive or have received any direct or indirect subsidy/ financial stake from any of them; or
 - c) they have the same legal representative/agent for purposes of this bid; or
 - d) they have relationship with each other, directly or through common third parties, that puts them in a position to have access to information about or influence on the bid of another Bidder; or
 - e) Bidder participates in more than one bid in this bidding process. Participation by a Bidder in more than one Bid will result in the disqualification of all bids in which the parties are involved. However, this does not limit the inclusion of the components/ sub-assembly/ Assemblies from one bidding manufacturer in more than one bid; or
 - f) In cases of agents quoting in offshore procurements, on behalf of their principal manufacturers, one agent cannot represent two manufacturers or quote on their behalf in a particular tender enquiry. One manufacturer can also authorise only one agent/dealer. There can be only one bid from the following:
 - 1) The principal manufacturer directly or through one Indian agent on his behalf; and
 - 2) Indian/foreign agent on behalf of only one principal; or
 - 3) A Bidder or any of its affiliates participated as a consultant in the preparation of the design or technical specifications of the contract that is the subject of the Bid; or
 - 4) In case of it holding company having more than one independently manufacturing units, or more than one unit having common business ownership/management, only one unit should quote. Similar restrictions would apply to closely related sister companies. Bidders must proactively declare such sister/ common business/ management units in same/ similar line of business. "
- 36 **GRIEVANCE REDRESSAL MECHANISM:**
To promote transparency and ensure fair treatment of all bidders, a structured Grievance Redressal Mechanism is in place to address any concerns or issues arising during the tendering process or in subsequent business dealings with the company.
Suppliers/Contractors are requested to follow the below escalation process for grievance resolution:
1. **First Level:** Any grievance should initially be addressed to the designated Dealing Officer, whose contact details are as follows:
(i) **During tendering Stage –**
Ashok Kumar Meena
AGM/TBSM, TBG, BHEL
Email: akmeena@bhel.in
Phone: 0120-2218640
(ii) **During execution of work –**
Sh Nandlal Verma
Sr. DGM
TRANSMISSION BUSINESS GROUP,
Plot No. 25, Sector-16A, Noida,
Distt. Gautambudh Nagar, UP-201301
PHONE: 0120-221- 8836/ 9911477637
E-mail: nverma@bhel.in
2. **Second Level:** If the issue remains unresolved, it may be escalated by lodging a formal grievance through the **SUVIDHA Portal:** <https://suvidha.bhel.in/suvidha/>. Responses will be provided in accordance with the defined escalation matrix."

Thanking you,

Yours faithfully,
For and on behalf of BHEL,

(Ashok Kumar Meena)
AGM /TBSM

PROJECT INFORMATION

REF No. TBSM/33KV CABLE/ETC/TENDER/26-27

DATE : 07.05.2026

1	CUSTOMER:	TAMIL NADU POWER GENERATION CORPORATION LIMITED
2	PROJECT LOCATION AND DETAILS:	TENDER FOR INSTALLATION, TESTING & COMMISSIONING OF 19/33 KV (E), 1C x 500 SQ. MM AL. CONDUCTOR, XLPE INSULATED, ARMoured MV POWER CABLE — BETWEEN ENNORE SEZ TPS MAIN PLANT AREA TO SEA WATER INTAKE PUMP HOUSE (OUTSIDE PLANT BOUNDARY, APPROX. 4 KM ROUTE LENGTH) ON CABLE TRENCH / VERTICAL SUPPORT / PIER-MOUNTED CABLE TRAY (AT HEIGHTS RANGING FROM APPROX. 5.0 M TO12.5 M ABOVE GROUND LEVEL) / CABLE TRESTLE AT ENNORE SEZ PROJECT IN TAMIL NADU."
3	SITE ADDRESS:	Site Address : Bharat Heavy Electricals Limited, Transmission Business Group, 2x660MW Ennore-SEZ STPP, Voyalur PO, Ponneri Taluk, Tiruvallur District, Tamilnadu-601203.
4	CONTACT PERSON AT SITE :	Sh.S Babu Sr Manager Phone No. : 9791009767 E-mail: sbabu@bhel.in
5	CONTACT PERSON: FOR CONTRACTUAL ISSUES	Sh. Ashok Kumar Meena AGM (TBSM) SUBCONTRACTS MANAGEMENT, TRANSMISSION BUSINESS GROUP, Plot No. 25, Sector-16A, Noida, Distt. Gautambudh Nagar, UP-201301 PHONE: 0120-221- 8640/ 9831038136 E-mail: akmeena@bhel.in
6	CONTACT PERSON: FOR ENGINEERING ISSUES	Jai Kumar DGM (TBEM-Electrical) TRANSMISSION BUSINESS GROUP, Plot No. 25, Sector-16A, Noida, Distt. Gautambudh Nagar, UP-201301 PHONE: 0120- 221-8815/9214448521 E-mail: jaik@bhel.in
7	CONTACT PERSON: FOR CONTRACT EXECUTION ISSUES	Sh Nandlal Verma Sr. DGM TRANSMISSION BUSINESS GROUP, Plot No. 25, Sector-16A, Noida, Distt. Gautambudh Nagar, UP-201301 PHONE: 0120-221- 8836/ 9911477637 E-mail: nverma@bhel.in

(TO BE FILLED BY TENDERER OVER THEIR LETTERHEAD)

OFFER FORWARDING LETTER / TENDER SUBMISSION LETTER

REF:

DATE:

To,
AGM/TBSM
Transmission Business Group,
Bharat Heavy Electricals Limited,
6th Floor, BHEL SADAN,
Plot No. 25, Sector-16A, Noida,
Distt. – Gautam Buddha Nagar, UP-201301

Dear Sir,

Sub: Submission of Offer against following tender specification No. :
TENDER REF NO. TBSM/33KV CABLE/ETC/TENDER/26-27

DATE: 07.05.2026

I/We hereby offer to carry out the work detailed in the Tender Specification issued by Bharat Heavy Electricals Limited, Transmissin Business Group (TBG) in accordance with the terms and conditions thereof. I/We have carefully perused the following listed documents connected with the above work and agree to abide by the same.

1. Amendments/Clarifications/Corrigenda/Errata/etc., issued in respect of the Tender documents by BHEL
2. Notice Inviting Tender (NIT)
3. Price Bid
4. Technical Specifications
5. Special Conditions of Contract
6. General Conditions of Contract
7. Forms and Procedures

Should our Offer be accepted by BHEL for Award, I/we further agree to furnish 'Security Deposit' for the work as provided for in the Tender Conditions within the stipulated time as may be indicated by BHEL. I/We further agree to execute all the works referred to in the said Tender documents upon the terms and conditions contained or referred to therein and as detailed in the appendices annexed thereto. I/We have deposited/depositing herewith the requisite documents furnished in the Check List.

Place :
Date :

Signature of the Authorized Signatory
Name:
Designation:

DECLARATION BY BIDDER

REF: TBSM/33KV CABLE/ETC/TENDER/26-27

DATE: 07.05.2026

SUB : TENDER FOR INSTALLATION, TESTING & COMMISSIONING OF 19/33 KV (E), 1C × 500 SQ. MM AL. CONDUCTOR, XLPE INSULATED, ARMoured MV POWER CABLE — BETWEEN ENNORE SEZ TPS MAIN PLANT AREA TO SEA WATER INTAKE PUMP HOUSE (OUTSIDE PLANT BOUNDARY, APPROX. 4 KM ROUTE LENGTH) ON CABLE TRENCH / VERTICAL SUPPORT / PIER-MOUNTED CABLE TRAY (AT HEIGHTS RANGING FROM APPROX. 5.0 M TO 12.5 M ABOVE GROUND LEVEL) / CABLE TRESTLE AT ENNORE SEZ PROJECT IN TAMIL NADU."

It is certified that General Instructions and Information for tenderer have been read/ complied/ agreed to and each page of tender offer has been initialled and stamped.

Also It is being declares that we _____ (Bidder Name) will not enter into any illegal or undisclosed agreement or understanding, whether formal or informal with other Bidder(s). This applies in particular to prices, specifications, certifications, subsidiary contracts, submission or non-submission of bids or any other actions to restrict competitiveness or to introduce cartelization in the bidding process.

In case, the Bidder is found having indulged in above activities, suitable action shall be taken by BHEL as per extant policies/ guidelines

(Signature of Tenderer)

Name and Designation of Authorised person (s)
Signing the tender on behalf of the tenderer

(TO BE FILLED BY TENDERER OVER THEIR LETTERHEAD)

ANNEXURE – Y

REF: TBSM/33KV CABLE/ETC/TENDER/26-27

DATE: 07.05.2026

TENDER FOR INSTALLATION, TESTING & COMMISSIONING OF 19/33 KV (E), 1C × 500 SQ. MM AL. CONDUCTOR, XLPE INSULATED, ARMoured MV POWER CABLE — BETWEEN ENnore SEZ TPS MAIN PLANT AREA TO SEA WATER INTAKE PUMP HOUSE (OUTSIDE PLANT BOUNDARY, APPROX. 4 KM ROUTE LENGTH) ON CABLE TRENCH / VERTICAL SUPPORT / PIER-MOUNTED CABLE TRAY (AT HEIGHTS RANGING FROM APPROX. 5.0 M TO 12.5 M ABOVE GROUND LEVEL) / CABLE TRESTLE AT ENnore SEZ PROJECT IN TAMIL NADU."

Subject: Declaration confirming knowledge about Site conditions

I/We, _____ hereby declare and confirm that we have visited the Project Site with reference to above BHEL Tender Specifications and acquired full knowledge and information about the Site conditions including Wage structure, Industrial Climate, the Law & Order and other conditions prevalent at and around the Site. Also, we have acquired information about availability of manpower, construction material, water, electricity etc.

We further confirm that the above information is true and correct and we shall not raise any claim of any nature due to lack of knowledge of Site conditions.

I/We, hereby offer to carry out work as detailed in above mentioned Tender Specification, in accordance with Terms & Conditions thereof.

Site Visited Official Name & Contact Details:

Date of Site Visit:

(Signature of Tenderer)

Date :

Place :

Name and Designation of Authorised person (s)
Signing the tender on behalf of the tenderer

(TO BE FILLED BY TENDERER OVER THEIR LETTERHEAD)

ANNEXURE – Z

REF: TBSM/33KV CABLE/ETC/TENDER/26-27

DATE: 07.05.2026

SUB : TENDER FOR INSTALLATION, TESTING & COMMISSIONING OF 19/33 KV (E), 1C × 500 SQ. MM AL. CONDUCTOR, XLPE INSULATED, ARMoured MV POWER CABLE — BETWEEN ENNORE SEZ TPS MAIN PLANT AREA TO SEA WATER INTAKE PUMP HOUSE (OUTSIDE PLANT BOUNDARY, APPROX. 4 KM ROUTE LENGTH) ON CABLE TRENCH / VERTICAL SUPPORT / PIER-MOUNTED CABLE TRAY (AT HEIGHTS RANGING FROM APPROX. 5.0 M TO12.5 M ABOVE GROUND LEVEL) / CABLE TRESTLE AT ENNORE SEZ PROJECT IN TAMIL NADU."

Subject: Authorization of representative for contacting during tendering process

1	NAME & DESIGNATION OF OFFICIAL	
2	POSTAL ADDRESS (complete)	
3	TELEPHONE NOS. (LAND LINE & MOBILE BOTH)	
4	FAX NO.	
5	E-MAIL ADDRESS	

(TO BE FILLED BY TENDERER OVER THEIR LETTERHEAD)

LIST OF KEY-STAFF TO BE POSTED AT SITE AFTER RECEIPT OF LOI

REF: TBSM/33KV CABLE/ETC/TENDER/26-27

DATE: 07.05.2026

SUB : TENDER FOR INSTALLATION, TESTING & COMMISSIONING OF 19/33 KV (E), 1C × 500 SQ. MM AL. CONDUCTOR, XLPE INSULATED, ARMoured MV POWER CABLE — BETWEEN ENNORE SEZ TPS MAIN PLANT AREA TO SEA WATER INTAKE PUMP HOUSE (OUTSIDE PLANT BOUNDARY, APPROX. 4 KM ROUTE LENGTH) ON CABLE TRENCH / VERTICAL SUPPORT / PIER-MOUNTED CABLE TRAY (AT HEIGHTS RANGING FROM APPROX. 5.0 M TO 12.5 M ABOVE GROUND LEVEL) / CABLE TRESTLE AT ENNORE SEZ PROJECT IN TAMIL NADU."

To,
AGM/TBSM
Transmission Business Group,
Bharat Heavy Electricals Limited,
6th Floor, BHEL SADAN,
Plot No. 25, Sector-16A, Noida,
Distt. – Gautam Buddha Nagar, UP-201301

Subject: LIST OF KEY-STAFF TO BE POSTED AT EACH SITE AFTER RECEIPT OF LOI

Dear Sir,

With reference to above, this is to confirm that we shall depute the following main staff (Minimum) for above referred work at project site permanently till completion of work..

ENNORE SEZ SITE

		Site Incharge	Supervisor-1	Supervisor-2	Safety Engineer
1	Name				
2	Qualification				
3	Experience (in years)				
4	Age				

We assure that above are the minimum staff we shall depute at site. In case of further requirement, we shall depute additional staff as per work requirement and as per instruction of BHEL site incharge.

Thanking you,

(Signature of Tenderer)

Name and Designation of Authorised person (s)
Signing the tender on behalf of the tenderer

(TO BE FILLED BY TENDERER OVER THEIR LETTERHEAD)

NO DEVIATION CERTIFICATE

REF:

DATE:

SUB : TENDER FOR INSTALLATION, TESTING & COMMISSIONING OF 19/33 KV (E), 1C × 500 SQ. MM AL. CONDUCTOR, XLPE INSULATED, ARMoured MV POWER CABLE — BETWEEN ENNORE SEZ TPS MAIN PLANT AREA TO SEA WATER INTAKE PUMP HOUSE (OUTSIDE PLANT BOUNDARY, APPROX. 4 KM ROUTE LENGTH) ON CABLE TRENCH / VERTICAL SUPPORT / PIER-MOUNTED CABLE TRAY (AT HEIGHTS RANGING FROM APPROX. 5.0 M TO 12.5 M ABOVE GROUND LEVEL) / CABLE TRESTLE AT ENNORE SEZ PROJECT IN TAMIL NADU."

TENDER REF NO. : TBSM/33KV CABLE/ETC/TENDER/26-27

Dated: 07.05.2026

Subject: NO DEVIATION STATEMENT

Dear Sir,

With reference to above, this is to confirm that as per tender conditions, we have visited subject site before submission of our offer and noted the job content & site conditions etc.

We also confirm that we have not changed / modified the tender documents as appeared in the website and in case of observance at any stage, it shall be treated as null and void. We hereby confirm that we have not taken any deviation from tender clauses together with other references as enumerated in the above referred NIT and we hereby convey our unqualified acceptance to all terms and conditions as stipulated in the tender and NIT. In the event of observance of any deviation in any part of our offer at a later date whether implicit or explicit, the deviations shall stand null & void.

We confirm to have submitted offer strictly in accordance with tender instructions

Thanking you,

(Signature of Tenderer)

Date :

Place :

Name and Designation of Authorised person (s)
Signing the tender on behalf of the tenderer

(TO BE FILLED BY TENDERER OVER THEIR LETTERHEAD)

Declaration for Relation in BHEL

REF:

DATE:

To,
AGM/TBSM
Transmission Business Group,
Bharat Heavy Electricals Limited,
6th Floor, BHEL SADAN,
Plot No. 25, Sector-16A, Noida,
Distt. – Gautam Buddh Nagar, UP-201301

Dear Sir,

Sub: Declaration for relation in BHEL

TENDER REF NO.: TBSM/33KV CABLE/ETC/TENDER/26-27

Dated 07.05.2026

I/We hereby submit the following information pertaining to relation/relatives of Proprietor/ Partner(s)/Director(s) employed in BHEL

Tick (✓) any one as applicable:

1. The Proprietor, Partner(s), Director(s) of our Company/Firm DO NOT have any relation or relatives employed in BHEL
OR

2. The Proprietor, Partner(s), or Director(s) of our Company / Firm HAVE relation / relatives employed in BHEL and their particulars are as below:

a)

b)

Signature of the Authorized Signatory

Note:

- 1) Attach separate sheet, if necessary.
- 2) If BHEL Management comes to know at a later date that the information furnished by the Bidder is false, BHEL reserves the right to take suitable action against the Bidder/ Contractor.

(TO BE FILLED BY TENDERER OVER THEIR LETTERHEAD)

DECLARATION REGARDING INSOLVENCY / LIQUIDATION / BANKRUPTCY PROCEEDINGS

REF:

DATE:

To,
AGM/TBSM
Transmission Business Group,
Bharat Heavy Electricals Limited,
6th Floor, BHEL SADAN,
Plot No. 25, Sector-16A, Noida,
Distt. – Gautam Buddh Nagar, UP-201301

Dear Sir,

Sub: Declaration Regarding Insolvency / Liquidation / Bankruptcy Proceedings

Reference Documents :

(a) NIT/Tender NO.: TBSM/33KV CABLE/ETC/TENDER/26-27

Dated

07.05.2026

I/We, _____ declare that, I/We am/are not under insolvency resolution process or liquidation or Bankruptcy Code Proceedings (IBC) as on date, by NCLT or any adjudicating authority/authorities, which will render us ineligible for participation in this tender.

Thanking you,

Date :

(Signature of Tenderer)

Place :

Name and Designation of Authorised person (s)
Signing the tender on behalf of the tenderer

(TO BE FILLED BY TENDERER OVER THEIR LETTERHEAD)

**DECLARATION BY AUTHORISED SIGNATORY OF BIDDER REGARDING
AUTHENCITY OF SUBMITTED DOCUMENTS**

REF:

DATE:

To,
AGM/TBSM
Transmission Business Group,
Bharat Heavy Electricals Limited,
6th Floor, BHEL SADAN,
Plot No. 25, Sector-16A, Noida,
Distt. - Gautam Buddh Nagar, UP-201301

Dear Sir,

Sub: Declaration by Authorized Signatory regarding Authenticity of submitted documents.

Reference Documents :

- (a) NIT/Tender NO. TBSM/33KV CABLE/ETC/TENDER/26-27
(b) All other pertinent issues till date

Dated 07.05.2026

I/We, hereby certify that all the documents submitted by us in support of possession of "Qualifying Requirements" are true copies of the original and are fully compliant required for qualifying / applying in the bid and shall produce the original of same as and when required by Bharat Heavy Electricals Limited.

I / We hereby further confirm that no tampering is done with documents submitted in support of our qualification as bidder. I / We understand that at any stage (during bidding process or while executing the awarded works) if it is found that fake / false / forged bid qualifying /supporting documents / certificates were submitted, it would lead to summarily rejection of our bid / termination of contract. BHEL shall be at liberty to initiate other appropriate actions as per the terms of the Bid / Contract and other extant policies of Bharat Heavy Electricals Limited.

Thanking you,

Date :

(Signature of Tenderer)

Place :

Name and Designation of Authorised person (s)
Signing the tender on behalf of the tenderer

Annexure-MII

DECLARATION REGARDING MINIMUM LOCAL CONTENT IN LINE WITH REVISED PUBLIC PROCUREMENT (PREFERENCE TO MAKE IN INDIA), ORDER 2017 DATED 04TH JUNE, 2020 AND SUBSEQUENT ORDER(S).

REF: TBSM/33KV CABLE/ETC/TENDER/26-27

DATE: 07.05.2026

NIT TENDER FOR INSTALLATION, TESTING & COMMISSIONING OF 19/33 KV (E), 1C × 500 SQ. MM AL. CONDUCTOR, XLPE INSULATED, ARMoured MV POWER CABLE — BETWEEN ENNORE SEZ TPS MAIN PLANT AREA TO SEA WATER INTAKE PUMP HOUSE (OUTSIDE PLANT BOUNDARY, APPROX. 4 KM ROUTE LENGTH) ON CABLE TRENCH / VERTICAL SUPPORT / PIER-MOUNTED CABLE TRAY (AT HEIGHTS RANGING FROM APPROX. 5.0 M TO 12.5 M ABOVE GROUND LEVEL) / CABLE TRESTLE AT ENNORE SEZ PROJECT IN TAMIL NADU."

To,
AGM/TBSM
Transmission Business Group,
Bharat Heavy Electricals Limited,
6th Floor, BHEL SADAN,
Plot No. 25, Sector-16A, Noida,
Distt. – Gautam Buddh Nagar, UP-201301

Dear Sir,

Subject: DECLARATION REGARDING MINIMUM LOCAL CONTENT IN LINE WITH REVISED PUBLIC PROCUREMENT (PREFERENCE TO MAKE IN INDIA), ORDER 2017 DATED 04TH JUNE, 2020 AND SUBSEQUENT ORDER(S).

Reference Documents :

(a) NIT/Tender No. TBSM/33KV CABLE/ETC/TENDER/26-27

Dated

07.05.2026

(b) All other pertinent issues till date

We here by certify that the items/works/services/ offered by (specify the name of the organization here) has a local content of _____ % and this meets the local content requirement for – Class 1 Local supplier/ Class II local supplier** as defined in Public Procurement (Preference to Make in India), Order 2017-Revision dated 04.06.2020 issued by DPIIT and subsequent order(s).

The details of the location(s) at which the local value addition is made are as follows:

1 _____ 2 _____
3 _____ 4 _____

Thanking you,
Yours faithfully,

(Signature, Date & Seal of Authorized Signatory of the Bidder)

** - Strike out whichever is not applicable.

Note:

Bidders to note that above format Duly filled & signed by authorized signatory, shall be submitted.

In case the bidders quoted value is excess of 10 crores, the authorized signatory for this declaration shall necessarily be the statutory auditor or cost auditor of the company (in the case of companies) or a practising cost accountant or practicing chartered accountant (in respect of suppliers/contractors other than companies).

In the event of false declaration, actions as per the above order and as per BHEL Guidelines shall be initiated against the bidder.

(TO BE FILLED BY TENDERER OVER THEIR LETTERHEAD)

DECLARATION REGARDING NO CONFLICT OF INTEREST

REF: TBSM/33KV CABLE/ETC/TENDER/26-27

DATE: 07.05.2026

TENDER FOR INSTALLATION, TESTING & COMMISSIONING OF 19/33 KV (E), 1C x 500 SQ. MM AL. CONDUCTOR, XLPE INSULATED, ARMoured MV POWER CABLE — BETWEEN ENnore SEZ TPS MAIN PLANT AREA TO SEA WATER INTAKE PUMP HOUSE (OUTSIDE PLANT BOUNDARY, APPROX. 4 KM ROUTE LENGTH) ON CABLE TRENCH / VERTICAL SUPPORT / PIER-MOUNTED CABLE TRAY (AT HEIGHTS RANGING FROM APPROX. 5.0 M TO 12.5 M ABOVE GROUND LEVEL) / CABLE TRESTLE AT ENnore SEZ PROJECT IN TAMIL NADU."

To,
AGM/TBSM

Bharat Heavy Electricals Limited,
6th Floor, BHEL SADAN,
Plot No. 25, Sector-16A, Noida,
Distt. – Gautam Buddh Nagar, UP-201301

Dear Sir,

Subject: DECLARATION REGARDING NO CONFLICT OF INTEREST

Reference Documents :

NIT / TENDER NO. TBSM/33KV CABLE/ETC/TENDER/26-27

Dated

07.05.2026

We, M/s. _____ a company/Firm incorporated under the laws of the country having its registered office at _____, hereby declare and confirm the following in connection with the tender No.

We confirm that no conflict of interest exists in our participation in this tender.

None of our personnel, agents, or subcontractors have any personal, financial, or business relationship with BHEL's employees or officials involved in this tender process that could constitute a conflict of interest.

None of our directors, employees, agents, or allied firms have been involved in need assessment, procurement planning, or evaluation of this tender.

If we are acting as an agent/distributor, we confirm that we do not represent more than one manufacturer in this tender and that the OEM is not bidding separately.

We are not participating in more than one bid in this tender. *

*Participating in any capacity by a bidder (including the participation of a Bidder as a partner/JV member or sub-contractor in another bid or vice-versa) in more than one bid shall result in the disqualification of all bids in which he is a party. However, this does not limit the participation of an entity as a sub-contractor in more than one bid if he is not bidding independently in his own name or as a member of a JV.

We understand that false declarations may result in disqualification or legal action."

Thanking you,
Yours faithfully,

(Signature, Date & Seal of Authorized Signatory of the Bidder)

Note:

1) Attach separate sheet, if necessary.

INDEMNITY BOND

(To be typed and submitted in the Letter Head of the Company/Firm of Bidder)

This Indemnity Bond executed by < _____ name of company > having their Registered Office at < _____ > in favour of M/s Bharat Heavy Electricals Limited, a Company incorporated under the Companies Act, 1956, having its Registered Office at BHEL House, Siri Fort, Asiad, New Delhi - 110049 through its unit - TBG, 5th Floor, BHEL Sadan, Plot No. 25, Sector-16A, Noida-201301 (UP). (Hereinafter referred to as the Company)

And whereas the Company has entered into a Contract with M/s _____, the executants of this Deed (hereinafter referred to as the Contractor) as its contractor in respect of the work of INSTALLATION, TESTING & COMMISSIONING OF 19/33 KV (E), 1C x 500 SQ. MM AL. CONDUCTOR, XLPE INSULATED, ARMoured MV POWER CABLE — BETWEEN ENNORE SEZ TPS MAIN PLANT AREA TO SEA WATER INTAKE PUMP HOUSE (OUTSIDE PLANT BOUNDARY, APPROX. 4 KM ROUTE LENGTH) ON CABLE TRENCH / VERTICAL SUPPORT / PIER-MOUNTED CABLE TRAY (AT HEIGHTS RANGING FROM APPROX. 5.0 M TO 12.5 M ABOVE GROUND LEVEL) / CABLE TRESTLE AT ENNORE SEZ PROJECT IN TAMIL NADU.

AND WHEREAS under the provisions of GCC further stipulates that the Contractor shall indemnify the Company against all claims of whatever nature arising during the course of execution of Contract including defects liability period of < _____ Months > i.e till < _____ >

Now this deed witness that in case the Company is made liable by any Authority including Court to pay any claim or compensation etc. in respect of all labourers or other matters at any stage under or relating to the Contract with the Contractor, the Contractor hereby covenants and agrees with the Company that they shall indemnify and reimburse the Company to the extent of such payments and for any fee, including litigation charges, lawyers' fees, etc, penalty or damages claimed against the Company by reason of the Contractor falling to comply with Central/States Laws, Rules etc, or his failure to comply with Contract (including all expenses and charges incurred by the Company).

The Contractor further indemnifies the Company for the amount which the Company may be liable to pay by way of penalty for not making deductions from the Bills of the Contractor towards such amount and depositing the same in the Government Treasury.

The Contractor further agree that the Company shall be entitled to withhold and adjust the Security Deposit and/or withhold and adjust payment of Bills of Contractor pertaining to this Contract against any payment which the Company has made or is required to make for which the Contractor is liable under the Contract and that such amount can be withheld, adjusted by the Company till satisfactory and final settlement of all pending matters and the Contractor hereby gives his consent for the same.

The Contractor further agrees that the terms of indemnity shall survive the termination or completion of this contract.

The contractor further agrees that the liability of the contractor shall be extended on actual basis notwithstanding the limitations of liability clause, in respect of :

- 1. breach of terms of contract by the contractor
- 2. breach of laws by the contractor
- 3. breach of Intellectual property rights by the contractor
- 4. breach of confidentiality by the contractor

Nothing contained in this deed, shall be construed as absolving or limiting the liability of the Contractor under said Contract between the Company and the Contractor. That this Indemnity Bond is irrevocable and the condition of the bond is that the Contractor shall duly and punctually comply with the terms and the conditions of this deed and contractual provisions to the satisfaction of the Company.

In witness where of M/s _____ these presents on the day, month and year first, above written at _____ by the hand of its signatory Mr. _____.

Signed for and on behalf of M/s _____

Witness

1 _____

2 _____

PROFORMA OF BANK GUARANTEE (in lieu of SECURITY DEPOSIT)

(On non-Judicial paper of appropriate value)

In consideration of Bharat Heavy Electricals Limited (hereinafter referred to as the 'Employer' which expression shall unless repugnant to the context or meaning thereof, include its successors and permitted assigns) incorporated under the Companies Act, 1956 and having its registered office at BHEL House, Siri Fort, New Delhi-110049 through its Unit at BHEL, Transmission Business Group, Noida (name of the Unit) having agreed to exempt _____ (Name of the Vendor / Contractor / Supplier) with its registered office at _____¹ (hereinafter called the said "Contractor" which term includes supplier), from demand under the terms and conditions of the Contract reference No. _____ dated _____² valued at Rs. _____³ Rupees _____ (hereinafter called the said Contract), of Security Deposit for the due fulfilment by the said Contractor of the terms and conditions contained in the said Contract, on production of a Bank Guarantee for Rs. _____⁴ (Rupees _____ only),

We _____ (indicate the name and address of the Bank) having its Head Office at _____ (address of the head Office) (hereinafter referred to as the Bank), at the request of _____ [Contractor(s)], being the Guarantor under this Guarantee, do hereby irrevocably and unconditionally undertake to forthwith and immediately pay to the Employer, an amount not exceeding Rs. _____ without any demur, immediately on demand from the Employer and without any reservation, protest, and recourse and without the Employer needing to prove or demonstrate reasons for its such demand

Any such demand made on the bank, shall be conclusive as regards the amount due and payable by the Bank under this guarantee. However, our liability under this guarantee shall be restricted to an amount not exceeding Rs. _____.

We undertake to pay to the Employer any money so demanded notwithstanding any dispute or disputes raised by the Contractor(s) in any suit or proceeding pending before any Court or Tribunal or Arbitrator or any other authority, our liability under this present being absolute and unequivocal.

The payment so made by us under this guarantee shall be a valid discharge of our liability for payment hereunder and the Contractor(s) shall have no claim against us for making such payment.

We, further agree that the guarantee herein contained shall remain in full force and effect during the period that would be taken for the performance of the said Contract and that it shall continue to be enforceable till all the dues of the Employer under or by virtue of the said Contract have been fully paid and its claims satisfied & the Employer certifies that the terms and conditions of the said Contract have been fully and properly carried out by the said contractor(s) or acceptance of the final bill or discharge of this guarantee by the Employer, whichever is earlier. This guarantee shall initially remain in force up to and including _____⁵ and shall be extended from time to time for such period as may be desired by the Employer. Unless a demand or claim under this guarantee is made on us in writing on or before the _____⁶, (3 months more than the present date of validity of Bank Guarantee) we shall be discharged from all the liability under this guarantee thereafter.

We, _____ (indicate the name of the Bank) further agree with the Employer that the Employer shall have the fullest liberty without our consent and without affecting in any manner our obligations hereunder to vary any of the terms and conditions of the said Contract or to extend time of performance by the said contractor(s) from time to time or to postpone for any time or from time to time any of the powers exercisable by the Employer against the said contractor(s) and to forbear or enforce any of the terms and conditions relating to the said Contract and we shall not be relieved from our liability by any reason of any such variation or extension being granted to the said contractor(s) or for any forbearance, act or omission on the part of the Employer or any indulgence by the Employer to the said contractor(s) or by any such matter or thing whatsoever which under the law relating to sureties would but for this provision have effect of so relieving us.

The Bank also agrees that the Employer at its option shall be entitled to enforce this Guarantee against the Bank as a principal debtor, in the first instance without proceeding against the Contractor and notwithstanding any security or other guarantee that the Employer may have in relation to the Contractor's liabilities.

This Guarantee shall not be determined or affected by liquidation or winding up, dissolution or change of constitution or insolvency of the Contractor but shall in all respects and for all purposes be binding and operative until payment of all money payable to the Employer in terms thereof. This guarantee will not be discharged due to the change in the constitution of the Bank or the Contractor(s).

We, _____ BANK lastly undertake not to revoke this guarantee during its currency except with the previous consent of the Employer in writing.

Notwithstanding anything to the contrary contained hereinabove:

- a) The liability of the Bank under this Guarantee shall not exceed _____⁴
- b) This Guarantee shall be valid up to _____⁵
- c) Unless the Bank is served a written claim or demand on or before _____⁶ all rights under this guarantee shall be forfeited and the Bank shall be relieved and discharged from all liabilities under this guarantee irrespective of whether or not the original bank guarantee is returned to the Bank.

We, _____ Bank, have power to issue this Guarantee under law and the undersigned as a duly authorized person has full powers to sign this Guarantee on behalf of the Bank.

Date _____ Day of _____

for _____ (indicate the name of the Bank) _____

(Signature of Authorised signatory)

- ¹ ADDRESS OF THE VENDOR /CONTRACTOR / SUPPLIER .
- ² DETAILS ABOUT THE NOTICE OF AWARD/CONTRACT REFERENCE
- ³ CONTRACT VALUE
- ⁴ BG AMOUNT IN FIGURES AND WORDS
- ⁵ VALIDITY DATE (At least 3 months more than completion period)
- ⁶ DATE OF EXPIRY OF CLAIM PERIOD (At least 3 months more than the present date of validity of BG)

Notes:

- 1 The expiry of claim period shall be at least 3 months more than the validity date. It may be ensured that the same is in line with the agreement/ contract entered with the Vendor.
- 2 The BG should be on Non-Judicial Stamp paper/e-stamp paper of appropriate value as per Stamp Act prevailing in the State(s) where the BG is submitted or is to be acted upon or the rate prevailing in the State where the BG was executed, whichever is higher. The Stamp Paper/e-stamp paper shall be purchased in the name of Vendor/Contractor/Supplier /Bank issuing the guarantee.

3 **In Case of Bank Guarantees submitted by Foreign Vendors:**

a From Nationalized/Public Sector / Private Sector/ Foreign Banks (BG issued by Branches in India)

From Nationalized/Public Sector / Private Sector/ Foreign Banks (BG issued by Branches in India) can be accepted subject to the condition that the Bank Guarantee should be enforceable in the town/city or at nearest branch where the Unit is located i.e. Demand can be presented at the Branch located in the town/city or at nearest branch where the Unit is located.

b From Foreign Banks (wherein Foreign Vendors intend to provide BG from local branch of the Vendor country's Bank)

In such cases, in the Tender Enquiry/ Contract itself, it may be clearly specified that Bank Guarantee issued by any of the Consortium Banks only will be accepted by BHEL. As such, Foreign Vendor needs to make necessary arrangements for issuance of Counter-Guarantee by Foreign Bank in favour of the Indian Bank's (BHEL's Consortium Bank) branch in India. It is advisable that all charges for issuance of Bank Guarantee/ counter- Guarantee should be borne by the Foreign Vendor. The tender stipulation should clearly specify these requirements.

In case, Foreign Vendors intend to provide BG from Overseas Branch of our Consortium Bank (e.g. if a BG is to be issued by SBI Frankfurt), the same is acceptable. However, the procedure at sl.no. b.1 will required to be followed.

FORMAT FOR E-PAYMENT

To,
 GM/Finance
 Transmission Business Group,
 Bharat Heavy Electricals Limited,
 5th Floor, BHEL SADAN,
 Plot No. 25, Sector-16A, Noida,
 Distt. - Gautam Buddh Nagar, UP-201301

Dear Sir,

Sub: e-Payment vide RTGS/NEFT

I / We hereby request and authorise you to effect E-Payment vide any of the two modes to my bank account as per the details given below:

Vendor Name	
Title / Name of account in the bank	
Account Type (Saving / Current)	
Bank account number	
Name and address of the bank	
Bank / Branch contact person's Name	
Bank / Branch Telephone Number with STD Code	
Bank Branch MICR Code (Please enclose a copy of a cheque. This Cheque should not be a payable at par cheque.)	
Bank Branch RTGS IFSC Code	
Bank Branch NEFT IFSC Code	
Vendor email address	
Name of authorised signatory of Vendor	
Vendor's Contact persons name	

I/We confirm that information provided above is correct & any consequences due to any mistake in above will be borne by us.

Thanking you,

Name and Designation of Authorised person (s)

We confirm that we are enabled for receiving RTGS/NEFT credits and we further confirm that the account number of _____, the signature of the authorised signatory and the MICR and IFSC codes of our branch mentioned above are correct.

Bank's Verification
 (Manager's / Officer's Signature under bank stamp)

Note : Please attach cancelled original Cheque leaf

Pre-Qualifying Requirements

Tender Spec. No.: TBSM/33KV CABLE/ETC/TENDER/26-27

Date : 07.05.2026

SUB : TENDER FOR INSTALLATION, TESTING & COMMISSIONING OF 19/33 KV (E), 1C × 500 SQ. MM AL. CONDUCTOR, XLPE INSULATED, ARMoured MV POWER CABLE — BETWEEN ENNORE SEZ TPS MAIN PLANT AREA TO SEA WATER INTAKE PUMP HOUSE (OUTSIDE PLANT BOUNDARY, APPROX. 4 KM ROUTE LENGTH) ON CABLE TRENCH / VERTICAL SUPPORT / PIER-MOUNTED CABLE TRAY (AT HEIGHTS RANGING FROM APPROX. 5.0 M TO 12.5 M ABOVE GROUND LEVEL) / CABLE TRESTLE AT ENNORE SEZ PROJECT IN TAMIL NADU."

Tenders (Under two-part bid system) are invited from competent contractors for subject works. Only those who are technically and financially capable to execute the job and who fulfil the Pre-Qualifying Requirements [PQR] given under are eligible to quote against the above NIT. Tenderers should submit their offer as per the procedure specified in tender documents. The PQR of contractor for tender submission shall be as under:

Sl. No.	Criteria	Description
A	Turn Over	<p>Bidders should have a minimum average annual turnover (Annual Gross Revenue from operations/ Gross operating income as incorporated in the profit & loss account excluding Other Income) of</p> <p style="text-align: center;">₹ 21,52,377.00</p> <p>for last three financial years (2022-23, 2023-24 & 2024-25 OR 2023-24, 2024-25 & 2025-26)</p> <p>and should submit audited balance sheet and Profit & Loss Account Sheet of these years. The audited financial statements must be signed by the owner and the auditor. Auditors seal, Name, Membership No., Firm Registration No. & firm name (if applicable), UDIN and the capacity in which he is signing (Proprietor/Partner), must be mentioned on the Profit & Loss A/c and Balance Sheet.</p> <p>In case of proprietorship and partnership firms where Audited Profit & Loss A/c and Balance Sheet is not mandatory as per extant rules, CA certificate certifying turnover and profit for the required financial years must be submitted. CA certificate must be on his letter head mentioning his/her name, Membership No., Firm Registration No. & firm name (if applicable), UDIN, capacity in which he is signing (Proprietor/Partner), date and place of signing.</p>
B	Profit & Networth	<p>Bidder should have earned profit in at least one financial year during the period of last three Financial Years as per Sl. No. A above</p> <p style="text-align: center;">and</p> <p>Net worth of the Bidder based on the latest Audited Accounts as furnished for 'A' above should be positive. Net worth = Paid up share capital + Reserves. (Net worth is required to be evaluated in case of companies)</p>
C	Similar Work	<p>Bidder should have successfully executed :</p> <p style="text-align: center;">a) Installation of 11KV or above voltage class Cable.</p> <p style="text-align: center;">OR</p> <p style="text-align: center;">b) Installation of 33 kV or above voltage class Switchgear, Substations, or Switchyards.</p> <p style="text-align: center;">AND</p> <p style="text-align: center;">Experience of installation of 11 kV or above voltage class Cable (may be from same or different work order).</p> <p style="text-align: center;">OR</p> <p style="text-align: center;">c) Execution of Electrical Works in a Thermal or Hydro Power Plant;</p> <p style="text-align: center;">AND</p> <p style="text-align: center;">Experience of installation of 11 kV or above voltage class Cable (may be from same or different work order).</p> <p>during last seven years ending on 30.04.2026 and should be either of the following:</p> <p>(i) Three similar jobs executed costing (except service tax/GST) not less than ₹ 28,69,836.00</p> <p style="text-align: center;">OR</p> <p>(ii) Two similar jobs executed costing (except service tax/GST) not less than ₹ 35,87,295.00</p> <p style="text-align: center;">OR</p> <p>(iii) One similar job executed costing (except service tax/GST) not less than ₹ 57,39,672.00</p>

NOTES:

- 1 The Bidder shall submit the Contract Agreement/Work Order/LOI along with BOQ and Performance/completion/execution certificate issued by customer/contractor along with technical bid in support of qualification.
- 2 'EXECUTED' means the bidder should have achieved the criteria specified in the Technical criteria of PQR (as in 'C' above) even if the Contract has not been completed or closed.
- 3 In order to technically qualify in this tender, bidder should meet all criteria i.e. A, B & C mentioned above.
- 4 If the job is completed in the last seven years period, as specified above, even if it has been started earlier, the same will also be considered meeting the qualifying requirements.
- 5 Consortium/ JV bidding is not allowed unless specifically mentioned in NIT.
- 6 BHEL reserves the right to:
 - (a) Accept or reject any bid received at its discretion without assigning any reasons whatsoever.
 - (b) Postpone the above-mentioned date, split and distribute the work among more than one bidder without assigning any reason whatsoever.
 - (c) May ask for further qualification during techno commercial scrutiny of bids received.
 - (d) May ask for further proofs including TDS certificates/ Form 26AS/ Final bill/ payment detail for the said job for cross- verification.
- 7 BHEL shall not be responsible for any delay, loss, damage for bids/documents sent by post.
- 8 BHEL shall not be liable for any expenses incurred by bidder in preparation of bid irrespective of whether it is accepted or not.
- 9 Quotations received from bidders who do not fulfil the PQR shall be summarily rejected without any further evaluation and information to bidders.
- 10 Canvassing i.e. soliciting favour, seeking advantage etc. in any form is strictly prohibited and any bidder found to have engaged in canvassing shall be liable to have his bid rejected summarily
- 11 If the bidder deliberately gives any wrong information in his tender to create in circumstances for the acceptance to his bid, BHEL reserves the right to reject such application.
- 12 Bidder's selection is subject to approval of BHEL's customer for this work. The approval/acceptance of bidders from Customer is mandatory requirement for subject tender.
- 13 All corrigenda, addenda, amendments and clarifications to this Tender will be hosted in web page, www.bhel.com and <https://eprocurebhel.co.in> and not in the newspaper. Bidders shall keep themselves updated with all such amendments.

NIT HSE SPECIFICATIONS



Health Safety and Environment Management System

TRANSMISSION BUSINESS GROUP, NOIDA



BHARAT HEAVY ELECTRICALS LIMITED

	Transmission Business Group Department of Health, Safety & Environment, Noida	Doc No. TBG/HSE/NIT-01 Rev No. : 03 Date: 31.03.26
	NIT HSE Specifications	Page- 1 of 22



Transmission Business Group, Noida

DOCUMENT CONTROL			
Document number:	TBG/HSE/NIT-01		
Issue number:	00	Issue date:	08.01.2020
Revision number:	01	Revision date :	22.10.2021
Revision number:	02	Revision date :	31.01.2024
Revision number:	03	Revision date :	31.03.2026
	Prepared by		Approved and Issued for use by
Name	Arvind Kumar Pandey		
Designation	Sr. Engineer		Head/HSE
Signature	-sd-		
Date	31.03.2026		
Doc. copy issue no. :		Doc. copy issue date :	
Issued to :	Name	Designation	Signature
Issued by :	Name	Designation	Signature

BHARAT HEAVY ELECTRICALS LIMITED

TRANSMISSION BUSINESS GROUP

	Transmission Business Group Department of Health, Safety & Environment, Noida	Doc No. TBG/HSE/NIT-01 Rev No. : 03 Date: 31.03.26
	NIT HSE Specifications	Page- 2 of 22

Preamble: BHEL-TBG, through its long experience and policies, has developed a strong culture of prioritizing societal well-being, environmental protection, and the occupational health and safety of its workforce. Transparency in all business dealings is also a hallmark of TBG. In line with this culture, this NIT HSE Specification provides a concise glimpse of TBG's HSE requirements, drawn from the detailed document '*HSE Plan for Site Operations (for Sub-contractors), Doc. No. HSEP-14*'. While the complete HSE provisions with applicable formats are covered in HSEP-14, this annexure serves as a primary reference to highlight the major compliances that must 100% be adhered to by the successful bidder during contract execution. All interested bidders are advised to carefully review these HSE specifications before quoting.

1. BHEL HSE Policy

(Rev-03)



स्वास्थ्य, सुरक्षा एवं पर्यावरण नीति

बीएचईएल अपने कर्मचारियों और संगठन के लिए काम करने वाले अन्य लोगों के व्यावसायिक स्वास्थ्य और सुरक्षा को सुनिश्चित करने और सक्रिय नेतृत्व के माध्यम से अपनी गतिविधियों, उत्पादों और सेवाओं के पर्यावरणीय पदचिह्नों को कम करने एवं आवश्यक संसाधनों की उपलब्धता सुनिश्चित करने के लिए प्रतिबद्ध है। इसके अलावा, हम अपने पर्यावरण, सामाजिक और प्रशासन (ESG) प्रदर्शन को निम्नलिखित द्वारा लगातार बेहतर बनाने के लिए प्रतिबद्ध हैं:

- शून्य क्षति के लक्ष्य को प्राप्त करने के उद्देश्य से सुरक्षा संस्कृति को मजबूत करना,
- प्रदूषण की रोकथाम, जैव विविधता और पारिस्थितिकी तंत्र की सुरक्षा और जलवायु परिवर्तन शमन (mitigation) और अनुकूलन सहित पर्यावरण की सुरक्षा के लिए गतिविधियों को और सुदृढ़ता से करना,
- 2047 तक शुद्ध शून्य (Net Zero) उत्सर्जन (स्कोप 1 और स्कोप 2) प्राप्त करने के लिए कदम उठाना,
- संसाधनों का संरक्षण करना तथा उनका उपयोग कम करना / पुनर्चक्रण करना / पुनः उपयोग करने (Reduce / Recycle / Reuse) के दृष्टिकोण के आधार पर स्थायी अपशिष्ट प्रबंधन प्रथाओं को अपनाना,
- उन्मूलन / प्रतिस्थापन / कमी / नियंत्रण (elimination / substitution / reduction / control) दृष्टिकोण के माध्यम से पर्यावरणीय प्रभावों तथा व्यावसायिक स्वास्थ्य एवं सुरक्षा जोखिमों का प्रबंधन करना,
- लागू विधानों, विनियमों तथा बीएचईएल प्रबंधन प्रणालियों का अनुपालन सुनिश्चित करना,
- व्यावसायिक निर्णयों, उत्पादों की अवधारणा एवं डिजाइन, संयंत्रों, प्रौद्योगिकियों एवं सेवाओं के चयन, खरीद तथा आउटसोर्स प्रक्रियाओं में उपयुक्त व्यावसायिक स्वास्थ्य, सुरक्षा एवं पर्यावरण मानदंडों को शामिल करना,
- एच.एस.ई. प्रबंधन प्रणाली (एच.एस.ई.एम.एस.) में सुधार के लिए श्रमिकों एवं अन्य हितधारकों से परामर्श एवं भागीदारी सुनिश्चित करना तथा उनकी प्रासंगिकता, उपयुक्तता एवं प्रभावशीलता सुनिश्चित करने के लिए समय-समय पर इस नीति एवं एच.एस.ई.एम.एस. की समीक्षा करना,
- हमारे कार्यस्थलों पर कार्यरत व्यक्तियों को उचित संरचित प्रशिक्षण प्रदान करना तथा एच.एस.ई. मुद्दों पर ग्राहकों, ठेकेदारों एवं आपूर्तिकर्ताओं के बीच जागरूकता को बढ़ावा देना,
- बीएचईएल के भीतर इस नीति का संचार करना तथा ड्यूक पक्षों को इसे उपलब्ध कराना।

(यह नीति अभ्यक्ष एवं प्रबंध निदेशक, बीएचईएल द्वारा अनुमोदित है)



भारत हेवी इलेक्ट्रिकल्स लिमिटेड



Health, Safety & Environment Policy

BHEL is committed to ensure occupational health & safety of its employees and other people working for the organisation and minimising the environmental footprints of its activities, products and services through active leadership and ensuring availability of required resources. Further, we commit to continually improve our Environmental, Social and Governance (ESG) performance by:

- Strengthening safety culture with an objective to attain Zero Harm,
- Taking up activities for protection of the environment, including prevention of pollution, protection of biodiversity & ecosystems and climate change mitigation & adaptation,
- Taking steps for attaining Net Zero emissions (Scope 1 and Scope 2) by 2047,
- Conserving resources and adopting sustainable waste management practices based on Reduce / Recycle / Reuse approach,
- Managing Environmental impacts and Occupational Health & Safety risks through elimination / substitution / reduction / control approach,
- Ensuring compliance with applicable legislations, regulations and BHEL Management Systems,
- Incorporating appropriate Occupational Health, Safety and Environment criteria into business decisions, conceptualisation and design of products, selection of plants, technologies and services, procurements and in outsourced processes,
- Ensuring consultation and participation of workers and other stakeholders for improvements in the HSE Management System (HSEMS) and reviewing periodically this policy and HSEMS to ensure their relevance, appropriateness and effectiveness,
- Imparting appropriate structured training to persons engaged at our workplaces and promoting awareness amongst customers, contractors and suppliers on HSE issues,
- Communicating this policy within BHEL and making it available to interested parties.

(This policy bears the approval of Chairman & Managing Director, BHEL)



Bharat Heavy Electricals Limited

	Transmission Business Group Department of Health, Safety & Environment, Noida	Doc No. TBG/HSE/NIT-01 Rev No. : 03 Date: 31.03.26
	NIT HSE Specifications	Page- 3 of 22

2. Legal/Statutory Compliances:

- a. **Statutory Provisions:** All the sub-contractors are to comply with client specific rules and procedures, the National legislations and codes, in particular the following or their revised versions:

S.no.	Acts/Rules Name	S.no	Acts/Rules Name
1	The Code on Wages, 2019	13	Contractor labour Act, 1970 (Regulation and abolition) (4)
2	The Industrial Relations Code, 2020	14	Provident fund Act, 1952 (3)
3	The Code on Social Security, 2020	15	Payment of gratuity Act, 1972 (3)
4	The Occupational Safety, Health and Working Conditions Code, 2020	16	Indian Explosives Act and the explosives Rules 2008
5	Buildings and Other Construction Workers Welfare Act, 1996 (4)	17	The Gas Cylinder Rules, 2016, Static and Mobile Pressure Vessels (Unfired) Rules 2016
6	The Inter-State Migrant Workmen (Regulation of Employment and Conditions of Service) Act, 1979 (4)	18	The Indian Electricity Act 2003 and Indian Electricity Rules 2005
7	Employee's Compensation Act, 1923 (4)	19	The Atomic Energy Act, 2015
8	Payment of wages Act, 2017 Equal remuneration Act, (1)	20	The atomic energy (Radiation Protection) Rules. 2004
9	Minimum wages Act.1948 (1)	21	National Fire Protection Association (NFPA),
10	Maternity benefit amendment act 2017 (3)	22	National Building Code of India 2016 etc.
11	The Factories Act 1948 (4)	23	The Environment Act 1986
12	Industrial dispute Act, 1947 (2)	24	Employers liability Act, 1938
13	Employees' State Insurance Act, 1948 (3)		

Note: Although new labour codes came into effect from 21.11.2025, yet till the OSHWC Code rules are fully notified and enforced by a State, BOCW Act, Contract Labour Act, Factories Act, etc., continue to apply in that State.

(Rev-03)

- b. **Indian Standard (IS) Codes related to HSE**

All the sub-contractors are to comply with client specific rules and procedures, the National legislations and codes in particular the following or their revised versions:

Srl	IS Code	Applies on
1	IS: 4081 -1986	Safety code for Blasting and Related Drilling operations
2	IS: 3764 -1992	Safety code for excavation work
3	IS: 5121 -1969	Safety code for piling and other deep foundations
4	IS: 2750 -1964	Specification for steel scaffoldings
5	IS: 3696 (Part-I)-1987	Safety code for scaffolds and Ladders: Part- I Scaffolds
6	IS: 3696 (Part-II) -1991	Safety code for scaffolds and Ladders: Part –II Ladders
7	IS: 4082 -1977	Recommendations on stacking and storage of construction materials at site (First revision)
8	IS: 4130-1976	Safety code for demolition of building (First revision)
9	IS: 4912-1978	Safety requirements for floor and wall openings, railings and toe boards (First revision)



NIT HSE Specifications

10	IS: 5916- 1970	Safety code for constructions involving use of hot bituminous materials
11	IS: 7205 -1974	Safety code for erection of structural steel work
12	IS: 7969 -1975	Safety code for handling and storage of building materials
13	IS: 8989 -1978	Safety code for erection of concrete framed structures
14	IS: 7293 -1974	Safety code for working with construction machinery
15	IS: 2212 -1991	Pipe lines –Identification –Colour code
16	IS: 5216 -1982	Recommendations on safety procedures & practices in Electrical works (Part -I & II)
17	IS: 875 -1964	Code of practice for structural safety of buildings and loading standards
18	IS: 10386 -1983	General aspects Part-1 -1983, Part-2 -1982, Part-6 -1983, Part-10 -1983- Amenities, Protective clothing and equipment, construction, storage, handling, detection and Safety measures for gases, chemicals and flammable liquids
19	IS: 10500-2012	Drinking water (Specification)
20	IS: 10291 -1982	Code of dress in civil engineering works
21	IS: 2925-1984	Safety helmets
22	IS: 1179-1967	Welding helmets
23	IS: 7524 -1979 (Part-I)	Safety goggles
24	IS: 9167 -1979	Ear muff /Ear plugs
25	IS: 6994 -1973 (Part-I)	Canvas hand gloves, Cotton hand gloves, Chrome leather gloves
26	IS: 4770 -1991	Rubber hand gloves tested for 15,000 volts
27	IS: 3521 -1999	Full body safety harness
28	IS: 11057 -1984	Specification for Industrial safety nets
29	IS: 13415 -1992	Protective Barriers in & around buildings (Code of safety)
30	IS: 13416 -1992	Preventive measures against Hazards at work places-Recommendations part-I Falling materials hazards Prevention part-I
31	IS: 13416 -1992	Preventive measures against Hazards at work places-Recommendations part-II Fall Prevention
32	IS: 15298 -2011 (Part 1&2)	Personal Protective Equipment -Safety shoes
33	IS: 12254 -1993	Poly vinyl chloride (PVC) industrial boots
34	IS: 5557:2004	Industrial and Protective Rubber knee and Ankle boots
35	IS: 2878 -2004	Co2 Type fire extinguisher
36	IS: 2171 -1999	Dry chemical powder fire extinguisher
37	IS: 13849 – 1993	Fire extinguisher for ABC fires
38	IS: 10204-2001	Mechanical Foam type extinguisher (Foam used shall conform to IS: 4989 -1974 and Co2 cartridge shall conform to IS: 4947 -1985)
39	IS: 3786 -1983	Methods for computation of Frequency rate and Severity rates for Industrial injuries and classification of Industrial accidents (First revision)

	Transmission Business Group Department of Health, Safety & Environment, Noida	Doc No. TBG/HSE/NIT-01 Rev No. : 03 Date: 31.03.26
	NIT HSE Specifications	Page- 5 of 22

3. Standard conditions of Subcontractor mobilization:

- Attend HSE familiarization program at TBG-HQ with his site management team. This will be a half day long awareness session on HSE requirements and compliances which the agency is supposed to fulfil during contract execution at site. The session shall be taken by TBG HSE department on intimation by TBSM. Minutes shall be prepared and shall be jointly signed
- Request for issuance of Form-V in their name from customer on behalf of BHEL
- Get the Labour license registration from concerned Labour office.
- Get the BOCW Registration done along with the labour license.
- Get the labourers registered under BOCW for benefits provided by the office.
- Maintain legal registers of labours as per BOCW requirement.
- Ensure payment of wages to labours not less than the current minimum wages applicable in the premises.
- Ensure PF deduction of labourers and submission of proof to BHEL office (Wage sheet, ECR & Challan copies) duly signed.
- Submit Labour Payment Certificate by 10th of Every month.
- File timely returns, get renewals done and submit a copy to BHEL office.
- Get Workmen's Compensation policy before the start of work, covering all the labourers and staff,
 - Policy should clearly mention the project name and location,
 - should be as per labour class and wage.
 - Should cover all the height workers with clear mention of Max. height.
 - Policy should be submitted to BHEL office and renewal before expiry.
- Issue employment card and identity card to every worker.
- Submit filled and signed RA bill checklist with each bill
- **Judiciously include the cost against safety related expenditures while bidding.**
- Subcontractor shall ensure submission of identity and address proof (preferably Aadhaar card/Voter card) and mobile number of the person to be mobilized at site well in advance.
- Subcontractor shall ensure that the person joining the site has no criminal record.
- Subcontractor shall also ensure the health check-up and induction training is done and the person is covered under employee's compensation insurance policy before he is actually engaged in the work.
- I-card in the prescribed format of BHEL/Customer is mandatory for all the persons of the subcontractor.
- If subcontractor fails to comply with any of the above provisions, BHEL shall not allow the person(s) to enter and work in the project premises. **(Rev-03)**

	Transmission Business Group Department of Health, Safety & Environment, Noida	Doc No. TBG/HSE/NIT-01 Rev No. : 03 Date: 31.03.26
	NIT HSE Specifications	Page- 6 of 22

4. Labour Welfare and Medical Facilities

a. Labour Welfare

1. Declaration of normal working hours and weekly off day, Payment day & intervals
2. Paid rest days & holidays.
3. Payment of overtime @ twice the normal wage rate.
4. No labour shall be allowed overtime >12 hrs/week, limited to 48 hrs/month.
5. Ensure to provide a dedicated rest and lunch area.
6. Separate Male/Female Toilets and Lavatories, clearly marked in local Language and provided with signage.
7. Cold and clean drinking water facility suitable to strength and near workplace
8. Creche for children of female workers as per BOCW requirements
9. Arranging labour accommodation in hygienic environment with the facilities of Water (Drinking, Sanitation), washing and bathing area, toilets in sufficient nos., clean and safe camps and surrounding, access road, well illuminated camp and roads, display of emergency contacts, transport facility, first aid centre, 24x7 Security etc.
10. Cooking and eating place to be maintained in hygienic condition
11. General awareness of health and hygiene.

b. Medical facilities and Health centres

- Availability of first aid box at every work location and agency office, with contents as per BOCW requirement.
- Emergency vehicle (four-wheeler) at work place with display of driver name and number
- Availability of stretchers in emergency vehicle and in office.
- Availability of trained first aider
- Medical check-up for all the supervisors and workers including cooks, at the time of induction and annually thereafter.
- Tetanus Vaccination for all in every six months.
- Identification and tie-up with nearby reputed hospital(s) and display of their contact number in Emergency contact list.

5. House Keeping & Storage

Housekeeping is a continuous process and is the part of work. Agencies shall maintain safe and presentable housekeeping all the time in their respective areas, common work locations and passage areas. Roads, passages, staircases, entrance/exit gates shall always be maintained obstruction free. No material shall be left or stacked at the roof edges. Agency shall make arrangements to remove scraps on regular basis and dispose them at a space provided by customer, clearly fenced and marked by the sub-contractor as “**SCRAP YARD**”. Suitable arrangement like dedicated housekeeping team and tractor/Farana should be identified for this work.

	Transmission Business Group Department of Health, Safety & Environment, Noida	Doc No. TBG/HSE/NIT-01 Rev No. : 03 Date: 31.03.26
	NIT HSE Specifications	Page- 7 of 22

Construction materials like shuttering materials, staging materials, cables, re-bars, cements bags, earthing flats and rods, FF pipes, surplus soil etc should be stored/stacked properly such that it should neither pose threat to safety of man nor should obstruct the free movement of man and machineries.

Every sub-contractor should have separate and well-maintained storage area for his own materials, T&Ps, PPEs and BHEL issued materials. Consumables like diesel, cotton, grease, oil, paint, admixtures and other fire potential materials should be stored separately with suitable firefighting facility.

Fire capacity of store area to be assessed and accordingly fire extinguishers shall be planned suiting the class and capacity of fire. Sand heaps may also be stacked in open store yards suitably to use in case of fires.

6. Site Safety

a. Induction and others safety trainings

Every sub-contractor shall make arrangement to provide induction training as per BHEL and/or customer requirement on a pre-approved and fixed module to all its new inductees irrespective of class or grade of appointment/hire. He shall also arrange the required facilities for induction training such as White board and marker, dummy with all PPEs, posters/banners with all the mandatory PPEs.

Sub-contractor shall also arrange for periodic trainings on fire-fighting, first aid, CPR, importance and use of PPEs, electrical safety, hot work safety, Height work safety, confined space, deep excavations and barricading, concreting work safety etc.

b. Deployment of safety personnel by subcontractor:

(Rev-03)

Deployment of safety personnel may be done as per the conditions prescribed below. This shall be payable at the approved basis of monthly rates as per **Annexure-1**. The qualification and experience criteria of each type of safety personnel is given in the table below:

Type	Safety personnel	Minimum Qualification & Experience	Remarks
A	Safety officer (To be deployed on need basis, as decided by BHEL site-charge.)	Qualification: A recognised Degree or Diploma in Engineering with a recognised Degree or Diploma in Industrial Safety. Experience: in building and other construction works. - Two years for degree in engineering - Five years for diploma in engineering	Applicable to all projects.
B	Safety supervisor (Max.-1 no.)	Qualification: A recognised Diploma in Engineering or B.Sc. Experience: Two years field experience in construction safety.	For POWERGRID Contracts only (where revised POWERGRID safety plan and GCC-2025

	Transmission Business Group Department of Health, Safety & Environment, Noida	Doc No. TBG/HSE/NIT-01 Rev No. : 03 Date: 31.03.26
	NIT HSE Specifications	Page- 8 of 22

			are applicable and when total number of workers exceeds 250)
C	Safety steward (Max.-2 nos.)	Qualification: An ITI or 10th pass, having undergone safety training programs and/or understands basic field safety requirements. Experience: field experience in construction safety. - One year for ITI certificate - Five years for 10th pass	For POWERGRID Contracts only (where revised POWERGRID safety plan and GCC-2025 are applicable- 01 safety steward up to 75 workers, second steward- when total number of workers exceed 75)

- a) The provision for deploying Safety Supervisors or Safety Stewards applies exclusively to **POWERGRID projects** to ensure compliance with specific contractual requirements. This deployment is authorized only for projects where the **Revised POWERGRID Safety Plan** and **GCC-2025** have been formally incorporated into the contract.
- b) Safety personnel deployment and extensions are subject to actual site requirements and shall require a prior formal approval from the Sector Head/concerned GM by the BHEL Site In-charge.
- c) Total worker strength mentioned in remarks column in above table refers to the overall manpower deployed at site under BHEL, not to the manpower of any individual subcontractor.
- d) Subcontractor shall ensure deployment of safety personnel as per the stipulated qualification and experience on the direction of BHEL site-in-charge.
- e) The subcontractor shall deploy safety personnel within 15 days of formal written intimation by BHEL.
- f) The subcontractor shall submit the credentials and present the candidate to the BHEL Site In-Charge for verification and assessment of suitability prior to deployment.
- g) BHEL shall have the right to accept or reject the candidate upon verification and assessment. Subcontractor shall submit credentials of another suitable candidate within the original stipulated time of 15 days.
- h) BHEL site in-charge may seek help of HSE-HQ in verification and suitability assessment of the candidate.
- i) The deployed safety personnel by subcontractor shall functionally report to BHEL Site In-Charge for daily duties and work assignments.
- j) Subcontractor shall demobilize the safety personnel and terminate the services on the written instruction of BHEL Site in-charge on an advance notice of not less than a month.

	Transmission Business Group Department of Health, Safety & Environment, Noida	Doc No. TBG/HSE/NIT-01 Rev No. : 03 Date: 31.03.26
	NIT HSE Specifications	Page- 9 of 22

- k) The subcontractor shall be solely responsible for fulfilling all legal and contractual obligations without additional cost to BHEL. This includes, but is not limited to: applicable minimum wages, medical services, PPE, leave and overtime compensation, transportation, accommodation, and catering.
- l) Additionally, the subcontractor shall provide all necessary administrative resources, including gate pass processing, seating arrangements, secure record storage, stationery, and continuous access to computing and printing facilities.
- m) The safety personnel may be assigned the responsibilities of one or more agencies other than the employing agency as per requirement.
- n) He shall perform his duties in line to meet the requirements of TBG HSE MANAGEMENT SYSTEMS, such as; but not limited to:
- o Ensure compliance to all legal, regulatory, and contractual HSE obligations including customer's contractual requirements.
 - o Implement and monitor BHEL TBG's HSE Manual, Standard Procedures, Formats, Checklists, and Operational Control Procedures (OCPs) in their true spirit within the agency's work area.
 - o Ensures daily toolbox talks, job safety analyses and timely incident investigations.
 - o Maintain and submit safety records, compliance reports, and participate in HSE meetings and audits.
 - o Coordinate with the BHEL site HSE in-charge and lead in organising HSE campaigns, health check-ups, periodic mock drills and participate in regular HSE performance reviews.
 - o conducting site safety inspections, induction trainings and other HSE training and awareness programs,
 - o Ensure other such compliances as per HSE Plan for Site Operation (TBG/HSEP-14) on regular basis.

The sub-contractor shall ensure that the Safety personnel have adequate authority of decision-making and access to resources including workforce to implement safety measures effectively. **(Rev-03)**

c. Safety organisation, Safety committees and meetings

Safety officer shall administratively report to the head of the projects of the sub-contracting agency. There shall be some nominated **safety stewards** from each sub-group like shuttering, bar-bending, concreting, brick work, material handling, structure erection, cable laying, pipe work, maintenance, batching plant, housekeeping, etc.

A **safety committee** shall be formed including members from different agencies, BHEL and customer covering at-least 50% participation from workers. Safety committee shall meet on weekly basis or as may be decided by customer, outcomes shall be complied as committed.

	Transmission Business Group Department of Health, Safety & Environment, Noida	Doc No. TBG/HSE/NIT-01 Rev No. : 03 Date: 31.03.26
	NIT HSE Specifications	Page- 10 of 22

d. Personal Protective Equipment.

Unless mentioned otherwise, there will be three mandatory PPEs- Safety shoes, Safety Helmet and Reflective jackets conforming to relevant IS codes as mentioned above. Every person entering in the project premises shall use above mandatory PPEs.

There will be other PPEs too, based on the work requirement like: Twin lanyard full body harness, fall arresters and life lines for height workers, Face shield for welders and grinders, Induction helmets and Electrical resistant shoes with FRP/PVC toe for electricians and commissioning engineers, Gum boots for concrete workers and manual excavators, Goggle for gas cutters and grinders, Aprons for welders, shoulder pads for material handlers, Hand gloves – Leather for binders/welders/grinders, certified Rubber gloves for electricians, PVC for concrete/cement handlers, cotton-housekeeping team/brick coolies/erectors, cable laying men and other material handlers. Dust mask for cement handlers.

f. Material Handling

BHEL as a policy discourages continuous manual handling. Material handling contributes a major portion in the project and hence proper means (mechanical/ electrical powered) should be deployed appropriately for this work. Cranes/Faranas should not be used for material transportation for long distances(>100m), if such movement is un-avoidable, it must be accompanied by a trained signal man/flag man. Long materials should be guided by tagline. Roads for material movement should be free from obstructions. Lifting appliances must be in good condition and must have test/inspection certificates.

Lifting tackles like- D-shackles, chains, ropes, slings, belts shall be periodically inspected and shall have valid test certificate and/or third-party inspection certificates.

Painted/galvanized structures/materials to be lifted by adequate capacity nylon belts only.

If a machine undergoes a major maintenance, fresh TPI shall be required before use. Hydraulic/pneumatic machines shall be free from leakages. Daily checklist to be filled and witnessed by the concerned supervisor before start of the work.

g. Vehicle/Machinery Documents and other safety requirements (Rev-03)

Sr.:	Required Docs. / compliances	Crawler mounted boom cranes/Tyre mounted telescopic cranes	Loader backhoe (JCB), crawler excavators (Poclairn), Farana lifters/ cranes	Tipper, Transit mixtures/Self-loading concrete mixture (Ajax Fiori), tractors	Cars, Taxis, scooters, motor cycles and other public carriers	Man-lifts (Cherry pickers), Scissors Lifts
1.	Valid third-party inspection certificate.	Yes	Yes	-	-	Yes
2.	Valid Insurance policy	Yes	Yes	Yes	Yes	Yes



NIT HSE Specifications

Sr.:	Required Docs. / compliances	Crawler mounted boom cranes/Tyre mounted telescopic cranes	Loader backhoe (JCB), crawler excavators (Poclain), Farana lifters/ cranes	Tipper, Transit mixtures (TM), Self-loading concrete mixture (Ajax Fiori), Tractors	Cars, Taxis, scooters, motor cycles and other public carriers	Man-lifts (Cherry pickers), Scissors Lifts
3.	Registration Certificate	Yes (if tyre mounted)	Yes	Yes	Yes	Yes (for truck mounted)
4.	Valid Pollution under control (PUC)	Yes (if applicable)	Yes (if applicable)	Yes (if applicable)	Yes (if applicable)	Yes (for truck mounted)
5.	Fitness certificate from RTO	Yes (if tyre mounted)	Yes	Yes	-	Yes (for truck mounted)
6.	Driver/Operator's valid license	Heavy License (LDRXCV/HMV)	Heavy License (LDRXCV/HMV)	Heavy License (HMV)	Yes (As applicable)	Yes (for truck mounted)
7.	Operators experience and/ or competency certificate.	Yes	Yes	-	-	Yes
8.	Swing horn	Yes	-	-	-	Yes
9.	Reverse horn	Yes	Yes	Yes	-	Yes
10.	Boom aviation light	Yes	Yes (if applicable)	-	-	Yes
11.	Approved Load chart (inside cabin)	Yes	Yes (if applicable)	-	-	-
12.	Fire extinguisher (inside cabin)	Yes	Yes	Yes	-	Yes
13.	First aid kit (inside cabin)	Yes	Yes	Yes	Yes	-
14.	Boom angle indicator	Yes	Yes (if applicable)	-	-	Yes (if applicable)
15.	Hook Latch	Yes	Yes (if applicable)	-	-	-
16.	Reflector strips on around cabin and on boom	Yes	Yes	Yes	-	Yes
17.	SLI+Load Limit Switch	Yes	-	-	-	-

	Transmission Business Group Department of Health, Safety & Environment, Noida	Doc No. TBG/HSE/NIT-01 Rev No. : 03 Date: 31.03.26
	NIT HSE Specifications	Page- 12 of 22

Note:

1. No one shall ride man-lift bucket without safety belt, safety shoes, helmet and reflective jacket.
2. Not more than 3 persons at a time will board in bucket of man-lift (without any heavy materials) including operator.
3. Operator will not leave the machine while persons are elevated and working.
4. No one other than the authorised operator will operate the man lifts/Scissors lifts.
5. Hydra cranes are not allowed. Contractors must instead use Farana cranes with that meet safety standards for stability and operator visibility.
6. Farana and other lifting cranes must have operational safe load indicator (SLI) and load limit switch as standard attachment. **(Rev-03)**

h. Excavation

Prior permission/clearance from customer is a must for excavations in areas where underground service services such as gas/water/oil/chemical/electrical lines may be routed. Due precautions shall be taken during excavation in such area. Excavations near water bodies (ponds/canals etc.) shall be done with sand/soil bags ready to plug water from accidental damaged/burst of edges. All the excavations shall be done by either step cutting (min. 600mm step at every 1.5m depth) or slope cutting at 1:2(X:Y axis) (or greater depending upon the soil condition). Where step cutting/slope cutting is not possible due to space constraints, shoring/shuttering or sheet piling to be used to check collapse of soil.

Excavated soil shall be stacked away from edge of the pit, at-least 1.5 meters or half of the depth whichever is higher. Height of the stack shall not exceed 2m in height.

Ramps shall be provided for access of the workers in large pits and ladder of metal/good built for small pits. Ladders shall be of sufficient length protruding at least 1m above the ground level.

Pumps of adequate capacity shall be available for pumping out of water. No lone worker shall be allowed to work in any excavation. Overloaded vehicle shall not be allowed near excavated pits.

i. Bar bending and Binding

Bar bending machine shall be installed under shed/roof. It shall be properly earthed and maintained for operation. Housekeeping of the area shall be team's responsibility on daily basis. All be bar benders shall be given hand gloves (leather/cotton) in addition to mandatory PPEs. Scrap shall be segregated and moved to scrap yard on regular basis. Bar bending station shall be located away from Main plying roads/passages. The station shall be well illuminated, shall have a maintained first aid kit and potable water. Station shall be located in such a way that the movement of the material be minimised.

j. Concreting

No electric vibrators shall be allowed to use. All the concrete workers shall be issued gum boots, safety helmets, reflective jackets and PVC hand gloves. Free fall of concrete from chute shall not exceed 1m in height. Heavy machineries/ vehicles shall be kept at least 2m away from the edge. Emergency vehicle shall be available near concreting work. Late night works shall be avoided, if it is unavoidable, a prior permission from BHEL/Customer is mandatory.

	Transmission Business Group Department of Health, Safety & Environment, Noida	Doc No. TBG/HSE/NIT-01 Rev No. : 03 Date: 31.03.26
	NIT HSE Specifications	Page- 13 of 22

k. Welding, Gas Cutting & other hot works

Welding: Only experienced welders should be deployed for welding jobs. Welders shall be provided with apron, hand gloves, arm pads, leg pads, face shield and safety shoes. Welding leads shall be joint less and insulated. Power input point shall be fully covered at machine.

Gas cutting: If LPG is being used, domestic cylinder is strictly prohibited inside the project premises, (not allowed for site kitchen too). Hose pipes shall be in good condition without cracks, cuts, punctures or joints. Ends should be clamped with worm clamps. Dial gauges shall be of good quality and duly calibrated. Flash back arresters is a must for both oxygen/acetylene or LPG/Oxygen combination. Cylinders shall be stored, transported and used in vertical position only. When not in use, they shall be capped. Empty and filled cylinders to be stored separately with distinct marking.

Cylinders shall neither be rolled on the ground nor thrown during loading/unloading.

Grinding: Grinder shall be given clear glass face shield, apron, safety shoes, ear muffs and hand gloves. Grinder machines shall have wheel guard. Plug tops to be used for power connection preferably three wire type. Only trained persons shall be allowed to use grinders, abrasive cutters. Electrical connection shall be free from cuts, joints etc.

l. Erection & Height Work

Only trained filters and experienced helpers shall be engaged in erection work. Step bolts of lattice towers shall be checked for full tightness with spring washers before use. Height pass shall be issued to the identified group of erectors who have passed medical test and have working experience at height. Name of such workers shall be displayed at appropriate place. These workers only shall be allowed to work at height. Height work shall not be permitted in high wind/bad weather condition, during raining or in night/dark.

m. Electrical Safety

BHEL usually provided single point power source and sub-contractors draw power from there. Otherwise agencies make their own arrangement for construction power like DG sets etc. Sub-contractors shall submit their load requirement (amperage & phase) to BHEL before start of work. Accordingly, they shall make arrangements to draw power and distribution arrangements too in a safe way. MCCBs and HRC fuses to be put in circuit for short circuit and overload protections and RCCBs of 30mA sensitivity to be put at each distribution panel for human safety. Earthing pits shall be installed at each distribution point and maintained below three Ohm resistivity which shall be inspected randomly. The distribution points shall be clean, free from vegetation and water logging, easily accessible and covered/protected from three sides and top for rain. Earthing of DBs shall be done by 25x3mm GI flats connected from proper earth pits. Insulation mat, PVC Sheet/Wooden plank to be placed before DBs as platform. DB Sheds shall be legibly marked with name of agency, contact no of electrician and SLD of that DB. Only industrial plugs and sockets shall be allowed. Three wire (Phase, neutral and earth) system shall be used for tools, lights and machineries and two wire power draws shall be strictly prohibited. PTW and LOTO system shall be maintained to work on LT system. Name and contact no of authorised electricians who will be responsible of electrical power facility maintenance shall be submitted to BHEL by Agencies. Unauthorised sharing of power from one agency to other is strictly prohibited. Electricians shall use standard PPEs and insulated

	Transmission Business Group Department of Health, Safety & Environment, Noida	Doc No. TBG/HSE/NIT-01 Rev No. : 03 Date: 31.03.26
	NIT HSE Specifications	Page- 14 of 22

tools only. Standard and tested/certified discharge rods to be used in the areas where there is a possibility of residual current or induction charge. The induction rod to be connected to the earth first and removed in the last. Induction helmets only to be used in the charged area. Electricians to be provided with electrical resistant safety shoes having FRP/PVC toe.

n. Dust Gases and fumes

Sub-contractor shall make arrangements to avoid accumulation of dust fumes and gases. Cement handlers inside store or at batching plant and gravel spreader shall be given effective nose masks and jaggery (at least 200g per person per day). DG sets and other machineries like cranes excavators etc. shall have valid and effective PUC certificate and shall have maintained engine with silencer. No IC engine operated machine shall be used in confined and covered area like hall, sheds, store etc. where accumulation due to lack of ventilation can increase to harmful levels. Dedicated arrangements (tanker or tractor with sprinkler) shall be made by the sub-contractors (individual or jointly) to continuously subside the dusts arising out of the movement of the vehicle's roads/passages. Welding activities near roof accumulates harmful gases. Welders in such positions shall be provided with effective masks conforming to IS standards.

o. Vehicular Traffic

Speed limits defined within the premises shall strictly be followed by the drivers/commuters of construction as well as other vehicles.

Every construction machinery, man-lift shall display the name, contact no and passport size photograph of the authorised operator (There can be one or more authorised operators).

No one other than operator and co-operator shall sit inside the cabin of any construction machine while it is working.

Construction machineries (tractor, trucks, tippers, JCBs, Farana, Fassi cranes etc. shall never be used as mode of public transport. Machineries like Ajax Fiori and Farana shall not be driven in back direction except for small distances. No overloaded vehicle shall be permitted entry in the project premises.

Over speeding shall be reported and driver/operator shall be barred from entry or shall be penalised.

Drunken drivers shall be barred from entry in the project.

Carrying harmful weapons like knives (>6"), guns etc. shall permanently disqualify the person from entry in project premises.

p. Barricading and floor openings

Every pit deeper than 4 feet (1.2m) shall be barricaded immediately after excavation and will remain barricaded till backfilling.

Pits/trenches drains near roads, passages whether temporary or permanent shall be hard barricaded and well illuminated. Roof edges and openings shall be strictly hard barricaded and illuminated. Height works like masonry works, structure erection, erection by cranes, Lattice tower/beam erection areas shall be barricaded to restrict entry. Areas under charging/commissioning shall be barricaded and caution boards shall be displayed on newly charged areas.

	Transmission Business Group Department of Health, Safety & Environment, Noida	Doc No. TBG/HSE/NIT-01 Rev No. : 03 Date: 31.03.26
	NIT HSE Specifications	Page- 15 of 22

q. Scaffold & Ladder

No bamboo/wooden scaffold shall be allowed to be used. Only tubular steel scaffolds with couplers conforming to the relevant IS codes shall be allowed with base plates. Standard steel or wooden planks to be used as platforms and no packing materials shall be used. All the platforms shall be built with provisions of **top rail at 1m height, mid rail at 0.5m height and toe boards of min 6” height** at floor level. Minimum width of platform shall be 900mm and if wheel barrow is to be used then 1200mm. Means of access to be provided in the form of ladders, ramps or staircase. Multilevel work platforms or those platforms having passage underneath shall be provided with safety net, screen or canopy at each level for protection from falling objects. Platforms shall be free from concrete, debris or other materials. Platforms shall not extend out of the putlogs and shall be secured and fastened. Decking shall be made non-skidding.

Scaffolds under erection shall be tagged “**RED**”, under repair/maintenance/inspection shall be tagged “**YELLOW**” and ready for use shall be tagged “**GREEN**”

Only metal ladders in the construction site and FRP ladders in charged areas shall be allowed. Ladders made from packing materials shall not be used. Ladders shall be securely fixed at bottom, top and long ladders at middle points too at an interval not more than 2400mm and must have a landing at every 6m. Inclination angle should be approximately 1:4 (X:Y) or 75deg. Ladder must extend at least 1m above the platform/access area. Gap between two rungs shall not exceed 300mm. Portable ladder should not be more than 4m in length. Minimum width of the ladder shall not be less than 300mm.

Use of Mobile aluminium scaffold is preferably advisable for erection of transformers/reactors.

r. Illumination

The sub-contractor shall ensure that the areas such as work stations, buildings, batching plants, passages/roads, stores, rest areas, power sources, staircases etc. are illuminated sufficiently to make safe work conditions at site and shall not be less than the relevant IS standards. Excavations/ below ground level structures near passages/roads shall also be sufficiently illuminated.

s. Safety banners/posters, caution boards

Sub-contractors shall display boards and banners in sufficient quantity having safety signs, slogans, important messages, pictures, cautions at prominent locations to promote safety and spread awareness for important precautions such as “Deep Excavation Ahead”, “Speed Limit”, “Charged Area”, “Do not operate”, “Hard hat area”, “No smoking Zone” etc. Boards containing messages of Emergency contacts, First aid facility, rates of minimum wages, working hours, rest day etc. should be displayed at specific areas.

t. Waste management and disposal

Sub-contractor shall make suitable and effective arrangement to remove waste material from site on regular basis and store them in an identified and safe location. Disposal of wastes shall also be done as per manufacturer’s instructions or as per the guidelines laid by legal authorities. Re-bars, Cement bags, packing material (wooden/metal/plastic/paper), paint, oil, grease, cables (armour, sheathing, insulation), civil debris, metal chips, GI sheet scraps, batteries etc. are the common waste materials. Sub-contractor

	Transmission Business Group Department of Health, Safety & Environment, Noida	Doc No. TBG/HSE/NIT-01 Rev No. : 03 Date: 31.03.26
	NIT HSE Specifications	Page- 16 of 22

shall arrange disposal of the hazardous wastes/materials in conformance to the legal and contractual requirements only.

u. Inspection of PPEs, T&Ps, Machineries and lifting appliances

All the PPEs, T&P and lifting appliances purchased newly by sub-contractors shall have test certificates which shall be submitted to BHEL office periodically or on demand. There shall be at least monthly joint inspection schedule for inspection of healthiness of all the PPEs, T&Ps and lifting appliances. All the lifting appliances shall be tested and examined by a competent person before taking into use for the first time or after it has undergone any alterations or repairs liable to affect its strength or stability

and also once at least in every twelve months. To confirm quality of the PPEs as per the relevant IS codes, BHEL may ask sub-contractors to get any or all types of PPEs tested through NABL approved lab as per relevant IS codes. At any stage, the 100% cost of such tests shall be in the scope of respective sub-contractors.

v. Cable Laying

Sub-contractor shall ensure cable trenches free from water, mud, debris, snakes, Scorpions, lizards before start of the work in trenches. Cable drum rollers shall be used to pull cables out of drums to avoid twisting of cables. Hand gloves, Safety shoes/gum boots, reflective jackets, safety helmets shall be provided to the workers. Cable laying area shall be well illuminated.

w. Fire Protection

Every sub-contractor has to maintain their working area, store and office area free from bushes. Stacking of flammable materials like wood, paper, plastic, paint, oil, grease, fuel, cotton, gases etc. at isolated place disconnected from other storage and office areas. Adequate arrangements of firefighting means like suitable extinguishers, fire/water buckets, water tanks, sand dunes etc. shall be made by the agency depending upon the fire capacity assessed or as per MSDS. Fire drills and trainings on how to operate fire extinguishers and how to react in case of fire breakouts shall be the part of regular training program. Guards and store persons must be a regular participant of such training programs. A list of trained firefighting persons and periodicity of such training programs shall be submitted to BHEL by every agency and same to be adhered. Sufficient number of fire extinguishers with suitable class shall be placed at such locations where there can be fire hazard like stores, pantry, office, DG set, electrical distribution panels etc.

x. Fencing of exposed rotating parts

Exposed rotating parts poses great threat to the person in vicinity. Such parts need to be fenced/covered. Guards are mandatory of grinders, abrasive cutters. Flywheels of the engines of heavy machines, Diesel engines, DG sets need to be covered. Electric winch machines, pulleys, chains, shafts, exhaust fans at reachable height, table fans, need to be caged/fenced. Such fencing/guard shall not be removed while machinery is in operation.

	Transmission Business Group Department of Health, Safety & Environment, Noida	Doc No. TBG/HSE/NIT-01 Rev No. : 03 Date: 31.03.26
	NIT HSE Specifications	Page- 17 of 22

y. Emergency preparedness response plan and periodic mock drills.

Sub-contractor shall comply JSA (Job Safety Analysis) and arrange to mitigate the effects of identified possible hazards. He shall also define following in response to emergency preparedness:

An emergency assembly point and put a board of the same with information to all in induction training.

Have facility of ambulance or tie-up with nearest hospital for service in minimum possible time (Max-30min) if there is not ambulance inside the premises.

Ensure availability of emergency vehicle with driver all the time at site during work.

Conduct mock-drills on possible risks like electrocution, fall from height, fire, heat stroke etc., record responses and take photographs to submit in BHEL office. Stretchers availability in emergency vehicle or at work place should be well accessible. Provide fire extinguishers of right type at right place in right quantity with information to all. Display emergency contact nos. to various risk locations and at office, service building or at major work locations. Provide first aid training by doctors for and display names of such trained first aiders and fire fighters. Rescue kit with trained staff or man lift or both to rescue a man hanging by safety belt at height. Provide running water tap near chemical storage and handling points. Agencies shall follow emergency response plan prepared by BHEL in each area of work, store and office.

z. Safety reports & Reporting of accidents

BHEL will provide “formats and checklists” for the purpose of records/documents pertaining to the compliance of aforesaid clauses. Agencies shall be responsible for strict adherence and compliance for timely generation and fill-up of the checklists and reports. These shall be submitted on weekly and monthly basis as specified in the formats.

Agency shall also promote such an environment that the near misses, incidents and accidents are reported by every person, whosoever witnesses them. These shall help in analysing the trend and taking measures in reducing/stopping the accidents/incidents. Initial reporting can be in any form-by call, SMS, WhatsApp, e-mail, letter etc.

Major and fatal accidents or high potential incidents shall be investigated for root cause and outcomes shall be immediately implemented to check recurrences.

7. REPORTING OF ACCIDENTS:

- ❖ Any accident on the construction site which causes loss of life or disables the person from working for a period of more than 10 days, shall be reported in writing to:
 - Regional Labour Commissioner
 - State BOCW Inspector / Board to which the person is registered as beneficiary.
 - Director General of Factory Advice Service and Labour Institutes (DGFASLI), Mumbai
 - Employees’ Compensation Commissioner or ESIC Branch Office as applicable
 - Nearest Police Station
 - District Magistrate (in case of fatality)
 - The next of kin or relative of the person.
- ❖ Fatal accidents within 4 hours and major accidents within 72 hours of occurrence must be reported to authorities as above and client. Hiding facts like incidents, accidents, submitting fake/forged reports/certificates shall also attract penalty/ notice or both.

	Transmission Business Group Department of Health, Safety & Environment, Noida	Doc No. TBG/HSE/NIT-01 Rev No. : 03 Date: 31.03.26
	NIT HSE Specifications	Page- 18 of 22

- ❖ All PPEs shall conform to relevant BIS/IEC/EN standards in performance, not merely carry an ISI mark. For helmets, DGMS-approved models should be preferred, 100% compliance is mandatory.
- ❖ Over speeding of vehicles shall attract penalty/notice and recurrence will attract debarring from entry into project premises.
- ❖ Only approved third party agencies shall be allowed to inspect the machines, T&Ps. Reports shall directly be sent to BHEL/customers by the third parties.
- ❖ Insurance and TPIs to be renewed before expiry. Machines, T&Ps shall not be allowed to work if renewal delayed. Continuity of EC policy to be maintained religiously by the respective agencies.
- ❖ Agency shall submit the status report of his labour license, BOCW registration, EC Policy, insurance & TPI certificate's validity on monthly basis with list of machineries and T&Ps
- ❖ Sub-contractors shall also maintain a buffer stock of all the PPEs in at least 20% excess to the present strength of the work force.
- ❖ Agencies shall be responsible for the compliance of the above requirements. Failure in one or more clauses/area shall attract a notice or monetary penalty or a combination of both. **(Rev-03)**

8. PENAL PROVISIONS:

(Rev-03)

- a) Subcontractor shall be responsible for ensuring HSE compliances with respect to the applicable legal and contractual obligations (refer **TBG/HSEP-14** for details). The performance of the subcontractor with respect to HSE compliances shall be evaluated by BHEL on monthly basis (format no. **TBG/HSEP07:F02**).
- b) Non-compliance with any stipulated HSE requirement shall attract a notice and/or a monetary penalty. Such penalties shall be in addition to any medical expenses incurred for treatment of victims or compensation payable to the affected persons or their families, including amounts covered under insurance policies (Employees' Compensation Policy / Group Insurance). Monetary penalties shall be recovered from the next bills or from the EMD/SD of the subcontractors, as applicable.
- c) In addition to the above, BHEL has the right to suspend/debar the subcontractor from participating in future tenders for a period of one year from the date of second fatal accident.
- d) Upon the first incident, BHEL Site In-charge shall issue a notice to the agency, cautioning that suspension/debarment will be considered in the event of a second fatal incident.
- e) Post mobilization, the subcontractor shall consult with the BHEL site in-charge to understand and acknowledge the customer's penal provisions that may be levied upon or passed on to the subcontractor in the event of any non-compliance or incident.

	Transmission Business Group Department of Health, Safety & Environment, Noida	Doc No. TBG/HSE/NIT-01 Rev No. : 03 Date: 31.03.26
	NIT HSE Specifications	Page- 19 of 22

The penalties shall be applicable as below:

8.1. Penal Provisions for Non-Compliances and Safety Violations.

- a) Up to ₹1,000/- per person/incident per day for HSE related non-compliances and safety violations (**Refer- Clause 18**, HSE NON-COMPLIANCE & PENALTIES of TBG/HSEP-14).
- b) Three times consecutive penalty on the same person for the same reason shall debar him/her from working into the TBG project premises.
- c) In case a penalty is imposed by the customer on account of non-compliances and safety violations, the higher of the two amounts shall be recoverable from the subcontractor.

8.2. Penal Provisions for Non-deployment of safety personnel.

- a) Deployment of safety personnel will be done on formal written communication from BHEL. In case the contractor fails to deploy the required safety manpower within the stipulated time, a recovery of **₹50,000/-** per person per month or part thereof shall be made from the next bill, irrespective of the category of safety manpower, notwithstanding availability of schedule of rate item for deployment of safety personnel in the contract which shall be operated as per contract provisions.
- b) Upon failure to deploy the required safety personnel by subcontractor, BHEL reserves the right to deploy a full-time qualified Safety Officer through its existing Safety Consultancy Rate Contract and assign duties of any category of safety personnel. The cost incurred on such deployment shall be recovered from the subcontractor at the higher of the actual expenditure incurred by BHEL or **₹50,000/-** per person per month.
- c) If a safety personnel is deployed by BHEL on behalf of the subcontractor, the person shall remain deployed for a minimum period of two months from the date of deployment and recovery shall be made accordingly. If the subcontractor mobilizes his safety personnel during this period (two months), no payment against that item shall be admissible by BHEL.
- d) Continuous absence of deployed safety personnel for more than **10 days** shall be treated as demobilization, penalty shall be imposed on a pro-rata basis for the entire period of absence.
- e) Any penalty imposed by the customer on account of non-deployment of safety personnel, attributable to sub-contractor shall be recoverable from the subcontractor.
- f) The deployment of safety personnel by BHEL on behalf of subcontractor will not absolve him from legal and contractual obligations.
- g) Instructions of safety person engaged by BHEL directly or indirectly (through other agencies/subcontractors) to be followed by the subcontractor.

	Transmission Business Group Department of Health, Safety & Environment, Noida	Doc No. TBG/HSE/NIT-01 Rev No. : 03 Date: 31.03.26
	NIT HSE Specifications	Page- 20 of 22

- h) BHEL Site In-charge shall issue a written intimation to the subcontractor with copy to TBSM, regarding deployment of safety personnel on behalf of the subcontractor. The subcontractor shall provide a written acknowledgement of the same.

8.3. Penalty Provisions on Major/disablement/Fatal accidents.

- a) Major injuries or accidents causing 25% or more permanent disablement: **₹2,00,000/-** per incident. The cumulative penalty amount shall be limited to 5% of the original contract value.
- b) Fatality or permanent disability with total loss of earning capacity: **₹5,00,000/-** per incident irrespective of contract value.

8.4 If the penalties **imposed by the customer** for major/disablement/fatal accidents, attributable to subcontractor are **higher** than the limits mentioned in **clause 8.3** above, then recoveries shall be made as per the following conditions:

- a) **Contracts up to ₹1 crore value:** Clause no. **8.3** shall apply.
- b) **Contracts above ₹1 crore to ₹5 crore value:** Customer penalty shall be transferred to subcontractor, subject to a liability of the higher of **Rs. 5 lakh** or **3%** of original contract value per person/per incident but not exceeding the actual penalty imposed.
- c) **Contracts with value of more than ₹5 crore:** Customer-imposed penalty shall be transferred to the subcontractor, subject to a liability of the higher of **₹15 lakh** or **2%** of the original contract value per person/per incident, but not exceeding the actual penalty imposed.

9. Creation of common HSE Facilities on contribution basis at sites:

All health, safety and welfare provisions stipulated under the Building and Other Construction Workers (Regulation of Employment and Conditions of Service) Act, 1996 and allied rules shall be adequately and timely complied with by the subcontractor. These include, but are not limited to, arrangements for clean drinking water, toilets and urinals, safe electrical installations, periodic health check-ups of workers, operators and supervisors, medical examination of height workers, tetanus vaccination, induction training and provision of mandatory and job specific PPEs. In the event of non-compliance or delay in fulfilling these obligations, BHEL reserves the right to arrange the same on behalf of the subcontractor, along with applicable overhead charges.

In order to comply with the legal and contractual obligations, BHEL site in-charge shall decide to create certain HSE facilities involving fixed or recurring expenditure which shall

	Transmission Business Group Department of Health, Safety & Environment, Noida	Doc No. TBG/HSE/NIT-01 Rev No. : 03 Date: 31.03.26
	NIT HSE Specifications	Page- 21 of 22

be operated on a contributory basis among the running contracts at site. The contribution shall be determined proportionately based on either the manpower strength or the original contract value of each subcontractor, as decided by the site management. The facilities to be covered under this arrangement include, but are not limited to:

- Dust suppression arrangements,
- Ambulance van (Advanced Life Support type),
- Periodic visit of a qualified medical officer,
- Engagement of trained first-aid person or a qualified nurse for the medical/first-aid centre.
- Drinking water facility with periodic cleaning arrangement.
- Toilet/urinal facility with daily cleaning arrangement.

The contribution per contractor per month shall not exceed ₹20,000 (Rupees Twenty Thousand only). Any balance cost beyond this limit shall be borne by BHEL. **(Rev-03)**

10. Revision History

Revision Date	Revision No.	Old Text	New Text	Reason	Revised by (with sign)
03.05.2019	00	N/A	Full Document	New Release	-sd-
12.10.2021	01	Nil	Attend HSE familiarization program at TBG-HQ with his site management team. This will be a half day long awareness session on HSE requirements and compliances which the agency is supposed to fulfil during contract execution at site. The session shall be taken by TBG HSE department on intimation by TBSM. (at page no. 5)	For better understanding of HSE requirements to agency. (HSE Review meeting dated 23.08.2021)	-sd-
12.10.2021	01	Edition	Inclusion of penalty provisions in case of non-deployment of safety person (page-8)	Introduction of HSEP-14	-sd-
17.01.2024	02	Edition	Appointment and duties of qualified safety officer (Page-8)	As per BOCW 1996	-sd-
05.09.2025	03	Edition	Document name change, Clause (1) new HSE policy, Revised clause 2(a), 3, 6 (b,c,g) addition of new clause 7,8&9,	Inclusion of CFC recommendations	-sd-

--End of Document--

BHARAT HEAVY ELECTRICALS LIMITED
TRANSMISSION BUSINESS GROUP,
NEW DELHI



CONDITIONS OF CONTRACT
FOR
ERECTION WORKS

DOC. NO. – TB-ETC-GCC,REV.-02
20th JUNE, 2005

BHARAT HEAVY ELECTRICALS LTD.
TRANSMISSION BUSINESS GROUP, NEW DELHI.
Conditions of Contract for Erection Works, Rev-02

INDEX

S.No.	Description	Page No.
A.0	GENERAL INSTRUCTIONS TO TENDERERS	05 – 31
A.1.0	Procedure for submission of Sealed Tenders	6
A.2.0	Procedure for evaluation of Price Bids	6
A.12.0	Data to be enclosed	8
A.13.0	Earnest Money Deposit	9
A.14.0	Authorization and Attestation	10
A.15.0	Validity of Offer	11
A.16.0	Execution of Contract	11
A.17.0	Security Deposit	11
A.19.0	Rejection of Tender and Other conditions	14
Annex-A	Details of work executed/ Being Executed	17
Annex-B	Proposed Manpower	18
Annex-C	Status of Tools, Plants and Instruments	19
Annex-D	Analysis of Unit Rate	20
Annex-E	Declaration sheet	21
Annex-F	Checklist and Schedule of General Particulars	22
Annex-G	Deleted.	
Annex-H	Contract Agreement	23
Annex-I	Form of BG for Security Deposit	25
Annex-J	Proforma for Performance Guarantee	27
Annex-K	Revised offer in lieu of Deviation withdrawal	30
Annex-L	BG confirmation letter from Banker	31
B.0	GENERAL TERMS AND CONDITIONS	32-61
B.1.0	Definitions	33
B.2.0	Law governing the contract and Court Jurisdiction	35
B.3.0	Issue of Notice	35
B.4.0	Use of Land	36
B.5.0	Commencement of Work	36
B.6.0	Measurement of work and Mode of Payment	36
B.7.0	Rights of BHEL	38
B.8.0	Responsibility of Contractor in respect of local laws	40
B.9.0	Responsibility of Contractor in respect of Safety	44
B.10.0	Consequences of Cancellation	47
B.11.0	Insurance	48
B.12.0	Strikes and Lockouts	48
B.13.0	Force Majeure	49
B.14.0	Guarantee	49

BHARAT HEAVY ELECTRICALS LTD.
TRANSMISSION BUSINESS GROUP, NEW DELHI.
Conditions of Contract for Erection Works, Rev-02

B.15.0	Arbitration	50
B.16.0	Variations and Valuations of variations	51
Annex-M	Programme of Work	54
Annex-N	List of Test Equipment	54
Annex-P	Activities for Testing and Commissioning	58
Annex-Q	List of Tools and Tackles	61
C.0	SPECIAL CONDITIONS OF CONTRACT	63 - 76
C.1.0	Qualification of Contractor	64
C.2.0	Terms of Payment	65
C.3.0	Security Deposit	66
C.4.0	Performance Guarantee	67
C.5.0	LD/Penalty for Delay in Execution	67
C.6.0	Receipt/Unloading etc. at site	68
C.7.0	Facilities to be provided by contractor	68
C.8.0	Testing and Commissioning	68
C.9.0	Completion of Contract	70
C.10.0	Trial Operation and Handing over	70
C.11.0	Additional Expenditure	71
C.12.0	Splitting the work	71
C.13.0	Supply of Material	71
C.14.0	Electricity and Water	72
C.15.0	Insurance	73
C.16.0	Escalation/Price Variation	73
C.17.0	Over run charges	73
C.18.0	Construction Schedule	73
C.19.0	Heavy material handling Equipment	73
C.20.0	Calibrated Test Instruments	73
C.22.0	Protection of Work	74
C.23.0	Safety Measures	74
C.24.0	Quality Records	74
C.28.0	Working Hours	75
C.29.0	Division of Work	75
C.30.0	Income Tax/Sales Tax/Works Tax	75
C.31.0	Discrepancies and Adjustment of Errors	76
D.0	ERECTION CONDITIONS OF CONTRACT	78-94
D.1.0	General	79
D.2.0	Regulation of Local Authorities & Statutes	79
D.3.0	Owner's Lien on Equipment	80
D.4.0	Re-works etc.	80
D.5.0	Access to site and works on site	80
D.6.0	Contractors Site office Establishment	80

BHARAT HEAVY ELECTRICALS LTD.
TRANSMISSION BUSINESS GROUP, NEW DELHI.
Conditions of Contract for Erection Works, Rev-02

D.7.0	Co-operation with other contractors	81
D.8.0	Discipline of Workmen	81
D.9.0	Contractors Field Operation	82
D.10.0	Photographs and Progress Reports	82
D.11.0	Manpower Report	83
D.12.0	Protection of Work	83
D.13.0	Employment of Labour	83
D.14.0	Facilities to be provided by Owner	84
D.15.0	Facilities to be provided by Contractor	84
D.16.0	Lines and Grades	85
D.17.0	Fire Protection	86
D.18.0	Security	86
D.19.0	Contractors Area Limits	87
D.20.0	Contractor's co-operation with Owner/BHEL	87
D.21.0	Pre -commissioning Trials and Initial Operation	87
D.22.0	Material handling and Storage	88
D.23.0	Construction and Arrangements	90
D.24.0	Field Quality Plans and Records	91
D.25.0	Contractor's Material brought to site	91
D.26.0	Protection of Property and Contractors liability	92
D.27.0	Painting	92
D.28.0	Protection of Monuments and Reference Points	92
D.29.0	Work and Safety Regulations	93
D.30.0	Electrical Safety Regulations	93
D.31.0	Consumables	94
D.32.0	MS and Aluminium Welding	94
E.0	SCOPE OF WORK AND COMPLETION SCHEDULE	96-106
E.1.0	Scope of work	97
E.2.0	Erection, Testing and Commissioning Requirements	100
E.3.0	Method of workmanship and Quality of work	101
E.4.0	Equipment, Material and Services to be provided	102
E.5.0	Testing and Commissioning Equipment	104
E.6.0	Preparation for Commissioning	104
E.7.0	Minor Civil works	105
E.8.0	Price Schedules	106
E.9.0	Start of work and completion schedule	106
E.10.0	Schedule of Equipment	106

BHARAT HEAVY ELECTRICALS LTD.
TRANSMISSION BUSINESS GROUP, NEW DELHI.
Conditions of Contract for Erection Works, Rev-02

SECTION- A

GENERAL

INSTRUCTIONS TO

TENDERERS

BHARAT HEAVY ELECTRICALS LTD.
TRANSMISSION BUSINESS GROUP, NEW DELHI.
Conditions of Contract for Erection Works, Rev-02

SECTION - A

GENERAL INSTRUCTIONS AND INFORMATION FOR TENDERER

A.1.0 : PROCEDURE FOR SUBMISSION OF SEALED TENDERS

Please refer Annexure to the Conditions of Contract for Erection work attached with the tender documents

PART - II (PRICE - BID) COVER - II:

Rate/Price Schedule only shall be given in this part - II "Price Bid".

A.2.0 : PROCEDURE FOR EVALUATION OF PRICE BID

Please Refer "ANNEXURE TO CONDITIONS OF CONTRACT FOR ETC WORKS" attached with the tender document

BHARAT HEAVY ELECTRICALS LTD.
TRANSMISSION BUSINESS GROUP, NEW DELHI.
Conditions of Contract for Erection Works, Rev-02

A.3.0

Please Refer "ANNEXURE TO CONDITIONS OF CONTRACT FOR ETC WORKS"
attached with the tender document

A.4.0

A.5.0

A.6.0

A.7.0

A.8.0

A.9.0

BHARAT HEAVY ELECTRICALS LTD.
TRANSMISSION BUSINESS GROUP, NEW DELHI.
Conditions of Contract for Erection Works, Rev-02

A.10.0

A.11.0

A.12.0

A.12.1

A.12.2

Please Refer "ANNEXURE TO CONDITIONS OF CONTRACT FOR ETC WORKS"
attached with the tender document

A.12.3 Three years financial turn over (certified), present commitments with all orders in hand, value of total order, value completed, and balance with completion dates as per Annexure-A.

BHARAT HEAVY ELECTRICALS LTD.
TRANSMISSION BUSINESS GROUP, NEW DELHI.
Conditions of Contract for Erection Works, Rev-02

A.12.4 ORGANISATION CHART & MANPOWER DEPLOYMENT:

The organisation pattern and the manpower that are totally available with him & that will be deployed by the tenderer for this work in the form of month wise and category wise deployment plan duly indicating the number of Engineers, Supervisors, Skilled and Unskilled Workers etc. as per proforma at Annexure-B shall be submitted.

A.12.5 A list of machines, tools and plant that the tenderer is having and those that will be deployed on this job giving proof of ownership or any tie-up of equipment as per proforma enclosed at Annexure-C.

A.12.6 Analysis of unit rate quoted as per proforma enclosed at Annexure-D.

A.12.7 Declaration sheet as per proforma enclosed at Annexure-E.

A.12.8 Checklist as per proforma enclosed at Annexure-F.

A.12.9 Certificate from schedule Bank to prove his financial capacity to undertake the work or solvency certificate from the concerned Government Authority.

A.12.10 A certificate of Income Tax/Sales Tax verification from the appropriate authority in the forms prescribed duly indicating annual turnover. These certificates shall be valid for one year from the date of issue or for the period prescribed therein for all tenders submitted during the period.

A.12.11 In addition to the above, the particulars required elsewhere in the tender documents.

A.12.12 NOTE: In terms of clauses A.12.1 to A.12.11 above, all the data required to be enclosed with the tender need to be furnished neatly typed, signed & stamped in the given formats only (in the form of separate sheets) failing which the tender may be considered as incomplete and is liable for rejection. Documentary proof wherever necessary also need to be enclosed.

A.13.0 EARNEST MONEY DEPOSIT

A.13.1 Please refer "Annexure to conditions of contract for ETC Work" attached with the tender documents.

BHARAT HEAVY ELECTRICALS LTD.
TRANSMISSION BUSINESS GROUP, NEW DELHI.
Conditions of Contract for Erection Works, Rev-02

A.13.2

A.13.3

A.13.4

A.13.5 Please refer " Annexure to conditions of contract for ETC Work"
attached with the tender documents.

A.13.6

A.13.7

A.13.8

Above clause No. A.13.0 stands deleted. Please refer Annexure to conditions of contract for ETC works.

A.14.0 **AUTHORISATION AND ATTESTATION:**

A.14.1 Tenders shall be signed by persons duly authorised / empowered to do so. Certified copies of such authority and relevant documents shall be submitted along with the tenders.

BHARAT HEAVY ELECTRICALS LTD.
TRANSMISSION BUSINESS GROUP, NEW DELHI.
Conditions of Contract for Erection Works, Rev-02

A.15.0 VALIDITY OF OFFER:

A.15.1 THE OFFER SHALL BE KEPT OPEN FOR ACCEPTANCE FOR A MINIMUM PERIOD OF FOUR MONTHS FROM THE DATE OF OPENING OF TENDERS. In case the BHEL calls for negotiations, such negotiations shall not amount to cancellation or withdrawal of the original offer which shall be binding on the tenderer.

A.16.0 EXECUTION OF CONTRACT :

A.16.1 The successful tenderer's responsibility under this contract commences from the date of issue of the Letter of Intent by BHEL. The successful tenderer shall be required to execute an agreement in the prescribed form as per Annexure-H with BHEL within a reasonable time after the acceptance of his tender and in any case before submitting the first bill for payment. The expenses for completion, stamping and registration of the agreement with prescribed authority if necessary, shall be borne by the contractor.

A.17.0 SECURITY DEPOSIT:

Please refer " Annexure to conditions of contract for ETC Work" attached with the tender documents.

A.17.1

**BHARAT HEAVY ELECTRICALS LTD.
TRANSMISSION BUSINESS GROUP, NEW DELHI.
Conditions of Contract for Erection Works, Rev-02**

e)

f)

Please refer " Annexure to conditions of contract for ETC Work"
attached with the tender documents.

g)

h)

i)

j)

k)

l)

Note

BHARAT HEAVY ELECTRICALS LTD.
TRANSMISSION BUSINESS GROUP, NEW DELHI.
Conditions of Contract for Erection Works, Rev-02

A.17.2

Please refer " Annexure to conditions of contract for ETC Work" attached with the tender documents.

A.17.3

A.17.4

A.17.5

A.17.6

A.17.7

Above clause No. A.17.0 stands deleted. Please refer Annexure to conditions of contract for ETC works.

BHARAT HEAVY ELECTRICALS LTD.
TRANSMISSION BUSINESS GROUP, NEW DELHI.
Conditions of Contract for Erection Works, Rev-02

A.19.0 **REJECTION OF TENDER & OTHER CONDITIONS:**

A.19.1

Please Refer "ANNEXURE TO CONDITIONS OF CONTRACT FOR ETC WORKS"
attached with the tender document

A.19.2

A.19.3

A.19.4

A.19.5

BHARAT HEAVY ELECTRICALS LTD.
TRANSMISSION BUSINESS GROUP, NEW DELHI.
Conditions of Contract for Erection Works, Rev-02

A.19.6

A.19.7

A.19.8

Please Refer "ANNEXURE TO CONDITIONS OF CONTRACT FOR ETC WORKS"
attached with the tender document

A.19.9

A.19.10

A.19.11

A.19.12

**BHARAT HEAVY ELECTRICALS LTD.
TRANSMISSION BUSINESS GROUP, NEW DELHI.**

Conditions of Contract for Erection Works, Rev-02

- A.19.13 The tenderers must go through Annexure 'Q' of Section-B which details out the List of Tools, Tackles & Calibrated Test Equipments to be arranged by ETC contractor together with special purpose instruments which can be provided by BHEL free of cost for execution of work provided the same is informed to BHEL on award of contract.

Also, Annexure 'Q' gives the details of specialised Services which can be provided by BHEL for system commissioning on NO CHARGE basis with advance intimation to 'ENGINEER' in this regard. The tenderer must also see Clause E.4.2 & E.6.3 of Section E for more details.

- A.19.14 IT WOULD BE PREFERRED THAT YOUR OFFER IS WITHOUT ANY DEVIATION w.r.t. TENDER SPECIFICATIONS AND THE SAME MAY BE CLEARLY MENTIONED ON THE COVERING LETTER ACCOMPANYING THE TECHNICAL BID. Offers with deviations are likely to be rejected. However if the bidder insists on any technical or commercial deviations, from the specification and/or tender conditions, the price implication if any, of withdrawing the deviations must be submitted along with the price bid in a separate sealed envelope superscribed "Price Implication for withdrawal of deviations". No price implication for withdrawal of deviation shall be accepted at a later date, after the opening of technical bid.

BHARAT HEAVY ELECTRICALS LTD.
TRANSMISSION BUSINESS GROUP, NEW DELHI.
Conditions of Contract for Erection Works, Rev-02

ANNEXURE - A

DETAILS OF WORK EXECUTED / BEING EXECUTED

A) WORK EXECUTED

SL. NO.	FINANCIAL YEAR	CUSTOMER	DESCRIPTION OF WORK	TOTAL ORDER VALUE	REMARKS

B) WORK BEING EXECUTED

SL. NO.	CUSTOMER	DESCRIPTION OF WORK	TOTAL VALUE	VALUE OF THE PORTION COMPLETED	ACTUAL START DATE	EXPECTED COMPLETION DATE	REMARKS

**(SIGNATURE OF TENDERER)
WITH STAMP**

BHARAT HEAVY ELECTRICALS LTD.
TRANSMISSION BUSINESS GROUP, NEW DELHI.
Conditions of Contract for Erection Works, Rev-02

ANNEXURE - B

**(A) PROPOSED MANPOWER (ENGINEERS / SUPERVISORS) RESOURCES
FOR EXECUTION OF WORK**

SL. NO.	NAME OF STAFF	QUALIFICATION	EXPERIENCE IN YEARS	REMARKS

(B) MONTH WISE MANPOWER DEPLOYMENT PLAN

SL. NO.	CATEGORY	INDICATE NO. OF PERSONS TO BE DEPLOYED IN EACH MONTH								
		1st	2nd	3rd	4th	5th	6th	7th	8th	AND SO ON

(C) Total Man-days planned to be deployed for the work :Man-days
Plus man-days for unskilled labour as per site requirement.

**(SIGNATURE OF TENDERER)
WITH STAMP**

BHARAT HEAVY ELECTRICALS LTD.
TRANSMISSION BUSINESS GROUP, NEW DELHI.
Conditions of Contract for Erection Works, Rev-02

ANNEXURE - C

(A) STATUS OF TOOLS, PLANTS & INSTRUMENTS

Sl. No.	Name of Eqpt.	Quantity owned	Registration No. wherever applicable	Documents enclosed for proof of Ownership/Tie-up	Present Location	Quantity proposed to be deployed for this job

(B) MONTH WISE TOOLS, PLANTS & INSTRUMENTS DEPLOYMENT PLAN

Sl. No.	Description of Tools, Plants and Instruments	(Indicate No. to be deployed in each month)							
		1st	2nd	3rd	4th	5th	6th	7th	and so on

**(SIGNATURE OF TENDERER)
WITH STAMP**

BHARAT HEAVY ELECTRICALS LTD.
TRANSMISSION BUSINESS GROUP, NEW DELHI.
Conditions of Contract for Erection Works, Rev-02

ANNEXURE - D

ANALYSIS OF UNIT RATE

Sl. No.	DESCRIPTION	PERCENTAGE OF THE UNIT RATE	REMARKS
01	Salary & Wages for staff & workers		
02	Materials (a)) (b)) (c)) (d))		
03	Depreciation & maintenance for T & P		
04	Depreciation & maintenance for other items		
05	Establishment & Admn. expenses of site		
06	Overheads		
07	Profit		

**(SIGNATURE OF TENDERER)
WITH STAMP**

BHARAT HEAVY ELECTRICALS LTD.
TRANSMISSION BUSINESS GROUP, NEW DELHI.
Conditions of Contract for Erection Works, Rev-02

ANNEXURE -E

DECLARATION SHEET

I hereby certify that all the information and data furnished by me with regard to this Tender Specification No. are true and complete to the best of my knowledge. I have gone through the specification, conditions and stipulations in detail and agree to comply with the requirements and intent of specifications.

(SIGNATURE OF TENDERER)
WITH STAMP

BHARAT HEAVY ELECTRICALS LTD.
TRANSMISSION BUSINESS GROUP, NEW DELHI.
Conditions of Contract for Erection Works, Rev-02

ANNEXURE - F

CHECKLIST & SCHEDULE OF GENERAL PARTICULARS

NOTE: Tenderers are requested to fill in the following details and no column should be left blank.

1. Name & Address of the Tenderer :
2. Telegraphic/telex address :
3. Phone/Fax No. (Office) :
4. Name & designation of the official of the tenderer to whom all the references shall be made :
5. Tenderer's Proposal No. & date :
6. Whether EMD submitted (by cash/ Bank Guarantee/Bank Draft) : By.....
7. Validity of offer/rates quoted for six months from the date of opening of tender : Yes/No
8. Attested copy of power of attorney as per Clause-A.12.1 : Yes/No
9. Solvency Certificate submitted as per Clause-A.12.9 : Yes/No
10. Income Tax/Sales Tax Certificate submitted as per Clause-A.12.10 : Yes/No
11. Details of work executed/being executed as per Annexure-A : Yes/No
12. Monthwise & Category wise manpower deployment plan as per Annexure-B : Yes/No
13. Status of Tools, Plants and Instruments & their month wise deployment plan as per Annexure-C : Yes/No
14. Analysis of unit rate quoted as per Annexure-D : Yes/No
15. Declaration sheet as per Annexure-E : Yes/No
16. Request for registration (for new tenderers) submitted : Yes/No

Date

(SIGNATURE OF TENDERER)
WITH STAMP

WITNESS : (Signature with full particulars)

- 1.
- 2.

BHARAT HEAVY ELECTRICALS LTD.
TRANSMISSION BUSINESS GROUP, NEW DELHI.
Conditions of Contract for Erection Works, Rev-02

ANNEXURE - H

CONTRACT AGREEMENT

CONTRACT NO. :
LETTER OF INTENT NO. :
WORK ORDER NO. :

1. The Contract Agreement entered into the day of, 20... (..... day oftwo thousand and..... ..) at New Delhi between M/S BHARAT HEAVY ELECTRICALS LIMITED, TRANSMISSION BUSINESS GROUP, New Delhi, having its Registered Office at BHEL House, Siri Fort, New Delhi - 110 049 (hereinafter called the FIRST PARTY which expression shall include their executors, administrators, successors and permitted assigns)

AND

M/S (hereinafter called the SECOND PARTY which expression shall include their executors, administrators, successors and permitted assigns).

2. And whereas the FIRST PARTY called for the offer for the work of..... as per approved specifications, drawings and quality plan at as per Tender Specification No....., dated
3. Whereas the SECOND PARTY submitted their offer No. dated against above.
4. Whereas the FIRST PARTY has accepted the offer referred to above & issued Letter of Intent No....., dt..... and also detailed Work Order No..... dt
5. Whereas the SECOND PARTY has agreed to work as Sub-Contractor of the FIRST PARTY on the conditions specified in the Tender Specifications at a contract price of Rs.....(Rupees.....)
6. Now, therefore it is hereby mutually agreed to by and between the parties hereto as under :
 - a) The SECOND PARTY shall execute the works of at on the conditions specified in Tender Specifications of FIRST PARTY and Letter of Intent referred to herein before at a total contract price of Rs..... (Rupees
 - b) That the SECOND PARTY shall organise all activities and mobilisation of facilities so that the work specified herein before is completed byas per the time bound programme mentioned in the Tender Specifications.

BHARAT HEAVY ELECTRICALS LTD.
TRANSMISSION BUSINESS GROUP, NEW DELHI.
Conditions of Contract for Erection Works, Rev-02

- c) That all disputes arising out of or relating to this agreement shall be referred to the sole Arbitrator as per arbitration clause mentioned in the Tender Specifications. The Arbitrator from time to time with the consent of the parties enlarge the time for making and publishing award without reference to the court for the purpose.
 - d) That the jurisdiction in all suits or claims arising out of this agreement shall be of New Delhi Courts only.
 - e) The Following documents shall form part of this agreement :-
 - i)
 - ii)
 - iii)
 - iv)
 - v)
 - vi)
7. Deviation Limit : The contract value is subject to deviations depending upon the actual requirement within plus or minus 30%. Quantities of individual items may vary to any extent or may get deleted.
8. Terms of Payment : The terms of payment applicable to this contract shall be those covered under Point No.... of Work Order dt. and as per Tender Specifications.
9. Abandoning the work : In the event of the SECOND PARTY abandoning the work, FIRST PARTY reserves the right to get the unfinished work done at the risk and cost of the SECOND PARTY.
10. All other terms and conditions shall be as stipulated in the Tender Documents.
11. This contract agreement consists.... pages.

IT WITNESS WHEREOF, the parties have signed this agreement on the date, month and year first above written in presence of:

For and on Behalf of
(FIRST PARTY)

WITNESS (WITH ADDRESS)

For and on Behalf of
(SECOND PARTY)

- 1.
- 2.

BHARAT HEAVY ELECTRICALS LTD.
TRANSMISSION BUSINESS GROUP, NEW DELHI.
Conditions of Contract for Erection Works, Rev-02

ANNEXURE - I

MODEL FORM OF BANK GUARANTEE (FOR SECURITY DEPOSIT)

1.

Please Refer "ANNEXURE TO CONDITIONS OF CONTRACT FOR ETC WORKS"
attached with the tender document

2.

b)

c)

BHARAT HEAVY ELECTRICALS LTD.
TRANSMISSION BUSINESS GROUP, NEW DELHI.
Conditions of Contract for Erection Works, Rev-02

5.

Please Refer "ANNEXURE TO CONDITIONS OF CONTRACT FOR ETC WORKS"
attached with the tender document

6.

7.

NOTE

BHARAT HEAVY ELECTRICALS LTD.
TRANSMISSION BUSINESS GROUP, NEW DELHI.
Conditions of Contract for Erection Works, Rev-02

ANNEXURE - J

PROFORMA FOR PERFORMANCE GUARANTEE
(to be used in appropriate value non - judicial stamp paper)

1. This deed of guarantee made this day of 20... by Bank Limited in favour of Bharat Heavy Electricals Limited, having their registered office at BHEL House, Siri Fort, New Delhi - 110 049.
2. Whereas M/s (hereinafter called the CONTRACTOR / SELLER have entered into a Contract bearing No. dated..... (hereinafter called the CONTRACT) for supply / civil works /erection, testing and commissioning of M/s Bharat Heavy Electricals Limited (hereinafter called the COMPANY).
3. And whereas the said CONTRACT Inter - alia provides that the CONTRACTOR / SELLER shall pay to the COMPANY a sum of Rs. only towards Performance Guarantee in the form and manner therein specified.
4. And whereas the SELLER / CONTRACTOR have approached Bank Limited (hereinafter referred to as the GUARANTOR) and at their request and in consideration of the arrangement arrived at between the CONTRACTOR and the GUARANTOR, the GUARANTOR has agreed to give the Guarantee as hereinafter mentioned in favour of the COMPANY.

NOW THIS DEED WITNESSES AS FOLLOWS:

5. The GUARANTOR by the hand of Mr. and its lawfully and fully constituted attorney and do hereby guarantee the due and faithful performance of the said CONTRACT and do hereby irrevocably undertake and promise to pay the COMPANY without any demur merely on demand made by them a sum not exceeding Rs. only in case the COMPANY sustains any loss or damage by reason of any breach, default by the CONTRACTOR / SELLER of any of the terms, conditions, stipulations or undertakings or any one of them contained in the said CONTRACT and the tender documents attached hereto and for payment of any moneys payable by the CONTRACTOR / SELLER to the COMPANY under the terms and conditions of the said CONTRACT. The decision of the COMPANY regarding the breach, default, loss, damage and payment shall be conclusive and binding in the GUARANTOR, irrespective of the fact whether the CONTRACTOR / SELLER admits or denies such claims or questions its correctness in any court, tribunal or arbitration proceedings or before any other authority.

BHARAT HEAVY ELECTRICALS LTD.
TRANSMISSION BUSINESS GROUP, NEW DELHI.
Conditions of Contract for Erection Works, Rev-02

6. The COMPANY shall have the fullest liberty without effecting in any way the liability of the GUARANTOR under this guarantee, from time to time to vary any of the terms and conditions of the CONTRACT or extend time by the SELLER / CONTRACTOR or to postpone for any time and from time to time any of the powers exercisable by its against the SELLER / CONTRACTOR and either to enforce or forbear from enforcing any of terms and conditions governing the CONTRACT or securities available to the COMPANY and the GUARANTOR shall not be released from its liability under these presents by any exercise by the COMPANY of the liberty with reference to the matters aforesaid or by reason of time being given to the SELLER or any other forbearance, act or omission on the part of the COMPANY or any indulgence by the COMPANY to the SELLER / CONTRACTOR or of any other matter or thing whatsoever which under the law relating to sureties, would but for this provision have the effect of so releasing the GUARANTOR / CONTRACTOR from its liability under this Guarantee.
7. This Guarantee shall remain in full force and effect and the GUARANTOR shall be liable under the same irrespective of any concession or time being granted by the COMPANY to the CONTRACTOR in or for fulfilling the said CONTRACT and this Guarantee shall remain in full force irrespective of any change in terms and conditions, stipulations or any variations in the terms of CONTRACT irrespective of whether notice of such change and / or variation is given to the GUARANTOR or not and the claim to receive such notice of any change and or variation of the terms / or conditions of the CONTRACT is hereby specially waived by the GUARANTOR.
8. The GUARANTEE herein contained shall not be determined, prejudiced or effected by the liquidation or winding up or insolvency of or change in the constitution of the CONTRACTOR but shall in all respects and for all purposes be binding and operative until all payments or all moneys due or that may hereafter become payable to the COMPANY are paid in respect of any liability or obligation of the CONTRACTOR under the CONTRACT.
 - b) The GUARANTOR further agree that the Guarantee herein contained shall remain in full force and effect during the period that would be taken for the commencement of the CONTRACT till end of the CONTRACT and its claim satisfied or discharged and till the COMPANY certified that the terms and conditions of the CONTRACT have been fully and properly carried out by the SELLER and accordingly discharges this guarantee, subject, however, that the COMPANY shall have no claim under this Guarantee after months from the date of completion of the Guarantee has been served on the GUARANTOR before the expiry of the said period in which case the same shall be enforceable against GUARANTOR notwithstanding the fact that the same is enforced after expiry of said period.

BHARAT HEAVY ELECTRICALS LTD.
TRANSMISSION BUSINESS GROUP, NEW DELHI.
Conditions of Contract for Erection Works, Rev-02

The GUARANTOR undertake not to revoke this Guarantee during the period it is in force except with the previous consent of the COMPANY in writing and agree that any liquidation or winding up or insolvency or dissolution or any change in the constitution of the SELLER or the GUARANTOR shall not discharge the GUARANTOR's liability here under.

It shall not be necessary for the COMPANY to proceed against the SELLER before proceeding against the GUARANTOR and the Guarantee herein contained shall be enforceable against them notwithstanding any security which the company may have obtained or obtained from the SELLER shall at the time when proceedings are taken against the GUARANTOR here under be outstanding or unrealized.

The GUARANTOR hereby declares that it has power to execute this Guarantee and the executant has full powers to do so on its behalf under the proper authorities granted to him / them by of the guarantor.

10. Notwithstanding anything herein before contained, our liability under this Guarantee is restricted to Rs. (Rupees only) and will expire on and unless a claim in writing is presented to us or an action or suit to enforce the claim is filed against us, within six months from the date, all our rights shall be forfeited and we shall be relieved and discharged from all our liabilities thereunder.

IN WITNESS whereof the (Bank) have hereunto set and subscribed their hands the day, month and year first above written.

**SIGNED FOR AND ON
BEHALF OF THE BANK**

WITNESS:

NAME AND ADDRESS

SIGNATURE

1.

2.

BHARAT HEAVY ELECTRICALS LTD.
TRANSMISSION BUSINESS GROUP, NEW DELHI.
Conditions of Contract for Erection Works, Rev-02

ANNEXURE - K

**REVISED PRICE OFFER IN LIEU OF WITHDRAWAL OF DEVIATIONS/
CLARIFICATIONS OFFERED BY BHEL DURING TECHNICAL DISCUSSION**

Sl. No.	Clause Ref.	Description of Deviation/ Clarification	Whether Increase/ Decrease in Price	Unit Rate (if applicable)	Total Increase/ Decrease	Remarks

NOTE: Total increase or decrease in total price shall be indicated either in percentage or in value (Rs.).

**(SIGNATURE OF TENDERER)
WITH STAMP**

BHARAT HEAVY ELECTRICALS LTD.
TRANSMISSION BUSINESS GROUP, NEW DELHI.
Conditions of Contract for Erection Works, Rev-02

ANNEXURE -L

(On Bank's Letter Head)

To,
AGM(Finance)
Transmission Business Group,
Block-VI, Central Annexe, IInd Floor,
Bharat Heavy Electricals Ltd.
Bhopal – 462 022

Ref & Date

Sub : Confirmation of Bank Guarantee no. <<BG No.>>

We are a Scheduled Bank other than Co-operative sector Bank under the RBI Act 1934. The aforesaid << BG No.>> for Rs. <<BG Amount>>/ (In Words Also) and valid up to <<validity date>> is issued by us on behalf of M/s << Beneficiary's Name>> in favour of BHARAT HEAVY ELECTRICALS LTD.

The format of the Bank guarantee is strictly as per the format prescribed by M/s BHEL and the stamp papers forming part of the BG are as per the state rules extant.

The signatures to the Bank Guarantee are duly authorised.

Thanking you,

For & On behalf of
Name of the Bank & Seal

(Please Sign here)

BHARAT HEAVY ELECTRICALS LTD.
TRANSMISSION BUSINESS GROUP, NEW DELHI.
Conditions of Contract for Erection Works, Rev-02

SECTION-B

GENERAL TERMS AND **CONDITIONS**

BHARAT HEAVY ELECTRICALS LTD.
TRANSMISSION BUSINESS GROUP, NEW DELHI.
Conditions of Contract for Erection Works, Rev-02

SECTION - B

GENERAL TERMS AND CONDITIONS

- B.1.0 The following terms shall have the meaning hereby assigned to them except where the context requires otherwise:-
- B.1.1 BHEL (or B.H.E. Ltd.) shall mean Bharat Heavy Electricals Limited, a Company registered under Indian Companies Act 1956, with its Registered Office at BHEL House, Siri Fort, New Delhi-110 049 or its Authorised Officers or its Engineer or other Employees authorised to deal with any matters with which these persons are concerned.
- B.1.2 "GENERAL MANAGER" shall mean the Officer in Administrative charge of the Contracting Unit of BHEL.
- B.1.3 "ENGINEER" OR "ENGINEER-IN-CHARGE" shall mean Engineer deputed by BHEL. The term includes "Deputy General Manager, Construction Manager, Resident Engineer, Assistant Site Engineer of BHEL/at the site as well as the officers in charge at Head Office.
- B.1.4 "SITE" shall mean the place or places at which the plants/equipments are to be erected and services are to be performed as per the specification of this tender.
- B.1.5 "CLIENTS OF BHEL" or "CUSTOMER/OWNER" shall mean the organisation to whom BHEL is responsible for this work.
- B.1.6 "CONTRACTOR" or "ETC CONTRACTOR" shall mean the individual, firm or Company who enters into this Contract with BHEL and shall include their executors, administrators, successors and assigns.
- B.1.7 "CONTRACT" or "CONTRACT DOCUMENT" shall mean and include the agreement, the work order, the accepted appendices of rates, Schedules of Quantities, if any, General Terms and Conditions of Contract, Special Conditions of Contract, Instructions to Tenderer, the drawings, the Technical Specifications, the Special Specifications, if any, the tender documents and the Letter of Intent/Accepting Letter issued by BHEL. Any conditions or terms stipulated by the tenderer in the tender documents or subsequent letters shall not form part of the Contract unless specifically accepted in writing by BHEL in the Letter of Intent and incorporated in the Agreement.
- B.1.8 "GENERAL CONDITIONS OR CONTRACT" shall mean the "Instructions and Information for Tenderer and General Terms and Conditions" pertaining to the work detailed.

BHARAT HEAVY ELECTRICALS LTD.
TRANSMISSION BUSINESS GROUP, NEW DELHI.
Conditions of Contract for Erection Works, Rev-02

- B.1.9 "TENDER SPECIFICATIONS" shall mean the Special Conditions, Technical Specifications, Appendices, Site Information and drawings pertaining to the work for which the tenderer are required to submit their offer. Individual Specification Numbers will be assigned to each technical specifications.
- B.1.10 "TENDER DOCUMENTS" shall mean the General Terms and Conditions and Tender Specifications.
- B.1.11 "LETTER OF INTENT" shall mean the intimation by a letter/telegram/telex/ fax to the tenderer that the tender has been accepted in accordance with provisions contained in the letter. The responsibility of the contractor commences from the date of issue of this letter and all the terms and conditions of contract are applicable from this date.
- B.1.12 "COMPLETION TIME" shall mean the period by date specified in the Letter of Intent/Work Order or date mutually agreed upon for handing over of the erected equipment/plant which are found acceptable by the Engineer being of required standard and conforming to the specifications of the contract.
- B.1.13 "ZERO DATE" shall mean the planned commencement date of work under this tender and shall be date of issue of Letter of Intent.
- B.1.14 "PLANT OR PROJECT OR SWITCHYARD" shall mean and connote the entire assembly of the plant and equipments covered by the contract.
- B.1.15 "EQUIPMENT" shall mean all equipments, machineries, materials, structural, electrical and other components of the plant covered by the contract.
- B.1.16 "TESTS" shall mean and include such test or tests to be carried out by the contractor as are prescribed in the contract or considered necessary by BHEL, in order to ascertain the quality, workmanship, performance and efficiency of the contracted work or part thereof.
- B.1.17 "APPROVED" "DIRECTED" or "INSTRUCTED" shall mean approved, directed or instructed by BHEL.

BHARAT HEAVY ELECTRICALS LTD.
TRANSMISSION BUSINESS GROUP, NEW DELHI.
Conditions of Contract for Erection Works, Rev-02

- B.1.18 "WORK OR CONTRACT WORK" shall mean and include supply of all categories of labour, specified consumables, tools and tackles required for complete and satisfactory site transportation, handling, stacking, storing, civil and electrical works, erection, testing & commissioning of the equipment to the entire satisfaction of BHEL.
- B.1.19 "SINGULAR AND PLURAL" etc. words carrying singular number shall also include plural and vice versa, where the context so requires. Words imparting masculine gender shall be taken to include the feminine gender and words imparting persons shall include any Company or Association or Body or Individuals, whether incorporated or not.
- B.1.20 "HEADINGS" The headings in these General Conditions are solely for the purpose of facilitating reference and shall not be deemed to be part thereof or be taken into consideration in the interpretation of construction thereof or the contract.
- B.1.21 "MONTH" shall mean calendar month.
- B.1.22 "WRITING" shall include any manuscript typewritten or printed statement under the signature or seal as the case may be.

B.2.0 LAW GOVERNING THE CONTRACT & COURT JURISDICTION:

The Contract shall be governed by the Law for the time being enforce in the Republic of India. The Civil Court at New Delhi having ordinary Original Civil Jurisdiction shall alone have exclusive jurisdiction in regard to all claims in respect of this contract.

B.3.0 ISSUE OF NOTICE:

The contractor shall furnish to the Engineer, the name, designation and address of his authorised agent and all complaints, notices, communications and references shall be deemed to have been duly given to the Contractor, if delivered to the Contractor or his authorised agent and shall be deemed to have been so given in the case of posting on the day on which they would have reached such address in the ordinary course of post or at which they were so delivered or left.

BHARAT HEAVY ELECTRICALS LTD.
TRANSMISSION BUSINESS GROUP, NEW DELHI.
Conditions of Contract for Erection Works, Rev-02

B.4.0 USE OF LAND:

No land belonging to BHEL or its customer under temporary possessions of BHEL shall be occupied by the contractor without the written permission of BHEL.

B.5.0 COMMENCEMENT OF WORK:

B.5.1 The contractor shall commence the work within fifteen days of Letter of Intent or the time indicated in the Letter of Intent/Work Order and shall proceed with the same with due expedition without delay.

The Contractor shall have to give programme of work in Annexure 'M' to the ENGINEER-IN-CHARGE after mobilisation at site. This will have to be regularly updated / revised so as to meet the Project completion schedule as per requirement of BHEL /Owner.

B.5.2 If the successful tenderer fails to commence the work within the stipulated time, BHEL, at its sole discretion will have the right to cancel the Letter of Intent/Contract. His Earnest Money and/or Security Deposit will stand forfeited without any further reference to him without prejudice to any and all of BHEL's other rights and remedies in this regard.

B.5.3 All the works shall be carried out under the direction and to the satisfaction of BHEL/Customer/Owner.

B.5.4 The transported equipment, erected/constructed plant or work performed under the contract, as the case may be, shall be taken over when it has been completed in all respect and/or satisfactorily put into operation at site.

B.6.0 MEASUREMENT OF WORK AND MODE OF PAYMENT:

B.6.1 All payments due to the contractor shall be made only by "Account Payee Cheques".

B.6.2 For progress/running bill payments, the contractor shall present detailed measurement sheets in duplicate duly indicating all relevant details based on technical documents, protocols & material test reports and connected drawings for the work done during the calendar month/period under different categories in line with terms of payment as per Letter of Intent. The basis of arriving at the quantities/ weights shall be the relevant documents and drawings released by BHEL.

BHARAT HEAVY ELECTRICALS LTD.
TRANSMISSION BUSINESS GROUP, NEW DELHI.
Conditions of Contract for Erection Works, Rev-02

These measurement sheets shall be prepared jointly with Engineer and signed by both parties. Where required, joint measurement with Customer/Owner shall have to be taken.

- B.6.3 The measurement sheets will be checked by the Engineer and quantities and percentage eligible for payment under different groups shall be decided by him. The abstract of quantities and percentage so arrived at based on the terms of payment shall be entered in the Measurement Book & signed by both the parties. Where required counter signature of Customer/Owner shall have to be taken.
- B.6.4 Based on the above quantities, contractor shall prepare the bills in the prescribed proforma and work out the financial value. These will be entered in the Measurement Book and signed by both the parties. Payment shall be made by BHEL after effecting the recoveries due from the Contractor.
- B.6.5 All recoveries due from the contractor for the month/period shall be effected in full from corresponding running bills unless specific approval from Competent Authority is obtained to the contrary.
- B.6.6 Measurement shall be taken jointly by person duly authorised by BHEL and the Contractor.
- B.6.7 The Contractor shall bear the expenditure involved, if any, in taking the measurements and testing of materials to be used in the works. The Contractor shall without extra cost to BHEL, provide all the assistance with appliances and other things necessary for measurement.
- B.6.8 If at any time due to any reason whatsoever, it becomes necessary to remeasure the work done, in full or in part, the expenses towards such re-measurement shall be borne by contractor.
- B.6.9 Passing of bills covered by such measurement does not amount to acceptance by BHEL of the completion of the work measured. Any left out work has to be completed by the Contractor, as directed by BHEL.
- B.6.10 Final measurement bill shall be prepared in the proforma prescribed for the purpose, based on the certificate issued by the Engineer that the entire work as stipulated in the tender specification has been completed in all respects to the entire satisfaction of BHEL.

BHARAT HEAVY ELECTRICALS LTD.
TRANSMISSION BUSINESS GROUP, NEW DELHI.
Conditions of Contract for Erection Works, Rev-02

The contractor shall give unqualified "No claim" and "No Demand" certificates. All the tools and tackles loaned to him should be returned in condition satisfactory to BHEL. The abstract of final quantities and financial values shall also be entered in the Measurement Book and signed by both the parties. The final bill shall be paid after completion of all the defects/deficiencies etc. pointed out by BHEL. The contractor should submit all the original documents such as material consumption, site order book etc. maintained at site. After payment of final bill only guarantee obligation, percentage value shall remain unpaid which shall be released in accordance with Clause A.15.0.

B.7.0 RIGHTS OF BHEL:

B.7.1 Please Refer "ANNEXURE TO CONDITIONS OF CONTRACT FOR ETC WORKS"
attached with the tender document

B.7.2

B.7.3

BHARAT HEAVY ELECTRICALS LTD.
TRANSMISSION BUSINESS GROUP, NEW DELHI.
Conditions of Contract for Erection Works, Rev-02

B.7.4

B.7.5 Please Refer "ANNEXURE TO CONDITIONS OF CONTRACT FOR ETC WORKS"
attached with the tender document

B.7.6

B.7.7

B.7.8

BHARAT HEAVY ELECTRICALS LTD.
TRANSMISSION BUSINESS GROUP, NEW DELHI.
Conditions of Contract for Erection Works, Rev-02

B.7.9

Please Refer "ANNEXURE TO CONDITIONS OF CONTRACT FOR ETC WORKS"
attached with the tender document

B.7.10

B.7.11

B.8.0 RESPONSIBILITY OF THE CONTRACTOR IN RESPECT OF LOCAL LAWS, EMPLOYMENT OF WORKERS ETC:

The following are the responsibilities of the Contractor in respect of observance of local laws, employment of personnel, payment of taxes etc.

- B.8.1 As far as possible, unskilled workers shall be engaged from the local areas in which the work is being executed. In case of any necessity is felt by the contractor to bring labourers from out side State, provisions of law governing such immigration by the concerned State are to be followed.
- B.8.2 The Contractor at all times during the currency of this contract, shall in all his dealings with the local labour for the time being employed on or in connection with the work, have due regard to all local festivals, religious and other customs.
- B.8.3 The contractor shall comply with all State and Central Laws, Statutory Rules, Regulations etc., such as : The payment of wages to, The Minimum Wages Act, The Workmen Compensation Act, The Employees Liability Act, The Industrial Dispute Act, The Employees Provident Fund and Miscellaneous Provisions Act 1952, Employees State Insurance Scheme, The Contract Labour (Regulations & Abolition) Act 1970 and other Acts, Rules and Regulations for labour as may be enacted by the Government during the tenure of the contract and having in force or jurisdiction at site. The Contractor shall give to the local Governing Body, Police and other concerned Authorities all such notice as may be required under law.

The contractor should have Provident Fund Code Number and shall ensure compliance of the EPF & MP Act, 1952 by the sub-contractors, if any engaged by the contractor for the said work,

BHARAT HEAVY ELECTRICALS LTD.
TRANSMISSION BUSINESS GROUP, NEW DELHI.
Conditions of Contract for Erection Works, Rev-02

- B.8.4 The contractor, as required, will obtain independent license under the Contract Labour (Regulations and Abolition) Act 1970 from the concerned authorities based on the certificate (Form-V) issued by the Principal Employer/Customer.
- B.8.5 The Contractor shall pay all taxes, fees, license charges, deposits, duties, tolls, royalty, commissions or other charges which may be Leviable on account of any of his operations connected with this contract. The Contractor is responsible to furnish documentary evidence towards GST Registration of the State wherein the site is located and any other documents as per GST Act which may be required from time to time by BHEL. The contractor should have to get the contract registered immediately after award of works as per rules and regulations of the State Government. The contractor will file regular return as per statute of the State/ Centre and provide all information to BHEL as required for the assessment of the project concerned . In case BHEL is forced to make any of such payments, BHEL shall recover the same from the contractor either from moneys due to him or otherwise as deemed fit.
- B.8.6 Arrangements for the periodical visits of inspection agencies such as Electrical Inspector etc. to site, inspection certificates etc. will have to be made by the contractor at his cost. The contractor will also meet all expenses in connection with his welder's qualification/ re-qualification tests etc.
- B.8.7 The contractor shall be responsible for provision of health and sanitary arrangements {more particularly described in the Contract Labour (Regulation & Abolition) Act 1970} and safety precautions as may be required for safe and satisfactory execution of the contract.
- B.8.8 The Contractor shall be responsible for proper accommodation including adequate medical facilities for the personnel employed by him.
- B.8.9 The Contractor shall be responsible for the proper behaviour and observance of all regulations by the staff employed by him.
- B.8.10 The contractor shall ensure that no damage is caused to any person/property of other parties working at site. If any such damage is caused, it shall be the responsibility of the contractor to make good the losses or compensate them.

BHARAT HEAVY ELECTRICALS LTD.
TRANSMISSION BUSINESS GROUP, NEW DELHI.
Conditions of Contract for Erection Works, Rev-02

- B.8.11 All the properties/equipment/components of BHEL/its customer loaned with or without deposit, to the contractor, shall remain the properties of BHEL/its customer. The contractor shall use such properties for the purpose of execution of this contract. All such properties/equipment/components shall be taken to in good condition unless notified to the contrary by the contractor within 48 Hrs. The Contractor shall return them in good conditions as and when required by BHEL/its customer. In case of non-return, loss, damage repairs etc., the cost thereof, as may be fixed by the Engineer, will be recovered from the contractor.
- B.8.12 It shall not be obligatory on the part of BHEL to supply any tools and tackles or materials other than those specifically agreed to be given by BHEL. However, depending upon availability/possibility, BHEL/its customer's equipment and other materials may be made available to the contractor on payment of the hire charges as fixed by them, subject to the conditions laid down by BHEL/its Customer from time to time. Unless paid in advance, such hire and other charges shall be recovered from out of dues to the contractor or Security Deposit in one instalment.
- B.8.13 The Contractor shall fully indemnify and keep indemnified BHEL/its customer against all claims of whatsoever nature arising during the course of execution of this contract.
- B.8.14 In case the contractor is required to undertake any work outside the scope of this contract, the amount payable shall be as may be mutually agreed upon.
- B.8.15 Any delay in completion of works or non-achievement of periodical targets, due to reasons attributable to the contractor, will have to be compensated by the contractor either by increased manpower and resources or by working extra hours or more than one shift at no extra cost to BHEL.
- B.8.16 The contractor shall execute the work under the conditions usual to such construction work and in conjunction with numerous other operations at site and proceed in a manner that shall help in the progress of work at site as a whole.
- B.8.17 The contractor will be directly responsible for payment of wages to his workmen. A pay roll sheet giving details of all payments made to the workmen duly signed by the contractor's representative should be furnished to BHEL, along with each Running Account Bill. Also, Contractor shall display wages paid by him as per The Minimum Wages Act.

BHARAT HEAVY ELECTRICALS LTD.
TRANSMISSION BUSINESS GROUP, NEW DELHI.
Conditions of Contract for Erection Works, Rev-02

- B.8.18 In case of any class of work for which there is no specification laid down in the contract, such work shall be carried out in accordance with the instructions and requirements of the Engineer.
- B.8.19 No levy, payment or charges made or imposed shall be impeached by reason of any clerical error or by reason of any mistake in the amount levied, demanded or charged.
- B.8.20 No idle labour charges will be admissible in the event of any stoppage of work resulting in the contractor's workmen being rendered idle due to any reason any time.
- B.8.21 The contractor shall take all reasonable care to protect the materials and the work till such time the place/equipment has been taken over by BHEL/its customer.
- B.8.22 The contractor shall not stop work or abandon the site for whatsoever reason or dispute, excepting for force majeure conditions. All problems/disputes shall be separately discussed and settled without effecting the progress of work. Stoppage or abandonment of work, other than under force majeure conditions, shall be treated as breach of work of contract and dealt with accordingly.
- B.8.23 The contractor shall keep the area of work clean and shall remove debris etc. while executing day-to-day work. Upon completion of work, the contractor shall remove from the vicinity of works, all scrap, packing materials, rubbish, unused and other materials and deposit them in places specified by the Engineer. The contractor will also demolish all the hutments, sheds, offices etc. constructed and used by him and shall clean the debris. In the event of his failure to do so, the same will be arranged to be done by the Engineer and the expenses recovered from the contractor.
- B.8.24 The contractor shall execute the work in the most substantial and workman like manner in the stipulated time. Accuracy of work and timely execution shall be the essence of this contract. The contractor shall be responsible to ensure that the quality, assembly and workmanship conform to the dimensions and clearance given in the drawings and/or as per instructions of the Engineers.
- B.8.25 The contractor shall furnish progress reports on work at regular intervals as required by the Engineer.

**BHARAT HEAVY ELECTRICALS LTD.
TRANSMISSION BUSINESS GROUP, NEW DELHI.**

Conditions of Contract for Erection Works, Rev-02

B.9.0 RESPONSIBILITIES OF CONTRACTOR IN RESPECT OF SAFETY OF MEN, EQUIPMENT, MATERIAL & ENVIRONMENT:

- B.9.1 All safety rules and codes applied by BHEL/its customer at site shall be observed by the contractor and his workmen without exception. The contractor shall be responsible for the safety of the equipment/materials and work to be performed by him and shall maintain all lights, fencing guards, signs etc. or other protections necessary for the purpose. Contractor shall also take such additional precautions as may be indicated from time to time by the Engineer, with a view to prevent pilferage, accidents, fire hazards etc. and suitable number of clerical staff, watch and ward, store keepers to take care of equipment, materials and construction tools and tackles shall be posted at site by the contractor till the completion of the work under this contract. The contractor shall arrange for such safety devices as are necessary for this type of work and carry out the requisite site tests of handling equipment, lifting tools, tackles etc. as per usual standards and practices.
- B.9.2 The contractor shall provide to its work force and ensure the use of required personal protective equipment as found necessary & as directed by the authorised BHEL officials in line with latest Amendments / Revisions of various Indian Standards.
- i) Safety helmets conforming to IS-2925 : 1984.
 - ii) Safety belts conforming to IS-3521 : 1983.
 - iii) Safety shoes conforming to IS-1989 : 1978.
 - iv) Eye and face protection devices conforming to IS-8520 : 1977 and IS-8940 : 1978.
 - v) Hand and body protection devices conforming to IS-2573 : 1975, IS-6994 : 1973, IS-8807 : 1978 and IS-8519 : 1977.
- B.9.3 All tools, tackles, fitting appliances, material handling equipment, scaffolds, cradles, safety nets, ladders, equipment, etc. used by the contractor (as per Annexure 'N') shall be of safe design and construction and maintained in good condition. However BHEL officials shall have the right to ban use of any of them or get them tested at their discretion.

All test & measuring instruments to be pre-calibrated through certifying agency before use. Also, please see. Cl. E.4.2 & E.6.3 of section - E for more details.

**BHARAT HEAVY ELECTRICALS LTD.
TRANSMISSION BUSINESS GROUP, NEW DELHI.**

Conditions of Contract for Erection Works, Rev-02

All electrical equipment, connections and wiring for construction power, its distribution and use shall conform to the relevant requirements of Indian Electricity Act and Rules. Only electricians licensed by the appropriate statutory authority shall be employed by the contractor to carry out electrical works.

- B.9.4 All electrical appliances including portable electric tools used by contractor shall have safe plugging system to source of power and be appropriately earthed.
- B.9.5 The contractor shall not use any hand lamp energised by electric power with supply voltage of more than 240 volts. For work in confined spaces, lighting shall be arranged with power source of not more than 240 volts.
- B.9.6 Where it becomes necessary to provide and/or store petroleum products, explosives, chemicals and liquid or gaseous fuel or any other substance that may cause fire or explosion, the contractor shall be responsible for carrying out such provision and/or storage in accordance with the rules and regulations laid down in the relevant Government Acts, such as Petroleum Act, Explosive Act, Petroleum and Carbides of Calcium Manual of the Chief Controller of Explosives, Government of India etc. Prior approval of the authorised BHEL official at the site shall also be taken by the contractor in all such matters.
- B.9.7 The contractor shall arrange at his cost appropriate illumination as required at all work spots for safe working, when natural day light may not be adequate for clear visibility.
- B.9.8 In case of a fatal or disabling injury/accident to any person at construction sites pertaining to this work, the victim and/or his/her dependents shall be compensated by the contractor as per statutory requirements. However, if considered necessary, BHEL shall have the right to impose appropriate financial penalty on the contractor & recover the same from payments due to the contractor for suitably compensating the victim and/or his/her dependents. Before imposing any such penalty, appropriate enquiry shall be held by BHEL giving opportunity to the contractor to present his case.
- B.9.9 In case of any damage to property due to lapse by the contractor, BHEL shall have the right to recover the cost of such damages from the payments due to the contractor.
- B.9.10 In case of any delay in the completion of a job due to mishaps attributable to lapses by the contractor, BHEL shall have the right to recover cost of such delay

**BHARAT HEAVY ELECTRICALS LTD.
TRANSMISSION BUSINESS GROUP, NEW DELHI.**

Conditions of Contract for Erection Works, Rev-02

from the payments due to the contractor, after notifying the contractor suitably and giving him opportunity to present his case.

- B.9.11 If contractor fails to improve the standards of safety in its operation to the satisfaction of BHEL after being given reasonable opportunity to do so and/or if the contractor fails to take appropriate safety precautions or to provide necessary safety devices and equipment or to carry out instructions regarding safety issued by the authorised BHEL official, BHEL shall have the right to take the corrective steps at the risk and cost of the contractor after giving appropriate notice indicating the steps that would be taken by BHEL.
- B.9.12 The contractor shall submit report of all accidents, fires, property damaged & dangerous occurrences connected with his area of work or caused due to his action/ inaction, to the authorised BHEL official immediately after such occurrence, but in any case not later than 12 hours of the occurrence.
- B.9.13 During the course of construction, alteration or repairs scrap lumbars with protruding nails, sharp edges etc. and all other debris including combustibles scrap shall be kept cleared from working areas, passage ways and stairs in and around site.
- B.9.14 Cylinders shall be moved by tilting and rolling them on their bottom edges. They shall not be intentionally/ negligently dropped, struck or permitted to strike each other violently. When cylinders are transported by powered vehicles, they shall be secured in a vertical position.
- B.9.15 The contractor shall be responsible for the safe storage of his radioactive sources if same have been permitted to use.
- B.9.16 All contractor's supervisory personnel and sufficient number of workmen shall be trained for fire fighting and first aid duties and shall be assigned specific duties. Enough number of such trained personnel must be available during the tenure of the contract.

**BHARAT HEAVY ELECTRICALS LTD.
TRANSMISSION BUSINESS GROUP, NEW DELHI.**

Conditions of Contract for Erection Works, Rev-02

- B.9.17 Contractor shall provide enough fire protecting equipment of the types & numbers at his office, stores, construction/erection site, other temporary structures, labour colony area etc. Access to such fire protection equipment shall be easy and kept open at all times. Compliance of the above requirement under fire protection system at project site shall in no way relieve the contractor of any of his responsibilities & liabilities to fire accident occurring. In the event of fire safety measures being not to BHEL's satisfaction, BHEL shall have option to provide the same and recover the cost plus incidentals from contractor's bills and/or impose penalty as deemed fit by the Engineer.
- B.9.18 Before commencing the work, the contractor shall appoint/nominate a responsible officer to supervise implementation of all safety measures and liaison with BHEL Engineer at site.
- B.9.19 If safety record of the contractor in execution of the awarded job is to the satisfaction of Safety Department of BHEL, issue of an appropriate certificate to recognise the safety performance of the contractor may be considered by BHEL after completion of the job.
- B.10.0 **CONSEQUENCES OF CANCELLATION:**
- B.10.1 Whenever BHEL exercises its authority to terminate the contract/withdraw a portion of work, the work may be got completed by any other means at the contractor's risk and cost provided that in the event of the cost of completion (as certified by the Engineer which shall be final and binding on the contractor) being less than the contract value, the advantage shall accrue to BHEL. If the cost of completion exceeds the money due to the Contractor under the Contract, the Contractor shall either pay the excess amount demanded by BHEL or the same shall be recovered from the contractor. This will be in addition to the forfeiture of Security Deposit and recovery of liquidated damages as per relevant clauses.
- B.10.2 In case BHEL completes the work under the provisions of this clause, the cost of such completion to be taken into account for determining the excess cost to be charged to the contractor shall consist of cost of materials purchased and/or labour provided by BHEL with an addition of such percentage to cover supervision and establishment charges as may be decided by BHEL.

BHARAT HEAVY ELECTRICALS LTD.
TRANSMISSION BUSINESS GROUP, NEW DELHI.
Conditions of Contract for Erection Works, Rev-02

B.11.0 INSURANCE:

- B.11.1 BHEL/its customer shall arrange for insuring the project materials/properties of BHEL/its customer covering the risks during transit, storage, construction, erection and commissioning.
- B.11.2 It shall be the sole responsibility of the Contractor to insure his workmen against risks of accident and injury while at work as required by the relevant rules and to pay compensation, if any, to them as per Workmen's Compensation Act. The Contractor shall also insure his staff against accidents. The work will be carried out in a protected area and all the rules and regulations of BHEL/its client in the project area which are in force from time to time will have to be followed by the contractor.
- B.11.3 If due to negligence and/or non-observance of safety and other precautions any accident/injury occurs to any other person/public, the contractor shall pay necessary compensation and other expenses, if so decided by the appropriate authority.
- B.11.4 It shall be the responsibility of the contractor to provide security and insurance claim related information/reports, FIRs etc. for the equipment/material belonging to BHEL/its customer and handed over to the contractor for transportation/erection/ construction till these are taken over by BHEL after erection/construction or are returned to BHEL/its customer's store.
- B.11.5 If due to Contractor's carelessness, negligence, non-observance of safety precautions, improper security arrangements or due to non-compliance of paper work needed for lodging insurance claim, damage to BHEL/its Customer's property and/or personnel should occur, and if BHEL is unable to recover its claim from the Insurance Company, the deficit will be recovered from the Contractor. **All losses arising out of theft of material from the contractor's store/erection site shall be recovered from the contractor irrespective of the insurance claims.**

B.12.0 STRIKES & LOCKOUTS:

- B.12.1 The Contractor will be solely responsible for all disputes & other issues connected with his workmen. In the event of the contractor's workmen resorting to strike or the contractor resorting to lockout and if the strike or the lockout so declared is not settled within a period of one month, BHEL shall have the right to get the work executed by employing its own men or through other agencies or both. The cost incurred by BHEL in this regard shall be recovered from the Contractor.

BHARAT HEAVY ELECTRICALS LTD.
TRANSMISSION BUSINESS GROUP, NEW DELHI.
Conditions of Contract for Erection Works, Rev-02

B.12.2 For any purpose whatsoever, the employees of the contractor shall not be deemed to be in the employment of BHEL/its Customer.

B.13.0 FORCE MAJEURE:

B.13.1 The following shall amount to force majeure conditions:-

Acts of God, Act of any Government, war, Sabotage, riots, civil Commotion, Police Action, Revolution, Flood, Fire Cyclone, Earthquake, Epidemic and other similar causes over which the contractor has no control.

B.13.2 If the contractor suffers delay in the due execution of the contract, due to delays caused by force majeure conditions, as defined above, the agreed time of completion of the work covered by this contract may be extended by a reasonable period of time in consultation and after agreement of BHEL's clients / owner, provided that on the occurrence of any such contingency, the Contractor immediately reports to BHEL in writing the causes of delay. The Contractor shall not be eligible for any compensation on this account.

B.14.0 GUARANTEE:

B.14.1 Even though the work will be carried under the supervision of BHEL Engineers, the contractor will be responsible for the quality of the workmanship and shall guarantee the work done for a period of 12 months from the date of putting the complete system into commercial operation or 18 months from the date of system is declared completely erected duly tested and accepted by customer whichever is later and shall rectify free of cost all defects due to faulty erection detected during the guarantee period starting from the date of the completion of rectification. In the event of the contractor failing to repair the defective works within the time specified by the Engineer, BHEL may proceed to undertake the repairs of such defective works at the contractor's risk and expense without prejudice to any other rights and recover the same from Security Deposit/other dues.

BHARAT HEAVY ELECTRICALS LTD.
TRANSMISSION BUSINESS GROUP, NEW DELHI.
Conditions of Contract for Erection Works, Rev-02

B.15.0 **ARBITRATION:**

B.15.1

Please refer " Annexure to conditions of contract for ETC Work" attached with the tender documents.

BHARAT HEAVY ELECTRICALS LTD.
TRANSMISSION BUSINESS GROUP, NEW DELHI.
Conditions of Contract for Erection Works, Rev-02

Please refer " Annexure to conditions of contract for ETC Work" attached with the tender documents.

NOTE:

Above clause No. B.15.0 stands deleted. Please refer Annexure to conditions of contract for ETC works.

B.16.0 VARIATIONS AND VALUATIONS:

B.16.1 QUANTITIES:

The quantities set out in the Bill of Quantities are the estimated quantities of the work but they are not to be taken as the actual and correct quantities of the works to be executed by the Contractor in fulfilment of his obligations under the Contract.

B.16.2 VARIATIONS:

B.16.2.1 The Engineer shall have power to make any variation of the form, quantity of the Works or any part thereof that may in his opinion be necessary and for that purpose or if for any other reason it shall in his opinion be desirable shall have power to order the Contractor to do and Contractor shall do any of the following:-

BHARAT HEAVY ELECTRICALS LTD.
TRANSMISSION BUSINESS GROUP, NEW DELHI.
Conditions of Contract for Erection Works, Rev-02

- a) Increase or decrease the quantity of any work included in the contract.
- b) Omit any such work.
- c) Change the character or quality or kind of any such work.
- d) Execute additional work of any kind necessary for the completion of the works and no such variation shall in any way vitiate or invalidate the contract but the value (if any) of all such variation shall be taken into account in ascertaining the amount of the Contract Price.
- e) Restrict the extent of work of any item covered under Clause E.10.0 of Section - E "Schedule of Equipment".

B.16.2.2 Orders for Variations to be in writing. No such variation shall be made by the contractor without an order in writing of the Engineer provided that, no order in writing shall be required for increase or decrease in the quantity of any work where such increase or decrease is not the result of an order given under this clause but is the result of the quantities exceed in for being less than those stated in the Bill of Quantities. Provided also that if for any reason the Engineer shall consider it desirable to give any such order verbally the Contractor shall comply with such order and any confirmation in writing of such verbal order given by the Engineer whether before or after the carrying out of the order shall be deemed to be an order in writing within the meaning of this clause. Provided further that if the contractor shall confirm in writing to the Engineer any verbal order of the Engineer and such confirmation shall not be contradicted in writing by the Engineer, it shall be deemed to be an order in writing by the Engineer.

B.16.3 VALUATION OF VARIATIONS:

The Engineer shall determine the amount (if any) which in his opinion should be added to or deducted from the sum named in the Contract in respect of any extra or additional work done or work omitted by his order. All such work shall be valued at the rates set out in the Contract if in the opinion of the Engineer the same shall be applicable. If the contract shall not contain any rates applicable to the extra or additional work then suitable prices shall be derived from the nearest item of BOQ or arrived at from the actual cost of manpower utilised (the cost of T&P and testing equipment etc. are not to be taken into account for arriving at the rates of additional/extra works) plus 10% for contractor's OH and profit. The rates for manpower shall be as per the minimum wages applicable for the project area.

Above clause No.B.16.3 shall be read in conjunction with clause No.1.of of Annexure to conditions of contract for ETC works.

BHARAT HEAVY ELECTRICALS LTD.
TRANSMISSION BUSINESS GROUP, NEW DELHI.
Conditions of Contract for Erection Works, Rev-02

B.16.4 POWER OF ENGINEER TO FIX RATES:

If the nature or amount of any omission or addition relative to the nature or amount of the whole of the contract work or to any part thereof shall be such that in the opinion of the Engineer the rate or price contained in the Contract for any item of the Work is by reason of such omission or addition rendered unreasonable or inapplicable then a suitable rate or price shall be agreed upon between the Engineer and the Contractor. In the event of disagreement the Engineer shall fix such other rate of price as shall in his opinion be reasonable and proper having regard to the circumstances and the same shall be binding on the contractor. But under no circumstance the contractor shall suspend the work on the plea of non-settlement of rates falling under the clause or claim any compensation on that account.

BHARAT HEAVY ELECTRICALS LTD.
TRANSMISSION BUSINESS GROUP, NEW DELHI.
Conditions of Contract for Erection Works, Rev-02

ANNEXURE - M

PROGRAMME OF WORK

SL.NO.	ACTIVITY	DURAION
01.	Award of work.	Zero week
02.	Mobilisation & setting up of site office weeks
03.	Start / finish of structure erection weeks
04.	Start / finish of stringing of shielding wire and conductors weeks
05.	Start / finish of Circuit Breaker erection weeks
06.	Start / finish of other equipment erection weeks
07.	Start / finish of testing and precommissioning weeks
08.	Start / finish of commissioning weeks
09.	Final Handing over weeks

**(SIGNATURE OF TENDERER)
WITH STAMP**

BHARAT HEAVY ELECTRICALS LTD.
TRANSMISSION BUSINESS GROUP, NEW DELHI.
Conditions of Contract for Erection Works, Rev-02

ANNEXURE - N

LIST OF TEST EQUIPMENTS TO BE ARRANGED BY ETC CONTRACTOR

All measuring and testing instrument shall be pre-calibrated through a certifying agency before use. The certificate of calibration shall be submitted to BHEL Site Engineer for records. Also see clause E.4.2 & E.6.3 under Section E of the tender specification for more details.

<u>A -</u>	<u>General purpose</u>	<u>Qty.</u>
1.	Digital multimeter - 4½ digits Accuracy ± 1% (Any reputed make - preferably Fluke - make)	4 Nos.
2.	Megger 2.5 kV - 5kV, range 0.5 MΩ - 10,000 MΩ (Motorised/Electronic) (Any reputed make)	1 No.
3.	Megger having voltage multiplier 0-500V- 1000V, (Motorised / Electronic) Range 0.5 MΩ - 1000 MΩ (Any reputed make)	1 No.
4.	Single phase variac 8 A, 0.-250V, 50 HZ	2 No
5.	Three phase variac 15A, 0-440V, 50 HZ	1 No
6.	Single phase transformer 220V / 4000V, 500VA, 50HZ	1No
7.	Stop watch	1No
8.	Micro- ohm- meter (mV drop test kit) 0-200ADC, 0-2000 micro ohm with suitable calibrated cable leads for current injection and mV drop.	1 No
9.	Phase sequence meter	1 No
10.	Two way intercom set with 50 to 100 M cables for checking of cable continuity	2 sets
11.	Walkie - Talkie sets with battery charging sets Receiver + Transmitter, Type GP 300 - Motorola - make	1 set
12.	Variable D.C. power supply 0-220VDC, 10 A	2 Nos
13.	4 pole Miniature moulded case breaker 16 A	3 No
14.	Capacitance meter having range 20 PF- 100mfd ± 1%	1 No
15.	Isolation Transformer 1KVA, 240V AC, 1 phase, 50Hz	2 Nos

BHARAT HEAVY ELECTRICALS LTD.
TRANSMISSION BUSINESS GROUP, NEW DELHI.
Conditions of Contract for Erection Works, Rev-02

B **For testing of current transformer**

- | | | |
|----|---|--------|
| 1. | Primary injection test kit, range 0-2000A with a pair of leads & C clamps for testing of CT's | 1 No |
| 2. | Secondary injection test kit suitable for 5A& 1A with banana plug cable leads. | 1 No |
| 3. | Digital Tongue tester 0-2000A, 600VAC, 50 Hz (Any reputed make). | 1 No |
| 4. | Digital Tongue tester 0-20A, 600V AC, 50 Hz (Any reputed make). | 1 No |
| 5. | Digital Tongue Tester, 0-1A, 600V AC, 50Hz | 2 Nos. |

C - **For testing of oil cooled transformer and AC reactor**

- | | | |
|----|--|------|
| 1. | Transformer winding resistance meter or Kelvin's double bridge | 1 No |
| 2. | Transformer turns ratio meter | 1 No |
| 3. | PPM tester for transformer oil | 1 No |
| 4. | BDV tester for transformer oil | 1 No |

D **For testing of relays**

- | | |
|--|------|
| Single phase / 3 phase relay test kit having timer current source 5A, 1A, voltage source 0-220VDC, 0-110 VAC 50 HZ. (Any reputed make) | 1set |
|--|------|

E- **For time measurement of breaker**

- | | |
|--|------|
| Breaker closing and / opening time measurement timer | 1 No |
|--|------|

F **For testing of relays and distance protection**

- | | | |
|----|---|-------|
| 1. | CFB kit or equivalent - of any reputed make | 1 Set |
| 2. | ZFB kit or equivalent - of any reputed make | |

BHARAT HEAVY ELECTRICALS LTD.
TRANSMISSION BUSINESS GROUP, NEW DELHI.
Conditions of Contract for Erection Works, Rev-02

ANNEXURE - P

ACTIVITIES FOR TESTING AND COMMISSIONING BY ETC CONTRACTOR

1. Preparation of joint inspection records / observation by BHEL, BHEL customer and the contractor on the pending activities of erection holding for starting of testing and commissioning.
2. Issue of certificate for completion of erection activities to the satisfaction of BHEL customer.
3. Compilation of documents (scheme, cable schedules, FQP, technical literature, operation and maintenance manuals, technical reports, works test certificate for the equipments / components, and other relevant documents to expedite commissioning) in a systematic manner to present to customer/owner to meet the contractual requirement.
4. To expedite the testing activities contractor has to arrange the engineers and his staff and instruments at site for testing and commissioning of switchyard equipments as follows:
 - 4.1 Testing of individual relay, energy meter, transducer and meters for their satisfactory operation.
 - 4.2 Protection devices / relays will be tested with appropriate current and voltage injections.
 - 4.3 Individual control and protection panels testing for their satisfactory operation as per scheme.
 - 4.4 Individual CT, PT, CVT, Breaker, Transformer and Isolator LA, MB, Battery Charger etc. where ever possible to test them independently.
 - 4.5 Wiring check as per scheme and cable schedule preferably in the following sequences:
 - Between marshalling Kiosk in the yard to other yard equipments.
 - Between equipments in the yard.
 - Yard equipments to control room equipments.
 - Inter connection between control room equipments.
5. All cables to be properly glanded, identified and terminated suitably.
6. Cables should have proper / accurate cross reference ferruling and necessary cable tags for identifications as per recommendation by BHEL/ Customer.
7. Green marking in cable schedule and scheme after wiring check. Contractor to make also "As Built" scheme and cable schedule for submission to BHEL/Customer.
8. List of wiring mistakes, component damage and mal-operation of components.

BHARAT HEAVY ELECTRICALS LTD.
TRANSMISSION BUSINESS GROUP, NEW DELHI.
Conditions of Contract for Erection Works, Rev-02

9. Successful completion of equipment level testing operative from local and remote and desired FQP filled up and approved by ultimate customer. Approval/acceptance on FQP results by customer has to be obtained by Contractor. For any technical clarifications, BHEL will only assist.
10. In case the contractor is finding difficulty to understand the technicalities to undertake testing and commissioning of a particular equipment, subsystem and system he has to inform BHEL in advance with in 2 months from the date of award of contract for necessary information and explanation.
11. For erection/commissioning of SF6 Circuit Breakers (If called for in BOQ), the services of experts +for supervision will be extended by BHEL free of cost. Contractor will provide adequate support by providing skilled manpower and tools & tackles. However the complete responsibility for erection and commissioning lies with subcontractor.
12. Contractor has to keep a senior and experienced person in the area of testing and commissioning associated with his skilled staff till charging and handing over of complete switchyard to the satisfaction of BHEL customer.
13. Contractor has to be well equipped at site with testing instruments and safety measures (like helmet and hand globes) while doing testing and commissioning.
14. Contractor will also carry out design validation tests as per BHEL / BHEL customer documents.
15. If the contractor fails to take up testing and commissioning work as per the requirement of contract or project requirement, then BHEL will be at liberty to hire services of third agency for this work at the risk and cost of subcontractor.
16. Testing of mandatory spares or any other spare (if required by customer / BHEL), cleaning and handing over to customer's stores is also included in the scope of this Tender Specification. The site Test Reports of these mandatory spares will also be generated by subcontractor in such a case.
17. In case contractor fails to arrange Test equipments as referred in Annexure 'N' (as per requirement of equipment covered in BOQ), BHEL will arrange the instruments at the risk and cost of contractor for providing such instruments.
18. Contractor has to repeat any tests free of cost, even if already conducted, whenever required to prove and check the healthiness of system before power flow, such tests could be primary injection and secondary injection in CT, CVT, meggering, and functional tests or any other tests as required by BHEL/customer.

**BHARAT HEAVY ELECTRICALS LTD.
TRANSMISSION BUSINESS GROUP, NEW DELHI.**

Conditions of Contract for Erection Works, Rev-02

19. Oil processing/filtering in a transformer, CT and CVT shall also be repeated free of cost if required before charging and handing over of the switchyard to the owner in case BDV and PPM of oil is not satisfactory.
20. As isolator is a rotating equipment and its alignment is likely to get disturbed. Therefore contractor has to do alignment of isolators and measurement of contact resistance repeatedly free of cost as and when required till handing over of the station.
21. Commissioning means charging of total system in a sub-station and inter connected equipments by power flow. Accordingly the payment will be made to the contractor as per payment terms.
22. Contractor has to deploy adequate and experienced man power at site as per project requirement and advice of BHEL site in-charge. Non compliance of this requirement will be treated as indiscipline and non cooperation of the contractor. Accordingly BHEL will hire the man power as required at the risk and cost of the contractor after giving a single notice.
23. Based on site requirement, for the works not stipulated in the contract, the contractor has to provide assistance of skilled manpower with required tools and test instruments.
24. If any Expert services of manufacturer for commissioning supervision of special protection relays / numerical relays / equipment is felt necessary by the contractor, the same shall be arranged by the contractor themselves at their cost. Contractor shall provide testing & Commissioning, Engineer, electrician, other tools tackles and consumables for these equipments and for total system.

Any delay in arranging special testing & commissioning equipment and expert supervisor shall not entitle the contractor to any claim (idle labour, additional time etc.) whatsoever.
25. Any idle days of the expert supervisor at site due to reasons attributable to the contractor, due to lack of readiness in erection, delay in arranging of manpower, tools etc. shall be to contractor's account.

NOTES :-

- (1) Above is only an indicative list. Contractor has to mobilise and keep adequate competent commissioning staff at site to ensure that all mile stones & events and relevant commissioning activities are completed successfully in a scheduled time.
- (2) In case contractor is not finding competent and adequate staff with him, he can hire the commissioning services from out side agencies approved and accepted by BHEL. Contractor will furnish the details (experience, qualification) of all commissioning staff and the commissioning tools and instruments available with the contractor OR obtained on loan basis with in 60 days from the date of award of the work.

BHARAT HEAVY ELECTRICALS LTD.
TRANSMISSION BUSINESS GROUP, NEW DELHI.
Conditions of Contract for Erection Works, Rev-02

ANNEXURE - Q

LIST OF TOOLS & TACKLES TO BE ARRANGED BY CONTRACTOR

<u>Sl. No.</u>	<u>PARTICULARS</u>
01.	Electrical Drilling Machine & Hand drilling Machine.
02.	Hydraulic Bending Machine for Al. pipes.
03.	Gas Welding Set & Gas Cutting Set.
04.	Hand Operated Winches.
05.	Electric Welding machine.
06.	Jack with axle for lifting Cable Drum.
07.	Jointers Tool Box.
08.	Blow Lamps.
09.	Compression Tools suitable for Cables.
10.	Pull Lifts.
11.	Pulley Blocks.
12.	Hooks/Chains
13.	Cable Rollers.
14.	Hydraulic Jacks
15.	Aluminium Rollers.
16.	D- Shackles.
17.	Dynamometers.
18.	TIG, Welding machine (for Aluminium welding).
19.	High Vacuum 1000 GPH Oil Filtration Machine for Transformer / Reactor oil suitable for 760mm vacuum. In case 250 MVA / 315 MVA transformer ETC work is covered in the scope, Oil filtration equipment of 1500 GPH suitable for High Vacuum along with 30 kL capacity storage tank for oil storage and processing of oil should be provided.
20.	Hydraulic cranes including accessories (20 tonne or more and boom height of 15mts. Vertical or more) suitable for erection of transformer bushings accessories and other equipments.
21.	Hydraulic Crimping tools for conductor / Shield wire.
22.	Crimping tools for cable termination.
23.	Torque wrenches of different ranges in sufficient numbers.
24.	All general purpose hand tools in sufficient quantities.
25.	Shearing Machine for cutting of Earthing Flat.



- For cable laying.

BHARAT HEAVY ELECTRICALS LTD.
TRANSMISSION BUSINESS GROUP, NEW DELHI.
Conditions of Contract for Erection Works, Rev-02

26. Tool Kit for fitters.
27. Tool Kit for Electrician.
28. Bench Vice.
29. 'A' type collapsible Al. ladder height 8M.
30. 'H' type Al. ladder height 5M.
31. Pressure Gauge 0-1kg/Sq.cm for measurement of N2 pressure.
32. Vacuum gauges for measuring fire vacuum of less than 1 torr in transformer.
33. Nylon slings for 4T capacity with different lengths.
34. Turper
35. Angle meter for measurement of bushing angle during erection.
36. Nylon hammer.
37. Wedge for cutting of 'O' rings/neoprene gaskets.
38. Die/Drill tool for making holes in gland plates (All sizes in sufficient numbers)
39. Phoenix screw drivers for handling of Terminal Blocks.

IMPORTANT NOTE:

1. The Contractor shall submit the copies of latest test certificate of lifting tackles, slings, pulleys etc. after mobilisation at site to the ENGINEER-IN-CHARGE.
2. Above is only a specimen/indicative list and any other Tools & Tackles as may be required by Owner/ BHEL at site during the execution of work will be arranged by the contractor promptly.
3. The status of tools, plants and instruments mentioned in annexure C of section - A does not relieve the subcontractor of his responsibility to make available all the test equipments and tools & tackles mentioned in the annexures of section B as per requirement of project.

BHARAT HEAVY ELECTRICALS LTD.
TRANSMISSION BUSINESS GROUP, NEW DELHI.
Conditions of Contract for Erection Works, Rev-02

SECTION-C

SPECIAL CONDITIONS OF **CONTRACT**

SECTION - C

SPECIAL CONDITIONS OF THE CONTRACT

C.1.0 QUALIFICATION OF THE CONTRACTOR :

- C.1.1 The contractor must have the experience of execution of identical work in the past as specified in the tender documents and must have executed contracts of similar nature. The contractor must furnish enough evidence to establish his capacity in erection, testing and commissioning of similar equipments covered under this specification.
- C.1.2 The contractor should be able to obtain clearance from the Electrical Inspector/ State Authorities on completion of the installations. If required, the Contractor is supposed to obtain such clearances on part completion of the installation as required by BHEL / Owner time to time. Also, before the start of work the contractor should obtain the supervisory license from the concerned Electrical Authorities.
- C.1.3 The Contractor will have following certificates.
- a) Contractor electrical licence.
 - b) Supervisor competency certificates to deal with Electrical high voltage equipments for their installation and for their installation and testing.
- Such certificates from two persons of subcontractors representatives who will be posted at site will be required.
- C.1.4 The contractor should be aware of the local conditions and be well acquainted with the site.
- C.1.5 The contractor shall be preferred who has worked for State Electricity Boards/BHEL/Steel Authorities/Public Undertakings.
- C.1.6 The contractor should have a very good engineering background and capability of carrying out erection and commissioning work of large scale.

BHARAT HEAVY ELECTRICALS LTD.
TRANSMISSION BUSINESS GROUP, NEW DELHI.
Conditions of Contract for Erection Works, Rev-02

~~C.2.0~~ **TERMS OF PAYMENT FOR ERECTION, TESTING AND COMMISSIONING :**

C.2.1

C.2.2

C.2.3

Please refer " Annexure to conditions of contract for ETC Work" attached with the tender documents.

C.2.4

C.2.5

C.2.6

BHARAT HEAVY ELECTRICALS LTD.
TRANSMISSION BUSINESS GROUP, NEW DELHI.
Conditions of Contract for Erection Works, Rev-02

C.2.7

Please refer " Annexure to conditions of contract for ETC Work" attached with the tender documents.

C.2.8

Above clause No. C.2.0 stands deleted. Please refer Annexure to conditions of contract for ETC works.

C.3.0 **SECURITY DEPOSIT:**

C.3.1

C.3.2

Please refer " Annexure to conditions of contract for ETC Work" attached with the tender documents.

C.3.3

C.3.4

C.3.5 **RETURN OF SECURITY DEPOSIT:**

The contractor should refer the clause A.17.7.

No interest shall be payable by BHEL on Earnest Money/Security Deposit or on any money due to the contractor by BHEL.

BHARAT HEAVY ELECTRICALS LTD.
TRANSMISSION BUSINESS GROUP, NEW DELHI.
Conditions of Contract for Erection Works, Rev-02

C.4.0 PERFORMANCE GUARANTEE:

C.4.1 The contractor shall be responsible for any defects in the execution of work noticed in guarantee period of 12 months reckoned from the date of putting the complete system into commercial operation/handing over to customer or 18 months from the date of system is declared completely erected, duly tested and accepted by BHEL and customer. The Contractor shall submit a bank guarantee worth 10% of the total contract value of erection, testing and commissioning of equipment in the prescribed proforma form of BHEL. If the contract is for more than one sub-station and the substations are completed and taken over by customer in stages, then the performance BG for the substation completed and handed over may be submitted based on the contract value of individual substation at the time of submitting the final bill, substation wise.

~~C.5.0 LD/PENALTY FOR DELAY IN EXECUTION:~~

C.5.1

Please refer " Annexure to conditions of contract for ETC Work" attached with the tender documents.

Above clause No.C.5.0stands deleted. Please refer Annexure to conditions of contract for ETC works.

BHARAT HEAVY ELECTRICALS LTD.
TRANSMISSION BUSINESS GROUP, NEW DELHI.
Conditions of Contract for Erection Works, Rev-02

C.6.0 RECEIPT/ UNLOADING, HANDLING, TRANSPORTATION, SECURITY AND PRESERVATION OF EQUIPMENT AT SITE:

- C.6.1 The contractor shall take the delivery of all the equipment, structures and materials etc. at site and their security shall be the responsibility of the contractor. Further transportation of materials to work place as per requirements will be in the scope of the contractor. For any delay, demurrage/wharfage/detention charges will be borne by the contractor.

In order to ensure timely completion of project, some of the equipment/material as covered under clause no. E.10.0 of Section-E (Schedule of equipment) may arrive at site and are unloaded and stacked/stored prior to mobilisation of ETC Contractor for the work covered under this Tender Specification. In such a case, the amount actually spent by BHEL on unloading and storage till the time of mobilisation by the ETC contractor shall be debited to their account. Immediately after mobilisation, the contractor shall take these into their custody and all the conditions as applicable for the material directly received by the contractor will be applicable for these material.

C.7.0 FACILITIES TO BE PROVIDED AT SITE BY THE CONTRACTOR:

- C.7.1 Watch and ward by authorised/licensed agency for the safe custody of the equipment shall be responsibility of the contractor.
- C.7.2 It is the responsibility of the contractor to dismantle and take away all the materials of his office accommodation as soon as the project is handed over to BHEL/Owner and clean the area off debris.

C.8.0 TESTING AND COMMISSIONING:

- C.8.1 All the electrical/mechanical test of the materials and equipment will be arranged by the contractor as per standard Specification/Field Quality Plan/ Erection Manual/Directive of the Site Engineer and Owner. The contractor shall have to fill the check list (site inspection record forms) for receipt, storage, erection, testing and commissioning of all the equipments as per BHEL systems to ensure proper quality of work.

BHARAT HEAVY ELECTRICALS LTD.
TRANSMISSION BUSINESS GROUP, NEW DELHI.
Conditions of Contract for Erection Works, Rev-02

C.8.2 All the testing equipment required to carry out the site test for all the equipment or the erected equipment shall be calibrated and shall be arranged by the contractor at his own cost. However, necessary instruction and the guidelines will be given by BHEL/owner.

In case Contractor is unable to provide the calibrated measuring and test instruments to the satisfaction of 'ENGINEER' then as per his own wisdom/judgement can recommend a deduction of maximum limit up to 5% from the Contractor's bill. But this in no way relieves the Contractor from arranging the test & measuring instruments / equipment as required for completion of the 'PROJECT' without affecting the quality of work and meeting any Contractual obligation whatsoever.

C.8.3 The contractor shall be completely responsible for the satisfactory erection and providing Test Equipment and skilled manpower for testing, commissioning of all equipment, notwithstanding the fact that he may be assisted by BHEL or its authorised representative.

C.8.4 The installation of all electrical equipment shall be carried out only by an electrical contractor holding a valid License for carrying out installation work of the voltage classes involved, under the direct supervision of and by persons holding valid certificates of competency for the same voltage classes, issued or recognised by the State Government. Contractor shall submit the particulars of the License held by him.

C.8.5 The contractor shall furnish to BHEL the names and particulars of certificates of competency of the supervisors and workmen to be engaged for carrying out installation work against this specifications.

C.8.6 The work shall be executed in a workman like manner in accordance with the requirements specified in the General Specification of Electrical Equipment installation, testing and commissioning specifications. Copy of such specifications/ drawings will be given to successful bidder before starting the work.

BHARAT HEAVY ELECTRICALS LTD.
TRANSMISSION BUSINESS GROUP, NEW DELHI.
Conditions of Contract for Erection Works, Rev-02

- C.8.7 All electrical work shall also comply with standard norms and practices adopted by the State Electricity Board. Site test reports shall be prepared and submitted by the contractor.
- C.8.8 Before charging the installation in part or full, this shall have to be approved by Statutory Govt. Authorities like Electrical Inspector, other concerned agency and the contractor has to arrange approval for the same as and when required by BHEL/Owner.
- C.8.9 Any feasible modification in the equipment or installation that may be demanded by Electrical Inspector shall have to be carried out by the contractor at no extra charges to BHEL. The contractor shall take all necessary steps to enable BHEL/Owner to get the installation approved by the above authorities & shall render all necessary assistance to BHEL/Owner in the matter.
- C.9.0 **COMPLETION OF CONTRACT:**
- C.9.1 All equipment, mountings, fittings accessories or apparatus which may not have been specifically mentioned but which are usual or necessary for completing the erection and commissioning work of system, shall be done by the contractor without any extra charges.
- C.10.0 **TRIAL OPERATION AND HANDING OVER:**
- C.10.1 On completion of erection of the equipment and before pre-commissioning tests of the equipment, each of the equipment shall be inspected by the BHEL/Owner for the correctness and completeness of the installation. Thereafter commissioning engineers shall carry out all pre-commissioning tests. The results of such pre-commissioning tests shall be signed jointly by the contractor's representative and BHEL/Owner.
- C.10.2 On conclusion of satisfactory pre-commissioning tests, the trial operation of the equipments shall start. The equipment shall be on trial operations during which period all necessary adjustments shall be made.

BHARAT HEAVY ELECTRICALS LTD.
TRANSMISSION BUSINESS GROUP, NEW DELHI.
Conditions of Contract for Erection Works, Rev-02

- C.10.3 After completion of trial operation, the plant will be handed over to the owner, after the period to be specified by BHEL. On taking over the plant, the owner shall issue a certificate to that effect.
- C.10.4 BHEL/Owner shall be at liberty from time to time or at any time before the completion of the works to take possession and use any part of the completed works and in such case the contractor shall completely finish the said uncompleted part or parts of the works as and when the engineer shall direct whether before or after the respective prescribed time or extended time (if any) for the completion of the works and if required by the engineer while the owner is in possession of the said part or parts, of the site or works.
- C.10.5 If due to reason of any default on the part of Contractor, a taking over certificate has not been issued in respect of any portion of the works, within one month after the time for completion or extended time as the case may be, the Owner/BHEL shall be at liberty to use the works or any portion thereof in respect of which a taking over certificate has not been issued, provided that the works or the portion so used as aforesaid shall be reasonably capable of being used and that the Contractor shall be afforded the earliest opportunity of taking such steps as may be necessary to permit the issue of the taking over certificate.

C.11.0 **ADDITIONAL EXPENDITURE:**

In case any additional expenditure is incurred in the works arising out of the faulty execution of the works by the contractor, such additional expenditure shall be borne by the contractor.

C.12.0 **SPLITTING THE WORK:**

BHEL reserves the right to split the work and award any part of the work to any agency without assigning any reason whatsoever.

C.13.0 **SUPPLY OF MATERIAL:**

- C.13.1 The Contractor shall in no case be entitled to any compensation or damage on account of any delay in supply or non-supply thereof for all or any such materials and stores but the contractor shall be entitled to suitable extension of time as may be determined by the Engineer whose decision shall be final and binding.

**BHARAT HEAVY ELECTRICALS LTD.
TRANSMISSION BUSINESS GROUP, NEW DELHI.**

Conditions of Contract for Erection Works, Rev-02

C.13.2 The contractor shall satisfy himself of the quantity and quality of the materials at the time of taking delivery from the BHEL/Owner. No claim whatsoever will be entertained by the BHEL/Owner on account of quality or quantity after the materials are taken by the contractor from the BHEL/Owner.

C.14.0 **ELECTRICITY AND WATER:**

C.14.1 Electricity for construction work shall be provided at one point on chargeable basis at the rate prevailing at the time of drawal of power, unless specified otherwise. The contractor shall have to make their own arrangements, at their cost, for distribution to various locations for their works including proper switch/fuse units, distribution boards, cables, poles etc. to ensure safety of men and equipment. Where required the contractor shall employ diesel operative equipment in addition to electric operated ones to ensure timely completion of work.

In case BHEL is unable to provide Electricity on chargeable basis then the contractor has to arrange same at his end.

C.14.2 The contractor shall indicate in his offer the power load required by him along with the load details for which power is required.

C.14.3 The owner shall not be responsible for any inconvenience caused due to any failure of lighting and power supply and no compensation for delay in works can be claimed by the contractor due to such non-supply on the grounds of idle labour, machinery or any other grounds.

C.14.4 The contractor should ensure that the work in critical areas is not held up in the event of lighting and power breakdown and for the same he should have some standby arrangement at his cost. In the event of breakdown in the electric supply, if the progress of work is hampered, it will be the responsibility of the contractor to step up the progress after restoration of electric supply so that over all progress of work is not affected. The contractor shall make proper arrangement of illumination at work place while working in late hours or in darkness.

C.14.5 Unless stated otherwise in the scope of works, the contractor shall make his own adequate arrangement for procuring clear water to be used in the works.

BHARAT HEAVY ELECTRICALS LTD.
TRANSMISSION BUSINESS GROUP, NEW DELHI.
Conditions of Contract for Erection Works, Rev-02

C.15.0 **INSURANCE :**

C.15.1 Contractor shall take insurance cover(s) to cover his Tools and Plants, Assets, workmen compensation and third party liability. The contractor shall make available the original insurance cover(s) to the Engineer for necessary verification before commencement of work.

C.16.0 **ESCALATION/PRICE VARIATION :**

C.16.1 Under this contract, **No escalation/ Price variation** is allowed. The quoted prices are FIRM till complete commissioning and handing over of the Project to Customer/Owner.

C.17.0 **OVERRUN CHARGES:**

C.17.1 **Above clause No.C-17.0 stands deleted. Please refer Annexure to conditions of contract for ETC works.**

C.18.0 **CONSTRUCTION SCHEDULE:**

C.18.1 While submitting the offer the contractor shall furnish Bar Chart detailing out all major activities, as to how he proposes to complete the work maintaining the completion schedule as given in Notice Inviting Tender. If the contractor fails to achieve any milestone indicated in the Bar Chart/completion schedule mentioned elsewhere, the contractor shall be levied penalty as per clause C.5.0.

C.19.0 **HEAVY MATERIAL HANDLING EQUIPMENT:**

The contractor must clearly indicate the details of all Heavy Materials Handling Equipment owned by him in Annexure-C of Section-A, General Instructions to the Tenderer. The boom length, capacity of handling load and other relevant details must also be given.

C.20.0 **CALIBRATED TEST INSTRUMENTS:**

Contractor is required to bring all the required testing equipments and instruments for conducting pre-commissioning test. All instruments should be calibrated as this is an ISO System requirement and the contractor should furnish test certificate for calibration. Also, please see clause E.4.2 and E.6.3 of Section-E for more details.

BHARAT HEAVY ELECTRICALS LTD.
TRANSMISSION BUSINESS GROUP, NEW DELHI.
Conditions of Contract for Erection Works, Rev-02

- C.21.0 Contractor should maintain moisture free store.
- C.21.1 Illumination system in & around store should be maintained by the contractor.
- C.21.2 All the material stored in the open yard shall be covered by tarpaulins to be arranged by the contractor.
- C.22.0 **PROTECTION OF WORK :**
- C.22.1 Contractor shall effectively protect his work, equipment, material from theft, damage or tempering at his own expenses till the work is finally taken over by the BHEL/Owner.
- C.22.2 Finished work where required, shall be suitably covered to keep it clean and free from defacement or damage.
- C.22.3 Necessary fire protection arrangement is to be made by the contractor for store and place of work.
- C.23.0 **SAFETY MEASURES :**
- C.23.1 All safety rules and codes as applicable to work shall be followed without exception.
- C.23.2 All safety appliances and protective devices including safety belt, hand gloves, aprons, helmets, shield goggles etc. shall be provided by the contractor to his personnel. Also, the Contractor must follow BHEL Quality system to ensure safety in all activities of site work.
- C.24.0 **QUALITY RECORDS (FQPs, MATERIAL MANAGEMENT ETC.)**
- C.24.1 Contractor should follow field quality plan furnished by BHEL to ensure quality in all activities of work performed at site.
- C.24.2 The contractor shall have to maintain records pertaining to Material Verification on receipt at site as well as Daily Receipt Register, Stock Register as per the various quality systems of BHEL.

**BHARAT HEAVY ELECTRICALS LTD.
TRANSMISSION BUSINESS GROUP, NEW DELHI.**

Conditions of Contract for Erection Works, Rev-02

- C.25.0 The contractor shall remove all scaffolding, ladders, temporary structures etc. erected by him during erection in order to leave place neat and clean to the satisfaction of the owner.
- C.26.0 All packing/items are to be checked immediately on receipt at site. Any shortages, damages are to be reported to BHEL within a week's time in writing.
- C.26.1 All parts shall be thoroughly cleaned, all rust removed and surface polished as required before erection of any equipment.
- C.26.2 Cleaned and polished parts shall be coated with anti-corrosive paints wherever necessary.
- C.27.0 After completion of work, reconciliation is to be done for all the material issued to the contractor. Balance materials are to be returned to BHEL/Owner.

C.28.0 **WORKING HOURS:**

If in the opinion of BHEL, the progress of the erection work by the contractor at any stage needs expediting so as to ensure completion of work within stipulated time, BHEL shall have the right to instruct the Contractor to increase the Contractor's manpower and working hours and the contractor shall comply with such instructions without any Extra Charges.

C.29.0 **DIVISION OF WORK:**

Prices are to be quoted for schedule of Equipment - E.10.0 of Section-E. Work can be split-up and awarded to more than one contractor as per requirement of BHEL/Owner for timely completion of Project.

C.30.0 **INCOME TAX / SALES TAX / WORKS TAX/VAT**

~~The items to be quoted by bidder shall be EXCLUSIVE of Government~~
Please refer "Annexure to conditions of contract for ETC Work" attached with the tender documents.

Above clause No.C-30.0 stands deleted.Please refer Annexure to conditions of contract for ETC works.

**BHARAT HEAVY ELECTRICALS LTD.
TRANSMISSION BUSINESS GROUP, NEW DELHI.**

Conditions of Contract for Erection Works, Rev-02

C.31.0 **DISCREPANCIES AND ADJUSTMENT OF ERRORS**

- C.31.1 The several documents forming the contract are to be taken as mutually explanatory of one another, detailed drawings being followed in preference to small scale drawings & figures dimensions in preference to scale & special conditions in preference to general conditions.
- C.31.2 In case of discrepancies between schedule of quantities, the specification and/or the drawings the following order of preference shall be observed.
- a) Description in Schedule of Quantities.
 - b) Special Conditions.
 - c) Drawings
 - d) Technical Specifications.
 - e) General Conditions of Contract.
- C.31.3 If there are varying or conflicting provisions made in any one document forming part of the contract, the Engineer shall be deciding authority with regard to the document.
- C.31.4 Any error in the description, quantity in schedule of quantities or any omission there from shall not vitiate the contract or release the contractor from the execution of the whole or any part of the works comprised therein according to the drawings and specifications or from any of his obligations under the contract.
- C.31.5 If on check there are found to be differences between the rates given by the contractor in words and figures or in the amount worked out by him in the schedule of quantities and general summary, the same shall be adjusted in accordance with the following rules. :
- a) In the event of discrepancies between description in words and figures quoted by tenderer, the description in words shall prevail.
 - b) In event of an error occurring in the amount column of schedule of quantities as a result of wrong extension of the unit rate and the quantity, the unit rate shall be regarded as firm and extension shall be amended on the basis of the rates.
 - c) All errors in totalling in the amount column and in carrying forward totals shall be corrected.

**BHARAT HEAVY ELECTRICALS LTD.
TRANSMISSION BUSINESS GROUP, NEW DELHI.**

Conditions of Contract for Erection Works, Rev-02

- d) The totals of sections of bill of quantities amended shall be carried over to the general summary and the tendered sum amended accordingly. The tendered sum so altered shall, for the purpose of tender be substituted for the sum originally tendered and considered for acceptance instead of the original sum quoted by the tenderer. Any rounding of quantities or in sections of bill of quantities or in general summary, by the tenderer, shall be ignored.

- C.31.6 If neither drawings nor specifications contain any mention of minor details of construction which in the opinion of the Engineer, whose decision shall be final and conclusive, are reasonable and obviously and fairly intended for satisfactory completion of work, such details shall be provided by the contractor without any extra cost, as if they were specially mentioned and shall be deemed to be included in the contract.

BHARAT HEAVY ELECTRICALS LTD.
TRANSMISSION BUSINESS GROUP, NEW DELHI.
Conditions of Contract for Erection Works, Rev-02

SECTION-D

ERECTION CONDITIONS **OF CONTRACT**

BHARAT HEAVY ELECTRICALS LTD.
TRANSMISSION BUSINESS GROUP, NEW DELHI.
Conditions of Contract for Erection Works, Rev-02

SECTION - D

ERECTION CONDITIONS OF CONTRACT

D.1.0 GENERAL:

D.1.1 The following shall supplement the conditions already contained in the other parts of these specifications and documents and shall govern that portion of the work of this contract to be performed at site.

D.1.2 The contractor upon signing of the contract shall, in addition to a Project Coordinator, nominate another responsible officer as his representative at site suitably designated for the purposes of overall responsibility and co-ordination of the works to be performed at site. Such person shall function from the site office of the contractor during the pendency of the contract.

D.2.0 REGULATION OF LOCAL AUTHORITIES AND STATUTES:

D.2.1 The contractor shall comply with all the rules and regulations of local authorities during the performances of his field activities. He shall also comply with the **Minimum Wages Act, 1948 and the Payment of Wages Act** (Both of Government of India) and the rules made there under in respect of any employee or workman employed or engaged by him or his sub-contractor.

The Contractor should note that all instructions of Engineer shall be binding for example display of Minimum Wages paid to the workmen, construction of toilets etc. in the vicinity of working area from health and sanitation standpoint etc.

D.2.2 All registration and statutory inspection fees, if any in respect of his work pursuant to this contract shall be to the account of the contractor. However any registration, statutory inspection fees lawfully payable under the provision of the statutory laws and it's amendments from time to time during erection in respect of the plant equipment ultimately to be owned by the Owner/BHEL shall be to the account of the Owner/BHEL. Should any such inspection or registration need to be rearranged due to the fault of the Contractor or his sub-contractor, the additional fees for such inspection and/or registration shall be borne by the contractor.

BHARAT HEAVY ELECTRICALS LTD.
TRANSMISSION BUSINESS GROUP, NEW DELHI.
Conditions of Contract for Erection Works, Rev-02

D.3.0 OWNER'S LIEN ON EQUIPMENT :

The owner/ BHEL shall have lien on all equipments including those of the contractor brought to the site for the purposes of erection, testing and commissioning of the plants. The Owner/ BHEL shall continue to hold the lien on all such equipments through out the period of contract. No material brought to the site shall be removed from the site by the contractor and/ or his Sub-contractors without the prior written permission of BHEL.

D.4.0 RE-WORKS ETC. :

In case Owner/BHEL/consultant during inspection at site rejects an item already agreed and the same is agreed to by BHEL and any re-execution of works of other contractors and/or his agencies, which might have got damaged or affected by the replacements will have to be attended to by the contractor free of cost.

D.5.0 ACCESS TO SITE AND WORKS ON SITE :

D.5.1 Suitable access to and possession of the site shall be provided to the contractor by Owner/ BHEL in reasonable time.

D.5.2 The works so far as it is carried out on the owner's premises shall be carried out at such time as the owner/BHEL may approve and the Owner/ BHEL shall give the contractor reasonable help/ facility for carrying out the works.

D.5.3 In the executions of the works, no persons other than the Contractor or his duly appointed representative, Sub- contractor and workmen shall be allowed to do work on the site except by the special permission in writing by BHEL.

D.6.0 CONTRACTOR'S SITE OFFICE ESTABLISHMENT:

The contractor shall establish site office at the site and keep posted an authorised representative for the purpose of contract. Any written order or instruction of BHEL or his duly authorised representative shall be communicated to the contractor at the site office and the same shall deemed to have been communicated to the contractor at his legal address.

BHARAT HEAVY ELECTRICALS LTD.
TRANSMISSION BUSINESS GROUP, NEW DELHI.
Conditions of Contract for Erection Works, Rev-02

D.7.0 CO-OPERATION WITH OTHER CONTRACTORS:

D.7.1 The contractor shall co-operate with all other contractors or tradesmen of the owner/BHEL who may be performing other works on behalf of them and the workmen who may be employed by the owner/BHEL doing work in the vicinity of the works under the contract. The contractor shall also arrange to perform his work as to minimise to the maximum extent possible interference with the work of other contractors and his workmen. Any injury or damage that may be sustained to the employees of the other contractors, BHEL and the owner due to the contractor's work shall promptly be made good at contractor's own expenses. The owner/ BHEL shall determine the resolution of any difference or conflict that may arise between the contractor and other contractor's or between the contractor and workmen of the owner and BHEL in regard to their work. If the works of the contractor is delayed because of any acts or omission of another contractor, the contractor shall have no claim against the owner/ BHEL on that account other than an extension of time for completing his works.

D.7.2 BHEL shall be notified promptly by the contractor of any defects in the other contractor's works that could affect to the contractor's works. The owner/BHEL shall determine the corrective measures if any, required to rectify this situation which shall be binding on the contractor.

D.8.0 DISCIPLINE OF WORKMEN:

D.8.1 The contractor shall adhere to the disciplinary procedure set by the owner in respect of his employees & workman at site. The owner/BHEL shall be at liberty to object to the presence of any representatives or employee of the contractor at the site, if in the opinion of the owner/ BHEL such employee has misconducted himself or be incompetent or negligent or otherwise undesirable and then the contractor shall remove such a person objected to and provide in his place a competent replacement.

BHARAT HEAVY ELECTRICALS LTD.
TRANSMISSION BUSINESS GROUP, NEW DELHI.
Conditions of Contract for Erection Works, Rev-02

D.9.0 CONTRACTOR'S FIELD OPERATION:

D.9.1 The contractor shall keep informed in advance regarding his field activity plans & schedule for carrying out such part of the works. Any review of such plan or schedule or method of work by the BHEL shall not relieve the contractor of any of his responsibilities towards the field activities and its schedule. Such reviews shall also not be considered as an assumption of any risk or liability by the owner/BHEL or consultant or any of his representatives and no claim of the contractor will be entertained because of the failure or inefficiency of any such plan or schedule or method or work reviewed. The contractor shall be solely responsible for the safety adequacy and efficiency of plant and equipments and his erection methods.

D.9.2 The contractor shall be completely responsible for the conditions of the work-site including the safety of all persons employed by him or his sub-contractor and all the properties under his custody during the performance of the work. This requirements shall apply continuously till the completion of contract and shall not be limited to normal working hours.

D.10.0 PHOTOGRAPH AND PROGRESS REPORT:

D.10.1 The Contractor shall furnish to BHEL photographs of the progress of work / work done at site. Photographs shall be taken as & when indicated by BHEL representative. Photograph shall be adequate in size & number to indicate various stages of erection. Each photograph shall contain the date, the name of the Contractor and the title of the Photograph. The cost of photographs is to be born by the Contractor.

D.10.2 The above Photographs along with the soft copy (on floppy/CD) shall accompany the monthly progress report detailing out the progress achieved on all erection activities as compared to the schedules. The report shall also indicate the reasons for the variance between the scheduled and actual progress and action proposed for corrective measures wherever necessary.

BHARAT HEAVY ELECTRICALS LTD.
TRANSMISSION BUSINESS GROUP, NEW DELHI.
Conditions of Contract for Erection Works, Rev-02

D.11.0 MANPOWER REPORT:

D.11.1 The Contractor shall submit to BHEL from the first working day of every month, a Manpower report of the previous month detailing the number of persons scheduled to have been employed and actually employed skill-wise and the areas of employment of such labour.

D.12.0 PROTECTION OF WORK:

The Contractor shall have total responsibility for protecting his works till it is finally taken over by the owner. No claim will be entertained by the BHEL for damage or loss to the Contractor's works & the contractor shall be responsible for the complete restoration of the damaged work to its original condition to comply with the specification & drawings. Should any such damage to the Contractor's works occur because of other party not under him directly, & if disagreement or

conflict or dispute develops between the contractor & the other party or parties concerns works the same will be resolved as per the provisions of the clause D.7.0 above entitled cooperation with other contractors. The contractor shall not cause any delay in the repair of such damaged works because of any delay in the resolution of such dispute. The contractor shall proceed to repair the work immediately & no cause thereof will be assigned pending resolution of such dispute.

D.13.0 EMPLOYMENT OF LABOUR:

D.13.1 The Contractor will be expected to employ on the work only his regular skilled employees with experience of his particular work. No female labour shall be employed after darkness. No person below the age of eighteen years shall be employed.

D.13.2 All travelling expenses including provision of all necessary transport to and fro for Site, lodging allowance and other payments to be Contractor's employees shall be the sole responsibility of the contractor.

D.13.3 The hours of work on the Site shall be decided by the owner/BHEL and the Contractor shall adhere to it. Working hours will normally be eight (8) hours per day Monday through Saturday or depending upon the situation/ requirement.

BHARAT HEAVY ELECTRICALS LTD.
TRANSMISSION BUSINESS GROUP, NEW DELHI.
Conditions of Contract for Erection Works, Rev-02

D.13.4 Contractor's employees shall wear identification badges while on the work at site.

D.13.5 In the case of owner/BHEL become liable to pay any wages or dues to the labour or to any Government agency under any of the provisions of the Minimum Wages Act, Workmen Compensation Act, Contractor Labour Regulation Abolition Act or any other law due to act or omission of the Contractor, BHEL may make such payment and recover the same from the Contractor's bills or from any amount which is already under process of payment to the Contractor.

D.14.0 **FACILITIES TO BE PROVIDED BY OWNER:**

D.14.1 Space: The Contractor shall advise BHEL within Fifteen (15) days from the date of acceptance of the Letter of Intent about his exact requirement of space for his office, storage area. The above requirements shall be reviewed by the Owner/BHEL & space will be allotted to the Contractor for construction of his temporary structures like office and storage sheds.

D.14.2 Construction water and power (Electricity) (Refer Clause C.14.0).

D.15.0 **FACILITIES TO BE PROVIDED BY THE CONTRACTOR:**

D.15.1 **CONSTRUCTION EQUIPMENTS, TOOLS, TACKLES AND SCAFFOLDINGS:**

The Contractor shall provide all the construction equipments, tools, tackles and scaffoldings required for pre-assembly, erection, testing and commissioning of the equipments covered under the contract. He shall submit a list of all such materials to the BHEL before the commencement of work at Site. These tools and tackles shall not be removed from site without the written permission of the owner/BHEL.

D.15.2 **COMMUNICATION:**

The Contractor will make his own arrangement for all his communication needs such as telephone, fax etc., at his site office and his residential accommodation.

BHARAT HEAVY ELECTRICALS LTD.
TRANSMISSION BUSINESS GROUP, NEW DELHI.
Conditions of Contract for Erection Works, Rev-02

D.15.3 FIRST AID:

The Contractor shall provide necessary first aid facilities for all the employees, representatives and workmen working at the Site. Enough number of contractor's personnel shall be trained in administering first aid.

D.15.4 CLEANLINESS:

D.15.4.1 The Contractor shall be responsible for keeping the entire area allotted to him clean and free from rubbish, debris, etc. during the period of contract. The Contractor shall employ enough number of special personnel to thoroughly clean his work-area at least once in a day. All such rubbish and scrap material shall be stacked or disposed in a place to be identified by the owner/BHEL. Materials and stores shall be so arranged to permit easy cleaning of the area. In areas where equipment might drip oil and cause damage to the floor surface, a suitable protective cover of the flame resistant, oil proof shield shall be provided to protect the floor from such damage.

D.15.4.2 Similarly the labour colony, the office & the residential areas of the Contractor's employees and workmen shall be kept clean & neat to the entire satisfaction of the Owner/BHEL. Proper sanitation arrangements shall be provided by the contractor in the workmen areas, office and residential areas of the contractor.

D.16.0 LINES AND GRADES:

All the works shall be performed to the lines, grades and elevations indicated on the drawings. The Contractor shall be responsible to locate the layout of the works. Basic horizontal and vertical control points as required will be established & marked by the Owner/BHEL at Site at suitable points.

These points shall be used as datum for the works under the contractor. The contractor shall inform the Engineer well in advance of the time and places at which he wishes to do work in the area allotted to him, so that suitable datum points may be established and checked by Owner/BHEL to enable the contractor to proceed with his works. Any work done without being properly located may be removed and/or dismantled by the Owner/BHEL at Contractor's expenses.

BHARAT HEAVY ELECTRICALS LTD.
TRANSMISSION BUSINESS GROUP, NEW DELHI.
Conditions of Contract for Erection Works, Rev-02

D.17.0 FIRE PROTECTION:

- D.17.1 The work procedures that are to be used during erection shall be those which minimise fire hazards to the extent practicable. Combustible materials, combustible waste and rubbish shall be collected and removed from the site at least once each day. Fuels, oils and volatile or flammable materials shall be stored away from the construction and equipments and material storage and areas in safe containers. Untreated canvas paper, plastic or other flammable materials shall not at all be used at site for any other purpose unless otherwise specified, if any such materials are received with the equipment at the Site, the same shall be removed and replaced with acceptable materials before moving in to the construction area or storage.
- D.17.2 Similarly corrugated paper fabricated cartons etc., will not be permitted in the construction area either for storage or for handling of materials. All such materials used shall be of water proof and flame resistance type. All other materials such as working drawings, plants etc. which are combustible but are essential for the works to be executed shall be protected against combustion resulting from welding sparks, cutting flames and other similar fire sources.
- D.17.3 All the contractors supervisory personnel and sufficient number of workers shall be trained for fire-fighting and assigned specific fire protection duties. Enough of such trained personnel must be available at the Site during the entire period of the Contract.
- D.17.4 The contractor shall provide enough fire protection equipment of the types and number for the ware-houses, office, temporary structures, labour colony area etc., access to such fire protection equipment shall be easy and kept all times.

D.18.0 SECURITY:

The Contractor shall have total responsibility for all equipments & materials in his custody stored, loose, semi assembled and/or erected by him at site. The contractor shall make suitable security arrangements including employment of security personnel to ensure the protection of all materials, equipments and works from theft, fire, pilferage & other damages and losses. All materials belonging to the Contractors shall enter and leave the project site only with the written permission of the Owner/BHEL in the prescribed manner.

BHARAT HEAVY ELECTRICALS LTD.
TRANSMISSION BUSINESS GROUP, NEW DELHI.
Conditions of Contract for Erection Works, Rev-02

D.19.0 CONTRACTOR'S AREA LIMITS:

The Owner will make out the boundary limits of access roads, parking spaces, storage and construction areas for the contractor and the contractor shall not trespass the areas not so marked out for him. The contractor shall be responsible to ensure that none of his personnel move out the areas marked out for his operations. In case of such a need for the contractor's personnel to work in the areas not marked out for him, the same shall be done only with written permission of the Owner/BHEL.

D.20.0 CONTRACTOR'S COOPERATION WITH THE OWNER/ BHEL:

In cases where the performances of the erection work by the contractor affects the operation of the system facilities of the Owner/BHEL such erection work of the contractor shall be scheduled to be performed only in the manner stipulated by the Owner/BHEL and the same shall be acceptable at all times to the contractor. The Owner/BHEL may impose such restriction on the facilities provided to the contractor such as electricity, water etc., as he may think fit in the interest of the Owner/BHEL and the contractor shall strictly adhere to such restrictions and cooperate with the Owner/BHEL. It will be responsibility of the contractor to provide all necessary temporary instrumentation and other measuring devices required during start up and operation of the equipment system which are erected by him. The contractor shall also be responsible for flushing and initial filling of all the oil and lubricant required for the equipment furnished and erected by him, so as to make such equipments ready for operation. The contractor shall be responsible for supplying such flushing oil & other lubricants unless otherwise specified elsewhere in these documents and specifications.

D.21.0 PRE-COMMISSIONING TRIALS AND INITIAL OPERATIONS:

The pre-commissioning trials and initial operations of the equipments furnished and erected by the contractor shall be the responsibility of the contractor as detailed in relevant clauses. The contractor shall provide in addition, test instruments calibrating devices etc. and the labour required for the successful performance of these trials. If it is anticipated that the above test may prolong for a long time, the Contractor's workmen required for the above test shall always be present at site during such trials.

BHARAT HEAVY ELECTRICALS LTD.
TRANSMISSION BUSINESS GROUP, NEW DELHI.
Conditions of Contract for Erection Works, Rev-02

D.22.0 MATERIAL HANDLING AND STORAGE:

D.22.1 All the equipments furnished under this contract arriving at site shall be promptly received, unloaded, transported and stored in the storage spaces by the contractor.

D.22.2 Contractor shall be responsible for examining all the shipments immediately on receipt at site and notify BHEL immediately if any damage, shortage, discrepancy. Filling of material verification reports on receipt of materials shall be carried out by the Contractor as per the instructions of Engineer. For any shortages or damages in transit, handling and/or in storage and erection of the equipments at site shall be intimated to BHEL/ equipment supplier promptly to enable them lodge claim with the underwriters. Any financial and/or time loss happened due to contractor's negligence in this regard shall be to the account of the contractor. Any demurrage, wharfage and any other charges claimed by the Transporter or Railways due to any reason attributable to the contractor such as delay in taking delivery in time shall also be to the account of the contractor.

D.22.3 The Contractor shall maintain an accurate and exhaustive record detailing out the list of all equipments received and keep such record open for the inspection of the Owner/BHEL at any time.

BHEL is an ISO Company and the contractor shall extend all help in maintaining records of receipts, issue and stock in line with Material Management System issued by BHEL. Also, he shall assist in periodic inspection of equipment/materials in stores as per this system.

The Contractor shall carryout all field activities related with ETC work as per Field Quality Plans (FQPs) provided by Engineer to ensure Quality of work at site as well as meet the contractual obligation to BHEL/Owner.

D.22.4 All equipments shall be handled very carefully to prevent any damage or loss. No bare wire ropes, slings etc. shall be used for unloading and/or handling of the equipments without the specified written permission of BHEL. The equipment stores shall be properly protected to prevent damage either to the equipment or to the floor where they are stored. The equipment from the store shall be moved to the actual location at the appropriate time so as to avoid damage of such equipment at site.

**BHARAT HEAVY ELECTRICALS LTD.
TRANSMISSION BUSINESS GROUP, NEW DELHI.**

Conditions of Contract for Erection Works, Rev-02

- D.22.5 All electrical panels, control gears, motors and such other devices shall be properly dried by heating before they are installed and energised. Motor bearings, slip rings, commutators and other exposed parts shall be protected against moisture ingress and corrosion during storage and periodically inspected. Heavy rotation parts if any, in assembled conditions shall be periodically rotated to prevent corrosion due to prolonged storage.
- D.22.6 All the electrical equipment, such as motors, transformers etc. shall be tested for insulation resistance at least once in three months from the date of receipt till the date of commissioning and record for such measured insulation values maintained by the contractor. Such records shall be open for inspection by the Owner/BHEL.
- D.22.7 The contractor shall ensure that all the packing materials and protection devices used for the various equipments during transit and storage are removed before the equipments are installed.
- D.22.8 The consumable and other supplies likely to deteriorate due to storage must be thoroughly protected and stored in a suitable manner to prevent damage or deterioration in quality by storage.
- D.22.9 All the materials stored in the open or dusty location must be covered with suitable weather proof & flame proof covering materials wherever applicable.
- D.22.10 If the materials belonging to the contractor are stored in areas other than these earmarked for him, the Owner/BHEL will have the right to get it removed to the area earmarked for the contractor at the contractor's cost.

BHARAT HEAVY ELECTRICALS LTD.
TRANSMISSION BUSINESS GROUP, NEW DELHI.
Conditions of Contract for Erection Works, Rev-02

D.22.12 STORAGE INSTRUCTION FOR GAS FILLED EQUIPMENTS:

- D.22.12.1 All transformers despatched to site are fitted with Nitrogen cylinder in the tank to maintain positive pressure. It will be the responsibility of the contractor to maintain the pressure and replace the empty Nitrogen cylinder with Nitrogen filled cylinder of required purity at his own cost whenever such cylinders are become empty. Contractor should also maintain the periodic record of the pressure of Nitrogen in the transformer in a register for this purpose.
- D.22.12.2 For all other gas filled equipments, like CTs, VTs, CVTs etc. the contractor should also maintain the gas pressure & if it falls below the required value, contractor should refill the leaked gas of required purity at his own cost.

D.23.0 CONSTRUCTION AND ARRANGEMENTS:

- D.23.1 The field activities of the contractors working at site, will be coordinated by BHEL and BHEL decision shall be final in resolving any dispute or conflicts between the contractor and other contractor's and tradesmen of the BHEL regarding scheduling and coordination of work. Such decisions shall not be cause for extra compensation for time to the contractor.
- D.23.2 The Owner/Consultant shall hold weekly meetings of all the contractors working at the site at a time and a place so designated. The contractor along with BHEL shall attend such meetings and take notes of discussions during the meeting and the decisions of the Owner/BHEL/Consultant shall be strictly adhered to in performing his works. In addition to the above weekly meetings, the Owner/Consultant/BHEL may call for other meetings either with individual contractors or with selected number of contractors and in such a case the contractor, if called will also attend such meetings with BHEL.
- D.23.3 Time is the essence of the contract & the contractor shall be responsible for performance of his work in accordance with the specified construction schedule. If at any time the contractor is falling behind the schedule, he shall take necessary action to make good for such delay by increasing his work force or by working overtime or otherwise accelerate the progress of the work to comply with the schedule and shall communicate such actions in writing to the BHEL satisfying them that his action will compensate for the delay. The contractor shall not be allowed any extra compensation for such action.

BHARAT HEAVY ELECTRICALS LTD.
TRANSMISSION BUSINESS GROUP, NEW DELHI.
Conditions of Contract for Erection Works, Rev-02

D.23.4 BHEL shall however not be responsible for provision of additional labour and/or materials or supply or any other service to the contractor except for the coordination work between various contractors as set out earlier.

D.24.0 **FIELD QUALITY PLANS AND RECORDS:**

The contractor shall maintain at his Site Office upto date copies of all drawings, specifications, FQPs and other contract documents and any other supplementary data complete with all the latest information thereto. The contractor shall also maintain in addition the continuous record of all changes to the above contract documents, drawings, specifications, supplementary data etc. effected at the field and on completion of his total assignment under the contract, shall incorporate all such changes on the drawings and other engineering data to indicate as installed/build conditions of the equipments furnished and erected under the contract.

Such "AS BUILT DRAWINGS" and "ENGINEERING DATA" shall be submitted to BHEL in required number of copies.

D.25.0 **CONTRACTOR'S MATERIALS BROUGHT ON TO SITE:**

D.25.1 The contractor shall bring to site all equipments, components, parts, materials, including construction equipment, tools & tackles for the purpose of the works under intimation to the owner/BHEL. All such goods shall, from the time of there being brought to site but may be used for the purpose of the works only and shall not on any account be removed or taken away by the contractor without the written permission of the BHEL.

D.25.2 After the completion of the works the contractor shall remove from the site under the direction of the BHEL the material such as construction equipment, erection tools and tackles, scaffolding etc. with the written permission of BHEL. If the contractor fails to remove such materials within fifteen (15) days of issue of a notice by the BHEL to do so, then BHEL shall have the liberty to dispose/remove such materials and expanses incurred by BHEL in this regard will be recovered from the Contractor.

BHARAT HEAVY ELECTRICALS LTD.
TRANSMISSION BUSINESS GROUP, NEW DELHI.
Conditions of Contract for Erection Works, Rev-02

D.26.0 PROTECTION OF PROPERTY AND CONTRACTOR'S LIABILITY:

- D.26.1 The contractor shall be responsible for any damage resulting from his operation. He shall also be responsible for protection of all persons including members of public and employees of the Owner/BHEL and the employees of other contractors and subcontractors building, other plants and equipments and utilities either above or below the ground.
- D.26.2 The contractor will ensure provisions of necessary safety equipments such as barriers, sign-boards, warning lights and alarm etc. to provide adequate protection to persons and property. The contractor shall be responsible to give reasonable notice to Owner/BHEL of public or private property and utilities when such property and utilities are likely to get damaged or injured during the performance of his work shall make all necessary arrangements with such owners related to removal and or replacement or protection of such property and utilities.

D.27.0 PAINTING:

All exposed metal parts of the equipment including pipings, structures, railings etc. wherever applicable shall be first painted with at least one coat of suitable primer after thoroughly cleaning all such parts off dirt and rust scales, greases, oil and other foreign materials by wire brushing, scraping or/and blasting and the same being inspected and approved by the Engineer for painting. After wards the above parts shall be finished with two coats of enamel paint. The quality of the finish paint shall be as per the standards of ISI equivalent and to be of the colour as approved by the Owner/BHEL.

D.28.0 PROTECTION OF MONUMENTS AND REFERENCE POINTS:

The contractor shall ensure that at points such as relic, antiquity, coins, fossils etc. which he may come across during the course of performance of his works either during excavation or elsewhere are properly protected & handed over to the owner under intimation to BHEL. Similarly the contractor shall ensure that the bench marks reference points etc. which are marked out either with the help of owner or by BHEL shall not be disturbed in any way during the performance of his works. If any work is to be performed which may disturb such references, the same shall be only after these are transferred to other suitable locations under the direction of BHEL. The contractor shall provide all necessary materials and assistant for such relocation of reference points etc.

BHARAT HEAVY ELECTRICALS LTD.
TRANSMISSION BUSINESS GROUP, NEW DELHI.
Conditions of Contract for Erection Works, Rev-02

D.29.0 WORK AND SAFETY REGULATIONS:

- D.29.1 The contractor shall ensure the safety of all the workmen, materials, and equipment either belonging to him or to others working at site.
- D.29.2 The contractor will notify the BHEL office of his intention to bring on to site any equipment or any container with liquid or gases, fuel or other substances which may create hazards. BHEL shall have the right to prescribe the conditions under which such equipment or container may be handled and used during the performance of the works and the contractor shall strictly adhere to such instructions. BHEL shall have strictly the right to inspect any construction plant and to forbid its use, if in his opinion it is unsafe. No claim due to such prohibition shall be entertained by BHEL.
- D.29.3 Where it is necessary to provide and/or store petroleum products or petroleum mixtures & explosive, the contractor shall be responsible for carrying out such provision and/or storage in accordance with the rules and regulations laid down in Petroleum Act,1934. Explosively Act,1948 and petroleum and carbide of calcium manual published by the Chief Inspector Of Explosive of India. All such storage shall have prior approval of BHEL in case any approval are necessary from the Chief Inspector of Explosive of any statutory authorities, the contractor shall be responsible for obtaining the same.
- D.29.4 The contractor shall be responsible for the safe storage of his & his sub-contractor's radio-active source if any.

D.30.0 ELECTRICAL SAFETY REGULATIONS:

- D.30.1 In no circumstances will the contractor interfere with fuses and Electrical Equipment belonging to BHEL/Owner or to the other contractors.
- D.30.2 Before the contractor connects any electrical appliances to any plug or sockets belonging to the other contractor or Owner, he shall:
- (a) Satisfy the Owner/BHEL that the appliances are in good working conditions.
 - (b) Inform the Owner/BHEL of the maximum current, relating, voltage etc. of the appliances.
 - (c) Obtain permission of the Owner detailing the sockets to which the appliances may be connected.

BHARAT HEAVY ELECTRICALS LTD.
TRANSMISSION BUSINESS GROUP, NEW DELHI.
Conditions of Contract for Erection Works, Rev-02

- D.30.3 The BHEL will not grant permission to the contractor until he satisfies that:
- (a) The appliance is in good conditions and fitted with suitable plug.
 - (b) The appliance is fitted with a suitable cable having proper earthing provisions.
- D.30.4 No cable in use will be disturbed by the contractor without prior permission. No weight of any description will be imposed on any such cable and no ladder or similar equipment will rest against or attached to it.
- D.30.5 No work shall be carried out on any live equipment. The equipment must be made safe by the BHEL/Owner and a permit to work issued before any work is carried out.
- D.30.6 The contractor shall employ the necessary number of qualified full time electrician to maintain his temporary electrical installation.
- D.31.0 **CONSUMABLES:**
- The contractor shall make arrangements for an adequate inventory at site of necessary consumable prior to erection so that the requirements of the same will not come in the way of timely completion of the works under the contract.
- D.32.0 **MILD STEEL AND ALUMINIUM WELDING & OTHER SPECIAL PROCESSES :**
- D.32.1 Only an approved and qualified welder shall be employed by the contractor. The welder will be subjected to pre-qualification test by Owner/BHEL.
- D.32.2 The Contractor shall ensure that personnel employed for doing other special processes like tube/pipe bending etc. are having proper experience and are qualified for doing such work.
- D.32.3 Erection of Aluminium tubular bus bar shall include cutting, bending, aluminium welding with sleeves (sleeves supplied by BHEL), Radiographic testing and D.P test of 100% welded joints, fixing corona end bells etc to complete.

BHARAT HEAVY ELECTRICALS LTD.
TRANSMISSION BUSINESS GROUP, NEW DELHI.
Conditions of Contract for Erection Works, Rev-02

- D.32.4 For MS welding, red lead paint shall be applied followed by aluminium paint and bitumen after welding. For GS welding , two coats of cold galvanising anti-corrosive paint shall be applied after welding. In case any special process is indicated in customer's specification, then the same shall be applicable.
- D.32.5 10% welded joints in earthing shall be tested for Dye penetration test.

SECTION – E

SCOPE OF WORK AND **COMPLETION** **SCHEDULE**

SECTION - E

SCOPE OF WORK AND COMPLETION SCHEDULE

E.1.0 SCOPE OF WORK :

The scope of work of the successful tenderer shall comprise but not limited to the following. The Tenderer shall read this scope of work in conjunction with all terms and conditions (Section -A,B,C & D) contained else where in this document. The quoted rates for various equipments/activities are deemed to include all the below mentioned activities and nothing extra is payable on account of these.

- E.1.1 For Contractor supplied materials:** It shall be prime responsibility of contractor to ensure safe storage of material supplied by him. The contractor may construct open/ covered store to ensure proper storage of the materials as per site requirement. Contractor will be permitted to dismantle and take back the stores after completion of the work. No additional payment shall be made/deducted on account of stores constructed by contractor for storing these materials.

For BHEL supplied materials: Contractor shall construct open/ covered store only if the same is mentioned in the Bill of Quantities.

If due to any reason the material can not be unloaded in designated store/open yard and it is unloaded at some nearby place on instructions of site Engineer then this material has to be shifted by subcontractor to designated store/open yard when it is ready without any additional claim. Any multiple handling of material within project premises is not payable by BHEL

Some items may get delivered at stores of other BHEL unit on account of convenience of despatch within the plant area. These material will be collected/shifted by subcontractor to switchyard store at no extra cost.

- E.1.2.1** Inspection / verification of equipment / materials received for any shortage / damage after opening the packing cases and intimating the same to BHEL/ Owner and underwriters within the time period specified by BHEL and to strictly follow the procedures specified. Storage of equipment indoor / open stores in line with the instructions of the manufacturer / BHEL.

BHARAT HEAVY ELECTRICALS LTD.
TRANSMISSION BUSINESS GROUP, NEW DELHI.
Conditions of Contract for Erection Works, Rev-02

Conservation / maintenance / upkeep of the equipment in the store.

Temporary lighting in stores & construction area wherever required.

Safety / Security of equipments / materials.

E.1.2.2 **Watch and ward of Erected Equipment/Material** - Soon as the erection of switchyards are taken up, the watch and ward for the erected items will also be arranged by the subcontractor till the switchyards are taken by BHEL/customer

E.1.3 Erection, levelling and fixing of GI Structures of towers, beams including all the equipment support structures on their respective foundations in line with drawings to be furnished by BHEL. Final adjustment of foundation levels by chipping and dressing, checking location, elevation, etc., and checking position of foundations / anchor bolts and grouting/under pinning of anchor bolts and base plates wherever necessary for certain aux. equipment and accessories of main equipment. Materials such as M.S. packing shims of required thickness for levelling and alignment and civil material for final grouting with 1:1 cement mortar with approved make anti-shrinkage compound and finishing shall be arranged by contractor. *The grouting/underpinning of all tower and equipment foundation bolts as per specifications is in the scope of Contractor ie Bidder.*

Fixing and assembly including minor modification, where required, of all cable trench materials like cable tray racks, cable trays, coupler plates, 'T' and 'L' bends etc in line with drawings to be furnished by BHEL. The work shall also covers laying of all cables including glanding and termination for all the equipments covered under BOQ . At various crossing and wherever necessary the cables to pass through pipes laid underground in line with drawing to be furnished by BHEL. Pipes will be supplied by BHEL for cabling from trench to equipment and laying of the same including excavation and backfilling and making and finishing of holes in trench walls will be carried out by the contractor.

E.1.4 Transportation of equipment/material from stores to erection site, erection of equipment materials in line with the drawings/instructions to be furnished by BHEL including filtration of oil wherever required, testing and commissioning and handing over to owner/customer.

BHARAT HEAVY ELECTRICALS LTD.
TRANSMISSION BUSINESS GROUP, NEW DELHI.
Conditions of Contract for Erection Works, Rev-02

- E.1.5 Earthing (if called for in BOQ) : laying of earth mat and risers including excavation, bending, cutting, welding, cleaning and painting of joints, backfilling and earth compaction etc. as per BHEL drawings/specifications.

Cutting, pointing and driving of MS rod electrode, installation of pipe electrode and construction of chambers as per drawings.

Earth connections from risers to equipment, structures etc. through GI flat including bending, cutting, welding, cleaning and painting of welded joints as per BHEL's drawings/specifications.

Welding electrode should be of reputed make company ISI certified, and as per BHEL's specifications.

- E.1.6 Providing for all consumables : It shall be noted by the tenderer that BHEL shall supply only the equipments/materials listed in schedule of equipments as free issue items. Any other sundry items required for completion of the job shall be procured by the contractor.

All Equipment fixing hardware shall be arranged by BHEL.

All cable glands shall be arranged by BHEL. However cable accessories like ferrules, lugs and markers, cable dressing and tying material etc. shall be in the scope of the contractor. The lugs shall be of reputed make company and as advised by BHEL site Incharge.

- E.1.7 Maintenance of switchyard and associated equipment till handing over to the owner, any other activity necessary for completion of the job but not specifically mentioned in this specification.
- E.1.8 Unloading, shifting, storing, verification, preservation during storage and handing over of spare items/maintenance equipment to Customer/Owner.
- E.1.9 Reconciliation and shifting of all the balance excess material and scrap material to BHEL store or handover in customer store, as the case may be.

BHARAT HEAVY ELECTRICALS LTD.
TRANSMISSION BUSINESS GROUP, NEW DELHI.
Conditions of Contract for Erection Works, Rev-02

This excess material may include erection spares for various items of BOQ such as ACSR/AAC conductor, Al tube, Cable trench materials, Cables etc. Excess erection spare (except main equipment) supplied by purchaser upto 10% of the erected quantity shall be absorbed by the contractor & shall not be payable. Only as erected quantity of the various items of BOQ shall be payable as per the unit rates. However, any erection spares (excluding main equipment) handled in excess of 10% of the erected quantity shall be payable @ 10% of the unit rate (to account for only unloading, storage and watch & ward. However, any additional quantity of main equipment, handled but not erected, shall be paid @ 10% of the item rate.

E.2.0 ERECTION, TESTING & COMMISSIONING REQUIREMENTS :

- E.2.1 All the switchyard equipment shall be erected, installed, tested and commissioned by the contractor to the satisfaction of BHEL/Owner adhering to the latest national standard and codes. Some of the Reference standards are given below which are normally applicable for Switchyard work. ETC activity of all other equipment to be done as per relevant standards.
- a) IS : 10118-1982 Code of practice for selection, installation and maintenance of switchgear & control gear.
 - b) IS : 10028-1985 Code of practice for installation and maintenance of transformer.
 - c) IS : 732-1963 Code of practice for electrical wiring.
 - d) IS : 3043-1963 Code of practice for earthing.
 - e) IS : 2309-1989 Code of practice for the protection of building and allied structure against lightning.
 - f) IS : 1646-1982 Code of practice for fire safety of building (General) Electrical installations.
- E.2.2 All electrical equipment and installations shall also conform to the latest Indian Electricity rules as regards safety, earthing and other essential provisions specified therein for insulation and operation of electric plants.

BHARAT HEAVY ELECTRICALS LTD.
TRANSMISSION BUSINESS GROUP, NEW DELHI.
Conditions of Contract for Erection Works, Rev-02

E.2.3 Earthing system, earth connections, testing of earthing system and connection, lightning protection system, electrical clearance and safety shall be strictly followed as per the national specifications which will be given to the successful bidder.

E.2.4 The schedule of equipment indicates the quantity of the equipment and these will be procured by BHEL and are to be erected by the contractor. The contractor has to erect, test all equipment for system commissioning and putting the same into operation. The trial run of individual equipment and final commissioning upto the handing over of the system to the customer of BHEL is the responsibility of the contractor.

Contractor will have to provide necessary support i.e.. suitable manpower, common tools, conventional testing instruments as per Annexure 'N' and other assistance as required by BHEL wherever expert services of any equipment are arranged by BHEL viz.. SF6 circuit breakers.

E.2.5 All equipments, material and accessories provided by the contractor shall conform to the requirements of the relevant Indian standard or International standard.

E.3.0 **METHOD OF WORKMANSHIP & QUALITY OF WORK:**

E.3.1 Workmanship will be in accordance with the best engineering practices to ensure satisfactory performances and service life.

E.3.2 All works shall be installed in a first class manner with technical skill in the trade involved to achieve quality of work of high standard. BHEL site supervisor's comments regarding quality of work should be taken care by the contractor.

E.3.3 The erection work shall be supervised by the competent supervisor holding supervisory license by the state or central Government or statutory licensing authority, as the case may be.

E.3.4 The installation shall be carried out in such a manner not to obstruct access to the other equipment installed or likely to be installed in the vicinity.

BHARAT HEAVY ELECTRICALS LTD.
TRANSMISSION BUSINESS GROUP, NEW DELHI.
Conditions of Contract for Erection Works, Rev-02

E.3.5 The complete erection shall be performed in accordance with the modern practices for similar substation equipments.

E.4.0 **EQUIPMENT, MATERIAL & SERVICES TO BE FURNISHED**

E.4.1 The contractor shall employ sufficient labours, skilled, unskilled, supervisory and administrative personnel for timely and effective execution of the contract.

E.4.2 The contractor shall arrange as per Annexure - Q erection tools and tackles, mobile crane, all transport vehicles, measuring & testing equipments necessary for timely and effectively execution of the contract. All measuring & testing instruments shall be pre-calibrated through a certifying agency before use. The certificate of calibration shall be submitted to Engineer for records. In case Contractor is unable to provide the calibrated measuring and test instruments then 'ENGINEER' according to his own wisdom / judgement can recommend a deduction of maximum limit up to 5% from the Contractor's bill. But this in no way relieves the Contractor from arranging the test & measuring instruments / equipment as required for completion of work without affecting the quality of work and meeting any Contractual obligation whatsoever.

E.4.3 All equipment including individual component fittings and accessories shall be properly stored at site so as to obviate any deterioration of electrical properties and mechanical damages.

E.4.4 All equipment shall be thoroughly cleaned of packing materials, scales rust, oil grease etc. prior to commencement of the installation work.

E.4.5 All equipment shall be checked physically for the completeness of all components and devices before taking up installation.

E.4.6 The contractor shall repair all minor defects in equipment, free of charge, if required prior to installation in consultation with equipment manufacturer of BHEL, so that manufacturer's guarantee is not affected in any way. In case of any major damage to the equipments, the same shall be rectified or replaced by the manufacturer's representatives with the approval of BHEL / Owner.

BHARAT HEAVY ELECTRICALS LTD.
TRANSMISSION BUSINESS GROUP, NEW DELHI.
Conditions of Contract for Erection Works, Rev-02

- E.4.7 All equipments and accessories shall be installed strictly in accordance with the manufacturer's instructions / drawings. Equipment supplied in sections or in dismantled conditions shall be re-assembled at site with all associated accessories as per manufacturer's instructions.
- E.4.8 If the services of BHEL engineers, suppliers, and / or of any equipment manufacturers are required by the contractor at any stage of work, it will be made available on chargeable basis at existing rates prevailing at that time.
- E.4.9 All consumable items required to carry out welding, brazing, soldering etc. for the erection and commissioning is included in the offer of contractor and shortages in hardware (due to careless / negligent handling at site) to be made up free of cost by the contractor. The quality of such replenishment shall be at par with main supply and to be acceptable to BHEL / Owner.
- E.4.10 The successful contractor should note that after execution of work they will send marked up drawings "as erected" drawings to Project Manager at site for preparation of firm "AS BUILT" drawings. "AS BUILT" drawings will bear the signature of Project Manager of BHEL and Contractor's representative.
- E.4.11 **OIL FILTRATION (IN CASE OF TRANSFORMERS COVERED IN BOQ):**

An extra high vacuum oil filtration plant with a minimum of thousand GPH capacity shall be employed by the contractor for oil filtration.

An empty oil tank of minimum of 12000 ltrs. capacity also shall be arranged by the contractor to prepare the oil before pushing it into the transformer.

BHARAT HEAVY ELECTRICALS LTD.
TRANSMISSION BUSINESS GROUP, NEW DELHI.
Conditions of Contract for Erection Works, Rev-02

E.5.0 TESTING AND COMMISSIONING OF EQUIPMENT:

- E.5.1 The testing of all electrical equipment as well as the system as a whole shall be carried out to ensure that the equipment and its components are in satisfactory condition and will successfully perform its functional operation. All required tests shall be carried out by the contractor using his own instruments, testing equipments as well as qualified testing personnel. The tests on power transformer (if covered in BOQ) shall include winding resistance, tan-delta, PPM of moisture, acidity in oil. For SF-6 Circuit Breaker (if covered in BOQ) closing and tripping timing test shall also be carried out in addition to other routine tests.
- E.5.2 At site all equipments shall be energised only after certification by the personnel performing the test that the equipment is ready for energising and with the concurrence of BHEL / Owner.

E.6.0 PREPARATION FOR COMMISSIONING:

- E.6.1 After completion of the installation at site and for the preparation of system commissioning the contractor shall carry out checking and testing of all equipment and installation in accordance with the agreed standards, codes of practices of Indian Standards Institutions and specific instruction furnished by the particular equipments suppliers as well as the Owner.
- E.6.2 Required checking to be made on all equipment and installation at site. This shall include but not limited to the following:
- a) Physical inspection for removal of any foreign bodies external defects such as damaged insulators, loose connecting bolts, loose foundation bolts etc.
 - b) Check for grease insulating / lubricating oil leakage and its proper level / quantity.
 - c) Check for free movement of mechanism of the circuit breaker / isolator and rotating parts of other rotating machine and devices.
 - d) Check for tightness of all the cables, busbars as well as earth connection in the main earthing net work.
 - e) Check for clearance of live busbar and conductors from the metal enclosures.
 - f) Continuity check in case of power and control cables.

**BHARAT HEAVY ELECTRICALS LTD.
TRANSMISSION BUSINESS GROUP, NEW DELHI.**

Conditions of Contract for Erection Works, Rev-02

- g) Checking of all mechanical and electrical interlocks, including tripping of breakers using manual operation of relay.
 - h) Checking of alarm and annunciation circuits by manual actuation of relevant relays like buchholz relay in case of transformer.
 - i) Check and calibrate devices requiring field adjustments / calibration like adjustment of relay setting etc.
 - j) Check proper connection to earth-mat work of all non current carrying parts of equipments & installation.
- E.6.3 All the measuring and testing instruments will be arranged by the contractor and while submitting his quotation he shall furnish list of testing equipments which are readily available with him and also which can be procured by him from outside agency for the purpose of testing and commissioning.
- E.7.0 **MINOR CIVIL WORK:**
- E.7.1 Minor civil works including secondary grouting/under pinning of structure i.e. filling the gap between structure and foundation after levelling, alignment shall be done by the contractor at no extra cost. This shall also include necessary materials required for doing the work.
- E.7.2 Minor civil works of final / secondary grouting of structures, towers equipment has to be arranged by the contractor and the rate for the same should be included in respective erection. Final / secondary grouting means filling the gap between the structure and foundation after levelling, alignment etc.
- E.7.3 Minor civil work shall also include fixing of foundation bolts for radiator / cooling oil pump etc. Foundation bolts for such work shall however be arranged by BHEL.

BHARAT HEAVY ELECTRICALS LTD.
TRANSMISSION BUSINESS GROUP, NEW DELHI.
Conditions of Contract for Erection Works, Rev-02

E.8.0 **PRICE SCHEDULE**

E.8.1 The prices to be quoted FIRM and should be valid till the work is completed to the satisfaction of BHEL / Owner and handed over the system to Owner.

E.8.2 The quantities given in schedule of equipment are estimated ones and may vary up to $\pm 30\%$ on the total value of the contract. Quantity of individual item may vary up-to any extent.

E.9.0 **START OF WORK AND COMPLETION SCHEDULE**

E.9.1 The contractor shall mobilise at site within one week from the date of LOI.

E.9.2 The entire work under this tender is required to be completed as indicated in Letter of Intent.

E.9.3 Detailed Bar Chart (activity schedule) should be submitted by the bidder in Annexure 'M' showing as to how the work is proposed to be executed in order to meet the completion schedule. This shall be filled in by the bidder after mobilisation at site and to be given to ENGINEER-IN-CHARGE at site.

E.9.4 The contractor is required to commence the work within the time as indicated in Letter of Intent failing which the contract is liable to be cancelled and EMD/SD shall be forfeited.

E.10.0 **SCHEDULE OF EQUIPMENT:**

The estimated quantities in the Schedule of Equipment given in Annexure-1 is tentative to give idea of work and to enable tenderer to quote unit rates. The actual quantities required to be erected shall be based on relevant drawings and latest revisions.

Annexure to conditions of contract for ETC Works

REF No. TBSM/33KV CABLE/ETC/TENDER/26-27

Date : 07.05.2026

SUB : INSTALLATION, TESTING & COMMISSIONING OF 19/33 KV (E), 1C × 500 SQ. MM AL. CONDUCTOR, XLPE INSULATED, ARMoured MV POWER CABLE — BETWEEN ENNORE SEZ TPS MAIN PLANT AREA TO SEA WATER INTAKE PUMP HOUSE (OUTSIDE PLANT BOUNDARY, APPROX. 4 KM ROUTE LENGTH) ON CABLE TRENCH / VERTICAL SUPPORT / PIER-MOUNTED CABLE TRAY (AT HEIGHTS RANGING FROM APPROX. 5.0 M TO 12.5 M ABOVE GROUND LEVEL) / CABLE TRESTLE AT ENNORE SEZ PROJECT IN TAMIL NADU.

The following terms and conditions shall form a part of the tender document. If any discrepancies found between below mentioned clauses and clauses in the General Conditions of Contract for ETC Works (Document No. TB-ETC-GCC, Rev-02) Annexure to conditions of contract for ETC Works the clauses mentioned in this annexure shall prevail.

A1 GENERAL INSTRUCTION

A1.1 All pages of the tender documents shall be duly signed, stamped and submitted along with the offer in token of complete acceptance thereof. The information furnished shall be complete by itself. The tenderer is required to furnish all the details and other documents as required in the following pages.

A1.2 Tenderers are advised to study all the tender documents carefully. Any submission of tender by the tenderer shall be deemed to have been done after careful study and examination of the tender documents and with the full understanding of the implications thereof. Should the tenderers have any doubt about the meaning of any portion of the Tender Specification or find discrepancies or omissions in the drawings or the tender documents issued are incomplete or shall require clarification on any of the technical aspect, the scope of work etc., tenderer shall at once, contact the authority inviting the tender well in time (so as not to affect last date of submission) for clarification before the submission of the tender. Tenderer's request for clarifications shall be with reference to Sections and Clause numbers given in the tender documents. The specifications and terms and conditions shall be deemed to have been accepted by the tenderer in his offer. Non-compliance with any of the requirements and instructions of the tender enquiry may result in the rejection of the tender.

A2 PROCEDURE FOR SUBMISSION OF SEALED TENDERS

A2.1 Bidders may please refer Cl no. 2 to Cl no. 4 of the Notice inviting tender.

A2.2 The tenders received after the specified time of their submission shall be treated as 'Late Tenders' and shall not be considered under any circumstances.

A2.3 Tenders shall be opened by the officers concerned of BHEL at the time, date and venue as specified in the tender enquiry. Tenderer or their authorized representative may witness the bid opening.

A2.4 The tenderer shall closely pursue all the clauses, specifications and drawings indicated in the Tender Documents before quoting. Should the tenderer have any doubt about the meaning of any portion of the Tender Specifications or find discrepancies/omission in the drawings or the tender documents issued are incomplete or shall require clarification on any of the technical aspect, scope of work etc. he shall at once contact the authority inviting the tender for clarification before the submission of the tender.

A2.5 Before submission of offer, the tenderers are advised to inspect the work & the environments and be well acquainted with the actual working and other prevalent conditions, facilities available, sourcing of material and labour, means of transport and access to site, accommodation, etc. No claim will be entertained later on the grounds of lack of knowledge on any of these conditions/ resources.

A2.6 Tenderer must fill up all the schedules and furnish all the required information as per the instructions given in various sections of the tender specification. Each and every page of the Tender Specification must be SIGNED AND SUBMITTED ALONG WITH THE OFFER by the Tenderer in token of complete acceptance thereof the information furnished shall be complete by itself.

A2.7 The tenderer shall quote the rates in English Language and international numerals. Total price offered should be entered in figures as well as in words. For the purpose of the tender, the metric system of units shall be used.

A2.8 The tenderer shall quote a percentage above/ below/At Par the rates shown in the "Bill of Quantities Cum Price Schedule (Annexure-I)" of subject tender.

A2.9 The quoted percentage will apply to the individual items of "Annexure-I i.e Bill of Quantity Cum Price Schedule" uniformly.

A2.10 All entries in the tender shall either be typed or be written legibly in ink. Erasing and overwriting are not permitted and may render such tender liable for rejection. All cancellations and insertions shall be duly attested by the tenderer.

A2.11 The tenderer must provide the registered e-mail of their registered office along with the addresses and authorised phone/mobile nos.

A3 ADJUSTMENT PRICE DISCREPANCY (IES):

A3.1 Not Applicable being e procurement

A4 EVALUATION OF TECHNICAL BIDS

A4.1 Technical Bids submitted by the tenderer will be opened first and evaluated for fulfilling the Pre-Qualification criteria and other conditions in NIT/Tender documents, based on documentary evidences submitted along with the offer.

A4.2 In case the same qualifying experience is claimed by more than one bidder due to subletting of work by main contractor to subcontractor (s) then following conditions shall be applicable.

(a) For labour + consumable contract without material and T&P:

Benefit of work experience shall be given to the subcontractor who has actually executed job and not to the contractor offloaded down the line.

(b) For contract with complete scope i.e. with materials, T&P, labour and consumable:

(i) Benefit of work experience shall be given to the subcontractor who has actually executed job and not to the contractor offloaded down the line.

(ii) If the contractor offloads the labour and/or T&P portion only, benefit of work experience shall be given to the main contractor and not to the subcontractor who has executed only as labour supply contractor

The bidder's qualification shall be subject to submission of documentary proof. BHEL reserves the right to ask for further proofs including submission of TDS certificates/ for the said job

A4.3 In case the qualifying experience is claimed by private organizations based on Work Order and completion certificates from another private organization, BHEL reserves the right to ask for further proofs including submission of TDS certificates/ form 26AS /bills for the said job.

A4.4 Credentials of all the bidders participating in open tender will be scrutinized thoroughly by the nominated committee w.r.t. the pre-qualifying requirement for the tender.

A4.5 Details of qualifying work(s) executed by the bidder will be forwarded to the principle employer for verification of the work with respect to completion, commencement & completion date, scope and value of the work executed. Performance feedback of the bidder will also be sought from the principle employer.

A4.6 BHEL may conduct onsite verification of at least one of the qualifying works to verify completion of the work and evaluate capability and performance of the bidder.

A4.7 The bidder representative may be called for the discussion with the committee. His originals may be verified by the committee. In addition to above their organization chart and detailed list of manpower, tools & plants and technical capability may be discussed and ascertained by the committee.

A5 EVALUATION OF PRICE BIDS

A5.1 Price Bids of unqualified bidders shall not be opened.

A5.2 The offers will be evaluated on the basis of total price basis (refer "BILL OF QUANTITY AND PRICE SCHEDULE) as shown in the price bid.

A5.3 Reasons for rejection of the bid shall be intimated in due course after issue of LOI/LOA to successful bidder and receipt of unconditional acceptance of LOI /LOA from the successful bidder

A5.4 In case of electronic Reverse Auction, the unqualified bidders shall not be allowed to participate in reverse auction. - N.A.

A6 DOCUMENTS TO BE ENCLOSED:

Full information shall be given by the tenderer in respect of the following.

A6.1 Tenders shall be signed by persons duly authorized/empowered to do so. An attested copy of the Power of Attorney to be submitted in all cases except where the sole proprietor is the signatory to the tender documents

A6.2 PERMANENT ACCOUNT NUMBER:

Certified copies of Permanent Account Numbers as allotted by Income Tax Department for the Company / Firm / Individual Partners, etc. shall be furnished along with tender.

A6.3 AUDITED BALANCE SHEET AND INCOME TAX RETURN:

Copy of Audited Balance sheets and income tax return for last three financial years (financial years as specified in PQR)

A6.4 SOLVENCY CERTIFICATE:

If asked in NIT, bidder should submit solvency certificate (not older than 12 months from date of tender notification) issued by any scheduled bank.

A6.5 DOCUMENT RELATED TO INCORPORATION OF BUSINESS ENTITY:

(i) IN CASE OF INDIVIDUAL TENDERER:

His/her full name, address and place & nature of business.

(ii) IN CASE OF PARTNERSHIP FIRMS:

The names of all the partners with address. A copy of the partnership deed/instrument of partnership duly certified by the Notary shall be enclosed.

(iii) **IN CASE OF COMPANIES:**

Date & place of registration including date of commencement certificate in case of Public Companies and the nature of business carried on by the company. Certified copies of Memorandum and Articles of Association are also to be furnished.

A6.6 **OFFER FORWARDING LETTER (over the letterhead)**

A6.7 **DECLARATION SHEETS** (As per Prescribed format) over the letter head

A6.8 **NO DEVIATION CERTIFICATE** (As per Prescribed format) over the letterhead

A6.9 **GST REGISTRATION CERTIFICATE**

All the data required to be enclosed with the tender need to be furnished neatly typed, signed & stamped in the given formats only (in the form of separate sheets) failing which the tender may be considered as incomplete and is liable for rejection. Documentary proof wherever necessary also need to be enclosed.

A7 VALIDITY OF OFFER

The rates in the Tender shall be kept valid for acceptance for a minimum period of Four Months from latest due date of offer submission (including extension(s), if any). In case BHEL (Bharat Heavy Electricals Limited) calls for negotiations, such negotiations shall not amount to cancellation or withdrawal of the original offer which shall be binding on the tenderer.

A8 REJECTION OF TENDER & OTHER CONDITIONS:

- 1 The decision of acceptance of tender will rest with BHEL which does not bind itself to accept the lowest tender or any tender and reserves to itself full rights for the following without assigning any reasons whatsoever:
 - (a) To reject any or all of the tenders.
 - (b) To split up the work amongst two or more Tenderer as per NIT
 - (c) To award the work in part as per NIT
 - (d) In either of the contingencies stated in (b) and (c) above to modify the time for completion suitably.
- 2 Conditional tenders, unsolicited tenders, containing abnormally low/ unworkable rates & amounts, tenders which are incomplete or not in the form specified or defective or have been materially altered or not in accordance with the tender conditions, specifications etc. are liable to be rejected.
- 3 Tenders are liable to be rejected in case of unsatisfactory performance of the tenderer with BHEL, or tenderer under suspension (hold / banning / delisted) by any unit / region / division of BHEL or tenderers who do not comply with the latest guidelines of Ministry / Commissions of Govt. of India. BHEL reserves the right to reject a bidder in case it is observed that they are overloaded and may not be in a position to execute this job as per the required schedule in line with 'NIT'. The decision of BHEL will be final in this regard.
- 4 In case of any adverse information is received concerning performance, capability or conduct of the tenderer after issue of tender enquiry or opening of tender or award of work, BHEL reserves the right to reject the offer at any stage as deemed fit.
- 5 Offers with inadequate Tools & Plants, Manpower Deployment Plan, and Method Statement are liable for rejection.
- 6 If a tenderer who is a proprietor expires after the submission of his tender or after the acceptance of his tender, BHEL may at its discretion, cancel such tender. If a partner of a firm expires after the submission of the tender or after the acceptance of the tender, BHEL may cancel such tender at its discretion unless the firm retains its character.
- 7 BHEL will not be bound by any Power of Attorney granted by the tenderer or by changes in the composition of the firm made subsequent to the execution of the contract. BHEL may, however, recognise such Power of Attorney and changes after obtaining proper legal advice, the cost of which will be chargeable to the contractor concerned.
- 8 If the tenderer deliberately gives wrong information in his tender, BHEL reserves the right to reject such tender at any stage or to cancel the contract, if awarded, and forfeit the Earnest Money/Security Deposit/any other moneys due.
- 9 Canvassing in any form in connection with the tender is strictly prohibited and the tenders submitted by the tenderer who resorts to canvassing are liable to be rejected.
- 10 In case the Proprietor, Partner or Director of the Company / Firm submitting the Tender, has any relative or relation employed in BHEL, the authority inviting tender shall be informed to the fact as per specified format along with the offer, failing this, BHEL may, at its sole discretion reject the tender or cancel the contract and forfeit the Earnest Money/ Security Deposit.
- 11 The successful tenderer should not sub-contract the part or complete work detailed in the tender specifications without written permission of BHEL's Site In charge/ Sector Head. For this the contractor shall submit request application to site in charge supported by credentials (financial and technical) and resource mobilisation schedule of such sub-contractor. Such request is to be considered in consultation with end user/ultimate customer (if applicable) and subject to satisfactory credentials, fund flow arrangement between them, HSE and other contractual and statutory obligations. The tenderer is solely responsible to BHEL for the work awarded to him.
- 12 The Tender submitted by a tenderer shall become the property of BHEL who shall be under no obligation to return the same to the bidder. However unopened price bids and late tenders shall be returned to the bidders.

- 13 unsolicited discount received after the due date and time of Bid Submission shall not be considered for evaluation. However, if the party who has submitted the unsolicited discount/rebate becomes the L-I party, then the awarded price i.e contract value shall be worked out after considering the discount so offered.
- 14 BHEL shall not be liable for any expenses incurred by the bidder in the preparation of the tender irrespective of whether the tender is accepted or not.

A9 NO DEVIATIONS ARE ACCEPTABLE:

Offers with deviations are likely to be rejected. However, if the bidder insists on any technical or commercial deviations from the specifications and / or tender conditions, the price implication, if any, of withdrawing the deviations must be submitted along with the price bid in a separate sealed envelope super-scribed "PRICE IMPLICATION FOR WITHDRAWAL OF DEVIATIONS". No price implication for withdrawal of deviation shall be accepted at a later date, after opening of technical bid.

A10 CONSORTIUM / JV BIDDING

Consortium/ JV bidding is not allowed under this NIT.

B EARNEST MONEY DEPOSIT (BID SECURITY): Not Applicable

C SECURITY DEPOSIT

Security Deposit means the security provided by the Contractor towards fulfilment of any obligations in terms of the provision of the contract.

- 1 Upon acceptance of Tender, the successful Tenderer should deposit the required amount of Security Deposit for satisfactory completion of work. The total amount of Security Deposit will be 5% of the Contract Value. EMD of the successful tenderer shall be converted and adjusted towards the required amount of Security Deposit.

2 Mode of Security deposit:

The security Deposit should be furnished before start of the work by the contractor.

"Bidders agrees to submit performance security required for execution of the contract within the time period mentioned. In case of delay in submission of Performance security, enhanced performance security which would include interest (Repo rate + 4%) for the delayed period, shall be submitted by the bidder.

Further, if performance security is not submitted till such time the first bill becomes due, the amount of performance security due shall be recovered as per terms defined in NIT / Contract, from the bills along with due interest".

The balance amount to make up the required Security Deposit of 5% of the contract Value may be furnished in any of the following forms:

- i) Cash (as permissible under the extant Income Tax Act)
- ii) Local cheques of scheduled banks (subject to realization) / Pay Order / Demand Draft / Electronic Fund Transfer, in favour of BHEL.
- iii) Bank Guarantee from Scheduled Banks / Public Financial Institutions as defined in the Companies Act. The Bank Guarantee format for Security Deposit shall be in the prescribed formats enclosed with general conditions of contract.
- iv) Fixed Deposit Receipt issued by Scheduled Banks / Public Financial Institutions as defined in the Companies Act. The FDR should be in the name of the contractor, A/C BHEL and duly discharged on the back.
- v) Securities available from Indian Post Offices such as National Savings Certificates, Kisan Vikas Patras etc. (Certificates should be held in the name of Contractor furnishing the security and duly endorsed/hypothecated/pledged, as applicable, in favour of BHEL and duly discharged on the back).
- vi) Insurance Surety Bonds.

(NOTE: BHEL will not be liable or responsible in any manner for the collection of interest or renewal of the documents or in any other matter connected therewith)

3 Submission of Security Deposit:

- i) At least 50 % of the required Security Deposit shall be submitted before start of work. Balance of the Security Deposit can be submitted by way of deduction of 10% of the gross amount progressively from each running bills of the contractor till the total amount of the required Security Deposit is collected.
- ii) In case of delay in submission of performance security, enhanced performance security which would include interest (Repo rate + 4%) for the delayed period, shall be submitted by the bidder.
- iii) If the value of work done at any time exceeds the contract value, the amount of Security Deposit shall be correspondingly enhanced and the additional Security Deposit shall be immediately deposited by the Contractor or it shall be recovered from payment/s due to the Contractor.

- iv) The recoveries made from running bills (cash deduction towards balance SD amount) can be released against submission of equivalent Bank Guarantee in acceptable form, but only once, before completion of work, at the discretion of BHEL.
- 4 The BG shall be submitted only through the Banker. Along with the BG, the Bank shall also furnish a letter of confirmation (in the prescribed formats enclosed with general conditions of contract).
- 5 The validity of the Bank Guarantee furnished towards Security Deposit shall be up to three months more than the period of completion of work as stipulated in the LOI and the same will be kept valid by proper renewal till the completion of the work.
- 6 BHEL reserves the right of forfeiture of Security Deposit in addition to other claims and penalties in the event of the contractor's failure to fulfil any of the contractual obligations or in the event of termination of contract as per terms and conditions of the contract. BHEL reserves the right to set off the Security Deposit, against any claims of any other contracts with BHEL.

7 Conditions for acceptance of bank guarantees

Contractors are advice to obtain Bank Guarantee preferably from any of the following BHEL consortium banks

Sl. No.	Name of Bank	Sl. No.	Name of Bank
1	State Bank of India	11	Punjab National Bank
2	Canara Bank	12	Union Bank of India
3	IDBI Bank Limited	13	Yes Bank Limited
4	ICICI Bank Limited	14	RBL Bank Ltd.
5	HDFC Bank Limited	15	Standard Chartered Bank
6	Axis Bank	16	Indian Overseas Bank
7	IndusInd Bank Limited	17	Kotak Mahindra Bank Limited
8	Bank of Baroda	18	Federal Bank Limited
9	Exim Bank	19	Hongkong and Shanghai Banking Corporation Ltd
10	Indian Bank		

Bank Guarantees from Banks outside BHEL's consortium shall be as below:

- The Bank Guarantees of all Public sector banks can be accepted (in addition to consortium banks)
- The Bank Guarantees of Co-operative banks shall not be accepted.
- Bank Guarantees of other than consortium bank and public sector bank can be accepted subject to an overall exposure limit (at New Delhi) of Rs. 10 crores for banks with net worth of more than Rs. 500 crores as on last balance sheet date and Rs 5 crores for banks with net worth between Rs. 350 to Rs 500 crores (A certificate and copy of latest Balance Sheet to be given by the Bank at the time of submission of Bank Guarantees).
- In case of private sector banks, a clause to be incorporated in the text of Bank Guarantee that it can be enforceable by being presented at any branch of the bank.
- In case of foreign vendors, the bank guarantees issued by foreign banks may be confirmed by our consortium bank in India.
- In case of Bank Guarantees given by Non-Consortium banks (Private sector or Public sector), the Bank Guarantees are to be enforceable in New Delhi or the town/ city in which the sector office is located

8 Return of Security Deposit

If the contractor duly performs and completes the work in all respects to the entire satisfaction of BHEL and presents an absolute "No demand certificate", returns properties belonging to BHEL, taken, borrowed or hired by him for carrying out the said works, and furnishes performance bond BG in the prescribed proforma, Security Deposit will be released to the contractor after deducting all costs, expenses and other amounts that are to be paid to BHEL under this contract or other contracts entered into with the contractor.

It may be noted that in no case the Security Deposit shall be refunded/released prior to passing of final bill.

D BANK ACCOUNT DETAILS FOR SUBMISSION OF SECURITY DEPOSIT

Bank Account Details for submission of Security Deposit through electronic fund transfer mode.

NAME OF THE COMPANY	BHARAT HEAVY ELECTRICALS LTD
ADDRESS OF THE COMPANY	TRANSMISSION BUSINESS GROUP, PLOT NO. 25, SECTOR- 16A,
NAME OF BANK	STATE BANK OF INDIA
NAME OF BANK BRANCH	CAG-II NEW DELHI (17313)
CITY	NEW DELHI
ACCOUNT NUMBER	00000030206227732
ACCOUNT TYPE	CASH CREDIT
IFSC CODE	SBIN0017313

E PAYMENT TERMS:

Clause No. C.2.0 of GCC stands deleted. Now this clause shall be read as below.

(Description of work in this section is made for payment purpose only and the scope is not limited to the activities mentioned below. Please refer technical documents for complete scope of work)

- 1 No Mobilization Advance shall be paid.

2 For BOQ items- Sr. No. 1 to 4 – Erection, Testing and Commissioning (Category-A1):

- i) 10% of the contract item price on the monthly progressive bills on pro rata basis for receipt, material including arranging crane for unloading, maintaining proper records of receipt & storage in Field Quality Plans (FQPs) and as certified by BHEL Engineer. In case of power transformer/reactors, 5% amount shall be paid after unloading and 5% after dragging main tank in position on foundation. The subitems mentioned in transformer/ reactor shall be consider for payment with main item.
- ii) 60% of the contract item price on the monthly progressive bills on pro rata basis after arranging necessary calibrated tools/tackles required for erection, submitting calibration reports, qualification/experience certificates of welder/ Electrician/other staff, levelling, alignment, tightening and completion of erection including maintaining proper records of installation in FQPs and as certified by BHEL, Engineer.
- iii) 10% of the contract item price on the monthly progressive bills on pro rata basis on arranging calibrated testing equipment, submission of calibration reports, testing of equipment including maintaining proper records of testing in FQPs and as certified by BHEL, Engineer. BOQ items, which are not required to be tested as per FQP, shall be qualified for release of payment on prorated basis after completion of testing of all equipment's of corresponding bay (As per SLD/layout).
- iv) 10% of the contract item price after completion of satisfactory commissioning and submission of complete records of erection/testing/commissioning /charging protocol as per FQPs for the corresponding bay.
- v) Last 10% of the contract item price after all test reports as per contract are jointly witnessed and signed by BHEL/customer, "As Built" changes are incorporated in relevant drawings, material reconciliation and substation is handed over to the Owner / Customer. If the contract is for more than one sub-station, then the same will be released after successful handing over of each sub-station. If for any reason, the handing over is delayed for reasons beyond the control of the contractor, in such case this payment will be released against commissioning certificate issued by the BHEL / customer and against submission of final bill of individual substation.

3 For BOQ items - Sl. Nos. 7 to 9 & 12 to 14 (Category-A2)- Complete Erection works.(Category-A2):

- i) 10% of the contract item price on the monthly progressive bills on pro rata basis for receipt, material including arranging crane for unloading, maintaining proper records of receipt & storage in Field Quality Plans (FQPs) and as certified by BHEL Engineer. In case of power transformer/ reactors, 5% amount shall be paid after unloading and 5% after dragging main tank in position on foundation. The sub-items mentioned in transformer/ reactor shall be consider for payment with main item.
- ii) 80% of the contract item price on the monthly progressive bills on pro rata basis after arranging necessary calibrated tools/tackles required for erection, submitting calibration reports, qualification/experience certificates of welder/Electrician/other staff, levelling, alignment, tightening and completion of erection including maintaining proper records of installation in FQPs and as certified by BHEL, Engineer.
- iii) Last 10% payment shall be released as per E.2.v above.

4 For BOQ item: - Sl. Nos.: 5 (Category-A3) (Testing and Commissioning work):

- i) 50% of the contract item price on the monthly progressive bills on pro rata basis on arranging calibrated testing equipment, submission of calibration reports, testing of equipment including maintaining proper records of testing in FQPs and as certified by BHEL, Engineer. BOQ items, which are not required to be tested as per FQP, shall be qualified for release of payment on prorated basis after completion of testing of all equipment's of corresponding bay (As per SLD/layout).
- ii) 30% of the contract item price after completion of satisfactory commissioning and submission of complete records of testing/commissioning /charging protocol as per FQPs for the corresponding bay.
- iii) 10% of the contract item price after overall system commissioning and submission of complete records of testing/commissioning /charging protocol as per FQPs for the complete substation.
- iv) Last 10% payment shall be released as per E.2.v above.

5 For BOQ item: - Sl. Nos. 6, 10 & 11 (Category-B) (Supply in contractor's scope):

- i) 80% of the contract item price on the monthly progressive bills on prorated basis after supply, receipt of the material at site, unloading, proper storage and as certified by site in charge.
- ii) 10% of the contract item price on the monthly progressive bills on prorated basis after material erection as certified by BHEL site In-charge on prorated basis after erection.
- iii) Last 10% payment shall be released as per E.2.v above.

F OVERALL QUANTITY VARIATION

The individual quantity can vary to any extent or may be deleted for which no compensation will be payable to the contractor and **the rates will remain firm**. Also, the rate of each item remains firm as long as the variation in the total value of work executed under the contract including extra items if any remains within plus/minus 30 percent of the contract value. In case the actual value of executed work including extra work on completion of work becomes less than 70% of the basic/original contract value than the following method shall be adopted.

The actual executed value shall be raised by 7 % (For arriving at the final payment against work executed) subject to the condition that total value of work executed plus increase by 7% as above shall be limited to 70% of the basic/original contract value. The rate quoted shall be firm irrespective of any upward variation in the contract price.

G OVERRUN COMPENSATION

Not applicable

H TAXES AND DUTIES

Clause No. C.30.0 "INCOME TAX/SALES TAX/WORKS TAX/VAT" stands deleted. Now this clause shall be read as below.

- 1 All taxes (except GST), duties, charges, royalties, cess and any other levies by Central/ State/local authorities for the execution of the contract shall be borne by the contractor and shall not be payable extra.
Any increase of the same at any stage during execution of the contract shall be borne by the contractor.
Quoted price of the same shall be inclusive of all such requirements.
- 2 GST along with Cess (as applicable) legally leviable & payable by successful bidder as per GST Law shall be paid by BHEL, extra.

Hence, bidder shall not include GST along with Cess (as applicable) in their quoted rates/ price.

- 3 Contractors have to make their own arrangement at their cost for completing the formalities, if required with relevant taxation authorities, for bringing their material, plant and machinery at site for the execution of the contract. Road permits / way bill, if required shall be arranged by the contractor
- 4 Contractor shall furnish proof of GST registration with GSTN Portal covering the services under this contract.

Registration should also bear endorsement for the premises from where the billing shall be done by contractor on BHEL for this project / work

However, in case contractor submits GST Registration of a state other than the state wherein the site is located, then contractor has to submit an undertaking that contractor is not liable to take registration in the state wherein the site is located as per the provision of Place of Supply under CGST/SGST/IGST Act.

BHEL will not be held responsible for any non-compliance of the Contractor in respect of GST laws as framed from time to time.

- 5 Contractor shall comply with all statutory amendment/notifications in this respect

Contractor shall submit the tax invoice complying with GST Invoice Rules (Section 31 of GST Act & Rules referred thereunder).

In case of raising any Supplementary Tax Invoice (Debit / Credit Note), contractor shall issue the same containing all the details as referred in Section 34 read with Section 31 of GST Act & Rules referred there under.

Contractor shall comply with the Time Limit prescribed under the GST Law and rules thereof for raising the Tax Invoice.

- 6 Goods and Service Tax (GST) will be reimbursed to the Contractor subject to the following conditions: -
 - I) Submission of valid GST Compliant Tax Invoice as per the GST Invoice Rules.
 - II) The Invoice raised by the Contractor should indicate the BHEL GST Registration Number.)
 - III) Contractor shall upload the invoices raised on BHEL in IFF/GSTR-1 within the prescribed time as given in the GST Act.
 - IV) Invoice raised and uploaded in IFF/GSTR-1 by the Contractor should be available to BHEL in FORM GSTR-2B electronically through the common portal.
 - V) Confirmation of payment of such GST to the Government through filing of GSTR-3B of corresponding month/quarter.
- 5 The GST amount should get reflected within prescribed time limit in the GSTN for BHEL to avail the input credit. If the GST Credit is reversed/ denied/ delayed to BHEL due to non-receipt/delayed receipt of Services and/or tax invoice or due to expiry of timeline prescribed in GST law or due to any other factor for availing such Input Tax Credit (ITC) or for any other reason arising out of the act directly attributable to the Contractor, GST amount shall be recoverable from Contractor from any dues payable to the Contractor along with any interest levied/ leviable on BHEL.
- 6 Statutory variation, if any, on account of GST will be payable by BHEL at actuals on submission of documentary evidence variation, if any, on account of GST will be payable by BHEL at actuals on submission of documentary evidence.

7 TDS under Income Tax Act/ GST Act shall be deducted as per applicable rates unless Exemption certificate, if applicable, from the appropriate Authority is furnished to BHEL along with the Invoice.

8 New Taxes & duties (Introduced after tender opening date):

If any new tax or duty is levied by the Central/State Government/Municipality/Local Authority and becomes directly applicable on items specified in the Bill of Quantities, full reimbursement shall be made subject to submission of documentation as per statute.

I BOCW (TAXES, DUTIES & LEVIES):

BUILDING & OTHER CONSTRUCTION WORKERS (REGULATION OF EMPLOYMENT AND CONDITIONS OF SERVICE) ACT, 1996 (BOCW Act) AND RULES OF 1998 READ WITH BUILDING & OTHER CONSTRUCTION WORKERS CESS Act, 1996 & CESS RULES, 1998.

In case any portion of work involves execution through building or construction workers, then compliance to the above titled Acts shall be ensured by the contractor and contractor shall obtain license and deposit the cess under the Act. In the circumstances it may be ensured as under:

- 1 It shall be the sole responsibility of the contractor in the capacity of employer to forthwith (within a period of 15 days from the award of work) apply for a licence to the Competent Authority under the BOCW Act and obtain proper certificate thereof by specifying the scope of its work. It shall also be responsibility of the contractor to furnish a copy of such certificate of licence / permission to BHEL within a period of one month from the date of award of contract.
- 2 It shall be the sole responsibility of the contractor as employer to ensure compliance of all the statutory obligations under these act and rules including that of payment / deposit of 1% cess on gross payment made for value of work involving building or construction workers engaged by the contractor within a period of one month from the receipt of payment.
- 3 It shall be the responsibility of the sub-contractor to furnish the receipts / challans towards deposit of the cess together with the number, name and other details of beneficiaries (building workers) engaged by the sub-contractor during the preceding month.
- 4 It shall be the absolute responsibility of the sub-contractor to make payment of all statutory payments & compensations to its workers including that is provided under the Workmen's Compensation Act, 1923.
- 5 The contractor shall, however ensure before deposit of any BOCW cess, that customer is not depositing the same in order to avoid excess deposit of cess.
- 6 The contractor shall bear cost of BOCW cess either by way of deposit or through recovery by BHEL in case the same is deposited by the customer.
- 7 In case of failure in above mentioned compliances, BOCW Cess @ 1% as well as applicable penalty as specified in BOCW Act/Rules shall be deducted from the contractor
- 8 **NOTE:** Any labour law or statutory compliance enacted or brought into force by the applicable government during the term of this contract shall be deemed applicable to this contract.

J DELAY AND EXTENSION OF TIME

- 1 If, in the opinion of the Engineer, the work is delayed:
 - i) (by reason of abnormally bad weather, or
 - ii) by reason of serious loss or damage by fire, or
 - iii) by reason of civil commotion, local combination of workmen, strike or lockout, affecting any of the trades employed on the work, or
 - iv) delay on the part of the agency or tradesman engaged by the BHEL in executing work not forming part of the contract, or
 - v) By reason of any other cause which in the absolute discretion of the Engineer is beyond the contractor's control, then in any such case, the Engineer (or higher authority) may make fair and reasonable extension in the completion dates of the individual items of work of the contract as whole. Such extension which will be communicated to the contractor by the Engineer in writing shall be final and binding on the contractor. No other claim in this respect for compensation, idle labour or otherwise howsoever is admissible. Upon the happening of any such event causing delay the contractor shall immediately give notice thereof in writing to the Engineer but shall nevertheless use constantly his best endeavour to prevent or make good the delay and shall do all that may reasonably be required to the satisfaction of the Engineer to proceed with the work.
- 2 In case of delay in completion of work BHEL reserve the right to grant time extension under the following options depending upon the performance of the vendor:
 - i) Time extension without levy of LD in case it is found that delay is not attributable to the vendor
 - ii) Time extension with deduction of applicable LD in line with Liquidity Damage clause if the delay is solely attributable to the vendor.

iii) In case facts of delay is not settled, BHEL reserve the right to grant provisional time extension for delay in completion of total work or part thereof and running/ interim payments to the vendor will be released without deduction of LD subject to submission of additional Bank guarantee equivalent to maximum LD amount valid till completion of work under their scope and grant of final time extension.

During provisional time extension period ORC/ PVC shall not be payable to the contractor. The Final Delay analysis shall be prepared on completion of the work. In case of delay is not attributable to contractor as per final delay analysis the ORC/ PVC shall be released along with the final bill without any interest charges attributable to BHEL.

In case of delay attributable to contractor, LD shall be deducted for that period in line with clause "Compensation/ LD/ Penalty for delay in execution" of conditions of contract and balance ORC/ PVC (if any) shall be released along with the final bill without any interest charges attributable to BHEL.

K LIQUIDATED DAMAGES/PENALTY FOR DELAY IN EXECUTION

The Clause No. C.5.0 "LD / Penalty for delay in execution" of Conditions of contract for ETC works stands deleted. Now the modified clause shall be read as below:

Liquidated Damages, wherever referred under this Tender/Agreement, shall mean and refer to the damages, not in the nature of penalty, which the contractor agrees to pay in the event of delay in delivery of stores, installation, commissioning, breach of contract etc. as the case may be.

Liquidated Damages leviable upon the contractor is a sum which is agreed by the parties as a reasonable and genuine pre-estimate of damages which will be suffered by BHEL on account of delay/breach on the part of the contractor.

Liquidated Damages shall be calculated in the manner stipulated hereinafter:

In case the work is not completed within the stipulated time period, BHEL at its discretion may grant provisional time extension to contractor for the sole purpose of completion of balance works keeping its right reserved under the contract and law.

Grant of any provisional time extension shall by no means be considered as waiver of BHEL rights under the contract or law.

After the completion of work, duly certified by Engineer In charge, a comprehensive delay analysis shall be carried out to ascertain the attribution of delays in the provisional time extensions granted to contractor. The delay analysis shall record:

- a) Delays solely attributable to contractor
- b) Delays attributable to BHEL
- c) Delays on account of Force Majeure (as specified elsewhere in the contract)

The total period under the final time extension shall be equal to the period between the scheduled date of completion and the actual date of completion of contract. LD shall be imposed/ levied for the portion of time extensions solely attributable to contractor and recoverable from the dues payable to the contractor.

For the periods, wherein the delay as per the comprehensive delay analysis carried out is solely attributable to contractor, BHEL shall have the right to impose Liquidated Damage at the rate of 0.5% of the contract value, per week of delay or part thereof subject to a maximum of 10% of the contract value.

Contract Value for this purpose, shall be the final executed value exclusive of ORC, Extra Works executed on Man-day rate basis, Supplementary/ Additional Items and PVC. Before levying LD, the contractor shall be duly intimated the amount and reasons thereof for imposition of LD.

L RIGHTS OF BHEL

The Clause No. B.7.0 "RIGHTS OF BHEL" of Conditions of contract for ETC works stands deleted. Now the modified clause shall be read as below:

BHEL reserves the following rights in respect of this contract during the original contract period or its extensions if any, as per the provisions of the contract, without entitling the contractor for any Compensation

- 1 To withdraw any portion of work and/or to restrict/alter quantum of work as indicated in the contract during the progress of work and get it done through other agencies to suit BHEL's commitment to its customer or in case BHEL decides to advance the date of completion due to other emergent reasons/ BHEL's obligation to its customer.

In case of inadequate manpower deployed by the contractor, BHEL reserves the right to deploy additional manpower through any other agency for expediting activities in the interest of the project. Supplied manpower shall be put on job by the contractor and payments and other statutory compliances related to manpower shall be the contractor's responsibility. In case of contractor's failure to fulfil his obligations in respect of such manpower, BHEL reserves the right to take necessary action as per contract conditions.

- 2 **Breach of Contract, Remedies and Termination**

- a) The following shall amount to breach of contract:
- I) Non-supply of material/ non-completion of work by the Supplier/Vendor within scheduled delivery/ completion period as per contract or as extended from time to time.
 - II) The Supplier/Vendor fails to perform as per the activity schedule and there are sufficient reasons even before expiry of the delivery/ completion period to justify that supplies shall be inordinately delayed beyond contractual delivery/ completion period.
 - III) The Supplier/Vendor delivers equipment/ material not of the contracted quality.
 - IV) The Supplier/Vendor fails to replace the defective equipment/ material/ component as per guarantee clause.
 - V) Withdrawal from or abandonment of the work by the Supplier/Vendor before completion as per contract.
 - VI) Assignment, transfer, subletting of Contract by the Supplier/Vendor without BHEL's written permission resulting in termination of Contract or part thereof by BHEL.
 - VII) Non-compliance to any contractual condition or any other default attributable to Supplier/Vendor.
 - VIII) Any other reason(s) attributable to Vendor towards failure of performance of contract. In case of breach of contract, BHEL shall have the right to terminate the Purchase Order/ Contract either in whole or in part thereof without any compensation to the Supplier/Vendor.
 - IX) Any of the declarations furnished by the contractor at the time of bidding and/ or entering into the contract for supply are found untruthful and such declarations were of a nature that could have resulted in non-award of contract to the contractor or could expose BHEL and/ or Owner to adverse consequences, financial or otherwise.
 - X) Supplier/Vendor is convicted of any offence involving corrupt business practices, antinational activities or any such offence that compromises the business ethics of BHEL, in violation of the Integrity Pact entered into with BHEL has the potential to harm the overall business of BHEL/ Owner.

Note Once BHEL considers that a breach of contract has occurred on the part of Supplier/Vendor, BHEL shall notify the Supplier/Vendor by way of notice in this regard. Contractor shall be given an opportunity to rectify the reasons causing the breach of contract within a period of 14 days.

In case the contractor fails to remedy the breach, as mentioned in the notice, to the satisfaction of BHEL, BHEL shall have the right to take recourse to any of the remedial actions available to it under the relevant provisions of contract.

LD against delay in executed work in case of Termination of Contract:

LD against delay in executed work shall be calculated in line with relevant LD clause of GCC, for the delay attributable to contractor. For limiting the maximum value of LD, contract value shall be taken as Executed Value of work till termination of contract.

Method for calculation of "LD against delay in executed work in case of termination of contract" is given below.

I)	Let the time period from scheduled date of start of work till termination of contract excluding the period of Hold (if any) not attributable to contractor	T1
II)	Let the value of executed work till the time of termination of contract	X
III)	Let the Total Executable Value of work for which inputs/fronts were made available	Y
IV)	Delay in executed work attributable to contractor i.e. T2	$= [1-(X/Y)] \times T1$
V)	LD shall be calculated in line with LD clause of the Contract for the delay attributable to contractor taking "X" as Contract Value and "T2" as period of delay attributable to contractor.	

b) Remedies in case of Breach of Contract is established:

- i) Wherein the period as stipulated in the notice issued under clause "BREACH OF CONTRACT, REMEDIES AND TERMINATION" of GCC has expired and Contractor has failed to remedy the breach, BHEL will have the right to terminate the contract on the ground of "Breach of Contract" without any further notice to contractor.
- ii) Upon termination of contract, BHEL shall be entitled to recover an amount equivalent to 10% of the Contract Value for the damages on account of breach of contract committed by the Contractor. This amount shall be recovered by way of encashing the security instruments like performance bank guarantee etc available with BHEL against the said contract. In case the value of the security instruments available is less than 10% of the contract value, the balance amount shall be recovered from other financial remedies (i.e. available bills of the contractor, retention amount, from the money due to the Contractor etc. with BHEL) or the other legal remedies shall be pursued.

- iii) wherever the value of security instruments like performance bank guarantee available with BHEL against the said contract is 10% of the contract value or more, such security instruments to the extent of 10% contract value will be encashed. In case no security instruments are available or the value of the security instruments available is less than 10% of the contract value, the 10% of the contract value or the balance amount, as the case may be, will be recovered in all or any of the following manners:
- iv) In case the amount recovered under sub clause (a) above is not sufficient to fulfil the amount recoverable then; a demand notice to deposit the balance amount within 30 days shall be issued to Contractor.
- v) If Contractor fails to deposit the balance amount within the period as prescribed in demand notice, following action shall be taken for recovery of the balance amount:
 - a) from dues available in the form of Bills payable to defaulted Contractor against the same contract.
 - b) If it is not possible to recover the dues available from the same contract or dues are insufficient to meet the recoverable amount, balance amount shall be recovered from any money(s) payable to Contractor under any contract with other Units of BHEL including recovery from security deposits or any other deposit available in the form of security instruments of any kind against Security deposit or EMD.
 - c) In-case recoveries are not possible with any of the above available options, Legal action shall be initiated for recovery against defaulted Contractor.
- vi) It is an agreed term of contract that this amount shall be a genuine pre-estimate of damages that BHEL would incur in completion of balance contractual obligation of the contract through any other agency and BHEL will not be required to furnish any other evidence to the Contractor for the purpose of estimation of damages.
- vii) In addition to the above, imposition of liquidated damages, debarment, termination, de-scoping, short-closure, etc., shall be applied as per provisions of the contract.

Note: The defaulting contractor shall not be eligible for participation in any of the future enquiries floated by BHEL to complete the balance work. The defaulting contractor shall mean and include:

- a) In case defaulted contractor is the Sole Proprietorship Firm, any Sole Proprietorship Firm owned by same Sole Proprietor.
 - b) In case defaulted contractor is The Partnership Firm, any firm comprising of same partners/ some of the same partners (but not including any new partner); or sole proprietorship firm owned by any partner(s) as a sole proprietor.
- 3 In case Contractor fails to deploy the resources as per requirement informed by BHEL in writing to expedite the work, BHEL can deploy own/hired/otherwise arranged resources and recover the expenses incurred from the dues payable to contractor. Recoveries shall be actual expenses incurred plus 5% overheads or as defined in TCC.
 - 4 To terminate the contract or to restrict the quantum of work and pay for the portion of work executed in case BHEL's contract with their customer are terminated for any reason, whatsoever.
 - 5 Whenever any Claim or Claims for payment of any sum of money(s) arises under this or any other contract against the contractor, BHEL shall be entitled to withhold and also have a lien to retain such sum of money(s) in whole or in part from any money(s) payable to contractor and/or security deposits furnished or deducted in cash from the bills of contractor, (if any) under this contract. In the event of the securities or the amounts payable to Contractor, being insufficient to cover BHEL claims, then BHEL shall be entitled to withhold and have a lien to the extent of such claims from any sum or sums found payable or which at any time thereafter may become payable to the contractor under this or any other contract with BHEL.
 - a) Claim or Claims for payment of any sum of money(s) arising from the Contractor under this or any other contract against the contractor, shall mean, the sum of money(s) actually incurred by BHEL in fulfilling the contractual responsibilities of contractor under the contract, to which he has failed to fulfil plus applicable overheads (@ 5%) along with interest as applicable under the Contract on total amount (i.e. money actually incurred plus overheads)
 - b) It is an agreed term of the contract that, the sum or sums of money so withheld or retained under the lien by BHEL will be kept withheld or retained as such by BHEL till the claims arising out of this or any other contract are finally adjudicated wither through Arbitration or a Court of competent jurisdiction as the case may be in accordance with the terms of contract. Intimation given by the BHEL Engineer regarding withholding of such money(s) shall be considered as sufficient and relevant date for all purposes. No Interest shall be payable on such sum(s) of money which becomes due or as the case may be adjudged to be due from BHEL to Contractor, whether under contract or otherwise.
 - c) Where the contractor is a partnership firm, BHEL shall be entitled to withhold and also have a lien to retain towards such claims in whole or in part, from any other money(s) payable to any partner, whether in his individual capacity or otherwise.
 - d) If any money(s) shall, as a result of any claim or application made under the relevant provisions of any Labour Welfare Act and/ or Rules, including but not limited to Contract Labour Regulation & Abolition Act, Minimum Wages Act, Payment of Gratuity Act, BOCW (RE&CS) Act, Provident Fund Act, Employee State Insurance Act, be directed to be paid by the BHEL, such money shall be deemed to be moneys payable to the BHEL by the Contractor.

- e) Where the Contractor fails to repay to BHEL such moneys along with applicable overheads (@ 5%) and interest, as aforesaid within seven days of being demanded, BHEL shall be entitled to recover the same from Contractor's bills/ Security Deposit or any other money(s) payable to Contractor under this Contract or any other Contract with BHEL.
- 6 While every endeavor will be made by BHEL to this end, yet BHEL cannot guarantee uninterrupted work due to conditions beyond its control. The Contractor will not be normally entitled for any compensation/extra payment on this account unless otherwise specified elsewhere in the contract.
- 7 BHEL may permit or direct contractor to demobilize and remobilize at a future date as intimated by BHEL in case of following situations for reasons other than Force majeure conditions and not attributable to contractor:
- a) suspension of work(s) at a Project either by BHEL or Customer,
 - or
 - b) where work comes to a complete halt or reaches a stage wherein worthwhile works cannot be executed and there is no possibility of commencement of work for a period of not less than three months

In such cases, charges towards demobilization and remobilization shall be as decided by BHEL after successful remobilization by contractor at site, and decision of BHEL shall be final and binding on the contractor. After remobilization, all conditions as per contract shall become applicable. In case Contractor does not remobilize with adequate resources or does not start the work within the period as intimated, then BHEL reserves the right to terminate the contract and effect remedies under Clause "Remedies in case of Breach of Contract" In case of any conflict, BHEL decision in this regard shall be final and binding on the contractor.

- 8 In the unforeseen event of inordinate delay in receipt of materials, drawings, fronts etc. due to which inordinate discontinuity of work is anticipated, BHEL on its own or contractor's request at its discretion may consider to short close the contract in any of the following cases:
- a) The balance works (including but not limited to Trial Operation, PG Test etc.) are minor vis a vis the scope of work envisaged as per the contract.
 - b) There has been no significant work in past 6 months OR no significant work is expected in next 6 months (example in Hydro projects or in projects where work has stopped due to reasons beyond the control of BHEL).
 - c) The balance works cannot be done within a reasonable period of time as they are dependent on unit shut down or on other facilities of customer or any other such reasons not attributable to the contractor.

At the point of requesting for short closure, contractor shall establish that he has completed all works possible of completion and he is not able to proceed with the balance works due to constraints beyond his control. In such a case, the estimated value of the unexecuted portion of work (or estimated value of services to be provided for carrying out milestone/stage payments like Trial Operation/PG Test etc.) as decided by BHEL, shall however be reduced from the final contract value.

Note: The Contractor shall not be eligible for any compensation on account of Quantity Variation arising out of short-closure of contract as per clause above.

M FORCE MAJEURE

Clause No. B.13.0 (FORCE MAJEURE) of Conditions of Contract for ETC Works has been modified as below:

- 1 "Force Majeure" shall mean circumstance which is:
- a) beyond control of either of the parties to contract,
 - b) either of the parties could not reasonably have provided against the event before entering into the contract,
 - c) having arisen, either of the parties could not reasonably have avoided or overcome, and
 - d) is not substantially attributable to either of the parties

Such circumstances include but shall not be limited to:

- i) War, hostilities, invasion, act of foreign enemies.
- ii) Rebellion, terrorism, revolution, insurrection, military or usurped power, or civil war.
- iii) Riot, commotion or disorder by persons other than the contractor's personnel and other employees of the contractor and sub-contractors.
- iv) Strike or lockout not solely involving the contractor's personnel and other employees of the contractor and sub-contractors.
- v) Encountering munitions of war, explosive materials, ionizing radiation or contamination by radio-activity, except as may be attributable to the contractor's use of such munitions, explosives, radiation or radio-activity.
- vi) Natural catastrophes such as earthquake, tsunami, volcanic activity, hurricane or typhoon, flood, fire, cyclones etc.
- vii) Epidemic, pandemic etc.

- 2 The following events are explicitly excluded from Force Majeure and are solely the responsibilities of the non-performing party:
 - a) any strike, work-to-rule action, go-slow or similar labour difficulty
 - b) late delivery of equipment or material (unless caused by Force Majeure event) and
 - c) economic hardship.
- 3 If either party is prevented, hindered or delayed from or in performing any of its obligations under the Contract by an event of Force Majeure, then it shall notify the other in writing of the occurrence of such event and the circumstances thereof within 15 (fifteen) days after the occurrence of such event.
- 4 The party who has given such notice shall be excused from the performance or punctual performance of its obligations under the Contract for so long as the relevant event of Force Majeure continues and to the extent that such party's performance is prevented, hindered or delayed. The Time for Completion shall be extended by a period of time equal to period of delay caused due to such Force Majeure event.
- 5 Delay or non-performance by either party hereto caused by the occurrence of any event of Force Majeure shall not
 - a) Constitute a default or breach of the Contract.
 - b) Give rise to any claim for damages or additional cost expense occasioned thereby, if and to the extent that such delay or non-performance is caused by the occurrence of an event of Force Majeure
- 6 BHEL at its discretion may consider short closure of contract after 1 year of imposition of Force Majeure in line with extant guidelines. In any case, Supplier/Vendor cannot consider deemed short-closure after 1 year of imposition of Force Majeure.

N SETTLEMENT OF DISPUTE

Clause No. B.15.0 (Arbitration) of Conditions of Contract for ETC Works has been modified as below:

If any dispute or difference of any kind whatsoever shall arise between BHEL and the Supplier/Vendor, arising out of the contract for the performance of the work whether during the progress of contract termination, abandonment or breach of the contract, it shall in the first place referred to **Sector Head/TBSS, TBG, BHEL** for amicable resolution by the parties. **Sector Head/TBSS, TBG, BHEL** who within 60 days after being requested shall give written notice of his decision to the contractor. Save as hereinafter provided, such decision in respect of every matter so referred shall forthwith be given effect to by the Supplier/Vendor who shall proceed with the work with all due diligence, whether he or BHEL desires to resolve the dispute as hereinafter provided or not.

If after the **Sector Head/TBSS, TBG, BHEL** has given written notice of this decision to the party and no intention to pursue the dispute has been communicated to him by the affected party within 30 days from the receipt of such notice, the said decision shall become final and binding on the parties. In the event the Supplier/Vendor being dissatisfied with any such decision or if amicable settlement cannot be reached then all such disputed issues shall be resolved through conciliation in terms of the BHEL Conciliation Scheme 2018 as per Clause "Conciliation" of GCC.

1 CONCILIATION:

Any dispute, difference or controversy of whatever nature howsoever arising under or out of or in relation to this Agreement (including its interpretation) between the Parties, and so notified in writing by either Party to the other Party (the "Dispute") shall, in the first instance, be attempted to be resolved amicably in accordance with the conciliation procedure as per BHEL Conciliation Scheme 2018. The proceedings of Conciliation shall broadly be governed by Part-III of the Arbitration and Conciliation Act 1996 or any statutory modification thereof and as provided in - "Procedure for conduct of conciliation proceedings" (as available in www.bhel.com)).

Note: Ministry of Finance has issued OM reference No. 1/2/24 dated 03.06.2024 regarding "Guidelines for Arbitration and Mediation in Contracts of Domestic Public Procurement. In the said OM it has been recommended that Government departments/

Entities/agencies are to encourage mediation under the Mediation Act. 2023. The said Act has not yet been notified by the Government. Therefore, the clause "Settlement of Disputes" shall be modified accordingly as and when the Mediation Act 2023 gets notified.

2 ARBITRATION:

Except as provided elsewhere in this Contract, in case Parties are unable to reach amicable settlement (whether by Conciliation to be conducted as provided in Clause "**Conciliation**" herein above or otherwise) in respect of any dispute or difference; arising out of the formation, breach, termination, validity or execution of the Contract; or, the respective rights and liabilities of the Parties; or, in relation to interpretation of any provision of the Contract; or, in any manner touching upon the Contract (hereinafter referred to as the 'Dispute'), then, either Party may, refer the disputes to Arbitral Institution i.e. "**India International Arbitration Centre (IIAC) Delhi**" and such dispute to be adjudicated by Sole Arbitrator appointed in accordance with the Rules of said Arbitral Institution.

A party willing to commence arbitration proceeding shall invoke Arbitration Clause by giving notice to the other party in terms of section 21 of the Arbitration & Conciliation Act, 1996 (hereinafter referred to as the 'Notice') before referring the matter to arbitral institution. The Notice shall be addressed to the **Executive Director, TBG, BHEL, Noida**, executing the Contract and shall contain the particulars of all claims to be referred to arbitration with sufficient detail and shall also indicate the monetary amount of such claim including interest, if any.

- C After expiry of 30 days from the date of receipt of aforesaid notice, the party invoking the Arbitration shall submit that dispute to the Arbitral Institutions and that dispute shall be adjudicated in accordance with their respective Arbitration Rules. The matter shall be adjudicated by a Sole Arbitrator who shall necessarily be a Retd Judge having considerable experience in commercial matters to be appointed/nominated by the respective institution. The cost/expenses pertaining to the said Arbitration shall also be governed in accordance with the Rules of the respective Arbitral Institution. The decision of the party invoking the Arbitration for reference of dispute to a specific Arbitral institution for adjudication of that dispute shall be final and binding on both the parties and shall not be subject to any change thereafter. The institution once selected at the time of invocation of dispute shall remain unchanged.
- D The fee and expenses shall be borne by the parties as per the Arbitral Institutional rules.
- E The Arbitration proceedings shall be in English language and the seat and venue of Arbitration shall be Delhi. Subject to the above, the provisions of Arbitration & Conciliation Act 1996 and any amendment thereof shall be applicable. All matters relating to this Contract and arising out of invocation of Arbitration clause are subject to the exclusive jurisdiction of the Court(s) situated at Delhi.
- G Notwithstanding any reference to the **Sector Head/TBSS, TBG, BHEL** or Conciliation or Arbitration herein, a. the parties shall continue to perform their respective obligations under the Contract unless they otherwise agree. Settlement of Dispute clause cannot be invoked by the Contractor, if the Contract has been mutually closed or 'No Demand Certificate' has been furnished by the Contractor or any Settlement Agreement has been signed between the Employer and the Contractor.
- H The Mechanism of resolution of disputes through arbitration shall be available only in the cases where the value of the dispute is less than Rs. 10 Crores.
- I In case the disputed amount (Claim, Counter claim including interest is Rs. 10 crores and above, the parties shall be within their rights to take recourse to remedies other than Arbitration, as may be available to them under the applicable laws after prior intimation to the other party. Subject to the aforesaid conditions, provisions of the Arbitration and Conciliation Act, 1996 and any statutory modifications or re-enactment thereof as amended from time to time, shall apply to the arbitration proceedings under this clause.
- J In case, multiple arbitrations are invoked (whether sub-judice or arbitral award passed) by any party to under this contract, then the cumulative value of claims (including interest claimed or awarded) in all such arbitrations shall be taken in account while arriving at the total claim in dispute for the subject contract for the purpose of clause N.2.I. Disputes having cumulative value of less than 10 crores shall be resolved through arbitration and any additional dispute shall be adjudicated by the court of competent jurisdiction.
- K **In case of Contract with Public Sector Enterprise (PSE) or a Government Department, the following shall be applicable:**
- In the event of any dispute or difference relating to the interpretation and application of the provisions of commercial contract(s) between Central Public Sector Enterprises (CPSEs)/ Port Trusts inter se and also between CPSEs and Government Departments/Organizations (excluding disputes concerning Railways, Income Tax, Customs & Excise Departments), such dispute or difference shall be taken up by either party for resolution through AMRCD (Administrative Mechanism for Resolution of CPSEs Disputes) as mentioned in DPE OM No. 05/0003/2019-FTS-10937 dated 14-12-2022 as amended from time to time.

O FACILITIES PROVIDED TO MSEs:

Vide office memorandum F.No.21(8)/2011-MA dated 09.11.2016, Office of AS&DC, Ministry of MSME has issued clarification regarding definition of Goods and Services under the Public Procurement Policy of MSEs order-2012, In accordance with the Public Procurement Policy for MSEs order-2012 and OM regarding definition of Goods and Services issued by Ministry of MSME, it is clarified that benefits as envisaged in Public Procurement Policy for MSEs Order 2012 are to be provided in respect of the procurements related to the Goods and Services produced and provided by Micro and Small Enterprises (MSEs) only and **no benefits is to be given in Case of Works Contracts.**

P CLOSING OF CONTRACTS

The Contract shall be considered completed and closed upon completion of contractual obligations and settlement of Final Bill or completion of Guarantee period whichever is later. Upon closing of Contract, BHEL shall issue a performance/ experience certificate as per standard format, based on specific request of Contractor as per extant BHEL guidelines through the online portal available at <https://siddhi.bhel.in> only.

Q SUSPENSION OF BUSINESS DEALINGS

BHEL reserves the right to take action against Contractors who either fail to perform or Tenderers/Contractor who indulge in malpractices, by suspending business dealings with them in line with BHEL guidelines issued from time to time.

The offers of the bidders who are under suspension as also the offers of the bidders, who engage the services of the banned firms / principal / agents, shall be rejected. The list of banned firms is available on BHEL web site www.bhel.com.

If any bidder / supplier / contractor during pre-tendering / tendering / post tendering / award / execution / post-execution stage indulges in any act, including but not limited to, mal-practices, cheating, bribery, fraud or and other misconduct or formation of cartel so as to influence the bidding process or influence the price or tampers the tendering process or acts or omits in any manner which tantamount to an offence punishable under any provision of the Indian Penal Code, 1860 or any other law in force in India, or does anything which is actionable under the Guidelines for Suspension of Business dealings, action may be taken against such bidder / supplier / contractor as per extant guidelines of the company available on www.bhel.com and / or under applicable legal provisions. Guidelines for suspension of business dealings is available in the webpage:

http://www.bhel.com/vender_registration/vender.php.

R PERFORMANCE MONITORING:

The Contractors performance shall be continuously monitored during execution of work at site.

In case of contractor's performance is found not satisfactory during the execution of work at site, BHEL may take alternate remedial measures and may not consider the contractor for further tenders, if the contractor performance is not improved in spite of opportunities given by BHEL.

S MEASUREMENT OF WORK AND MODE OF PAYMENT:

- S.1 All payments due to the contractors shall be made by e-mode only.
- S.2 For progress running bill payments: - The Contractor shall present detailed measurement sheets in triplicate, duly indicating all relevant details based on technical documents and connected drawings for work done during the month/period under various categories in line with terms of payment as per contract. The basis of arriving at the quantities, weights shall be relevant documents and drawings released by BHEL. These measurement sheets shall be prepared jointly with BHEL Engineers and signed by both the parties.
- S.3 These measurement sheets will be checked by BHEL Engineer and quantities and percentage eligible for payment under various groups shall be decided by BHEL Engineer. The abstract of quantities and percentage so arrived at based on the terms of payment shall be entered in Measurement Book by BHEL Engineers and signed by both the parties.
- S.4 These measurement sheets will be checked by BHEL Engineer and quantities and percentage eligible for payment under various groups shall be decided by BHEL Engineer. The abstract of quantities and percentage so arrived at based on the terms of payment shall be entered in Measurement Book and signed by both the parties.
- S.5 Based on the above quantities, contractor shall prepare the bills, along with statutory documents, in prescribed format and work out the financial value. These will be entered in Measurement Book and signed by both the parties. Payment shall be made by BHEL after effecting the recoveries due from the contractor.
- S.6 All recoveries due from the contractor for the month/period shall be effected in full from the corresponding running bills unless specific approval from the competent authorities is obtained to the contrary.
- S.7 Measurement shall be restricted to that portion of work for which it is required to ascertain the financial liability of BHEL under this contract.
- S.8 The measurement shall be taken jointly by persons duly authorized on the part of BHEL and by the Contractor.
- S.9 The Contractor shall bear the expenditure involved if any, in making the measurements and testing of materials to be used/ used in the work. The contractor shall, without extra charges, provide all the assistance with appliances and other things necessary for measurement.
- S.10 If at any time due to any reason whatsoever, it becomes necessary to re-measure the work done in full or in part, the expenses towards such re measurements shall be borne by the contractor unless such re measurements are warranted solely for reasons not attributable to contractor.
- S.11 Passing of bills covered by such measurements does not amount to acceptance of the completion of the work measured. Any left out work has to be completed, if pointed out at a later date by BHEL.
- S.12 Final measurement bill shall be prepared in the final bill format prescribed for the purpose based on the certificate issued by BHEL Engineer that entire works as stipulated in tender specification has been completed in all respects to the entire satisfaction of BHEL. Contractor shall give unqualified "No Claim" Certificate. All the tools and tackles loaned to him should be returned in satisfactory condition to BHEL. The abstract of final quantities and financial values shall also be entered in the Measurement Books and signed by both parties to the contract. The Final Bill shall be prepared and paid within a reasonable time after completion of work

T NO INTEREST PAYABLE TO CONTRACTOR:

Notwithstanding anything to the contrary contained in any other document comprising in the Contract, no interest shall be payable by BHEL to Contractor on any moneys or balances including but not limited to the Security Deposit, EMD, Retention Money, RA Bills or the Final Bill, or any amount withheld and/or appropriated by BHEL etc., which becomes or as the case may be, is adjudged to be due from BHEL to Contractor whether under the Contract or otherwise.

U PROGRESSIVE PAYMENT/ FINAL PAYMENT:

1 Running Account Bills (RA Bills)

- (i) These are for interim payments when the contracts are in progress. The bills for such interim payments are to be prepared by Contractor in prescribed formats (RA Bill forms).
- (ii) Payments shall be made according to the extent of work done as per measurements taken up to the end of the calendar month and in line with the terms of payments described in the Tender documents.
- (iii) Recoveries on account of electricity, water, statutory deductions etc. are made as per terms of contract.
- (iv) Full rates for the work done shall be allowed only if the quantum of work has been done as per the specifications stipulated in the contract. If the work is not executed as per the stipulated specifications, BHEL may ask the contractor to redo the work according to the required specifications, without any extra cost.
- (v) The contractor shall submit his monthly RA bills with all the details required by BHEL on specified date every month covering progress of work in all respects and areas for the previous calendar month.
- (vi) Mode of payment and measurement of work completed shall be as per relevant clauses of General Conditions of Contract
- (vii) Release of payment in each running bill including PVC Bills where ever applicable will be as per stages of progressive pro rata payments.
- (viii) The contractor will be eligible for payment of RA Bills within 30 days of submission of running bill complete in all respects with all documents. It is the responsibility of the contractor to make his own arrangements for making timely payments towards labour wages, statutory payments, outstanding dues etc. and other dues in the meanwhile.

All documents like HR Clearance, Quality and Safety Compliances etc. required for processing the RA Bills should be submitted along with RA Bills.
- (ix) BHEL shall release payment through Electronic Fund Transfer (EFT)/RTGS. In order to implement this system, Contractor to furnish details pertaining to his Bank Accounts where proceeds will be transferred through BHEL's banker, as per prescribed formats.
- (x) For MSMEs, at the time of submission of first RA bill, the subcontractor has to declare whether it is registered on RXIL portal and wishes to receive the proceeds through RXIL portal throughout the contract duration.

1.1 Documents required for RA Bill:

- a) GST Complied Invoice of the work done as per approved BOQ.
- b) Jointly signed Measurement sheet, Abstract , WAM -6 for RA Bill.
- c) Valid Bank Guarantees as applicable under the contract.
- d) Labour Payment Certificate
- e) Copy of valid Workmen Compensation Insurance policy
- f) Material Reconciliation statement
- g) Test Report of the material as per FQP
- h) Power of Attorney for representative signing MBs etc, if not submitted earlier.
- i) HR compliance documents (like PF, ESI, Wage sheets etc.)
- j) Any other documents as per customer/statutory requirement.

Note :

Site in charge has to certify that all the above required documents have been received and verified and document sl no. a) to e) duly verified are to be sent to Finance alongwith RA bills.

2 Final Bill

Final Bill' is used for final payment on closing of Running Account for works or for single payment after completion of works. 'Final Bill' shall be submitted as per prescribed format after completion of works as per scope, material reconciliation, removal of temporary structures, return of scrap/surplus material of BHEL. BHEL shall settle the final bills after deducting all liabilities of Contractor to BHEL.

2.1 Documents required for Final Bill:

- a) GST Complied Invoice of the work done as per approved BOQ.
- b) Jointly signed Measurement sheet, WAM -7, WAM-10 format (if Applicable).
- c) Valid Bank Guarantees as applicable under the contract.
- d) Labour Payment Certificate.
- e) 'No claim' certificate from the contractor.
- f) Copy of valid Workmen Compensation Insurance policy
- g) Deviation statement showing the Executed quantities and quantities as per the contract.

- h) Material Reconciliation statement.
- i) Submission of As Built Drawings
- j) Material Reconciliation statement duly approved by BHEL
- k) Power of Attorney for representative signing MBs etc, if not submitted earlier.
- l) HR compliance documents (like PF, ESI, Wage sheets etc.)
- m) Compliance report from BHEL/Customer for completion of punch points.
- n) Final Delay Analysis.
- o) Any other documents as per customer requirement/statutory requirement.

Note :

Site incharge has to certify that all the above required documents have been received and verified and document sl no. a) to g) duly verified are to be sent to Finance alongwith Completion certificate.

V Limitation of liability

Notwithstanding anything to the contrary in this Contract or LOA or Work Order or any other mutually agreed document between the parties, the maximum liability, for damages, of the contractor, its servants or agents, shall under no circumstances exceed an amount equal to the Price of the Contract or the Work Order. Neither party shall be liable to the other for any indirect or consequential loss or damage, including but not limited to loss of use, loss of profits, or loss of contracts, or special, punitive, exemplary losses whatsoever, arising out of or in connection with this contract.

This shall not be applicable on the recoveries made by Customer from BHEL on account of Contractor, any other type of recoveries for workmanship, material, T&P etc. due from the contractor”.

W CONSEQUENTIAL LOSS

Neither party shall be liable to the other for any indirect or consequential loss or damage, including but not limited to loss of use, loss of profits, or loss of contracts, or special, punitive, exemplary losses whatsoever arising out of or in connection with this contract.

X DEPLOYMENT OF SAFETY PERSONNEL BY SUBCONTRACTOR AS PER HSE SPEC CLAUSE 6.b (If required by BHEL site in-charge)

a)Deployment of safety personnel may be done as per the conditions prescribed below. This shall be payable at the approved basis of monthly rates as per Table below.

b)The qualification and experience criteria of each type of safety personnel is given Clause 6.b of HSE Specification.

c)No. of safety personnel and duration of deployment shall be strictly as per written instructions of BHEL site in charge.

d)The rates payable as per table below shall be fixed for the entire contract period, including extension if any.

e)The rates payable shall be paid without applying any percentage above/below as per quoted rates in regular BOQ.

f)All the applicable legal and contractual obligations such as payment of applicable minimum wages, PF, bonus, ESIC, leave, insurance, medical, overtime, etc. shall be complied by agency.

Table: Schedule of rate for Safety personnel				
Sl. No.	Components	Safety officer (Rs.) (Highly Skilled)	Safety Supervisor (Rs.) (Skilled)	Safety Stewards (Rs.) (Semi-skilled)
1	Schedule of rate (rounded off to nearest hundred)	34400	31600	27300

NOTE : All other terms and conditions of GCC shall remain unchanged.

BHARAT HEAVY ELECTRICALS LIMITED
DIVISION.....
Running Account Bill
(Para 4.3.1 of Works Accounts Manual)

Name of the Contractor

Name of the Work:

Sanctioned Estimate:

Code No.:

Contract Agreement No.:

Dated:

Division:

Date of written order to commence the Work:

Date of commencement of work:

Due date of completion as per agreement

Date of approval of Competent Authority for time extension as applicable (copy to be enclosed).

Departmental Bill No.

Date:

Sub-Division:

Period of work covered in this bill:

I. ACCOUNT OF WORK EXECUTED

Adhoc payment for work not previously measured **			Item No. of work	Description of work	Quantity as per agreement	Quantity executed upto date	Rate	Unit	Payment on the basis of actual measurement upto date	Quantity executed since last RA bill	Payment on the basis of actual measurement since last running account bill	Remarks
Total as per last running account bill	Since last running account bill	Total upto date										
1	2	3	4	5	6	7	8	9	10	11	12	13

** 1. Whenever payment is made on adhoc basis without actual measurements the amount in whole rupees should be entered in columns 1 to 3 only and not in columns 7 to 12
 2. Whenever there is an entry in column 12 on the basis of actual measurement, the whole of the amount previously paid without detailed measurement should be adjusted by a minus entry in column 2 equivalent to the amount shown in column 1, so that the total upto date in column 3 may become nil.

Total value of work done upto date (A) -----

Deduct value of work shown on the last Running Account Bill (B) -----

Net value of work done since last Running Account Bill (C) -----

Rupees (in words) Only

Note :

Wherever adhoc payments to contractors against running bills are made in accordance with the extant Works Policy, the amount so paid shall be adjusted.

II. MEMORANDUM OF PAYMENTS

		I	II
1.	Total value of work actually measured as per Account No. I, Column 10	(A) -----	-----
2.	Total upto date adhoc payment for work covered by approximate or plan measurements as per Account I, Col. 3	(B) -----	-----
4.	Total upto date payments [(A)+(B)]	(C) -----	-----
5.	Total amount of payments already made as per entry (D) of last Running Account Bill No. dated forwarded to the Accounts Department on	(D) -----	-----
6.	Balance [(C) - (D)]		-----
7.	Payments now to be made:	-----	
	a) by cash / cheque	-----	
	b) by deduction for value of materials supplied by BHEL vide Annexure A attached	-----	
	c) by deduction for hire of tools and plant vide Annexure B attached	-----	
	d) by deduction for other charges vide Annexure C attached	-----	
	e) by deduction on account of security deposit	-----	
	f) by deduction on account of Income Tax		-----

Note : Amounts relating to items 4 to 6 above should be entered in column II and those relating to item 7 in column I. The amount shown against item 6 and the total of item 7 should agree with each other.

III. CERTIFICATE OF THE ENGINEER IN CHARGE

1	The measurements on which the entries in column 7 to 12 of Part I of this Bill (Account of work executed) are based were made by ----- and are reorded at pages - ----- of Measurement Book No. ----- (Name and Designation)
2	Certified that the methods of measurement are correct and the work has been carried out in accordance with the terms and conditions, schedules, specifications and drawings etc. forming part of the contract agreement, subject to deviations included in the deviation statement (Annexure D)
3	Certified that in addition to and quite apart from the quantities of work actually executed as shown in column 10 of Part I, some work has actually been done in connection with several items and the value of the such work is, in no case, less than the adhoc payments as per column 3 of Part I, made or proposed to be made, for the convenience of the contractor in anticipation of, and subject to the results of, detailed measurement which will be made as soon as possible.
4	Certified that measurements by Engineer-incharge and test check of prescribed percentage of measurements by the concerned superior authorities has been carried out.
5	Certified that there are no pending recoveries from the contractor on account of chargeable items (e.g T&P, consumables, material, etc.) issued either by BHEL or by the customer and other recoveries like power, water, quarter, tax liability towards declaration forms etc.
6	Certified that with regard to the free issues, regular reconciliation is being done, completed upto ----- and there are no recoveries pending from the contractor on account of such issues in excess of requirement for execution of work as per contract.
7	Certified that there is no pending recovery for damaged material issued free of cost.
8	Certified that the contractor has fulfilled all the requirements as per contract with reference to statutory obligations (PF, ESI, Minimum Wages, BOCW, Insurance etc.), support services such as service manpower, computer system , T&P etc

Signature of Contractor

Signature of Engineer in Charge

Designation:

Date:

Date:

IV. CERTIFICATE OF THE SENIOR ENGINEER

1	Certified that the measurements have been check measured to the prescribed extent by at site and also by the undersigned and the relevant entries have been initialed in the Measurement Book. (vide pages) (Name and Designation)
2	Certified that all the measurements recorded in the measurement book have been correctly billed for
3	Certified that all recoverable amounts in respect of materials tools and plant etc. and other charges have been correctly made vide annexures A to C attached.

Certified for payment * of Rs. (Rupees only)

* Here specify the net amount payable.

Date:

Signature of Senior Engineer

V. ENTRIES TO BE MADE IN THE FINANCE DEPARTMENT

Accounts Bill No. dated

Entered in Journal Book vide entry No. dated

Passed for Rs.

Less Deductions Rs.

Net amount payable Rs.

(Rupees only)

Payable to Shri / M/s by cheque / cash

Entered in Contractors ledger No. Page

Estimate No :

Debit

Credit

(Gross amount)

(Deductions)

Name of Work :

Account code head

Code No.:

ALLOCATION

Total

Assistant

Date:

Accountant

Date:

Finance Executive

Date:

ANNEXURE C

Form WAM 6 (Contd.)

Statement showing details of other recoveries to be made from the contractor Shri/M/s-----in respect of contract Agreement No.Dated

S. No.	Particulars	Unit	Quantity	Rate	Amount recoverable	Amount recovered up to previous bill	Amount now recovered	Remarks
1	2	3	4	5	6	7	8	9
1	Water charges							
2	Electricity charges							
3	Seignorage charges							
4	Medical charges							
5	Cost of empty gunny bags and empty containers not returned							
6								
7								
8								

TOTAL

--	--	--

Signature of Contractor
Date :

Signature of Engineer in Charge
Date :

Signature of Senior Engineer
Date:

**ANNEXURE D
DEVIATION STATEMENT**

Name of the Contractor:

Contract Agreement No

Name of Work:

Date:

S. No.	Description of Item	Unit	Quantity as per agreement	Quantity as executed	Quantity further anticipated	Total quantity anticipated on completion	Rate as per agreement	Rate as executed	Amount as per agreement	Amount as executed	Amount further anticipated	Total Amount anticipated on completion	Difference		Reason for deviation with authority, if any
													Excess	Savings	
1	2	3	4	5	6	7	8	9	10	11	12	13	14	15	16

Signature of Engineer in Charge
Date :

Signature of Senior Engineer
Date :

BHARAT HEAVY ELECTRICALS LIMITED
DIVISION.....
.....And Final Bill
(Para 4.3.2 of Works Accounts Manual)

Departmental Bill No:

Date:

Name of the Contractor:

Name of the Work:

Division:

Date of Written order to commence the work:

Sub-Division:

Sanctioned Estimate:

Contract Agreement/ Work Order No:

Date of actual completion of the work:

Date of commencement of the Work:

Dated:

Due date of completion as per Agreement:

I. ACCOUNT OF WORK EXECUTED

Adhoc payment for work not previously measured **			Item no. of the agreement / work order	Description of work	Quantity as per agreement	Quantity executed upto date	Rate	Unit	Payment on the basis of actual measurement upto date	Quantity since last running account bill	Payment on the basis of actual measurement since last running account bill	Remarks
Total as per last running account bill	Since last running account bill	Total upto date										
1	2	3	4	5	6	7	8	9	10	11	12	13

** Whenever there is an entry in column 12 on the basis of actual measurement, the whole of the amount previously paid without detailed measurement should be adjusted by a minus entry in column 2 equivalent to the amount shown in column 1, so that the total upto date in column 3 may become nil.

Total value of work done upto date (A) -----

Deduct value of work shown on the last Running Account Bill (B) -----

Net value of work done since last Running Account Bill (C) -----

Rupees (in words) Only

II. MEMORANDUM OF PAYMENTS

1	Total value of work actually measured as per Account No. I column 10	(A)	-----
2	Deduct amount of payments already made as per last running account bill No. dated	(B)	-----
3	Payment now to be made [(A) - (B)]	(C)	-----
4	Deduct amounts recoverable from the contractor on account of :		
	a) Materials supplied by BHEL vide Annexure A attached		-----
	b) Hire of tools and plant vide Annexure B attached		-----
	c) Other charges vide Annexure C attached		-----
	d) Income Tax		-----
	Total Deductions		-----
5	Balance		-----
6	Refunds of Security Deposit		-----
7	Net amount to be paid to the contractor		-----
	Net value Rupees (in words)		Only

I/ We hereby certify that I/We have performed the work as per the terms and conditions of Contract Agreement/Work Order No.....Dated.....for which payment is claimed as above and that I/We have no further claim under this agreement/work order.

Signature of the Contractor

Date:

III CERTIFICATE OF THE ENGINEER IN CHARGE

1. The measurements on which the entries in columns 7 to 11 of Part I of this bill (Account of work executed) are based were made by.....
are recorded at pages.....of measurement book No..... (Name and Designation)

2. A statement showing the quantities of stores issued to the contractor (whether free or on recovery basis) and their disposal is attached.

Date:

Signature of Engineer incharge

Designation:

IV CERTIFICATE OF THE SENIOR ENGINEER

Form WAM 7 (Contd.)

1. Certified that I have personally inspected the work and that the work has been physically completed on the due date in accordance with the terms and conditions, schedules, specifications and drawings etc., forming part of the contract agreement, subject to the deviations noted in Deviation Statement (Annexure D).
2. Certified that the measurements have been check measured to the prescribed extent by..... and by the undersigned at site and the relevant entries have been initiated in the measurement book (vide pages.....) (Name and Designation)
3. Certified that the methods of measurement are correct.
4. Certified that the measurements have been technically checked with reference to contract drawings, deviations etc.
5. Certified that the measurements recorded in the measurement book have been correctly billed for at the contract rates or approved rates.
6. Certified that all recoverable amounts in respect of stores, tools and plant, water, electricity charges etc. have been correctly made vide Annexures A to C and that there are no other demands outstanding against the contractor on this contract.
7. Certified that the issues of all stores as per statement attached (whether charged to the contractor or direct to the work) have been technically checked and represent fair and reasonable issues for the items of work executed vide Annexure E.
8. Certified that all statutory requirements including PF, ESI, Minimum wages, Insurance, GST, BOCW, etc. are complied with by the Contractor. This should be duly backed by the relevant documents.

Certified for payment of * Rs.....(Rupees.....only).

*Here specify the net amount payable

Signature of Senior Engineer

Date

IV ENTRIES TO BE MADE IN THE FINANCE DEPARTMENT

Passed for.....Rs.....
Less Deductions.....Rs.....
Net Amount Payable.....Rs.....
(Rupees.....only)

Account code head	Debit	Credit
	(Gross Amount)	(Deductions)
TOTAL		

Assistant

Date:

Accountant

Date:

Finance Executive

Date:

**ANNEXURE A
Part I**

Form WAM 7 (Contd.)

Statement showing details of materials issued to the contractor Shri / M/S.....in respect of Contract Agreement / Work Order No.....Dated..... and covered by the agreement.

Sl.No.	Stores Issue Voucher No. and date	Issue voucher No. and date allotted by stores to the SIV	Description of material issued to the contractor	Quantity issued	Quantity actually incorporated in the work	Whether recoverable from the contractor or supplied free	If recoverable from the Contractor				
							Rate at which recoverable	Amount recoverable	Amount recovered upto previous bill	Balance now recovered	Remarks

1	2	3	4	5	6	7	8	9	10	11	12
---	---	---	---	---	---	---	---	---	----	----	----

Total

--	--	--	--	--

Signature of Contractor
Date:

Signature of Engineer in Charge
Date:

Signature of Senior Engineer
Date:

**ANNEXURE A
Part II**

Statement showing details of materials issued to the contractor Shri / M/S..... in respect of Contract Agreement / Work Order No.....Dated..... and not covered by the agreement

Sl.No	Stores Issue Voucher No. and Date	Issue Voucher No. and date allotted by stores to the SIV	Description of material issued to the contractor	Quantity issued	Quantity actually incorporated in the work	Issue Rate	Amount recoverable	Amount recovered upto previous bill	Balance now recovered	Remarks
-------	-----------------------------------	--	--	-----------------	--	------------	--------------------	-------------------------------------	-----------------------	---------

1	2	3	4	5	6	7	8	9	10	11
---	---	---	---	---	---	---	---	---	----	----

TOTAL
Add Departmental Charges
Add GST (Wherever applicable)
GRAND TOTAL

Signature of Contractor
Date:

Signature of Engineer-in-Charge
Date:

Signature of Senior Engineer
Date:

Note: Cost of materials recovered in this bill should be shown against item 4 (a) of the memorandum of payments. The amounts of taxes and departmental charges recovered in this bill should be incorporated in Annexure C.

**ANNEXURE D
DEVIATION STATEMENT**

Name of the Contractor:
Name of the Work:

Contract Agreement/Work Order No.
Date:

SL. No.	Description of Item	Unit	Quantity as per agreement	Quantity as executed	Rate as per agreement	Rate as executed	Amount as per agreement	Amount as executed	Difference		Reason for the deviation with authority, if any
									Excess	Savings	
1	2	3	4	5	6	7	8	9	10	11	12

Signature of Engineer in Charge
Date:

Signature of Senior Engineer
Date:

ANNEXURE E

Statement showing the consumption of materials issued to the contractor Shri/M/s..... in respect of Contract Agreement / Work Order No.....Dated.....

Name of the Work:

ON RECOVERY BASIS

SL. No.	Description of material	Unit	Quantity actually issued	Quantity actually incorporated in the work	Balance	Particulars of disposal of balance	Quantity to be issued as per approved data for work actually done	Variation in consumption (difference between colum 5 & 8)		Rate chargeable for excess/short consumption, if any	Amount Recoverable for excess/short consumption, including materials not returned, if any	Remarks
								More	Less			
1	Cement											
2	Bricks											
3	Wood											
4	Asbestos Sheet											
5	Iron Material											
6												
7												

Signature of Contractor

Signature of Engineer in Charge

Signature of Senior Engineer

Date:

Date:

Date:

Note

- The quantities shown in columns 4 and 5 above should tally with those shown in columns 5 & 6 respectively of Annexure A (Part I and II)
- Data statement of theoretical consumption should be attached in support of quantity specified in column 8.

ANNEXURE G
QUESTIONNAIRE TO BE ANSWERED BY THE ENGINEER IN CHARGE AND SENIOR ENGINEER
(Correct particulars and answers to be recorded)

1. Name of the Work:
2. Name of the Contractor:
3. Date of commencement of the Work:
4. Contract agreement /Work Order No. and date:
5. Reference to the supplementary Agreement No. if any:
6. Whether administrative approval and technical sanction has been accorded by the competent authority? If so, cite reference?
7. Whether sanction of the competent authority and financial concurrence of the Finance Department for award of the work has been accorded? If so, cite reference.
8. Whether the work has been completed in time? If not whether penalty has been levied or sanction of the competent authority for extension of time granted and communicated to the Finance Department with reasons for grant of extension? (Due and actual date of completion of the work and reference to letter No. and date granting the extension of time should be given).
9. (a) Whether the rates allowed in the bill have been checked with the contract agreement?
(b) Whether the rates for extra/supplemental items have been approved by the competent authority and the sanction communicated to the Finance Department together with rate analysis? If so, cite reference
10. Whether deviations have been approved by the competent authority? If yes, give reference to the approval; if not, give reasons.
11. Whether the rates of recovery of stores issued to the contractor which are not provided for in the contract agreement have been settled in consultation with Finance?

12. Whether discrepancies pointed out by the Finance department in the stores statement have been reconciled and accepted by the Finance Department?
13. Whether materials issued to the contractor in excess of the theoretical requirements have been returned to the Stores department and the No. and date of such returned stores vouchers have been shown in Stores statement? If not, whether the cost of such excess materials has been recovered at the prescribed rate? Whether consumption statements in respect of materials chargeable to the work have been attached to the bill?
14. Whether consumption of materials shown has been technically checked by Senior Engineer?
15. Whether materials issued and used in the work is not less than that required for consumption in work according to our specifications? If consumption is less, whether necessary recovery has been made in the bill?
16. Whether measurements have been checked by the Engineer and Senior Engineer to the extent required and certificates of check recorded in the measurement books?

17. Whether contractor has signed the bill and the measurement books without reservations? If not, whether reasons have been intimated to the Finance Department?

18. Whether arithmetical calculations have been checked and certificate recorded in the measurement books by a person other than the one who calculated initially?
19. Whether any work was done at the risk and cost of the contractor and whether such cost has been recovered from him? Give particulars.
20. Whether all advance payments on running accounts have been recovered?
21. Whether all the recoveries due for services given to the contractor like rent of accommodation, water charges, electricity charges have been recovered and whether payments made by the company on behalf of the contractor have been adjusted?
22. Whether the files containing abstracts from measurement books/standard measurement books have been completed/updated?
23. Whether hire charges for tools & plant have been recovered and the statement of hire charges with full details attached?
24. Whether the certificate of workmanship and completion of work according to specifications, drawings etc. is recorded by Engineer Incharge/Senior Engineer and whether recoveries have been made for defective works, if any?
25. Whether all corrections in the bill/measurement books etc. have been neatly made and attested and there are no overwriting?
26. Whether final measurements have been taken as soon as possible after completion of the work and the certificate of completion issued? If not, whether reasons for delay have been recorded and communicated to finance department?
27. In respect of quantities reduced in the final bill as compared to the running payment, whether adequate reasons have been recorded and communicated to finance department?
28. Whether the expenditure has been classified correctly according to heads of account recorded in the sanctioned estimate?
29. Whether the work has been completed within the estimated cost? If not, what is the percentage of excess over the sanctioned estimate/ administrative approval? In case the excess is beyond the competency of the Senior Engineer, what action has been taken for obtaining the approval of the authority competent to sanction the excess?
30. (a) If the contractor has furnished bank guarantee in lieu of cash security deposit towards proper execution of works and guarantee against defects during the maintenance period, whether the period of currency of the bank guarantee covers the entire maintenance period?
(b) If not whether security deposit has been proposed to be recovered from the final bill?
31. Whether all the previous audit objections raised on running account bills have been settled? If so, cite references.

Signature of Engineer in Charge
Date:

Signature of Senior Engineer
Date:

ANNEXURE TO MODEL CONCILIATION CLAUSE FOR CONDUCT OF CONCILIATION UNDER THE BHEL CONCILIATION SCHEME, 2018

BRIEF PROCEDURE FOR CONDUCT OF CONCILIATION PROCEEDINGS

1. The proceedings of Conciliation shall broadly be governed by Part-III of the Arbitration and Conciliation Act 1996 or any statutory modification thereof and as provided herein:
2. The party desirous of resorting to Conciliation shall send an invitation/notice in writing to the other party to conciliate specifying all points of Disputes with details of the amount claimed. The party concerned shall not raise any new issue thereafter. Parties shall also not claim any interest on claims/counter-claims from the date of notice invoking Conciliation till the conclusion of the Conciliation proceedings.
3. The party receiving the invitation/notice for Conciliation shall within 30 days of receipt of the notice of Conciliation intimate its consent for Conciliation along with its counter-claims, if any.
4. The Conciliation in a matter involving claim or counter-claim (whichever is higher) up to Rs 5 crores shall be carried out by sole Conciliator nominated by BHEL while in a matter involving claim or counter-claim (whichever is higher) of more than Rs 5 crores Conciliation shall be carried out by 3 Conciliators nominated by BHEL.
5. The Parties shall be represented by only their duly authorized in-house executives/officers and neither Party shall be represented by a Lawyer.
6. The first meeting of the IEC shall be convened by the IEC by sending appropriate communication/notice to both the parties as soon as possible but not later than 30 days from the date of his/their appointment. The hearings in the Conciliation proceeding shall ordinarily be concluded within two (2) months and, in exceptional cases where parties have expressed willingness to settle the matter or there exists possibility of settlement in the matter, the proceedings may be extended by the IEC by a maximum of further 2 months with the consent of the Parties subject to cogent reasons being recorded in writing.
7. The IEC shall thereafter formulate recommendations for settlement of the Disputes supported by reasons at the earliest but in any case within

15 days from the date of conclusion of the last hearing. The recommendations so formulated along with the reasons shall be furnished by the IEC to both the Parties at the earliest but in any case within 1 month from the date of conclusion of the last hearing.

8. Response/modifications/suggestions of the Parties on the recommendations of the IEC are to be submitted to the IEC within time limit stipulated by the IEC but not more than 15 days from the date of receipt of the recommendations from the IEC.
9. In the event, upon consideration, further review of the recommendations is considered necessary, whether by BHEL or by the other Party, then, the matter can be remitted back to the IEC with request to reconsider the same in light of the issues projected by either/both the Parties and to submit its recommendations thereon within the following 15 days from the date of remitting of the case by either of the Parties.
10. Upon the recommendations by the Parties, with or without modifications, as considered necessary, the IEC shall be called upon to draw up the Draft Settlement Agreement in terms of the recommendations.
11. When a consensus can be arrived at between the parties only in regard to any one or some of the issues referred for Conciliation the draft Settlement Agreement shall be accordingly formulated in regard to the said Issue(s), and the said Settlement Agreement, if signed, by the parties, shall be valid only for the said issues. As regards the balance issues not settled, the parties may seek to resolve them further as per terms and conditions provided in the contract.
12. In case no settlement can be reached between the parties, the IEC shall by a written declaration, pronounce that the Conciliation between the parties has failed and is accordingly terminated.
13. Unless the Conciliation proceedings are terminated in terms of para 22 (b), (c) & (d) herein below, the IEC shall forward his/its recommendations as to possible terms of settlement within one (1) month from the date of last hearing. The date of first hearing of Conciliation shall be the starting date for calculating the period of 2 months.

14. In case of 3 members IEC, 2 members of IEC present will constitute a valid quorum for IEC and meeting can take place to proceed in the matter after seeking consent from the member who is not available. If necessary, videoconferencing may be arranged for facilitating participation of the members. However, the IEC recommendations will be signed by all members. Where there is more than one (1) Conciliator, as a general rule they shall act jointly. In the event of differences between the Members of IEC, the decision/recommendations of the majority of the Members of IEC shall prevail and be construed as the recommendation of the IEC.
15. The Draft Settlement Agreement prepared by the IEC in terms of the consensus arrived at during the Conciliation proceedings between the Parties shall be given by the IEC to both the parties for putting up for approval of their respective Competent Authority.
16. Before submitting the draft settlement agreement to BHEL's Competent Authority viz. the Board Level Committee on Alternative Dispute Resolution (BLCADR) for approval, concurrence of the other party's Competent Authority to the draft settlement agreement shall be obtained by the other party and informed to BHEL within 15 days of receipt of the final draft settlement agreement by it. Upon approval by the Competent Authority, the Settlement Agreement would thereafter be signed by the authorized representatives of both the Parties and authenticated by the members of the IEC.
17. In case the Draft Settlement Agreement is rejected by the Competent Authority of BHEL or the other Party, the Conciliation proceedings would stand terminated.
18. A Settlement Agreement shall contain a statement to the effect that each of the person(s) signing thereto (i) is fully authorized by the respective Party(ies) he/she represents, (ii) has fully understood the contents of the same and (iii) is signing on the same out of complete freewill and consent, without any pressure, undue influence.
19. The Settlement Agreement shall thereafter have the same legal status and effect as an arbitration award on agreed terms on the substance of the dispute rendered by an arbitral tribunal passed under section 30 of the Arbitration and Conciliation Act, 1996.
20. Acceptance of the Draft Settlement Agreement/recommendations of the Conciliator and/or signing of the Settlement Agreement by BHEL shall

however, be subject to withdrawal/closure of any arbitral and/or judicial proceedings initiated by the concerned Party in regard to such settled issues.

21. Unless otherwise provided for in the agreement, contract or the Memorandum of Understanding, as the case may be, in the event of likelihood of prolonged absence of the Conciliator or any member of IEC, for any reason/incapacity, the Competent Authority/Head of Unit/Division/Region/Business Group of BHEL may substitute the Conciliator or such member at any stage of the proceedings. Upon appointment of the substitute Conciliator(s), such reconstituted IEC may, with the consent of the Parties, proceed with further Conciliation into the matter either de-novo or from the stage already reached by the previous IEC before the substitution.

22. The proceedings of Conciliation under this Scheme may be terminated as follows:

- a. On the date of signing of the Settlement agreement by the Parties; or,
- b. By a written declaration of the IEC, after consultation with the parties, to the effect that further efforts at conciliation are no longer justified, on the date of the declaration; or,
- c. By a written declaration of the Parties addressed to the IEC to the effect that the Conciliation proceedings are terminated, on the date of the declaration; or,
- d. By a written declaration of a Party to the other Party and the IEC, if appointed, to the effect that the Conciliation proceedings are terminated, on the date of the declaration.
- e. On rejection of the Draft Settlement Agreement by the Competent Authority of BHEL or the other Party.

23. The Conciliator(s) shall be entitled to following fees and facilities:

Sl No	Particulars	Amount
1	Sitting fees	Each Member shall be paid a Lump Sum fee of Rs 75,000/- for the whole case payable in terms of paragraph No. 27 herein below.
2	Towards drafting of settlement agreement	In cases involving claim and/or counter-claim of up to Rs 5crores. Rs 50,000/- (Sole Conciliator)

Sl No	Particulars	Amount
		<p>In cases involving claim and/or counter-claim of exceeding Rs 5 crores but less than Rs 10 crores. Rs 75,000 (per Conciliator)</p> <p>In cases involving claim and/or counter-claim of more than Rs 10 crores. Rs 1,00,000/- (per Conciliator)</p> <p>Note: The aforesaid fees for the drafting of the Settlement Agreement shall be paid on Signing of the Settlement Agreement after approval of the Competent Authority or Rejection of the proposed Settlement Agreement by the Competent Authority of BHEL.</p>
3	Secretarial expenses	<p>Rs 10,000/- (one time) for the whole case for Conciliation by a Sole Member IEC.</p> <p>Where Conciliation is by multi member Conciliators –Rs 30,000/- (one time)- to be paid to the IEC</p>
4	<p>Travel and transportation and stay at outstation</p> <p>i) Retired Senior Officials of other Public Sector Undertakings (pay scale wise equivalent to or more than E-8 level of BHEL)</p>	<p>As per entitlement of the equivalent officer (pay scale wise) in BHEL.</p>
	Others	<p>As per the extant entitlement of whole time Functional Directors in BHEL.</p>

Sl No	Particulars	Amount
		Ordinarily, the IEC Member(s) would be entitled to travel by air Economy Class.
5	Venue for meeting	Unless otherwise agreed in the agreement, contract or the Memorandum of Understanding, as the case may be, the venue/seat of proceedings shall be the location of the concerned Unit / Division / Region / Business Group of BHEL. Without prejudice to the seat/venue of the Conciliation being at the location of concerned BHEL Unit / Division / Region / Business Group, the IEC after consulting the Parties may decide to hold the proceedings at any other place/venue to facilitate the proceedings. Unless, Parties agree to conduct Conciliation at BHEL premises, the venue is to be arranged by either Party alternately.

24. The parties will bear their own costs including cost of presenting their cases/evidence/witness(es)/expert(s) on their behalf. The parties agree to rely upon documentary evidence in support of their claims and not to bring any oral evidence in IEC proceedings.
25. If any witness(es) or expert(s) is/are, with the consent of the parties, called upon to appear at the instance of the IEC in connection with the matter, then, the costs towards such witness(es)/expert(s) shall be determined by the IEC with the consent of the Parties and the cost so determined shall be borne equally by the Parties.
26. The other expenditures/costs in connection with the Conciliation proceedings as well as the IEC's fees and expenses shall be shared by the Parties equally.
27. Out of the lump sum fees of Rs 75,000/- for Sitting Fees, 50% shall be payable after the first meeting of the IEC and the remaining 50% of the Sitting Fees shall be payable only after termination of the conciliation proceedings in terms of para 22 hereinabove.

28. The travelling, transportation and stay at outstation shall be arranged by concerned Unit as per entitlements as per Serial No. 3 of the Table at para 23 above, and in case such arrangements are not made by the BHEL Unit, the same shall be reimbursed to the IEC on actuals limited to their entitlement as per Serial No. 4 of the Table at Para 23 above against supporting documents. The IEC Member(s) shall submit necessary invoice for claiming the fees/reimbursements.
29. The Parties shall keep confidential all matters relating to the conciliation proceedings. Confidentiality shall extend also to the settlement agreement, except where its disclosure is necessary for purposes of its implementation and enforcement or as required by or under a law or as per directions of a Court/Governmental authority/regulatory body, as the case may be.
30. The Parties shall not rely upon or introduce as evidence in any further arbitral or judicial proceedings, whether or not such proceedings relate to the Disputes that is the subject of the Conciliation proceedings:
 - a. Views expressed or suggestions made by the other party in respect of a possible settlement of the Disputes;
 - b. admissions made by the other party in the course of the Conciliator proceedings;
 - c. proposals made by the Conciliator;
 - d. The fact that the other Party had indicated his willingness to accept a proposal for settlement made by the Conciliator.
31. The Parties shall not present the Conciliator(s) as witness in any Alternative Dispute Resolution or Judicial proceedings in respect of a Disputes that is/was the subject of that particular Conciliation proceeding.
32. None of the Conciliators shall act as an arbitrator or as a representative or counsel of a Party in any arbitral or judicial proceeding in respect of a Disputes that is/was the subject of that particular Conciliation proceeding.
33. The Parties shall not initiate, during the Conciliation proceedings, any arbitral or judicial proceedings in respect of a Disputes that is the subject matter of the Conciliation proceedings except that a Party may initiate arbitral or judicial proceedings where, in his opinion, such proceedings are necessary for preserving his rights including for preventing expiry of period of limitation. Unless terminated as per the provisions of this Scheme, the Conciliation proceedings shall continue

notwithstanding the commencement of the arbitral or judicial proceedings and the arbitral or judicial proceedings shall be primarily for the purpose of preserving rights including preventing expiry of period of limitation.

34. The official language of Conciliation proceedings under this Scheme shall be English unless the Parties agree to some other language.

Format 2 to BHEL Conciliation Scheme, 2018

**FORMAT FOR SEEKING CONSENT FOR REFERRING THE DISPUTES TO
CONCILIATION THROUGH IEC**

To,

M/s. (Stakeholder's name)

**Sub: Resolution of the Disputes through conciliation by Independent
Expert Committee (IEC).**

Ref: Contract No/MoU/Agreement/LOI/LOA& date _____.

Sir,

With reference to above referred Contract/MoU/Agreement/LOI/LOA, you have raised certain Disputes/claims. Vide your letter dated____ you have requested BHEL to refer the Disputes/claims to IEC for Conciliation.

We are enclosing herewith Format (3) for giving consent and the terms and conditions of BHEL Conciliation Scheme, 2018 governing conciliation through IEC. You are requested to give your unconditional consent to the said terms and conditions of the Scheme by returning the same duly sealed and signed on each page. On receipt of your consent, matter will be put to the Competent Authority for consideration and decision.

Please note that BHEL has also certain claims against you (if applicable). BHEL reserves its right to agree or not to agree conciliation of the said disputes through BHEL and this letter is being issued without prejudice to BHEL's rights and contentions available under the contract and law.

Yours faithfully,

Representative of BHEL

Format 3 to BHEL Conciliation Scheme, 2018
FORMAT FOR GIVING CONSENT BY
CONTRACTOR/VENDOR/CUSTOMER/COLLABORATOR/CONSORTIUM PARTNERS FOR REFERRING THE DISPUTES TO CONCILIATION THROUGH IEC

To,
 BHEL

.....

Sub: Resolution of Disputes through Conciliation by Independent Expert Committee (IEC).

Ref: Contract/MoU/Agreement/LOI/LOA No & date____

With reference to above referred contract, our following bills/invoices/claims submitted to BHEL are still unpaid giving rise to Disputes:

SL. no.	Claim Description	Bill submitted to BHEL (no. and date)	Amount of the bill/claim	Amount received from BHEL	Outstanding Amount

Accordingly we request you to kindly refer the Disputes in respect of above claims to IEC for Conciliation.

We hereby agree and give our unconditional consent to the terms and conditions of BHEL Conciliation Scheme, 2018 governing conciliation through IEC. We have signed the same on each page and enclosed it for your consideration.

Yours faithfully,

(Signature with stamp)

Authorized Representative of Contractor

Name, with designation

Date

Format 5 to BHEL Conciliation Scheme, 2018
STATEMENT OF CLAIMS/COUNTER CLAIMS TO BE SUBMITTED TO
THE IEC BY BOTH THE PARTIES

1. Chronology of the Disputes
2. Brief of the Contract/MoU/Agreement/LOI/LOA
3. Brief history of the Disputes:
4. Issues:
5. Details of Clam(s)/Counter Claim(s):

SI. No.	Description of claim(s)/Counter Claim	Amount (in INR)Or currency applicable in the contract	Relevant contract clause

6. Basis/Ground of claim(s)/counter claim(s) (along with relevant clause of contract)

Note– *The Statement of Claims/Counter Claims may ideally be restricted to maximum limit of 20 pages. Relevant documents may be compiled and submitted along with the statement of Claims/Counter Claims. The statement of Claims/Counter Claims is to be submitted to all IEC members and to the other party by post as well as by email.*

Bill of Quantity cum Price Schedule (Annexure-I)

Name of Project: TANGEDCO ENNORE SEZ

Name of Work: Installation, Testing & Commissioning of 19/33 kV (E), 1C × 500 sq. mm Al. Conductor, XLPE Insulated, Armoured MV Power Cable — between Ennore SEZ TPS Main Plant Area to Sea Water Intake Pump House (outside plant boundary, approx. 4 km route length) on Cable Trench / Vertical Support / Pier-Mounted Cable Tray (at heights ranging from approx. 5.0 m to 12.5 m above ground level) / Cable Trestle at Ennore SEZ Project in Tamil Nadu.

Tender Specification No. : - TBSM/33KV CABLE/ETC/TENDER/26-27, Date: 07.05.2026

SR.NO.	Description of Item	Quantity	UOM	Unit Rate	AMOUNT
1	<p>Installation of MV Power Cable 19/33 kV (E), 1C × 500 sq. mm Aluminium Conductor, XLPE Insulated, Armoured Cable to be laid on cable trays on Cable Trench / Vertical Support / Pier-Mounted Cable Tray / Cable Trestle or directly under-ground.</p> <p>(1) 2 Circuits in Formation (total 6 Nos. Single Core Cables) from Ennore SEZ TPS Main Plant Area to Seawater Intake Pump House (outside plant boundary, approx. 4 km route length) on Cable Trench / Vertical Support / Pier-Mounted Cable Tray (at heights ranging from approx. 5.0 m to 12.5 m above ground level) / Cable Trestle/ under-ground. Scope includes loading from site store, transportation to cable laying route, unloading, handling, storage, shifting, cable laying, dressing and installation of Cable Accessories, Jointing & Termination Kits, Junction Boxes, Earthing works, security, material reconciliation and handing over of surplus materials to BHEL / Customer on completion. Provision of all manpower, labour, tools & plants, testing kit, hydra, crane, cable pulling winch, cable rollers and DG Set / AC power supply for in-route installation activities is in Bidder's scope.</p> <p>Scope also includes associated works & minor supply of cable tag, cable marker, route markers, as applicable, small consumables, minor modifications in civil works, fabrication and welding etc. for completion of activities shall be in contractor's scope.</p> <p>Scope also include providing round-the-clock security (watch & ward) for 19/33 kV cables and associated accessories including termination kits, jointing kits and earthing materials, within and beyond Ennore SEZ Thermal Power Station boundary, along the entire cable route from Main Plant Area to Seawater Intake Pump House (approx. 4 km). Scope includes security of materials at site store, temporary storage areas, erection locations, laid cable route etc to complete. Cable is already stored (unloaded) at Ennore site store.)</p>	26	Km	₹ 1,94,750.00	₹ 50,63,500.00
2	<p>Cable Accessories: Installation of 33 kV indoor/outdoor heat-shrinkable type cable termination kits, suitable for 19/33 kV, 1C × 500 sq. mm cable (one set per cable end), complete in all respects. Scope includes cable preparation, lug crimping, application of heat-shrink components, sealing, earthing of armour / screen, earthing cable / braided strip connection for cross bonding provisions, dressing, clamping and all associated works as per manufacturer's guidelines. Installation shall be carried out only by OEM-certified cable jointers from approved manufacturers such as Raychem RPG, 3M India, Cabseal or equivalent. Supply of kits, lugs and earthing materials shall be in BHEL's scope.</p>	24	Set	₹ 4,275.00	₹ 1,02,600.00
3	<p>Cable Accessories: Installation of 33 kV indoor / outdoor heat-shrinkable type Straight Through Jointing Kits, suitable for 19/33 kV, 1C × 500 sq. mm cable (1 set equals jointing of two single core cables), complete in all respects. Scope includes cable preparation, lug crimping, application of heat-shrink components, sealing, earthing of armour / screen, earthing cable / braided strip connection for cross bonding provisions, dressing, clamping and all associated works as per manufacturer's guidelines. Installation shall be carried out only by OEM-certified cable jointers from approved manufacturers such as Raychem RPG, 3M India, Cabseal or equivalent. Supply of kits, lugs and earthing materials shall be in BHEL's scope.</p>	66	Set	₹ 4,275.00	₹ 2,82,150.00
4	<p>Cable Accessories: Installation of Cable Link Box suitable for cross bonded arrangement of 3-phase 19/33 kV cable joint. Scope includes mounting hardware, connection of earthing cable / braided strip coming out from cable jointing & termination kits and all associated works required for completion of work.</p>	26	Set	₹ 4,275.00	₹ 1,11,150.00
5	<p>Testing & commissioning of 33 kV Cable & Accessories: Complete site testing of the 33 kV cable system, including cables, terminations, Link Box, and joints, Earthing along with provision of all required testing equipment. Scope includes high-voltage pressure testing of the cable as per relevant standards (IS 7098), and completion of all testing activities in all respects.</p>	1	Lot	₹ 1,90,000.00	₹ 1,90,000.00

Bill of Quantity cum Price Schedule (Annexure-I)

Name of Project: TANGEDCO ENNORE SEZ

Name of Work: Installation, Testing & Commissioning of 19/33 kV (E), 1C × 500 sq. mm Al. Conductor, XLPE Insulated, Armoured MV Power Cable — between Ennore SEZ TPS Main Plant Area to Sea Water Intake Pump House (outside plant boundary, approx. 4 km route length) on Cable Trench / Vertical Support / Pier-Mounted Cable Tray (at heights ranging from approx. 5.0 m to 12.5 m above ground level) / Cable Trestle at Ennore SEZ Project in Tamil Nadu.

Tender Specification No. : - TBSM/33KV CABLE/ETC/TENDER/26-27, Date: 07.05.2026

SR.NO.	Description of Item	Quantity	UOM	Unit Rate	AMOUNT
6	Supply and Installation of Panel Supporting Angles / Channel etc. Structural Steel Work welded in built up sections like angles, channels & framed work etc including providing cutting, hoisting, fixing in position and applying a priming coat of approved steel primer all complete	0.1	MT	₹ 1,14,000.00	₹ 11,400.00
7	Earthing work with 75X12 GI Flat : Installation of GI Flat including cutting, bending, welding with GI Flat / MS Rod, supply and application of paint, clamping to structure/building wall etc. to complete in all respect. All arc welding shall be done with low hydrogen content electrodes. the welds should be treated with two coats of metal primer (comprising of red oxide and zinc chromate in a synthetic medium) followed by two finishing coats of aluminum paint. The red oxide and zinc chromate shall conform to IS:2074	0.5	km	₹ 10,45,000.00	₹ 5,22,500.00
8	Earthing work with 50x6 GI Flat : Installation of GI Flat including cutting, bending, welding with GI Flat / MS Rod, supply and application of paint, clamping to structure/building wall etc. to complete in all respect. All arc welding shall be done with low hydrogen content electrodes. the welds should be treated with two coats of metal primer (comprising of red oxide and zinc chromate in a synthetic medium) followed by two finishing coats of aluminum paint. The red oxide and zinc chromate shall conform to IS:2074	0.5	km	₹ 6,17,500.00	₹ 3,08,750.00
9	Earthing material- 40 mm Dia MS Rod , Work includes cutting, bending, welding, applying red oxide & anti corrosive paint, clamping to structure/building wall etc. to complete. Hardware required for connecting flat on pads of structure & equipment included in scope. Excavation wherever required including backfilling and compaction of backfilled earth is included in scope. (Note - Material is already unloaded at Ennore Site Store)	0.1	MT	₹ 7,12,500.00	₹ 71,250.00
10	Supply and installation of Insulated flexible Copper Braided strip of required size (25x6)	200	m	₹ 2,090.00	₹ 4,18,000.00
11	Supply and installation of Tinned COPPER LUG for flexible Copper Braided strip of required size (25x6) Copper Braid	60	Nos	₹ 142.50	₹ 8,550.00
12	Supply of Anchor Fastners/ Bolts : of required size (M12/M16/M20 upto 150mm long) of Anchor Fastner /Bolts and fixing in Concrete/wall/ceiling wherever required.	100	Kg	₹ 114.00	₹ 11,400.00
13	Supply of Equipment Fixing Hardware - Full Threaded bolts with nut and two Plane Washer and one Spring Washer as per technical specification	100	Kg	₹ 142.50	₹ 14,250.00
14	Civil Work for directly buried in ground (directly underground) Cable (Excluding cable and accessories with covered in separate BOQ item) in flat/trefoil formation, Scope includes: excavation of trench 0.8m wide, (1.05 m depth / 1.5 m at road crossings), 100mm sand bedding at trench bottom, laying of cable, 100mm sand cover over cable, supply and installation of protective concrete tiles/bricks extending 50mm beyond cable on each side, supply and laying of warning/marker tape, backfilling with excavated soil in compacted layers and restoration of surface to original condition , cable loading, transportation, laying, dressing, fixing of trefoil/flat clamps, and all incidental works with contractor's own T&P, DG set/power supply etc. The same shall be used for two circuit side by side.	100	m	₹ 590.90	₹ 59,090.00
Total Amount (Excluding GST)					₹ 71,74,590.00

[Validate](#)[Print](#)[Help](#)**Percentage BoQ**

Tender Inviting Authority: BHEL, TBG- SubContracting Department, Sector 16A Noida, UP

Name of Work: "Installation, Testing & Commissioning of 19/33 kV (E), 1C × 500 sq. mm Al. Conductor, XLPE Insulated, Armoured MV Power Cable — between Ennore SEZ TPS Main Plant Area to Sea Water Intake Pump House (outside plant boundary, approx. 4 km route length) on Cable Trench / Vertical Support / Pier-Mounted Cable Tray (at heights ranging from approx. 5.0 m to 12.5 m above ground level) / Cable Trestle at Ennore SEZ Project in Tamil Nadu".

Contract No: TBSM/33KV CABLE/ETC/TENDER/26-27, Date: 07.05.2026

Name of the Bidder/ Bidding Firm / Company :						
PRICE SCHEDULE						
(This BOQ template must not be modified/replaced by the bidder and the same should be uploaded after filling the relevant columns, else the bidder is liable to be rejected for this tender. Bidders are allowed to enter the Bidder Name and Values only)						
NUMBER #	TEXT #	NUMBER #	TEXT #	NUMBER	NUMBER #	TEXT #
SI. No.	Item Description	Quantity	Units	Estimated Rate in Rs.	TOTAL AMOUNT Without Taxes in Rs.	TOTAL AMOUNT In Words
1	2	4	5	6	53	55
1	Total amount as per rates in BOQ (as per Annexure-I) for "Installation, Testing & Commissioning of 19/33 kV (E), 1C × 500 sq. mm Al. Conductor, XLPE Insulated, Armoured MV Power Cable — between Ennore SEZ TPS Main Plant Area to Sea Water Intake Pump House (outside plant boundary, approx. 4 km route length) on Cable Trench / Vertical Support / Pier-Mounted Cable Tray (at heights ranging from approx. 5.0 m to 12.5 m above ground level) / Cable Trestle at Ennore SEZ Project in Tamil Nadu". - Excluding GST	1.000	Nos	7174590.00	7174590.00	INR Seventy One Lakh Seventy Four Thousand Five Hundred & Ninety Only
Total in Figures					7174590.00	INR Seventy One Lakh Seventy Four Thousand Five Hundred & Ninety Only
Quoted Rate in Figures			Select		0.000	INR Zero Only
Quoted Rate in Words			INR Zero Only			

Sl.	BOQ ANNEXURE 1: STANDARD TECHNICAL NOTES & BIDDER'S SCOPE
1	33kV cable system is to be installed between Ennore SEZ main plant area to sea water intake pump house (outside plant boundary).
2	Installation of the cable shall be carried out in a neat and well-dressed manner using Cable Pulling Winch, cable rollers & other applicable T&P for safe installation.
3	Installation testing, and commissioning of the cable & accessories shall be in accordance technical specification and IS 1255:1983 Code of Practice for Installation and Maintenance of Power Cables up to 33 kV. The scope includes complete installation, testing, and commissioning of the 33kV Cable & accessories in all respects.
4	Installation, Testing & Commissioning of 19/33 kV (E), 1C × 500 sq. mm Al. Conductor, XLPE Insulated, Armoured MV Power Cable & accessories — 2 Circuits in Formation (total 6 Nos. Single Core Cables) from Ennore SEZ TPS Main Plant Area to Seawater Intake Pump House (outside plant boundary, approx. 4.5 km route length) on Cable Trench/ cable truss/ Vertical Support / Pier-Mounted Cable Tray (at heights ranging from approx. 5.0 m to 12.5 m above ground level) / Cable Trestle. Scope includes receipt of equipment / material at site (excluding 33kV Cable which is available at site store within plant boundary), unloading, reconciliation, inspection, verification, proper storage, upkeeping during storage, shifting to & from store, assembly, installation, pre-commissioning test and commissioning tests (as per BHEL / Customer FQP), commissioning and handing over of the 33kV Cable System at Ennore SEZ area. Shifting of material between plant store to construction site / construction store, and all T&P including hydra/crane, truck/trailer truck etc shall be in bidder's scope.
5	Scope includes loading from site store, transportation to cable laying route, unloading, handling, storage, shifting, cable laying, dressing and installation of Cable Accessories, Jointing & Termination Kits, Junction Boxes, Earthing works, security, material reconciliation and handing over of surplus materials to BHEL / Customer on completion. Provision of all manpower, labour, tools & plants, testing kit, hydra, crane, cable pulling winch, cable rollers and DG Set / AC power supply for in-route installation activities is in Bidder's scope.
6	Scope also includes associated works & minor supply of cable Tie, Aluminium Cable tag, Aluminium cable marker, route markers, as applicable, small consumables, minor modifications in civil works for opening, fabrication and welding etc. for completion of activities shall be in contractor's scope.
7	Security: Scope also include providing round-the-clock security (watch & ward) for 19/33 kV cables and associated accessories including termination kits, jointing kits and earthing materials, within and beyond Ennore SEZ Thermal Power Station boundary, along the entire cable route from Main Plant Area to Seawater Intake Pump House (approx. 4.5 km). Scope includes security of materials at site store, temporary storage areas, erection locations, laid cable route etc to complete.
8	Remark: 19/33 kV (E) Cable is already stored (unloaded) at Ennore site store. Cable accessories i.e. Termination & Jointing Kit, Formation Clamp, Link Box etc shall be supplied by BHEL and the same are to be unloaded & install by bidder.
9	Please refer drawing PE-DG-412-100-M049 "Sea water Intake Piping Outside Plant Boundary wall", the cable route is highlighted with colour. (The same is subject to minor revision). In some smaller area Cables may also routing through ground level cable trench, hanger, supports, underground or through PVC/Hume pipe over/under ground, through wall etc as per site requirements.
10	Please refer (PE-DG-412-100-M049 "Sea water Intake Piping Outside Plant Boundary wall") Section view Section A-A, Section J-J, Section K-K e.t.c. for provision of cable laying on CABLE CUM PIPE TRESTLE, Further please refer other (indicative) sections such as Section C-C, Section C1-C1 & Section C2-C2, Section C3-C3 Section E-E for cable routing on near Ground Levels. (PLEASE REFER DRAWING FOR DETAILS)
11	Cable shall be laid on cable trays/ racks in the trestle along with the water pipeline as per attached layout drawing. Installation of Cable trays shall be done by BHEL/ its appointed contractor. However, minor modification/ fabrication/ adjustments work for installation of cables in proper manner shall be in contractor scope.
12	Supply of Insulated flexible Copper Braided strip shall have Minimum insulation of rated voltage 6kV & Power Frequency withstand voltage 21kV, size 25x6 or equivalent flexible copper cable shall be of customer approved Reputed make.
13	Supply & Installation of structure work required at cable jointing, cable termination & installation of link box etc (as per requirement for proper installation with well dress and safe manner) shall be supplied and installed at site by contractor and charges for the same shall be included in the contractor's scope.
14	Overall contract value may vary +/- 30%, Individual item may be even gets deleted

Sl.	BOQ ANNEXURE 1: STANDARD TECHNICAL NOTES & BIDDER'S SCOPE
15	The cable may be laid in trefoil formation, Some location orientation of cable tray mentioned in the drawings is subject to revision.
16	ETC work of 33kV cable system and accessories shall comprise of all activities and not limited to the followings. a. Verification and taking over the materials b. Reconciliation and updating of records c. shifting to & from store to work location (Materials shall be shifted between BHEL store to work area) c. Installation/ laying of cables and connection of cables with straight through joints in between and termination kits at end. d. Pre-commissioning test and commissioning tests (As per applicable standards/ customer specifications). e. Handing over of 33kV cable system along with accessories f. Reconciliation and Handing over of balance materials to BHEL/ Customer as required. g. watch and ward from shifting to handing over of the system. Security persons deployed shall be as per the assessment at site. h. Arrangement of electricity and temporary lighting Notes: 1. All materials of cables and accessories are stored in BHEL store within Ennore SEZ Plant boundary. 2. Power supply point shall be provided at a point preferably near to BHEL office and contractor shall make its own arrangement for extension of the supply.
17	All general and special tools and plants for laying and installation of cable and associated system along with rollers, winch machine, hydra/ crane, truck/ trailer truck for shifting of materials from store to working locations shall be in contractor scope.
18	All the annexures/ write-ips attached with specification for cable laying, handling ETC work etc. are to be followed. However, contractor shall carry out work as per instructions/ approved procedure/ FQP (Field Quality plan) from BHEL/ Customer at site. if required, method of statement for carrying out the work shall be made by contractor and it shall get approved by customer/ BHEL.
19	Following items shall be supplied by BHEL as free issue item, however contractor shall keep the records of its usage, a. Cables along with termination kits/ straight through joints a. Tre-foil clamp/ single clamps with its mounting hardware nut bolts b. Earthing cable d. Link box c. 40mm MS Rod and GI Flats for earthing work This is an indicative list, however free issue items shall be provided as per actual requirements at site.
20	All consumables and other materials (where as required) such as Welding Electrodes, Low hydrogen content welding electrode, Ferruls, Paint, bitumen compound, Zinc riched enamel paint, red oxide and zinc chromate paint apart from free issue items required for completion of work in all respect shall be in contractor's scope.
21	All arc welding shall be done with low hydrogen content electrodes for all earthing works i.e. MS Rod, GI Flat & MS Flat. All welding done at site for equipment and structures, shall be painted with zinc rich paint immediately to avoid corrosion. Zinc coating shall be as provided considering coastal area. The welds on 40MM MS Rod should be treated with red oxide primer and afterwards coated with two layers bitumen compound to prevent corrosion.
22	Bidder to supply material of proven design and make, which have already been extensively used and tested. Bidder to obtain approval from BHEL / Customer prior to supply.
23	Cable ends shall be kept sealed to prevent damage. In cable vault, fire resistant seal shall be provided underneath the panels. Wherever cable pass through floor or through wall openings or other partitions, GI/PVC wall sleeves with bushes having a smooth curved internal surface so as not to damage the cable, shall be supplied, installed and properly sealed by the Contractor at no extra charges.

Sl.	BOQ ANNEXURE 1: STANDARD TECHNICAL NOTES & BIDDER'S SCOPE
24	Any cutting of masonry / concrete work, Wall openings at suitable locations, Civil works such as grouting, filling up of crevices/ cut outs etc. during installation of equipment, modification of civil foundations, making holes in the trenches/ building, fixing of trench material shall be done by the bidder and shall be made good including supply and installation of chicken wire mesh to match the original work. Any other damage caused to civil works during ETC work of the equipment/ system shall be made good to the original finish. Cost of the same is deemed inclusive in the scope.
25	Minimum Permissible Bending Radius: The cable should not be bent to a sharp radius. Minimum bending radius shall be as per GTP of cable. Wherever possible, larger bending radius should be used.
26	Looping of cable (in all phases) shall be done on each side of cable end before termination.
27	To avoid damage to the protective covering and the insulation the cable must not be pulled across hard and sharp objects and must not be bent in an inadmissible way.
28	Joint Position - During the preliminary stages of laying the cable, consideration should be given to proper location of the joint position so that when the cable is actually laid the joints are made in the most suitable places. There should be sufficient overlap of cables to allow for the removal of cable ends which may have been damaged. Before jointing is commenced, the insulation resistance of both sections of the cable to be jointed be checked by insulation resistance testing instruments like megger. □
29	Earthing link box with / without SVL (sheath voltage limiter) shall be install as per instructions given by BHEL. Earthing of cable are to be done to meet cross bonding arrangement with and without SVL.

SR_NO	Description_of_Item	Quantity	UOM	REMARK
Installation of MV Power Cable				
1	<p>(1.1) Installation of MV Power Cable 19/33 kV (E), 1C x 500 sq. mm Aluminium Conductor, XLPE Insulated, Armoured Cable to be laid on cable trays on Cable Trench / Vertical Support / Pier-Mounted Cable Tray / Cable Trestle or directly under-ground.</p> <p>(1) 2 Circuits in Formation (total 6 Nos. Single Core Cables) from Ennore SEZ TPS Main Plant Area to Seawater Intake Pump House (outside plant boundary, approx. 4 km route length) on Cable Trench / Vertical Support / Pier-Mounted Cable Tray (at heights ranging from approx. 5.0 m to 12.5 m above ground level) / Cable Trestle/ under-ground. Scope includes loading from site store, transportation to cable laying route, unloading, handling, storage, shifting, cable laying, dressing and installation of Cable Accessories, Jointing & Termination Kits, Junction Boxes, Earthing works, security, material reconciliation and handing over of surplus materials to BHEL / Customer on completion. Provision of all manpower, labour, tools & plants, testing kit, hydra, crane, cable pulling winch, cable rollers and DG Set / AC power supply for in-route installation activities is in Bidder's scope.</p> <p>Scope also includes associated works & minor supply of cable tag, cable marker, route markers, as applicable, small consumables, minor modifications in civil works, fabrication and welding etc. for completion of activities shall be in contractor's scope.</p> <p>Scope also include providing round-the-clock security (watch & ward) for 19/33 kV cables and associated accessories including termination kits, jointing kits and earthing materials, within and beyond Ennore SEZ Thermal Power Station boundary, along the entire cable route from Main Plant Area to Seawater Intake Pump House (approx. 4 km). Scope includes security of materials at site store, temporary storage areas, erection locations, laid cable route etc to complete. Cable is already stored (unloaded) at Ennore site store.)</p>	26	Km	
CABLE ACCESSORIES				
2	<p>(1.2) Cable Accessories: Installation of 33 kV indoor/outdoor heat-shrinkable type cable termination kits, suitable for 19/33 kV, 1C x 500 sq. mm cable (one set per cable end), complete in all respects. Scope includes cable preparation, lug crimping, application of heat-shrink components, sealing, earthing of armour / screen, earthing cable / braided strip connection for cross bonding provisions, dressing, clamping and all associated works as per manufacturer's guidelines. Installation shall be carried out only by OEM-certified cable jointers from approved manufacturers such as Raychem RPG, 3M India, Cabseal or equivalent. Supply of kits, lugs and earthing materials shall be in BHEL's scope.</p>	24	Set	(1) 2 Circuits in Formation (total 6 Nos. Single Core Cables) from Ennore SEZ TPS Main Plant Area to Seawater Intake Pump House (outside plant boundary, approx. 4 km route length) on Cable Trench / Vertical Support / Pier-Mounted Cable Tray (at heights ranging from approx. 5.0 m to 12.5 m above ground level) / Cable Trestle/ under-ground. Scope includes loading from site store, transportation to cable laying route, unloading, handling, storage, shifting, cable laying, dressing and installation of Cable Accessories, Jointing & Termination Kits, Junction Boxes, Earthing works, security, material reconciliation and handing over of surplus materials to BHEL / Customer on completion. Provision of all manpower, labour, tools & plants, testing kit, hydra, crane, cable pulling winch, cable rollers and DG Set / AC power supply for in-route installation activities is in Bidder's scope.
3	<p>(1.3) Cable Accessories: Installation of 33 kV indoor / outdoor heat-shrinkable type Straight Through Jointing Kits, suitable for 19/33 kV, 1C x 500 sq. mm cable (1 set equals jointing of two single core cables), complete in all respects. Scope includes cable preparation, lug crimping, application of heat-shrink components, sealing, earthing of armour / screen, earthing cable / braided strip connection for cross bonding provisions, dressing, clamping and all associated works as per manufacturer's guidelines. Installation shall be carried out only by OEM-certified cable jointers from approved manufacturers such as Raychem RPG, 3M India, Cabseal or equivalent. Supply of kits, lugs and earthing materials shall be in BHEL's scope.</p>	66	Set	
4	<p>(1.4) Cable Accessories: Installation of Cable Link Box suitable for cross bonded arrangement of 3-phase 19/33 kV cable joint. Scope includes mounting hardware, connection of earthing cable / braided strip coming out from cable jointing & termination kits and all associated works required for completion of work.</p>	26	Set	
5	<p>(2) Testing & commissioning of 33 kV Cable & Accessories: Complete site testing of the 33 kV cable system, including cables, terminations, Link Box, and joints, Earthing along with provision of all required testing equipment. Scope includes high-voltage pressure testing of the cable as per relevant standards (IS 7098), and completion of all testing activities in all respects.</p>	1	Lot	
TESTING & COMMISSIONING				
6	<p>(3) Supply and Installation of Panel Supporting Angles / Channel etc. Structural Steel Work welded in built up sections like angles, channels & framed work etc including providing cutting, hoisting, fixing in position and applying a priming coat of approved steel primer all complete</p>	0.1	MT	
7	<p>(4) Earthing work with 75X12 GI Flat : Installation of GI Flat including cutting, bending, welding with GI Flat / MS Rod, supply and application of paint, clamping to structure/building wall etc. to complete in all respect. All arc welding shall be done with low hydrogen content electrodes. the welds should be treated with two coats of metal primer (comprising of red oxide and zinc chromate in a synthetic medium) followed by two finishing coats of aluminum paint. The red oxide and zinc chromate shall conform to IS:2074</p>	0.5	km	
8	<p>(5) Earthing work with 50x6 GI Flat : Installation of GI Flat including cutting, bending, welding with GI Flat / MS Rod, supply and application of paint, clamping to structure/building wall etc. to complete in all respect. All arc welding shall be done with low hydrogen content electrodes. the welds should be treated with two coats of metal primer (comprising of red oxide and zinc chromate in a synthetic medium) followed by two finishing coats of aluminum paint. The red oxide and zinc chromate shall conform to IS:2074</p>	0.5	km	
9	<p>(6) Earthing material- 40 mm Dia MS Rod , Work includes cutting, bending, welding, applying red oxide & anti corrosive paint, clamping to structure/building wall etc. to complete. Hardware required for connecting flat on pads of structure & equipment included in scope. Excavation wherever required including backfilling and compaction of backfilled earth is included in scope. (Note - Material is already unloaded at Ennore Site Store)</p>	0.1	MT	
11	(8) Supply and installation of Insulated flexible Copper Braided strip of required size (25x6)	200.0	m	
12	(9) Supply and installation of Tinned COPPER LUG for flexible Copper Braided strip of required size (25x6) Copper Braid	60.0	Nos	
13	(10) Supply of Achor Fastners/ Bolts : of required size (M12/M16/M20 upto 150mm long) of Anchor Fastner /Bolts and fixing in Concrete/wall/ceiling wherever required.	100.0	Kg	
14	(11) Supply of Equipment Fixing Hardware - Full Threaded bolts with nut and two Plane Washer and one Spring Washer as per technical specification	100.0	Kg	
15	<p>Civil Work for directly buried in ground (directly underground) Cable (Excluding cable and accessories with covered in seperate BOQ item) in flat/trefoil formation,</p> <p>Scope includes: excavation of trench 0.8m wide, (1.05 m depth / 1.5 m at road crossings), 100mm sand bedding at trench bottom, laying of cable, 100mm sand cover over cable, supply and installation of protective concrete tiles/bricks extending 50mm beyond cable on each side, supply and laying of warning/marker tape, backfilling with excavated soil in compacted layers and restoration of surface to original condition , cable loading, transportation, laying, dressing, fixing of trefoil/flat clamps, and all incidental works with contractor's own T&P, DG set/power supply etc. The same shall be used for two circuit side by side.</p>	100	m	

LIST OF ENCLOSED DRAWINGS / DOCUMENTS, Rev.00

REMARK - THE ENCLOSED DRAWINGS / DOCUMENTS ARE PROVISIONAL AND SUBJECT TO REVISION DURING CONTRACT STAGE.

1	Cable Routing Layout, (Sea water Intake Piping Outside Plant Boundary wall)	PE-DG-412-100-M049
2	Other Technical Specification	PE-DC-412-507-E004 R2
3	33KV Cable Drawing	TB-378-316-127-1
4	33KV Cable GTP	TB-378-316-127-1

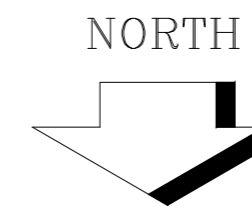

33KV CABLE ROUTE

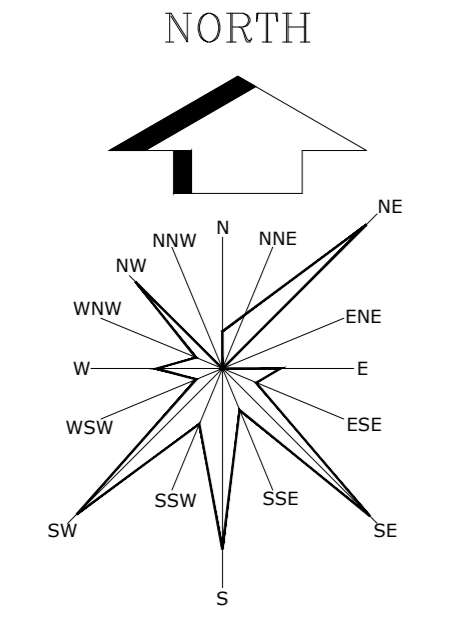
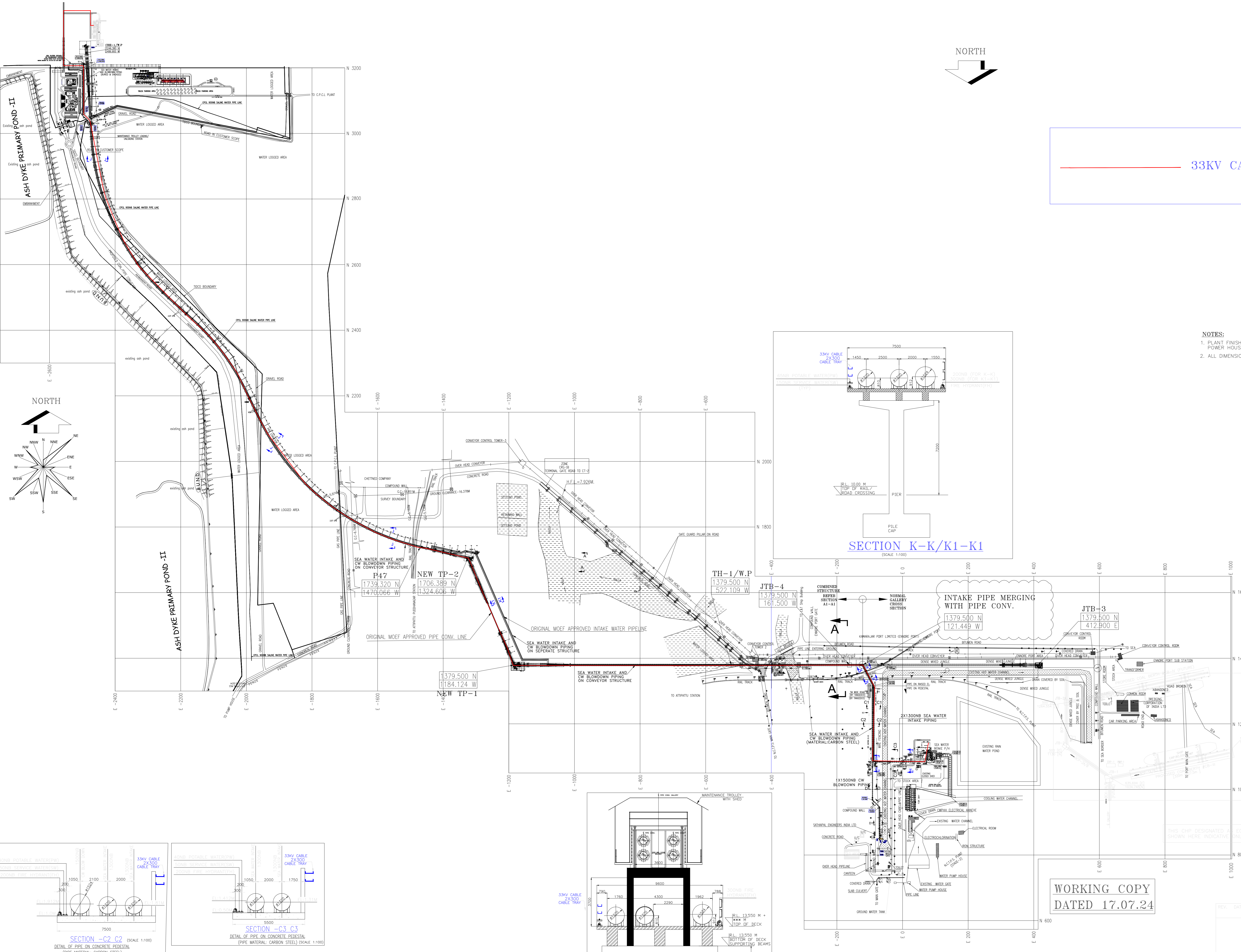

- NOTES:**
1. PLANT FINISHED GRADED LEVEL (FGL) SHALL BE RL (+)8.50M. POWER HOUSE (TG BUILDING) FINISHED GROUND FLOOR LEVEL IS EL(+)+0.00M, WHICH CORR. TO RL(+)+10.0M.
 2. ALL DIMENSIONS ARE IN MM & LEVELS ARE IN METER UNLESS OTHERWISE STATED.

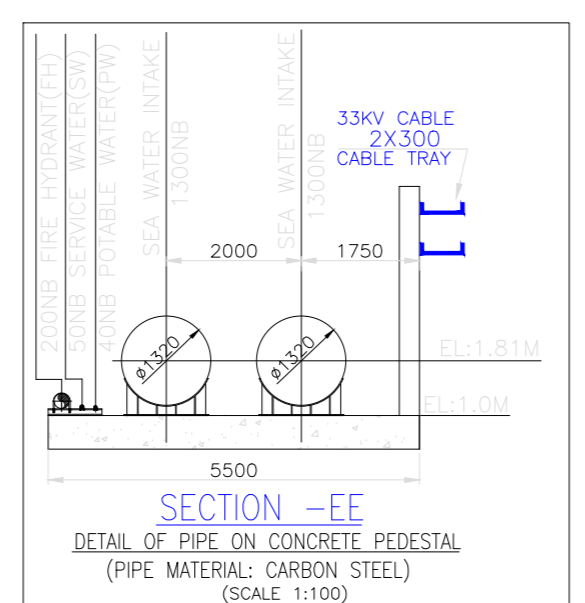
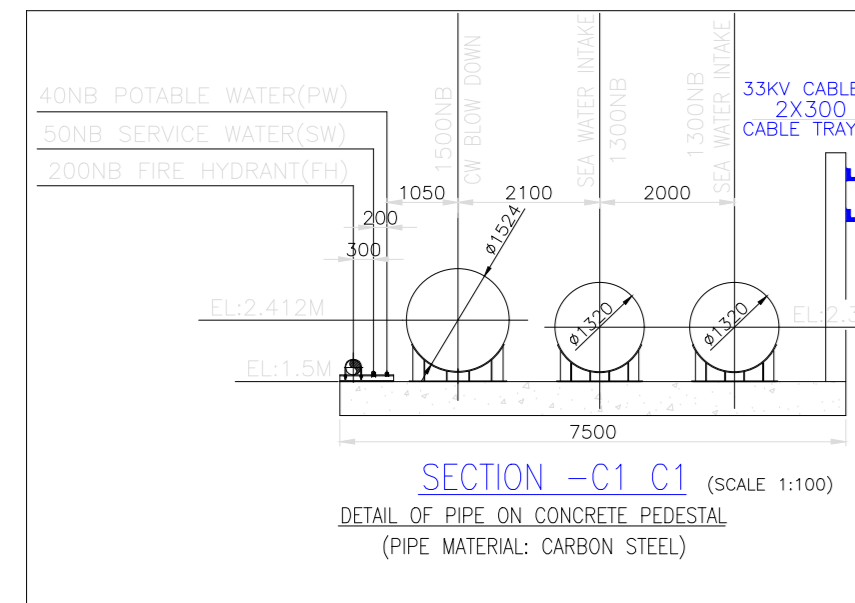
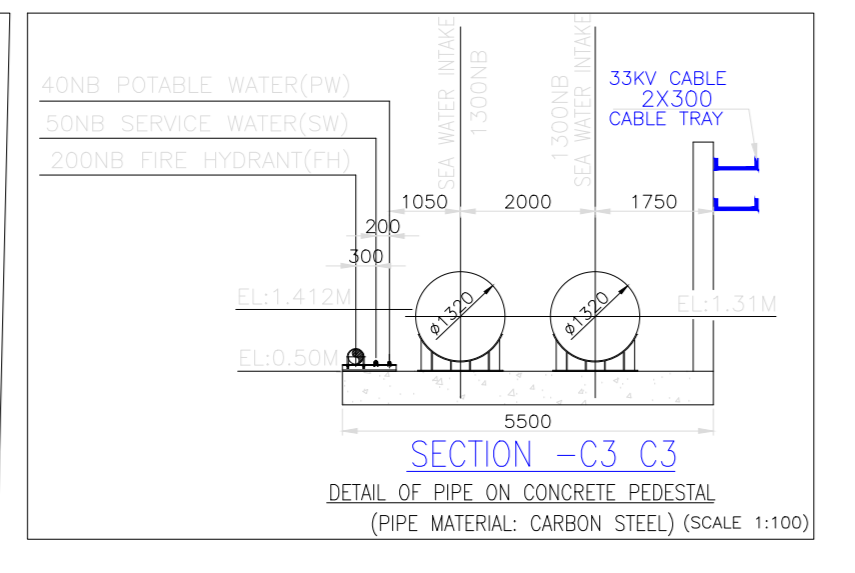
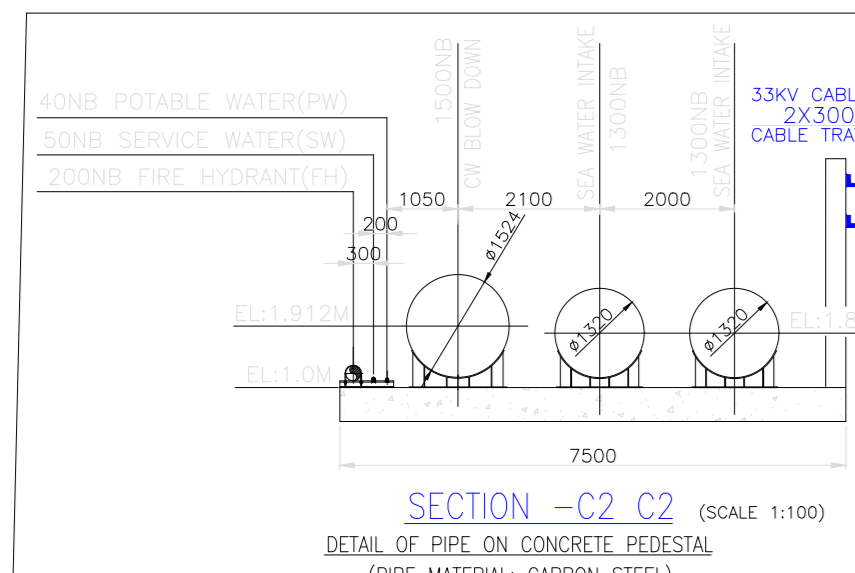
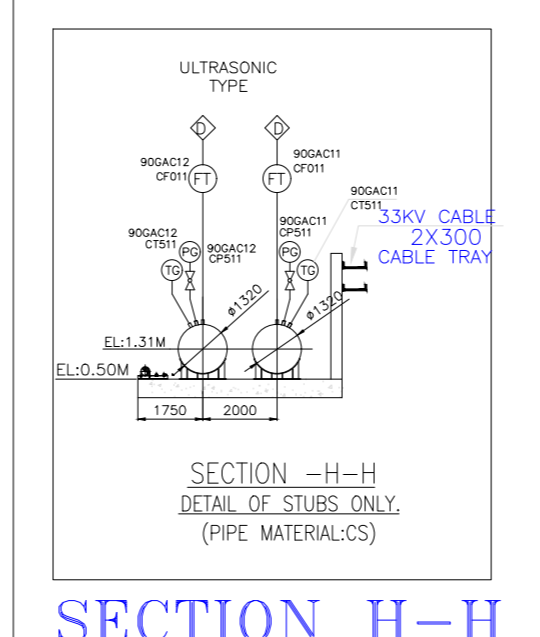
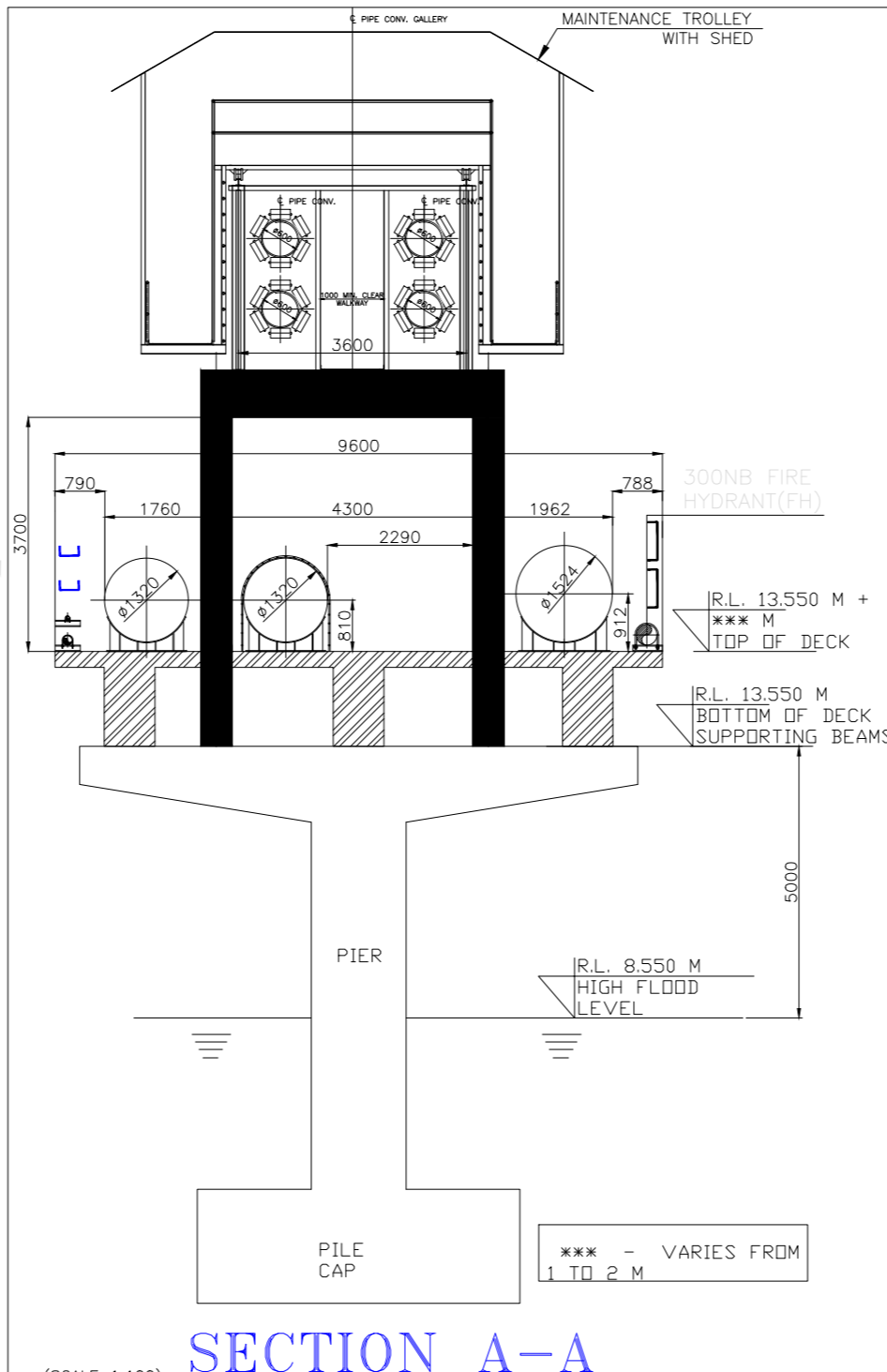
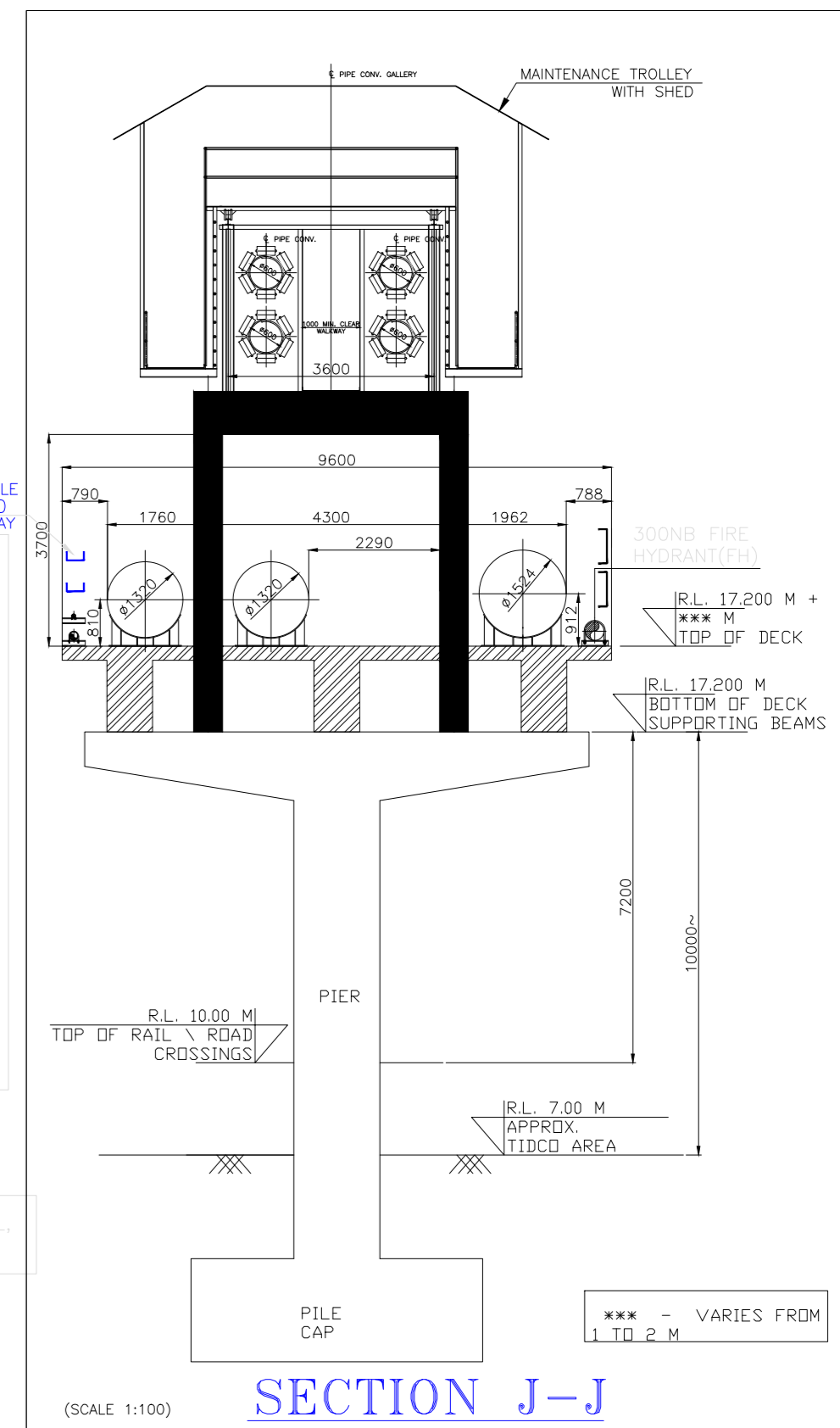
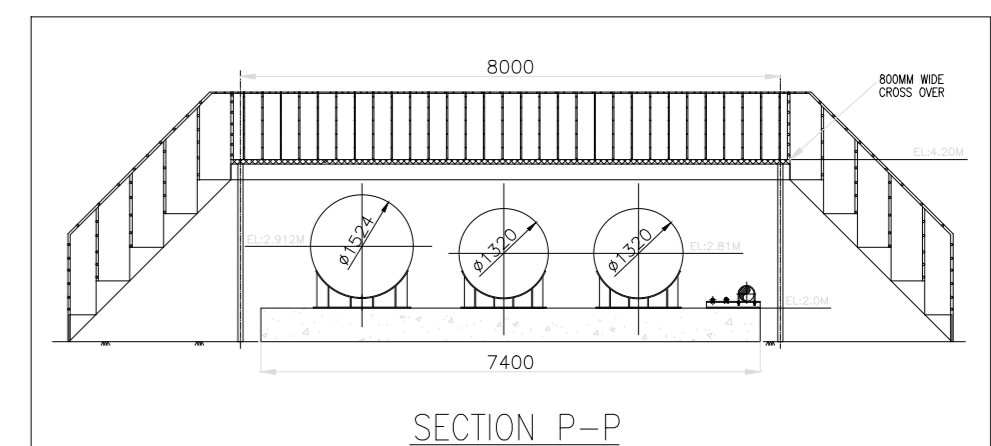
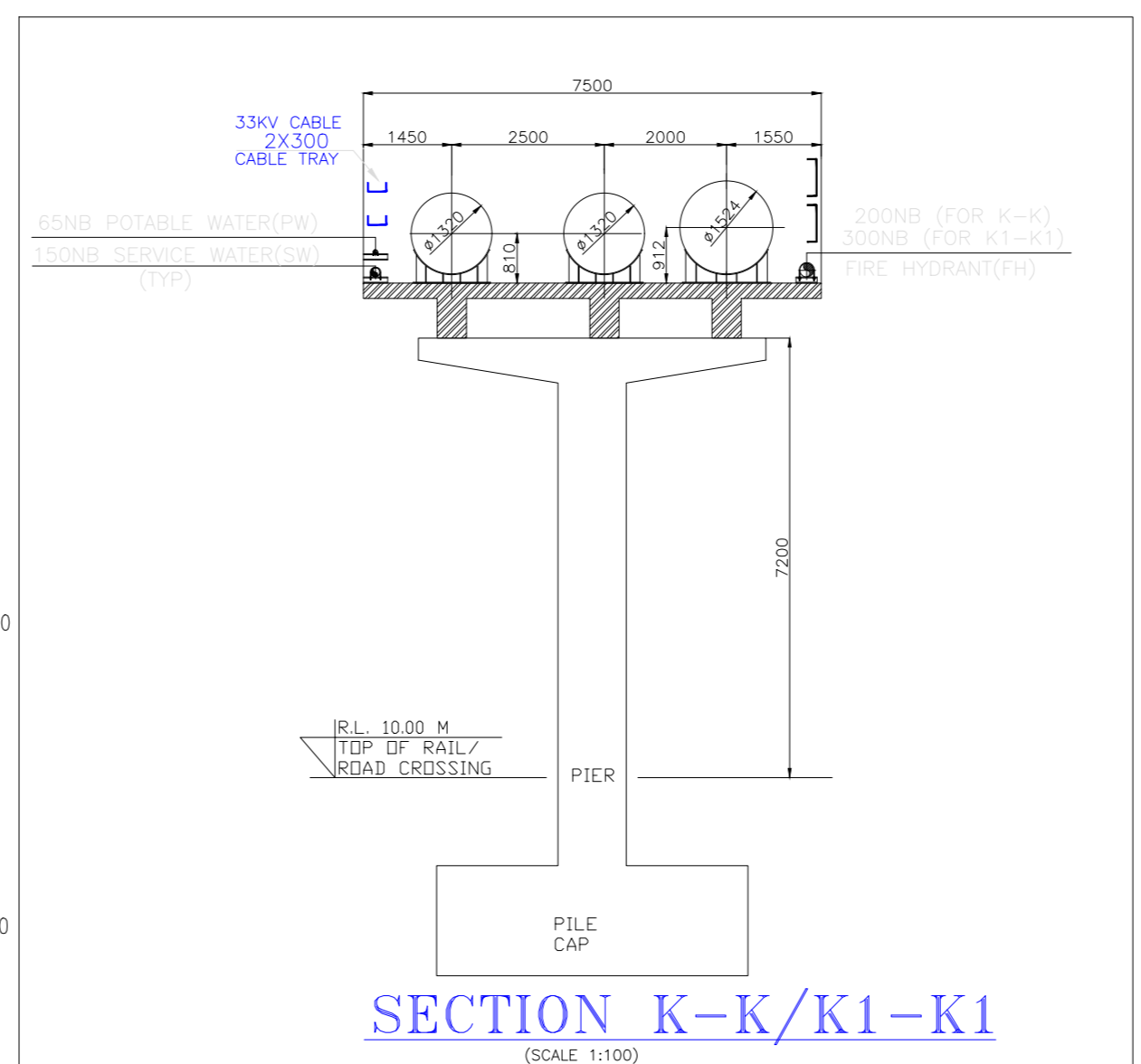

WORKING COPY DATED 17.07.24

REV.	DATE	ALTD.	CHKD.	APPRO.	REV.	DATE	ALTD.	CHKD.	APPRO.

PROJECT	2x660MW ENNORE SEZ SUPERCRITICAL THERMAL POWER PROJECT AT ASH DYKE OF NCTPS, CHENNAI
OWNER	TAMILNADU GENERATION & DISTRIBUTION CORPORATION LIMITED
OWNER'S CONSULTANT	DESEIN PRIVATE LIMITED DESEIN HOUSE, NEW DELHI
EPC CONTRACTOR	BHARAT HEAVY ELECTRICALS LTD.



FIRST ANGLE PROJECTION (ALL DIMENSIONS ARE IN MM)

REV 1	DATE 10.06.15	ALTERED: -sd- CHECKED: -sd-	REV 2	DATE 08.07.15	ALTERED CHECKED	STATUS : CONTRACT JOB NO.: 412
1. DOCUMENT REVISED IN LINE WITH TANGEDCO LETTER REF: SE /E/T&H(P)/EE-6/E/P/F.2X660MW Ennore SEZ STPP/D.98/15, DATED 20.04.2015.			1. DOCUMENT REVISED IN LINE WITH TANGEDCO LETTER REF: SE /E/T&H(P)/EE-6/E/P/F.2X660MW Ennore SEZ STPP/D.194/15, DATED 08.07.2015.			

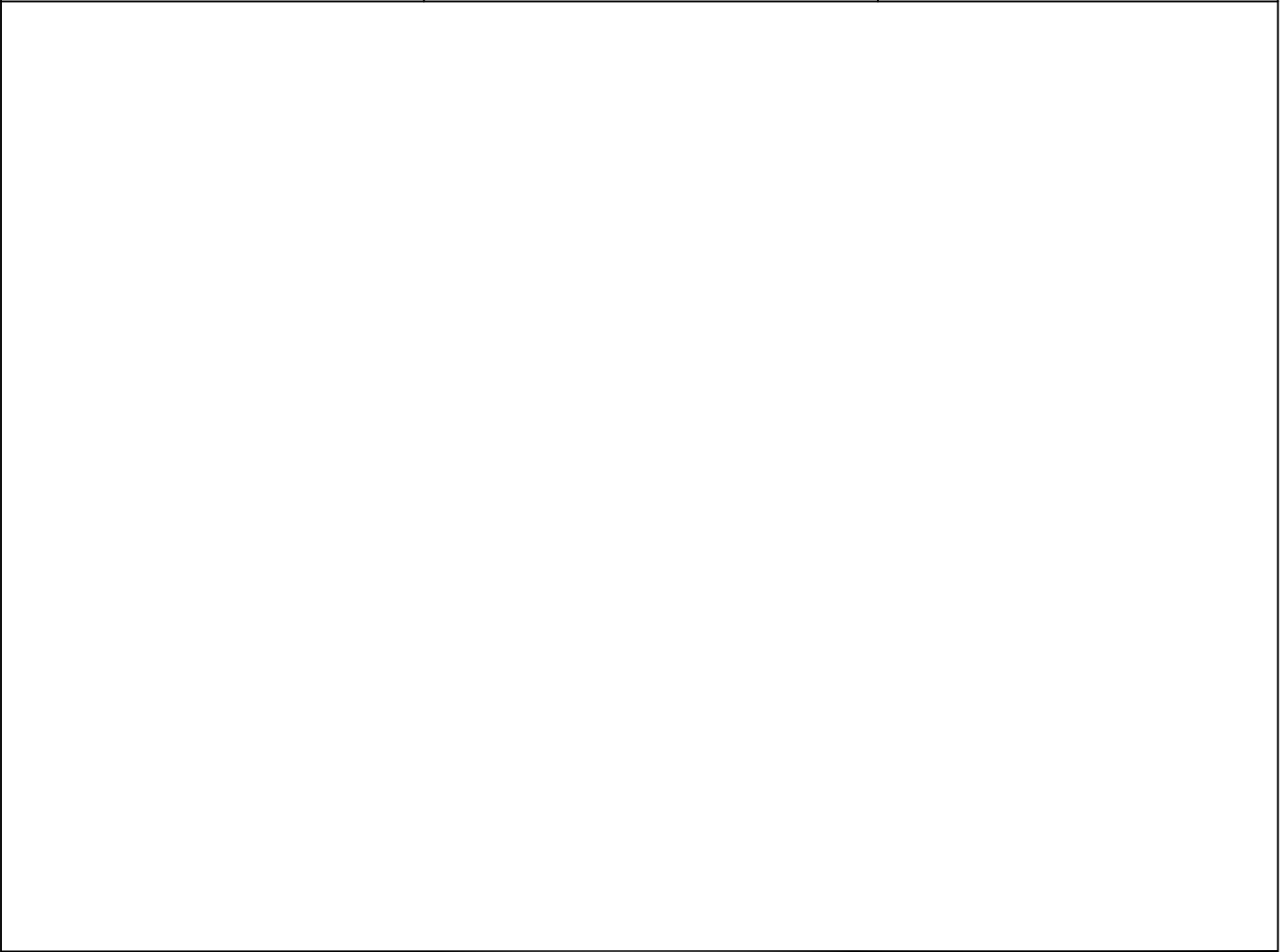
COPY RIGHT AND CONFIDENTIAL
The information on this document is the property of BHARAT HEAVY ELECTRICALS LIMITED it must not be used directly or indirectly in any way detrimental to the interest of the company



2X660 MW ENNORE SEZ COAL BASED STPP AT ASH DYKE OF NCTPS, CHENNAI.

	TAMILNADU GENERATION AND DISTRIBUTION CORPORATION (TANGEDCO)
	CONSULTANT: DESEIN PVT LTD, NEW DELHI.
	BHARAT HEAVY ELECTRICALS LIMITED PROJECTS ENGINEERING MANAGEMENT, NEW DELHI

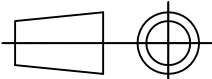
DEPT. E	CODE A		SCALE -	WEIGHT(KG) -	REF DRG. -	ITEM -		
CABLE ERECTION PHILOSOPHY					NAME	SIGN	DATE	
					PREP	AA	-S.D.-	15.12.14
					CHKD	SL	-S.D.-	15.12.14
					APPD	RG	-S.D.-	15.12.14

DEPT.						CARD CODE	DRAWING NO.	REV
SIGN		N.A.				-	PE-DC-412-507-E004	2
DATE								

	2 x 660 MW ENNORE SEZ STPP CABLE ERECTION PHILOSOPHY	DOCUMENT NO. PE-DC-412-507-E004
		Rev No: 2
		Date: 08/07/2015
		SHEET 1 of 10

1.0 Scope

- 1.1 This document is intended to cover the aspects of cable raceway design and installation, laying and termination of various types of cables for main power house and auxiliary plant areas (in BHEL scope) of the project except for those listed under "Exclusions" below.
- 1.2 Design calculations for cable sizing and selection & design memorandum for fire sealing system are covered in separate documents.
- 1.3 Latest revisions of all drawings / documents shall be referred.
- 1.4 Reference standards/ documents.
- 1) IS: 1255 (Code of practice for installation and maintenance of power cables)
 - 2) IEEE 422 : IEEE Guide for the design of Cable Raceway Systems for Electric Generating Facilities
 - 3) IEEE 1185: IEEE Recommended Practice for Cable Installation in Generating Stations and Industrial Facility
 - 4) NEMA VE 1: Metal Cable Tray Systems.
 - 5) NEMA VE
 - 6) Drg. No. PE-DG-412-507-E005 (Typical details of Cable Trays And Accessories)
 - 7) Drg. No. PE-DG-412-507-E006 (Installation details for Cable Tray support system)
- 1.5 Exclusions: - The following areas / systems are excluded from the scope of this document.
- (a) Switchyard.
 - (b) ESP Integral Cabling.
 - (c) Steam Generator integral cabling.
 - (d) Turbine & generator integral cabling.

2.0 Cable Raceway System

- 2.1 Cables shall generally be laid in galvanised MS cable trays in multi-tier arrangement. The trays shall in turn be supported on flexible cable tray support systems in cable vaults, along structural members/ concrete surfaces inside plant buildings, cable trenches below switchboards/ MCCs in auxiliary plant buildings, and interconnecting pipe-cum-cable trestles. The trays shall be fixed to supports by means of bolting. Clamping of trays to the cantilever arms shall be resorted to where due to fabrication mismatches, there are misalignments between the respective locations of holes in trays and the cantilever arms. Cable trays shall be fixed to the horizontal/vertical arm

	2 x 660 MW ENNORE SEZ STPP CABLE ERECTION PHILOSOPHY	DOCUMENT NO. PE-DC-412-507-E004
		Rev No: 2
		Date: 08/07/2015
		SHEET 2 of 10

of supporting structure as per the reference drawings at serial no. 1.4(3) above. Cables can be routed through cable duct bank wherever required.

- 2.2 Generally cable trays shall be oriented horizontally in all areas, except in areas subject to coal dust or ash deposition (such as boiler platforms etc). Cable trays may be oriented vertically in other areas also if so required due to reasons such as space restriction, accessibility, plant aesthetics, operational clearances, etc. as per approved layout drawings. Cable tray cover (1.6 mm thick) shall be provided wherever cable trays are oriented horizontally in boiler area cable trestle and shall be inverted 'V' type on upper tray.
- 2.3 Cable trays shall be generally ladder type of widths 600mm, 450 mm, 300 mm, 150 mm. For screened control cables, perforated type cable trays of 600mm, 450mm, 300 & 150 mm size and below shall be used where required. For instrumentation and control purpose, some perforated type cable trays of width 100 mm may be used. However, in vertical cable tray risers and vertically oriented trays, all trays shall be ladder type. In these trays screened control & instrumentation cables will be laid in ladder type cable trays. Minimum thickness of cable tray shall be 2mm and galvanization thickness shall be 86 microns.
- 2.4 Suitable cable tray accessories such as horizontal and vertical bends, crosses, tees, reducers etc. shall be used in conjunction with straight runs of cable trays wherever required as per approved layout drawings to ensure a continuous and break-free tray support system for cables.
- Tray accessories shall be generally factory fabricated. However the same may also be fabricated at site from the straight length of respective sizes if required.
- 2.5 The cable trays & accessories shall be of approved makes, and generally conforming to reference drawing at 1.4 (2). Minor fabrication differences (which do not affect the overall dimensions of the trays) due to specific manufacturing practices of different trays manufacturers shall be acceptable.
- 2.6 Cable trays of width 600 mm shall be subjected to deflection test as under: -
- A 2.5 metre straight section of cable trays shall be simply supported at the two ends. A uniformly distributed load of 100 Kg per meter for 600mm tray will be applied along the length of the tray. The maximum deflection at the mid span shall not exceed 7 mm.
- 2.7 FRP cable trays shall be provided in intake raw water pump house, desalinating plant, CHP, Battery Room, NDCT & Chemical house.
- 2.8 The flexible cable tray support system shall comprise of galvanised MS single channel (C1) or double channel (C2) members as main supports, to which galvanised MS cantilever arms of sizes commensurate with the tray being supported shall be fixed by means of spring nuts. Along overhead cable tray paths employing trays installed in vertical orientation, trays may be fixed directly to the vertical channel supports (e.g. along cable trestles) through bolting/ clamping.

	2 x 660 MW ENNORE SEZ STPP CABLE ERECTION PHILOSOPHY	DOCUMENT NO. PE-DC-412-507-E004
		Rev No: 2
		Date: 08/07/2015
		SHEET 3 of 10

- 2.9 Cable tray risers in plant buildings shall be supported on cage structures made from double channels as vertical members along the four vertices of a rectangle and single channel horizontal members connected to the vertical members at every 1000mm. Each tray of the risers will be fixed directly to one horizontally fixed single channel available at every 1000mm within this cage.
- 2.10 The main supports (single/ double channels) shall be fixed to concrete/ steel surfaces by means of clamps/ brackets with spring nuts. The clamps/ brackets shall be fixed to the corresponding surfaces as permitted by site conditions in any of the following ways as per approved Document No. PE-DG-412-507-E006, Installation Details for Cable trays Support System (Boltable type) :
- a) Fixed with anchor bolts directly to concrete surface
 - b) Welded to steel inserts where available in the concrete surface
 - c) Clamped to steel structural members
 - d) Welded to steel structural members (except vertical bracings)-wherever clamping is not possible.
- 2.11 Horizontal runs of cable trays shall be supported at intervals of 1500mm approximately. Vertical runs (risers) shall be supported at approximately every 1000mm interval if the floor to floor distance does not exceed 10m; otherwise same shall be supported at every 750mm. Spacing between cable trays shall normally be kept 300mm for cable laying convenience and effective heat dissipation. However, wherever layout constraints do not permit this spacing, the same may be reduced to 250mm, for trays carrying control and instrumentation cables.
- The cable tray numbering shall be provided at every 10 meter and at each end of cable tray & branch connection.
- 2.12 All galvanisation damaged due to cutting/ welding operation required to be carried out for the installation of the support system, cable trays & accessories shall be made good with application of two coats of cold galvanisation paint.
- 2.13 Cable trays shall be grounded as per the provisions of the approved grounding document for the project.
- 2.14 For laying cables along building steel structures or masonry structures, the cables shall be fixed by clamping with GI saddles screwed to the GI flats welded/ embedded to the structures.
- 2.15 For laying cables along concrete walls, ceilings etc., the cables shall be clamped with GI saddles screwed to the GI flats welded to the inserts. Where inserts are not available the saddles may be directly fixed to the walls using anchor bolts and MS flat spacers of minimum 6mm thickness.
- 2.16 Provisions of IS: 1255 shall be followed for cables buried directly in ground. For road/rail crossings, buried pipes (at a depth of minimum 1000mm) shall be used.

	2 x 660 MW ENNORE SEZ STPP CABLE ERECTION PHILOSOPHY	DOCUMENT NO. PE-DC-412-507-E004
		Rev No: 2
		Date: 08/07/2015
		SHEET 4 of 10

Alternatively, RCC duct banks may also be used. Buried cable routes shall have marker projecting 150 mm above ground and shall be spaced at an interval of 30 m along the route and at every bend. Though directly buried cable shall generally be avoided and will be only used for street lighting; however specific approval shall be taken in other areas in case same is unavoidable due to layout constraint.

- 2.17 Local cabling near equipment shall be done using GI conduit/ cable slits/ local trays as per layout conditions.
- 2.18 Cables for redundant equipment shall be run in separate trays/ separate route, as far as possible.
- 2.19 Cables from two different services viz. supply from station board and supply from unit board shall be segregated to prevent simultaneous damage due to fire in one of the services.
- 2.20 Switchgear in the main plant building, ESP control room building, Sea water Intake Pump house, Compressor house, CHP & AHP switchgear rooms, RODM switchgear room and switchyard control room will be located on RCC floors with a cable vault provided below each switchgear room. Cable vault in main power house shall have minimum height of 3.5mtrs.
Switchgear in auxiliary plant buildings will generally be trench mounted, and located inside switchgear/ MCC rooms. The depth of trench shall be 500mm below finished ground level.

REV 2

- 2.21 False flooring shall be generally avoided for cabling purposes.

3.0 **General Philosophy of Cable Installation**

- 3.1 Laying, dressing, clamping and jointing/ termination process of power, control and instrumentation cables shall follow the requirements of IS: 1255.
- 3.2 All precautions as per IS: 1255 & Field Quality Plan (FQP) shall be taken while handling the cables.
- 3.3 For the purpose of cable laying, the cables are categorised as under:
- a) HT: Power cables of 11KV , 3.3KV grade
 - b) LT: Power cables of 1.1kV grade, catering to loads at 415V AC/ 230V AC/ 220V DC/ 24V DC
 - c) Control: Control cables of 1.1kV grade generally carrying control signals at 220V DC/ 110V AC.
 - d) Instrumentation: (Also called screened control cables): Screened cables of 1100 V grade with minimum cross section of 0.5 sq mm generally carrying very low voltage very low current signals.

Separate coloured paint strips shall be applied for identification of different type of trays depending upon types of usage/applications/area as below:

	2 x 660 MW ENNORE SEZ STPP CABLE ERECTION PHILOSOPHY	DOCUMENT NO. PE-DC-412-507-E004
		Rev No: 2
		Date: 08/07/2015
		SHEET 5 of 10

- (I) High/ medium voltage cables: Red strips, 2 inch width each, numbers 11kV/3.3kV equally spaced at 5 metres interval
- (II) 1.1kv power cables: Yellow Strips ----- do -----
- (III) 1.1kv control cables: Blue Strips ----- do -----
- (IV) Instrumentation cables: Green Strips ----- do -----
- 3.4 All cables shall be provided with identification tags indicating the cable numbers in accordance with the cable circuit schedule. Cable tags shall be fixed at terminal ends, at tray intersection / bend and at each side of floor/ wall/ duct crossings etc and at every 20m in cable trench/tray or buried run.
- 3.5 Single core cables for a. c. three phase circuits, when laid on trays, shall be in trefoil formation (each trefoil with RYB phases formation), with each trefoil two 'D' apart from the next trefoil in the tray. 'D' is the diameter of cable. The trefoil formation shall be duly secured to the cable tray by means of trefoil clamps of nonmagnetic type (Aluminium or Nylon-6 clamps) at every 1000 mm interval. Trefoil Clamps shall have adequate mechanical strength to withstand the forces generated by short circuit of 105 kA peak.
- 3.6 Multi-core cables 11/3.3 kV grade when laid on trays shall be in one layer, touching (As per Design calculations for cable sizing & calculation) and clamped by means of nylon cable ties.
- 3.7 1100 V grade multi-core power cables carrying continuous current when laid on trays shall be placed in single layer, touching and clamped by means of nylon cable ties. Cables of sizes indicated below, shall be clamped individually.
- (a) Single core cables : 500 sq mm or higher (when not laid in trefoil formation- e.g. dc circuits)/ neutral cables)
- (b) Multi-core cables : 95 sq mm or higher
- 3.8 Control and instrumentation cables shall be laid in multi layers, but not exceeding three layers in any section. Special purpose cables (e.g. IPB, WAN etc.) shall be laid as per system manufacturer/ supplier recommendations with due regard to segregation of routes for redundant circuits.
- REV 2** 3.9 While power, control and instrumentation cables shall generally be laid in separate trays, low current carrying power cables (valve/ damper actuator power cables) may be laid along with control cables. In most such cases, the control cable sizes shall be 1.5 Sq mm, however for CT/PT connections same shall be 2.5 Sq mm; Further for few cases, higher sizes if required as per approved cable sizing calculations (due to voltage drop criterion) may be used.
- 3.10 Cables shall be placed on trays on the basis of their types and functions as under for horizontal formations:
- a) HT cables: in the top tier(s) of ladder type trays.



2 x 660 MW ENNORE SEZ STPP
CABLE ERECTION PHILOSOPHY

DOCUMENT NO.
PE-DC-412-507-E004
Rev No: 2
Date: 08/07/2015
SHEET 6 of 10

- b) LT power cables: in the ladder tray(s) below the HT cable trays.
- c) Control cables: in the ladder tray(s) next below to the LT power cable tray(s).
- d) Instrumentation cables (screened control cables): in the bottom most perforated tray(s).

3.11 For vertical formations, the outermost tray shall be considered as the topmost tray and the order as indicated shall be followed. In rare cases, where there is no clear distinction of bottom/ top trays, the order convenient for linking the horizontal and vertical formations avoiding criss-crossing, or exit of cables shall be followed.

Typical examples of tray numbering are given overleaf.

REV 2

3.12 Wherever it is not possible to accommodate cables as per the criteria indicated in the clauses 3.10 & 3.11 (due to layout constraints) for lengths not exceeding more than 5 mtrs, control cables may be laid in the same tray with the instrumentation cables with clear minimum gap of 100mm between the two types of cables.

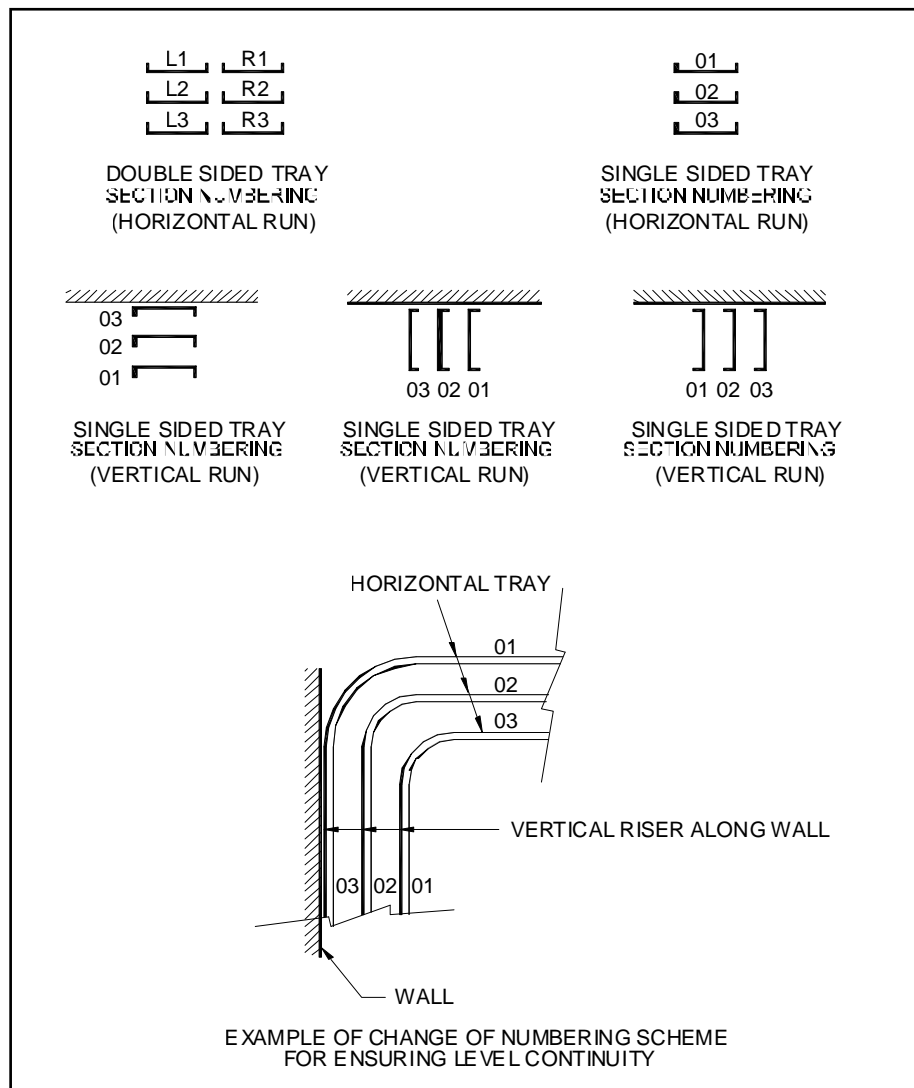

	2 x 660 MW ENNORE SEZ STPP CABLE ERECTION PHILOSOPHY	DOCUMENT NO. PE-DC-412-507-E004
		Rev No: 2
		Date: 08/07/2015
		SHEET 7 of 10

3.13 No single core cable shall pass through a GI conduit/ pipe or duct singly except DC single core cables. AC single core cables shall pass through GI conduit/ pipe in trefoil formation only, or through PVC pipes. Conduit/pipe occupancy (ratio of total cable area to conduit area shall not exceed the following: -

- 1) One Cable: 53 %
- 2) Two Cables: 31 %
- 3) Three Cables & Up: 40 %

Exposed pipes/ conduits if used in corrosive areas shall have anti-corrosive coating both inside & outside.

3.14 Conduits shall be of rigid steel, hot dip galvanised, furnished in standard length of 5 metres, which shall be as per IS:9537.

3.15 Cable clamping spacing for cables laid in cable trays shall be generally as under:

(a) Trefoil clamps (Aluminium or Nylon-6 clamps):

- 1) Horizontal run spacing: 1000 mm (max.)
- 2) Vertical run spacing: 1000 mm (max.)

(b) Other Ties/ Strips

1. Power cables of sizes indicated under

- (i) Single core cables: 500 sq mm or higher

(When not laid in trefoil formation- e.g. dc circuits)

- (ii) Multi core cables: 95 sq mm or higher

Horizontal runs: Individually tied at 1000 mm interval (max.) by Nylon ties/ strip
Vertical runs: Individually clamped at 1000 mm interval (max.) by Aluminium strip (25 x 3 size)

2. Power cables of other sizes

Horizontal runs: Collectively tied at 1000 mm interval (max.) by Nylon Ties/ strip
Vertical runs: Collectively clamped at 1000 mm interval (max.) by Aluminium strip (25 x 3 size)

	2 x 660 MW ENNORE SEZ STPP CABLE ERECTION PHILOSOPHY	DOCUMENT NO. PE-DC-412-507-E004
		Rev No: 2
		Date: 08/07/2015
		SHEET 8 of 10

3. Control Cables

Horizontal runs:	Collectively tied at 1000 mm interval (max.) by Nylon Ties/ strip
Vertical runs:	Collectively tied at 1000 mm interval (max.) by Nylon Ties

3.16 Clamp spacing for cables supported directly along structure/ ceiling shall be as under:

a) Clamp spacing

1. In horizontal runs: 1000 mm (max.)

2. In vertical runs: 1000 mm (max.)

b) Spacing between cables: 30 mm (min.)

c) Supports shall also be provided at each bend.

REV 2

3.17 Special tools & tackles, all new unused cable accessories and fittings like Light Interface Units, Surge suppressors, Opto isolators, Interface Converters, Fiber Optic Card Cage, Fiber Optic Line Driver, Repeater / Modem, OTDR (for Optical Fiber Cables), cable glands, grommets, lugs, termination kits etc. for optical fibre cable shall be supplied & installed on requirement basis.

4.0 Cable Termination & Jointing

4.1 Termination and jointing of cables shall conform to the requirements of IS: 1255 and shall be carried out as per the recommendations of termination and jointing kit supplier. Cable terminations at various electrical and electronic equipment terminals shall be done as per approved scheme/ interconnection diagrams.

4.2 All cable entries in the equipment shall be sealed by cable glands supplied with the equipment. All cable glands shall be properly gasketed. Sealing (to prevent ingress of dust entry & propagation of fire) shall be provided for all floor slots used for cable entrance. When the equipment are supplied with undrilled gland plates for cable/ conduit entry into the equipment, all drilling & cutting on the gland plate and any minor modification work required to complete the job shall be carried out at site as per cable glanding requirement. Types of glands to be used are as under.

I. Material: Tinned brass conforming to BS: 6121 (Nickel Chrome plated with thickness 10 microns)

II. Type: Double compression

Glands for classified hazardous areas shall be double compression type flameproof and weather proof.

	2 x 660 MW ENNORE SEZ STPP CABLE ERECTION PHILOSOPHY	DOCUMENT NO. PE-DC-412-507-E004
		Rev No: 2
		Date: 08/07/2015
		SHEET 9 of 10

- 4.3 Termination of cables shall be done as per termination drawings & interconnection diagrams furnished. Shorting & looping of cores/ wires at terminals and between the panels if required shall be carried out as per approved scheme.
- 4.4 HT/LT power cable termination kits / jointing kits shall be pre moulded type, tapped type or heat-shrinkable type, tested as per IS: 13573.
- 4.5 Termination of aluminium/ copper conductor cables shall be done as indicated below:
- i) Aluminium conductor cables:- Heavy duty Aluminium tubular terminal end for solderless crimping.
 - ii) Copper conductor control cables:- Copper Cable lugs for control cable termination shall be PVC insulated sleeve type.

REV 2

- 4.6 Screened control cables shall be terminated by means of cage clamp termination system.
- 4.7 Individual cores of control cables shall have ferrules for identification. Ferrule numbers shall be provided as per the control schemes and other related documents.
- 4.8 Junction boxes may be used, wherever required, for jointing/ marshalling of control and instrumentation cables.

5.0 Grounding of Cabling System

5.1 Armour grounding:

- a) Armour of the HT cables and LT single core cables shall be grounded only at one end of cable preferably the source end.
- b) Armour of other cables shall be grounded at both ends of cable.

5.2 Screen Grounding:

- a) Screen of multi-core cables shall be grounded at both ends.
- b) Screen of single-core power cables shall be grounded at one end.
- c) Screen of electronic grounding system cables shall be grounded as per the Control System panel manufacturer recommendation.

6.0 Testing Of Cable Installation

- 6.1 Testing and electrical measurement of cable installations shall generally conform to the requirement of IS: 1255 & shall be listed below.
- 6.2 Prior to installation, cables shall be tested for
- a) Continuity of conductors for all cores of cables.

	2 x 660 MW ENNORE SEZ STPP CABLE ERECTION PHILOSOPHY	DOCUMENT NO. PE-DC-412-507-E004
		Rev No: 2
		Date: 08/07/2015
		SHEET 10 of 10

- b) Insulation resistance between conductors and earth.
 - c) Insulation resistance between conductors of multi core cables.
- 6.3 Pre installation checks for cable tray installation shall be as under:
- a) Availability of clear passage/ path for the cable tray network as per approved drawings.
 - b) Cold galvanisation paint treatment for all damaged portions of galvanisation due to cutting / repairs etc.
 - c) Correctness of installation of number and type of tray / tray accessories /support material as per approved drawings.
 - d) Firmness/ tightness of all welded joints.
 - e) Alignment / inter tray separation as per approved layout drawings.
 - f) Grounding connections for trays / cable boxes / marshalling boxes.
- 6.4 After installation cables shall be tested for
- a) Continuity of conductors for all cores of cables.
 - b) Insulation resistance between conductors.
 - c) Insulation resistance between conductors & earth.
 - d) Check for earth continuity for armour / screen (where applicable), and proper earth connection for cable glands, cable boxes etc.
 - e) DC High voltage test:- All HT power cables after installation and prior to connections shall be subjected to high potential tests. Also the insulation resistance values shall be measured both before and after high potential test for comparison. The leakage current shall also be measured during the high potential test.
 - f) Check for correct polarity & phasing of cable connections
 - g) Firmness/ tightness of terminations.
 - h) For correctness of all connections as per relevant wiring diagram.
 - i) For provision of correct cable tags, core ferrules etc.
- 6.5 All documents/ records regarding test data and all other measured values shall be duly vetted by the site Engineer before energizing the circuit and kept for future record and reference. The results of all tests shall conform to the specification requirements as well as any other specific performance guarantee.

A B C D E F G H

E

D

C

B

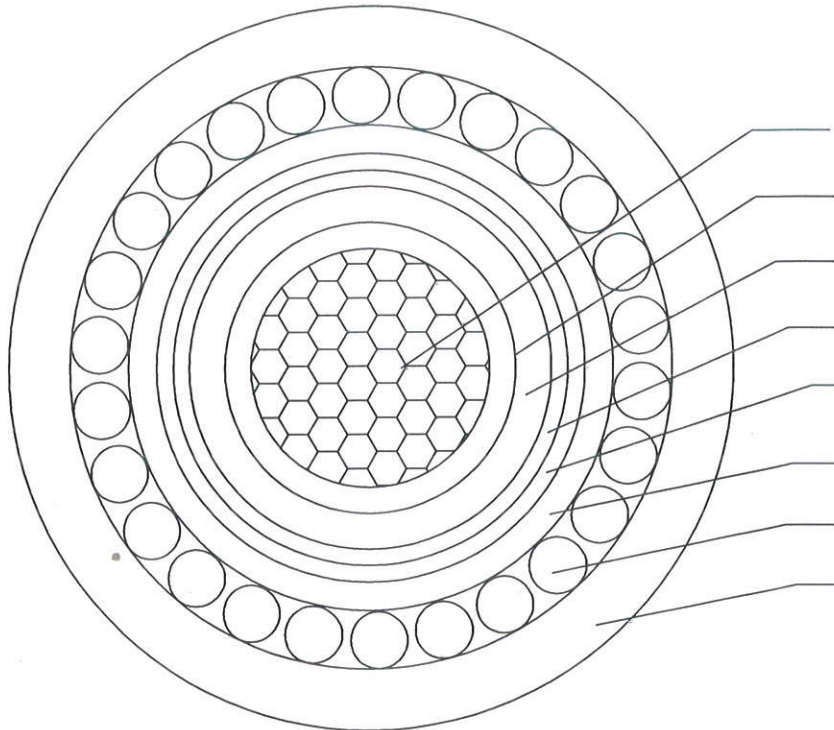

- Conductor : Stranded Compacted Circular Aluminium
- Conductor Screen : Extruded Semi-conducting layer
- Insulation : XLPE
- Core Screen : Extruded Semi-conducting layer
- Metallic Screen : Plain Copper Tape (Non-magnetic)
- Inner Sheath : Extruded FRLS PVC
- Armour : H4 Grade Aluminium Round Wire
- Outer sheath : FRLS PVC (Type-ST2)

A

B

C

D

E

TB-378-316-127-1 33kV XLPE Cable - Drawing & Datasheet

Project: 400kV GIS at 2 x 660 MW Ennore SEZ Supercritical Thermal Power Project at Ash Dyke of NCTPS, Chennai-120.
 NOA No: CE/P/SE/M/P/EE/10/E/P/F.2x660MW ENNORE SEZ STTP/D60/DT 27.027.2014
 Customer: Tamilnadu Generation And Distribution Corporation (TANGEDCO)
 Consultant: Desein Private Limited , New Delhi
 Contractor: Bhart Heavy Electricals Limited

CABLE SIZE:
1Cx500 -33kV(E)

TYPE :
A2XWaY

REF. STRD. :
IS:7098(II)

CUSTOMER :
TANGEDCO

GUPTA POWER INFRASTRUCTURE LTD.

DRAWN BY:	APPROVED BY:
DATE:	DATE:

DRAWING NO. :
GPIL/QN/405-01821

GUPTA POWER PRESENTS
RHINO
 WIRES | CABLES | LED



H G F E D C B A

HT POWER CABLE DRUM (IS:10418)

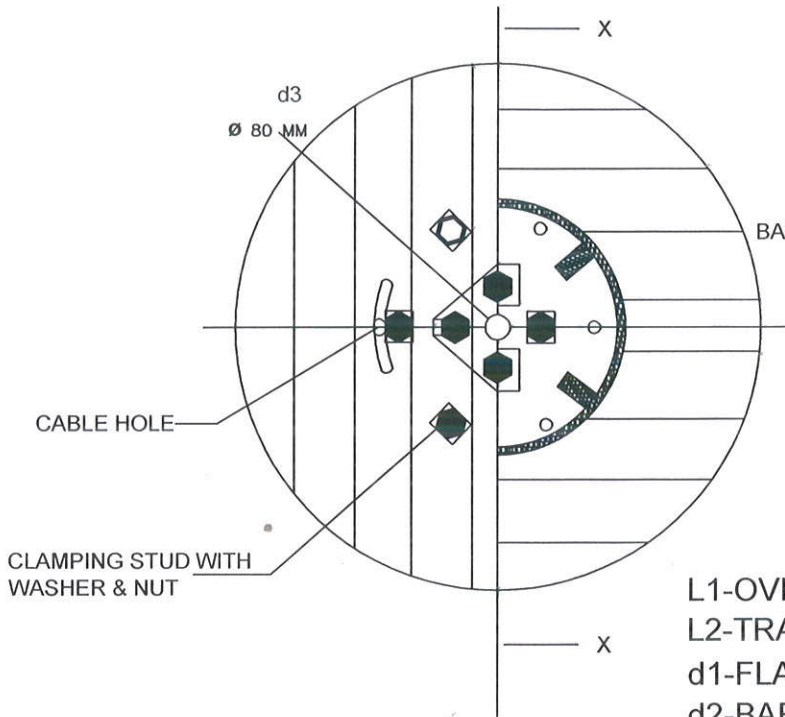

BARREL BATTENS

CABLE HOLE

CLAMPING STUD WITH WASHER & NUT

SPINDLE PLATE OR BUSH

d1

d2

STRETCHERS

L1

L2

FLANGE

BARREL END SUPPORT

CLAMPING STUD

BARREL MIDDLE SUPPORT

L1-OVER ALL WIDTH =855 mm
 L2-TRAVERSE=716 mm
 d1-FLANGE DIAMETER=1400 mm
 d2-BARREL DIAMETER= 675 mm
 d3-CENTRE HOLE DIAMETER -80 mm
 T-FLANGE THICKNESS =50 mm

SECTION XX

Details Of Materials used

- 1.Flanges, Main discs -2 ply (Thickness=50mm)
- 2.Stretchers (Core carrier Planks)-6 Nos (32mm thick x 100mm width)
- 3.Barrel Batten(Core Filler plank) Thickness -25 mm
- 4.Clamping Stud with Hexagonal Nuts -No/dia-6 /12mm
- 5.Square or round washers-No / dimension- 12 /65X65X6
- 6.External lagging thickness =25 mm

Drum details are for reference only

TB-378-316-127-1 33kV XLPE Cable - Drawing & Datasheet

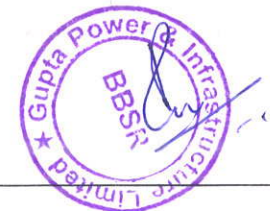

CUSTOMER	TANGEDCO		
TENDER NO.	GPIL/QN/405-01821		
SPEC.			
DRAWING TITLE	HT POWER CABLE DRUM		
DRAWN BY.			Supplier : M/s Gupta Power Infrastructure Ltd. Cuttack Road , Bhubaneswar
CHECKED BY			
SCALE	NTS		

Project:	400kV GIS at 2 x 660 MW Ennore SEZ Supercritical Thermal Power Project at Ash Dyke of NCTPS, Chennai-120.
NOA No:	CE/P/SE/M/P/EE-10/E/P/F.2X660MW ENNORE SEZ STTP/D60/DT 27.027.2014
Customer :	TAMILNADU GENERATION AND DISTRIBUTION CORPORATION (TANGEDCO)
Consultant:	DESEIN PRIVATE LIMITED, NEW DELHI
Contractor:	BHARAT HEAVY ELECTRICALS LIMITED

Revision-01(SI.No-6.4,6.5 & 12.2 to 12.5 , Si.no-17 to 18 and Si.No-20 to 26)

GUARANTEED TECHNICAL PARTICULARS

SL	PARTICULARS	Unit	1C x 500 Sqmm
1.0	Name of the Manufacturer		GUPTA POWER INFRASTRUCTURE LTD.
2.0	Cable Size	No x sqmm	1 X 500
3.0	Type of Cable		A2XWαY
4.0	Reference Standard		Gen. IS:7098 (Part-2) 2011
5.0	Voltage grade	Volts	19/33 KV (E)
5.1	Suitable for System with:		19KV
	a) Service Voltage		Suitable for 33 KV (E) System
	b) Neutral Earthing		90°C Continuous
5.2	Temparature Rating	°C	250°C for short circuit
	Short Time	°C	
6.0	CONDUCTOR :		
6.1	Material		H2 grade Aluminium (Class 2 of IS.8130 / 84)
6.2	Type of conductor	-	Stranded Circular Compacted
6.3	Area of Conductor (Nominal)	mm ²	500
6.4	No. of Strand		61
6.5	Nominal dia. of each wire in conductor	mm	3.25(Before Stranding)
6.6	Maximum DC resistance of Conductor at 20°C	ohm/km	0.0605
6.7	Short circuit current rating of conductor per second	KA/sec	47.2
7.0	CONDUCTOR SCREENING		
7.1	Material		Extruded Semiconducting Compound
7.2	Thickness (Min)	mm	0.8
8.0	INSULATION		
8.1	Material		XLPE
8.2	Thickness (Nom.)	mm	8.8
8.3	Process of Curing		Dry Cure
9.0	INSULATION SCREENING		
9.1	Material		Extruded Semiconducting Compound
9.2	Thickness		Extruded Layer : 0.8 mm (Min.)
9.3	Metallic Screen		A Layer of Plain Copper tape of 0.1mm thickness with 20% overlap.(300A/1Sec.)
10.0	Core identification		N/A
11.0	INNER SHEATH :		
11.1	Material & Type		Black PVC Type ST2 with FRLS Properties
11.2	Minimum thickness	mm	0.6
12.0	ARMOUR :		As per IS:3975-1979
12.1	Material & Type		Single layer H4 Round Aluminium Wire as per IS : 8130 (90% Coverage)
12.2	Size / dimension of round wire	mm	3.15
12.3	Min. No. of round Wire		40
12.4	Tolerance on round Wire	mm	±0.080
12.5	Max. Resistivity of Al. Wire	Ohm.sq.mm /km	28.264
12.6	Short circuit current rating of Armour (min.)		25KA/1Sec.
13.0	OUTER SHEATH :		
13.1	Material & Type		Black PVC Type ST2 (as per IS : 5831/84) with FRLS Properties
13.2	Minimum thickness	mm	2.20
14.0	Approx overall diameter of cable (±3 mm)	mm	62.0
15.0	Continuous current rating		
15.1	Cables laid in Ground (At temp 30 degC)	Amps	481
15.2	Cables installed in Air (At temp 40 degC)	Amps	730
16.0	Standard Drum length with Tolerance	Mtrs	600 (+/-5%)
17.0	Type & Construction of Cable Drums		Wooden/Steel Drum Gen. to IS:10418

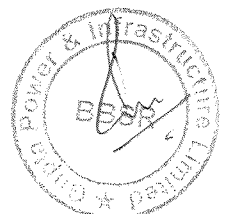

Sl.	PARTICULARS	Unit	1C x 500 Sqmm
18.0	Type of End Sealing		Both the ends of cable shall be properly sealed with heat shrinkable PVC/Rubber caps secured by "U" nails.
19.0	Min. Bending Radius	mm	20 X OD
20.0	Weight of Cable		4150 Kg/Km(App.)
21.0	Weight of Conductor		1263 Kg/Km(App.)
22.0	Weight of XLPE insulation		946.3 Kg/Km (App.)
23.0	Weight of PVC		612.3 Kg/km (App.)(For Outer Sheath)
24.0	Weight of PVC/Polyethylyne		140.4 Kg/Km (For Inner Sheath)
25.0	Shipping Weight		2990 Kg (Approx)
26.0	Tolerance on total quantity		+/-2%
27.0	Embossing details on Outersheath		GPIL-RHINO 19/33KV(E) 1C X 500 SQMM, A2XWaY, FRLS, Year of Mfg.
28.0	Whether sequential meter marking shall be provided		Yes, By Printing only (Sequential length marking at an interval of 1mtr.throughout the length.)

FRLS Properties

- i) Min. Oxygen Index : 29% when tested as per ASTM D-2863
- ii) Min. temp. Index : 250°C when tested as per ASTM D- 2863
- iii) Max. Smoke density rating : 60 when tested as per ASTMD- 2843
- iv) Max. Halogen Acid gas Evolution : 20 (by weight) generation when tested as per IEC-754-1

Note:

- Annexure-1 (Rating Factor & Group rating factors for HT Cable, enclosed along with GTP)
- Annexure-2 (Construction details of 33kv HT Cable with seal & sign, enclosed along with GTP)
- Annexure-3 (Short circuit Calculation sheet for Conductor, Screen & Armour, enclosed along with GTP)

Please refer document number: TB-378-510-034 Rev.1, Title:Cable Sizing Calculation for installation conditions.

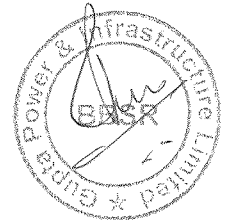

	Construction Details for 33kV Cable	Doc. No. TB-378-510-034 (Part-2)
	2 x 660 MW ENNORE TPS	Rev No. 2 Date 25.07.2017

1.0 CONTENTS

1.1 This document is in continuation to Cable Sizing calculation - Document No: TB-378-510-034

2.0 SCOPE

2.1 The scope of this document covers the construction details for 33kV Power cable

2.2 Reference Documents

3.0 REFERENCE

3.0 a) Design calculations for MV Cable & Sizing Doc No: PE-DC-412-507-E001

a) Cable Sizing calculation - Document No: TB-378-510-034

S.NO	ITEM	PARTICULARS
1	REFERENCE STANDARD	IS-7098 PART-II IN GENERAL
2	SYSTEM VOLTAGE	33 KV
3	VOLTAGE GRADE OF CABLES	19 / 33 KV (E)
4	CONDUCTOR	
a	REFERENCE STANDARD	IS-8130
b	MATERIAL	ALUMINIUM H2 GRADE CLASS 2
c	SHAPE	MULTI-STRANDED COMPACTED CIRCULAR - THE ECCENTRICITY OF THE CORE SHALL NOT EXCEED 10% AND OVALITY NOT TO EXCEED 2%
d	SIZES (NO. OF CORES -CROSS-SECTIONAL AREA)	500 Sqmm, Single Core
5	CONDUCTOR SCREENING	EXTRUDED SEMI-CONDUCTING COMPOUND MINIMUM THICKNESS: 0.8 MM
6	INSULATION*	
a	REFERENCE STANDARD	IS-7098 PART-II
b	MATERIAL	EXTRUDED XLPE
7	INSULATION SCREENING	
a	REFERENCE STANDARD	IS-7098 PART -II
b	MATERIAL	
(i)	NON METALLIC	EXTRUDED SEMI-CONDUCTING COMPOUND MINIMUM THICKNESS: 0.8 MM
(ii)	METALLIC	THE METALLIC SCREEN OF EACH CORE SHALL CONSIST OF COPPER TAPE WITH MINIMUM OVERLAP OF 20% NON-MAGNETIC METALLIC CU TAPE PER CORE SIZED FOR CARRYING EARTH FAULT CURRENT OF 300A FOR 1 SEC. MINIMUM THICKNESS: 0.1 MM



	Construction Details for 33kV Cable	Doc. No. TB-378-510-034 (Part-2)
	2 x 660 MW ENNORE TPS	Rev No. 2 Date 25.07.2017

8	EXTRUSION (INSULATION AND SCREENS)	
a	PROCESS	TRIPLE EXTRUSION. (EXTRUDED SEMI-CONDUCTING COMPOUND FOR CONDUCTOR SCREEN AND INSULATION SCREEN SHALL BE APPLIED ALONG WITH XLPE INSULATION IN A SINGLE OPERATION BY TRIPLE EXTRUSION DRY CURE PROCESS USING NITROGEN).
b	METHOD OF CURING	DRY CURING USING NITROGEN
9	CORE IDENTIFICATION	
		NOT APPLICABLE
10	INNER SHEATH	
a	REFERENCE STANDARD	IS-5831 & IS-7098 PART II
b	MATERIAL	EXTRUDED HRPVC, FR-LSH CONFORMING TO TYPE ST2
b.1	FILLERS (IF APPLICABLE)	ACCEPTABLE
b.2	MATERIALS OF FILLERS	SAME AS INNER SHEATH
11	ARMOUR	
a.	REFERENCE STANDARD	IS- 3975, IS- 7098 PART II & IS 8130
b	SINGLE CORE CABLES	
b.1.	MATERIAL	NON-MAGNETIC HARD DRAWN ALUMINIUM GRADE H4
b.2.	SHAPE	ROUND WIRE
12	SHORT CIRCUIT WITHSTAND CAPACITY	
a.	CONDUCTOR	25KA FOR 3 SEC
b.	COPPER TAPE SCREENING	300 A for 1 Sec
c.	ARMOUR	25KA FOR 1 SEC
13	OUTER SHEATH	
a	REFERENCE STANDARD	IS-5831 & IS-7098 PART II
b	MATERIAL	EXTRUDED HRPVC, FR-LSH CONFORMING TO TYPE ST2
14	CHARACTERISTICS OF HRPVC, FR-LSH SHEATH	
a.	OXYGEN INDEX	MIN. 29% (AS PER ASTM D 2863)
b	TEMPERATURE INDEX	MIN. 250°C AT OXYGEN INDEX OF 21 (AS PER ASTM D 2863)
c.	ACID GAS GENERATION	MAX 20% (AS PER IEC 60754-1)
d.	SMOKE DENSITY RATING	MAX 60% (AS PER ASTM D 2843)

