TECHNICAL SPECIFICATION ROS: 9088

**FOR WATER PUMP
OF WBPDCI PROJECT**

CONFIDENTIAL

CUSTOMER : WBPDCI
PROJECT : 1X660MW SAGARDIGHI
APPLICATION : FLUE GAS DESULPHURIZATION SYSTEM



Water Systems
Bharat Heavy Electrical Limited
Ranipet – 632 406.

	TECHNICAL SPECIFICATION FOR WATER PUMPS- WBPDCCL
WBPDCCL:FGD: WATER PUMP	
1X660MW SAGARDIGHI	

TECHNICAL SPECIFICATION FOR WATER PUMP

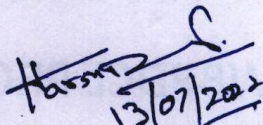
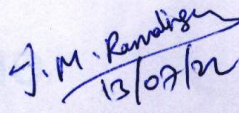
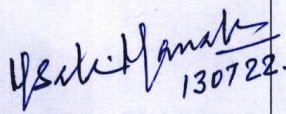
Department	Prepared	Checked	Approved
WS	 HARSH DEEP DM-WS 13/07/2022	 IMRL Rao Sr. Mgr.-WS 13/07/22	 M. Salaimanalan DGM/WEG & WS 13/07/22
ROS : 9088 Rev00 Dated:13.07.2022		COMMENTS : -----	

This document is meant for the exclusive purpose of bidding against this specification and shall not be transferred, reproduced or otherwise used for purposes other than that for which it is specifically issued.

	TECHNICAL SPECIFICATION FOR WATER PUMPS- WBPCL
WBPCL:FGD: WATER PUMP	
1X660MW SAGARDIGHI	

CONTENT

1.0	PROJECT INFORMATION
2.0	APPLICABLE CODES & REGULATIONS
3.0	WATER ANALYSIS
4.0	INTENT OF SPECIFICATION
5.0	SCOPE OF SUPPLY
6.0	GENERAL REQUIREMENTS
6.1	CONSTRUCTIONAL FEATURES
6.2	POWER SUPPLY
6.3	PAINTING PROCEDURE
6.4	MOTOR
7.0	EXCLUSION
8.0	OTHER SALIENT POINTS
8.0	SPARES, TOOLS & TACKLES
9.0	START UP & COMMISSIONING SPARES
9.1	MANDATORY SPARES
9.2	DEFECT LIABILITY & WARRANTY
10.0	PERFORMANCE GUARANTEE
11.0	BID EVALUATION CRITERIA FOR POWER CONSUMPTION
12.0	LIQUIDATED DAMAGES FOR POWER CONSUMPTION
13.0	DOCUMENTATION
14.1	ANNEXURE I- SCHEDULE OF GUARANTEES
14.2	ANNEXURE – II- LIST OF DEVIATIONS/EXCEPTIONS TO THE ENQUIRY DOCUMENT
14.3	ANNEXURE –III- A). DOCUMENTS TO BE SUBMITTED ALONG WITH THE OFFER
	ANNEXURE – III- B). DOCUMENTS TO BE SUBMITTED AFTER CONTRACT
14.4	ANNEXURE-IV : TECHNICAL SPECIFICATION FOR SEAWORTHY PACKING
14.5	ANNEXURE-V: DATA SHEET TO BE FILLED BY VENDOR: (FOR ALL PUMPS)

	TECHNICAL SPECIFICATION FOR WATER PUMPS- WBPDC
WBPDC:FGD: WATER PUMP	
1X660MW SAGARDIGHI	

1.0 PROJECT INFORMATION:

As per Annexure A, Clause 1.0

2.0 APPLICABLE CODES & REGULATIONS

The design and materials shall conform to the requirements of applicable codes and regulations of the latest edition. The design, manufacture, installation and testing of the pump shall follow the latest applicable Indian/International (ASME/EN/Japanese) Standards.

3.0 WATER ANALYSIS:

As per Annexure A, Clause 3.0

4.0 INTENT OF SPECIFICATION

This specification covers the minimum requirements for the complete design, material, manufacturing, shop inspection, testing at the manufacturer's works, supervision of erection & performance testing at bidder's works of water pumps along with accessories, which is furnished in the Flue Gas Desulphurization system. The following points may be noted.

- a. Each unit is envisaged with one FGD system. The details for the pumps is envisaged in the Annexure A.
- b. Bidder shall assume full unit responsibility for the entire equipment assembly and make all possible efforts to comply strictly with the requirements of this specification and other specifications/attachments to inquiry/order.
- c. In case, deviations are considered essential by the Bidder (after exhausting all possible efforts), the same shall be separately listed in the Bidder's proposal under separate section, titled as "List of Deviations/Exceptions to the Enquiry Document (**Annexure-IV**)".
- d. Any deviation, not listed under the above section, even if reflected in any other portion of the proposal, shall not be considered applicable.
- e. No deviation or exception shall be permitted without the written approval of the purchaser.
- f. Compliance to this specification shall not relieve the Bidder of the responsibility of furnishing equipment and accessories/auxiliaries of proper design, materials and workmanship to meet the specified start up and operating conditions.
- g. In case, the Bidder considers requirement of additional instrumentation, controls, safety devices and any other accessories/auxiliaries essential for safe and satisfactory operation of the equipment, the same shall be recommended along with reasons in a separate section and include the same in scope of supply.
- h. All accessories, items of work, though not indicated but required to make the system complete for its safe, efficient, reliable and trouble free operation and maintenance shall also be in supplier's scope unless specifically excluded

	TECHNICAL SPECIFICATION FOR WATER PUMPS- WBPCL
WBPCL:FGD: WATER PUMP	
1X660MW SAGARDIGHI	

5.0	Scope of Supply & Services
------------	---------------------------------------

1. All the pumps shall be supplied along with individual drive motor (IE3), Base Plate along with required isolations, Coupling, Coupling Guard, Drain Plug Vent Valves, Companion Flanges Foundation Bolt and Expansion Bellows (Neoprene) at inlet & outlet , Pressure gauges at inlet & outlet, Y – Type suction strainer & other accessories required for the smooth erection and commissioning of the pumps
2. First Fill of Consumables, Oil & Lubricants shall be supplied alongwith the main supply

6.0	TECHNICAL REQUIREMNT									
1.	The pumps shall be designed for continuous operation. The pump shall be centrifugal type capable of delivering the rated flow at rated head as specified in the respective clauses.									
2.	The pump shall be provided with seals of proven type and shall be designed for minimization of seal water consumption. The shaft shall be supported on heavy duty ball/roller bearings.									
3.	All pumps shall be designed to withstand a test pressure of 1.5 times the maximum possible pump shut off pressure under maximum suction pressure conditions									
4.	The Pump flow/head characteristics shall be such that within the operation range the head will continuously increase with decreasing flow, maximum head (shut off head) being at least 15% higher than duty point head.									
5.	Each pump will have a coupling of adequate size, designed for full load and capable of supporting start –Up an overload moment.									
6.	The Pump coupling motor and base frame shall be supplied in assembled condition. The Bidder at site without any implication shall assemble any items supplied loose.									
7.	Each rotating equipment shall be first statically balanced and then dynamically balanced according to ISO 1940 (in the case of impellers this shall be done before and after mounting of the service rotor shaft).									
8.	Pumps shall run smoothly without undue noise and vibration. Peak to peak vibration limits shall be restricted to the following values during operation: <table style="width: 100%; border-collapse: collapse;"> <thead> <tr> <th style="text-align: left;">Speed</th> <th style="text-align: left;">Antifriction Bearing</th> <th style="text-align: left;">Sleeve Bearing</th> </tr> </thead> <tbody> <tr> <td>1500 rpm and below</td> <td>75.0 micron</td> <td>75.0 micron</td> </tr> <tr> <td>3000 rpm</td> <td>50.0 micron</td> <td>65.0 micron</td> </tr> </tbody> </table>	Speed	Antifriction Bearing	Sleeve Bearing	1500 rpm and below	75.0 micron	75.0 micron	3000 rpm	50.0 micron	65.0 micron
Speed	Antifriction Bearing	Sleeve Bearing								
1500 rpm and below	75.0 micron	75.0 micron								
3000 rpm	50.0 micron	65.0 micron								
9.	The pumps shall be capable of starting with discharge valve fully open and close condition. Motors shall be selected to suit to the above requirements. Minimum motor margin (as per table below) shall be provided above maximum load demand of the pump in the entire operating range to take care of the system frequency variation and no case less than the maximum power requirement at any condition of the entire characteristic curve of the pump. Continuous Motor rating shall be at 50 deg.C ambient.									

	TECHNICAL SPECIFICATION FOR WATER PUMPS- WBPCL
WBPCL:FGD: WATER PUMP	
1X660MW SAGARDIGHI	

	Motor margin shall be as below <table border="1" style="margin-left: auto; margin-right: auto;"> <tr> <td>Pump rated BKW</td> <td>Motor rating</td> </tr> <tr> <td><22 kW</td> <td>125% of pump rated BKW</td> </tr> <tr> <td>22 kW – 55 kW</td> <td>115% of pump rated BKW</td> </tr> <tr> <td>>55 kW</td> <td>110% of pump rated BKW</td> </tr> </table>	Pump rated BKW	Motor rating	<22 kW	125% of pump rated BKW	22 kW – 55 kW	115% of pump rated BKW	>55 kW	110% of pump rated BKW
Pump rated BKW	Motor rating								
<22 kW	125% of pump rated BKW								
22 kW – 55 kW	115% of pump rated BKW								
>55 kW	110% of pump rated BKW								
10.	Make of the Bearings: SKF/FAG/ Equivalent subjected to customer approval.								
11.	Make of seal: Flowserve / Eagle Burgmann /Jone Crane / Equivalent subjected to customer approval.								
6.1	CONSTRUCTIONAL FEATURES								
	General:								
	<p>The pumps shall be complete with drive motors, baseplate and other accessories. The constructional features of the pump shall be as follows:</p> <p>a). Pump casing may be radially split. The casing shall be of robust construction. Casing drain and vent connections shall be provided. (If applicable).</p> <p>b). Impeller shall be made in one piece and securely keyed to the shaft. Locking device shall be provided to prevent its loosening during all conditions of operation.</p> <p>c). Wearing rings shall be of renewable type. Opposed wearing surface shall be of hardened material and shall have a hardness difference of at least 50 BHN.</p> <p>d). Replaceable shaft sleeves shall be provided to protect the shaft where it passes through bearings and stuffing boxes. The end of the shaft sleeve assembly shall extend through the packing gland. Shaft sleeve shall be securely locked or keyed to the shaft to prevent loosening or rotation. Shaft and shaft sleeves shall be machined and assembled for concentric rotation.</p> <p>e). The design of the shaft shall take into consideration the critical speed, which shall be at least 20% more than operating speed.</p> <p>f). Pump bearings shall be of antifriction type. Bearings shall be readily accessible without disturbing the alignment of pump.</p> <p>g). Packed stuffing boxes shall be of sufficient length to prevent leakage along the shaft and shall be complete with all packing and lantern rings required.</p> <p>h). Pumps shall be furnished complete with an approved type of flexible - coupling.</p> <p>i). Couplings guards made of expanded metal and bolted to the base plate shall be furnished.</p> <p>j). The common base plate for pumps and motor shall be in one piece and shall be made of fabricated steel.</p> <p>k). Pump speed shall be less than 1500 rpm for pumps of capacity more than 10</p>								

	TECHNICAL SPECIFICATION FOR WATER PUMPS- WBPCL
WBPCL:FGD: WATER PUMP	
1X660MW SAGARDIGHI	

	<p>m³/hr.</p> <p>l). The Pump shall be capable of developing the required total head at rated capacity for continuous operation. Also, the pumps shall be capable of being operated to give satisfactory performance at any point on the HQ characteristics curve. The operating range of the pump shall be 40% to 120% of the duty point unless otherwise mentioned elsewhere. The maximum efficiency of pump shall preferably be within $\pm 10\%$ of the rated design flow as indicated in data sheets.</p> <p>m). The total head capacity curve shall be continuously rising from the operating point towards shut-off without any zone of instability and with a minimum shut-off head of about 15% more than the design head.</p> <p>The power, head and flow characteristics of each pump shall be suitable for parallel operation. The Power characteristics of the pumps shall be of non-overloading type. All rotating parts of the pumps shall be statically and dynamically balanced.</p> <p>The motor shall be rated for continuous operation and confirm to companion electrical specification. However, motor rating shall not be less than the max. power demand throughout the entire range of operation of pump. Design duty point of pump shall match with the average value of maximum and minimum flow rates of the pump in the stable operation zone.</p>
A)	Casing, Gland & Stuffing Box
a.	The material of the Casing, Gland & Stuffing Box shall be of <u>2.5 Ni Cast iron to IS 210 Grade FG260 or equivalent.</u>
b.	The casing and flanges shall be designed to withstand the maximum shut-off pressure developed by the pump.
c.	Lifting provision (Lugs) of pump should be provided.
B)	IMPELLER & Wearing Rings (As applicable)
a.	The Impeller & wearing Rings (as applicable) material shall be of <u>Stainless Steel 316</u> grade.
C)	SHAFT AND SHAFT SLEEVES
a.	All Shafts & Shaft Sleeves shall be of <u>SS 410 grade.</u> All Pump shafts shall be of ample size to transmit the maximum possible output from the prime mover.
b.	The pump shaft and coupling are to be so dimensioned that the maximum permissible torque of the shaft is higher than the maximum transmissible torque of the coupling.
c.	Shafts shall be conservatively designed to transmit maximum power required and to assure rigidity. Shafts shall be machined and ground to close tolerances and shall be tapered to permit easy removal of the seals and bearings.

	TECHNICAL SPECIFICATION FOR WATER PUMPS- WBPCL
WBPCL:FGD: WATER PUMP	
1X660MW SAGARDIGHI	

D)	BASE PLATE
a.	A common base plate (epoxy coated) shall be provided for pump assembly & Motor and the same shall be rigidly constructed, adequately braced and provided with finish pads for mounting pump.
b.	Suitable holes shall be provided for grouting and these shall be so located that the base plate can be grouted in place without disturbing the pump and motor.
c.	Common base plate for Pump and Motor shall be in the scope of the bidder.
d.	Base plate must be stress-relieved for any residual welding stress and certificate to that effect is to be submitted as per inspection requirement.
E)	BEARINGS
a.	The bearings may be ball, roller or sleeve bearing. If sleeve bearings are used these shall be machined for close running fit. The bearings shall be designed to take the necessary radial load as well as the net axial thrust
b.	Make of the Bearings: SKF/FAG/ Equivalent subjected to customer approval.
F)	ACCESSORIES:
1.	FASTENERS
I	All fasteners shall be SS316 only irrespective of wetted / non-wetted parts.

6.2 POWER SUPPLY

1.	POWER SUPPLY	
	The following voltage levels shall apply:	
	3 phase, 3.3 kV AC ,50 Hz	: Voltage for motors equal to / bigger than 200KW and for power distribution within the plant.
	3 phase, 415 V, AC , 50 Hz	Standard voltage for power supplies to electric power consumers and motors Above 0.2 KW and upto 200 kW.
	240V AC / 3 phase 415 V AC, 50 Hz	Standard voltage for power supplies to electric power consumers and motors Upto 0.2 kW.
1.	All equipment's shall be suitable for rated frequency of 50 Hz with a variation of + 3% & -5%, and 10 % combined variation of voltage and frequency unless specifically brought out in the specification.	

	TECHNICAL SPECIFICATION FOR WATER PUMPS- WBPCL
WBPCL:FGD: WATER PUMP	
1X660MW SAGARDIGHI	

	2. Bidder shall design and supply the equipment suitable for satisfactory operation under above mentioned power supply condition.
--	---

6.3	PACKING AND FORWARDING
1.	Proper packing to be ensured. Indigenous Supply: Pump & sub system assembly shall be wrapped in polythene bags & packed in a strong rigid wooden crate. Rain water should not enter into the pump internals during storage in the outer yard of power plant.
2.	Equipment and process materials shall be packed and semi-knocked down, to the extent possible, to facilitate handling and storage and to protect bearings and other machine surfaces from oxidation. Each container, box, crate or bundle shall be reinforced with steel strapping in such a manner that breaking of one strap will not cause complete failure of packaging. The packing shall be of best standard to withstand rough handling and to provide suitable protection from tropical weather while in transit and while awaiting erection at the site.
3.	Equipment and materials in wooden cases or crates shall be properly cushioned to withstand the abuse of handling, transportation and storage. Packing shall include preservatives suitable to tropical conditions. All machine surfaces and bearings shall be coated with oxidation preventive compounds. All parts subject to damage when in contact with water shall be coated with suitable grease and wrapped in heavy asphalt or tar impregnated paper.
4.	Crates and packing material used for shipping will become the property of owner.(NTPC)
5.	Packing (tare) shall be part of the equipment cost and shall not be subject to return. The packing should ensure integrity and cohesiveness of each delivery batch of equipment during transportation. In case of equipment assemblies and unit's delivery in the packing of glass, plastics or paper the specification of packing with the material and weight characteristics are to be indicated.
6.	Each package should have the following inscriptions and signs stenciled with an indelible ink legibly and clearly: <ol style="list-style-type: none"> a. Destination b. Package Number c. Gross and Net Weight d. Dimensions e. Lifting places f. Handling marks and the following delivery marking
7.	Each part of the equipment which is to be shipped as a separate piece or smaller parts packed within the same case shall be legibly marked to show the unit of which it is part, and match marked to show its relative position in the unit, to facilitate assembly in the field. Unit marks and match marks shall be made with steel stamps and with paint.

	TECHNICAL SPECIFICATION FOR WATER PUMPS- WBPDC
WBPDC:FGD: WATER PUMP	
1X660MW SAGARDIGHI	
8.	Each case shall contain a packing list showing the detailed contents of the package. When any technical documents are supplied together with the shipment of materials no single package shall contain more than one set of such documents. Shipping papers shall clearly indicate in which packages the technical documents are contained.
9.	The case number shall be written in the form of a fraction, the numerator of which is the serial number of the case and the denominator the total number of case in which a complete unit of equipment is packed.
10.	Wherever necessary besides usual inscriptions the cases shall bear special indication such as "Top", "Do not turn over", "Care" , "Keep Dry" etc. as well as indication of the center of gravity (with red vertical lines) and places for attaching slings (with chain marks)
11.	Marking for Safe handling: To ensure safe handling, packing case shall be marked to show the following: <ol style="list-style-type: none"> a. Upright position b. Sling position and center of Gravity position c. Storage category d. Fragile components (to be marked properly with a clear warning for safe handling)
12.	Each crate or package is to contain a packing list in a waterproof envelope. All items are to be clearly marked for easy identification against the packing List. All cases, packages etc. are to be clearly marked on the outside to indicate the total weight where the weight is bearing and the correct position of the slings are to bear an identification mark relating them to the appropriate shipping documents. All stencil marks on the outside of cases are either to be made in waterproof material or protected by shellac or varnish to prevent obliteration in transit.
13.	The packing slip shall contain the following information: - Customer name, Name of the equipment, Purchase Order number with Date, Address of the delivery site, Name and Address of the Sender, Serial Number of pump & accessories, BHEL item Code, Gross Weight and Net weight of Supplied items.
14.	Prior to transport from manufacturer's work to destination, components of the unit shall be completely cleaned to remove any foreign particles. Flange faces and other machined surfaces shall be protected by an easily removable rust preventive coating followed by suitable wrapping.
6.4	Motor
Refer to technical specification TECI: LT MOTOR: REV 05; Date : 27.08.2021	
7.0	EXCLUSION
	The following work associated with the water pumps will be by others: <ol style="list-style-type: none"> a. Civil foundations b. Walkways, platforms and ladders

	TECHNICAL SPECIFICATION FOR WATER PUMPS- WBPDC
WBPDC:FGD: WATER PUMP	
1X660MW SAGARDIGHI	

	c. Element handling hoists
--	----------------------------

8.0	SPARES, TOOLS & TACKLES
8.1	START UP & COMMISSIONING SPARES
	Start-up & Commissioning Spares shall be part of the main supply of the Water pumps. Start-up & commissioning spares are those spares which may be required during the start-up and commissioning of the equipment/system. All spares required for successful operation till commissioning of pump shall come under this category. Bidder shall provide an adequate stock of such start up and commissioning spares to be brought by him to the site for the equipment erection and commissioning. The spares must be available at site before the equipments are energized. The List of such spares to be provided by bidders with their offer.
8.2	MANDATORY SPARES
	Bidder to quote for below mentioned mandatory spares with break up price as per Annexure A (Clause 6.0): Bidder shall quote for the Mandatory Spares List and it will be considered for L1 evaluation. Mandatory Spares Parts items shall be handed over separately and shall not be mixed with the supply of the main equipment parts. Spares shall be sent in pre-decided lots in containers/secure boxes. All boxes/containers are to be distinctly marked in red color with boldly written "S" mark on each face of the containers. Spares shall not be dispatched before dispatch of corresponding main equipment's. Each item shall be labelled in English and be packed against damage and sealed to prevent deterioration from corrosion.
9.0	DEFECT LIABILITY & WARRANTY
1.	The Bidder warrants that the equipments/items shall be free from defects in the design, engineering, materials and workmanship of the Plant and Equipment supplied and of the work executed. The Defect Liability Period shall be Twenty four (24) months from the date of delivery or eighteen (18) months from the date of commissioning, whichever first occurs. If during the Defect Liability Period any defect should be found in the design, engineering, materials and workmanship of the Plant and Equipment supplied or of the work executed by the Bidder, the Bidder shall promptly, in consultation and agreement with BHEL regarding appropriate remedying of the defects, and at its cost, repair, replace or otherwise make good (as the Bidder shall, at its discretion, determine) such defect as well as any damage to the Facilities caused by such defect.
2.	In case of failure of the equipment to meet the guarantee, NTPC/BHEL reserves the right to reject the equipment. However, NTPC/BHEL reserves the right to use the equipment until new equipment supplied by bidder meets the guaranteed requirement .

	TECHNICAL SPECIFICATION FOR WATER PUMPS- WBPDC
WBPDC:FGD: WATER PUMP	
1X660MW SAGARDIGHI	

10.0	PERFORMANCE GUARANTEE
	<p>All performance tests for Water pumps shall be carried out in accordance with any latest international codes/standards.</p> <ol style="list-style-type: none"> 1) Bidder shall furnish Performance guarantee for the design, manufacture, material, safe and trouble-free operation of the water pumps and its accessories 2) Bidder shall guarantee and demonstrate the rated capacity of the pump at the rated head. 3) Noise level-≤ 85 dB (A) at 1m horizontal distance from equipment/enclosures and 1.5m above operating floor is to be guaranteed. 4) Vibration levels measured on the non-rotating parts shall not exceed the zone limit "B" as defined in ISO 10816 at steady conditions and shall not exceed the zone limit "C" as defined in ISO 10816 at transient conditions. 5) Acceptance tests to be carried out as per the procedure defined by the bidder, which shall be submitted for customer approval. 6) In the event that the performance test is unsuccessful, bidder shall take necessary remedial action at his cost and the performance test shall be repeated.
11.0	BID EVALUATION CRITERIA FOR POWER CONSUMPTION:
	As per Annexure A Clause 7.0
12.0	LIQUIDATED DAMAGES FOR POWER CONSUMPTION
	As per Annexure A Clause 8.0
13.0	DOCUMENTATION
A	DOCUMENTS TO BE SUBMITTED ALONG WITH THE OFFER
	The Bidder shall submit all documents, drawings, diagrams and all such information, which are necessary to fully understand the offer for techno – commercial evaluation as per Annexure-III A . Annexure-III documents are required for proper evaluation purpose and vendors are requested to comply with above in all respect.
B	DOCUMENTS TO BE SUBMITTED AFTER AWARD OF CONTRACT
	<p>The Successful bidder shall submit necessary data, documents and drawings for review, approval as specified under Annexure-III B . All necessary GA drawings, sections, sub-assembly drawings, specifications of main and sub components and necessary set of operation & maintenance manual as asked by NTPC must be furnished by bidder in soft and hard copy forms.</p> <p>Unless agreed otherwise, Ten (10) hard copies and five (05) sets of electronic copies of all documents are to be submitted in the English language. Electronic Copies shall be submitted in primary original data format (e.g. DOC, XLS, DWG) as well as in a printable non-proprietary document format (e.g. PDF). However all the engineering related information shall be furnished in soft form to BHEL.</p>

	TECHNICAL SPECIFICATION FOR WATER PUMPS- WBPCL
WBPCL:FGD: WATER PUMP	
1X660MW SAGARDIGHI	

14.1	ANNEXURE-I: Schedule of Guarantee
-------------	--

Sl. No	Description	Data
1.	Rated capacity of pump m³/hr	:
2.	Total head at design capacity M	:
3.	Guaranteed shaft power consumption at rated capacity & head kW	:
4.	Noise level at a distance of 1.0 meter from the equipment at site and 1.5 m above operating floor dB(A)	:
5.	Maximum vibration (peak to peak amplitude at site) microns	:
6.	Equipment Availability (%)	:
7.	Pump Efficiency (%)	:

SIGNATURE OF BIDDER _____

NAME _____

DESIGNATION _____

	TECHNICAL SPECIFICATION FOR WATER PUMPS- WBPCL
WBPCL:FGD: WATER PUMP	
1X660MW SAGARDIGHI	

14.3	ANNEXURE-III
-------------	---------------------

A) DOCUMENTS TO BE SUBMITTED ALONG WITH THE OFFER

Sl. No.	Description	No of copies With proposal
1.	Specification duly signed and seal on each	1
2.	Anchor Plan & Civil foundation Loading	1
3.	GA drawings of pump assembly	1
4.	Data Sheet	1
5.	Performance curve	1
6.	Test Arrangement & Test procedure	1
7.	Reference plant details	1
8.	Required Electric power & other Utility List	1
9.	Deviation List	1
10.	Scope of Supply	1
11.	Start-up & Commissioning Spares	1

SIGNATURE OF BIDDER -----

NAME -----

DESIGNATION -----

	TECHNICAL SPECIFICATION FOR WATER PUMPS- WBPCL
WBPCL:FGD: WATER PUMP	
1X660MW SAGARDIGHI	

B) DOCUMENTS TO BE SUBMITTED AFTER CONTRACT:

Sl. No.	Description	No of copies After award of contract	Delivery Time
1.	Utility Consumption	1	2 weeks after contract
2.	Foundation Data including Anchor plan	1	2 weeks after contract
3.	Performance curve	2	2 weeks after contract
4.	GA Drawing	1	1 month after contract
5.	Cross section detail drawing	1	1 month after contract
6.	Data Sheet	1	2 weeks after contract
7.	Lubricating Chart	1	2 months after contract
8.	Installation and assembly procedure	1	4 months after contract
9.	Inspection Certificate	1	In 2 weeks after test
10.	Manufacturing Schedule	1	2 weeks after contract
11.	Proforma Packing List	1	2 months prior to
12.	Pump and Motor Sizing Calculation	1	2 weeks after contract
13.	Material Test Certificates	2	In 2 weeks after test
14.	Pre Commissioning Check List	2	4 months after contract
15.	Quality Plan	4	1 month after contract
16.	Operation and Maintenance Manual	• 10 hardcopies and 5 electronic copies in English	4 months after contract
17.	Start-up & Commissioning	2	1 month after contract
18.	Test Arrangement & Test procedure	2	1 month after contract

SIGNATURE OF BIDDER -----

NAME -----

DESIGNATION -----

	TECHNICAL SPECIFICATION FOR WATER PUMPS- WBPCL
WBPCL:FGD: WATER PUMP	
1X660MW SAGARDIGHI	

14.5 Annexure-V: Data Sheet to be filled by vendor: (to be filled by bidder for each pump)

Sl. No	Description	Value		
TECHNICAL DETAILS				
1	Make			
2	Model			
3	Application			
4	Design Flow at Rated Speed (m ³ /hr)			
5	Minimum & Maximum Continuous Flow (m ³ /hr)			
6	Total Discharge Head @ design flow MWC			
7	Shut off Head @ MWC			
8	NPSH required (minimum) @ MWC			
9	Hydraulic test pr.@ Kg/Sq. Cm			
10	Pump efficiency -			
10.1	At design point %			
10.2	At maximum flow %			
11	Pump shaft power reqd. at design point @ KW			
12	Maximum shaft power required @ KW			
13	Selected motor @ KW			
14	Rated speed & critical speed @ rpm			
15	GD2 of the pump @ kgm ²			
16	Operating flow range from design point % : + -			
17	Noise level at duty range dBA at 1.0 m distance			
18	Vibration level -			
18.1	Displacement microns			
18.2	Velocity (Peak) mm/sec			
19	Balancing quality as per ISO 1940 std.			
20	Rotation of shaft viewing from drive end			

	TECHNICAL SPECIFICATION FOR WATER PUMPS- WBPCL
WBPCL:FGD: WATER PUMP	
1X660MW SAGARDIGHI	

21	Tolerance on head and efficiency at rated speed and flow.			
CONSTRUCTIONAL DETAILS				
1.0	Suction / Discharge nozzle			
1.1	Size mm			
1.2	Rating psi			
1.3	Flange drilling standard			
1.4	Nozzle Orientation looking from DE			
2.0	Material of construction / make			
2.1	Pump casing			
2.2	Impeller			
2.3	Shaft			
2.4	Shaft sleeve			
2.5	Wear rings			
2.6	Diffuser			
2.7	Mechanical seal			
2.8	Bearing housing			
2.9	Fasteners			
2.10	Others if any			
3.0	No. of stage			
3.1	Impeller type			
3.2	Impeller diameter Trimmed / Untrimmed			
4.0	Bearings			
4.1	Type			
4.2	Make			
4.3	Lubrication Oil - Specification			
4.4	Lub. Oil Quantity / pump Litre			
5.0	Mechanical seal			
5.1	Type			
5.2	Make			
5.3	Model			
5.4	Drawing No			
6.0	Performance curve references No.			
7.0	Foundation Draws No.			
7.1	Pump Dimension L x W x H in mm			
7.2	Pump Weight in Kg			
COUPLING				
1.0	Type			

	TECHNICAL SPECIFICATION FOR WATER PUMPS- WBPDCL
WBPDCL:FGD: WATER PUMP	
1X660MW SAGARDIGHI	

2.0	Make , Model No			
3.0	Coupling guard Material			
4.0	Dimension detail with BOM enclosed			
5.0	Weight in Kg			
BASE FRAME AND ACCESSORIES				
1.0	Material			
2.0	Dimension detail in mm			
3.0	Weight kg :			
GENERAL				
1.0	Shipping package dim. in mm			
2.0	Total assembly weight in Kg			
3.0	Total shipment weight in Kg			

SIGNATURE OF BIDDER -----

NAME -----

DESIGNATION -----

ANNEXURE A

FOR

WATER PUMP

OF W BPDCL PROJECT

(As reference to Tech. Spec. ROS9088)

CONFIDENTIAL

CUSTOMER : W BPDCL
APPLICATION : FLUE GAS DESULPHURIZATION SYSTEM
PROJECT : 1X660M W SAGARDIGHI



Water Systems
Bharat Heavy Electrical Limited
Ranipet – 632 406.

	TECHNICAL SPECIFICATION FOR WATER PUMP-WBPDCL
WBPDCL: FGD: WP: SAGARDI GHI : NNEXURE- A	

CONTENT

1.0	PROJECT INFORMATION
2.0	PROVENNESS CRITERIA:
3.0	WATER ANALYSIS
4.0	PUMP DETAILS
5.0	PAINTING PROCEDURE
6.0	MANDATORY SPARES
7.0	BID EVALUATION CRITERIA FOR POWER CONSUMPTION:
8.0	LIQUIDATED DAMAGES FOR POWER CONSUMPTION
9.0	WATER TANK LEVEL
10.0	NOISE
11.0	PACKING & FORWARDING

	TECHNICAL SPECIFICATION FOR WATER PUMP-WBPDCL
WBPDCL: FGD: WP: SAGARDI GHI : NNEXURE- A	

1.0 PROJECT INFORMATION:

a.	Owner	WBPDCL
b.	Buyer	BHEL, Ranipet
c.	Process/Application	Flue Gas Desulphurization
d.	Site Location	Sagardighi Town Murshidabad District of West Bengal (India)

A) SITE CONDITIONS

1.	Ambient Temperature and Relative Humidity	
	Average Site Condition ASC	
	Ambient Temperature	: 32 deg C
	Ambient Temperature (Design)	: 49 deg C
	Relative Humidity	: 89 %

B) PROJECT LOCATION AND APPROACH

A	Site Address	BHEL SITE OFFICE- SAGARDIGHI (1X660MW); VILLAGE-MANIGRAM; MURSHIDABAD DISTRICT OF WEST BENGAL (INDIA) EPC-CONTRACTOR- BHARAT HEAVY ELECTRICALS LIMITED, INDIA
----------	---------------------	--

	TECHNICAL SPECIFICATION FOR WATER PUMP-WBPDCL
WBPDCL: FGD: WP: SAGARDI GHI : NNEXURE- A	

2.0 PROVENNESS CRITERIA:

Bidder should have previous experience of design, manufacture, supply, erection and commissioning / supervised erection & commissioning of the Water Pumps as per criteria given in table below and the water pump(s) should have been in successful operation for a period not less than One (1) year prior to Part-I (Techno-commercial) bid opening date”

Sl. No.	Name of Equipment	Type of Equipment	Equipment Rating
1	Water Pumps	Centrifugal pump	80% of the flow & 100% of the head of the offered water Pump(s)

The Bidder shall offer only proven design, which meets the Provenness criteria indicated above. Necessary documentary evidences as per Annexure-I for qualification shall be submitted along with the bid. If bidder does not meet the specified Provenness criteria, they are denied to participate in this tender.

a) REFERENCE LIST as per format shown below

S. No.	Project Name , Customer & Plant capacity	Flow	Head	Motor KW	Qty	Year of Commg	Performance Certificate/ Documentary Evidence
1.							to be enclosed
2.							to be enclosed

SIGNATURE OF BIDDER -----

NAME -----

DESIGNATION -----

	TECHNICAL SPECIFICATION FOR WATER PUMP-WBPDCL
WBPDCL: FGD: WP: SAGARDI GHI : NNEXURE- A	

3.0	WATER ANALYSIS
------------	-----------------------

Process water is envisaged for Emergency Quenching. Process water analysis is provided below

S.no	Constituents	Unit	PROCESS WATER
1.	Calcium as CaCO ₃	ppm	153.6
2.	Magnesium as CaCO ₃	ppm	42
3.	Nitrate as CaCO ₃	ppm	0
4.	Chlorides as CaCO ₃	ppm	45
5.	Sodium+Potassium as CaCO ₃	ppm	75
6.	Silica as SiO ₂	ppm	33
7.	Sulphate as CaCO ₃	ppm	118.5
8.	Iron as fe	ppm	1.0
9.	Total Cations as CaCo3	ppm	270.6
10.	Total Anions as CaCo3		270.6
11.	Carbonates as CaCO ₃	ppm	0
12.	pH		7.8-8.2
13.	Bicarbonates as CaCO ₃	ppm	107.1
14.	Turbidity	NTU	60

SIGNATURE OF BIDDER -----

NAME -----

DESIGNATION -----

	TECHNICAL SPECIFICATION FOR WATER PUMP-WBPDCL
WBPDCL: FGD: WP: SAGARDI GHI : NNEXURE- A	

4.0	PUMP DETAILS
------------	---------------------

Sl.No	Description	Unit	Process water Pumps	Mist eliminator Wash & Emergency Quench pumps
1.	Number of pumps	Nos	1W + 1S	1W + 1S
2.	Drive Motor		Included in the bidder's scope of supply. The motor make is subjected to customer approval.	
3.	Head	mwc	30	55
4.	Flow	m3/ hr	90	151
5.	Coupling		Direct drive	Direct drive
6.	Type of Pumps		Horizontal centrifugal	Horizontal centrifugal
7.	Specific Gravity	--	1	1
8.	Viscosity	Pa-s	0.003	0.003
9.	Fluid medium	---	Process water	Process water
10.	Water Characteristics		As per Clause No: 3.0	As per Clause No: 3.0
11.	Mode of operation	--	Continuous	Continuous
12.	Maximum operating temperature	°C	45	45
13.	Maximum operating speed	rpm	1500 (max)	1500 (max)
14	Service	---	Outdoor. Pump along with motor to be supplied with Canopy.	Outdoor. Pump along with motor to be supplied with Canopy
15	Casing, Gland and stuffing Box		2.5 Ni Cast Iron to IS 210 Grade FG 260 or equivalent	
16	Impeller (Wear Rings, as applicable)		Stainless Steel-316 grade	
17	Shaft & Sleeves		Stainless Steel-410	
18	Sound (maximum)	dB	85 @ 1m distance	
19	Operating Range	%	25-130	25-130
20	Power Consumption (Ceiling Value) per Pump	KW	14	42

	TECHNICAL SPECIFICATION FOR WATER PUMP-WBPDCL
WBPDCL: FGD: WP: SAGARDI GHI : NNEXURE- A	

5.0	PAINTING PROCEDURE
------------	---------------------------

Surface Preparation : Power Tool Cleaning to St 3 (SSPC-SP3)				
Coating Procedure :				
Sl No.	Coat	Paint	DFT	Total DFT µm (min)
1.	Primer coat	Epoxy resin based Epoxy Zinc phosphate primer to IS 13238. DFT= 100µm per coat.	100 µm per coat	300 Microns
2.	Intermediate Coat	Epoxy resin based intermediate paint pigmented with Tio2. DFT= 100µm per coat.	100µm per coat	
3.	Finish coat	a). One coat of Epoxy based finish paint with glossy finish to IS 14209. b). One coat of acrylic aliphatic polyurethane paint to IS 13213.	For a). DFT= 75µm per coat. For b).DFT= 25µm per coat.	
Shade : Smoke Grey Shade 692 of IS 5				

GENERAL NOTES:

- No painting for SS, Aluminium, Non-ferrous, Stainless Steel and Galvanized items.
- In sub assy, wherever the sheets/plates of thickness less than or equal to 5mm and rods are used, power tool cleaning or hand tool cleaning to SSPC-SP3/SP2 shall be followed.
- DFT shall meet the specified value. In case of non-meeting DFT in number of coats specified, subsequent coat shall be applied to meet specified DFT.
- Painting damaged surfaces will be same as the painting scheme in this specification with tool cleaning.

SIGNATURE OF BIDDER _____

NAME _____

DESIGNATION _____

	TECHNICAL SPECIFICATION FOR WATER PUMP-WBPDCL
WBPDCL: FGD: WP: SAGARDI GHI : NNEXURE- A	

6.0	MANDATORY SPARES
	<p>Bidder to quote for below mentioned mandatory spares with break up price:</p> <ol style="list-style-type: none"> 1. Complete Impeller Assembly - 1 nos for each type & size. 2. Casing Wear Rings - 1 set for each type. 3. Bearings - 1 Set (one set corresponds to replacement of one complete pump-motor set) 4. Motor - 1 No. of each type <p>Note:</p> <p>Any change in size material design etc. that obviates one to one replacement of the part shall be considered a different type. Unless otherwise stated a set shall mean complete replacement for one equipment.</p>
7.0	BID EVALUATION CRITERIA FOR POWER CONSUMPTION:
1.	<p>POWER GUARANTEE: Bidder to specify the guaranteed power consumption at motor input terminal per Pump operating at the duty point in their offer.</p>
2.	<p>BID EVALUATION CRITERIA FOR POWER CONSUMPTION: Power loading is applicable for the following Pumps</p> <ol style="list-style-type: none"> 1) Process water Pump 2) Mist Eliminator wash. <p>In case, Guaranteed Shaft power offered by the bidder exceeds the base value specified (Auxiliary Power at motor Input as per clause 4.i.19 & 4.ii.19), his bid price will be loaded for excess power consumption as per the formula given below.</p> <p>Adjustment factor for excess power consumption in USD = (GPC-BV) X PL X No's of Working pumps. Exchange rate as applicable on price bid opening date will be considered</p> <p>GPC- Guaranteed Power Consumption quoted by bidder in KW BV- Base Value for Guaranteed Power Consumption in KW PL- Power Loading per KW shall be 462,000/- Rs</p>
8.0	LIQUIDATED DAMAGES FOR POWER CONSUMPTION
	<p>If actual shaft Power Consumption during prove out (or) PG Test operating at the duty point exceeds the value guaranteed by the bidder, liquidated damages for shortfall in performance shall be deducted from contract price as per the formula given below</p>

	TECHNICAL SPECIFICATION FOR WATER PUMP-WBPDCL
WBPDCL: FGD: WP: SAGARDI GHI : NNEXURE- A	

9.0	TANK WATER LEVEL
-----	------------------

Process water Tank Level is provided below:-

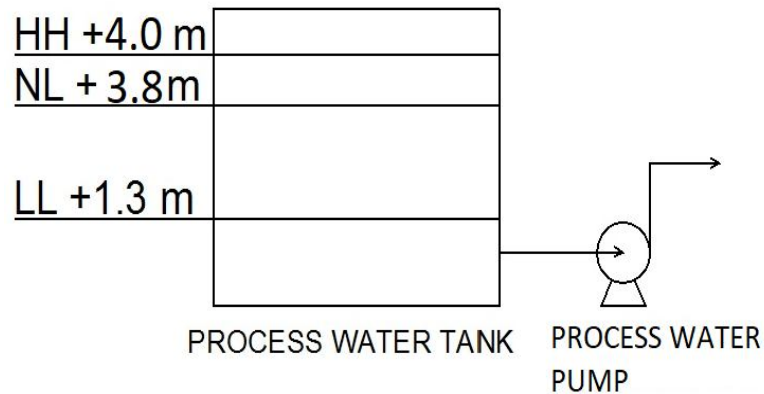
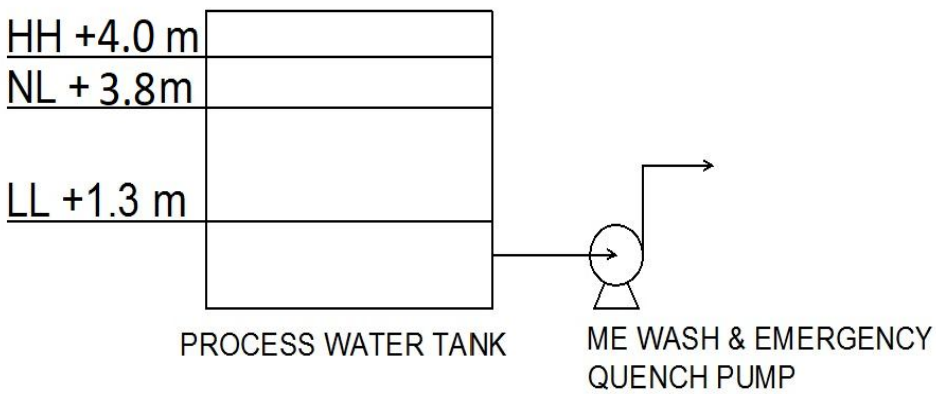

SIGNATURE OF BIDDER

NAME

DESIGNATION

	TECHNICAL SPECIFICATION FOR WATER PUMP-WBPDCL
WBPDCL: FGD: WP: SAGARDI GHI : NNEXURE- A	

10.0	Noise
-------------	--------------

Noise level measurement shall be carried out using applicable and internationally acceptable standards. The measurement shall be carried out with a calibrated integrating sound level meter meeting the requirement of IEC 651 or BS 5969 or is 9779.

Sound pressure shall be measured all around the equipment at a distance of 1.0 m horizontally from the nearest surface of any equipment/ machine and at a height of 1.5 m above the floor level in elevation.

A minimum of 6 points around each equipment shall be covered for measurement. additional measurement points shall be considered based on the applicable standards and the size of the equipment. the measurement shall be done with slow response on the a - weighting scale. the average of a-weighted sound pressure level measurements expressed in decibels to a reference of 0.0002 micro bar shall not exceed the guaranteed value. corrections for background noise shall be considered in line with the applicable standards. all the necessary data for determining these corrections, in line with the applicable standards, shall be collected during the tests

SIGNATURE OF BIDDER _____

NAME _____

DESIGNATION _____

	TECHNICAL SPECIFICATION FOR WATER PUMP-WBPDCL
WBPDCL: FGD: WP: SAGARDI GHI : NNEXURE- A	

11.0	PACKING AND FORWARDING
i	<p>Each Package or shipping units shall be marked or stenciled on at least two sides as Pre Annexure A.</p> <p>BHEL SITE OFFICE-</p> <p>SAGARDIGHI (1X660MW);</p> <p>VILLAGE-MANIGRAM;</p> <p>MURSHIDABAD DISTRICT OF WEST BENGAL (INDIA)</p> <p>EPC-CONTRACTOR-</p> <p>BHARAT HEAVY ELECTRICALS LIMITED</p> <p>In addition, each package or shipping unit shall have the symbol painted in red on at least two sides of the package, covering one fourth of the area of the side.</p>

SIGNATURE OF BIDDER

NAME

DESIGNATION

Specification for Y-type Strainer

Description	Tag 1 (Mist Eliminator)	Tag 2 PROCESS WATER PUMP
Type of strainer	Y type	Y type
Inlet and outlet size of strainer	Inlet and Outlet size shall correspond to suction and delivery size of pump	
Casing MOC	Carbon steel	Carbon steel
Element MOC	SS	SS
Pressure drop requirement	0.5 psi at design flow	0.5 psi at design flow
Design flow	151 m3/hr	90 m3/hr
Design temp	50 Deg Cel	50 Deg Cel
Qty of strainer	2 no's	2 no's

Specification for Expansion Bellows

Inlet and Outlet size shall correspond to suction and delivery size of pump. Please refer the attached typical drawing of Expansion Bellow. Vendor should follow this as per the offered pump.

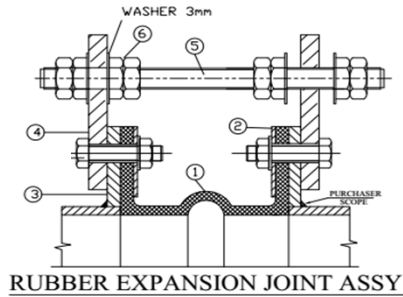

TOLERANCE:- AS PER FSA STANDARD

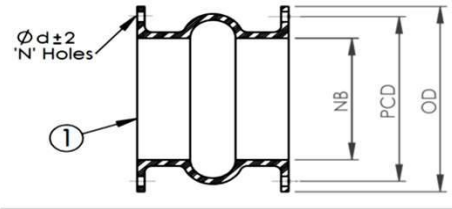

① RUBBER EXPANSION JOINT

S.No	Mat code	NB	OD	PCD	Ød	N	L	QTY (Nos)	Design Pressure [kg/sq.cm]	Hydrotest pressure [kg/sq.cm] *
1	RWT70612001	100	229	191	19	8	150	4	10.0	15.0
2	RWT70612002	150	279	241	22	8	150	14	10.0	15.0
3	RWT70612003	200	343	298	22	8	150	15	10.0	15.0
4	RWT70612004	250	406	362	25	12	200	6	10.0	15.0
5	RWT70612005	300	483	432	25	12	200	14	10.0	15.0
6	RWT70612006	350	533	476	29	12	200	6	10.0	15.0
7	RWT70612007	400	597	540	29	16	200	6	10.0	15.0
8	RWT70612008	450	635	578	32	16	200	12	10.0	15.0

* at Room Temperature

ALL DIMENSIONS ARE IN 'mm' Unless Otherwise Specified

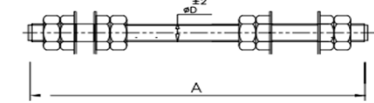

⑤&⑥ CONTROL UNITS

S.No	NB	A	ØD	QTY/REJ [Nos]
1	100	280	16	2
2	150	320	18	2
3	200	320	22	3
4	250	380	22	3
5	300	400	24	3
6	350	400	24	3
7	400	420	27	4
8	450	420	27	4

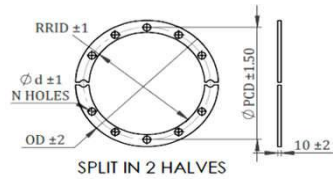

② RETAINER RING

S.NO	NB	RRID	OD	PCD	Ød	N
1	100	146	229	191	19	8
2	150	200	279	241	22	8
3	200	260	343	298	22	8
4	250	316	406	362	25	12
5	300	370	483	432	25	12
6	350	420	533	476	29	12
7	400	470	597	540	29	16
8	450	520	635	578	32	16

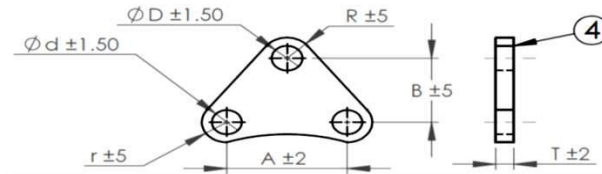

④ STRETCHER PLATE

S.NO	NB	A	B	ØD	Ød	R	r	T	QTY/REJ [Nos]
1	100	75	60	19	19	20	20	10	4
2	150	95	60	22	22	20	20	12	4
3	200	117	60	25	22	25	25	12	6
4	250	95	65	25	25	25	25	16	6
5	300	113	70	27	25	30	25	16	6
6	350	124	70	27	29	30	30	16	6
7	400	105	75	30	29	30	30	16	8
8	450	113	75	30	32	30	30	20	8

POS	DESCRIPTION	QTY	MATERIAL
6	NUT&LOCK NUT		IS:1367 CL. 6.0 (Hot-Dip Galv)
5	CONTROL ROD	SEE TABLE	IS:1367 CL. 6.8 (Hot-Dip Galv)
4	STRETCHER PLATE		IS:2062 GR. A (Hot-Dip Galv)
3	COMPANION FLANGE	-	NOT IN OUR SCOPE
2	RETAINERRING	2	IS:2062 GR. A (Hot-Dip Galv)
1	RUBBER EXPANSION JOINT	1	RUBBER

BILL OF MATERIALS

DESIGN DATA

S.No	Description	Value/ Specification
1	MATERIAL	Neoprene Inner Tube & Outer Cover
2	FLOWING MEDIUM	Brackish water at A pH 5 to 8.5
3	SHORE HARDNESS	65±5° Shore A
4	TEMPERATURE	Max. 50° C
5	DRILLING STANDARD	ANSI B 16.5 CL 150



MOVEMENT CAPABILITIES @ DESIGN PRESSURE

S.No	MOVEMENT CAPABILITIES @ DESIGN PRESSURE	Value/ Specification
1	AXIAL EXPANSION	10mm
2	AXIAL COMPRESSION	10mm
3	LATERAL DEFLECTION	10mm

Note:1. One set of control rod assy, shall consist of 1 stud 2 gusset plate, 4nuts, 4 lock nuts & 4 Washers

PRODUCT STANDARD
ELECTRICAL, CONTROLS & INSTRUMENTATION
BAP / BHEL / RANIPET – 632 406

TECI: LT MOTOR: REV 05
PAGE 1 OF 10
EFFECTIVE DATE : 28.07.2021

DOCUMENT TITLE : TECHNICAL SPECIFICATION FOR BOUGHT OUT ITEMS				
ITEM : LT MOTOR				
PROJECT : BHEL STANDARD				
	NAME	DESIGNATION	SIGNATURE	DATE
PREPARED BY	ALAN S G	ENGINEER		28/7/2021
REVIEWED BY	CHANDRASEKAR A P	DM		28-07-2021
APPROVED BY	JEYAMURUGANAND M	AGM		28/07/2021
ISSUED BY EDC – ECI				
RECORD OF REVISIONS:				
REVISION NUMBER 00	INITIAL RELEASE - Dt. 19.03.2013			
REVISION NUMBER 01				
REVISION NUMBER 02	Cl. No: 5- Packing and Drawing included			
REVISION NUMBER 03	Cl. No: 2.20, 2.21, 2.38, 2.39, 2.43 added			
REVISION NUMBER 04	Cl.No: 2.3, 4(b) - ECI:DATASHEET:LTMOTOR:00 added			
REVISION NUMBER 05	Cl.No: 2.36, 2.40, 4(b), 5(a) Updated			

PRODUCT STANDARD
ELECTRICAL, CONTROLS & INSTRUMENTATION
BAP / BHEL / RANIPET – 632 406

TECI: LT MOTOR: REV 05
PAGE 2 OF 10
EFFECTIVE DATE : 28.07.2021

	<u>SPECIFICATION</u>	<u>VENDOR COMPLIANCE/ REMARKS</u>
1	<u>SITE CONDITIONS</u>	
1.1	Altitude above mean sea level	>1000 m.
1.2	Ambient temperature condition	6 to 50°C.
1.3	Relative humidity	100%
1.4	Atmosphere	Tropical, Dusty, salty, corrosive & highly polluted as in a coal based Thermal power plant.
2	<u>GENERAL</u>	
2.1	Reference standards	IS 15999, IS 12615, IS/IEC-60034, IS 1231, IS 6362, IS 2253, IS 12065, IS 12075
2.2	Design ambient	50 Deg.C
2.3	Application/ Type(Normal/ Energy efficient)	As per the document LT MOTOR:PROJECT SPECIFIC DETAILS
2.4	Duty cycle	Continuous S1
2.5	Rated voltage, frequency & Phases	415 V AC $\pm 10\%$; 50 Hz (+5% to -5%); 3 phase
2.6	Combined variation of Voltage and frequency	10% absolute sum
2.7	Motors efficiency class	As per the document LT MOTOR:PROJECT SPECIFIC DETAILS
2.8	Minimum starting voltage	80% of the rated voltage
2.9	Minimum voltage under which motor will run satisfactorily	75% of the rated voltage for 5 minutes
2.10.	Capacity to restart (at specified voltage)	i. Two successive starts from cold condition ii. Two HOT restarts starts from Hot condition iii. Three equally spread start per hour
2.11	High speed bus transfer withstand capability	Suitable to withstand 150 % of rated voltage
2.12	Type of balancing for rotor	Dynamic balancing
2.13	Direction of rotation	Suitable for both direction
2.14	Direction of cooling air	Non-drive end to driving end
2.15	Class of insulation	Class F with temperature rise limited to Class B.
2.16	Winding treatment	The insulation shall be given tropical and fungicidal treatment for successful operation of the motor in hot, humid & tropical climate.
2.17	Allowed winding temperature rise at continuous full load	60°C by thermometer method & 70°C by resistance method
2.18	Accelerating Torque at minimum permissible Starting voltage	10% of full Load Torque

PRODUCT STANDARD
ELECTRICAL, CONTROLS & INSTRUMENTATION
BAP / BHEL / RANIPET – 632 406

TECI: LT MOTOR: REV 05
PAGE 3 OF 10
EFFECTIVE DATE : 28.07.2021

2.19	Pullout Torque at rated voltage	205% of full load torque	
2.20.	Ratio of Locked rotor KVA to KW for	As per the document LT MOTOR:PROJECT SPECIFIC DETAILS	
2.21	Starting current	As per the document LT MOTOR:PROJECT SPECIFIC DETAILS	
2.22	Starting time & locked rotor withstand time	The locked rotor withstand time (LRWT) at 110% rated voltage (RV) under HOT condition shall be at least 2.5 sec more than the starting time at 80% of rated voltage for motors with acceleration time upto 20 sec at RV and 5 sec where the accelerating time is more than 20 sec at RV.	
2.23	Momentary overload withstand capability	60% of full load torque for 15 second without any damage.	
2.24	Over speed withstand	120% of rated speed for 2 minutes without any mechanical damage.	
2.25	Hot thermal withstand curve	margin of at least 10% over the full load current	
2.26	Cooling	Totally enclosed fan cooled- IC 411(TEFC)	
2.27	Vibration	The peak amplitude of vibration shall be as per IS 12075	
2.28	Noise level	Within the limits specified by IS 12065 / <85 dB at 1 meter distance from motor.	
2.29	Type of enclosure	TEFC, IP 55 as per IS/IEC 60034-5	
2.30.	Type of mounting	Horizontal foot mounted.	
2.31	Bearings	Ball or roller type / bearings effectively sealed against ingress of dust. The bearing shall be so constructed that the loss of lubricating grease is kept to minimum. Sealed bearings are also acceptable	
2.32	Lubricant Type	Grease	
2.33	Bearing life	minimum life of 40000 Working hours	
2.34	Shaft extension	Key slotted bare shaft extension with key at the driving end.	
2.35	Terminal box Type	Weather proof IP 55 as per IS/IEC 60034-5; Capable of being turned through 360° in steps of 90°.	
2.36	Cable gland and lugs	Double compression type nickel plated brass cable glands and annealed tinned copper crimping lugs to suit the cable size i) Size of power cables will be intimated after PO. ii) For space heater cable glands and lugs suitable for 2CX2.5 to be provided	

PRODUCT STANDARD
ELECTRICAL, CONTROLS & INSTRUMENTATION
BAP / BHEL / RANIPET – 632 406

TECI: LT MOTOR: REV 05
PAGE 4 OF 10
EFFECTIVE DATE : 28.07.2021

2.37	Type of terminals	Stud / screw type with plain washers, spring washers / checknuts & lugs	
2.38	Min.Spacing between Gland plate and Center stud(in mm)	As per the document LT MOTOR:PROJECT SPECIFIC DETAILS	
2.39	Phase to Phase/Phase to Earth air clearance(in mm) in Terminal Box	As per the document LT MOTOR:PROJECT SPECIFIC DETAILS	
2.40.	Fault level	40KA for 0.25Sec	
2.41	Painting	As per the document LT MOTOR:PROJECT SPECIFIC DETAILS	
2.42	Space heaters:		
2.42.a	i) Motors above 30 kW	Separate space heater suitable for 240V, Single Phase, AC,50 Hz	
2.42.b	ii) Motors below 30 kW	Winding shall be suitable for heating at 24 V, Single phase, AC,50 Hz	
2.43	Terminals for space heater	As per the document LT MOTOR:PROJECT SPECIFIC DETAILS	
2.44	RTD for winding	Two numbers of Thermistors / RTD for each phase as below are to be provided A. Motors above 37 Kw shall have thermistors Or RTD if specifically called for in enquiry. B. Motor rated 160kW and above shall have RTDs	
2.45	Bearing RTD	For motors 132 Kw and above	
2.46	Terminals for RTD/ Thermistor	Thermistors/ RTDs shall be terminated in an auxiliary terminal box. Details shall be furnished in TB diagram.	
2.47	Earthing	Two no of earthing provisions on terminal box and on motor body(on opposite sides)	
2.48	Name plate	As per IS/IEC 60034-8 and Additional data on name plate : a. Bearing DE/ NDE details. b. Year of manufacture	
2.49	Lifting Device	Eye bolt or lugs to facilitate safe lifting	
3	INSPECTION & TESTING	As per applicable quality plan	

PRODUCT STANDARD
ELECTRICAL, CONTROLS & INSTRUMENTATION
BAP / BHEL / RANIPET – 632 406

TECI: LT MOTOR: REV 05
PAGE 5 OF 10
EFFECTIVE DATE : 28.07.2021

4 **DOCUMENTS**

a) Along with offer:	One set of technical data sheet as per the enclosed format and Motor general arrangement drawing giving foundation details, shaft details.	
b) After placement of Purchase order (within 15 days)	<p>Three sets of the following for approval:</p> <ol style="list-style-type: none"> 1. Technical Data sheet as per the enclosed format ECI:DATASHEET:LTMOTOR:00 2. Motor general arrangement drawing giving foundation details, shaft details and weight 3. Motor Terminal box arrangement drawing 4. Motor characteristic curves : Torque vs Speed with load curve superimposed Speed vs Current Time vs Current Thermal with stand curve Load vs Efficiency Load vs Slip Load vs Power factor Speed vs Time Load vs Current 5. Suggested steel crate packing drawing (Drawing No:- 3-00-114-39893) or vendor standard packing drawing subject to approval. <p>The following shall be submitted:</p> <ol style="list-style-type: none"> 1. Guarantee certificate. 2. O & M manuals. 3. Acceleration time and LRWT calculation shall be submitted for review. 	
5 PACKING	<ol style="list-style-type: none"> a) As per suggested Drawing No:- 3-00-114-39893 b) The packing shall meet the Transport, Environment & Storage hazards. c) As per Packing Procedure QA:CI: STD:PR:03 or as per Manufacturer's Standard Practice subject to approval. 	

PRODUCT STANDARD
 ELECTRICAL, CONTROLS & INSTRUMENTATION
 BAP / BHEL / RANIPET – 632 406

TECI: LT MOTOR: REV 05
 PAGE 6 OF 10
 EFFECTIVE DATE : 28.07.2021

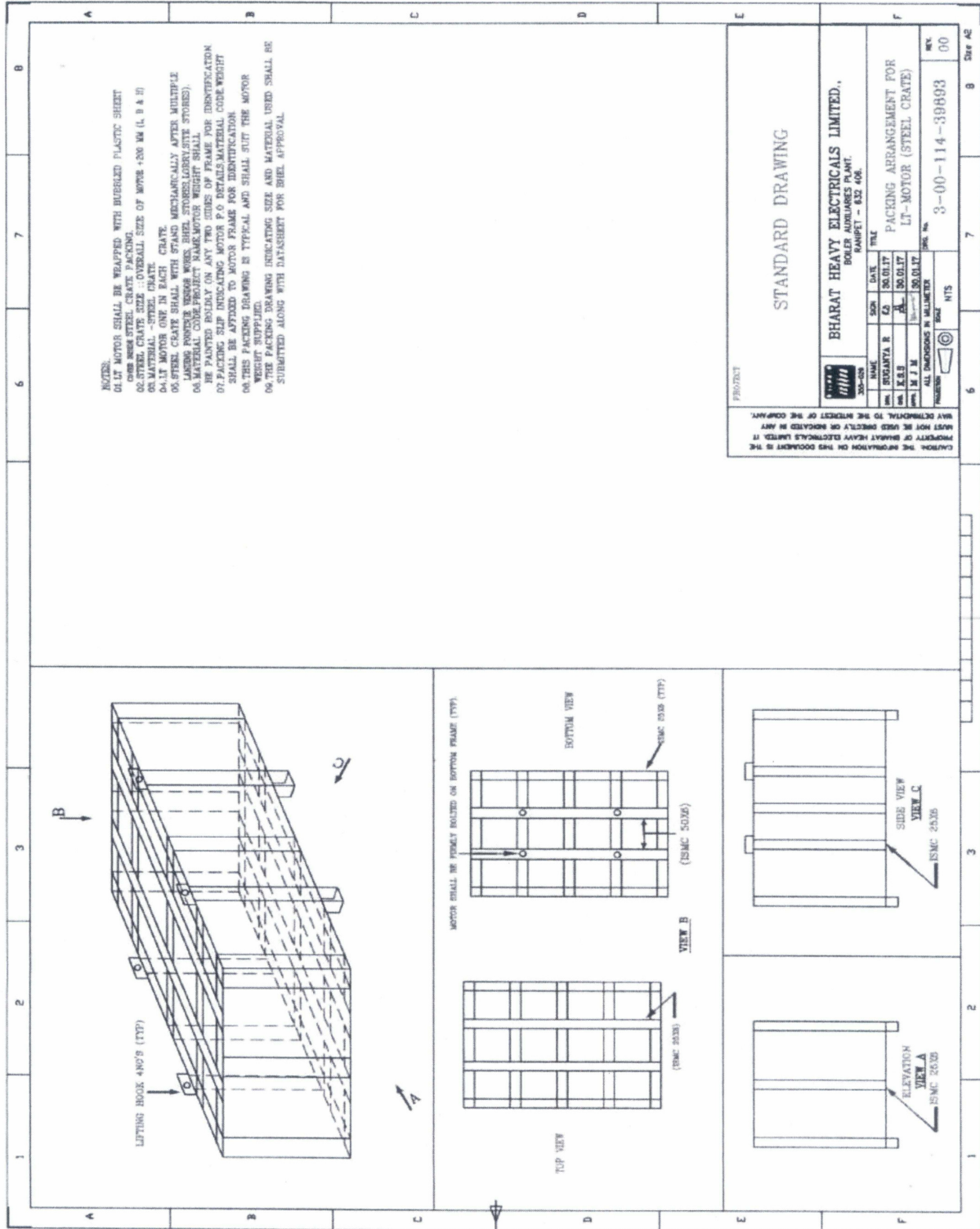

PRODUCT STANDARD
ELECTRICAL, CONTROLS & INSTRUMENTATION
BAP / BHEL / RANIPET – 632 406

TECI: LT MOTOR: REV 05
PAGE 7 OF 10
EFFECTIVE DATE : 28.07.2021

ECI: DATASHEET: LTMOTOR: 00

TECHNICAL DATA SHEET OF LT MOTOR

P.O No:

DATA SHEET - Customer No: Project:

CL.NO	CHARACTERISTICS	VENDOR DATA(To be filled by Vendor)
1.0	Application	
1.1	Fan / Load Curve referred	
2.0	Manufacturer	
3.0	Type & frame size	Normal/ Energy efficient Frame size:
3.1	Degree of Protection	IP55
4.0	Rated output in kW	
4.1	Rated speed	
5.0	Rated voltage , frequency & phases	415 V \pm 10% AC; 50 Hz \pm 5%; (Check voltage as per Enquiry) 10% absolute sum; 3 phase
6.0	Full load current	Amps
7.0	Energy efficient	As per IS 12615
8.0	Efficiency & power factor at Full load	Eff- Pf-
9.0	Efficiency & power factor at 75 % load	Eff- Pf-
10.0	Efficiency & power factor at 50 % load	Eff- Pf-
11.0	Duty Cycle	SI - Continuous
12.0	Rated torque	
13.0	Starting current	As per IS standards
14.0	No load current (with mechanism coupled)	(at Rated.V and Frequency)
15.0	Starting torque in % of full load torque	
16.0	Pull up torque in % of full load torque	
17.0	Pull out torque in % of full load torque	

PRODUCT STANDARD
ELECTRICAL, CONTROLS & INSTRUMENTATION
BAP / BHEL / RANIPET – 632 406

TECI: LT MOTOR: REV 05
PAGE 8 OF 10
EFFECTIVE DATE : 28.07.2021

18.0	No load starting time (without mechanism coupled)	
19.0	Locked rotor withstand time at rated voltage	a.Hot b.Cold
20.0	Locked rotor withstand time at minimum starting voltage	a.Hot b.Cold
21.0	Locked rotor withstand time at 110% rated voltage	a.Hot b.Cold
22.0	Starting time at minimum starting voltage with mechanism coupled	
23.0	Starting time at rated voltage with mechanism coupled	
24.0	Maximum permissible starting time	
25.0	Stator thermal time constant	Minutes
26.0	Type & No of terminals brought out	
27.0	Stator winding connection	Delta / Star
28.0	Class of insulation & temperature rise	Class F; 60 ⁰ C by thermometer method / 70 ⁰ C by resistance method.
29.0	Minimum permissible starting voltage	Volts
30.0	Resistance per phase at 20Deg C (Indicative)	Ohms
31.0	No of successive starts in Hot condition	
32.0	Quantity and power consumption of space heater	Quantity: Watts:
33.0	Direction of rotation	Bi-Directional.
34.0	Bearing make & type	Make: Drive End: Non Drive End:
35.0	Lubricant quantity grade & recommended interval of lubrication	

PRODUCT STANDARD
ELECTRICAL, CONTROLS & INSTRUMENTATION
BAP / BHEL / RANIPET – 632 406

TECI: LT MOTOR: REV 05
PAGE 9 OF 10
EFFECTIVE DATE : 28.07.2021

36.0	Type of mounting & shaft orientation	Foot mounting; Horizontal.
	<u>Terminal Box</u>	
37.0	Location & angle of rotation	
38.0	Gland size for stator winding	
39.0	Gland size for space heater	Suitable for 2CX2.5 sq.mm (armoured), if applicable.
40.0	Cable entry	
41.0	GD ² of motor (kg-m ²)	
42.0	Total weight of motor (kg).	
43.0	Weight of stator (kg)	
44.0	Weight of rotor (kg)	
45.0	Anticipated bearing life in Hours	
46.0	Method of connection to driven equipment	
47.0	Limiting rotor temperature for determining safe stall time	
48.0	RTD for winding/ Bearing	Applicable: YES <input type="checkbox"/> NO <input type="checkbox"/>
49.0	Grade of balance of motor	
50.0	Standard continuous rating at 40 Deg C ambient.	
51.0	Derated rating of motor at 50 Deg C.	
52.0	a. Locked Rotor KVA	
	b. Ratio of Locked rotor KVA / Rated KW	
53.0	a. Motor Dynamic Load	Upward/ Downward—
	b. Motor Static load	Upward / Downward—
54.0	PAINT SHADE	

Vendor's signature and seal

Rev No :

Date :

PRODUCT STANDARD
ELECTRICAL, CONTROLS & INSTRUMENTATION
BAP / BHEL / RANIPET – 632 406

TECI: LT MOTOR: REV 05
PAGE 10 OF 10
EFFECTIVE DATE : 28.07.2021

The following curves are to be enclosed during datasheet approval.

1. GA drawing , Terminal box arrangement
2. Torque Vs Speed with load curve superimposed.
3. Speed Vs Current
4. Time Vs Current
5. Thermal with stand curve
6. Load Vs Efficiency
7. Load Vs Slip
8. Load Vs Power factor
9. Speed Vs Time
10. Load Vs Current.

The following information shall be specifically provided for motors suitable for VFD drive (if called for in eqny during datasheet approval in addition to datasheet.

1. Stator Resistance
2. Stator leakage reactance
3. Magnetising reactance
4. Rotor resistance referred to stator
5. Rotor reactance referred to stator

Vendor's signature and seal.

Date

LT MOTOR: PROJECT SPECIFIC DETAILS

INDENT NO: RFW21745&RFW21746

Customer No: R4W1

Altitude	34 Meter above MSL
ENERGY EFFICIENT	IE3 mentioned in IS 12615
SUPPLY	Supply: 415V + 10% & -10%, 3 Phase, 50 Hz +5% & -5%.
STARTING CURRENT	As per the limit mentioned in the relevant standard with IE-3 efficiency class
RATIO OF LOCKED ROTOR KVA TO KW	
i) 50KW to 110KW	11
ii) 110KW to 200KW	9
M IN. SPACING BETWEEN GLAND PLATE AND CENTER STUD(IN M M)	
upto 3KW	As per manufacturer's practice
above 3KW and upto 7KW	85
above 7KW and upto 13KW	115
above 13KW and upto 24KW	167
above 24KW and upto 37KW	196
above 37KW and upto 55KW	249
above 55kw and upto 90KW	277
above 90KW and upto 125KW	331
above 125KW and upto 200KW	385/203 (For Single core cables only)
PHASE TO PHASE/ PHASE TO EARTH AIR CLEARANCE(IN M M) IN TERMINAL BOX	
upto 110	10
above 110kw and upto 150KW	12.5
above 150KW	19
ADDITIONAL DATA TO BE INCLUDED IN DATASHEET	
GRADE OF BALANCING OF MOTOR	
STANDARD CONTINUOUS RATING AT 40DEG.C AMBIENT	
DERATED RATING OF MOTOR AT 50DEG.C(DESIGN POINT)	
NO LOAD CURRENT OF MOTOR AT RATED VOLTAGE AND FREQUENCY	
STARTING TORQUE VALUE IN KGM	
LOCKED ROTOR KVA @ RATED KW	
POWER FACTOR AND EFFICIENCY AT 75% LOAD	
POWER FACTOR AND EFFICIENCY AT 50% LOAD	
SPACE HEATER TERMINAL	Separate terminal box shall be provided
PAINTING	Will be intimated after PO

Note: - Supplier confirm to the LT Project Specific Details in Handwriting.

VOLUME IIB

**TECHNICAL SPECIFICATION
FOR
SEAWORTHY PACKING FOR EXPORT JOBS**

SPECIFICATION NO. PE-TS-888-100-A001



**BHARAT HEAVY ELECTRICALS LIMITED
POWER SECTOR
PROJECT ENGINEERING MANAGEMENT
NEW DELHI, INDIA**

	TITLE TECHNICAL SPECIFICATION FOR SEAWORTHY PACKING FOR EXPORT JOBS	SPECIFICATION NO. PE-TS-888-100-A001	
		VOLUME II B	
		SECTION D	
		REV. NO. 0	DATE 10/08/2010
		SHEET 1	OF 52

1.0 Purpose

The purpose of this specification is to describe minimum packing requirements for the different items/equipment for all export Project and also to define marking and shipping requirements during transportation by ship, road and air for all export jobs.

2.0 SCOPE

For export jobs, sea worthy packing capable of performing all necessary functions like prevention of damage to the contents, sufficient to support frequent handling and lengthy period of outdoor storage in adverse weather conditions are required. Workmanship and materials used shall be of high standard meeting the technical requirements and in accordance with best commercial export packing practices. Vendor shall be responsible for sea worthy export packing, however it shall meet the minimum requirements specified herein. Equivalent or better packing methods may be deployed subject to approval of the BHEL/Purchaser. Vendor shall submit the packing procedure for its equivalent for purchaser's approval during detailed engineering.

The scope this specification is to define VENDOR's responsibilities in terms of:

- Preservation of the GOODS/items/equipments before packing.
- Packing of the GOODS for road, rail, sea and/or air transportation to desired destination i.e. project site
- Making cases/crates
- Chemical Treatment/Fumigation before packing to prevent fungus, damage due to termite, borer, rats, etc.
- Marking of cases/crates.
- Other Services required.

3.0 Application

This specification is applicable to all the goods to be transported to project site and requires to be in transit for longer duration. *However, for "Misc cable erection items", "Fire sealing system" & "Exothermic welding material", the packing requirements shall be as per the procurement specification.*

4.0 Definitions

- "BHEL" : Main EPC vendor
- "OWNER" : Customer for a particular export project.
- "VENDOR" : Company(ies)/VENDOR(s) to whom the BHEL has placed Purchase Order for GOODS/ items/system/package.
- "GOODS": means all or part of the articles, material, equipment supplies including technical documentation, as described in the Purchase Order, to be supplied by VENDOR.
- "PACKER": Packaging Company to whom VENDOR intends to sub-contract the packing in case they do not have own packing capability/facilities .
- "FREIGHT FORWARDER" : Means the Company responsible for performing freight forwarding activities.

5. General Information

	TITLE TECHNICAL SPECIFICATION FOR SEAWORTHY PACKING FOR EXPORT JOBS	SPECIFICATION NO. PE-TS-888-100-A001	
		VOLUME II B	
		SECTION D	
		REV. NO. 0	DATE 10/08/2010
		SHEET 2	OF 52

The following requirements are intended as minimum requirements, and compliance to these requirements in no way absolves or relieves VENDOR of any responsibility or obligation outlined in the Purchase Order. In all circumstances, the packing will be designed and constructed in order to support GOODS during transportation as well as to prevent the Goods from damage due to impact, extreme climatic conditions, sun and rain. It must be ensured that the delivery of the GOODS to the jobsite by sea, road or air, in good condition.

GOODS shall be export packed in compliance with the best-established practices for international projects, in accordance with the following instructions. In the event of any conflict between these specified requirement and the established practices, specification requirement shall govern.

Due to climatic conditions and the complex transport operation(s), it is essential that protection and packing is of the highest standard. Packing means to efficiently protect the GOODS during the total transport operation; from the moment they leave the factory until they are delivered to the jobsite, including handling operations (loading/unloading) and storage.

When VENDOR do not have packing capabilities/facilities of their own and therefore intends to sub-contract, VENDOR have to inform BHEL/Purchaser of the name and address of proposed PACKER(s) for approval.

6.0 Criteria for Selection of Packaging

Packages are to be made according to categories, described in articles 8.1 to 8.5, depending on the type of materials, their fragility and size.

These categories have been established for the protection of equipment and material during multi-mode transports, i.e.: combination of overland and sea transport; containerization, air transportation.

In a general manner, the GOODS have to be packed in such a way that crates, bundles, pallets can be stored into General Purpose containers, wherever possible.

If VENDOR has any doubt about the correct method of protection or packing, he should contact BHEL/Purchaser in order to mutually agree on the adequate type of packing to be used.

Materials can be classified in following categories

- Hazardous Material
- Non-Hazardous Material
-

Further to above categorisation, non-hazardous materials can be sub- categorised for selection of packing.

6.1 Hazardous Materials

Though handling of hazardous material may is not applicable in the scope of this specification. All hazardous material must be packed in adherence to the detailed requirement relating to packing, marking and labelling set out in the most recent report of the Board's Standard Advisory Committee on the Carriage of Dangerous Goods in Ships for sea freight, and the Restricted Articles Regulations, laid down by the International Air Transport Association for airfreight.

6.2 Non-Hazardous GOODS

The scope of this specification is to provide necessary guidelines for packing for power plant equipment, components, Pipings & Valves, Fittings, other structural items, electrical items, spare parts and erection materials. The procedure is defined in subsequent paragraphs in details in clause no. 8.0.

	TITLE	SPECIFICATION NO. PE-TS-888-100-A001	
	TECHNICAL SPECIFICATION FOR SEAWORTHY PACKING FOR EXPORT JOBS	VOLUME II B	
		SECTION D	
		REV. NO. 0	DATE 10/08/2010
		SHEET 3	OF 52

7.0 Marking Instructions & Despatch details, Storage Code**7.1 Marking Instructions & despatch details**

Packages and crates will be marked with indelible black paint, resistant to seawater. Marking must be perfectly legible.

The shipping marks, which will be as per fig-13, shall be stencilled on two sides and one end in clear characters at least 5 centimetres high (where crate size permits, otherwise use optimum size for each package dimension).

When the GOODS are to be shipped in containers then marking may be stencilled on one end only. However, packages must be stowed in a manner that shows these marks.

Crates containing fragile articles must be packed with special precaution against risk of breakage and must be stencilled on all sides "FRAGILE - HANDLE WITH CARE". Where crates are not to be overturned, VENDOR must show on the crates, clear and readily visible identification as per fig-12, to ensure they are kept in the correct position.

Packages/equipment of 2,000 kg or more must be marked with slinging points on all sides, in addition to the centre of gravity marks.

Number packages consecutively i.e. 1 of 10, 2 of 10, etc. Do not duplicate package numbers. VENDOR is responsible for any loss or damage caused by incorrect marking.

All cases/crates shall also be marked with the appropriate international standard graphic symbols for handling as shown in Fig 12.

As a minimum, all cases/crates are to be marked clearly on all four sides with:

- "HANDLE WITH CARE"
- "RIGHT SIDE UP"
- "KEEP DRY"

In the case of packages with a single gross weight totalling 2,000 kg and/or a height of more than 1m, the centre of gravity shall be clearly marked with the symbol on two adjoining sides. For all items of equipment with an eccentric centre of gravity this symbol shall be marked at the bottom, side and top of the package.

The slinging and lashing points shall be marked with a chain symbol.

When packing in cases/crates, these packages shall also have metal corners at the slinging points. (Fig-11)

External front and rear sides of the boxes to be planed for writing instructions.

Dispatch details such as consigner/consignee address, contract and case details, country of origin, port of delivery, stacking instructions shall be written on one side of the boxes. An anodized aluminum plate as per details and specifications given in fig-13 shall be provided on one side of the boxes.

One copy of packing slip wrapped in polyethylene bag covered with aluminum packing slip holder to be nailed on the external surface of the box. One more copy of the packing slip wrapped in polyethylene bag is to be kept inside the box at the pertinent place.

	TITLE TECHNICAL SPECIFICATION FOR SEAWORTHY PACKING FOR EXPORT JOBS	SPECIFICATION NO. PE-TS-888-100-A001	
		VOLUME II B	
		SECTION D	
		REV. NO. 0	DATE 10/08/2010
		SHEET 4	OF 52

7.2 Storage Code

The type of storage required is required to be specified, it will be shown on each packaging in RED colour.

- X Crates or packages to be stored outdoor without covers
- XX Crates or packages to be stored under tarpaulin
- XXX Crates or packages to be stored in covered or enclosed premises
- XXXX Crates or packages which must be stored in air-conditioned premises

8.0 GUIDELINES FOR PACKING GOODS

8.1 In the subsequent paragraphs details of different types of packings for different types of GOODS are defined. Vendor shall make packing details/procedure based on the guidelines and submit for approval.

8.1.1 Packing for Pipe, Fittings, Flanges and Valves, Structural Steel

Particular attention should be brought to pipe, fittings, flanges, valves and structural steel. Packing categories for piping and fittings will differ according to the diameter and wall thickness of these products. VENDOR shall comply with the following established practice.

IMPORTANT NOTE:

Depending on the project schedule and availability of ocean vessels, the piping and structural steel may be shipped in containers. In this event, VENDOR has to arrange the packages in such a way it allows the stuffing into Open Top in gauge containers.

8.1.2 Pipe

Where practicable, pipe lengths shall be limited to 11.8 meters.

All pipes 2" included and below shall be packed in crates. All pipes to be capped and ends sealed with waterproof tape.

Pipes over 2" up to 6", shall be bundled and banded in bundles of uniform length. Bundling is carried out with U-IRON or traversal planks, joined with threaded connecting rods with locknuts. Quantities and strapping positions depend on the lengths, with a 120 cm spacing to prevent distortion. Bundle weight shall not exceed 2,000 kg. All pipes are to be capped and ends sealed with waterproof tape (tape is not necessary if end caps are of the pre-shrunk or self-sealing type).

Pipes larger than 6" shall be shipped as single lengths with the ends capped. End caps are to be of the recessed type to enable the use of soft faced hooks, but still completely sealing the end and also protecting the weld.

All stainless steel piping must be packed separately in wooden crates. Any banding of bundles is to be with the same material.

8.1.3 Pipe Fittings, Flanges and Valves

All pipe fittings, flanges and valves up to 6", are to be packed in cases/crates. For items over 6", these may be fixed securely to a pallet base and enclosed in a crate, for protection. Where valves have actuators attached, rigidity must be ensured for the valve and actuator. The vulnerable parts of the actuator are to be completely protected within a wooden crate.

All stainless steel fittings, flanges and valves of all sizes, must be packed separately in wooden crates. Any strapping is to be with the same material.

8.1.4 Structural Steel

	TITLE TECHNICAL SPECIFICATION FOR SEAWORTHY PACKING FOR EXPORT JOBS	SPECIFICATION NO. PE-TS-888-100-A001	
		VOLUME II B	
		SECTION D	
		REV. NO. 0	DATE 10/08/2010
		SHEET 5	OF 52

Structural Steel, reinforcing rods, bars, etc., should be packed in bundles of uniform length. Refer to articles 8.1.2, for strapping requirements. Bundle weight not normally to exceed 2,000 kg. Fabricated structures and structural steelwork, etc, should be bundled and packed using wooden beams and long bolting to secure the load.

8.2 Bundling – Packing Category I

8.2.1 Type of Equipment

Equipment which is not subject to damage by corrosion or mechanical effect, i.e. pipes, piping, structural steel.

Packing category I

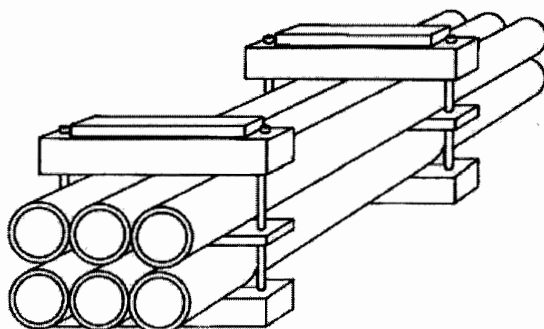

Bundling by U-shaped iron – packing category I A

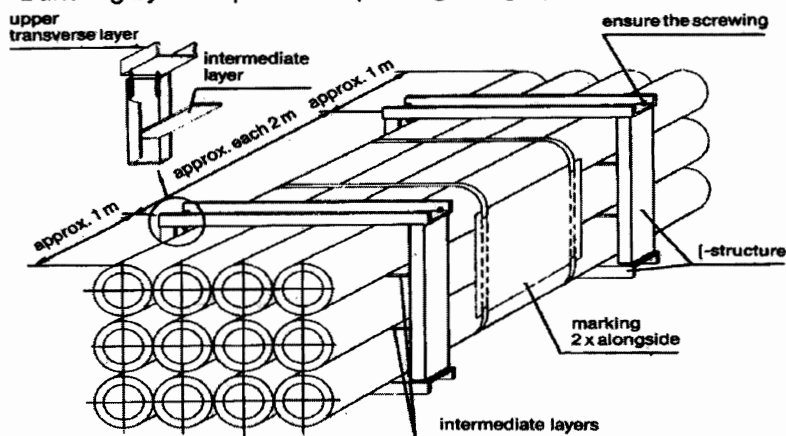

8.2.2 Type of Construction

	TITLE TECHNICAL SPECIFICATION FOR SEAWORTHY PACKING FOR EXPORT JOBS	SPECIFICATION NO. PE-TS-888-100-A001	
		VOLUME II B	
		SECTION D	
		REV. NO. 0	DATE 10/08/2010
		SHEET 6	OF 52

- Bundling has to be effected
- By squared timber and threaded rods.
- With an intermediate layer (threaded on tightening bolts) according to the weight of the package.
- Wedge-shaped timbers must be added at the outer points of lower layer.
- Between the bolts a spacer must be nailed.
- The bolts must be secured (e.g. by locking nut).
- If single parts could protrude, an appropriate protection must be installed (flat iron or plates).
- Bundling with steel straps or PVC straps is not accepted.

8.3 Skids, Square Timber Constructions, Casings – Packing (Category II)

8.3.1 Type of Equipment

Voluminous apparatus, tanks and/or heavy pieces those are not vulnerable to mechanical or corrosive effects.

8.3.2 Type of Construction

- The construction skid can be made of wood or of metal.
- The fastening of the packages on the skid will be made by steel straps (flat iron) which have to be elastically lined, non-slip and securely bolted onto the skids.
- Flange openings have to be closed with gaskets and blind flanges or, if necessary, provided with cover.
- Skid constructions may not be less than the dimensions of the package in length or in width.
- Tanks and apparatus with their own support cradles must be supplied with an anti-slip lining.

PACKING CATEGORY-II

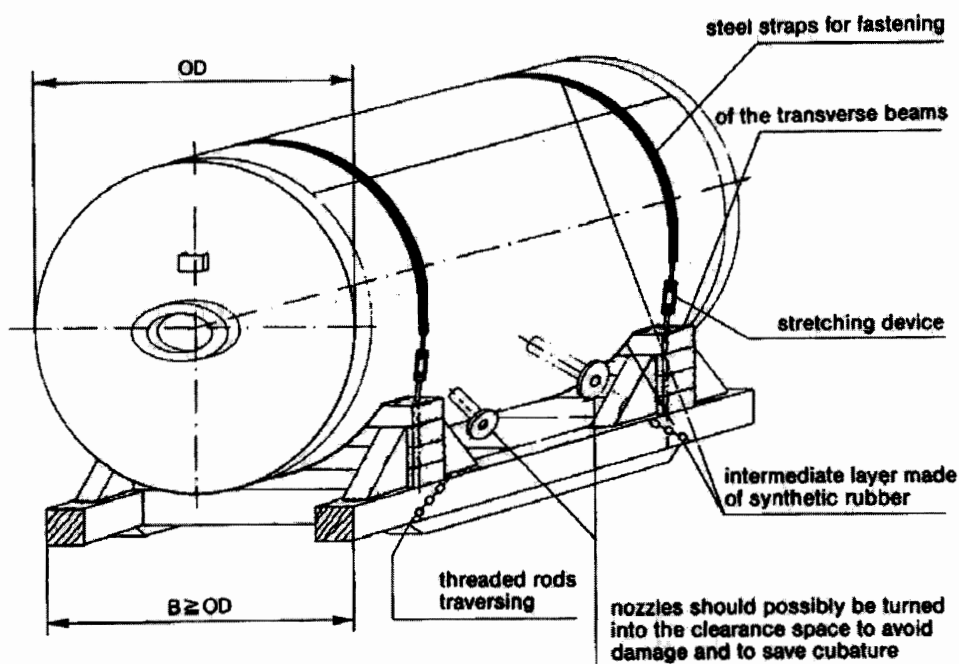

	TITLE	SPECIFICATION NO. PE-TS-888-100-A001	
	TECHNICAL SPECIFICATION FOR SEAWORTHY PACKING FOR EXPORT JOBS	VOLUME II B	
		SECTION D	
		REV. NO. 0	DATE 10/08/2010
		SHEET 7	OF 52

8.4 Packing of GOODS in Wooden Crates/Cases/Boxes

The construction of wooden crate/cases/boxes shall be as per the details indicated in clause 9.0 & Fig 1 to 11. Details indicated in the sketches for different categories Packing crates/boxes are only for a typical equipment considered for illustration.

8.4.1 Packing Category III

8.4.1.1 Type of Equipment

Fabricated equipment, which cannot be transported on cradles; frame-works, prefabricated piping and fittings, mechanical and electrical assemblies. This type of packing is recommended where many parts of the equipment/component/assembly are not protruding out.

8.4.1.2 Type of Construction

The equipment must be safely fastened to the bottom with bolts, possibly by the runners or to be spread in such a manner that no protruding parts are possible. For parts, sensitive to rainwater and/or debris, a protection has to be made by a foil cap.

If it is possible that single part could protrude through the front/back side wall, they shall be closed completely. The marking of the package shall be done on plywood plates at the prescribed sides.

Packing Category III

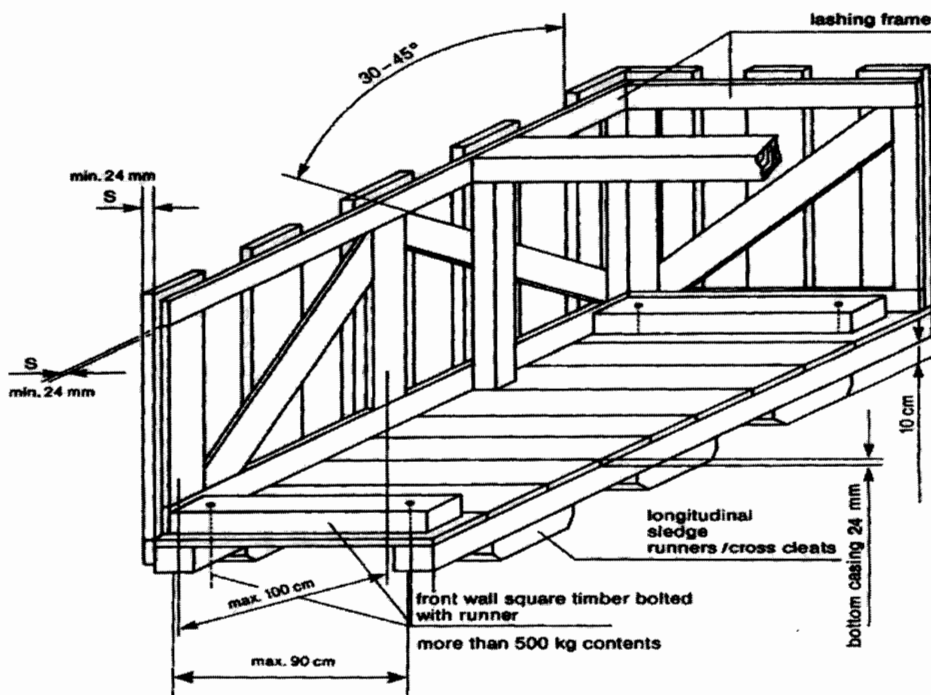

	TITLE	SPECIFICATION NO. PE-TS-888-100-A001	
	TECHNICAL SPECIFICATION FOR SEAWORTHY PACKING FOR EXPORT JOBS	VOLUME II B	
		SECTION D	
		REV. NO. 0	DATE 10/08/2010
		SHEET 8	OF 52

8.4.2 Cases with Lining – Packing Category IV

8.4.2.1 Type of Equipment

Recommended for equipment and mechanical parts Equipment sensitive to mechanical damage or parts and components that are particularly at risk of theft or loss; pumps, elbows, flanges, fittings, tools, erection materials, etc.

8.4.2.2 Type of Construction

The same type of construction as article 8.4.1.2, but with all sides completely boarded without space between the boards. Sides to be provided with waterproof lining; fabric-reinforced waterproof tar paper or polyethylene-foils resistant to ultraviolet rays can be used. Polyethylene-foil shall be fixed under the lid cover to avoid penetration of water. At weights of more than 500 kg the longitudinal runner must be bolted to the front all square timber. For ventilation inside the case, an opening in the waterproof lining must be placed between the diagonal battens and diagonal joists.

Packing Category IV

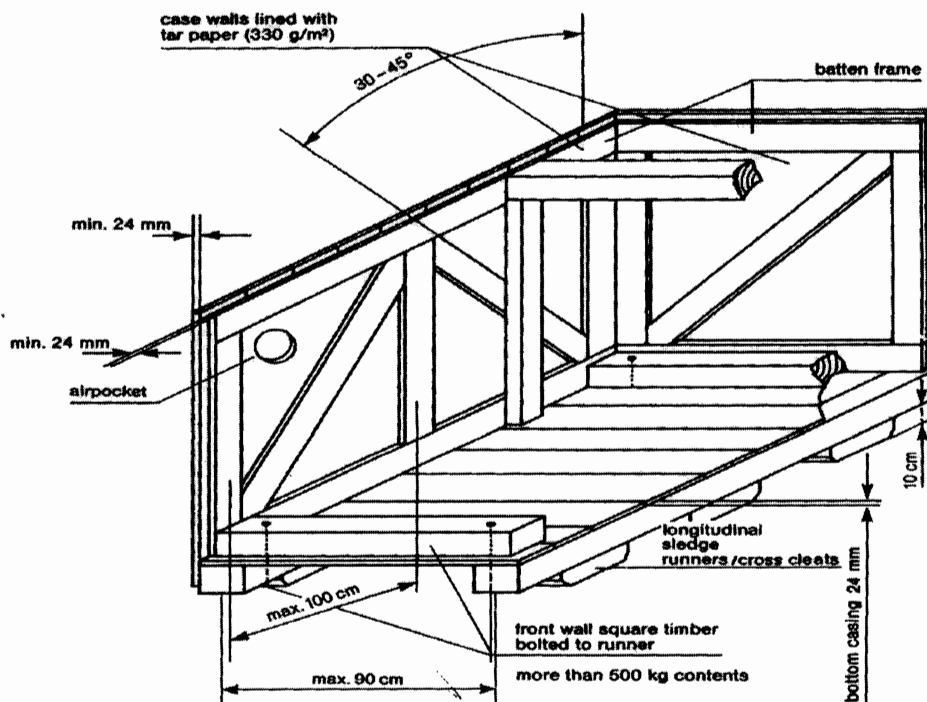

8.4.3 Cases with Alternative Surface Materials

8.4.3.1 Plywood Box – Packing Category IV A

	TITLE	SPECIFICATION NO. PE-TS-888-100-A001	
	TECHNICAL SPECIFICATION FOR SEAWORTHY PACKING FOR EXPORT JOBS	VOLUME II B	
		SECTION D	
		REV. NO. 0	DATE 10/08/2010
		SHEET 9	OF 52

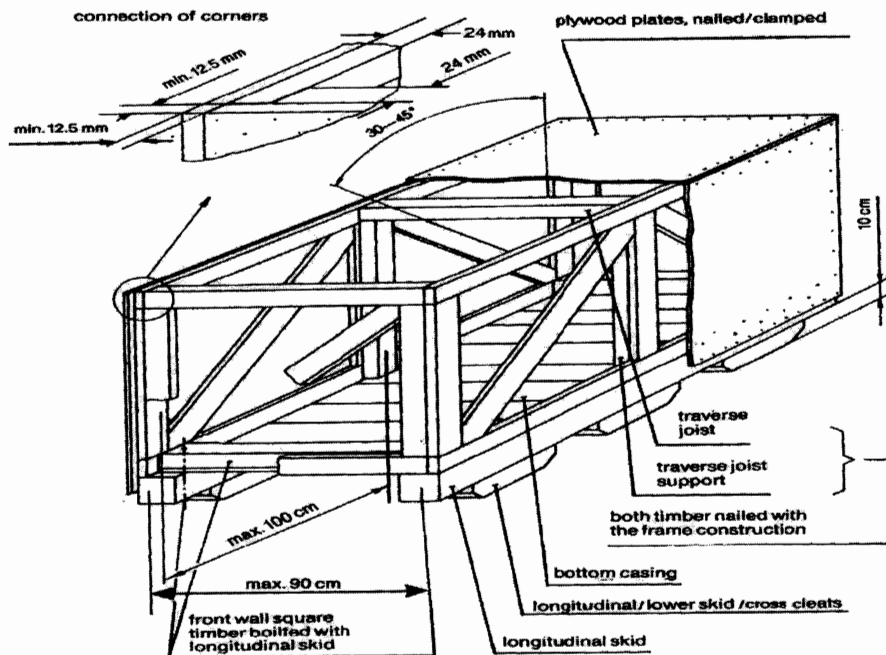

Case constructed of 5 layers of watertight, glued plywood with a total thickness of 12.5 mm. The frame must be constructed from minimum 24 mm timber or as per guide lines given above against clause 8.0, Fig 1 to 11 and must be suitable for the weight and nature of the parts to be packed. Planed square timber must be bolted with longitudinal skid and covered with diagonal joists. If applicable, construction of the cover and sides is to include diagonal bracing. Covers consisting of several layers of plywood are to be sealed with durable elastic putty or additional water-resistant sheets to be fixed.

8.4.4 Case with Barrier Material – Polyethylene Foil – Packing Category V

8.4.4.1 Type of Equipment

Sensitive equipment, simple electrical equipment, insulation materials, fire-resistant materials, with non-corrosion- guarantee for a period up to twelve (12) months.

8.4.4.2 Type of Construction

Preservation by welding in polyethylene-foil with addition of desiccants and if necessary, application of non-corrosive contact agents, otherwise, type of construction as indicated in article 8.4.2.2.

Additional marking:

- Case with desiccants.

8.4.5 Case with Barrier Material – Aluminium Compound Foil – Packing Category VI

8.4.5.1 Type of Equipment

	TITLE	SPECIFICATION NO. PE-TS-888-100-A001	
	TECHNICAL SPECIFICATION FOR SEAWORTHY PACKING FOR EXPORT JOBS	VOLUME II B	
		SECTION D	
		REV. NO. 0	DATE 10/08/2010
		SHEET 10	OF 52

Electrical equipment such as, switchboards, electric motors, sensitive equipment, with non-corrosion guarantee, for a period up to twelve (12) months.

8.4.5.2 Type of Construction

Type of construction as indicated in article 8.4.2.2. Preservation by sealing an aluminium compound foil, with the addition of desiccants. Humidity indicators, if required and installed in the barrier wrapping, shall allow easy control from the outside.

Additional marking:

- Case with desiccants.

Packing Category VVI

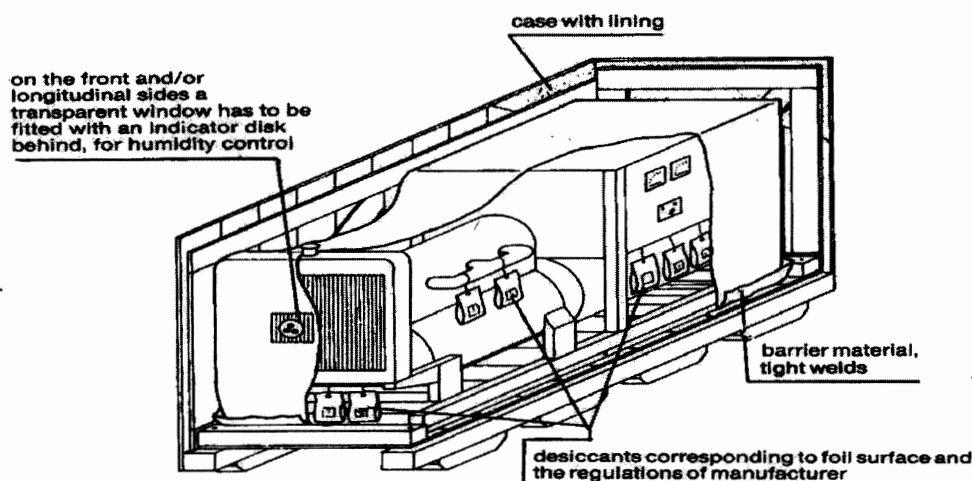

8.4.6 Double Case – Packing Category VII

8.4.6.1 Type of Equipment

GOODS which are of high sensitivity to shock, impact and vibration, for instance, special electrical equipment like computers, switchboards, laboratory instruments

8.4.6.2 Type of Construction

Case construction as indicated in article 8.4.2.2, with additional floating inner packing (case-in-case principle), padding corresponding to weight and sensitiveness. Preservation by sealing in aluminium compound foil with the addition of desiccants. The inner case has to be made of plywood or equivalent material with a thickness of 8-12 mm, depending on the weight of the GOODS to be packed. The inner buckles and/or frame borders have to be dimensioned so that the full stability of the inside case will be reached and no twisting is possible. The inner sides of the inside case will be lined with bituminous kraft paper on all sides (except bottom).

	TITLE	SPECIFICATION NO. PE-TS-888-100-A001	
	TECHNICAL SPECIFICATION FOR SEAWORTHY PACKING FOR EXPORT JOBS	VOLUME II B	
		SECTION D	
		REV. NO. 0	DATE 10/08/2010
		SHEET 11	OF 52

8.4.7 Cable Drum – Packing Category VIII

8.4.7.1 Type of Equipment

All type of cables, wires, ropes, hoses.

8.4.7.2 Type of Construction

For all type of cables refer clause no. 11.1. For other items (wires, ropes, hoses) new or practically new drums are to be used. Planking of the e drums by use of boards, thickness minimum 20 mm, with additional double steel strapping, nailed, and carefully preserved/protected cable ends prior to packing.

8.4.8 Hazardous Materials – Packing Category IX

8.4.8.1 Type of Equipment

Hazardous materials according to the law are explosives, compressed gases, liquefied gases dissolved under pressure or deeply refrigerated, flammable liquids, flammable solids: substances liable to spontaneous combustion; substances which, on contact with water, emit flammable gases, oxidizing substances, organic peroxides, poisonous (toxic) and infectious substances; radioactive materials, corrosives, miscellaneous dangerous goods.

8.4.8.2 Type of Construction

Hazardous materials shall always be packed and documented separately from any other material. Selection of packaging materials, execution of packing and marking as well as documentation shall always be in compliance with the applicable laws and regulations. Any certificates required for transportation or for authorities to be supplied before shipment of the GOODS.

8.4.9 Wooden Floor as a Transport Support – Packing Category X

8.4.9.1 Type of Equipment

Any materials to be stuffed in containers or on flat racks and that are not stowed on standard pallets or otherwise suitably packed

8.4.9.2 Type of Construction

- Longitudinal internal square timbers bolted to the front wall runners, longitudinal skid.
- Maximum distance between longitudinal runners 90 cm (middle to middle of the runner).
- Full boarding of the floor.
- Attaching of lifting lugs and/or iron ropes for lifting/pulling the units off the transport equipment.
- If applicable, preservation of the equipment by sealing in polyethylene-foil or aluminium compound foil and the addition of desiccants.

8.5 Air Transport Packing

8.5.1 General

Certain types of material may have to be shipped by air from their country of origin. This means of transport will be exceptional, and will be used only:

- For GOODS, which are highly sensitive to shock or vibrations, such as computers, electronic instruments, or those of small dimensions and weight.
- For GOODS urgently required at the module yard(s) and/or jobsite.

	TITLE TECHNICAL SPECIFICATION FOR SEAWORTHY PACKING FOR EXPORT JOBS	SPECIFICATION NO. PE-TS-888-100-A001	
		VOLUME II B	
		SECTION D	
		REV. NO. 0	DATE 10/08/2010
		SHEET 12	OF 52

8.5.2 Type of Packing

Depending on the goods to be packed, VENDOR may use one of the following types:

- A triple-corrugated cardboard container made with waterproofed glue and a barrier layer of polyethylene on the outsides to keep out humidity.
- Wooden/cardboard packing cases: the wood being used for the framework and base of the cases, waterproofed triple-corrugated cardboard being used for the sides and top. These cases are of the "Bell" type, and used for material of small or medium dimensions.
- For larger dimensions, plywood cases are acceptable. The timber characteristics, cross-sections and thickness will be systematically determined by the nature of the loads to be packed.

8.5.3 Dimensions

In order to optimize the existing transport facilities (passenger or cargo aircraft), the dimensions of:

- Triple-corrugated containers.
 - Wooden/cardboard packing cases.
 - Plywood cases.
- Are to be adapted to pallets used for air transportation.

9.0 Detailed specification for Wooden Crates/Boxes/Cases and other packing materials

9.1 Technical specification for wood

The wood shall be Fir, Chir, Silver Oak (Gravillea Robusta), chemically treated mango and Pinewood with moisture content not exceeding 50%. The wood shall have flexural and compressive strength, stiffness, shock absorption and nail retention properties. The wood shall be free from common defects such as warp, bone, twist, knot, crakes, splits, end splits, bend, visible sign of infection and any kind of decay caused by insects or fungus, etc. Surface cracks with maximum depth of 3mm are permissible. A continuous crack of any depth all along the length is not allowed.

9.2 Chemical Treatment of Wood:

The wood shall be chemically treated to provide protection against deterioration due to fungi and attack by termites, borers, marine organism and any other kind of infection. It shall be treated only after final processing like cutting, planning, joint grooving, etc.

9.3 TYPE, DESIGN & DIMENSION OF WOODEN PACKING CASES:

9.3.1 PACKING OF EQUIPMENTS

Various mechanical, electrical and C&I equipment e.g. Pumps, motors, equipment skids, heat exchangers, control panels, switch gears, transformers, etc. shall be wrapped in weather proof packing and then secured in wooden packing cases. The construction of wooden packing cases/crates shall be as per details given below and also given in figure 1 to 11.

9.3.1.1 Bottom Frame

	TITLE TECHNICAL SPECIFICATION FOR SEAWORTHY PACKING FOR EXPORT JOBS	SPECIFICATION NO. PE-TS-888-100-A001	
		VOLUME II B	
		SECTION D	
		REV. NO. 0	DATE 10/08/2010
		SHEET 13	OF 52

The construction of bottom frame shall be as per Fig-2. The No. of slides/runners for bottom frames shall be selected depending upon the weight and overall dimensions of the load to be carried. The equipment shall be secured by fixing their base frame/plate with the help of bolt and nuts etc. to bottom frame of the wooden packing cases/crates. The equipment not provided with base frame/plate like cylindrical vessels, etc to be secured to the bottom frame of the wooden cases with "C" clamps fabricated from steel channels/ angle iron.

9.3.1.2 TOP FRAME

The construction of top frame shall be as per fig-3.

9.3.1.3 END PANELS

The dimension of the end and lateral panels shall be calculated according to overall dimensions of the items to be packed. Diagonal braces shall be used for packing cases having height exceeding 500mm. Details of bracings shall be as per fig 5 to 9.

9.3.1.4 Sling Plate

To facilitate lifting of cases, longitudinal under slide boards shall be fixed. To avoid damage to the box while lifting sling plates shall be provided. Refer fig-11.

9.3.1.5 Angle Iron Cleats

Angle iron cleats shall be used for strengthening the joints as indicated in fig-10

9.3.1.6 Other Requirements

- The thickness of planks for top, bottom, side and end panels shall be at least 25mm. Planks used for this purpose shall be joined with each other by tongue and groove joint. The groove dimension shall be such that tongue fits tightly into groove to make the joint.
- Runners/slides, traverse bars, etc shall be of single length i.e. without any joint. Planks for sheathing, diagonal bracing etc shall also be of single length up to 2400mm, proper jointing is permitted for planks for sheathing and diagonal bracings.
- Each equipment to be individually covered with double polyethylene petticoat. Sheet thickness of polythene sheet shall not be less than 0.175 mm (175 microns). The sealing shall be such so as not to allow moisture inside.
- The inner surface of 4 sides of shooks shall be nailed with bituminized water proof craft paper. Wherever 2 pieces of kraft paper are used, joint shall have an overlap of minimum 20 mm.
- All the inner sides of the box shall be nailed with bitumen coated HESSIAN POLYTHYLENE KRAFT PAPER. For top frame it shall project on all sides by 100mm and shall be nailed on sides. Wherever 2 pieces of kraft paper are used, joint shall have an overlap of minimum 20 mm.
- For delicate equipment like control panels and switchgears, lighting panels and lighting transformers, suitable cushioning material like rubberised coir (min. 50 mm thick and 100 mm wide) shall be provided on their bottom support and the gap between the panel and casing

	TITLE TECHNICAL SPECIFICATION FOR SEAWORTHY PACKING FOR EXPORT JOBS	SPECIFICATION NO. PE-TS-888-100-A001	
		VOLUME II B	
		SECTION D	
		REV. NO. 0	DATE 10/08/2010
		SHEET 14	OF 52

shall be filled with rubberized coir with distance between consecutive supports less than 500 mm (ref fig15). For other equipment suitable support from sides of the casing shall be provided.

- Switchgear cubicles, control panels and control desks shall be packed and shipped in separate convenient sections. The components e.g. circuit breakers relays and instruments etc. which are removed from panels for shipping purpose and shall be separately packed and shipped as per packing instructions in clause 10.4.
- Packing case for control panels and switchgear panels shall be finally covered with GI sheet of minimum thickness of 0.4mm.
- Packing cases shall be bound at edges by nailing MS clamps/brackets at sufficient intervals. Further heavier boxes shall be strapped with C clamps (ref fig-4) fabricated from steel channels/angles and lighter boxes shall be strapped with hoop iron strips.
- Silica gel is used for this purpose to protect contents over sufficiently long time from corrosion. Silica gel shall be indicating type confirming to IS-304 (1979) packed in cotton bags placed at different positions inside the packing for absorbing moisture and shall not come into directly contact with equipment/material inside the package. The quantity of silica gel shall be adequate for storage period of one year, however it shall not be less than 4 gm. per ltr. Volume of case subject to minimum 400 gm. Per case.

	TITLE	SPECIFICATION NO. PE-TS-888-100-A001	
	TECHNICAL SPECIFICATION FOR SEAWORTHY PACKING FOR EXPORT JOBS	VOLUME II B	
		SECTION D	
		REV. NO. 0	DATE 10/08/2010
		SHEET 15	OF 52

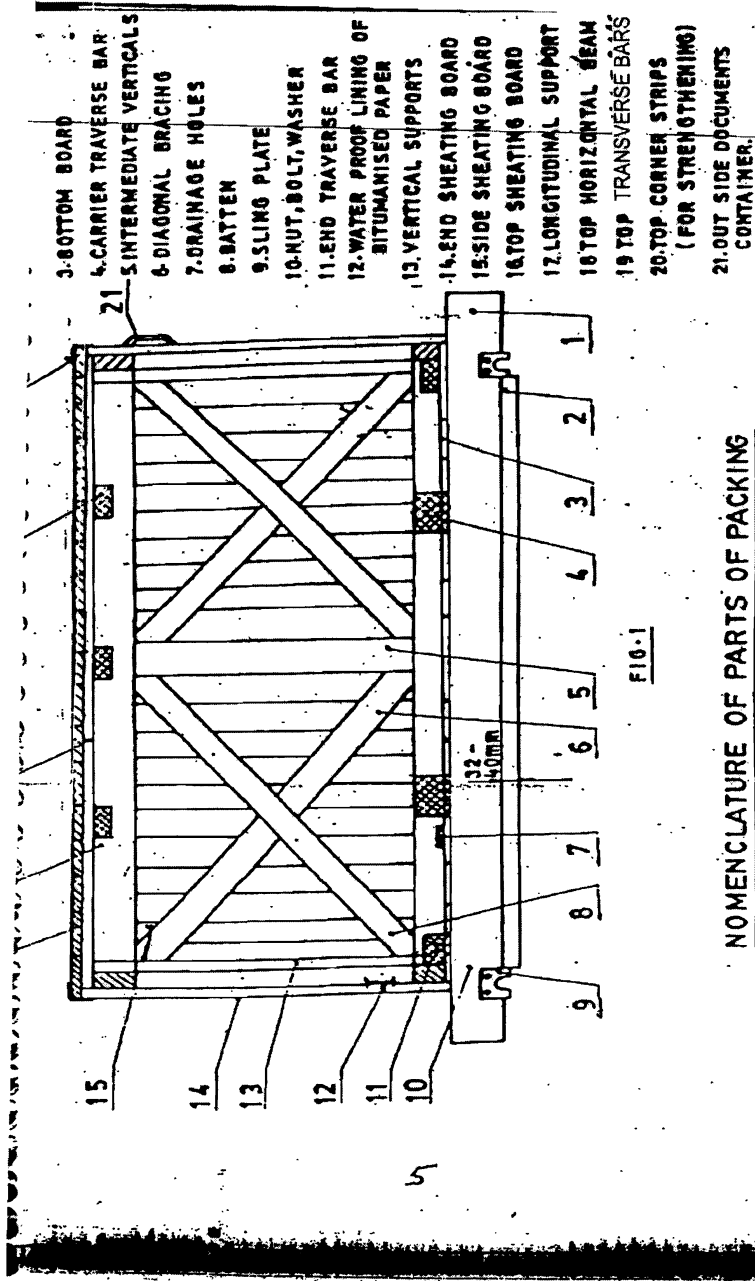

NOMENCLATURE OF PARTS OF PACKING

CASES

- 1 SLIDE
- 2 UNDER SLIDE BOARD

FIG-1

626

EC-009

	TITLE	SPECIFICATION NO. PE-TS-888-100-A001		
	TECHNICAL SPECIFICATION FOR SEAWORTHY PACKING FOR EXPORT JOBS	VOLUME II B		
		SECTION D		
		REV. NO. 0	DATE 10/08/2010	
		SHEET 16	OF	52

BOTTOM FRAME ARRANGEMENTS

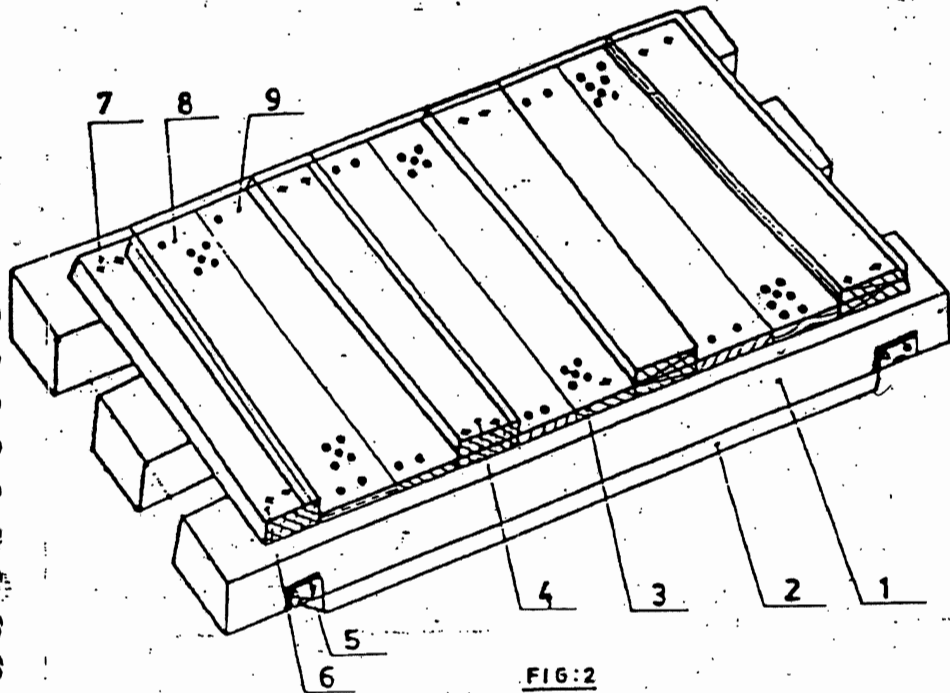

Nos. of slides: Minimum 2 Nos.
 For length more than 1800 mm or
 load more than 1000kg, nos. of
 slides shall be minimum 3 Nos.
 For dimensions of slides, refer Table 1
 Cross section of end traverse bar; 100 x 100 mm.
 (minimum)

- 1. SLIDE
- 2. UNDER SLIDE BOARD
- 3. BOTTOM BOARD
- 4. CARRIER TRAVERSE BAR
- 5. SLING PLATE
- 6. TRAVERSE BAR
- 7. BOLT, NUT & WASHER
- 8. DRAINAGE HOLES
- 9. NAILS

027

	TITLE	SPECIFICATION NO. PE-TS-888-100-A001	
	TECHNICAL SPECIFICATION FOR SEAWORTHY PACKING FOR EXPORT JOBS	VOLUME II B	
		SECTION D	
		REV. NO. 0	DATE 10/08/2010
		SHEET 17	OF 52

TOP FRAME ARRANGEMENT

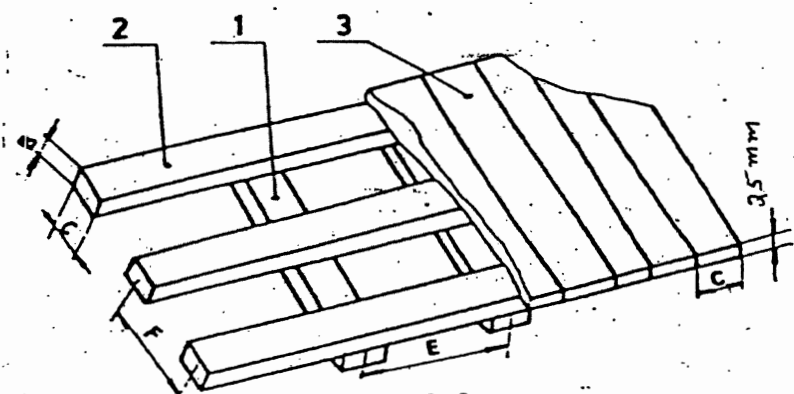
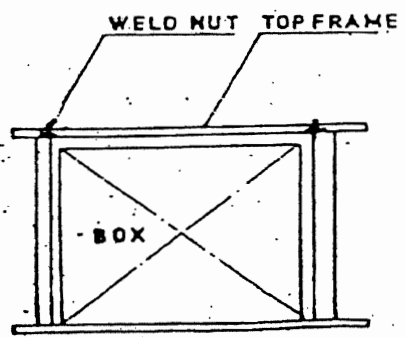
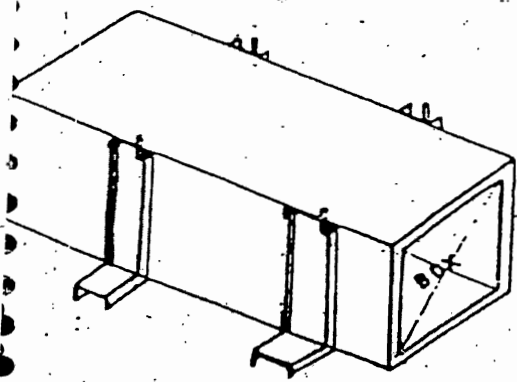

FIG-3

F : 700 to 1000 mm
 E : 500 to 900 mm
 30x100 mm.

- 1 - Traverse Bars
- 2 - Horizontal Soans
- 3 - Top Board

ARRANGEMENT OF C-CLAMPS AROUND CASES



028

	TITLE	SPECIFICATION NO. PE-TS-888-100-A001	
	TECHNICAL SPECIFICATION FOR SEAWORTHY PACKING FOR EXPORT JOBS	VOLUME II B	
		SECTION D	
		REV. NO. 0	DATE 10/08/2010
		SHEET 18	OF 52

ARRANGEMENT OF DIAGONAL BRACING AND HORIZONTAL SUPPORT

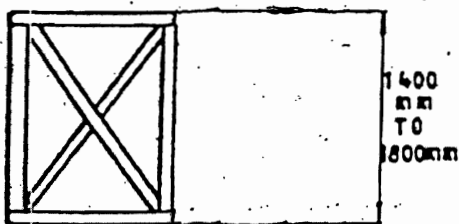

FIG: 6

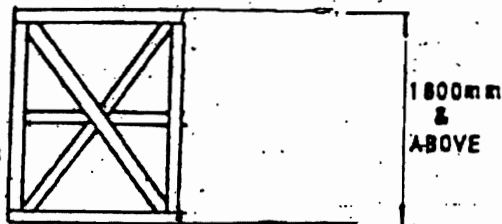

FIG: 8

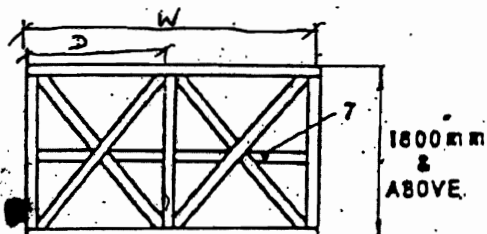

FIG: 9

7- Middle Horizontal Support

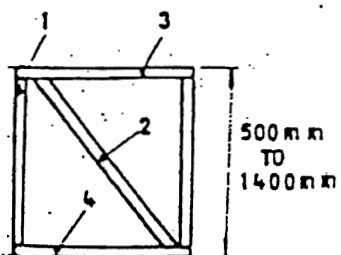

FIG: 5

1- Vertical Support

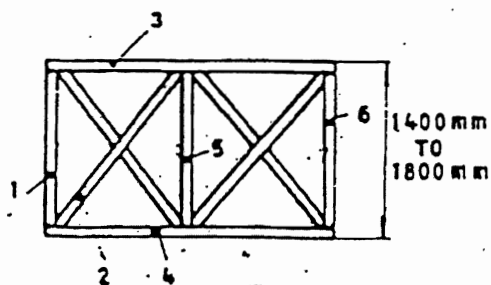



FIG: 7

1, 5, 6 - Vertical Support

029

	TITLE	SPECIFICATION NO. PE-TS-888-100-A001	
	TECHNICAL SPECIFICATION FOR SEAWORTHY PACKING FOR EXPORT JOBS	VOLUME	II B
		SECTION	D
		REV. NO. 0	DATE 10/08/2010
		SHEET	19 OF 52

ARRANGEMENT OF PACKING CASE

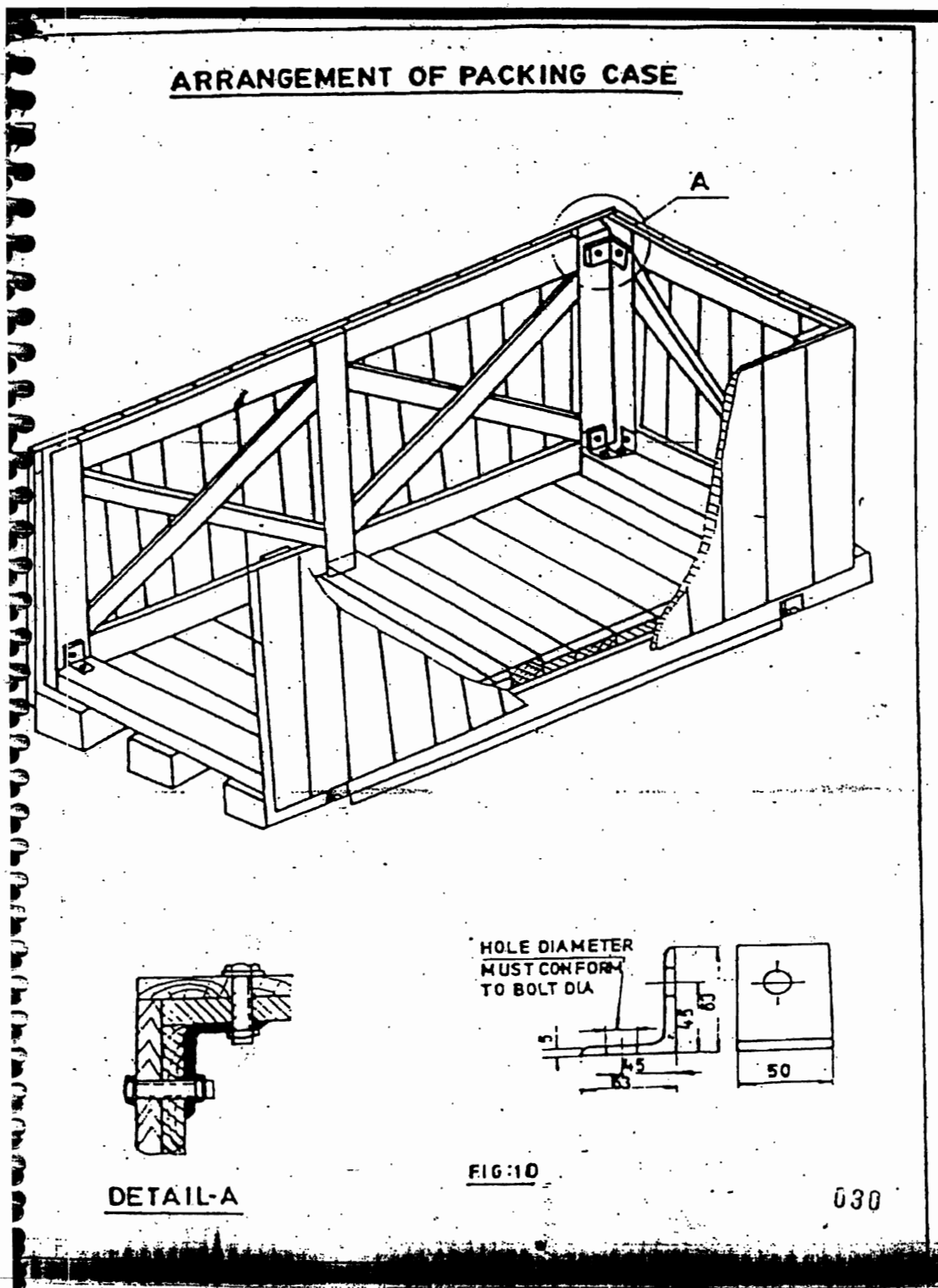

	TITLE	SPECIFICATION NO. PE-TS-888-100-A001		
	TECHNICAL SPECIFICATION FOR SEAWORTHY PACKING FOR EXPORT JOBS	VOLUME II B		
		SECTION D		
		REV. NO. 0	DATE 10/08/2010	
		SHEET 20	OF	52

**ARRANGEMENT OF SLING & PLATE ON
CASES**

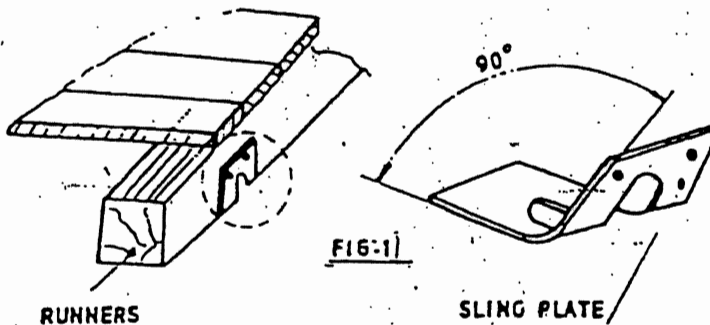

031

	TITLE	SPECIFICATION NO. PE-TS-888-100-A001	
	TECHNICAL SPECIFICATION FOR SEAWORTHY PACKING FOR EXPORT JOBS	VOLUME II B	
		SECTION D	
		REV. NO. 0	DATE 10/08/2010
		SHEET 21	OF 52

TABLE-1

LOADS	LENGTHS OF SLIDES						
	600	800	1000	1200	1300	1500	2000
	Cross section b x c				<div style="border: 1px solid black; display: inline-block; width: 40px; height: 15px;"></div> c b		
500	50 X 100	50 X 100	50 X 100	50 X 100	75 X 100	75 X 100	100 X 100
800	50 X 100	50 X 100	75 X 100	75 X 100	75 X 100	75 X 100	100 X 100
1000	75 X 100	75 X 100	75 X 100	100 X 100	100 X 100	100 X 110	100 X 150
1500	75 X 100	75 X 100	100 X 100	100 X 100	100 X 100	100 X 150	100 X 150
2000	75 X 100	100 X 100	100 X 100	100 X 150	100 X 150	100 X 150	150 X 150
2500	75 X 100	100 X 100	100 X 150	100 X 150	100 X 150	150 X 150	150 X 150
3000	100 X 100	100 X 150	150 X 150	150 X 150	150 X 150	150 X 150	150 X 150









	TITLE	SPECIFICATION NO. PE-TS-888-100-A001	
	TECHNICAL SPECIFICATION FOR SEAWORTHY PACKING FOR EXPORT JOBS	VOLUME II B	
		SECTION D	
		REV. NO. 0	DATE 10/08/2010
		SHEET 22	OF 52

Table-2



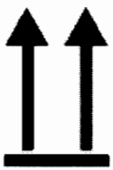



End and side panels	Width of the panel "W"	Distance between longitudinal support (Dimension "D")						
		600	800	1000	1200	1400	1600	1800
		Cross section b x c				Item 1 to 7		
Fig- 5 to Fig-9	600 to 1200	30 X 100	30 X 100	30 X 100	30 X 130	30 X 130	30 X 130	30 X 130
	1201 to 1600	30 X 130	30 X 130	30 X 130	30 X 130	30 X 130	30 X 130	30 X 130
	1601 to 2000	30 X 130	30 X 130	30 X 130	30 X 130	30 X 130	30 X 130	30 X 130
	2001 to 3000	30 X 130	30 X 130	30 X 130	30 X 130	30 X 130	30 X 130	40 X 150
	3001 to 4000	40 X 150	40 X 150	40 X 150	40 X 150	40 X 150	40 X 150	40 X 150

	TITLE	SPECIFICATION NO. PE-TS-888-100-A001	
	TECHNICAL SPECIFICATION FOR SEAWORTHY PACKING FOR EXPORT JOBS	VOLUME II B	
		SECTION D	
		REV. NO. 0	DATE 10/08/2010
		SHEET 23	OF 52

INDICATION MARKS ON CASES/BOXES/CRATES

Designation	Symbol	Explanation
Fragile, Handle with care		The symbol should be applied to easily broken cargoes. Cargoes marked with this symbol should be handled carefully and should never be tipped over or slung.
Use no hooks		Any other kind of point load should also be avoided with cargoes marked with this symbol. The symbol does not automatically prohibit the use of the plate hooks used for handling bagged cargo.
Top		The package must always be transported, handled and stored in such a way that the arrows always point upwards. Rolling, swinging, severe tipping or tumbling or other such handling must be avoided.
Keep away from heat (solar radiation)		Compliance with the symbol is best achieved if the cargo is kept under the coolest possible conditions. In any event, it must be kept away from additional sources of heat. It may be appropriate to enquire whether prevailing or anticipated temperatures may be harmful.
Protect from heat and radioactive sources		Stowage as for the preceding symbol. The cargo must additionally be protected from radioactivity.
Sling here		The symbol indicates merely where the cargo should be slung, but not the method of lifting. If the symbols are applied equidistant from the middle or center of gravity, the package will hang level if the slings are of identical length. If this is not the case, the slinging equipment must be shortened on one side.
Keep dry		Cargo bearing this symbol must be protected from excessive humidity and must accordingly be stored under cover. If particularly large or bulky packages cannot be stored in warehouses or sheds, they must be carefully covered with tarpaulins.

	TITLE	SPECIFICATION NO. PE-TS-888-100-A001	
	TECHNICAL SPECIFICATION FOR SEAWORTHY PACKING FOR EXPORT JOBS	VOLUME II B	
		SECTION D	
		REV. NO. 0	DATE 10/08/2010
		SHEET 24	OF 52

Center of gravity		This symbol is intended to provide a clear indication of the position of the center of gravity. To be meaningful, this symbol should only be used where the center of gravity is not central. The meaning is unambiguous if the symbol is applied onto two upright surfaces at right angles to each other.
No hand truck here		The absence of this symbol on packages amounts to permission to use a hand truck on them.
Stacking limitation		The maximum stacking load must be stated as "... kg max.". Since such marking is sensible only on packages with little loading capacity, cargo bearing this symbol should be stowed in the uppermost layer.
Clamp here		Stating that the package may be clamped at the indicated point is logically equivalent to a prohibition of clamping anywhere else.
Temperature limitations		According to regulations, the symbol should either be provided with the suffix "...°C" for a specific temperature or, in the case of a temperature range, with an upper ("...°C max.") and lower ("...°C min.") temperature limit. The corresponding temperatures or temperature limits should also be noted on the consignment note.
Do not use forklift truck here		This symbol should only be applied to the sides where the forklift truck cannot be used. Absence of the symbol on other sides of the package amounts to permission to use forklift trucks on these sides.
Electrostatic sensitive device		Contact with packages bearing this symbol should be avoided at low levels of relative humidity, especially if insulating footwear is being worn or the ground/floor is nonconductive. Low levels of relative humidity must in particular be expected on hot, dry summer days and very cold winter days.

	TITLE TECHNICAL SPECIFICATION FOR SEAWORTHY PACKING FOR EXPORT JOBS	SPECIFICATION NO. PE-TS-888-100-A001	
		VOLUME II B	
		SECTION D	
		REV. NO. 0	DATE 10/08/2010
		SHEET 25	OF 52



Do not destroy barrier		A barrier layer which is (virtually) impermeable to water vapor and contains desiccants for corrosion protection is located beneath the outer packaging. This protection will be ineffective if the barrier layer is damaged. Since the symbol has not yet been approved by the ISO, puncturing of the outer shell must in particular be avoided for any packages bearing the words "Packed with desiccants".
Tear off here		This symbol is intended only for the receiver.

FIG-12

	TITLE	SPECIFICATION NO. PE-TS-888-100-A001		
	TECHNICAL SPECIFICATION FOR SEAWORTHY PACKING FOR EXPORT JOBS	VOLUME II B		
		SECTION D		
		REV. NO. 0	DATE 10/08/2010	
		SHEET 26	OF	52



		BHEL-PEM-DELHI-INDIA			
CONSIGNEE					
MATERIAL					
CUSTOMER REF.			M.O. NO.		
DESPATCH ADVICE NOTE NO.			CASE NO.		
DIMENSIONS(MM) LXBXH	NET WT -KGS		GROSS WT -KGS		
SPECIAL INSTRUCTIONS	HANDLE WITH CARE -- KEEP DRY DO NOT DROP -- DO NOT TILT				

FIG-13: MARKING PLATE

535

	TITLE	SPECIFICATION NO. PE-TS-888-100-A001	
	TECHNICAL SPECIFICATION FOR SEAWORTHY PACKING FOR EXPORT JOBS	VOLUME II B	
		SECTION D	
		REV. NO. 0	DATE 10/08/2010
		SHEET 27	OF 52

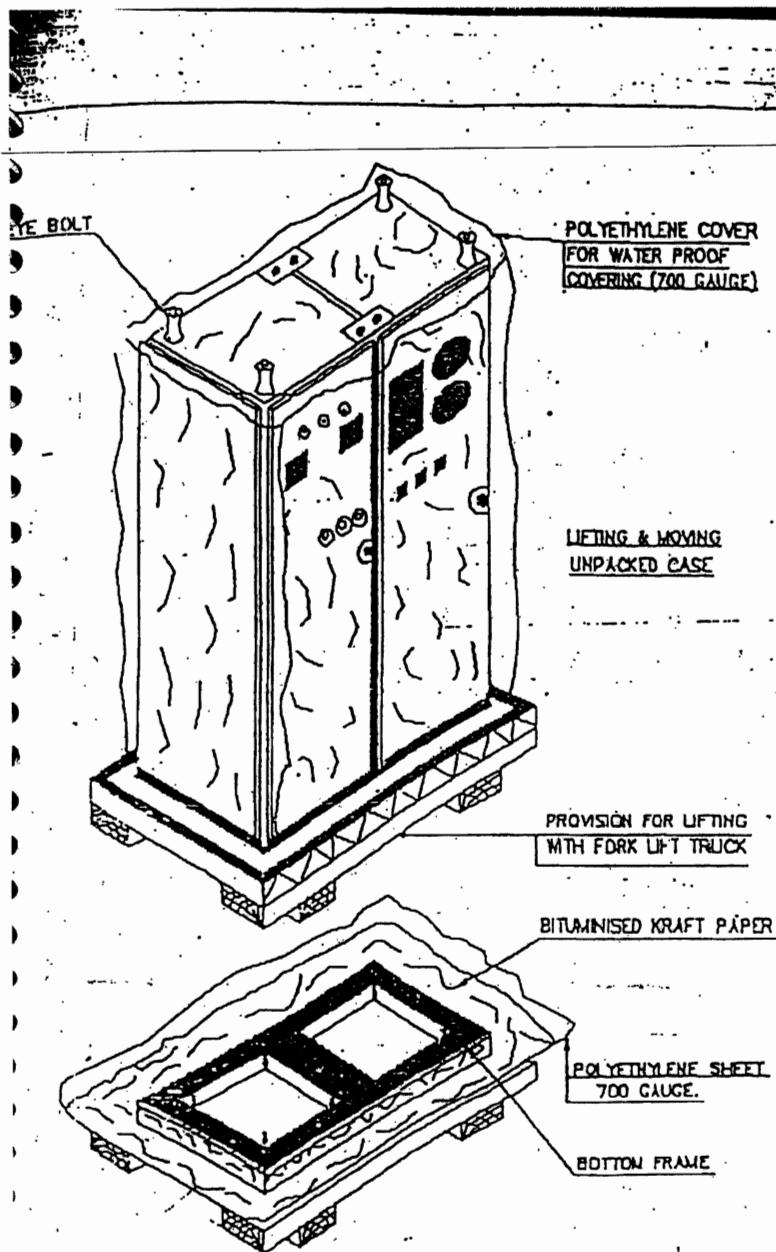

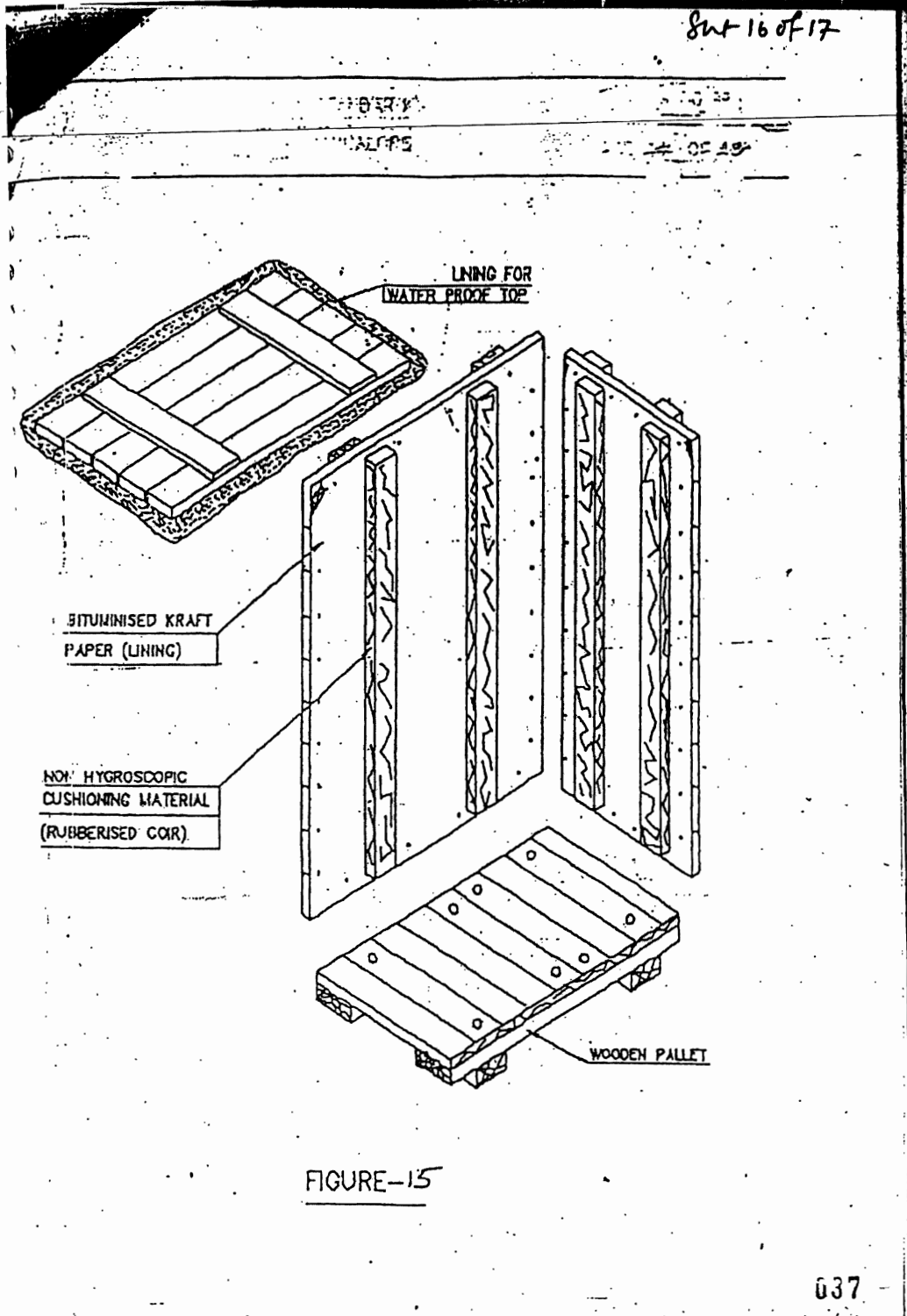



FIGURE-14

036

	TITLE	SPECIFICATION NO. PE-TS-888-100-A001	
	TECHNICAL SPECIFICATION FOR SEAWORTHY PACKING FOR EXPORT JOBS	VOLUME II B	
		SECTION D	
		REV. NO. 0	DATE 10/08/2010
		SHEET 28	OF 52



	TITLE	SPECIFICATION NO. PE-TS-888-100-A001	
	TECHNICAL SPECIFICATION FOR SEAWORTHY PACKING FOR EXPORT JOBS	VOLUME II B	
		SECTION D	
		REV. NO. 0	DATE 10/08/2010
		SHEET 29	OF 52

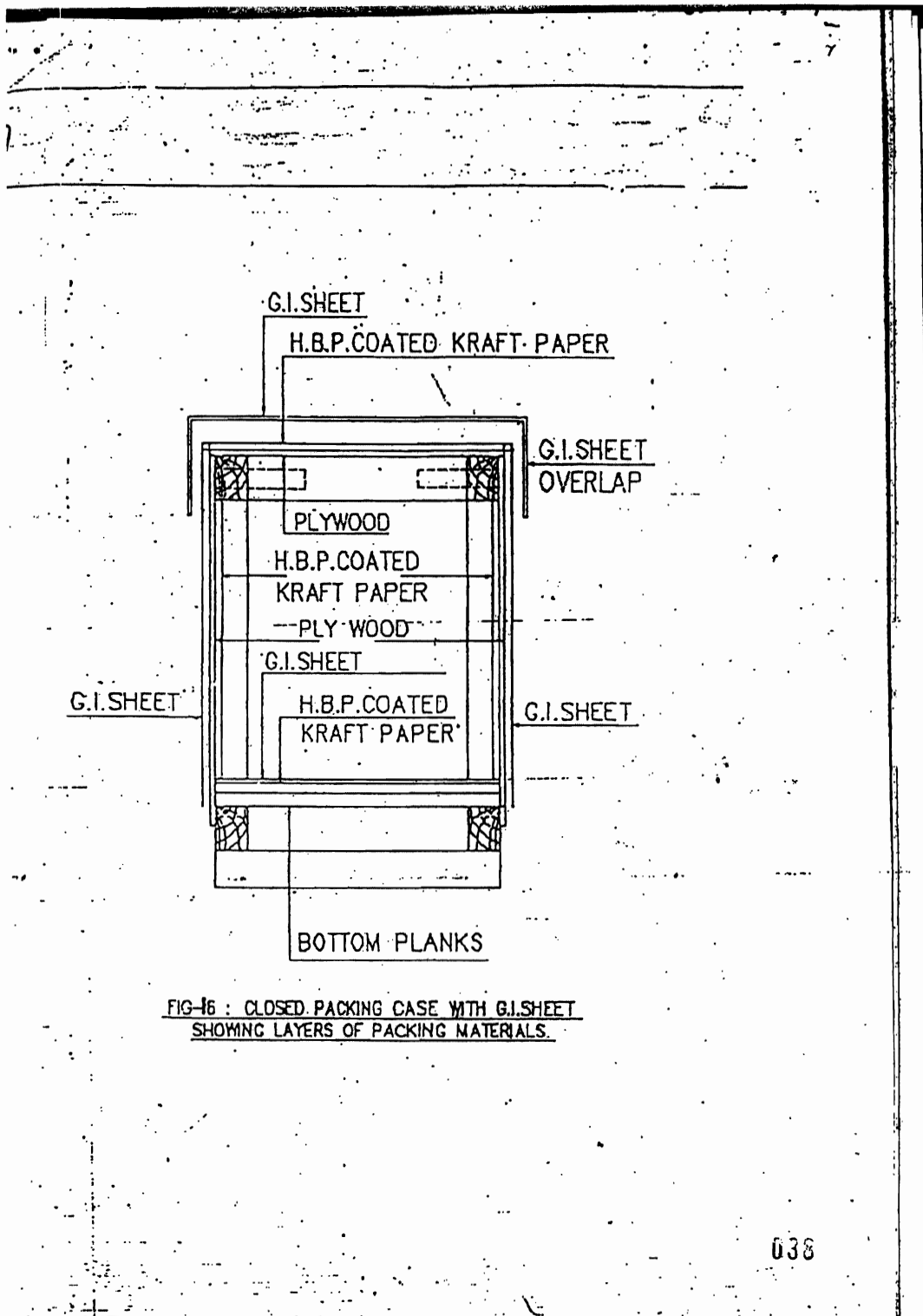



FIG-16 : CLOSED PACKING CASE WITH G.I.SHEET SHOWING LAYERS OF PACKING MATERIALS.

038

	TITLE	SPECIFICATION NO. PE-TS-888-100-A001	
	TECHNICAL SPECIFICATION FOR SEAWORTHY PACKING FOR EXPORT JOBS	VOLUME II B	
		SECTION D	
		REV. NO. 0	DATE 10/08/2010
		SHEET 30	OF 52

10.0 TYPICAL PACKING DETAILS/PROCEDURE FOR MECHANICAL ITEMS

10.1 INSULATION MATERIAL (MINERAL WOOL MATTRESSES)

This specification covers the requirements of seaworthy packing and marking for bonded mineral (rock) wool mattresses having metallic hexagonal wire netting as facing on one or both sides.

10.1.1 TYPE OF CONSTRUCTION

Mattress shall be packed in Polythene (of 0.2 mm thickness) all around and sealed to prevent moisture absorption during transit and storage. Further it shall be wrapped with Bitumen coated Polythene bonded/lined Hessian and stitched and then packed in 5 ply DFC carton box.

Silica gel is used for this purpose to protect contents over sufficiently long time from corrosion. Silica gel shall be of indicating type conforming to IS:304-1979 packed in cotton bags placed at different positions inside the packing for absorbing moisture and shall not come into direct contact with the material inside the package. The quantity of silica gel shall be enough for storage period of one year. However, it shall not be less than 4 gms per litre volume of case subject to minimum of 400 gms per case.

Each mattress as well as the packages shall be serial numbered. Also, printed sheets indicating the nominal thickness, density and wire netting details (i.e. material and size) shall be placed below the wire netting.

Following details shall be legibly written on the packages. The details shall also be typed on a sheet of paper & kept in a sealed Polythene cover, inside the packages

- a) Project Name
- b) Purchase Order No.
- c) Sl. No. of package
- d) Size of mattress (Thickness x Length x Width)
- e) Density
- f) Wire netting material and size
- g) Weight of the package

10.2 INSULATION MATERIAL (ALUMINIUM COIL)

Heavy Gauge Aluminium Coil Packaging are done by Eye-to-Sky packaging or by Eye to eye packaging as per the proven practice being followed by manufacturer of Aluminium sheets.

10.2.1 Type of construction for Eye to Sky packaging

- a. Strapping of coil with polyester strap around circumference at one place.
- b. Putting paper I. D. Edge protector.
- c. Wrapping the coil with VCI stretch film after putting silica gel bags (4 nos.) Inside the coil.
- d. Wrapping the coil with HDPE film.
- e. Covering the coil including its build up & bore with masonite / particle board.
- f. Putting metallic I. D on coil.
- g. Putting O.D edge protector (paper) on coil.

	TITLE	SPECIFICATION NO. PE-TS-888-100-A001		
	TECHNICAL SPECIFICATION FOR SEAWORTHY PACKING FOR EXPORT JOBS	VOLUME II B		
		SECTION D		
		REV. NO. 0	DATE 10/08/2010	
		SHEET 31	OF	52

- h. Putting circumferential polyester strap (3 nos.) & eye polyester strap (4 nos.).
- i. After placing the coil on coil tilter ply wood (10mm thick) of suitable size along with wooden pallet is to be put at the bottom side of the coil.
- j. Coil is to be tilted to eye-to-sky position.
- k. Final strapping with metallic strap to unit coil and skid at 2 places with top cover of plywood.
- l. Fixing the coil with wooden blocks at 4 corners.
- m. Labeling 2 nos.(one metallic & one adhesivetype) For specification, net wt. & gross wt.

10.2.2 Type of construction for Eye to Eye packaging

- a. Strapping of coil with polyester strap around circumference at one place.
 - b. Putting paper I. D. Edge protector.
 - c. Wrapping the coil with VCI stretch film after putting silica gel bags (4 nos.) Inside the coil.
 - d. Wrapping the coil with HDPE film.
 - e. Covering the coil including its build up & bore with masonite / particle board.
 - f. Putting metallic I. D on coil.
 - g. Putting O.D edge protector (paper) on coil.
 - h. Putting circumferential polyester strap (3 nos.) & eye polyester strap (4 nos.).
 - i. Placing of coil on wooden skid Coil is to be tilted to eye-to-sky position.
 - j. Final strapping of coil and skid at 2 places with steel strap. Fixing the coil with wooden blocks at 4 corners.
- Labeling 2 nos.(one metallic & one adhesive type) For specification net wt. & gross wt.

10.3 Packing Procedure for Online Tube Cleaning System and accessories

This procedure is applicable for the shipment of Onload Tube Cleaning System and accessories by sea.

10.3.1 Packing details:

- The Packing case shall be made of treated rubber wood. The design of the case shall be as per Annexure IIIA & IIIB.
- The Equipments shall be placed on the wooden base of the Packing case and fastened if required to arrest the movement of the same.
- Equipment shall be covered by Polythene sheet and inside wall surfaces of the wooden cases also shall be covered by polythene sheet.
- All Nozzles shall be closed with plywood dummies.
- All electrical components assembled or loose shall be covered with polythene sheets along with silica gel pack.
- Silica gel desiccants shall be kept inside each case in sufficient quantities in order to absorb the moisture.

	TITLE TECHNICAL SPECIFICATION FOR SEAWORTHY PACKING FOR EXPORT JOBS	SPECIFICATION NO. PE-TS-888-100-A001	
		VOLUME II B	
		SECTION D	
		REV. NO. 0	DATE 10/08/2010
		SHEET 32	OF 52

- Thermocol packing shall be made for glass items like Ball vessel sight glass, Vpiece sight glass & pressure gauge.
- Silica gel desiccants shall be kept inside of each case to absorb the moisture.
- A Packing list covered in a polythene envelope shall be fixed inside and outside of each packing case.
- Shipping marks and consignee address shall be painted on the outer surface of the case.
- All handling instruction required for the case like top, sling, rain, handle with care etc, shall be marked on the case as per the symbol attached.
- Machined surface will be applied with Anti rust oil and covered by polyurethane sheet to protect from external oxidation.
- All valves will be closed with dummies to protect the internals and placed in the wooden case which will covered by polyurethane sheet.

	TITLE	SPECIFICATION NO. PE-TS-888-100-A001	
	TECHNICAL SPECIFICATION FOR SEAWORTHY PACKING FOR EXPORT JOBS	VOLUME II B	
		SECTION D	
		REV. NO. 0	DATE 10/08/2010
		SHEET 33	OF 52

MODEL : FASTNERS TYPE (BASE, SIDE & TOP ATTACHED WITH BOLT, NUT & WASHER)

This Type of case to be used for following items:
 1. BALL SEPERATOR
 2. BALL COLECTOR SKID

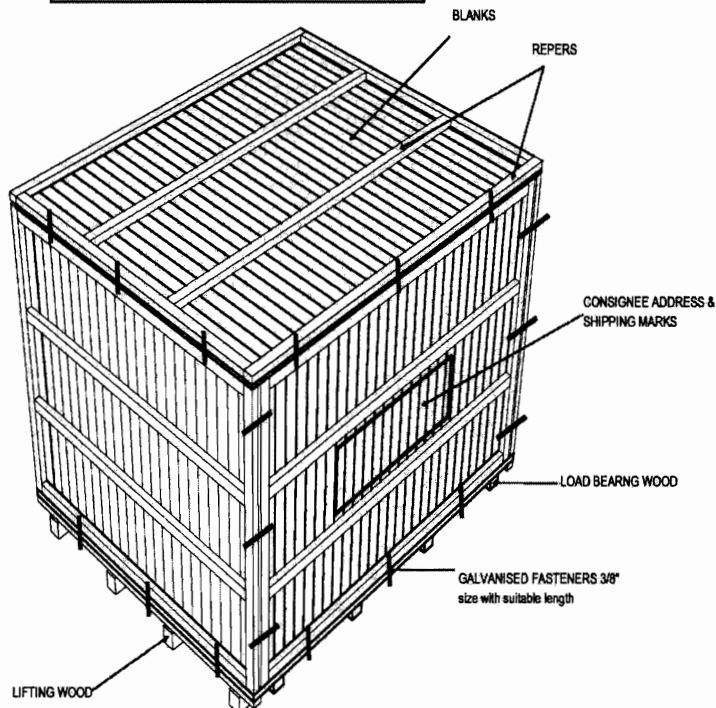

SHEET 05 of 10

	TITLE TECHNICAL SPECIFICATION FOR SEAWORTHY PACKING FOR EXPORT JOBS	SPECIFICATION NO. PE-TS-888-100-A001	
		VOLUME II B	
		SECTION D	
		REV. NO. 0	DATE 10/08/2010
		SHEET 34	OF 52

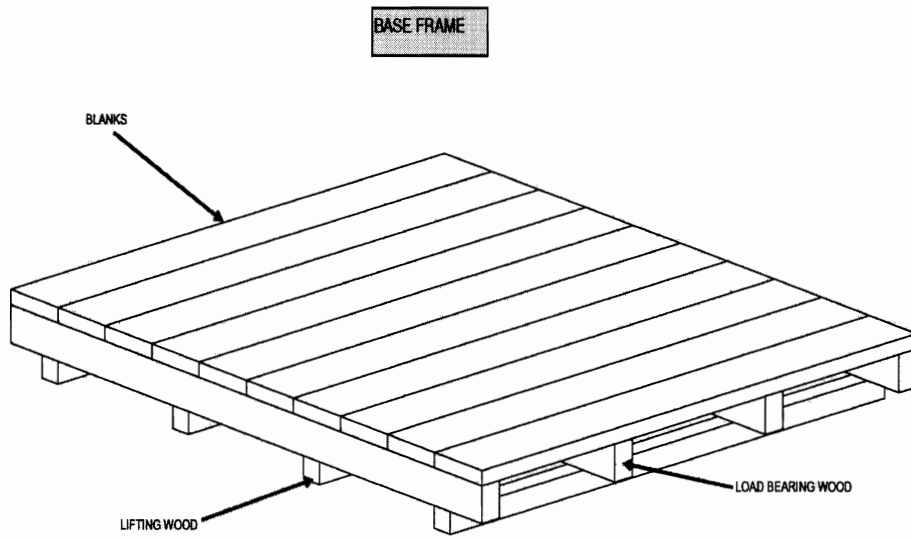

SHEET 06 of 10

	TITLE TECHNICAL SPECIFICATION FOR SEAWORTHY PACKING FOR EXPORT JOBS	SPECIFICATION NO. PE-TS-888-100-A001	
		VOLUME II B	
		SECTION D	
		REV. NO. 0	DATE 10/08/2010
		SHEET 35	OF 52

MODEL: FASTNERS TYPE - WITHOUT TOP

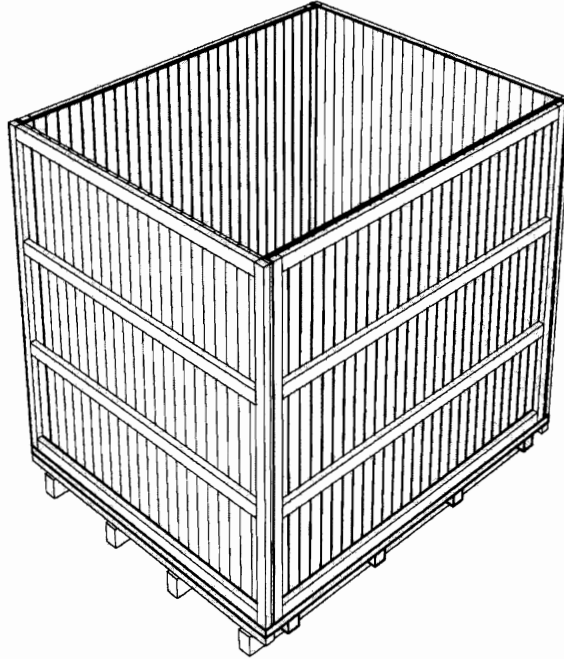

SHEET 07 of 10

	TITLE	SPECIFICATION NO. PE-TS-888-100-A001	
	TECHNICAL SPECIFICATION FOR SEAWORTHY PACKING FOR EXPORT JOBS	VOLUME II B	
		SECTION D	
		REV. NO. 0	DATE 10/08/2010
		SHEET 36	OF 52

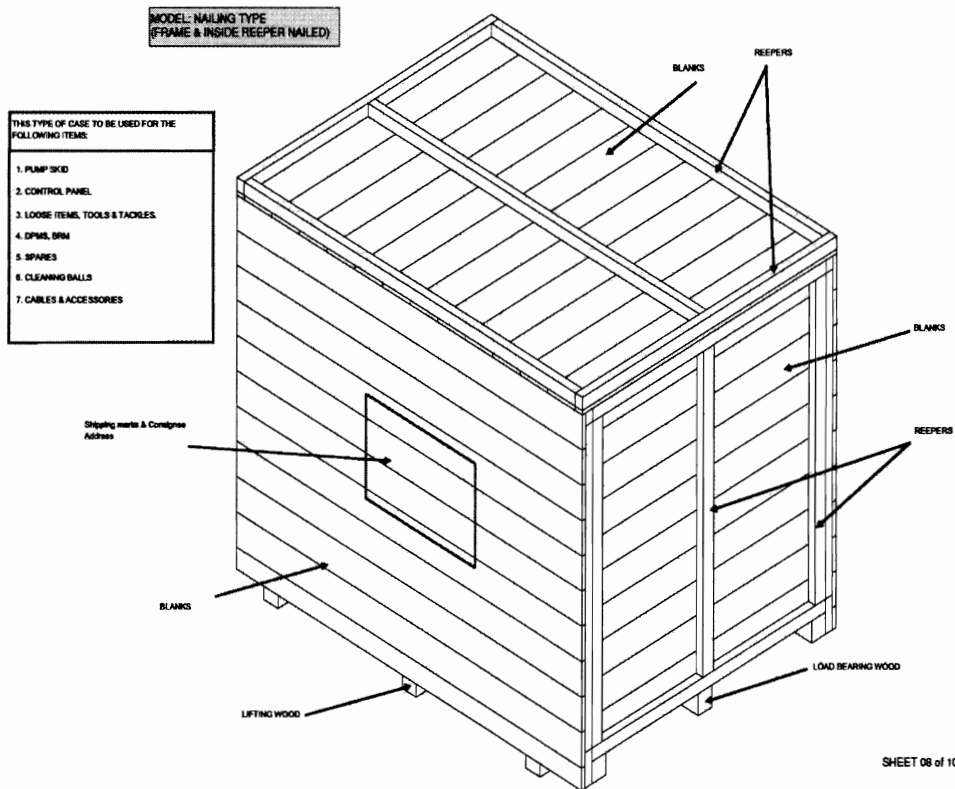

	TITLE	SPECIFICATION NO. PE-TS-888-100-A001		
	TECHNICAL SPECIFICATION FOR SEAWORTHY PACKING FOR EXPORT JOBS	VOLUME II B		
		SECTION D		
		REV. NO. 0	DATE 10/08/2010	
		SHEET 37	OF	52

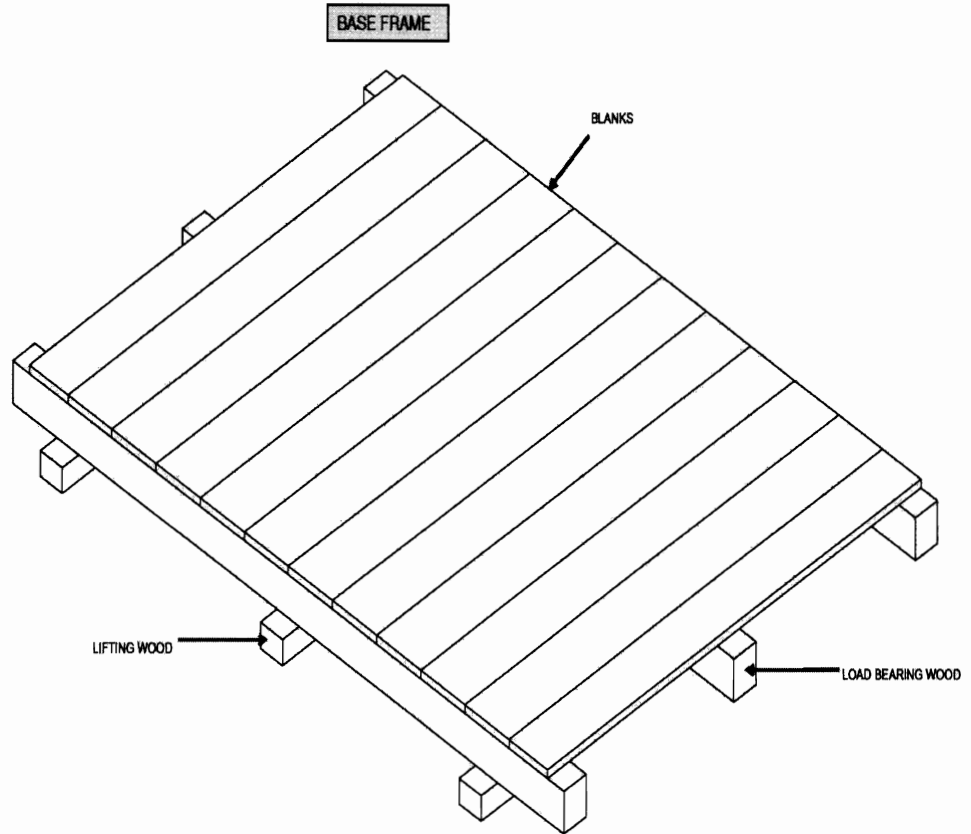

SHEET 09 of 10

	TITLE	SPECIFICATION NO. PE-TS-888-100-A001
	TECHNICAL SPECIFICATION FOR SEAWORTHY PACKING FOR EXPORT JOBS	VOLUME II B
		SECTION D
		REV. NO. 0 DATE 10/08/2010
		SHEET 38 OF 52

NAILING TYPE MODEL WITH TOP OPEN

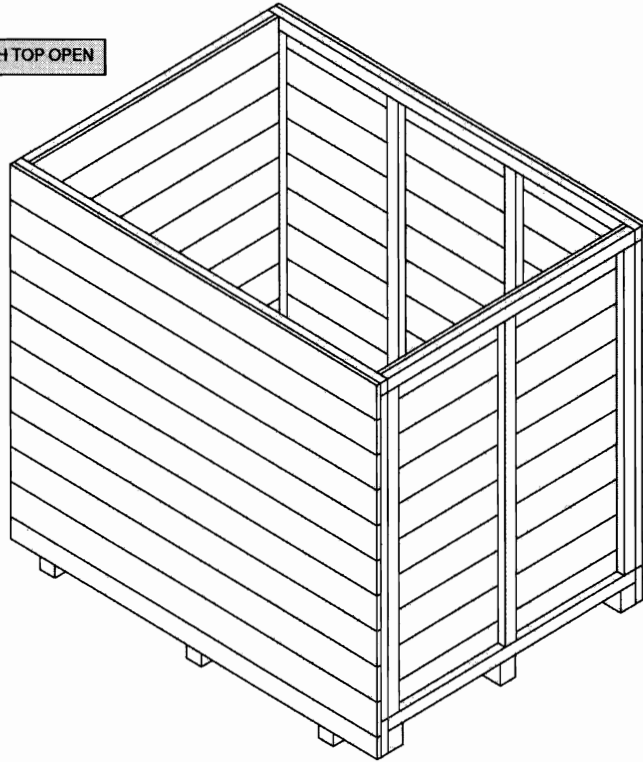

SHEET 10 of 10

	TITLE TECHNICAL SPECIFICATION FOR SEAWORTHY PACKING FOR EXPORT JOBS	SPECIFICATION NO. PE-TS-888-100-A001	
		VOLUME II B	
		SECTION D	
		REV. NO. 0	DATE 10/08/2010
		SHEET 39	OF 52

10.4 PACKING OF LOOSE ITEMS

Loose mechanical, electrical and C&I items e.g. valves, fittings, pressure/temperature gauges/switches, circuit breakers, relays etc shall be individually wrapped using polyethylene sheets/U foam/ thermocol sheets/air bubble sheets depending upon the items and then packed in wooden boxes. The left out spaces and top of the boxes shall be filled with rubberized coir to get proper cushioning effect, Special attention shall be paid to relays, instruments etc for arresting the movements of their operating mechanism during transportation.

The construction of wooden packing cases shall be as per clause 9.3.1 retaining its all features concerning strength of the box. The construction of wooden packing case for electrical and C&I items shall be as per fig-16.

Inner surface of 6 sides of the box shall be lined with bitumen coated hessian polyethylene kraft paper. Rubberized coir of min. 25mm thickness and 100 mm width shall be nailed to inner surfaces of bottom and 4 sides of the boxes.

11.0 PACKING OF ELECTRICAL ITEMS

11.1 CABLES

11.1.1 Type of Equipment

All type of cables..

11.1.2 Type of Construction

New or practically new cable drums made of steel and painted with epoxy resin paint are to be used. Cable ends are carefully protected before packing. Over the cables polyethylene sheet shall be wrapped and then sealed properly. Cable drum can be put in wooden crates for ease in transportation and handling. (Wooden cable drum is also acceptable, however vendor to furnish constructional details for approval).

	TITLE TECHNICAL SPECIFICATION FOR SEAWORTHY PACKING FOR EXPORT JOBS	SPECIFICATION NO. PE-TS-888-100-A001	
		VOLUME II B	
		SECTION D	
		REV. NO. 0	DATE 10/08/2010
		SHEET 40	OF 52

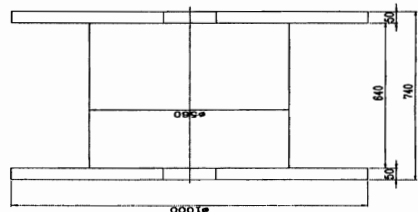
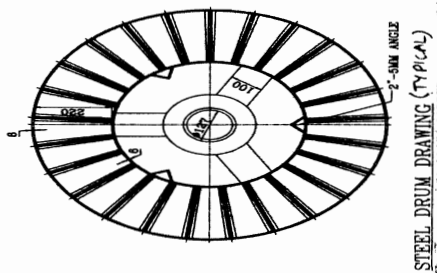

Dimension in mm.

	TITLE	SPECIFICATION NO. PE-TS-888-100-A001	
	TECHNICAL SPECIFICATION FOR SEAWORTHY PACKING FOR EXPORT JOBS	VOLUME II B	
		SECTION D	
		REV. NO. 0	DATE 10/08/2010
		SHEET 41	OF 52

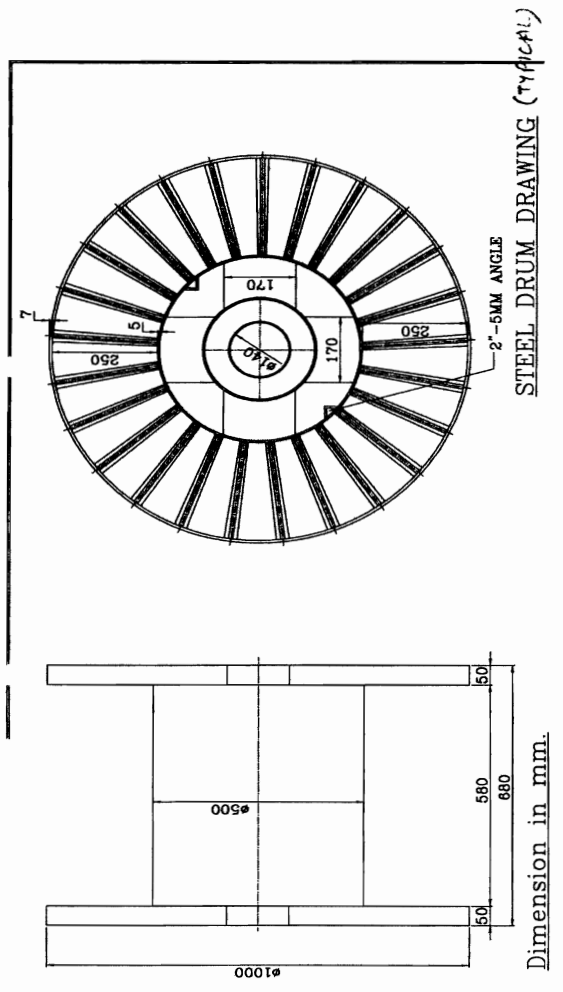

11.2 PACKING OF CABLE TRAYS & ACCESSORIES AND CABLE TRAY SUPPORT MATERIAL

11.2.1 Cable trays can be packed in wooden boxes as per fig 1 to 11 or in steel boxes. Details of steel box construction is as indicated below.

- 1) All Dimensions are in "mm" unless otherwise stated.
- 2) Packing Box shall be fabricated using 50x50x6mm MS Angle, 50x3mm Flat, 2.5 mm thick C Channel, 1mm & 1.6mm Thick sheet.
- 3) Finish of Packing Box Shall be Galvanized.
- 4) Angle & Channel Section forming part of the Main frame shall be welded thoroughly with each other to give a rigid structure.
- 5) Sheet Section and Flat section shall be bolted/ Riveted/ Welded suitably to the Main frame stated in '4' above.

	TITLE	SPECIFICATION NO. PE-TS-888-100-A001	
	TECHNICAL SPECIFICATION FOR SEAWORTHY PACKING FOR EXPORT JOBS	VOLUME II B	
		SECTION D	
		REV. NO. 0	DATE 10/08/2010
		SHEET 42	OF 52

- 6) Welding Portion on galvanized surfaces shall be painted with Zinc Rich Paint.
- 7) Dispatch details such as consignor/consignee address, contract and case details, 'country of origin, port of delivery, stacking instructions shall be written on one of the side of boxes. An anodized aluminium plate as per details and specifications given in page 3 of 5 shall be provided on the boxes
- 8) One copy of packing slip wrapped in polythylene bag covered with suitable aluminium .packing slip holder to be nailed on the external surface of the box. One more copy of the packing Slip wrapped in polythylene bag to be kept inside the box at the prominent place.
- 9) **INDICATION MARKS ON THE BOXES:** Markings shall be provided on the boxes indicating position of Boxes for handling, storage and nature of consignment. For guidelines referred page 4 of 5. The ink issued for this purpose as well as for marking dispatch instruction shall be indelible/non-washable marking ink.
- 10) Each item as mentioned in BOQ shall be packed & supplied as a set comprising of required numbers of associated fasteners & hardware etc

	TITLE	SPECIFICATION NO. PE-TS-888-100-A001	
	TECHNICAL SPECIFICATION FOR SEAWORTHY PACKING FOR EXPORT JOBS	VOLUME II B	
		SECTION D	
		REV. NO. 0	DATE 10/08/2010
		SHEET 43	OF 52

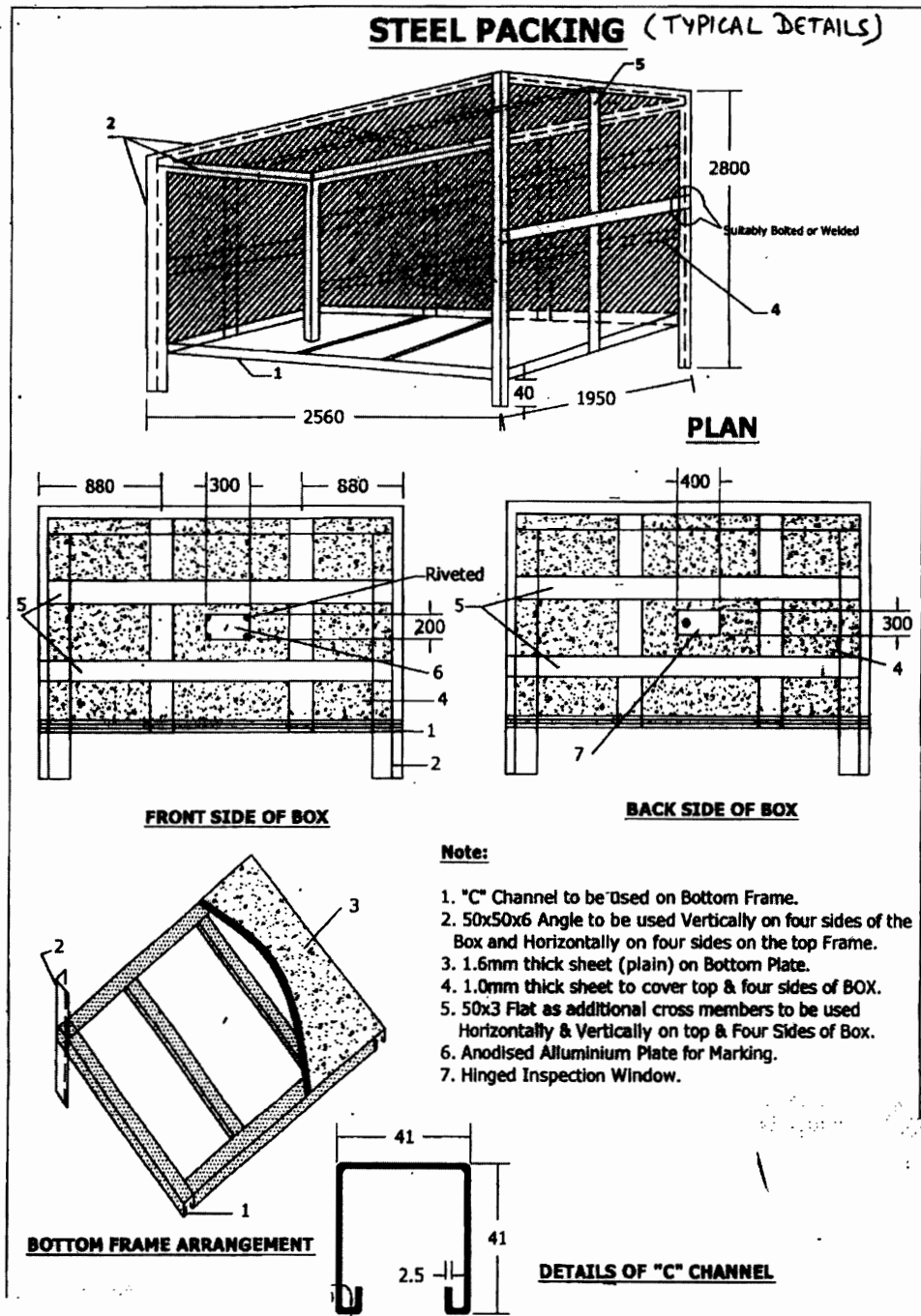

Page 1 of 2

	TITLE	SPECIFICATION NO. PE-TS-888-100-A001	
	TECHNICAL SPECIFICATION FOR SEAWORTHY PACKING FOR EXPORT JOBS	VOLUME II B	
		SECTION D	
		REV. NO. 0	DATE 10/08/2010
		SHEET 44	OF 52

11.3 PACKING FOR STATION LIGHTING SYSTEM

Aspects of packing specific to equipments / items of station lighting system are given here. All other instructions / aspects as per the main specification of export packing which are not covered here shall also be applicable.

11.3.1 For LIGHTING TRANSFORMER, DISTRIBUTION BOARDS, LIGHTING PANELS,

- Construction of packing case for LIGHTING DISTRIBUTION BOARDS, LIGHTING PANELS, TRANSFORMER . shall be EITHER as per FIGURE 1,2,3,5,6,7,8,9,10,11 OR FIGURE 14,15,16.
- Each Panel/Transformer shall be individually covered with double polythene sheet of thickness 175 microns minimum.
- All the 6 inner surfaces of packing shall be nailed with bitumen coated hessian polythene craft paper. Wherever 2 pieces of craft paper are used, the joint shall have minimum overlap of 20mm.

For the top frame it shall be project on all sides by 100mm and shall be nailed on sides .

- The gap between the panels and packing case shall be filled with rubberized coir of thickness 50mm minimum and width 100mm. The distance between two consecutive supports of rubberized coir shall be less than 500mm.
- Silica get packed in cotton bags shall be placed at different positions inside the packing.
- Packing case shall be finally covered with GI sheet of thickness 0.4mm minimum.

11.3.2 For LUMINARIES, RECEPTACLES. EMERGENCY LIGHT, 240/24V TRANSFORMER, CEILING FAN, SWITCH BOARDS, FLEXIBLE CONDUIT, WIRES, EARTH WIRE. JUNCTION BOXES, ERECTION COMMISSIONING SPARES, RECOMMENDED SPARES , ERECTION MATERIAL AND CONSUMABLES

- Construction of packing case for THE ABOVE MATERIAL shall be as per FIGURE 1to11.
- Items placed inside the case shall be covered with double polythene sheet of thickness 175 microns minimum.
- All the 6 inner surfaces of packing shall be nailed with bitumen coated hessian craft paper. wherever 2 pieces of craft paper are used, the joint shall have minimum overlap of 20mm. For the top frame it shall be project on all sides by 100mm and shall be nailed on sides.
- Silica get packed in cotton bags shall be placed at different positions inside the packing.

11.3.3 For CONDUIT PIPE

As per international practice pipes are shipped in open bundles with metal strapping. Packing as per attached figure A shall be provided which is described as following:

- Each bundle shall be wrapped with 2 layers of 175 microns thick polythene sheet.
- Then bundle will be wrapped with bitumen coated hessian craft paper.
- Bundle shall be strapped with steel straps.
- An anodized aluminium packing description plate as per Figure No. 13 shall be provided.

11.3.4 For POLES

Poles will be wrapped with 2 layers of minimum 175 microns thick polythene sheet and then with bitumen coated hessian craft paper, packed as per Figure – C i.e. bundling.

11.3.5 For STRUCTURAL STEEL

	TITLE	SPECIFICATION NO. PE-TS-888-100-A001	
	TECHNICAL SPECIFICATION FOR SEAWORTHY PACKING FOR EXPORT JOBS	VOLUME II B	
		SECTION D	
		REV. NO. 0	DATE 10/08/2010
		SHEET 45	OF 52

Structural steel will be different sizes and shapes. Hence it will be packed as per Figure No. B and described as following :

- a) Each bundle shall be wrapped with 2 layers of 175 microns thick polythene sheet.
- b) Then bundle will be wrapped with bitumen coated hessian craft paper.
- c) Bundle shall be strapped with steel straps.
- d) An anodized aluminium packing description plate as per Figure No. 13 shall be provided.

	TITLE TECHNICAL SPECIFICATION FOR SEAWORTHY PACKING FOR EXPORT JOBS	SPECIFICATION NO. PE-TS-888-100-A001	
		VOLUME II B	
		SECTION D	
		REV. NO. 0	DATE 10/08/2010
		SHEET 46	OF 52

PACKING PROCEDURE FOR CONDUIT PIPE

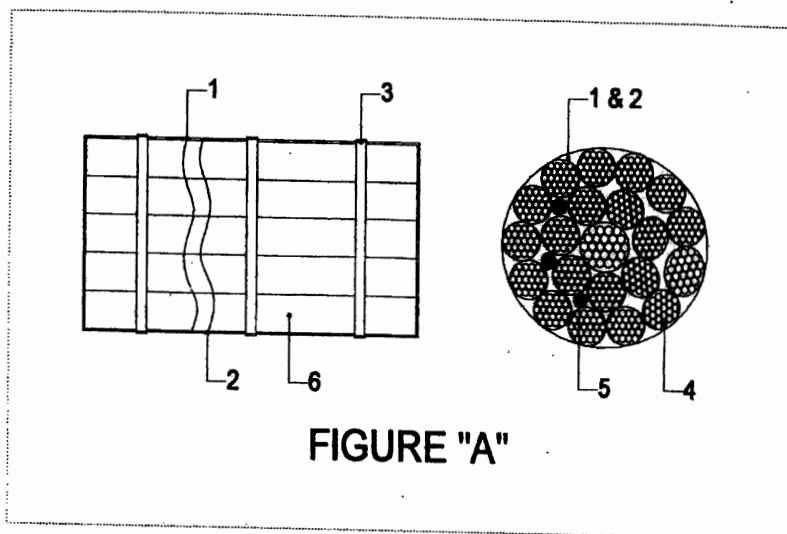



FIGURE "A"

- 1) LAYER OF BITUMEN COATED HESSIAN KRAFT PAPER.
- 2) LAYER OF POLYTHENE SHEET.
- 3) METAL STRAPPING.
- 4) CONDUIT PIPES.
- 5) SILICA GEL POUCHES.
- 6) BUNDLES OF CONDUIT PIPES.

	TITLE TECHNICAL SPECIFICATION FOR SEAWORTHY PACKING FOR EXPORT JOBS	SPECIFICATION NO. PE-TS-888-100-A001	
		VOLUME II B	
		SECTION D	
		REV. NO. 0	DATE 10/08/2010
		SHEET 47	OF 52

PACKING PROCEDURE FOR STRUCTURAL STEEL

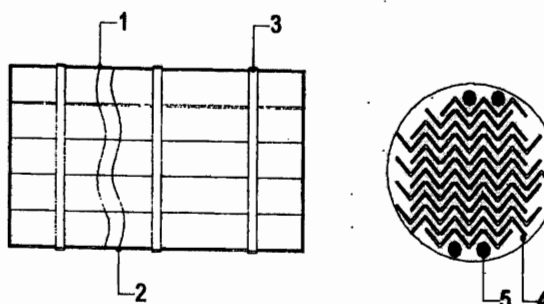

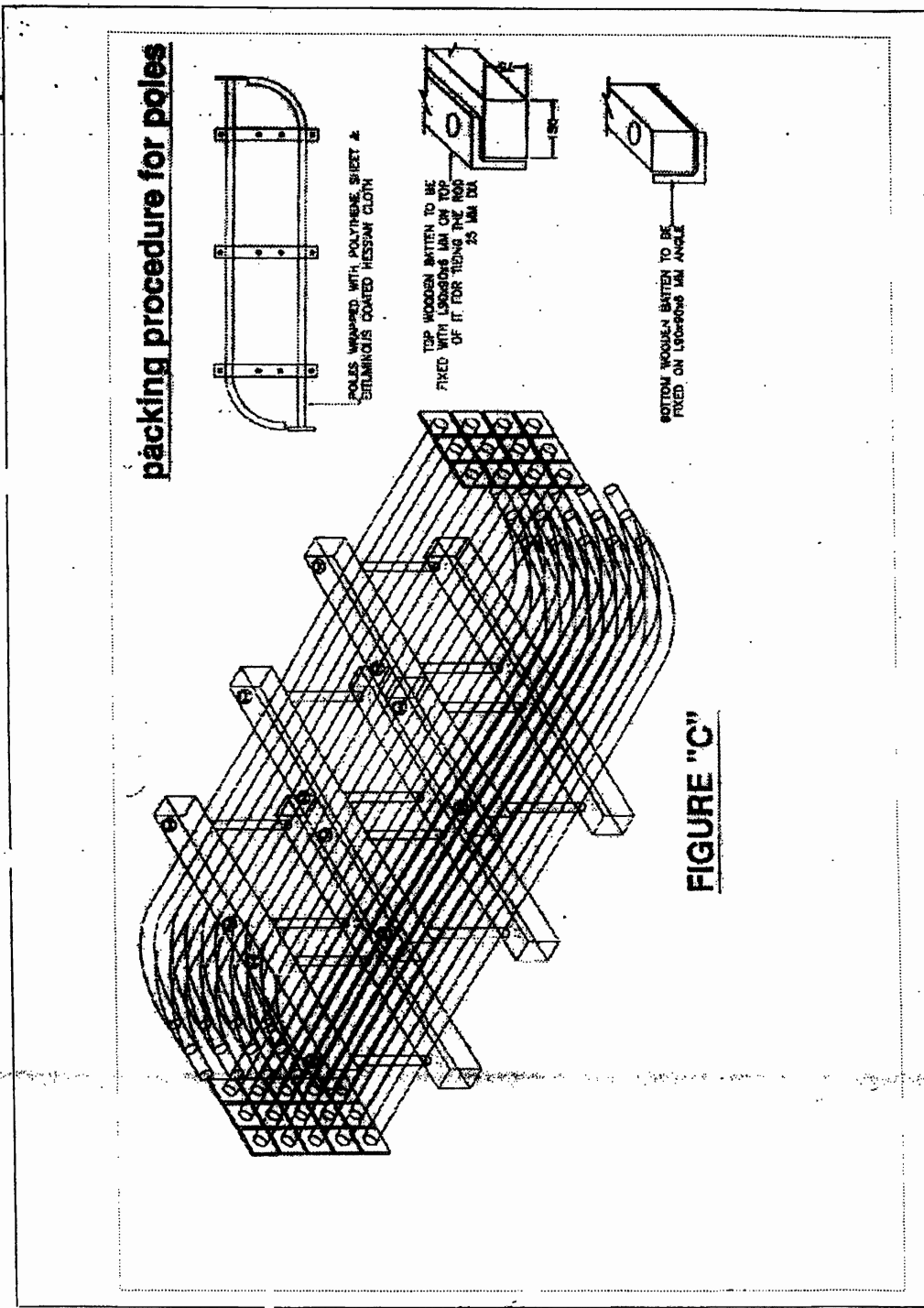



FIGURE "B"

- 1) LAYER OF BITUMEN COATED HESSIAN KRAFT PAPER.
- 2) LAYER OF POLYTHENE SHEET.
- 3) METAL STRAPPING.
- 4) STRUCTURAL STEEL.
- 5) SILICA GEL POUCHES.

	TITLE	SPECIFICATION NO. PE-TS-888-100-A001		
	TECHNICAL SPECIFICATION FOR SEAWORTHY PACKING FOR EXPORT JOBS	VOLUME II B		
		SECTION D		
		REV. NO. 0	DATE 10/08/2010	
		SHEET 48	OF	52



	TITLE	SPECIFICATION NO. PE-TS-888-100-A001	
	TECHNICAL SPECIFICATION FOR SEAWORTHY PACKING FOR EXPORT JOBS	VOLUME II B	
		SECTION D	
		REV. NO. 0	DATE 10/08/2010
		SHEET 49	OF 52

11.4 PACKING FOR DC BATTERY

The packing procedure for seaworthy packing of DC Battery is defined below, which is capable of withstanding impacts, compression, vibration, toppling, sea water spray, prevention against rust, temperature and extreme atmospheric conditions. Aspects of packing specific to equipments / items of DC Battery are given here. All other instructions / aspects as per the main specification of export packing which are not covered here shall also be applicable.

The packing procedure consists of various stages namely primary packing, cushioning, securing, desiccant, outside packing box, Runners/ sliders/ transverse bars of plywood, etc., provided for each movement.

- a) The packing boxes shall be made up of plywood boxes (thickness 9mm min.) with blocks at the bottom of the box for provision for handling the boxes using the forklift. The packing boxes sizes are generally standardized to half-euro size (capable of handling equipment's weight).
- b) Rubberized coir of 25mm thickness shall be provided as cushioning material at the bottom and thermocole of 20mm shall be provided inside on all four sides. Other than this polyethylene film wrap or cover also will be provided. Left out spaces to be filled with rubberized coir/ thermocol to get cushioning effect.
- c) Silica gel in dust free air permeable cotton/paper bag shall be placed in the packing boxes for storage period of 1 year as per IS 304 (1979)
- d) While packing the cells, transit caps (polypropylene) of red and blue shall be used for big size cells for ensuring that cells does not get damaged during the transport due to vibrations etc.
- e) The battery accessories shall be packed with suitable precautions as follows:
 - i) Copper connectors shall be packed after making bunches with lead wire seals to avoid misplacement.
 - ii) Hardware items shall be packed in polyethylene bags (Thickness ≥ 0.175 mm) with item slip
 - iii) Battery rack shall be packed in dismantled condition, wrapped with polyethylene sheet
 - iv) For Ni-Cd type battery, electrolyte in solid form for dry cells shall be packed in cans with KOH, LiOH being packed separately.
 - f) Galvanized Steel straps are provided for binding the packing box sides.
 - g) The handling instructions shall be marked in indelible/ non-washable ink, indicating the upright position.

11.5 PACKING OF SERVICE TRANSFORMERS(OIL FILLED) & ACCESSORIES

This instruction is applicable for packing of transformers (oil filled), its accessories and components so as to ensure safe delivery to end user. Aspects of packing specific to equipments / items of transformers(oil filled) are given here. All other instructions / aspects as per the main specification of export packing which are not covered here shall also be applicable.

11.5.01 PACKING DETAILS :

- a) Items shall be packed in case / crates as per the shipping list.
- b) All fragile items and small items shall be packed in cases and to be marked as "Fragile, handle with care Fragile items".
- c) Fragile accessories are to be first packed in their original boxes (VENDOR's packing). Very

	TITLE	SPECIFICATION NO. PE-TS-888-100-A001	
	TECHNICAL SPECIFICATION FOR SEAWORTHY PACKING FOR EXPORT JOBS	VOLUME II B	
		SECTION D	
		REV. NO. 0	DATE 10/08/2010
		SHEET 50	OF 52

- small / delicate items such as glass thermometer, door keys shall be packed in separate box.
- d In case original box is found damaged, suitable alternate box or packing method using felt or foam sheet and polythene wrap to be used.
- e These boxes are then placed in identified wooden boxes. Inside of such boxes are lined with a layer of polythene sheet, packing wool / grass and another layer of polythene sheet before placing the boxes. All boxes are then wrapped with this polythene sheet before closing the box. Fragile items shall not be placed loose, one above the other inside the case.
- f All wiring cables, connection flats of non-ferrous materials, CTs, valves bellows shall also be packed.
- g Items like CTs, Oil communicating bushings, insulators, wired equipments and housings such as RTCC Panel, M. Box, Drive Mechanism, thermometers, gauges shall be wrapped in polythene from all around.
- h Buchholz relay and OSR relay openings will be blanked using covers, before putting them in the box
- i Items shall be carefully lowered and arranged inside the crate / case and each item shall be locked from all sides in such a way to avoid its movement in any way. Wooden stoppers and separators shall be provided for this and nailed to the crate / case wood.
- j Wooden planks and batons in contact with fragile items shall be provided with kit foam at the locations of contact.
- k Oil communication bushings shall be packed in separate case on V or U shape wooden felted supports, as in case of condenser bushings.
- l While placing and arranging the items inside the crates / cases, these shall be verified for correctness and then the packing note shall be signed. The cover top of the crate / case shall then be closed.
- m The main equipment like transformer tank shall be packed suitably to prevent any damage during transit / storage. Support structures like frame, header supports etc. shall be crated. Conservator headers shall also be crated. Radiators pipe work and other instruments & components shall be packed in cases. All the cases shall be lined with polythene from inside.

11.6 ALTERNATIVE PACKING CASES FOR CONTROL PANELS AND SWITCH GEARS

For Control and switch gear panels, construction of wooden packing cases may be provided as per fig 14 & 15 and as detailed below.

Thickness of planks for all sides, binding and jointing battens shall be at least 25 mm. Width of the plank shall be at least 125mm and that of binding and jointing planks shall be at least 100mm.

Top frame shall be suitable so that it does not collapse due to sandwiching between slings while lifting. Longitudinal and traverse bars for the bottom wooden pallet to be suitably selected.

Diagonal bracings shall be as per cl 9.3.1.3 and all other requirements shall be as per clauses 9.3.1.4 to 9.3.1.6.

12.0 Containerization

As required by BHEL, the VENDOR shall stuff the GOODS into 20 or 40 foot containers (dry, open top, flat racks, etc.).

The maximum inside dimensions of containers are to be considered:

	TITLE	SPECIFICATION NO. PE-TS-888-100-A001	
	TECHNICAL SPECIFICATION FOR SEAWORTHY PACKING FOR EXPORT JOBS	VOLUME II B	
		SECTION D	
		REV. NO. 0	DATE 10/08/2010
		SHEET 51	OF 52

- 40 foot containers: 11.80 m x 2.20 m x 2.05 m
- 20 foot containers: 5.80 m x 2.20 m x 2.05m

The present definition of containerization is valid for sea containers only. Vendor to check the size of containers before start of packing of equipment.

12.1 Protection of Cases/Crates

Since shipping containers are in general not water tight, packing in contact with the floor of the container shall be raised in order to prevent it from being damaged by the accumulation of water.

12.2 Mechanical Constraints

The mechanical constraints for "general use" closed containers are of a different nature (height of "stacking" being limited inside the containers), the packing for the GOODS may be of a lighter structure. However, it is necessary that the packing be appropriate so as to protect the GOODS on site during the storage period, as required after discharging of the GOOD'S from the containers.

Note:

It is the responsibility of the VENDOR to ensure that the cases/crates are stowed, secured and fastened inside the container. The VENDOR will take all necessary precautions to conform to the maximum weight allowed and the centre of gravity of the container. The securing and fastening of the cases/ crates can be carried out by nailing timbers on the bottom or on the vertical sides of the container.

13.0 Other Services to be provided by Vendor

In addition to the packing and shipping documents, VENDOR must also carry out the following services, which shall be included in his quotation:

Carriage of VENDOR's sub-contracted equipment and material, which must be re-grouped in VENDOR's or PACKER's workshops, whilst waiting for packaging.

BHEL reserves the right to postpone the shipping of the GOODS. In this event, any storage and insurance costs during the first ninety (90) days shall be borne by the VENDOR.

Loading, including lifting, securing, lashing, and stowing, of all cases, crates, or packages onto means of transportation such as, but not limited to, trailers, containers, etc.

14.0 Responsibilities and Guarantees

VENDOR is responsible for the choice of category for packing according to the transport facilities used, and on the basis of the present document. In case of doubt or disagreement regarding the choice, VENDOR must inform BHEL prior to packing and await BHEL's approval. All phases of packaging, marking, loading, etc. will be subject to BHEL inspection.

BHEL reserves the right to reject the packing when the packing does not conform to these instructions and/or when the packing does not ensure perfect protection of the GOODS.

VENDOR is responsible for the weights and dimensions declared, and the marking of the packages.

The documents must be in strict conformity with the packing contents.

The packing specified in these "Packing, Marking and Shipping Instructions" is guaranteed for a twelve (12) months storage period after delivery on site.

VENDOR is responsible for providing storage recommendation adapted to the GOODS. According to this guarantee, VENDOR is held responsible in the event of goods becoming

	TITLE	SPECIFICATION NO. PE-TS-888-100-A001	
	TECHNICAL SPECIFICATION FOR SEAWORTHY PACKING FOR EXPORT JOBS	VOLUME II B	
		SECTION D	
		REV. NO. 0	DATE 10/08/2010
SHEET 52 OF 52			

useless, damaged or broken, as a result of poor packing and/or stowing, or due to corrosion, subsequent to insufficient or inadequate protection. All direct or indirect costs resulting thereof, will be back-charged to VENDOR.