



PREQUALIFICATION CRITERIA FOR  
TRAIN SET (SLEEPER) 80 SETS PROJECT

PQC/ PES-TE/BOI-80  
trainsets

Revision No. 00

Page 01 of 01

**1.0 Pre-Qualification Criteria**

1.1 The bidder should be a manufacturer/ regular supplier of the product for Rolling stock application of Railways for 3 phase IGBT based Train sets/RRTS/Semi high speed trains/AC EMU/MEMU in India or any railway systems in the world.

1.2 For supplies made in India, bidder should be approved vendor of Indian Railways /RRTS.

**OR**

For supplies made to any railway systems in the world, bidder shall provide approval, authenticated by country's recognized railway organization. Acceptance of such approvals will be at BHEL's discretion.

1.3 The product should have valid type test certificates complying to relevant latest IEC and other standards mentioned in the Reference Technical Specification for rolling stock application on the date of submission of the tender. The bidder shall fully comply with the type and routine test & inspection clause of the technical specification. The bidder shall conduct/repeat type tests either partially or fully **for the offered product** without any price implication to BHEL. Decision to conduct type test shall be at BHEL's discretion.

**OR**

The bidder shall provide valid type test certificate/reports complying to relevant latest IEC and other standards for similar product supplied as per clause 1.1. Acceptance of such type test certificate/reports will be at BHEL's discretion. In such case, bidder will be considered for technical evaluation. The bidder shall conduct type tests fully **for the offered product**, without any price implication to BHEL.

1.4 Those bidder(s) who are registered with BHEL/ BHEL's customer (as the case may be) shall be considered for technical evaluation, subject to meeting above PQC clauses.

Bidders who are not registered with BHEL/BHEL's customer (as the case may be) can also quote in the tender. However, their credentials will be assessed for consideration in the tender, before price bid opening, subject to meeting above PQC clauses.

**2.0 Documents to be submitted**

All the relevant documents proof for points referred in 1.0 shall be submitted along with the tender.

Rev. 00

Approved: Anjul

Prepared

Rupesh

Checked

David

Date:  
23.01.2024

## ANNEXURE-1

Bharat Heavy Electricals Limited Electronics Division, Mysore Road, Bengaluru

Purchase Specification no - PS4452954

Item - Vacuum Circuit Breaker (VCB) with AC Earth Switch

Vendor name - M/s

## Price Format for Vande Bharat Train Sets

Sl. No.	Material Code	Item Description	Applicability (Yes/No)	Qty [A1]	Unit Rate in INR [A2]	Total Cost [A3=A1*A2]	Total Qty [A4]	Total Cost [A5=A2*A4]	Remarks
<b>1</b>	-	<b>Equipment cost</b>		<b>Per rake</b>	<b>Per item</b>	<b>Per rake</b>	<b>For 32 rakes</b>	<b>For 32 rakes</b>	
1.1	PR2570000027	Basic Price per unit equipment	Yes	8 Set			256 Set		
1.2		Freight & Insurance	Yes				256 Set		
							<b>Total of sl no 1</b>		
<b>2</b>		<b>Maintenance &amp; Spares cost</b>							
2.1		AOH Spare Kit of VCB with consumables for 2 rakes considering 6 years' consumption	Yes	1 Set			16 Set		
2.2		IOH Spare Kit of VCB with consumables for 2 rakes considering 6 years' consumption	Yes	1 Set			16 Set		
2.3		POH Spare Kit of VCB with consumables for 2 rakes considering 6 years' consumption	Yes	1 Set			16 Set		
2.4		Special Tool Kit (One time)	No	X	X	X	X	X	
2.5		AMC for 4 (four) years post warranty period	No	X	X	X	X	X	
2.6		Spares for annual maintenance (for one year)	No	X	X	X	X	X	
							<b>Total of sl no 2</b>		
<b>3</b>		<b>Commissioning &amp; Supervision of Erection</b>							
3.1		Commissioning & Supervision of Erection of Prototype Rake (2 nos)	Yes	1 Rake			2 Rakes		
3.2		Commissioning & Supervision of Erection of All Rakes (Including Prototype)	No	X	X	X	X	X	
							<b>Total of sl no 3</b>		
<b>Note -</b>									
1. Any item required for functional integrity and commissioning of the item/system and not considered above shall be provided by the bidder without any cost implication to BHEL.									
2. Bidder shall quote as per the quantities mentioned in this table only. Quantities mentioned in the specification are for reference purpose.									
3. Tender evaluation shall be done on the total of sl. no. 1, 2 & 3. Purchase Order for Items in sl. no. 2 may be placed separately.									
4. Each rake consists of 16 coaches.									



**BHARAT HEAVY ELECTRICALS LIMITED**  
**ELECTRONICS DIVISION**  
**Mysore Road, Bangalore**

**Doc. No : PS4452954**

**Rev. No : 00**

**Page : 1 of 3**

**CUSTOMER/  
USER**



BHEL/INDIAN RAILWAYS

**PROJECT**

MANUFACTURING CUM MAINTENANCE OF VANDE  
BHARAT TRAINSETS

**COPYRIGHT AND CONFIDENTIALITY**  
 The information on this document is the property of  
 BHARAT HEAVY ELECTRICALS LTD.  
 It must not be used directly or indirectly in anyway detrimental to the  
 interest of the company

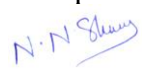
# Purchase Specification for Vacuum Circuit Breaker (VCB) with AC Earth Switch

Rev No.	Date	Altered	Checked	Approved	Revision Details
Issued by: Traction Engg. Dept., BHEL-EDN			Approved Anjul 		
			Prepared  Narasimha Shenoy	Checked  David J	Date 14.12.2023

	<b>Purchase Specification for Vacuum Circuit Breaker (VCB) with AC Earth Switch</b>	<b>Project – Vande Bharat – 80 sets</b>
	Doc. No.: PS4452954	Rev. No. 00

### **1.1 Technical Specification**

1.1.1 For the technical requirement, bidder to refer to PS4452954 - Part A

### **2.1 Bill of Quantities**

2.1.1 Bill of Materials in the technical specification (Part A) is for information only.

Bidder to consider & quote for the items as per the quantity mentioned in the RFQ

### **3.1 Packing Instructions**

3.1.1 Successful bidder to mandatorily follow the packing instructions given in Part A

3.1.2 Stack-ability of the packaged boxes & storage worthiness/durability to be ensured

3.1.3 Successful bidder shall ensure that set-wise Packing List be pasted on each Box

(Typical format enclosed with this document)



Purchase Specification for  
Vacuum Circuit Breaker (VCB) with AC  
Earth Switch

Project – Vande  
Bharat – 80 sets

Doc. No.: PS4452954

Rev. No. 00

**Set wise Packing List to be pasted on each Box**

Supplier shall furnish the packing list as per the format given below:

BHEL PO No.	
BHEL Material Code	
Material Description	
Quantity (Set)	
Box No (per set)	

**Bill of Materials** (Supplier shall list down all the items including loose items and respective quantities):

Main Item:

Sl. No.	Item description	Quantity per Set	Total Sets packed in the Box (applicable in case of multiple sets in one Box)

Loose Items (if any):

Sl. No.	Item description	Quantity per Set	Total Sets packed in the Box (applicable in case of multiple sets in one Box)

Supplier details:

**Notes for suppliers:**

- 1) Suppliers shall pack items, set wise in one box. In case of multiple boxes for one set, supplier shall identify box numbers (Set 1/ Box1, Set 1/ Box2 etc.)
- 2) Packing list shall be pasted on each box, as per actual contents inside the box. This list will be in addition to the supplier's standard packing list.
- 3) Box wise Packing list shall be shared with BHEL MM and same will be mandatory for dispatch clearance.



**BHARAT HEAVY ELECTRICALS LIMITED**  
**ELECTRONICS DIVISION**  
 Mysore Road, Bangalore

DOC. NO: PS4452954-part A

REV. NO: 00

Page 1 of 36



**COPYRIGHT AND CONFIDENTIALITY**  
 The information on this document is the property of  
**BHARAT HEAVY ELECTRICALS LTD.**  
 It must not be used directly or indirectly in anyway detrimental to the interest of the company

<b>CUSTOMER/ USER</b>	<b>BHEL/INDIAN RAILWAYS</b>
<b>PROJECT</b>	<b>Manufacturing cum Maintenance of Vande Bharat Trainsets</b>

# TECHNICAL SPECIFICATION

## Vacuum Circuit Breaker (VCB) with AC Earth Switch

Rev No.	Date	Altered	Checked	Approved	Revision Details

Issued by: Traction Engg. Dept., BHEL-EDN	<b>APPROVED</b>  S P Singh		
	<b>PREPARED</b>  Shankar Narayanan	<b>CHECKED</b>  Prafful K Lakra	<b>DATE</b>  08.12.2023

	<b>TECHNICAL SPECIFICATION FOR Vacuum Circuit Breaker with AC Earth Switch</b>	<b>PROJECT- ICF Trainsets</b>
	<b>DOC. No.: PS4452954, PART-A, REV No. 00</b>	

## Table of Contents:

SECTION – 1.....	4
SCOPE, QUANTITIES & ELIGIBILITY.....	4
1.1 SCOPE .....	4
1.2 BILL OF MATERIAL: .....	4
1.3 ELIGIBILITY CRITERIA.....	5
1.4 CLAUSE BY CLAUSE COMPLIANCE .....	5
1.5 REFERENCE SPECIFICATIONS .....	5
SECTION – 2.....	6
TECHNICAL SPECIFICATION .....	6
2.1 TECHNICAL SPECIFICATION OF VCB.....	6
2.2 CONSTRUCTIONAL DETAILS OF VCB .....	6
2.3 TECHNICAL DETAILS OF VCB:.....	7
2.4 TECHNICAL SPECIFICATION OF AC EARTH SWITCH FOR VCB .....	8
2.5 TECHNICAL DETAILS OF AC EARTHING SWITCH FOR VCB .....	9
2.6 EQUIPMENT TESTING .....	10
2.7 DESIGN REQUIREMENTS TO BE PROVIDED BY SUPPLIER .....	10
SECTION – 3.....	12
PROJECT DETAILS AND GENERAL SPECIFICATIONS.....	12
3.1 GENERAL.....	12
3.2 INSTRUCTION TO BIDDERS .....	12
3.3 GENERAL DESIGN REQUIREMENTS.....	12
3.4 INGRESS PROTECTION .....	15
3.5 AMBIENT CONDITIONS / OPERATING CONDITIONS.....	16
3.6 STANDARDS .....	17
3.7 ENGINEERING DATA .....	18
3.8 MARKING OF EQUIPMENT & RATING PLATE.....	19
3.9 INFRINGEMENT OF PATENT RIGHTS.....	19
3.10 DOCUMENT SUBMISSIONS.....	20
3.11 QUALITY ASSURANCE PROGRAMME.....	20
3.12 QUALITY ASSURANCE DOCUMENTS.....	21
3.13 TYPE AND ROUTINE TESTING & INSPECTION .....	21
3.14 MATERIALS AND WORKMANSHIP .....	23
3.15 PACKING, STORAGE AND HANDLING INSTRUCTIONS .....	23
3.16 FIRE PREVENTION .....	23
SECTION – 4.....	25
RELIABILITY, AVAILABILITY, MAINTAINABILITY AND SAFETY (RAMS).....	25



**TECHNICAL SPECIFICATION FOR  
Vacuum Circuit Breaker with AC Earth  
Switch**

**PROJECT- ICF  
Trainsets**

**DOC. No.: PS4452954, PART-A, REV No. 00**

4.1	KEY PERFORMANCE INDICATORS .....	25
4.2	RELIABILITY AVAILABILITY MAINTAINABILITY AND SAFETY (RAMS).....	25
4.3	RAMS DOCUMENTATION .....	26
4.4	SERVICE LIFE OF EQUIPMENT/SYSTEM.....	26
4.5	TRAIN MAINTENANCE SCHEDULE (TENTATIVE) .....	28
SECTION -5 .....		29
SPARES AND CONSUMABLES FOR MAINTENANCE.....		29
5.1	SPARES AND CONSUMABLES.....	29
5.2	SCHEDULED MAINTENANCE .....	29
5.3	UNSCHEDULED MAINTENANCE .....	30
5.4	EPIDEMIC DEFECT WARRANTY .....	30
5.5	OPERATION AND MAINTENANCE MANUAL .....	30
5.6	OBSOLESCENCE MANAGEMENT.....	32
5.7	TRAINING ON MAINTENANCE ASPECTS.....	32
ANNEXURE-1 .....		33
PERFORMA FOR PERFORMANCE CERTIFICATE.....		34
PERFORMA FOR PERFORMANCE STATEMENT .....		35
REVISION HISTORY .....		36

	<b>TECHNICAL SPECIFICATION FOR Vacuum Circuit Breaker with AC Earth Switch</b>	<b>PROJECT- ICF Trainsets</b>
	<b>DOC. No.: PS4452954, PART-A, REV No. 00</b>	

## SECTION – 1

### SCOPE, QUANTITIES & ELIGIBILITY

#### 1.1 SCOPE

This technical specification covers the requirements of design, manufacture, testing at works, packing and dispatch of Vacuum Circuit Breaker (VCB) with AC Earth Switch.

The equipment is required for the following project.

**Name of the customer:** BHEL/INDIAN RAILWAYS

**Name of the Project:** Manufacturing cum Maintenance of Vande Bharat Trainsets

The scope shall also include the followings:

The supply of complete documentation for approval of design, relevant drawings and calculations to the satisfaction of purchaser and RDSO and support documentation associated with the operation and maintenance of the equipment supplied.

The supplier shall submit list of equipment and facilities required for maintenance and overhaul of equipment offered.

#### 1.2 BILL OF MATERIAL:

Sl. No.	Description	Quantity (per 16 car Train)	Remarks
1.	Vacuum Circuit Breaker	8 No.	
2.	AC Earth Switch compatible with VCB along with Key	8 No.	All mounting hardware shall be Stainless steel.
3.	Adapter/Mounting Plate of VCB and Earth Switch	8 No.	Mounting details to be finalized during design stage in consultation with ICF/RDSO/Indian Railways.
4.	Other Accessories Required For Mounting and Electrical / pneumatic Connections of VCB and Earth Switch	As reqd.	
5.	Suitable Control connector for Auxiliary contacts and power supply (Male & Female Connectors of same make )	As reqd.	



**TECHNICAL SPECIFICATION FOR  
Vacuum Circuit Breaker with AC Earth  
Switch**

**PROJECT- ICF  
Trainsets**

**DOC. No.: PS4452954, PART-A, REV No. 00**

### **1.3 ELIGIBILITY CRITERIA**

The Bidder should be a regular supplier to Indian Railway Projects and should have supplied the offered equipment for Indian Railways projects of 3 phase IGBT Based AC EMU/MEMU/ Metros/Trainsets/Locomotives operating in India.

### **1.4 CLAUSE BY CLAUSE COMPLIANCE**

Vendor to submit clause by clause compliance to complete technical specification along with the technical bid.

### **1.5 REFERENCE SPECIFICATIONS**

This purchase specification has the reference of Railway Specification No. ICF MD SPEC-398 Rev-01 dated: 05/11/2022.

CONFIDENTIAL



# TECHNICAL SPECIFICATION FOR Vacuum Circuit Breaker with AC Earth Switch

PROJECT- ICF  
Trainsets

DOC. No.: PS4452954, PART-A, REV No. 00

## SECTION – 2 TECHNICAL SPECIFICATION

### 2.1 TECHNICAL SPECIFICATION OF VCB

- (a) The Vacuum Circuit Breaker to be supplied should be according to CLW specification no. CLW/ES/C-47/I of latest, in general. IEC-60077-4 shall be the governing standard for this type test requirements.
- (b) The Vacuum Circuit Breaker is a single bottle 25KV AC circuit -breaker equipped with a vacuum interrupter and mounted on the roof of the EMU/MEMU/Trainset/Loco. The vacuum circuit breaker is used as a line circuit breaker to close and open the power circuit of the vehicle from the overhead catenary and to interrupt the power circuit current under overload, short circuit conditions or any other abnormal working conditions defined and implemented to the application.
- (c) Design and manufacturing of VCB shall be in accordance with EN45545. The applicable Hazard level will be HL 3.
- (d) Mounting arrangement: As per Annexure-1

### 2.2 CONSTRUCTIONAL DETAILS OF VCB

#### a) VACUUM INTERRUPTER / VACUUM SWITCH TUBE

The vacuum interrupter shall comprise:

- (1) One vacuum bottle containing:
  - a. Fixed contact (FC)
  - b. Moving contact (MC)
- (2) Ceramic insulator as a protecting housing.

#### b) CLOSING DEVICE (ELECTRO-PNEUMATIC)

At the time of start, when EP valve shall be energized, controlled air supplied to the operating cylinder shall initiate movement of main mechanism and thereby control the initial speed of the mechanism travel.

#### c) HOLDING DEVICE (ELECTRO-PNEUMATIC)

The pneumatic cylinder shall be equipped with an electro-pneumatic valve and the moving part is the piston.

The contacts are held in closed position by air pressure, which is maintained by EP valve.



# TECHNICAL SPECIFICATION FOR Vacuum Circuit Breaker with AC Earth Switch

PROJECT- ICF  
Trainsets

DOC. No.: PS4452954, PART-A, REV No. 00

There are set of compression springs to store energy during closing operation, which is used while opening the circuit breaker.

#### d) OPENING CONTROL:

The opening of the VCB shall occur by interruption of the EP coil current thereby closing of compressed air supply and opening through stored energy of the springs.

#### e) AUXILIARY CONTACTS:

Auxiliary contacts/switch shall consist of fish bone type auxiliary switch, in which 4NO and 4NC contacts are available to the user.

These are operated through the cam drive linked with the main operating rod. The NO contact can be changed to NC and vice versa.

The Auxiliary switch shall be of fishbone type similar to DBTF type breaker, which is being currently used in these VCBs and approved by RDSO.

### 2.3 TECHNICAL DETAILS OF VCB:

The technical data of VCB shall be as follows:

S.No.	Parameter	Value
1.	Nominal supply voltage	25 KV (rms), 50 Hz, single phase AC
2.	Variation in voltage	19 KV to 27.5KV
3.	Occasional Min voltage	17 KV
4.	Occasional Max voltage	30 KV
5.	Normal variation in frequency	+/-3% (48.5 to 51.5 Hz)
6.	Rated operational current	1000 A rms
7.	Rated short circuit breaking current	16 kA rms (400 MVA)
8.	Rated short circuit making current	40 kA peak
9.	Rated impulse withstand voltage	175 KV peak
10.	Rupturing capacity at 25kV	400 MVA
11.	Rated power frequency withstand voltage	75 KV rms
12.	Rated duration of Short circuit current of 16kA (as per IEC-60077-4)	3 Sec.
13.	Total break time (Opening time)	<=60 ms
14.	Rated operating sequence	O-3 min-CO-3 min-CO
15.	Closing Time	<=145 ms
16.	Approximate weight	150 Kg (Max)
17.	Type of Bottle	Single Interrupter
18.	Control supply voltage	110 V DC (77 Vdc to 137.5 Vdc)
19.	Inlet air pressure to control circuit	5 to 11 kg/cm <sup>2</sup>



# TECHNICAL SPECIFICATION FOR Vacuum Circuit Breaker with AC Earth Switch

**PROJECT- ICF  
Trainsets**

**DOC. No.: PS4452954, PART-A, REV No. 00**

20.	Auxiliary contacts	Fish bone type (4 NO+4 NC)
21.	Creepage Distance	Adequate as per standard
22.	Compatibility with AC Earth switch	VCB offered by supplier should be compatible & mechanically matching for direct coupling with RDSO approved standard AC Earth switch
23.	Overall dimension(approximate)	Overall dimension of VCB shall be tentatively as shown in Annexure-1
22.	Mounting position and cut out dimension	The tentative mounting position and cut out dimension shall be as per Annexure-1
23.	Control Electrical connectors	Side entry shall be provided
24.	Pneumatic Connection	Side entry shall be provided
25.	Maximum permissible depth inside the coach from Mounting plate of VCB	180 mm

Besides above data/information, the vendor shall furnish the following data:

- Make and type, rated voltage and current, the maximum permissible operating voltage, rated short time current, total fault clearing time, making and breaking capacity, impulse with stand voltage, control circuit voltage, number and rating of auxiliary contacts, overall dimensions and weight of the equipment. Approved Bill of Material from RDSO/IR.
- Complete details of electronic control units in VCB, if used, along with circuit diagram, its parameters and other relevant details.
- Internal circuit diagram of VCB components.
- Detailed mounting arrangement drawing.
- Wiring diagram.
- Any other technical & performance details required by customer (BHEL/ RDSO/ICF/IR) regarding the equipment needs to be furnished. The mounting and fitment of VCB shall be finalized as per RDSO/ICF/IR requirements.

## 2.4 TECHNICAL SPECIFICATION OF AC EARTH SWITCH FOR VCB

- The AC Earth Switch, shall comply with CLW specification no. CLW/ES/3/0010, Alt D or latest and relevant IECs/other applicable standards.
- Design and manufacturing of AC Earth switch shall be in accordance with EN45545. The applicable Hazard level will be HL 3.
- The AC Earth Switch (ES) is a manual operated device with safety interlocking Keys, designed to ground electrical circuits on both sides of the vacuum circuit breaker. The earthing shall be achieved through two knives connecting together the traction and earth circuits once the vacuum circuit breaker is open. The AC earth switch shall be of proven



# TECHNICAL SPECIFICATION FOR Vacuum Circuit Breaker with AC Earth Switch

PROJECT- ICF  
Trainsets

DOC. No.: PS4452954, PART-A, REV No. 00

design suitable for transportation application in Indian environmental conditions as attached in Section 3.5 of this specification.

4. Out of 08 nos. AC Earth Switch 04 nos. are required with Key arrangement as 3keys (1 Blue +2 Yellow) considered as AC Earth Switch 1 and other 04 nos. key arrangement as 3keys (1 Yellow + 2 Green) considered as AC Earth Switch 2.
5. Keys shall be provided along with AC Earth Switch.

## Connection diagram

The connection diagram for each AC Earth switch shall be as follows:

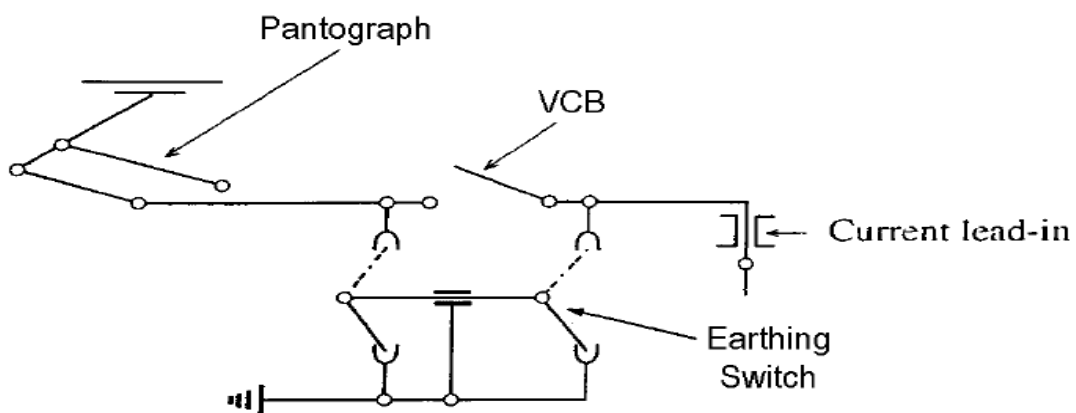

## 2.5 TECHNICAL DETAILS OF AC EARTHING SWITCH FOR VCB

Nominal voltage	25 kV
Highest short time operational voltage	30 kV
Rated Current	400 A
Poles	2
Weight	≤ 27kg
Place of mounting	Roof near the VCB
Short time withstand current	16 kA rms for 3sec
Peak withstand current	40kA
Key and lock configuration	3keys (1 Blue +2 Yellow) for AC Earthing Switch 1 and 3keys (1 Yellow +2 Green) for AC Earthing Switch 2

- a) Mounting of AC Earth Switch for VCB shall be finalized with RCF/RDSO/IR.
- b) The orientation of operating handle (Left or Right side) shall be finalized as per requirement of user Railways.
- c) Locking keys, size and make, should be compatible with Panto isolating cock and DC Earth Switch. The locking key design shall be finalized in conjunction with locking arrangement of Panto isolating cock and DC Earth switch, which will be supplied by different suppliers.

	<b>TECHNICAL SPECIFICATION FOR Vacuum Circuit Breaker with AC Earth Switch</b>	<b>PROJECT- ICF Trainsets</b>
	<b>DOC. No.: PS4452954, PART-A, REV No. 00</b>	

## 2.6 EQUIPMENT TESTING

- (a) Valid Type test report is to be submitted for the equipment along with offer, if the equipment is already type tested. In case, ultimate customer insists to repeat the type tests due to any reason, the supplier shall conduct the type test again, for which test procedure shall also be submitted by the supplier for approval before conducting the type test. In case ultimate customer desires to witness the type tests, the supplier shall have no objection. The supplier is required to quote for the type test charges if any, separately in commercial offer. These charges will be loaded in the equipment price at the time of final evaluation. If Type Test charges are not quoted separately in the commercial offer, then it will be presumed that offer is inclusive of type test charges and no extra payment will be done in case of type test conducted due to any reason.
- (b) Supplier to submit Routine test certificates and inspection certificate of equipment as per QAP along with equipment.
- (c) Type and routine test will also confirm to clause 3.13 of section 3 of technical specification.

## 2.7 DESIGN REQUIREMENTS TO BE PROVIDED BY SUPPLIER

<ul style="list-style-type: none"> <li>• Write-up/ description of each equipment</li> </ul>	To be provided by Supplier
<ul style="list-style-type: none"> <li>• Datasheet of equipment</li> </ul>	To be provided by Supplier.
<ul style="list-style-type: none"> <li>• Circuit diagram, connection &amp; wiring diagram, equipment drawing with mounting details, weights, center of gravity, etc. and any other relevant drawings</li> </ul>	To be provided by Supplier
<ul style="list-style-type: none"> <li>• Type test protocol &amp; procedure/ Type test reports</li> </ul>	Supplier to submit the complete reports of type test already conducted on the proposed/offered equipment. In case, type test is required to be done, supplier to submit the detailed test procedures for approval.
<ul style="list-style-type: none"> <li>• Routine test protocol &amp; procedure/ Routine test reports</li> </ul>	Supplier to submit Routine test Certificates and inspection certificate of equipment as per QAP along with equipment.
<ul style="list-style-type: none"> <li>• Details of proven design</li> </ul>	To be provided by Supplier
<ul style="list-style-type: none"> <li>• Performance statement</li> </ul>	To be provided by Supplier in the attached format.
<ul style="list-style-type: none"> <li>• Performance certificate</li> </ul>	To be provided by Supplier in the attached format.
<ul style="list-style-type: none"> <li>• RDSO Approval letter (conforming to the</li> </ul>	To be provided by Supplier



**TECHNICAL SPECIFICATION FOR  
Vacuum Circuit Breaker with AC Earth  
Switch**

**PROJECT- ICF  
Trainsets**

**DOC. No.: PS4452954, PART-A, REV No. 00**

latest RDSO spec as applicable)	
• Project specific AUTO CAD drawing-2D and 3D model	To be provided by Supplier after order placement
• Project Specific Drawings in A3 size	To be provided by Supplier
• Technical Manual	To be provided by Supplier
• Installation, Operational and Maintenance Manual	To be provided by Supplier
• MTBF/MDBF Values along with the method of calculation	To be provided by supplier
• Quality assurance plan (QAP)	To be provided by supplier

CONFIDENTIAL

	<b>TECHNICAL SPECIFICATION FOR Vacuum Circuit Breaker with AC Earth Switch</b>	<b>PROJECT- ICF Trainsets</b>
	<b>DOC. No.: PS4452954, PART-A, REV No. 00</b>	

## SECTION – 3

### PROJECT DETAILS AND GENERAL SPECIFICATIONS

#### 3.1 GENERAL

This section stipulates the General Technical Requirements under the contract and forms an integral part of the Technical Specification. The provisions under this section are intended to supplement general requirements for the materials, equipment and services covered under other sections and are not exclusive.

However, in case of conflict between the requirements specified in this section and requirements specified under other sections, the requirements specified under respective sections shall hold good.

The Train shall be Distributed Power type which shall have Driving Cabs on its both ends and shall be capable of running in either direction without the requirement for any change in its composition. Configuration of 16-car rake shall be two End Basic Units and two Middle Basic Units.

The configuration of Vande Bharat express (Trainsets) is as under (for reference):

DTC-MC-TC-MC-MC-TC-MC-NDTC-NDTC-MC-TC-MC-MC-TC-MC-DTC

Where,

DTC: Driving Trailer Coach

MC: Motor Coach

NDTC: Non-Driving Trailer Coach

TC: Trailer Coach

#### 3.2 INSTRUCTION TO BIDDERS

The bidders shall submit the technical requirements, data and information as per the technical specification, provided in Section-2.

The bidders shall furnish catalogues, engineering data, technical information, design documents, drawings etc. in English language, fully in conformity with the technical specification.

Whenever required, the bidder shall depute his technical experts to RDSO / nominated agency for design discussions and approval.

#### 3.3 GENERAL DESIGN REQUIREMENTS

- i) The stock fitted with the supplied equipment shall meet the operating, service conditions and performance requirements of this specification and shall be suitable for operating conditions on IR.

	<p align="center"><b>TECHNICAL SPECIFICATION FOR Vacuum Circuit Breaker with AC Earth Switch</b></p> <p><b>DOC. No.: PS4452954, PART-A, REV No. 00</b></p>	<p align="center"><b>PROJECT- ICF Trainsets</b></p>
--	--	---

- ii) All equipment shall be vandal proof and incorporate necessary anti-pilferage features without compromising aesthetics / maintainability.
- iii) Notwithstanding the contents of this specification, the Supplier shall ensure that the equipment supplied by them is complete in all respect so as to achieve the efficient operation & optimum performance of the Train set.
- iv) The equipment design shall incorporate all essential features necessary to yield high traffic use, low maintenance requirements, easy maintainability, high regeneration, high efficiency, light in weight, user & environment friendly and high reliability in train operation. The design shall also facilitate easy erection, inspection, maintenance and replacement of the sub-units/ assemblies of all the equipment.
- v) The entire equipment shall be designed to ensure satisfactory and safe operation under the running conditions mentioned in this specification duly taking care of sudden variations in load, voltage etc. under abnormal working conditions due to faulty operation, short circuits & earth faults etc.
- vi) Wherever applicable: Airflow inlet/ arrangement for forced cooled equipment shall be designed in such a way that cloth, polythene, papers etc., which may get sucked, either do not block the airflow or get removed during halts. Moreover, filter should be easily cleanable.
- vii) All working parts of the control and auxiliary circuit specifically electronics and PCBs, shall be suitably covered to keep them free from moisture, mold growth and dust. The protection level shall be furnished by the Supplier during design approval.
- viii) All the electrical equipment shall comply with the latest edition of governing IEC specifications unless otherwise specified. The temperature rise shall be measured according to the procedure stipulated by IEC and shall comply with the limits specified and the ambient conditions defined in the Specification.
- ix) All equipment shall be adequately earthed, insulated, screened or enclosed. They shall be provided with essential interlocks & keys as may be adequate to ensure the protection of the equipment and the safety of those concerned with its operation and maintenance.
- x) Wherever applicable: Supplier shall to the extent feasible employ the currently available lubricants/cooling oils in India. Full lubrication scheme and schedule for the equipment shall be submitted. If use of imported lubricants or cooling oil is inevitable, supplier shall furnish details of equivalent Indian lubricants/oil.
- xi) Supplier shall submit 3D models of offered equipment including associated sub-assemblies, etc. in. stp formats.

	<p align="center"><b>TECHNICAL SPECIFICATION FOR Vacuum Circuit Breaker with AC Earth Switch</b></p>	<p align="center"><b>PROJECT- ICF Trainsets</b></p>
<p><b>DOC. No.: PS4452954, PART-A, REV No. 00</b></p>		

- xii) The design of the equipment shall be based on sound, proven and reliable engineering practices. The equipment used in different sub systems shall be of proven technology and design. The supplier shall submit the supportive document for each of the assembly/sub-assembly for its proven performance under the environmental conditions prevalent in India.
- xiii) The supplier shall design the mounting arrangements suitable for coaches. The accessories for mounting the equipment shall be part of the scope of supply. The hardware for mounting, safety links for underslung equipment, the termination hardware also will be in the scope of supply for all equipment.
- xiv) SOFTWARE (WHEREVER APPLICABLE)
- a. Software shall be written in a structured manner and fully documented during all stages of its design and development. This shall meet the requirements of EN 50126-2: The specification and Demonstration of Reliability, Availability, Maintainability and Safety (RAMS) - Part 2, EN 50128: Railway Applications: Software for Railway Control and Protection Systems, and EN 50129: Safety-related Electronic Railway Control and Protection Systems.
  - b. The Supplier shall submit the values of parameters, list of fault messages, their environmental data, hierarchy of fault display, fault categorization, trouble shooting of each fault by way of Changes in parameters shall be demonstrated with their effect on the results.
  - c. Parametric changes shall be possible in the software in order to meet the future requirements. While listing out the values of various parameters, the Supplier must provide a range within which any change can be made without jeopardizing the functionality of the system. Supplier shall submit the licensed software to the purchaser.
  - d. Software shall be fine-tuned through simulations & real life working conditions based on the extensive trials, associating BHEL / user Railways before putting the rake in commercial services. As it requires, instrumentation and expertise of Software Design Professionals, software expert(s) of Supplier shall be based at the work place along with commissioning engineers so that all software related issues are expeditiously resolved before putting the rake into commercial service.
  - e. Quality and efficacy of trouble shooting manual, software tools and software documentation shall be validated during extensive field trials. Final version of these documents shall include the changes required based on the service trials, commercial service operation, experience of operating Railways.



# TECHNICAL SPECIFICATION FOR Vacuum Circuit Breaker with AC Earth Switch

PROJECT- ICF  
Trainsets

DOC. No.: PS4452954, PART-A, REV No. 00

- f. All the changes, thereafter, in software shall be approved by RDSO / nominated agency in consultation with user Railways before actual implementation and the Supplier must give software release, which shall include brief description of the problem, earlier as well as modified logic, explanation, parametric changes etc. to the satisfaction of RDSO / nominated agency.
- g. The Supplier shall submit Software Quality Plan for review before work commences on software design. The software quality plan shall clearly state the controls and practices used in the software life cycle from specification through to in-service operation.
- h. Internal independent review, verification & testing, using real & synthetic data, shall be performed at the software module and system level. RDSO/ nominated agency / BHEL / user Railway may audit the Supplier against the **Software Quality Plan** at any stage during the Contract. The Supplier shall ensure that all software is fully de- bugged prior to the final review by RDSO/user Railway.
- i. Sufficient software documentation shall be provided to give the full understanding of the software function, logics, parameters and operation. Documentation shall be complete, clear and concise, and include all modifications up to the final acceptance. Documentation shall clearly explain the software logics, associated parameters, include software block diagram showing signal flow, logic and hardware interfaces etc. A top level flow diagram and description of detailed operation shall be provided.
- xv) Notwithstanding the contents of this specification, the supplier shall ensure that the equipment supplied by them is complete in all respect so as to enable the desired operation of the Train fitted with their equipment.
- xvi) Supplier shall deliver the executable files of all developed software along with necessity tools to upload / download and carry out fault analysis.

## 3.4 INGRESS PROTECTION

- i) All equipment shall be suitably protected from dust and water. As a minimum, equipment shall be sealed to the standards stated below:

Under frame & externally mounted equipment (other than traction/ auxiliary converter/Traction Motor)	IP65
Battery Box and Brake Chopper	IP20
Equipment mounted inside the Car body	IP54



# TECHNICAL SPECIFICATION FOR Vacuum Circuit Breaker with AC Earth Switch

PROJECT- ICF  
Trainsets

DOC. No.: PS4452954, PART-A, REV No. 00

- ii) It may be necessary to protect some equipment to IP 67 in order to meet the requirements of Clause 3.5 of this Specification.

## 3.5 AMBIENT CONDITIONS / OPERATING CONDITIONS

The equipment shall be designed to work satisfactorily under following environmental conditions: -

Atmospheric temperature	Maximum temperature: 50 degrees Celsius Maximum touch temperature of metallic surface under the Sun: 75 degrees Celsius and in shade: 55 degrees Celsius Minimum temperature: - 10 degree Celsius
Humidity	100% saturation during rainy season
Solar radiation	1 kW/m <sup>2</sup>
Altitude	1000 meter above mean sea level
Rain fall	Very heavy and continuous rainfall in certain areas (up to 2500 mm during rainy season)
Atmospheric conditions	Extremely dusty and desert terrain in certain areas. The dust concentration in air may reach a high value of 1.6 mg/m <sup>3</sup> . In many iron ore and coal mine areas, the dust concentration is very high affecting the filter and air ventilation system
Coastal area	Humid and salt laden atmosphere. The equipment shall function in accordance with this Specification when subjected continuously to a humid and salt laden atmosphere with maximum pH value as per IEC 60571, sulphate content of 7 mg per litre, maximum concentration of chlorine 6 mg per litres and maximum conductivity of 130 micro Siemens / cm.
Vibration	The vibration and shock levels recorded on various Sub-systems in existing Trains of IR are generally more than the limits given in IEC 61373 particularly at axle box, and traction motor. Accelerations over 50g have been recorded at axle box levels during run. Vibrations during wheel slips are of even higher magnitude. High level of vibrations above 30g have been measured at traction motor on IR's Trains, which increase up to 50g with worn gear- pinion.
Wind speed	High wind speed in certain areas, with wind pressure reaching 216 kg/m <sup>2</sup> as per IS:875 Part 3(2015)



# TECHNICAL SPECIFICATION FOR Vacuum Circuit Breaker with AC Earth Switch

PROJECT- ICF  
Trainsets

DOC. No.: PS4452954, PART-A, REV No. 00

Flood level	<p>The Train shall function in accordance with these Specifications and Standards in the event of flooding up to 203 mm above Rail Level as follows:</p> <ul style="list-style-type: none"><li>• In the event of flooding at any level below Rail Level, the Train shall operate in full compliance with these Specifications and Standards.</li><li>• In the event of flooding at a height between Rail Level and 203 mm above Rail Level, the Train shall operate in full compliance with these Specifications and Standards with the exception that it is permissible to restrict the operation of the Train to a maximum of 8 km/h.</li></ul> <p>Allowance is to be made in addition for increase in the height of water level due to the “bow wave” effect of the Train passing through the water.</p>
Flood Proofing of the under slung Equipment	<p>Waterproofing test will be conducted on Traction and Auxiliary Converter by dipping them up to a height equivalent to 650 mm from rail level (under fully wheel worn condition) in stationary water for 12 hours. There should be no water ingress and Converters shall function normal after the test. Traction Motor with gearbox shall be tested for waterproofing as defined in clause 3.4.6.10.1 of specification ICF MD SPEC-398, issue status-01, rev 01. Other underslung equipment shall have IP protection as mentioned in clause 3.4 of this specification. However, even in case of flood levels more than the mentioned above, the equipment shall not get damaged and it should be possible to rejuvenate the equipment with minor attention without any adverse effect on their performance. Axle box shall be adequately flood proof.</p>

## 3.6 STANDARDS

- (a) The standards applicable and relevant to the complete Train and to the various Sub-systems and systems shall be:
- (i) IEC publications;
  - (ii) EN;
  - (iii) UIC;
  - (iv) AAR;
  - (v) IEEE;
  - (vi) BS;
  - (vii) RDSO specifications;
  - (viii) ICF/RCF specifications;
  - (ix) NF-F;
  - (x) ORE;
  - (xi) VDE;



# TECHNICAL SPECIFICATION FOR Vacuum Circuit Breaker with AC Earth Switch

**PROJECT- ICF  
Trainsets**

**DOC. No.: PS4452954, PART-A, REV No. 00**

- (xii) UL;
- (xiii) JIS
- (xiv) IS; and
- (xv) Any other standards referred to in this Schedule.

(b) In the event of any contradiction in the aforesaid standards, the following standards shall have priority in the order listed:

- (i) Standards mentioned in these Specifications and Standards set forth herein;
- (ii) EN/IEC/UIC/AAR and
- (iii) IS.

(c) For avoidance of any doubt, in case of any conflict between the requirements of these standards, the stipulations of Specifications and Standards in this Schedule shall have precedence.

(d) The temperature rise shall be measured according to the procedure stipulated by IEC and shall comply with the limits specified and the ambient conditions defined in the Specification. Specified temperature rise of equipment shall be calculated after taking into account at least 25% choking of air filters and radiator fins etc.

## 3.7 ENGINEERING DATA

- (a) The contactor shall necessarily submit all the drawings/ documents unless anything is waived. The contactor shall submit drawings/ design documents/ data/ test reports as may be required for the approval of the purchaser. All drawings submitted by the Manufacturer including those submitted at the time of bid shall be in sufficient detail to indicate the type, size, arrangement, material description, Bill of Materials, weight of each component, break-up for packing and shipment, the external connections, fixing arrangement required, dimensions required for installation and interconnections with other equipment and materials, clearances and spaces required for installation and interconnections between various portions of equipment and any other information specifically requested in the specifications.
- (b) Each drawing submitted by the Manufacturer shall be clearly marked with the name of the Customer and Project, the unit designation, the specifications title, the specification number, date of revision (if any), duly signed by the concerned technical person. If standard catalogue pages are submitted, the applicable items shall be indicated therein and should be made project specific. All titles, noting, markings and writings on the drawing shall be in English. All the dimensions should be in metric units.
- (c) The title block of drawings shall contain the following information incorporated in all contract drawings

**1. Customer :** BHEL /Indian Railways

**2. Project:** Manufacturing cum Maintenance of Vande Bharat Trainsets

	<b>TECHNICAL SPECIFICATION FOR Vacuum Circuit Breaker with AC Earth Switch</b>	<b>PROJECT- ICF Trainsets</b>
	<b>DOC. No.: PS4452954, PART-A, REV No. 00</b>	

**3.Contract No./LOA No./ Ref no.:** 2022/RS(WTA)-527/Vande Bharat Trains/874/1  
dated 14/06/23

**4. Main Contractor : Bharat Heavy Electricals Limited**

### 3.7.1 SIZE OF DRAWINGS

The drawings of the following parts shall be to the sizes indicated below

- I. Equipment details – full size or half size
- II. Motor Assemblies – 1:5
- III. General Assemblies- 1:10

Further, the scaling of drawings should be as per applicable standards.

### 3.7.2 METHOD OF FILING OF DRAWINGS

To facilitate filing of drawings, it is essential that each drawing submitted for approval is marked so that it can be identified. The supplier is, therefore, required to ensure that all prints are marked legibly at the right hand bottom corner. The following information is required in respect of each drawing:

- I. Supplier's drawing number.
- II. Supplier's name and date of submission.
- III. Contract no. given by the purchaser.
- IV. Description of drawings.
- V. Relevant Specifications

### 3.8 MARKING OF EQUIPMENT & RATING PLATE

- (a) All main assemblies of the equipment shall bear serial number, year of manufacture and symbol/ identification of the purchaser. Where the sub- assemblies/components of the main assemblies are not inter-changeable, the sub-assemblies shall also be marked with the serial nos. of the main assembly of which they form a part.
- (b) All equipment/cubicles shall contain non-detachable rating plates of anodized aluminium with embossed letters and fitted in a visible position. The rating plate will give detailed rating specification and identification of equipment.

### 3.9 INFRINGEMENT OF PATENT RIGHTS

BHEL and Indian Railway shall not be responsible for infringement of patent rights arising due to similarity in design, manufacturing process, components used in design, development and manufacturing of propulsion system & other equipment and any other

	<b>TECHNICAL SPECIFICATION FOR Vacuum Circuit Breaker with AC Earth Switch</b>	<b>PROJECT- ICF Trainsets</b>
	<b>DOC. No.: PS4452954, PART-A, REV No. 00</b>	

factor which may be a cause such dispute. The responsibility to settle any issue lies with the manufacturer.

### 3.10 DOCUMENT SUBMISSIONS

The scheduled dates for the submission of these as well as for, any data/information to be furnished by the Purchaser would be discussed and finalized at the time of award. The following schedule shall be followed generally for approval:

Sl.no.	No. of copies	Schedule
i)	Initial Submission Drawings, Data sheets, Type test Reports	At the time of submission of offer.
ii)	Furnishing of drawings in hard / soft copy format	Approx 2 to 3 weeks from the date of award of contract.
iii)	Furnishing of type test reports in hard / soft copy format	Hard / soft copy to be submitted immediately after the completion of the test.
iv)	Furnishing of routine test reports	Hard / soft copy to be submitted immediately after the completion of the test.
v)	All documents including Installation, Operation & Maintenance manuals.	Approx 2 to 3 weeks from the date of award of contract.

### 3.11 QUALITY ASSURANCE PROGRAMME

(a) To ensure that the equipment and services under the scope of this Contract, whether manufactured or performed within the Manufacturer's Works or at his Sub-manufacturer's premises or at the Purchaser's site or at any other place of Work, are in accordance with the specifications, the Manufacturer shall adopt a suitable quality assurance program to control such activities at all points, as necessary. Such program shall be outlined by the Manufacturer and shall be finally accepted by the Purchaser

(b) A quality assurance program of the manufacturer shall generally cover the following:

- I. Manufacturer's organization structure for the management and implementation of the proposed quality assurance program:
- II. Documentation control system;
- III. Qualification data of bidder's key personnel;



# TECHNICAL SPECIFICATION FOR Vacuum Circuit Breaker with AC Earth Switch

PROJECT- ICF  
Trainsets

DOC. No.: PS4452954, PART-A, REV No. 00

- IV. The procedure for purchases of materials, parts components and selection of sub-Manufacturer's services including vendor analysis, source inspection, incoming raw material inspection, verification of material purchases etc.
- V. System for shop manufacturing and site erection controls including process controls and fabrication and assembly control;
- VI. Control of non-conforming items and system for corrective actions;
- VII. Inspection and test procedure both for manufacture and field activities;
- VIII. Control of calibration and testing of measuring instruments and field activities;
- IX. System for indication and appraisal of inspection status;
- X. System for quality audits;
- XI. System for authorizing release of manufactured product to the Purchaser
- XII. System for maintenance of records;
- XIII. System for handling storage and delivery; and
- XIV. A quality plan detailing out the specific quality control measures and Procedures adopted for controlling the quality characteristics relevant to each item of equipment furnished and/or services rendered.

(c) The Purchaser or his duly authorized representative reserves the right to carry out quality audit and quality surveillance of the system and procedure of the Manufacturer/'his vendor's quality management and control activities.

### 3.12 QUALITY ASSURANCE DOCUMENTS

The Manufacturer shall be required to submit the Quality Assurance Documents as stipulated in the quality plan at the time of purchaser's inspection of equipment/material.

### 3.13 TYPE AND ROUTINE TESTING & INSPECTION

1. The individual prototype equipment, systems and sub- systems shall be type and routine tested in accordance with the relevant IEC/UIC/EN publications inclusive of the mandatory and optional tests along with the special tests as specified.
2. All type tests shall be conducted by Supplier or such other agency or person agreed by RDSO / Nominated Agency at the Supplier's cost where ever performed in presence of and to the satisfaction of RDSO/ Nominated Agency, who reserves the right to witness any or all of the tests. All tests set forth in this specification shall be conducted by the Supplier or other agency or competent person as agreed by the purchaser/ RDSO/ Nominated Agency.
3. RDSO / Nominated Agency may waive some of these tests in case of equipment/ sub-assemblies where the manufacturer can establish to the satisfaction of RDSO that such

	<p align="center"><b>TECHNICAL SPECIFICATION FOR Vacuum Circuit Breaker with AC Earth Switch</b></p> <p><b>DOC. No.: PS4452954, PART-A, REV No. 00</b></p>	<p align="center"><b>PROJECT- ICF Trainsets</b></p>
--	--	---

tests have already been carried out earlier. In such a case, manufacturer shall submit complete test reports along with necessary certification.

4. Wherever any equipment, system, sub system is not specifically covered by an international recognized specification or test procedure, the tests which are acceptable to both to Supplier and to the IR's representative shall be devised.
5. Without prejudice to any provisions of the contract, the purchaser reserves the right to witness any or all of the type tests and to require submission of any or all test specification and reports.
6. In case any bidder indicates that he shall not carry out a particular test, his offer shall be considered incomplete and shall be liable to be rejected.
7. The Purchaser, his duly authorized representative and/or outside inspection agency acting on behalf of the Purchaser shall have at all reasonable times free access to the Contractors premises or Works and shall have the power, at all reasonable times to inspect and examine the materials and workmanship of the works during its manufacture or erection if part of the Works is being manufactured or assembled at other premises or works, the Manufacturer shall obtain for the Engineer and for his duly authorized representative permission to inspect as if the works were manufactured or assembled on the Manufacturer's own premises or works. Inspection may be made at any stage of manufacture, dispatch or at site as the option of the Purchaser and the equipment if found unsatisfactory due to bad workmanship or quality, material is liable to be rejected.
8. Supplier to depute qualified person for supervision of installation and commissioning of the equipment in the prototype rake. During the prototype tests/trials of train, if a technical problem arises with the equipment, qualified supplier representative should be deputed to attend the same.
9. During the prototype tests/trials or service of train, if any problems arise or feedback information is obtained, which warrants a re-check of the design/manufacture/quality of the equipment and components, action will be taken as may be necessary by the Supplier to carry out the required investigations and to incorporate the improvements considered most appropriate to reach compliance with the specification without any extra costs to the Purchaser and in a manner approved by the RDSO/Nominated Agency on equipment/components already supplied as well as those to be supplied later.
10. The prototype rakes fitted with the supplied equipment, shall be subjected to pre-revenue service trials. Service trials are intended to prove the satisfactory running performance of the supplied Train set equipment and evaluate their reliability in service, ease of maintenance and operations. The performance of the equipment shall be

	<p style="text-align: center;"><b>TECHNICAL SPECIFICATION FOR Vacuum Circuit Breaker with AC Earth Switch</b></p> <p><b>DOC. No.: PS4452954, PART-A, REV No. 00</b></p>	<p style="text-align: center;"><b>PROJECT- ICF Trainsets</b></p>
--	---	--

assessed based on the experience gained during the service trials. Necessary modification as required and also as desired by the RDSO/ Nominated Agency / Indian Railway shall be implemented in the series production without any extra costs to the Purchaser.

**11. Type tests on electronic equipment and control electronics**

The electronic equipment and Control Electronics shall be tested as per IEC 60571/EN50155, IEC 60068, EN 50121, IEC 60721-2-5 and IEC 61373 including both compulsory and optional tests. Dry heat test, as specified in IEC 60571, shall be conducted for testing power and control electronic equipment at 80 degrees Celsius. LCD display units shall be tested at 70°C.

**3.14 MATERIALS AND WORKMANSHIP**

Equipment materials and components shall be new, of high grade and good quality and be to the latest engineering practice. The material and workmanship throughout shall be in accordance with the purpose for which they are intended. Each component shall be designed to be consistent with its duty.

**3.15 PACKING, STORAGE AND HANDLING INSTRUCTIONS**

All the equipment shall be suitably protected, coated, covered or boxed and crated to prevent damage or deterioration during transit, handling and storage at site till the time of erection. The manufacturer shall also submit packing details/ associated drawing for any equipment/ material before equipment dispatch.

All coated surfaces shall be protected against abrasions, impact, discoloration and any other damages. All exposed threaded portions shall be suitably protected with either a metallic or a non-metallic protecting device.

Storage requirements shall be clearly defined by the supplier. Packing shall be such that if required, long time storage at site should not deteriorate the performance of the equipment.

**3.16 FIRE PREVENTION**

- i) The design of equipment shall incorporate all measures to prevent fire, and will be such that should any fire take place, the effects shall be minimized and no spread of fire should take place. Materials that are not fire retardant shall not be used.
- ii) Materials used in the manufacture of equipment shall be selected to reduce the heat load, rate of heat release, propensity to ignite, rate of flame spread, smoke emission and toxicity of combustion gases.

	<p align="center"><b>TECHNICAL SPECIFICATION FOR Vacuum Circuit Breaker with AC Earth Switch</b></p>	<p align="center"><b>PROJECT- ICF Trainsets</b></p>
<p><b>DOC. No.: PS4452954, PART-A, REV No. 00</b></p>		

- iii) The fire protection on Train shall be designed and constructed in accordance with EN 45545. The applicable Hazard level will be HL3.
- iv) Contractor shall furnish the relevant data, fire load calculations, certifications etc. of the items considered in fire load calculations separately for Above & Below the floor level. The calculations and validation shall conform to the standard adopted by the contractor for fire strategy.
- v) Relevant provisions stipulated in Central Electricity Authority (Measures related to Safety and Electric Supply) Regulations, 2010, shall be followed in the interest of safety of passenger/staff as well as for equipment / instruments provided in the coaches.

CONFIDENTIAL

	<b>TECHNICAL SPECIFICATION FOR Vacuum Circuit Breaker with AC Earth Switch</b>	<b>PROJECT- ICF Trainsets</b>
	<b>DOC. No.: PS4452954, PART-A, REV No. 00</b>	

## SECTION – 4

# RELIABILITY, AVAILABILITY, MAINTAINABILITY AND SAFETY (RAMS)

### 4.1 KEY PERFORMANCE INDICATORS

Performance indicators comprises of Availability, Reliability and upkeep of Cars. The bidder must ensure RAMS parameters for the offered equipment and its sub-assemblies supplied to at least maintain the overall fleet availability and reliability targets given below. In case, fleet reliability drops on account of poor reliability of subassemblies supplied, the supplier will be required to improve the quality of subassemblies to match the availability & reliability targets.

#### a) Availability

Sum of Available Hours as a proportion of the total hours (Available Hours + Non-Available Hours) in the Fleet in any Accounting Year, shall be considered as “Availability”. Guaranteed Availability in every Accounting Year shall be at least 95%.

#### b) Reliability

Average Mean distance travelled between two Failures for the fleet in any Accounting Year shall be considered as “Reliability”. Guaranteed Reliability shall not be less than 200,000 km.

#### c) Upkeep

For the offered equipment, there shall be no such conditions during the operation of trains that affects the reliability, safety and passenger amenities. Any maintenance shall be conterminous with the train maintenance schedules as given in Cl 4.5 of this section.

List of Conditions affecting Upkeep (As applicable) is enclosed as Annexure-A of this section.

### 4.2 RELIABILITY AVAILABILITY MAINTAINABILITY AND SAFETY (RAMS)

a) The supplier shall ensure that, Guaranteed Reliability, Guaranteed Availability and High Degree of Safety in order to provide a dependable service, forms an integral element of the offered products.

b) The plan for Reliability, Availability, Maintainability and Safety shall conform to EN 50126/ IEC 61709/ IEC 62278. Reliability of electronic components shall conform to IEC 61709.

c) The supplier shall develop and provide RAMS targets (MTBF/MDBF/MTBSF) for the offered equipment both for the complete system and for the major Sub-systems at ambient temperature up to 50°C.

	<p align="center"><b>TECHNICAL SPECIFICATION FOR Vacuum Circuit Breaker with AC Earth Switch</b></p> <p><b>DOC. No.: PS4452954, PART-A, REV No. 00</b></p>	<p align="center"><b>PROJECT- ICF Trainsets</b></p>
--	--	---

d) After rectification of any failure / fault, the concerned equipment / system should resume its original performance / function.

e) Components critical for safety shall fall into safe operating mode in case of malfunctioning. The system safety plan shall identify and list safety critical components and this list shall be updated periodically and intimate to the purchaser.

f) Supplier shall submit the basic maintenance schedules of the proposed equipment. Minimum interval between two maintenance schedules in the depot for the equipment supplied should not be less than 90 days except for activities which can be done outside the base depot (such as cleaning of filters mounted in the under-frame, for which the periodicity shall not be less than 15 days) and 3 years for major works in workshop/major depot. Average running distance of a rake may be considered as 2000 kilometer per day. Please refer Cl 4.5 below in respective planning of maintenance schedule for the supplied equipment.

g) All systems, components and structural areas serviced as part of inspection or periodic preventive maintenance shall be conveniently accessible for service and inspection.

#### **4.3 RAMS DOCUMENTATION**

Vendor shall agree to submit following documents pertaining to RAMS analysis:

- Functional breakdown + inherent failure analysis
- Mission critical failures Analysis (Fault Tree Analysis)
- FMECA (Failure Mode Effects and Criticality Analysis)
- System/Sub-Systems Hazard Analysis
- Hazard Log + SIL data (if applicable)
- List of critical components
- Preventive Maintenance Analysis
- Corrective Maintenance Analysis

#### **4.4 SERVICE LIFE OF EQUIPMENT/SYSTEM**

Vendor shall specify the service life of the offered equipment / system based on life cycle calculations after which the equipment / system shall call for complete replacement to maintain the required reliability & availability of fleet.



# TECHNICAL SPECIFICATION FOR Vacuum Circuit Breaker with AC Earth Switch

PROJECT- ICF  
Trainsets

DOC. No.: PS4452954, PART-A, REV No. 00

## Annexure-A

List of Conditions affecting Upkeep of Trains.

S.No.	System name	Condition
1	Windscreen Wiper and Washer System	- Rainy weather, defective wiper in any cab.
2	Couplers (any type)	- Any mechanical/electrical/pneumatic fault and/or any dimensional misalignment and/or any damage to any part which does not allow the coupler to guarantee the fulfilment to its assigned mission, in accordance to the technical requirements, performance and safety set out in this specification.
3	Suspension	- Any defect in primary / secondary suspension resulting in passenger safety, comfort or performance.
4	Wheel	- If wheel flat is > 40 mm or as finalised in design. - Any abnormal hammering as reported by the TO.
5	Pantograph	- Isolation of any pantograph
6	Transformer	- Isolation of any one main transformer.
7	Battery charger	- Battery Charger of one unit isolated.
8	Mechanical drive system	- Any defect resulting in high temperature / isolation
9	Traction Motors	- Isolation of more than 25%motors.
10	Traction converters	- As per the consequential effect as defined in Item 10 above.
11	Main compressor unit	- Isolation of any Main Compressor Unit
12	Auxiliary converter-inverter	- Isolation of any Auxiliary Converter-Inverter unit.
13	Brake system (mechanical)	- If isolation of an additional bogie (mechanical) leads to speed restriction.
14	Exterior lights	- Failure of any head light / marker/tail light.
15	Driver's desk	- If master controller prevents the train from moving. - Any defect in master controller even if no delays are reported. - Any defective cab switch leading to unsafe operation.



# TECHNICAL SPECIFICATION FOR Vacuum Circuit Breaker with AC Earth Switch

PROJECT- ICF  
Trainsets

DOC. No.: PS4452954, PART-A, REV No. 00

16	TCMS & Vehicle circuits	<ul style="list-style-type: none"><li>- If HMI display fails &amp; functionality is not transferred to redundant HMI.</li><li>- Any failure in TCMS component / equipment /circuit element / software/communication system etc. resulting in loss of intended function.</li><li>- Further cases will be included based on TCMS redundancy and configuration.</li></ul>
17	PIS & CCTV	<ul style="list-style-type: none"><li>- If both automatic and manual announcements fail</li><li>- If announcements in Car is not audible</li><li>- if <math>\geq 1</math> unit exterior side view CCTV not working</li><li>- If <math>&gt;1</math> PEA in any car is defective</li><li>- One saloon CCTV, including its backup if any, is isolated.</li><li>- If <math>\geq 1</math> unit for rear cab and front cab camera, cameras on the roof</li></ul>
18	Passenger doors	<ul style="list-style-type: none"><li>- If <math>\geq 1</math> (one) door per train side is isolated.</li></ul>
19	HVAC (passenger area)	<ul style="list-style-type: none"><li>- Failure of any one HVAC in any car leading to increase in inside temperature <math>\geq 28^{\circ}\text{C}</math></li><li>- Failure of two HVAC's in one car.</li><li>- Noisy Air Conditioner: Interior Noise <math>&gt;+2\text{dB}</math> than the one recorded and validated during the type test at standstill)</li></ul>
20	Ground fault in DC Circuit	<ul style="list-style-type: none"><li>- Train to be withdrawn in case of single ground fault if it leads to unsafe operation as per the design.</li></ul>
21	A failure or symptom which may endanger safe and/or normal operation of train	<ul style="list-style-type: none"><li>- Failure in safety interlock or protection circuit such as door loop</li><li>- Abnormal noise in underframe</li><li>- Wheel flat</li><li>- Arcing in pantograph</li><li>- Failure of emergency equipment</li><li>- Failure which may disable train's push out duty.</li><li>- Train which that requires more than 2 instances of reset within 30 minutes</li><li>- Jerky movement (The details shall be finalized in design stage).</li><li>- Others to be decided during design stage</li></ul>

*Note: The above list shall be further reviewed and updated during design stage.*

## 4.5 TRAIN MAINTENANCE SCHEDULE (TENTATIVE)

Sl. No.	Schedule	Place of maintenance	Permissible time per schedule	Periodicity
1	Minor maintenance	Light maintenance at Depot	8 hours	3 months
2	AOH	Light maintenance at Depot	7 days	18 months
3	IOH	Heavy maintenance at Depot	10 days	36 months
4	POH	Heavy maintenance at Depot	20 days	72 months

	<b>TECHNICAL SPECIFICATION FOR Vacuum Circuit Breaker with AC Earth Switch</b>	<b>PROJECT- ICF Trainsets</b>
	<b>DOC. No.: PS4452954, PART-A, REV No. 00</b>	

## SECTION -5

### SPARES AND CONSUMABLES FOR MAINTENANCE

#### 5.1 SPARES AND CONSUMABLES

- i) Supplier shall provide complete list of items/materials which get consumed during normal course of operation of the Train as applicable for the equipment/system (the “Consumables”).
- ii) Supplier shall provide complete list of parts or equipment/system ensuring fleet availability of 95% or better, which would be necessary for efficient operation and maintenance of the (the “Spares”).
- iii) Supplier shall provide detailed spare parts catalogue / data-sheet listing all components manufactured or purchased by the supplier along with their rating, source, type / model no., schematic, position, etc.
- iv) Price for above spares and consumables to be shared separately as part of commercial offer.

#### 5.2 SCHEDULED MAINTENANCE

- a) Scheduled (Preventive) maintenance consists of operations to maintain an assembly/subassembly or components in its specific operating conditions by performing:
  - i) periodical inspection and diagnostic tests for prevention of malfunctioning.
  - ii) scheduled replacement of components.
  - iii) checks to be performed at specified time intervals, whose outcome determines whether or not replacements will be required.
  - iv) routine operations, such as filling, topping up, change oil, greasing, adjustments, etc.
  - v) general overhaul of systems and subsystems.
- b) The preventive maintenance schedules required to keep the supplied system in good fettle with requisite reliability and availability would be coterminous with the train maintenance schedules and it should be possible to comfortably complete such maintenance during the time provided for respective train maintenance schedule and in the facility provided (refer Chapter Reliability, Availability, Maintainability and Safety).
- c) Details of Schedule of Periodic / preventive maintenance (the “Scheduled maintenance”) shall be submitted in following sample format:

Nature of inspection / maintenance	Periodicity / Interval	Items to be replaced
------------------------------------	------------------------	----------------------



# TECHNICAL SPECIFICATION FOR Vacuum Circuit Breaker with AC Earth Switch

PROJECT- ICF  
Trainsets

DOC. No.: PS4452954, PART-A, REV No. 00

- d) Scheduled Maintenance shall ordinarily not be required before a travel of 40,000 km (forty thousand kilometres).
- e) Supplier shall provide plan / activities for periodical inspection and diagnostic test for prevention of malfunctioning
- f) List of facilities including tools & tackles required for carrying out all scheduled maintenance activities to be provided by vendor.
- g) All systems, components and structural areas serviced as part of inspection or periodic preventive maintenance shall be conveniently accessible for service and inspection.

### 5.3 UNSCHEDULED MAINTENANCE

Unscheduled (Corrective) maintenance consists of maintenance operation which is not scheduled (part of preventive maintenance) as a result of an in-service failure.

The supplier shall be required to provide repair & maintenance instructions to put back the equipment / system back in service.

List of facilities including tools & tackles required for carrying out all unscheduled maintenance activities to be provided by vendor.

### 5.4 EPIDEMIC DEFECT WARRANTY

(a) If any identical defect or deficiency affecting Safety, Reliability and Availability of the trains on more than 20% (twenty per cent) of equipment or parts in any rolling period of 36 (thirty-six) months commencing from the second Year of the Supply Period, such defect or deficiency shall be deemed to be an epidemic defect (the "Epidemic Defect") and the supplier shall cover such Epidemic Defect under an epidemic defect warranty.

(b) In case, the Government (Railways) notifies an Epidemic Defect on account of the supplied assembly, the supplier shall remedy such Epidemic Defect on all such Trains where equipment or parts of that particular design or lot are provided, subject to limitation of period elapsed since commissioning as mentioned above in this para.

### 5.5 OPERATION AND MAINTENANCE MANUAL

- i) Supplier shall provide an operation manual (the "Operation Manual") for the offered equipment / system in soft copy format in English and Hindi language. The Operation Manual shall include (but not limited to):
  - a) Instructions for troubleshooting;
  - b) Rating and layout of equipment;
  - c) Operating limits of installed systems;
  - d) Control and safety features of the Equipment/System;

	<p align="center"><b>TECHNICAL SPECIFICATION FOR Vacuum Circuit Breaker with AC Earth Switch</b></p> <p><b>DOC. No.: PS4452954, PART-A, REV No. 00</b></p>	<p align="center"><b>PROJECT- ICF Trainsets</b></p>
--	--	---

- e) Instructions to Loco Pilots for operation of the Train (if applicable);
- f) Do's and don'ts for Loco Pilots (if applicable);
- g) Safety precautions to be taken by the Loco Pilots (if applicable);
- ii) The Maintenance Manual to be provided by supplier shall include:
  - (a) All maintenance activities and their periodicities that are required to keep the Train safe and ensure that the prescribed tolerances of systems and components are not exceeded at any time, including any systems relevant to the maximum moving dimensions;
  - (b) The inspection program for regularly checking that the Train is safe to continuing in service;
  - (c) Assembly & disassembly sequences for the supplies with pictorial playbook guide
  - (d) The engineering facilities (such as pit facilities, special tools etc.) necessary for the mandated maintenance;
  - (e) Minimum competencies required by staff for the maintenance activities.
- iii) The Maintenance Manual shall ensure that safety critical systems and components on the Train are identified specifically and the minimum testing requirements that must be invoked in the event of their disturbance at examination or repair are defined.
- iv) Preparation of the Maintenance Manual shall give consideration to inspections, tests and maintenance of the following that have a bearing on safety:
  - (a) inter-vehicular couplers.
  - (b) fire prevention system including safe working of pantry/ sub pantry equipment.
  - (c) Auxiliary electrical machines: Integrity and security, earthing condition and integrity, condition of safety labelling.
  - (d) Passenger Information System
  - (e) Cleaning: Ventilation ducts, filters, bogies and underframe equipment
  - (f) Power systems (including protection systems): Integrity and security earthing condition and integrity, condition of safety labelling.
  - (g) Pantographs: Integrity and security - dimensions and condition of pantograph head, over-height protection, earthing condition and integrity, condition of safety labelling.
  - (h) Train structures and underframes: Integrity and condition of all load bearing members or panels, integrity, operation and security of doors, openable and removable panels, integrity and security of all body mounted equipment, alignment, gangway.
  - (i) Safety systems (e.g. Vigilance control device): Functional tests;
  - (j) Hydraulic and pneumatic systems: Condition and integrity of hoses, pipework, valves, etc.
  - (k) Fire protection systems: Integrity and condition.
  - (l) Lighting Systems & Visibility: Headlight, flasher and marker lights, adjustment, intensity
  - (m) Speedometers; headlights and marker lights; horn; doors; cattle guard; and bio-vacuum toilets

	<p align="center"><b>TECHNICAL SPECIFICATION FOR Vacuum Circuit Breaker with AC Earth Switch</b></p> <p><b>DOC. No.: PS4452954, PART-A, REV No. 00</b></p>	<p align="center"><b>PROJECT- ICF Trainsets</b></p>
--	--	---

- (v) The instructions within the Maintenance Manuals shall be such as to protect staff working on the Trains, with particular reference to safety precautions and implementing a specified safety condition of the Train prior to starting work.

## 5.6 OBSOLESCENCE MANAGEMENT

Supplier is required to manage obsolescence of all equipment, spares and consumables to enable the trains to continue in service for 35 years. This obsolescence management service must include:

- i) Timely identification of any obsolete items of equipment;
- ii) Development of mitigation strategies to minimize the impact of the imminent obsolescence of any item within the offered equipment / system including:
  - Establishing alternative supply paths;
  - Provision of equivalent or interchange parts or equipment
  - Development of replacement products or design modifications to accept market available alternatives.

## 5.7 TRAINING ON MAINTENANCE ASPECTS

Supplier to provide training to undertake scheduled and unscheduled maintenance to purchaser and its designated persons to handle the maintenance of train for 35 years. The duration of training shall be 12 man days.





**TECHNICAL SPECIFICATION FOR  
Vacuum Circuit Breaker with AC Earth  
Switch**

**PROJECT- ICF  
Trainsets**

**DOC. No.: PS4452954, PART-A, REV No. 00**

**PERFORMA FOR PERFORMANCE CERTIFICATE**

**Name of firm: .....**

TO WHOMSOEVER IT MAY CONCERN

Sub : Confirmation letter for service performance

Dear Sir,

We hereby confirm that We ..... have manufactured \_\_\_\_\_ number of sets of .....(Name of Equipment with Model No.) for 3 Phase IGBT based EMUs/MEMUs/Metros/trainsets/LOCOs.

We further confirm that ..... number of sets of .....(Name of Equipment with Model No.) for 3 Phase IGBT based EMUs/ MEMUs/Metros/trainsets/Locos are in satisfactory operation for railway rolling stock application.

Proforma for performance statement confirming above is also attached.

Yours faithfully

**For (Name of Firm)**





**TECHNICAL SPECIFICATION FOR  
Vacuum Circuit Breaker with AC Earth  
Switch**

**PROJECT- ICF  
Trainsets**

**DOC. No.: PS4452954, PART-A, REV No. 00**

## REVISION HISTORY

Rev No.	Date	Description/Update

CONFIDENTIAL

	<b>Vande Bharat Project</b>
	<b>RAMS TEMPLATES</b>
	<b>CONTENTS</b>
<b>1</b>	<b>Breakdown + Inherent Failure Reliability Prediction</b>
<b>2</b>	<b>Critical failures analysis</b>
<b>3</b>	<b>Failure Mode Effects and Criticality Analysis (FMECA)</b>
<b>4</b>	<b>System/Sub-Systems Hazard Analysis (SHA)</b>
<b>5</b>	<b>Hazard Log + SIL</b>
	<b>Note</b> All table are in accordance to the EN 50126-1-2-3 used as guideline. Refer to above standard for definition and meaning of contents. Minor differences may exist due to application of specific requirement from Railway Administration or final User

# Breakdown + Inherent Failure Reliability Prediction

Project:		Document No/Rev:	
System:	System Supplier:	Issue date:	
Sub-System:			
Drawing no:			

RAMS code				Equipment /System Breakdown	Part number	Data Input	DTC	MC	TC	NDTC	λ unit. BASIC (FPMH)	Duty Cycle %	λ Effett. BASIC (FPMH)	λ Train Level (FPMH)	λ Train Level LEVEL 1 (FPMH) ( 16 CarTrain)	λ Train Level LEVEL 2 (FPMH) ( Sub System)
				Equipment /System												
				<b>Sum of Subsystems</b>												
1	1			<b>Sub System 1</b>												<b>0.00</b>
1	1	1		Item 1												
1	1	2		Item 2												
1	1	3		Item (n)												
1	2			<b>Sub System 2</b>												<b>0.00</b>
1	2	1		Item 1												
1	2	2		Item 2												
1	2	3		Item (n)												
1	3			<b>Sub System (n)</b>												<b>0.00</b>
1	3	1		Item 1												
1	3	2		Item 2												
1	3	3		Item (n)												
				<b>66</b>												



## Failure Mode Effects and Criticality Analysis (FMECA)

Project:														Document No/Rev:				
System:														System Supplier:		Issue date:		
Sub-System:																		
Drawing no:																		
Position No	Part/LRU Code	Description	P/N	Coach type	Function	Phase	Failure mode		Cause of Failure Mode	Failure rate (FPMH)	Failure effect			Criticality		Failure identification /detection	Preventive and compensating measures	Remarks
							Fail. Mode index	Failure Mode			Local	System	Train	Service	Safety			

## System/Sub-Systems Hazard Analysis (SHA)

:	Document No/Rev:
:	Issue date:
stem:	
g no:	

Main System ID	Hazard Category	Hazard description (general)	Hazard Identification (detailed)	Hazard description (detailed)	Sequential Numbering	Phase / Operation mode	System / Sub-System / Component	Causes	Consequence Potential accident/ damage	Severity Level	Probability	Risk Category	Preventive/compensating actions (Design, Maintenance, Operational Safeguards)	Target risk category	Remarks / Documents reference	Comments
Code that univocally identifies the system object of SHA	Numbering for each hazard of the corresponding "hazard type category"	Hazard category in accoding with Hazard List	Numbering for each hazard of the corresponding "hazard type"	Specific description of the generic hazard	Progressive number associated to previous column	<ul style="list-style-type: none"> <li>- Running / Normal operation</li> <li>- Running / Degraded operation</li> <li>- Running / Multiple operation</li> <li>- Running / Emergency operation</li> <li>- Standstill / Parking</li> <li>- Standstill / Stabling</li> <li>- Standstill /Driver cab change</li> <li>- Depot / Manoeuvre</li> <li>- Depot / Maintenance</li> </ul>	System/ subsystem /component from which the hazard originates	Description of the cause that originate the corresponding hazard	Description of the consequences that could occur in case of the corresponding hazard. The subject of the consequences shall be identified.	Severity level category	Estimated Frequency of Hazard	Risk category and acceptance criteria	The preventive and mitigation measures identified in order to reach the Target risk Objective.All the useful Design, Maintenance, Operational safeguards shall be taken into account, and where available, a reference to applicable standards or regulation shall be reported.	Desired risk category and acceptance criteria	Reference to drawings or specification or documents	Any useful comments for a better understanding. For example it shall be highlighted If an hazard needs to be exported to the vehicle builder / train operator



## Corrective Maintenance Analysis

<b>Doc. No</b>		<b>Rev No.</b>	<b>00</b>
<b>Date:</b>			
<b>Project</b>	<b>Vande Bharat Project</b>		
<b>Equipment:</b>			
<b>Supplier:</b>			
<b>Compiled by:</b>			

			REMARKS
Manpower cost		<b>Rs/hrs</b>	
Yearly distance run	<b>3,50,000</b>	<b>km</b>	
LCC period	<b>35</b>	<b>Years</b>	
Fleet (nr. of trains)	<b>80</b>	<b>Trains</b>	



## Preventive Maintenance Analysis

Doc. No		Rev No.	
Date:			
Project	Vande Bharat Project		
Equipment:			
Supplier:			
Compiled by:			

			REMARKS
Conversion speed		km/hrs	
Manpower cost		Rs/hrs	
Yearly distance run	3,50,000	km	
Running days per year		days	
LCC considered period	35	years	
Basic maintenance frequency		km	
Distance covered in the considered period	1,22,50,000	km	
Train-sets number in the fleet	80	Trains	

Name of project <b>Preventive Maintenance results</b>																												Material	ManPower	Total								
System: name of system																		Maintenance time [h]			Train-set level maintenance hours sum				Train / Year													
Material cost [Rs/1000km]	Manpower cost [Rs/1000km]	Total cost [RS/1000km]																Global Manhours [h]			Train-set level manhours sum				Train / Period													
		Vehicle		TRAIN																				Fleet / Period														
RAMS LRU code	Description	Part Number P/N	DTC	MC	TC	NDTC	Total Q.ty	Step N°	Maintenance Level	Maintenance task	Standard Tool	Special Tool	Material	Frequency unit	Multiple	Cancellation per year	Cancellation at life end	Frequency [km]	People	Level	Nr	Failure diagnosis [min]	Integrator accessibility [min]	Supplier accessibility [min]	Change/ Repair/ Functional check [min]	Other activity [min]	n. people OFF train	Off train activity Time [min]	Global Operation Time [h]	Global Man Time [h/man]	Material cost [Rs]	Remark / Note	35	Per Type of Item	Per Type of Item	Per Type of Item		
																																		Years Nr of interventions	Material cost [€ / 1000 km]	Manpower cost [€ / 1000 km]	Total cost [€ / 1000 km]	
1	<b>Equipment / System</b>																																					
	(Sub-Assembly A)																																					
	Item 1																																					
	Item 2																																					
	<b>(Sub-Assembly B)</b>																																					
	Item 3																																					
	Sub-Item 1																																					
	Sub-Item 2																																					
	Sub-Item 3																																					
	Sub-Item 4																																					
	Sub-Item 5																																					
	Sub-Item 6																																					

**Checklist - Documents to be submitted by Bidder**

Sl. No.	Particulars	Acceptable documentation	Submitted with Tender	Document/s submitted by bidder	Remarks by Bidder
1	PQC qualification documentation	<ul style="list-style-type: none"> <li>RDSO/Indian Railways approval for Indian bidders</li> <li>Relevant PO copies</li> <li>Performance statements/certificate</li> </ul>	YES / NO		
2	Type test reports & protocol	<ul style="list-style-type: none"> <li>Recent type test reports from NABL-accredited laboratory and/or protocol for Indian bidders</li> <li>Recent type test reports from international accreditation agencies for international bidders and/or protocol</li> </ul>	YES / NO		
3	Routine test protocol	<ul style="list-style-type: none"> <li>Routine test protocol</li> </ul>	YES / NO		
4	QAP [Quality Action Plan]	<ul style="list-style-type: none"> <li>QAP [Quality Action Plan]</li> </ul>	YES / NO		
5	Clause-by-clause compliance - duly signed & stamped	<ul style="list-style-type: none"> <li>Signed &amp; stamped copy of complete specification</li> <li>Bidder's document tabling each specification clause and indicating the compliance against each clause</li> </ul>	YES / NO		
6	No deviation format - duly signed & stamped	<ul style="list-style-type: none"> <li>No deviation format, duly filled-in &amp; signed/stamped</li> </ul>	YES / NO		
7	Drawings & datasheets if applicable	<ul style="list-style-type: none"> <li>Drawing with all required data &amp; BoM</li> <li>Datasheet with all required parameters mentioned &amp; BoM</li> <li>Catalogue for standard product with all technical &amp; dimensional details mentioned</li> </ul>	YES / NO		
8	HL3 compliance	<ul style="list-style-type: none"> <li>Certificate from NABL approved lab or any International accreditation agency</li> </ul>	YES / NO		
9	Bill of Materials	<ul style="list-style-type: none"> <li>Unpriced copy of price format indicating "Quoted" against each line item</li> </ul>	YES / NO		
10	Spares for 35 years' maintenance requirement	<ul style="list-style-type: none"> <li>Preventive &amp; Corrective Maintenance Schedule with list of spares, in line with Chapter-5 of Technical Specification.</li> <li>Unpriced list of above spares with yearly consumption including replacements.</li> </ul>	YES / NO		
11	Checklist	<ul style="list-style-type: none"> <li>This checklist duly filled-in</li> </ul>	YES / NO		
12	Contact details for correspondence	<ul style="list-style-type: none"> <li>Email &amp; contact details of representative to contact for technical &amp; commercial queries</li> </ul>	YES / NO		
13	Authorization for bid signing	<ul style="list-style-type: none"> <li>Notarized/suitable valued bond paper stating authorization for bid signing</li> </ul>	YES / NO		
14	Formats in tech spec	<ul style="list-style-type: none"> <li>All formats to be filled which are part of the technical documentation .</li> </ul>	YES / NO		
15	RAMS Documentation	<ul style="list-style-type: none"> <li>Sample documents on RAMS compliance (as applicable) as per Chapter-4 of Technical Specification.</li> </ul>	YES / NO		

**Note to bidder -**

1	Bidder shall necessarily fill this checklist and upload it as a part of the documentation towards this tender. Incomplete documentation may make your offer liable for rejection
2	Bidder shall upload the documents in a logical sequence & include a table of content clearly indicating the page numbers
3	This list is not exhaustive & BHEL may ask for additional documentation from bidders in the course of evaluation of the offers