

TD-106-1
Rev No. 5
Form No.



**PRODUCT STANDARD
PULVERISERS
HYDERABAD**

Product
STD no.

BA89244

Rev No. 00

Page 1 of 32

COPYRIGHT AND CONFIDENTIAL
The information on this document is the property of BHARAT HEAVY ELECTRICALS LIMITED,
It shall not be used, disclosed, or disseminated to the extent of the contract.

**TECHNICAL SPECIFICATION
OF
ELEVATOR
FOR
DAY SILO APPLICATION**

RESTRICTED USE





PRODUCT STANDARD PULVERISERS HYDERABAD

Product STD no.	BA89244
Rev No.	00
Page 2 of 32	

CONTENTS:

Sl. No.	Description	Page No.
1.	GENERAL DESCRIPTION OF ELEVATOR (PASSENGER CUM GOODS ELEVATOR)	1
2.	INTENT OF SPECIFICATION	2
3.	APPLICABLE CODES & REGULATIONS	3
4.	PROVENNESS CRITERIA/ PRE QUALIFICATION REQUIREMENT	4
5.	SCOPE OF WORK	4-6
6.	SCOPE OF SERVICES	7
7.	EXCLUSION	7
8.	GENERAL TECHNICAL REQUIREMENTS	8-11
9.	DESIGN CRITERIA	12
10.	ELEVATOR OPERATION AND ITS PARTS	13-18
11.	SUPERVISION OF ERECTION AND COMMISSIONING	19
12.	SPECIAL TOOL AND TACKLES AND SPARES	19
13.	PERFORMANCE GUARANTEE AND SCHEDULE GUARANTEES	19-20
14.	WARRANTY	20
15.	QUALITY ASSURANCE	20
16.	PAINTING SHCDHULE	21
17.	FIRST FILL CONSUMABLE	22
18.	PACKING AND FORWARDING	22-24
19.	TRAINING	24
20.	CONFILCT	24
21.	COMPLIANCE CUM CONFIRMATION CERTIFICATE	24-25
22.	PROJECT INFORMATIONS	25-27
23.	DOCUMENTATION 23.1 TECHNICAL DOCUMENTS TO BE SUBMITTED ALONG WITH THE OFFER. 23.2 DOCUMENTS TO BE SUBMITTED AFTER PO PLACEMENT	27-29
24.	ANNEXURES LIST	29

COPYRIGHT AND CONFIDENTIAL
 The information on this document is the property of BHARAT HEAVY ELECTRICALS LIMITED,
 It shall not be read, disclosed, or in any way disseminated to the extent of the contract.





PRODUCT STANDARD

PULVERISERS

HYDERABAD

Product STD no.	BA89244
Rev No.	00
Page	3 of 32

1. GENERAL DESCRIPTION OF ELEVATOR (PASSENGER CUM GOODS ELEVATOR)

Passenger elevator shall be provided for access to various operating floors / platforms in Lime stone day silo & Wet Ball Mill building for FGD Package to facilitate movement of material and personnel for operation and maintenance purpose.

2. INTENT OF SPECIFICATION

This specification specifies the requirement of Design, Engineering, Manufacturing, Assembling, Inspection, Shop Testing, performance testing at manufacturer's works, properly packed & delivery at site, Erection & Commissioning, Testing of Passenger cum Goods Elevator at the site and final handing over to the customer, complete with all accessories as specified in the scope of work and as required for the safe and trouble-free operation of equipment to be installed at the site. Which is to be furnished in the limestone Silo building in the FGD plant.

- 2.1 Bidder shall assume full unit responsibility for the entire equipment assembly and make all possible efforts to comply strictly with the requirements of this specification and other specifications/attachments to inquiry/order.
- 2.2 The Bidder shall offer only proven design which meets the Proven-ness criteria indicated in the clause no: 4.0 of this specification. Necessary document evidences shall be submitted along with the bid. If bidder doesn't meet the specified proven-ness criteria, they are denied to participate in this tender.
- 2.3 In case, deviations are considered essential by the Bidder (after exhausting all possible efforts), the same shall be separately listed and submitted along with the offer.
- 2.4 No deviation or exception shall be permitted without the written approval of the purchaser.
- 2.5 Compliance to this specification shall not relieve the Bidder of the responsibility of furnishing equipment and accessories/auxiliaries of proper design, materials and workmanship to meet the specified start up and operating conditions.
- 2.6 In case, the Bidder considers requirement of additional instrumentation, controls, safety devices and any other accessories/auxiliaries essential for safe and satisfactory operation of the equipment, the same shall be recommended along with reasons in a separate section and include the same in scope of supply.
- 2.7 All accessories, items of work, though not indicated but required to make the system complete for its safe, efficient, reliable and trouble free operation and maintenance shall also be in supplier's scope unless specifically excluded.

3. APPLICABLE CODES & REGULATIONS

The Elevators shall be designed in line with the recommendation contained in the latest editions of Indian Standards. IS:14665 (All parts) and also meeting any additional requirements of IS:4666, IS:1860 and IS:3534 and Any other equivalent code/standards/safety procedures not listed above, but required to be followed, for supplying the unit as defined in the specification, shall be complied with by the vendor subjected to customer / BHEL approval.

COPYRIGHT AND CONFIDENTIAL
The information on this document is the property of BHARAT HEAVY ELECTRICALS LIMITED,
It cannot be used, copied, disseminated, or otherwise distributed without the written consent of the company.

RESTRICTED USE





PRODUCT STANDARD

PULVERISERS

HYDERABAD

Product STD no.	BA89244
Rev No.	00
Page 4 of 32	

4. PROVENNESS CRITERIA/ PRE QUALIFICATION REQUIREMENT:

Refer PQC Document No: BA89210-R00

5. SCOPE OF WORK

- 5.1.1 Design, engineering, manufacture, inspection, delivery, erection, commissioning, testing and handing over.
- 5.1.2 Maintenance & services during guarantee period.
- 5.1.3 Necessary erection / commissioning spares and consumables shall be included in vendor scope.
- 5.1.4 Necessary tools and tackles required for maintenance, testing and inspection shall be covered in vendor scope.
- 5.1.5 Necessary chain and pulley block along with hand operated geared trolley arrangement for horizontal movement across the monorail, hoist, rope and hook arrangements at the machine room ceiling to carry out the erection and maintenance of equipment shall be supplied by Elevator vendor. The necessary mono-rail beam will be supplied by purchaser (BHEL).
- 5.1.6 A steel ladder for access to the pit shall be supplied by the Elevator vendor.
- 5.1.7 Guard to protect the hoist way including temporary barricades at hoist way openings shall be supplied by Elevator vendor. Supporting steel material between hoist way & car will be provided by vendor.
- 5.1.8 Scaffolding as per erection requirement shall be provided by the Elevator vendor. After completion of handing over activities, the scaffolding materials may be taken back by the vendor.
- 5.1.9 All the electrical equipment including Lift well, Hoist way & machine room lighting with fittings, Power/control/trailing cables, MCCB/MCB & ELCB for 415 V AC 3ph supply and 240 V AC single phase supply (to receive the incoming feeders provided by customer) shall be included in the Elevator vendor scope.
- 5.1.10 The vendor shall assume all responsibility for proper design and operation of each and every component of the elevator as well as the elevator as a whole. Complying with Indian electricity rules & Indian electricity acts and applicable statutory requirements (of Government of India and applicable States) as well as procedural formalities also shall be taken care by the Elevator vendor.

i. Elevator shall include but shall not be limited to the following: -

- 5.2.1 Elevator car with SS 304, 1.5 mm (min) thick sheet of hair line finish for FGD Control building.
- 5.2.2 Guide rails for car and counterweights.
- 5.2.3 Counterweight.
- 5.2.4 DCEM brakes.
- 5.2.5 Spring buffer for car and counterweight.
- 5.2.6 Driving arrangement including motor, gear box, sheaves etc.
- 5.2.7 All electrical equipment including power cable, control cable, controller panel, safety devices including push buttons, limit switches, safety switches, indicators etc.
- 5.2.8 Isolating switch / MCBs.

COPYRIGHT AND CONFIDENTIAL
The information on this document is the property of BHARAT HEAVY ELECTRICALS LIMITED,
It shall not be used, copied, reproduced, disseminated or in any way disclosed to the extent of the document.

RESTRICTED USE





PRODUCT STANDARD PULVERISERS HYDERABAD

Product STD no.	BA89244
Rev No.	00
Page 5 of 32	

COPYRIGHT AND CONFIDENTIAL
 The information on this document is the property of BHARAT HEAVY ELECTRICALS LIMITED,
 It shall not be used, disclosed, or disseminated in any manner, without the written consent of the company.

- 5.2.9 Car doors, car ceiling and hoist way doors of SS 304, 1.5 MM (min) thick sheet of hair line finish.
- 5.2.10 Car operating panel, digital control, car position indicator at all floors, luminous hall buttons, auto door operating mechanism, alarm bell, car light & car fan.
- 5.2.11 Intercom connection through EPABX or PA which shall be finalized during contract stage.
- 5.2.12 Ropes for hoisting.
- 5.2.13 Circuit breaker, switch fuse unit etc. in machine room for terminating the power supply cable (power supply cable provided by purchaser up to machine room level), other power/control and trailing cabling and equipment earthing.
- 5.2.14 Ladder in pits.
- 5.2.15 Emergency light with rechargeable battery.
- 5.2.16 All fixing materials require fixing rails, brackets, equipment including nuts and bolts.
- 5.2.17 Fascia plates (750 mm minimum) & sill angels.
- 5.2.18 Full length infra-red Curtain safety feature in door along with pressure limiter as an extra mechanical safety.
- 5.2.19 ELCB if required as per statutory requirement.
- 5.2.20 Any other equipment required to meet the requirement of local statutory and regulatory body and prevailing lift etc.
- 5.2.21 Car lighting, LED light fittings for illumination level of 100 lux on car floor.
- 5.2.22 Elevator shaft, pit cable conduit fixtures, switches 3 pin or as required by bidder during erection / maintenance purpose at every 3 m.
- 5.2.23 Mirror for the car rear panel.
- 5.2.24 Floor announcement cum music system to be provided.
- 5.2.25 Maintenance tools and tackles along with un-priced list with the offer.
- 5.2.26 Three (3) sided SS- mirror finish hand railing at suitable height.
- 5.2.27 Minor civil work including grouting as well as foundation bolt grouting as required during installation of elevator.
- 5.2.28 Scaffolding for erection.
- 5.2.29 Automatic rescue device with battery drive - Modern advanced electronic drive system of rescuing passenger trapped in an elevator shall be provided.
- 5.2.30 Emergency safety devices - The lift shall be provided with safety device attached to the lift car frame and sustaining the lift car up at governor tripping speed with full rated load in car.
- 5.2.31 All steel embedment for fixing landing doors / indicators etc. to the elevator well shaft and fascia plate shall be supplied by the bidder
- 5.2.32 Guide rails complete with supporting brackets for the car and counter weights.
- 5.2.33 Elevator drive machines complete with electric motor, reduction gear unit, suspension ropes, buffers for the cars and the counter weights and other drives and control mechanism. All foundation anchor bolts, sleeves, anchoring steels and any item required to complete the job satisfactorily shall be provided by the bidder. The bidder shall also provide for the grouting of anchor bolts, sleeves, anchoring steel etc. and other anchorages.





PRODUCT STANDARD

PULVERISERS

HYDERABAD

**Product
STD no.**

BA89244

Rev No. 00

Page 6 of 32

- 5.2.34 Any other steel works as well as all other accessories / components not specified in the technical specification but necessary for making the elevator complete.
- 5.2.35 All minor building works including the supply of steel items, associated with installations of equipment's in the machine room hoist way, hoist way door, frames and elevator pit, shall form part of bidder's scope of supply, BHEL / customer will provide the elevator well complete with foundation and brick walls around the lift well together with overhead machine room. The machine room will be provided with RCC floor slab with necessary pockets for anchor bolts and slots.
- 5.2.36 Dummy landing/s, as required in case travel between two consecutive landings is more than 10 m, shall be considered by bidder in his offer.
- 5.2.37 Any other requirement stipulated by state statutory body and prevailing local lift act requirement shall also to be included by bidder in their scope.
- 5.2.38 Bidder shall use latest IS 14665 (all parts) for outline dimensions of elevator & shaft, installation, operation, maintenance & inspection and testing and for elevator components design.
- 5.2.39 Electric hoist with travelling trolley of 3T capacity to facilitate handling of equipment in the machine room.
- 5.2.40 Mandatory spare as per Annexure-I (Not applicable) & Special tools and Tackles to be indicated by bidder in Annexure-II.

NOTES:

- a. Flooring for all elevators shall be PVC tiles as indicated in the Data sheet.
- b. Functional Guarantee test shall be carried out at site for over speed test and over load test, travel and hoist speed checks as per latest IS.
- c. Car, landing door and car ceiling shall be of SS-304 sheet with thickness (min) 1.5 mm.
- d. Min dimensions as specified in applicable IS 14665 (all five parts) shall be considered / provided for lift shaft / pit / car / M/c Room. Safety requirement shall be as per latest IS 14665 (Relevant part). Bidder to refer the layout attached in the specification for different buildings.
- e. Elevators pit shall be bare pit (i.e. pit without any RCC block / pedestal for buffer for CAR & CWT). Accordingly, MS structure & buffer required for elevator resting shall be provided by bidders.
- f. All Equipment's / facilities needed for erection & commissioning shall be in bidder's scope.
- g. Bidder to note that all LT Power cables (Fixed power and control cables etc), Trailing cable and instrument / signal cable for elevator shall be as per electrical specification. Trailing cable shall be FRLS type (with strain bearing member).
- h. Make of various bought out items & QAP shall subject to approval of BHEL / Customer during detail engineering stage without any commercial implication at contract stage.
- i. Bidder shall supply erection and commissioning spares as required during E&C stage without any commercial implication.



PRODUCT STANDARD

PULVERISERS

HYDERABAD

**Product
STD no.**

BA89244

Rev No. 00

Page 7 of 32

- j. Car frame and structure (guide brackets, supports, MS structure for buffer for CAR & CWT etc) shall be painted with epoxy based paint for all elevators.
- k. Protection class for motor shall be IP 54 and main control panel shall be min IP 54 and elevator control shall be VVVF type. Push buttons, Car operating Panel, Landing Operating Panel, Landing door motor and other equipment shall be IP-54.
- l. Factor of safety for rope shall be 12 (min).
- m. All Landing door shall be fire rated for at min 2 hour or as per latest IS / as per the state statutory requirement whichever is more stringent.

6. SCOPE OF SERVICES

Scope of services will broadly include the followings: -

- 6.1 Complete erection, testing and commissioning including all testing and commissioning materials, consumables and other tools and tackles required for erection of complete elevator package.
- 6.2 Unloading, storage, handling and transportation at site for all items of elevator.
- 6.3 Minor civil and structural works shall be carried out by the bidder if required at site for which no additional commercial implication shall be entertained by BHEL.
- 6.4 Necessary consumables and instrumentation as required for inspection and testing at works as well as at site including pre-commissioning activities, if any, shall be arranged by the successful bidder at their own cost.
- 6.5 Functional testing of complete elevator package.
- 6.6 Preparation of civil input drawings including elevator pit, shaft, machine room etc.
- 6.7 Preparation of all necessary drawings / data sheets / documents / calculations as required for obtaining necessary local administration permits / approval from statutory authority and make arrangements for inspection and tests required thereby for necessary approval on behalf of the customer. Fees as required for obtaining approval from statutory bodies shall also be included in the scope of work of the bidder.
- 6.8 Any other service as required for making the installation complete in all respect and satisfactory erection and commissioning of the system.
- 6.9 Relevant requirements as per GCC, ECC & SCC.
- 6.10 Split Air conditioner of min 2 Ton capacity in the machine room which includes fans, air filter and accessories to prevent dust ingress in the machine room. However, successful bidder shall furnish the heat load calculation and capacity of air conditioner after considering all actual heat loads of elevator machine room during detail engineering stage for selection of final capacity of air conditioner.
- 6.11 1/2 Kg CO2/suitable type Fire extinguisher in bidder scope. Fixing arrangement shall be provided in Car accordingly.

7. EXCLUSION

Works not included in elevator contract, but furnished by others in accordance with local codes and regulations and



PRODUCT STANDARD

PULVERISERS

HYDERABAD

**Product
STD no.** BA89244

Rev No. 00

Page 8 of 32

the approved drawing of the Elevator vendor.

- 7.1 Complete civil works for hoist way, machine room, pit complete with the side enclosure (cladding/brick / RCC), interconnecting platform (if any) and monorail beam.
- 7.2 Steel structures for Columns and associated bracings and approach platforms up to landing doors at each level.
- 7.3 Power supply cable (AC 415 V, 3 Ph, 50 Hz) up to elevator area (Ground level by BHEL). Further cabling (all cables including power, control and instrumentation as per tender specification) shall be provided by the bidder.

8. GENERAL TECHNICAL REQUIREMENTS

Sl. No	Description	Vendor to confirm
1.	Descriptions in the drawings, in the documents, and in the displays shall be in English	
2.	Bidder shall submit instruction manual for all the equipment's covered under the scope of bidder as per agreed engineering schedule. The instruction manuals shall contain full details required for erection, commissioning, operation and maintenance of each equipment. The manual shall be specifically compiled for this project. The erection portion of manual shall contain erection strategy, sequence of erection, erection instructions, critical checks (along with permissible deviations/tolerance), Bill Of Materials, procedure for erection, general safety procedures to be followed. Procedure for initial checking after erection, procedure for testing (along with acceptance norms) check list for commissioning/pre-commissioning activities, List of tools and tackles. All the manuals shall be two rim PVC bound stiff sided binder able to withstand constant usage. The cover shall be printed with project name.	
3.	Portable guards shall be provided for protection of personnel on all exposed rotating and /or moving machine parts. All such guards shall be designed for easy installation and removal for maintenance purpose.	
4.	Any item not included above but necessary for safe and reliable operation of the passenger cum goods elevator system proposed by the supplier shall also be in the suppliers' scope.	
5.	The elevator shall be designed to withstand the corrosive and moist environment in which these are proposed to operate.	
6.	Suppliers shall suitably specify their delivery schedule along with the offer and Standard code specified shall be strictly adhered.	
7.	Quality Plan to be submitted along with the offer.	
8.	Cost towards the participation in discussions/meetings, providing technical assistance during technical discussions/meetings with customer for approval of drawing/documents etc. TA/DA, boarding and lodging to attend these meetings shall be borne by the bidder and shall be inclusive in supply portion.	
9.	Material of construction for all equipment/components shall be subject to CUSTOMER/ BHEL approval during detail engineering. Accordingly, bidder shall	

COPYRIGHT AND CONFIDENTIAL
 The information on this document is the property of BHARAT HEAVY ELECTRICALS LIMITED,
 It cannot be used, copied, disseminated, or in any way disclosed to the extent of the document.





PRODUCT STANDARD

PULVERISERS

HYDERABAD

Product STD no.	BA89244
Rev No.	00
Page 9 of 32	

COPYRIGHT AND CONFIDENTIAL
 The information on this document is the property of BHARAT HEAVY ELECTRICALS LIMITED,
 It shall not be read, disseminated, or in any way distributed to the extent of the contract.

Sl. No	Description	Vendor to confirm
	consider MOC for all equipment/component as per best engineering practice.	
10.	Bidder to provide sub vendor list and Bidder shall strictly adhere to CUSTOMER approved vendor list. In case bidder proposes an additional vendor for an item or vendor approval is required for any new item, acceptance shall be subject to approval by CUSTOMER/ BHEL before placing order and bidder shall submit relevant documents as per sub-supplier questionnaire attached in enclosed.	
11.	It shall be the complete responsibility of the successful bidders to obtain "Sub Vendor Approval" from BHEL / CUSTOMER for all equipment's & components. Any delay in sub vendor's approval should not affect the project schedule. If any of the sub vendors does not have the approval of CUSTOMER/ BHEL, the same may be replaced with another CUSTOMER/BHEL approved sub-vendor only, without any price implications to BHEL.	
12.	The modalities of inspection (Stage, Final, In-process) shall be finalized during detail engineering after submission of quality assurance plan (QAP). It shall be reviewed by the CUSTOMER/ BHEL. Bidder shall follow the procedures of inspection as per CUSTOMER/ BHEL approved QAP. Bidder has to submit the following documents along with inspection call and if any other documents required as per approved QAP. <ul style="list-style-type: none"> - Raw material inspection certificate - Internal test reports - Statutory certificates as required. - All inspection & testing shall be carried out based on the following documents: <ul style="list-style-type: none"> a. Relevant Standards b. Specifications c. Approved drawings d. Data Sheets e. Calibration certificate for all the measuring instruments f. Bidder should also coordinate in getting the MDCC's (Material Dispatch clearance certificate) and all types of IC's (Inspection Certificates) from the CUSTOMER along with BHEL. 	
13.	During detail engineering, bidder to strictly adhere to BHEL/CUSTOMER drawing formats, document numbering, quality plan formats	
14.	Complete detail engineering drawings, calculations, selection of components etc. shall be reviewed & subject to approval of BHEL/CUSTOMER during detail engineering	
15.	Bidder shall furnish necessary inputs & drawings of all equipment in editable Auto CAD/ MS-Word /Excel format.	
16.	During detail engineering, successful bidder shall ensure flow of drawings/documents as per schedule. Any comments from BHEL/CUSTOMER should be addressed	

RESTRICTED USE





PRODUCT STANDARD
PULVERISERS
HYDERABAD

**Product
STD no.**

BA89244

Rev No. 00

Page 10 of 32

COPYRIGHT AND CONFIDENTIAL
 The information on this document is the property of BHARAT HEAVY ELECTRICALS LIMITED,
 It shall not be used, disclosed, or in any way disseminated to the extent of the contract.

Sl. No	Description	Vendor to confirm
	timely by the bidder.	
17.	Characteristic curves of all motors shall be furnished by the bidder during detail engineering stage for approval showing torque, speed, current and voltage.	
18.	Complete elevator installation shall be in accordance with the requirements of concerned approving authority.	
19.	In case of any contradictory requirement amongst the various clauses within the specification and clarifications not having been sought by the bidders, the most stringent requirement as per interpretation of BHEL's engineer shall be final and binding on the bidder for which BHEL will not entertain any commercial implication.	
20.	Data sheets of various items shall be prepared by the bidder and shall be submitted to BHEL / customer / consultant for approval after placement of order and any changes required by BHEL / customer / consultant for the same shall be incorporated and adhered by the bidder without any commercial implications.	
21.	GA drawing indicating design data, material of construction etc. shall be prepared by the bidder during detail engineering stage based on specification / contractual requirement and there should be no commercial implication on account of finalization of the drawings and documents.	
22.	Field quality plan / quality assurance plan / check list shall be prepared by the bidder for each item of elevator and shall be submitted to BHEL / customer / consultant for approval after placement of order and any changes required by BHEL / customer / consultant for the same shall be incorporated and adhered by the bidder without any commercial implications	
23.	All possible efforts shall be made by the bidder to get the approval of drawings and documents from BHEL / customer / consultant at the earliest and the documents prepared / generated by them or their sub-vendors shall be checked by their competent authority before submission to BHEL.	
24.	Revision made by the bidder in any drawings and documents shall be highlighted by indicating the no. of revisions in a triangle without fail so that the minimum time is required by BHEL to review the drawings and documents.	
25.	Bidder to note that all the drawings shall be prepared in Auto Cad – 2013 and above version and required number of hardcopies and soft copies shall be furnished to BHEL during detailed engineering stage. Exact requirement of number of hard copies and soft copies of all drawings and documents as required by BHEL / customer / consultant shall be informed to the successful bidder during detail engineering stage and bidder to furnish the same for which no additional cost shall be entertained.	
26.	Civil works will be provided by BHEL / customer. Hence, bidder has to furnish the civil inputs in time. Bidder has to carry out the rectification in the civil works in the event of any changes in the civil input data furnished by them or delay in submission of input data by them. Bidder to furnish the civil input drawing along with the loading data for approval during detailed engineering stage showing / indicating the followings: a. Scope of work by BHEL and bidder shall be indicated with different legend or in	





PRODUCT STANDARD

PULVERISERS

HYDERABAD

**Product
STD no.**

BA89244

Rev No. 00

Page 11 of 32

COPYRIGHT AND CONFIDENTIAL
 The information on this document is the property of BHARAT HEAVY ELECTRICALS LIMITED,
 It shall not be used, disclosed, or disseminated in any form, or by any means, without the prior written consent of the company.

Sl. No	Description	Vendor to confirm
	the form of note. b. Recommended locations of earthing pads. c. Civil loads along with detailed calculation of loading. d. Details of pockets / cut outs as required for anchor bolts.	
27.	Bidder to depute competent designer (s) at BHEL's office during detailed engineering stage to discuss drawings and other technical documents as and when required by BHEL.	
28.	All the drawings which are required to be furnished to BHEL during detailed engineering stage shall include technical parameters, details of paints, BOQ / BOM etc in tabular form indicating all components including bought out items and their quantity, material of construction indicating its applicable code / standard, weight, make etc.	
29.	All drawings and documents including general arrangement drawing, data sheet, calculation etc. shall be furnished to BHEL during detailed engineering stage and shall include / indicate the following details for clarity w.r.t. inspection, construction, erection and maintenance etc.: -	
30.	All drawings and documents shall bear BHEL's title block and drawing / document number.	
31.	All drawings and documents shall indicate the list of all reference drawings including general arrangement.	
32.	All drawings shall include / show plan, elevation, side view, cross - section, skin section, blow - up view, all major self-manufactured and bought out items shall be labeled and included in BOQ / BOM in tabular form.	
33.	Bidder to assess the capability of their sub-vendors in terms of preparation of drawings, calculations, documents, quality assurance, supply of material etc. as per project schedule before placing the order on them. No deviations shall be entertained.	
34.	Delivery schedule, list of drawings and documents including data sheet, manual calculation, quality plan, field quality plan, PG test procedure, list of sub - vendors (mechanical, C & I and erection and commissioning), technical specification and material of construction, painting specification / schedule, dispatch schedule etc. of various items as required by BHEL / customer / consultant shall be submitted to BHEL / customer / consultant during detail engineering stage for approval and the approved drawings / documents shall be adhered by the bidder without any commercial implication.	
35.	List of commissioning spares and tools and tackles in terms of numbers shall be furnished by the bidder along with the offer.	
36.	Bidder to note that list above is not exhaustive and any work /items required for completing the smooth operation and ensuring satisfactory running of the machines till final hand over to the end user (CUSTOMER) shall also be in the scope of the bidder.	



TD-106-1
Rev No. 5
Form No.



PRODUCT STANDARD PULVERISERS HYDERABAD

Product
STD no.

BA89244

Rev No. 00

Page 12 of 32

Sl. No	Description	Vendor to confirm
37.	Bidder shall submit the signed and stamped copy of all the pages which constitutes this technical enquiry specification signed by authorized signatory.	

COPYRIGHT AND CONFIDENTIAL
The information on this document is the property of BHARAT HEAVY ELECTRICALS LIMITED,
It shall not be read, disclosed, or in any way disseminated to the extent of the contract.

RESTRICTED USE





PRODUCT STANDARD

PULVERISERS

HYDERABAD

Product
STD no.

BA89244

Rev No. 00

Page 13 of 32

9. DESIGN CRITERIA

The design criteria and equipment specification will be as follows:

i)	Type of service	Passenger cum Goods Elevator
	Design Standard	As per code mentioned in Cl. No. 3.0
	Area Classification	Safe Area
	Type of Elevator	Machine Room traction type, Geared Motor or Motor with Gearbox Type Passenger elevator
	Position of machine room	Directly above the lift shaft
	Machine room and lift shaft	One No. adequately sized, air conditioner each having minimum cooling capacity of 2.5 Ton (split type) shall be provided for elevator machine room to make it dust proof.
ii)	Number required	1 No.
iii)	Load on the Elevator	Minimum 1000 Kgs
iv)	Rated speed	1.0 meter/s
v)	Total travel and No. of floors to be served (Landing levels)	Please refer clause number 23. Project information.
vii)	No of Opening	One number in each floor
viii)	Method of control Motor Speed Control: Logic Control:	Variable Voltage variable frequency (VVVF) control. Microprocessor based Control with automatic level adjustment. The control system shall be of field proven design and having satisfactory track record.
	Car entrance and landing doors	As per BS:476 (Part 20 & 22) And Minimum 1500 mm (W) and 2000 mm (H)
ix)	Flooring of Car	Chequered plate (6 mm thick). Car floor shall comprise of a smooth nonslip surface.
	Door construction	Hollow metal construction form 16 gauge thick steel sheet spray painted
xi)	Design, construction and finish of car	SS (ASTM-304 No: 4 Hairline finish)
xii)	Car door	SS (ASTM-304 No: 4 Hairline finish)
xiii)	Landing door	MS sheet fabricated, smooth finish, spray painted to approved shade.
xiv)	Car Enclosure	SS (ASTM-304 No: 4 Hairline finish)
xv)	Lighting and fan in the car	Recessed fluorescent light fittings for illumination level of 100 lux on Car floor shall be provided. Cabin charger ventilation fan with control suitable for operation on 240 V, 50 Hz, AC single phase power supply shall be provided. Portable light shall be



PRODUCT STANDARD

PULVERISERS

HYDERABAD

Product STD no.	BA89244
Rev No.	00
Page 14 of 32	

COPYRIGHT AND CONFIDENTIAL
The information on this document is the property of BHARAT HEAVY ELECTRICALS LIMITED,
It cannot be used, copied, disseminated or in any way determined to be the interest of the company.

		provided on Car top. Adequate ventilation and illumination of car to be ensured.
xvi)	Method of operation of car	Power operated type – automatic, Horizontal Centre opening / closing car and landing doors.
xvii)	Operation of Elevator	Automatic, simplex, selective, collective with and without attendant, through illuminated pushbutton station located inside the car with provision for locking control in Auto or attendant position.
xviii)	Signals / Indicator	a) Car position informer in car both visual and audio, hall position indicator at all floors, telltale lights at all floors, battery operated alarm bell and emergency light with suitable battery, charger & controls. b) Soft touch keys and digital luminous display in car operating panel and on all floors landings. (All fixtures in stainless steel face plates). Battery operated alarm bell and emergency light with suitable battery and battery charger and controls. Audio annunciation for car position indication shall also be provided inside the car. Overload warning indicator with visual & audio annunciation.
	Power supply to Elevator	BHEL will terminate one 3-phase supply and one single-phase supply near to Limestone Silo building ground floor. Terminal box in each floor or at necessary location, circuit breaker, and other electrical protections are to be included in Bidders Scope.
xix)	Shaft lighting	The Elevator shaft shall be suitably illuminated by providing CFL fittings at every 3m (three meters) from bottom of Lift well.

Note:

- 9.1 The rated speed will be 1.0 m/sec. Proper allowance will be made for impact and wear and the factor of safety for rope shall not be less than twelve (12) or as per IS 14665 (all parts). The suspension wire rope will confirm to IS-14665 or approved equivalent international standard.
- 9.2 The lift will be providing with automatic travelling device which will take care of overrun and under run of the car and rope stretch that the car floor is within 6.0 mm from the landing level at the floors while in operation.
- 9.3 The lift will be equipped with upper and lower terminal switches arranged to stop the car automatically within the limit of the top car clearance and bottom run-by, from the any normal operating speed.
- 9.4 The elevator car shall be provided with SS-304 sheet fabricated, hair line finished to approved shade (including landing doors of the car). PVC tile flooring as indicated in the data sheet - A, concealed fan and indirect lighting, emergency lighting, intercom, car position and travel direction indicator.
- 9.5 As the elevator is to provide service in a power station, it is necessary for the equipment to be specially coated (painted). This will include application of anticorrosive paint as applicable. The electrical equipment will have enclosures meeting degree of protection as covered under electrical specification.
- 9.6 The elevator as a whole will comply with relevant Indian Standard i.e. 14665 or approved international standard. The outline dimensions of electric lift shall meet the requirements of IS 14665 (latest edition).
- 9.7 The elevator shall be provided with AC VVVF type drive control system.

RESTRICTED USE





PRODUCT STANDARD

PULVERISERS

HYDERABAD

Product STD no.	BA89244
Rev No.	00
Page	15 of 32

9.8 Doors are automatic, center opening with emergency key opening at all landings, horizontal sliding type for car as well as for hoist way. Trap door for each elevator in machine room shall be provided by civil contractor as per IS-14665 (latest edition).

10.0 ELEVATOR OPERATION AND ITS PARTS

10.1 ELEVATOR OPERATION

Elevator shall have provision to meet followings operational requirements: -

- a. Selective simplex / duplex collective, automatic operation with or without attendant through illuminated push button station located inside the lift car.
- b. Door operating shall be automatic door operation and electronic door protection system for opening / closing of car and landing doors.
- c. Bidder shall provide car operating panel with luminous buttons, car position indication in car (both visual and audio) combined with direction arrows, overload warning indicator, battery operated alarm bell and emergency light and fan and hands free speaker telephone set with suitable battery, charger and controls.
- d. Bidder shall provide emergency indicator to indicate the location of elevator in case of elevator being stuck up between the floors through automatic flashers/ display (both audio and visual as out of service).
- e. Two (2) push buttons, one for upward movement and the other for downward movement at each intermediate landing and one (1) push button at each terminal landing shall be provided in order to call the car. Digital hall position indicator at all floors, tell lights at all floors shall also be provided by the bidder.
- f. All fixtures shall be in stainless steel face plates.
- gg. Push buttons shall be fixed in the car for holding the door open for any length of time required.
- h. All other safety / protection / operation interlocks as required by IS – 14665 (all parts) latest edition.

10.2 MECHANICAL PARTS

10.2.1 ELEVATOR CAR

The car platform frame and sling shall be of steel construction. The platform shall be suitably isolated from its sling. The car shall be enclosed with suitably braced and reinforced sheet metal panel. The sheet metal panel shall have ventilation slots at the base. The car interior, the car doors and the landing doors shall be finished with two coats of baked enamel. All other exposed steel or cast surfaces shall be painted with one coat of suitable metal primer and two coats of machinery enamel paint. The car shall be provided with the following accessories:

- a. Car control station with position indicator inside the car and at landing platforms.
- b. An emergency stop switch (shall have two sets of potential free contact. Second one shall be taken and terminated in machine room for further connection by owner). This is as per IS 14665 Part 2 Amendment 3 Clause 9.6 -“An emergency stop switch, of manually opened and closed type, shall be provided on top of every lift car and shall be marked conspicuously”.
- c. A three pin plug & socket with switch on top of Elevator car for use by persons working there on.
- d. Telephone instrument shall be provided inside the car. Connection from the same shall be brought up

COPYRIGHT AND CONFIDENTIAL
The information on this document is the property of BHARAT HEAVY ELECTRICALS LIMITED,
It cannot be used, copied, disseminated or otherwise disclosed without the consent of the company.





PRODUCT STANDARD

PULVERISERS

HYDERABAD

Product STD no.	BA89244
Rev No.	00
Page 16 of 32	

COPYRIGHT AND CONFIDENTIAL
The information on this document is the property of BHARAT HEAVY ELECTRICALS LIMITED, Hyderabad. It should not be used, disclosed, reproduced, distributed, or otherwise disseminated to the extent of the document.

- to the machine room for further connection to plant network by customer. Telephone instrument provided inside the car shall have provision for hands free operation also, i.e. Speaker phone shall be provided for hands free operation.
- e. For better safety, elevator vendor to provide car top barricade on car top to ensure that service personnel stay inside the car region. A selector switch and a set of push buttons shall be provided on the top above the ceiling of the car to operate the elevator locally for inspection and maintenance. The selector switch when set to position “inspection” shall exclude control from other places and movement of the car in the desired direction shall be effected by the push buttons. For normal operation of the elevator, the selector switch shall be set to the position working. It shall be possible to operate the elevator only when the appropriate button is kept in pressed condition. The roof shall be strong enough to support at least two persons.
 - f. Adequate lighting and ventilation shall be provided in the Elevator car. The car shall be fitted with fan of adequate capacity and lighting with decorative fittings. The car platform shall be robust in construction and elegant in appearance.
 - g. The car shall be provided with an emergency alarm push button inside the Elevator car which shall be clearly marked. The alarm shall be clearly audible outside the Lift way in order to obtain assistance in case of breakdown or failure between the floors.
 - h. Car shall be equipped with handrails on three sides.

10.2.2 CAR DOOR

The car door shall be of hollow metal construction minimum 16 gauge thick sheet steel. Sides of the door shall be flush with all seams continuously welded. Guide shoes shall be rubber or roller type designed for operation on unlubricated guides. The car door shall be provided with locking gear of heavy and robust construction, so arranged mechanically and interlocked that the doors cannot be opened unless the Elevator car is within a particular landing zone. Conversely the Elevator shall not move until all the landing doors are closed and interlocked properly. Width of Car Entrance shall be min 1000 mm or as per applicable Indian or International Standard for Passenger cum Goods Elevator. The live load shall be taken into consideration while designing doors, door frame and hanger tracks. The car doors shall be designed such that their closing and opening is not likely to injure a person. A retractable safety shoe shall extend the full height and project beyond the front edge of the car, to open the closing door if and when it touches a person or an object. Alternatively opening of car by means of optical sensing shall also be provided.

10.2.3 LANDING DOOR

All landing openings in the Lift well enclosure shall be protected with doors which shall extend the full height and width of the landing opening. The type of door provided shall be similar to the Elevator car door. Every landing door shall be fitted with a locking device. The door shall be suitably interlocked so that they cannot open unless the car is within a particular landing zone. The locking device is closed until the door is closed. The levers operating the locking devices shall not interfere with the landing side or Elevator enclosures. Landing doors of the elevators shall have fire resistance of at least one hour. These doors shall also be smoke tight as far as possible.

10.2.4 LOAD PLATE

A load plate displaying the rated load of the Elevator in terms of persons and kilograms shall be fitted in the car in a conspicuous position.

10.2.5 SUSPENSION ROPES

RESTRICTED USE





PRODUCT STANDARD

PULVERISERS

HYDERABAD

Product STD no.	BA89244
Rev No.	00
Page	17 of 32

The car and the counter weights shall be suspended by steel wire ropes. Chain shall not be used for suspension. Not less than four independent stranded steel wire suspension ropes shall be used for car or counter weights of the Elevator with traction drive. The minimum diameter of the stranded rope shall not be less than 12.5 mm and minimum factor of safety shall not be less than 12mm. The suspension ropes shall conform to latest edition of IS 2365 – “Specification for steel wire suspension ropes for Lifts and hoists”.

10.2.6 SHEAVES & PULLEYS

All driving sheaves and pulleys fixed to and revolving with the shaft shall be fixed by means of sunk keys of sufficient strength and quality. Sheaves and pulleys shall be made of cast iron as per the latest edition of IS 14665 and free from cracks, sand holes and other injurious defects. They shall have suitable flanges and smoothly machined rope grooves. The diameter of the sheave or pulley shall be as specified in the latest edition of IS 14655 or equivalent International Standards.

10.2.7 SHAFT

Shafts and axles shall be forged steel. They shall have sufficient rigidity and bearing surface. Any shaft when stepped shall be turned to a reasonable radius at the point of reduction.

10.2.8 COUNTER WEIGHTS

The Elevator shall be provided with suitable counter weights located in the Lift shaft. The counter weight shall be designed for smooth and easy operation of the Elevator and shall be in accordance with Indian Standard (or) equivalent International Standard. Suitable counter weight screen shall be provided in the Elevator shaft. The counter weights shall consist of cast iron weight contained in structural steel frame. The traction should be such that no appreciable slip may occur but that slip shall be free to take place upon the landing of either the car or the counter weights.

10.2.9 GUIDE RAILS

Guide rails for the car and counter weights shall be machined ‘T’ sections and continuous throughout the entire length and shall be provided with adequate steel brackets or equivalent fixing of such design and spacing between brackets shall be such that to avoid any deflection during the normal operation. Guide rails section shall be adequate to withstand the forces resulting from the application of the safety gear when stopping the counter weights or fully loaded car. The guide shoes or their lining shall be easily renewable, adjustable and self-lubricated. Guides shall be of such length that it shall not be possible for any of the car or the counter weight shoes to run off the guides.

10.2.10 BUFFERS

Sufficient number of buffers of spring loaded type shall be fitted below the Elevator car and counter weights. The buffers shall be capable of stopping the car or counter-weights without permanent damage or deformation to itself or any part of the Elevator equipment. The number of buffers shall be so fixed as to ensure proper sharing of the impact loads by all of them.

10.2.11 EMERGENCY SAFETY DEVICES AND BRAKES

The Elevator shall be provided with safety device attached to the Elevator car frame and placed beneath the car. The safety device shall be capable of stopping and sustaining the Elevator car up to governor tripping speed with full rated load in car. The application of the safety device shall not cause the Elevator platform to become out of level in excess of 3 cm/m measured in any direction. Slack rope switches, if necessary, shall also be provided. The Elevator vendor shall also provide personnel evacuation system during the power failure to the

COPYRIGHT AND CONFIDENTIAL
The information on this document is the property of BHARAT HEAVY ELECTRICALS LIMITED,
It cannot be used, copied, disseminated, reproduced, stored, transmitted, or otherwise disclosed to the extent of the agreement.

RESTRICTED USE





PRODUCT STANDARD

PULVERISERS

HYDERABAD

Product STD no.	BA89244
Rev No.	00
Page 18 of 32	

Elevator. The Machine shall be provided with direct current spring set, solenoid release double shoe brakes of sufficient capacity to stop the car at any position with the design load. These brakes shall be designed in such a way that it gets applied automatically in the event of power failure.

10.2.12 AUTOMATIC RESCUE DEVICE (ARD)-(BATTERY DRIVE)

Contractor shall provide a modern advanced electronic drive system of “RESCUING Passengers Trapped in an ELEVATOR” in case of power failure. In addition to the above, bell and cranking device to be provided with hand wheel connected with motor shaft for manual lowering of elevator to the nearest landing level. For Elevators with ARD, an audio & visual indicator shall be provided inside the Elevator car to alert the person trapped inside that he/she is being rescued. Capacity of battery shall be such that minimum three rescue operations can be performed without recharging. ARD panel shall be suitable for floor mounting.

10.2.13 OVERLOAD DEVICE

Every passenger Elevator shall be provided with an overload device, which will prevent the Elevator from starting in case the Elevator car is loaded to 110 percent of the rated capacity of the Elevator or more. Elevator shall remain stationery with door open. Audio & visual warning device (Load weighing device) shall be provided to alert the passenger in case of overload.

10.2.14 OVER SPEED GOVERNOR AND GOVERNOR ROPES

Governor shall be located where there is sufficient room for their proper operation and where they cannot be struck by the Elevator car or counter weight in the event of over run. Each governor shall be marked with tripping speed in terms of car speed in m/sec and the motor control and brake control circuit shall be opened before or at the time the governor trips. As per IS 14665 (part4/Sec 4):2001, the nominal rope diameter for over speed governor shall be minimum 6mm. However, for elevators where travel height is more than 90 meters, the nominal rope diameter for over speed governor shall be minimum 8mm.

10.2.15 LEVELLING DEVICE

The Elevator shall be provided with a two-way automatic levelling device. The levelling device shall take care of overrun and under run of the car and rope stretch, such that car floor is within 6.0 mm from the landing level at all floors while in operation. Aprons of sufficient depth shall be fitted to the car floor to ensure that no space is permitted between the threshold and the landing while the care is being levelled to floor.

10.2.16 MACHINE ROOM AND OVERHEAD STRUCTURES

All the overhead machinery shall be supported on beam to be furnished by the contractor. The machinery support beam shall rest on top of or be designed to be framed into the contractor’s structural steel frame for the boiler house. The Elevator drive controller and all other apparatus and equipment of Elevator installation, except such apparatus and equipment which function in the machine room shall be located at the top of the Lift well. Adequate machine room and hoist way lighting shall be provided by the Elevator vendor. The maximum loads transmitted by the single heaviest equipment both during erection and maintenance of the Elevator to the machine room floor and other structures like guides etc. shall be furnished by the Elevator vendor within 15 days of placing the award letter. Sound reducing materials below machines in machine room shall be provided. Machine room shall be provided with minimum 200 Lux illumination. MACHINE ROOM Air Conditioning: Each Machine room shall be provided with 1 no. of 2.5-ton split A/C unit (minimum) to make it dust proof.

10.2.17 TERMINAL STOPPING AND FINAL LIMIT SWITCHES

The Elevator shall be equipped with an automatic stopping device arrangement to bring the car to a stop at the terminal landings independent of the regular operating device in the car. Such stopping device shall act

COPYRIGHT AND CONFIDENTIAL
The information on this document is the property of BHARAT HEAVY ELECTRICALS LIMITED,
It shall not be used, disclosed, or disseminated to the extent of the contract.

RESTRICTED USE





PRODUCT STANDARD

PULVERISERS

HYDERABAD

Product STD no.	BA89244
Rev No.	00
Page 19 of 32	

independently of the operating device, the final limit switches and buffer.
Final limit switches shall be provided to stop the car automatically within the top and bottom clearance independent of normal operating device and the terminal stopping device. The final limit switch shall act to prevent movement of the car under power in both directions of travel and shall after operating, remain open until the Elevator car has been moved by a hand operating mechanism within the limits of normal travel. Elevator shall be suitable for continuous 24 hours round the clock operation.

10.3 ELECTRICAL EQUIPMENT AND CONTROLS

10.3.1 OPERATION AND INTERLOCKS

The operation of the Elevator shall be simplex, selective, collective, and automatic, with or without operator. The Elevator operation shall conform to the following requirements.

- a. The operation of the Elevator shall be through a push button station located inside the car.
- b. The Elevator shall not move unless the car door, landing door and all other protected openings connected with the control circuit are closed.
- c. Two push buttons, one for upward and the other for downward movement at each intermediate landing and one push button at each terminal landing shall be provided in the landing floors in order to call the car.
- d. The landing doors shall be interlocked so that the landing door at any floor shall not open when the Elevator is not on that floor.
- e. Push button shall be fixed in the car for holding the doors open for any length of time required.

10.3.2 ELEVATOR DRIVE

The Elevator drive shall be equipped with automatic electromagnetic coil type brakes. The Elevator shall be driven by a drive suitable for method of control offered by the Elevator vendor. No friction gearing or clutch mechanism shall be used for connecting the main driving gear to the sheaves.

10.3.3 ELECTRIC MOTORS

Motors shall be as per IS 325 and suitable for the Variable Voltage Variable Frequency (VVVF) application. All motors shall be squirrel cage induction type, suitable for operation at 415 V (+/-10% variation), 3 phase, 3 wire, 50HZ (+3% to -5% variation) supply suitable for frequent starting with S4 duty class (S3 duty class also acceptable, if necessary to that application and subject to end user acceptance), CDF 40%, Maximum 150 starts per hour at 50 Deg. C ambient and with IP 54 protection class. Motor pull out torque shall be at least 240% of rated torque. Motor shall be of TEFC type. Motor insulation shall be class F or superior with temperature rise limited to 70 Degree Celsius. Motor paint shade shall be RAL 5012(tentative). In case of any specific painting, same will be informed by BHEL as per the approved painting schedule.

10.3.4 CONTROLLERS

The controllers shall be designed to start, accelerate, stop and reverse the Elevator when the appropriate push buttons are pressed. It shall be arranged so as to provide maximum convenience to the operator. Contact finger Buttons shall be easy to adjust and replace. The speed control device shall be such as to give smooth, easy and accurate speed control. The Elevator controls shall be housed in dust and vermin proof enclosures. The controls shall be wired with stranded copper conductor cables. All equipment mounted shall be neatly labelled as per wiring diagram. Ventilating louvers are to be provided in the panels. Control panel shall be suitable for floor mounting.

10.3.5 CABLES AND INTERNAL WIRING

Wiring shall be done as required to interconnect all Elevator electrical equipment including all power wiring from the main supply source in the machine room. Power cables shall be 1100 V grade multi core, stranded with XLPE insulation, FRLS type ST2 inner sheathed, galvanized steel wire armoured and overall extruded FRLS, Type ST2 PVC outer sheath. If unarmored cables are used all the cabling/wiring between the equipment in the lift machine room and between machine room and equipment in the lift well and at the landings shall be wired in HDP conduit/

COPYRIGHT AND CONFIDENTIAL
The information on this document is the property of BHARAT HEAVY ELECTRICALS LIMITED,
It cannot be reproduced, stored in a retrieval system, disseminated to the internet or otherwise used without the written permission of the company.

RESTRICTED USE





PRODUCT STANDARD

PULVERISERS

HYDERABAD

Product STD no.	BA89244
Rev No.	00
Page	20 of 32

galvanized steel conduit. The circular trailing cables shall conform to IS 4289 Part-I (Elastomer insulated) or IS 4289 Part II (PVC insulated) / Flat type trailing cable shall conform to IEC 60227-06. All other cables shall conform to latest edition of IS: 7098, IS:1554 & IS:5831. Following FRLS properties shall be complied with.

a) Oxygen index of min. 29 (as per IS:10810 Part-58) b) Acid gas emission of max.20% (as per IEC-754-I). c) Smoke density rating shall not be more than 60% (as per ASTM-D-2843).

10.3.6 CABLING AND EARTHING

Earthing shall be carried out as per IS 14665, IS 3043 and Indian Electricity Rules. The Elevator structures, motor, frames, metal cases and all electrical equipment including conduit, cable armouring and guards shall be properly bonded and earthed by two separate and distinct connections. The earth connection station mat shall be done by the owner.

10.3.7 POWER SUPPLY

One three phase 415V, AC, 50 Hz UPS Supply for Elevator main motor, and one single phase 240V, AC, 50Hz supply feeders for lighting, air conditioner and control panels will be provided in near elevator area (at ground level) by BHEL. The exact Power requirement in kVA of three phase supply and single phase power supply shall be indicated in the offer itself by the vendor. The junction box having MCCB/MCB/ELCB Isolation of adequate rating shall be arranged by the vendor to receive the above supplies (Best in Class system to be provided for this purpose). The Elevator vendor shall also indicate the proposed location of junction box in the machine room. All further cabling and wiring from the junction box shall be carried out by the Elevator vendor. The vendor shall arrange to tap power supply required for constructional purposes from the point terminated by the owner.

10.3.8 OTHER REQUIREMENTS

Electric high speed door operators for the opening and closing of the car doors and landing doors shall be furnished and installed. The car and landing doors shall be mechanically connected and shall move simultaneously in opening and closing. The car door and landing door shall be power closed and shall be controlled in opening and closing by oil cushioning mechanism built into the gear unit or alternate arrangement equally / better than this. Necessary lockable switches shall be provided in the Elevator machine room to control the operation of the door. Should the electric power fail, it must be possible for the doors to be opened from within the car, provided the car is exactly at the landing level. Overload relays shall be provided to protect the drive motor against overload or a power failure. Suitable protection shall be provided on the controller to protect the Elevator equipment from phase reversal, low voltage. Suitable arrangement shall be provided to intimate unit control room during emergency in the form of audio-visual alarm. Complete set of special tools and tackles required shall be supplied along with Elevator. Each tool and tackle shall be stamped so as to be identified easily for its use and size. Tools shall be supplied in a steel tool box. The list of tools and tackles shall be furnished along with the offer. One number Fire extinguisher (suitable for electrical fire) shall be provided along with each elevator.

COPYRIGHT AND CONFIDENTIAL
 The information on this document is the property of BHARAT HEAVY ELECTRICALS LIMITED,
 It shall not be used, disclosed, or in any way disseminated to the extent of the contract.





PRODUCT STANDARD PULVERISERS HYDERABAD

**Product
STD no.** BA89244

Rev No. 00

Page 21 of 32

11 SUPERVISION OF ERECTION AND COMMISSIONING

Sl. No	Description	Vendor to confirm
a)	The erection and commissioning of elevators & accessories shall be done by bidder. Bidder shall include complete erection, pre-commissioning & post-commissioning check-up, start-up, testing and trial runs till handing over at site under his scope of work. Also conductance Performance guarantee test shall be borne by bidder.	
b)	TA/DA, boarding and lodging shall be borne by the bidder and shall be included in quoted price.	
c)	Price comparison for evaluating the lowest bid will be considered all main supply, supervision of E&C charges, tools & tackles and commissioning spares price all together.	

12 SPECIAL TOOL AND TACKLES AND SPARES

12.1 SPECIAL TOOL AND TACKLES.

Any special tools & tackles required for the entire equipment to disassemble, assemble or maintain the units, they shall be included in the quotation and furnished as part of the initial supply of the machine. List of special tools & tackles shall be decided by bidder as per his proven practice. When special tools are provided, they shall be packaged in separate, boxes with lugs and marked as "Special Tools for (tag / item number)." Each tool shall be stamped or tagged to indicate its intended usage. Levers and eye bolts for the removal of parts to be serviced shall be submitted with special tools. The list of tools and tackles are in Annexure-II.

12.2 START UP & COMMISSIONING SPARES

Start-up & Commissioning Spares shall be part of the main supply of the Elevators. Start-up & commissioning spares are those spares which may be required during the start-up and commissioning of the equipment/system. All spares required for successful operation till commissioning of elevator shall come under this category. Bidder shall provide an adequate stock of such start up and commissioning spares to be brought by him to the site for the equipment erection and commissioning. The spares must be available at site before the equipment's are energized. The List of such spares to be provided during bidding stage.





PRODUCT STANDARD

PULVERISERS

HYDERABAD

Product
STD no.

BA89244

Rev No. 00

Page 22 of 32

13 PERFORMANCE GUARANTEE AND SCHEDULE GUARANTEES

All performance tests for elevators shall be carried out in accordance with latest international codes/standards.

The following performance guarantee test to be conducted and to be guaranteed by bidder.

- a. Rated capacity of the elevator.
- b. Travel and hoist Speed of the elevator.
- c. Accurate positioning of the elevator.
- d. Over Load test as per IS:14665 (Latest edition)
- e. The Bidder shall ensure a design of the equipment to achieve an average target availability as per customer specification.

Note: Noise level ≤ 85 dB (A) at 1m horizontal distance from equipment/enclosures and 1.5m above operating floor is to be guaranteed.

Note:

After erection, the performance of the Elevator shall be tested for ascertaining the conformity with the specification and upon satisfactory completion of the tests, the Elevator will be handed over to customer over. The responsibility for obtaining commissioning and handing over protocol signed by the customer lies with the Elevator vendor.

14 WARRANTY

- 14.1 The bidder warrants that the equipment's/items shall be free from defects in the design, engineering, materials and workmanship of the Plant and Equipment supplied and of the work executed. The Warranty Period shall be eighteen (18) months from the date of delivery or twelve months (12) months from the date of commissioning, whichever first occurs. If during the Defect Liability Period any defect should be found in the design, engineering, materials and workmanship of the Plant and Equipment supplied or of the work executed by the Bidder, the Bidder shall promptly, in consultation and agreement with BHEL regarding appropriate remedying of the defects, and at its cost, repair, replace or otherwise make good (as the Bidder shall, at its discretion, determine) such defect as well as any damage to the Facilities caused by such defect.
- 14.1 In case of failure of the equipment to meet the guarantee, CUSTOMER /BHEL reserves the right to reject the equipment. However, CUSTOMER /BHEL reserves the right to use the equipment until new equipment supplied by bidder meets the guaranteed requirement.

15 QUALITY ASSURANCE/QUALITY PLAN

(As per approved quality plan. However, minimum requirements are as below)

- 15.1 MQP (Manufacturing Quality Plan) shall be submitted to BHEL/Customer for review & approval.
- 15.2 MQP shall invariably cover w.r.t Inward inspection including on Raw Material Procurement, In process and Final inspection in elaborated way/details.





PRODUCT STANDARD PULVERISERS HYDERABAD

Product STD no.	BA89244
Rev No.	00
Page 23 of 32	

- 15.3 Bidder shall also to give specific confirmation that on need basis, their competent officials shall visit to BHEL/customer for finalization of Quality plan including test procedure/methodology during pre- award / post award approval / detailed engineering in the event of an order.
- 15.4 No deviation on BHEL/Customer approved MQP is acceptable.

16 PAINTING SCHEDULE

As per attached customer approved painting schedule.

17 FIRST FILL CONSUMABLE

Bidder's scope shall also include supply and filling of all chemicals, reagents, resins, lubricants, grease, filters and consumable items for operation up to COD including top up requirements at the time of issuance of PAC/declaration of COD. All lubricants proposed for the plant operation shall be suitable for all operating and environmental conditions that will be met on site consistent with good maintenance procedures as instructed in the maintenance manuals.

Detailed specifications for the lubricating oil, grease, gases, servo fluids, control fluids, chemicals including items qualities and quantities required per month of the plant operation for the CUSTOMER/BHEL's approval herein shall be furnished eighteen (18) months prior scheduled COD of the 1st unit. On completion of erection complete list of bearings/equipment giving their location and identification marks shall be furnished to CUSTOMER along with lubrication requirements. All types of chemicals, consumables, lubricants and grease shall be readily obtainable locally and the number of different types shall be kept to a minimum. For each type and grade of lubricant recommended, bidder shall list at least three equivalent lubricants (Make & Model) manufactured by alternative companies.

18 PACKING AND FORWARDING

Sl. No	Description	Vendor to confirm
a)	Proper packing to be ensured. Elevator & sub system assembly shall be wrapped in polythene bags & packed in a strong rigid wooden crate. Rain water should not enter into the elevator internals during storage in the outer yard of power plant.	

COPYRIGHT AND CONFIDENTIAL
The information on this document is the property of BHARAT HEAVY ELECTRICALS LIMITED,
It shall not be used, disclosed, or disseminated to the extent of the contract.

RESTRICTED USE





PRODUCT STANDARD
PULVERISERS
HYDERABAD

**Product
STD no.**

BA89244

Rev No. 00

Page 24 of 32

COPYRIGHT AND CONFIDENTIAL
 The information on this document is the property of BHARAT HEAVY ELECTRICALS LIMITED,
 It shall not be read, disclosed, or in any way disseminated to the extent of the contract.

b)	Equipment and process materials shall be packed and semi-knocked down, to the extent possible, to facilitate handling and storage and to protect bearings and other machine surfaces from oxidation. Each container, box, crate or bundle shall be reinforced with steel strapping in such a manner that breaking of one strap will not cause complete failure of packaging. The packing shall be of best standard to withstand rough handling and to provide suitable protection from tropical weather while in transit and while awaiting erection at the site. All the major equipment's shall be supplied in steel crates. The package shall be supplied in containers and it should be suitable for storage in the outside yard of the plant for a minimum period of 18 months.	
c)	Equipment and materials in wooden cases or crates shall be properly cushioned to withstand the abuse of handling, transportation and storage. Packing shall include preservatives suitable to tropical conditions. All machine surfaces and bearings shall be coated with oxidation preventive compounds. All parts subject to damage when in contact with water shall be coated with suitable grease and wrapped in heavy asphalt or tar impregnated paper.	
d)	Crates and packing material used for shipping will become the property of customer	
e)	Packaging or shipping units shall be designed within the limitations of the unloading facilities of the receiving ports and the ship will be used. It shall be the bidder's responsibility to investigate these limitations and to provide suitable packaging and shipping to permit transportation to site.	
f)	Packing (tare) shall be part of the equipment cost and shall not be subject to return. The packing should ensure integrity and cohesiveness of each delivery batch of equipment during transportation. In case of equipment assemblies and unit's delivery in the packing of glass, plastics or paper the specification of packing with the material and weight characteristics are to be indicated.	
g)	Each package should have the following inscriptions and signs stenciled with an indelible ink legibly and clearly: <ul style="list-style-type: none"> a. Destination b. Package Number c. Gross and Net Weight d. Dimensions e. Lifting places f. Handling marks and the following delivery marking 	
h)	Each part of the equipment which is to be shipped as a separate piece or smaller parts packed within the same case shall be legibly marked to show the unit of which it is part, and match marked to show its relative position in the unit, to facilitate assembly in the field. Unit marks and match marks shall be made with steel stamps and with paint.	
i)	Each case shall contain a packing list showing the detailed contents of the package. When any technical documents are supplied together with the shipment of materials no single package shall contain more than one set of such documents. Shipping papers shall clearly indicate in which packages the technical documents are contained.	
j)	Marking for Safe handling: To ensure safe handling, packing case shall be marked to show the following: <ul style="list-style-type: none"> a. Upright position 	

RESTRICTED USE





PRODUCT STANDARD

PULVERISERS

HYDERABAD

**Product
STD no.**

BA89244

Rev No. 00

Page 25 of 32

COPYRIGHT AND CONFIDENTIAL
 The information on this document is the property of BHARAT HEAVY ELECTRICALS LIMITED,
 It shall not be used, disclosed, or in any way disseminated to the extent of the contract.

	b. Sling position and center of Gravity position c. Storage category d. Fragile components (to be marked properly with a clear warning for safe handling)	
k)	Each crate or package is to contain a packing list in a waterproof envelope. All items are to be clearly marked for easy identification against the packing List. All cases, packages etc. are to be clearly marked on the outside to indicate the total weight where the weight is bearing and the correct position of the slings are to bear an identification mark relating the to the appropriate shipping documents. All stencil marks on the outside of cases are either to be made in waterproof material or protected by shellac or varnish to prevent obliteration in transit.	
l)	The packing slip shall contain the following information: - Customer name, Name of the equipment, Purchase Order number with Date, Address of the delivery site, Name and Address of the Sender, Serial Number of Elevator & accessories, BHEL item Code, Gross Weight and Net weight of Supplied items.	
m)	Prior to transport from manufacturer's work to destination, components of the unit shall be completely cleaned to remove any foreign particles. Flange faces and other machined surfaces shall be protected by an easily removable rust preventive coating followed by suitable wrapping.	
n)	All necessary painting, corrosion protection & preservation measures shall be taken as specified in painting schedule. Supplier shall consider the coastal environment zone which is defined as "very severe" during final finishing/shipping.	
o)	Successful bidder shall furnish the detail packing /shipment box details with information like packing box size, type of packing, weight of each consignment, sequence no. of dispatch, no. of consignment for each deliverable item against each billing break up units/ billable blocks. Without these details the BBU shall not be approved during detail engineering. Also, complete billing break-up with above mentioned details shall be submitted within 10 days of LOI.	
p)	All items/equipment shall be dispatched in properly packed condition (i.e. no item shall be dispatched in loose condition such that it becomes difficult to store/identify its location at site at a later stage).	
q)	Cases which cannot be marked as above shall have metal tags with the necessary markings on them. The metal tags shall be securely attached to the packages with strong steel binding wire. Each piece, Skid, Case or package shipped separately shall be labelled or tagged properly.	

19 TRAINING

Successful bidder shall provide comprehensive training for CUSTOMER/BHEL Engineering, O&M, Erection & Commissioning staffs at site covering all aspects of the elevator- Operation & Maintenance, troubleshooting etc.

20 CONFLICT

Bidder's equipment shall be designed for and shall meet the service, performance and minimum level of quality requirements specified. Bidder shall be solely responsible for advising CUSTOMER in writing of





**PRODUCT STANDARD
PULVERISERS
HYDERABAD**

**Product
STD no.**

BA89244

Rev No. 00

Page 26 of 32

any conflicts between the specifications and Bidder's design, including performance and levels of quality. Bidder agrees that its obligations, liabilities and warranties shall not be diminished or extinguished due to its meeting the requirements of the Specification.

21 COMPLIANCE CUM CONFIRMATION CERTIFICATE

The bidder shall confirm compliance with following by signing/ stamping this compliance certificate (every sheet) and furnish same with the offer.

- a. The scope of supply, technical details, construction features, design parameters etc. shall be as per technical specification & there are no exclusions other than those mentioned under "exclusion" and those resolved as per 'Schedule of Deviations', if applicable, with regard to same.
- b. There are no other deviations w.r.t. specifications other than those furnished in the 'Schedule of Deviations'. Any other deviation, stated or implied, taken elsewhere in the offer stands withdrawn unless specifically brought out in the 'Schedule of Deviations'.
- c. Bidder shall submit QP in the event of order based on the guidelines given in the specification & QP enclosed therein. QP will be subject to BHEL/ CUSTOMER approval & customer hold points for inspection/ testing shall be marked in the QP at the contract stage. Inspection/ testing shall be witnessed as per same apart from review of various test certificates/ Inspection records etc. This shall be within the contracted price with no extra implications to BHEL after award of the contract.
- d. All drawings/ data-sheets / calculations etc. submitted along with the offer shall not be taken cognizance.
- e. The offered materials shall be either equivalent or superior to those specified in the specification & shall meet the specified / intended duty requirements. In case the material specified in the specifications is not compatible for intended duty requirements then same shall be resolved by the bidder with BHEL, otherwise BHEL / Customer's decision shall be binding on the bidder whenever the deficiency is pointed out. For components where materials are not specified, same shall be suitable for intended duty, all materials shall be subject to approval in the event of order.
- f. The commissioning spares shall be supplied on 'As Required Basis' & prices for same included in the base price itself.
- g. All sub vendors shall be subject to BHEL / CUSTOMER approval.
- h. Guarantee and warranty as per clause No. 14. Of this specification.
- i. All the material required for completing the job at site shall be supplied by the bidder within the ordered price even if the same are additional to approved billing break up, approved drawing or approved Bill of quantities within the scope of work as tender specification. This clause will apply in case during site commissioning, additional requirements emerges due to customer and / or consultant's comments. No extra claims shall be put on this account
- j. Schedule of drawings submissions, comment incorporations & approval shall be as stipulated in the specifications. The successful bidder shall depute his design personnel to BHEL's / Customer's / Consultant's office for across the table resolution of issues and to get documents approved in the stipulated time.
- k. As built drawings shall be submitted as and when required during the project execution.

COPYRIGHT AND CONFIDENTIAL
The information on this document is the property of BHARAT HEAVY ELECTRICALS LIMITED,
It shall not be used, disclosed, or in any way disseminated to the extent of the contract.





PRODUCT STANDARD

PULVERISERS

HYDERABAD

**Product
STD no.**

BA89244

Rev No. 00

Page 27 of 32

- l. The bidder has not tempered with this compliance cum confirmation certificate and if at any stage any tempering in the signed copy of this document is noticed then same shall be treated as breach of contract and suitable actions shall be taken against the bidder.
- m. Successful bidder shall furnish detailed erection manual for each of the equipment supplied under this contract at least 3 months before the scheduled erection of the concerned equipment / component or along with supply of concerned equipment / component whichever is earlier.
- n. Document approval by customer under Approval category or information category shall not absolve the vendor of their contractual obligations of completing the work as per specification requirement. Any deviation from specified requirement shall be reported by the vendor in writing and require written approval. Unless any change in specified requirement has been brought out by the vendor during detail engineering in writing while submitting the document to customer for approval, approved document (with implicit deviation) will not be cited as a reason for not following the specification requirement.
- o. In case vendor submits revised drawing after approval of the corresponding drawing, any delay in approval of revised drawing shall be to vendor's account and shall not be used as a reason for extension in contract completion

22 PROJECT INFORMATIONS

PROJECT LOCATION

TSGENCO, Yadadri, 5X800 MW

THE DETAIL OF PASSENGER CUM GOODS ELEVATOR FOR LIMESTONE DAY SILO BUILDING.

i)	Type of service	Passenger cum Goods Elevator
	Design Standard	As per code mentioned in Cl. No. 3.0
	Area Classification	Safe Area
	Type of Elevator	Machine Room traction type, Geared Motor or Motor with Gearbox Type Passenger elevator
	Position of machine room	Directly above the lift shaft
	Machine room and lift shaft.	One No. adequately sized, air conditioner each having minimum cooling capacity of 2.5 Ton shall be provided for each elevator machine room to make it dust proof (Pressurized dust proof or air conditioned machine room as per requirement of lift manufacturers- to be splitted).
ii)	Number required	1 No.
iii)	Load on the Elevator	Minimum 1000 Kgs
iv)	Rated speed	1.0 meter/s



PRODUCT STANDARD

PULVERISERS

HYDERABAD

Product
STD no.

BA89244

Rev No. 00

Page 28 of 32

v)	Total travel and No. of floors to be served (Landing levels)	G+5 Landing Elevations* *Ground Floor: Level: 0.0 M (EL - 0.0 M) *1 st floor: Level: 4.50 M (EL + 4.50 M) *2 nd floor: Level: 12.50 M (EL +12.50 M) *3 rd floor: Level: 19.00 M (EL +19.00 M) *4 th floor: Level: 28.00 M (EL +28.00 M) *5 th floor: Level: 35.50 M (EL +35.50 M) * Elevations locations are subject to change & shall be finalized during Mechanical GA approval with customer. Hence, same shall be informed to bidder during final drawing/data sheet approval.
vii)	No of Opening	One number in each floor
viii)	Method of control Motor Speed Control: Logic Control:	Variable Voltage variable frequency (VVVF) control. Microprocessor based Control with automatic level adjustment. The control system shall be of field proven design and having satisfactory track record.
	Location of elevator	General Arrangement of Limestone day silo building (indicated shaft area) shall be provided.

23 DOCUMENTATION

23.1 Technical document to be submitted along with offer.

Sl. No.	Description	Purpose
1	Seal & Sign of bidder on all pages of specification	Technical valuation of Bid (TEB)
2	Schedule of Deviation List (if any)	TEB
3	Machine room layout	TEB
4	GA of Elevator with loading data	TEB
5	Filled Data Sheets of Elevator & All accessories	TEB
6	T-S curve & Performance curve	TEB
7	Anchor Plan & Civil foundation Loading details	TEB
8	Required Electric power & other Utility List	TEB
9	Make of all bought out items & sub vendor list	TEB
10	Quality Plan	TEB
11	List of Start-up & Commissioning Spares	TEB
12	Write-up on interlocks, controls and safety devices provided.	TEB





**PRODUCT STANDARD
PULVERISERS
HYDERABAD**

**Product
STD no. BA89244**

Rev No. 00

Page 29 of 32

13	Delivery Sequence	TEB
14	Catalogues	TEB

23.2 DOCUMENTS TO BE SUBMITTED AFTER CONTRACT:

Sl. No.	Description	Handing over of Documents PO Placement (in weeks)	Purpose
1.	GA of Elevator & accessories with bill of material with loading data (in PDF & AutoCAD format)	2	BHEL /Customer Approval
2.	Filled Data Sheets of Elevator & All accessories	2	BHEL /Customer Approval
3.	Anchor Plan & Civil foundation Loading details	2	BHEL /Customer Approval
4.	Machine room layout (in consultation with BHEL)	2	BHEL /Customer Approval
5.	Manufacturing Quality Plan	3	BHEL /Customer Approval
6.	Motor Sizing Calculation	4	BHEL /Customer Approval
7.	T-S Curve for motor selected	4	BHEL /Customer Approval
8.	Motor Rating in Kw	4	BHEL /Customer Approval
9.	Sub vendors List	4	BHEL /Customer Approval
10.	Manufacturing Schedule	4	BHEL /Customer Approval
11.	Electrical Load List with Single Line Diagram	6	BHEL Review
12.	Control Logic of Elevator	6	BHEL Review
13.	Local Panel Control Circuit Diagram	6	BHEL Review
14.	List of Special Tools	8	E&C
15.	List of Start-up & Commissioning Spares	9	E&C
16.	Required Electric power	10	E&C
17.	Pre- Commissioning Check List	10	E&C
18.	Installation & assembly procedure	10	E&C
20.	Erection & Commissioning Schedule	10	E&C
21.	Recommended Repair Procedure	10	E&C
22.	Operation and Maintenance Manual (10 hardcopies and 5 electronic copies in English)	10	E&C
23.	Catalogue	10	BHEL Review
	Performance Test Procedure at site	10	BHEL /Customer Approval

COPYRIGHT AND CONFIDENTIAL
 The information on this document is the property of BHARAT HEAVY ELECTRICALS LIMITED,
 It shall not be used, disclosed, or in any way disseminated to the extent of the contract.



TD-106-1
Rev No. 5
Form No.



PRODUCT STANDARD PULVERISERS HYDERABAD

Product
STD no.

BA89244

Rev No. 00

Page 30 of 32

24.	Proforma Packing List	12	Dispatch

ANNEXURES LIST

Annexure Sl. No.	Description
I.	Mandatory spares List- Not Applicable
II.	Approved Painting schedule
III.	General Arrangement of limestone day silo building. (elevation and floor plan)
IV.	List of Deviations

COPYRIGHT AND CONFIDENTIAL
The information on this document is the property of BHARAT HEAVY ELECTRICALS LIMITED,
It shall not be read, disclosed, or in any way disseminated to the extent of the contract.

RESTRICTED USE





PRODUCT STANDARD

PULVERISERS

HYDERABAD

Product STD no.	BA89244
Rev No. 00	
Page 31 of 32	

ANNEXURE-IV

LIST OF DEVIATIONS/EXCEPTIONS TO THE ENQUIRY DOCUMENT

SI No	Clause No	Page No	Description of Deviation

Note: Enlarge the table to incorporate items...

SIGNATURE OF BIDDER -----

NAME -----

DESIGNATION -----

COPYRIGHT AND CONFIDENTIAL
The information on this document is the property of BHARAT HEAVY ELECTRICALS LIMITED,
It shall not be used, copied, distributed, or otherwise disseminated to the extent of the contract.



COPY RIGHT AND CONFIDENTIAL
 The information on this document is the property of BHARAT HEAVY ELECTRICALS LIMITED
 It must not be used directly or indirectly in any way detrimental to the interest of the company.

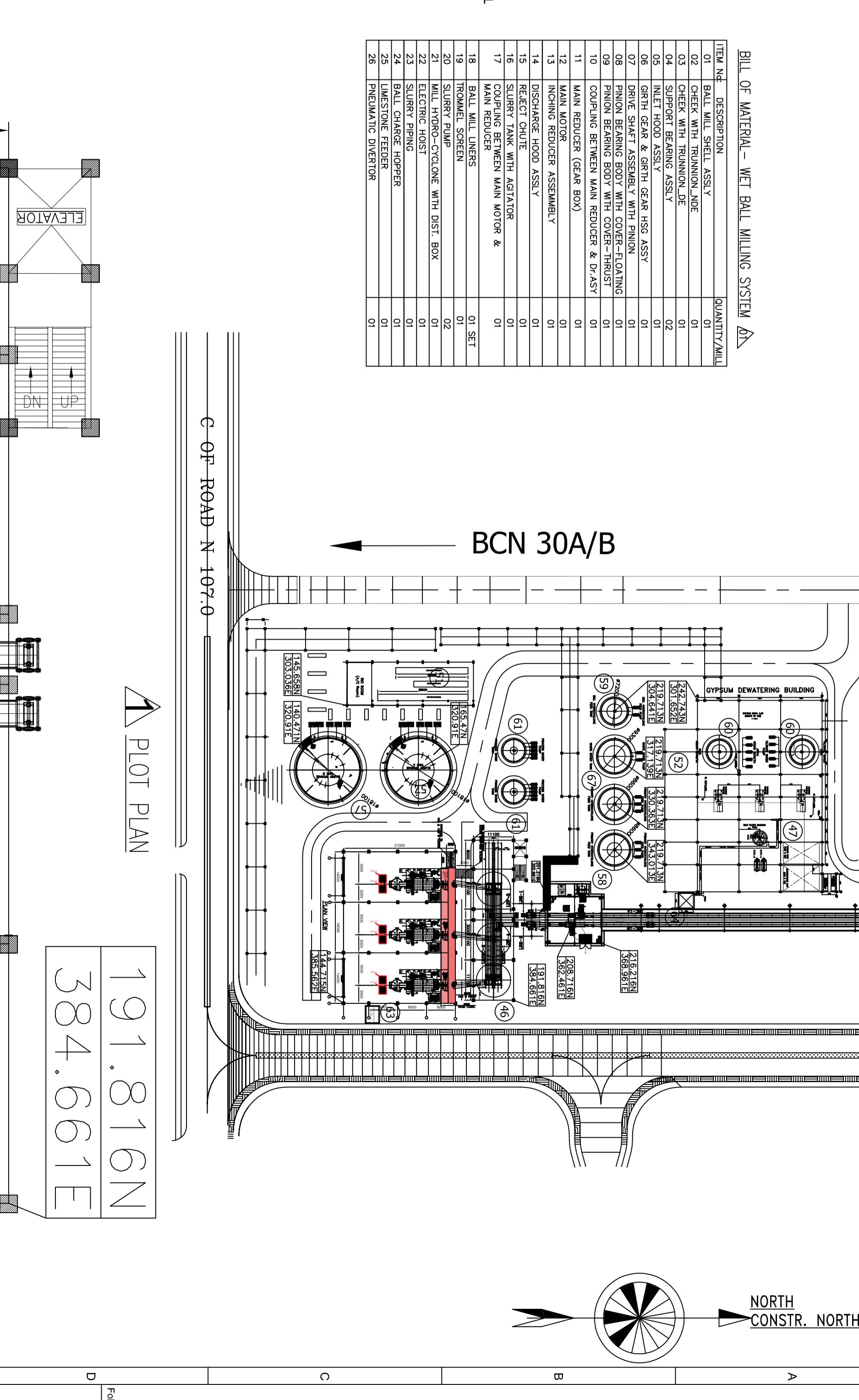
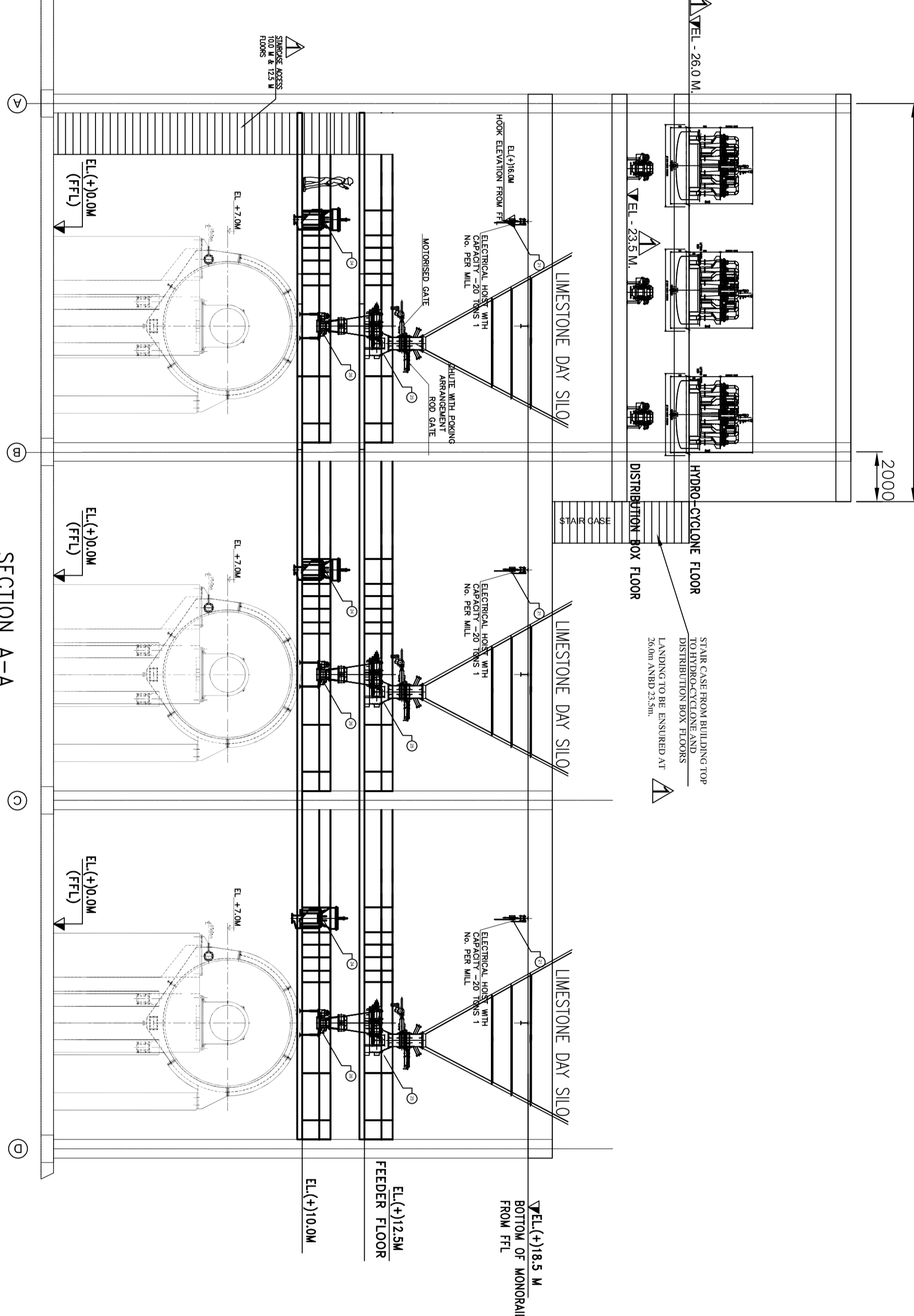
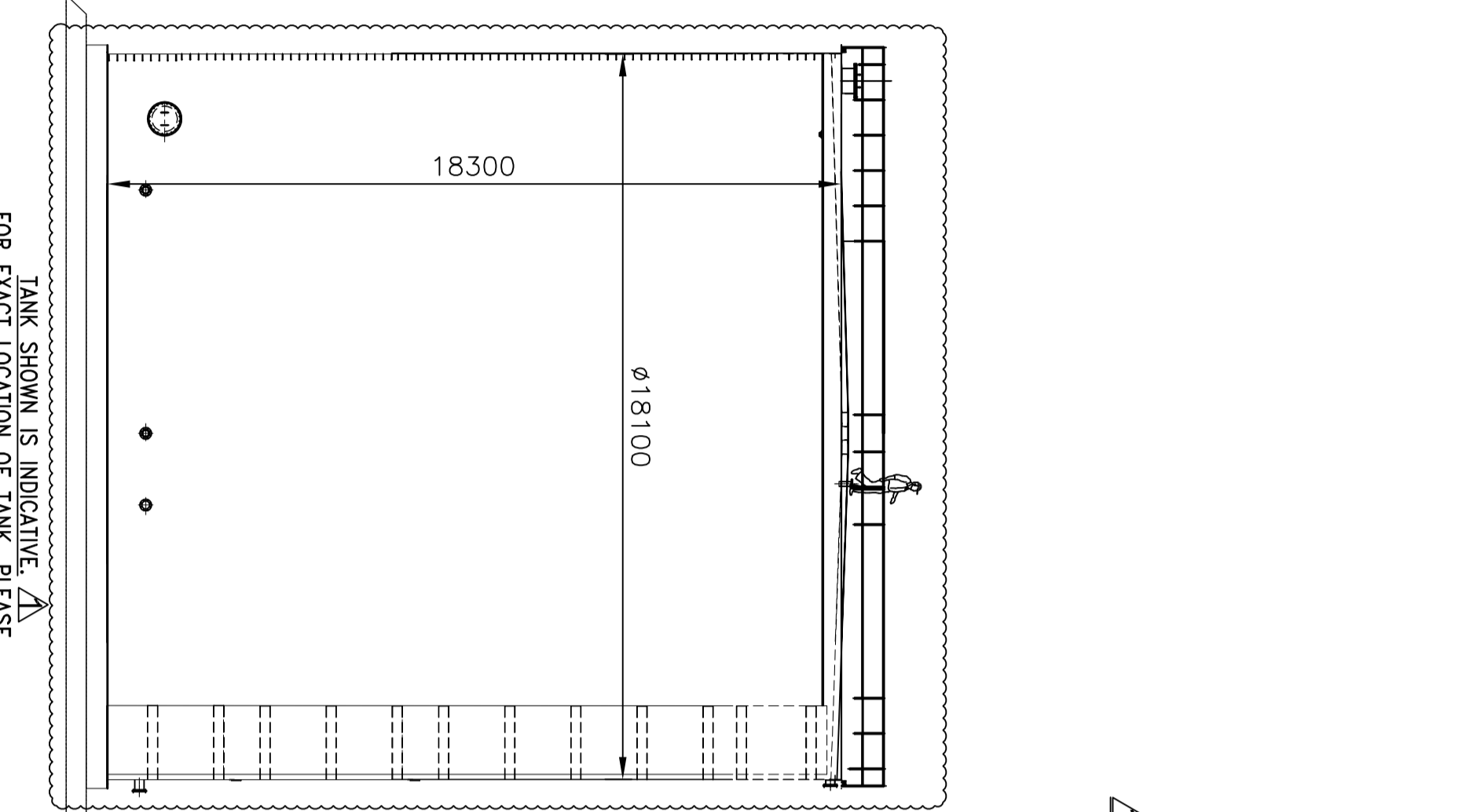
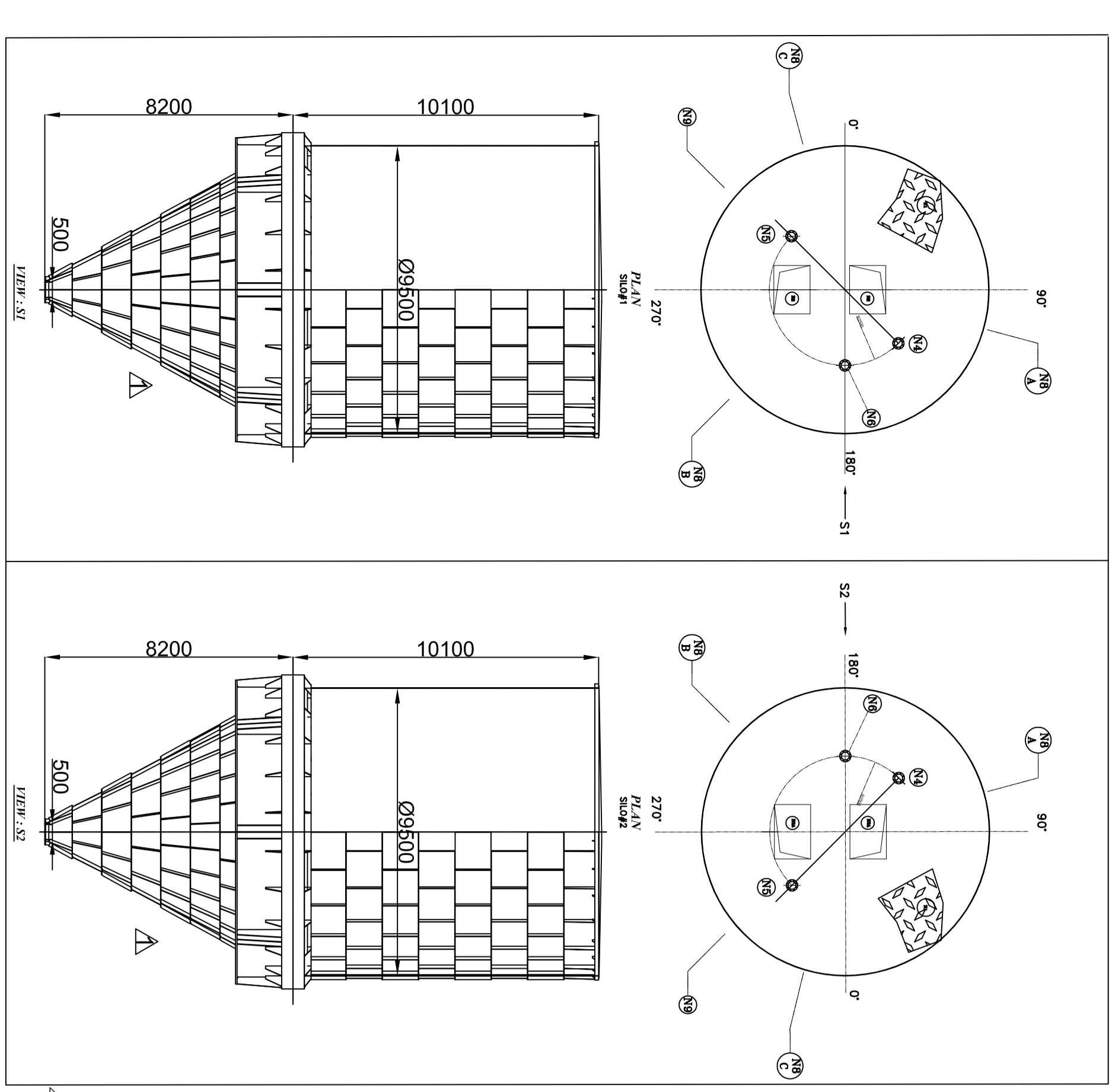
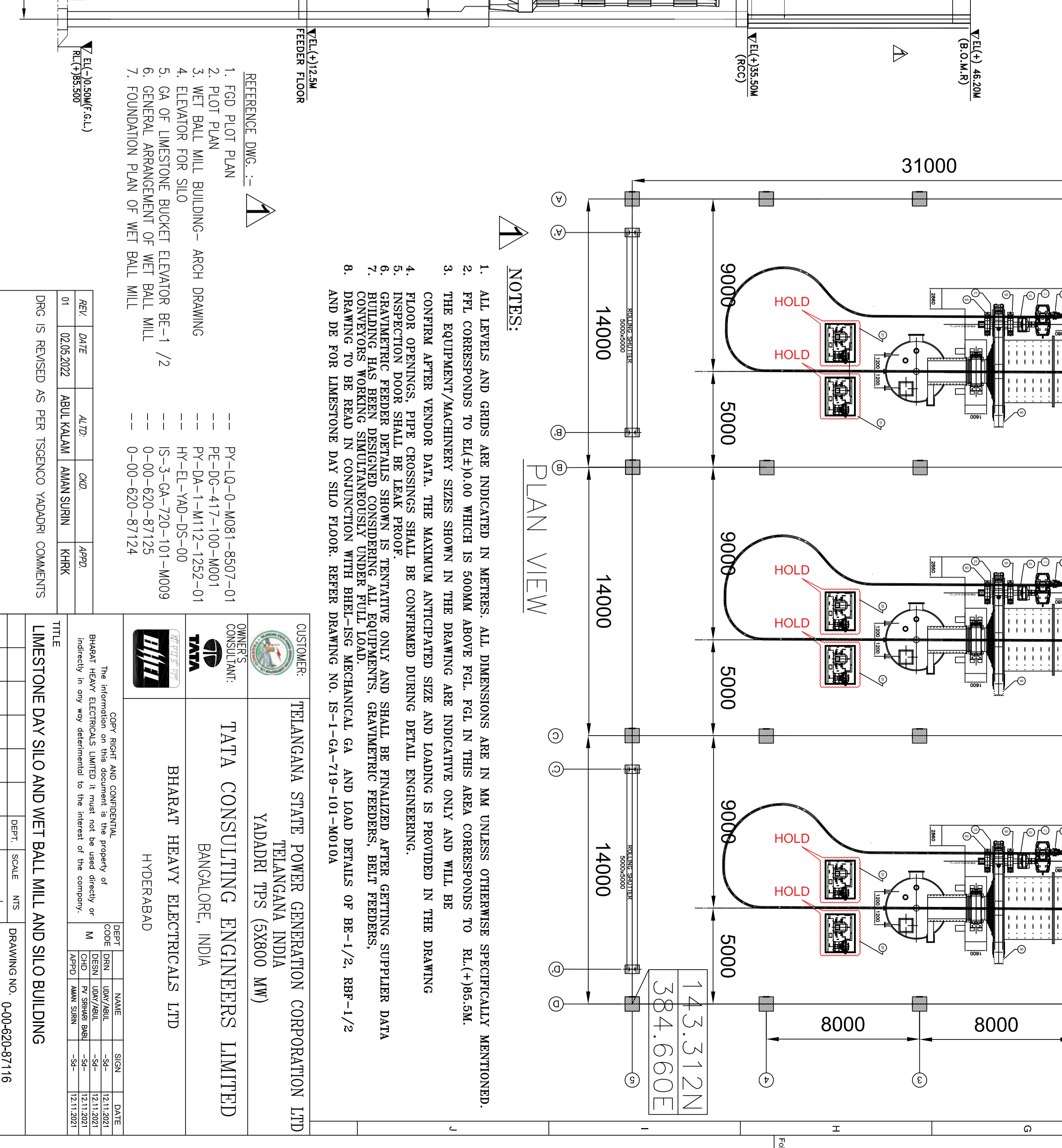
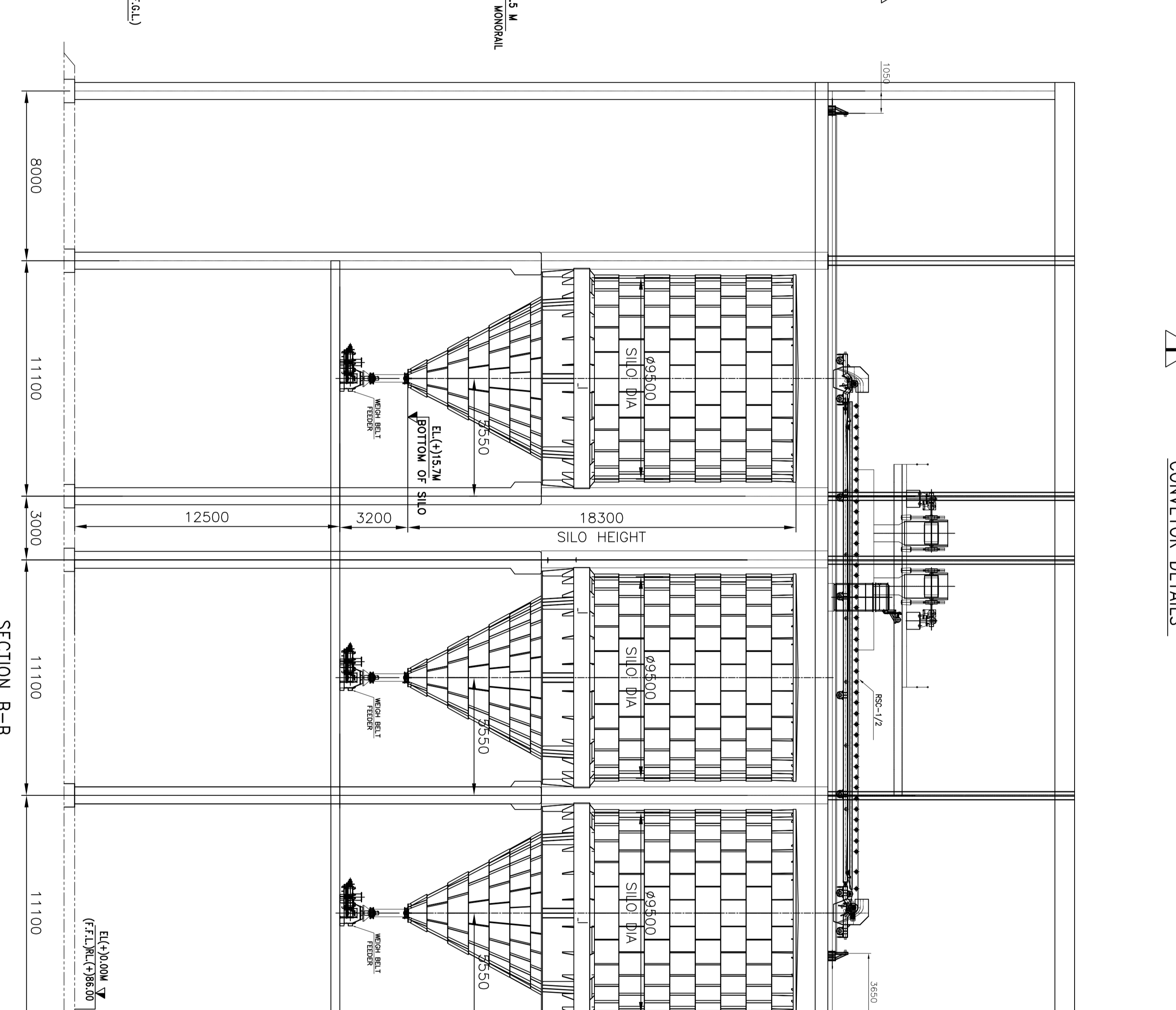
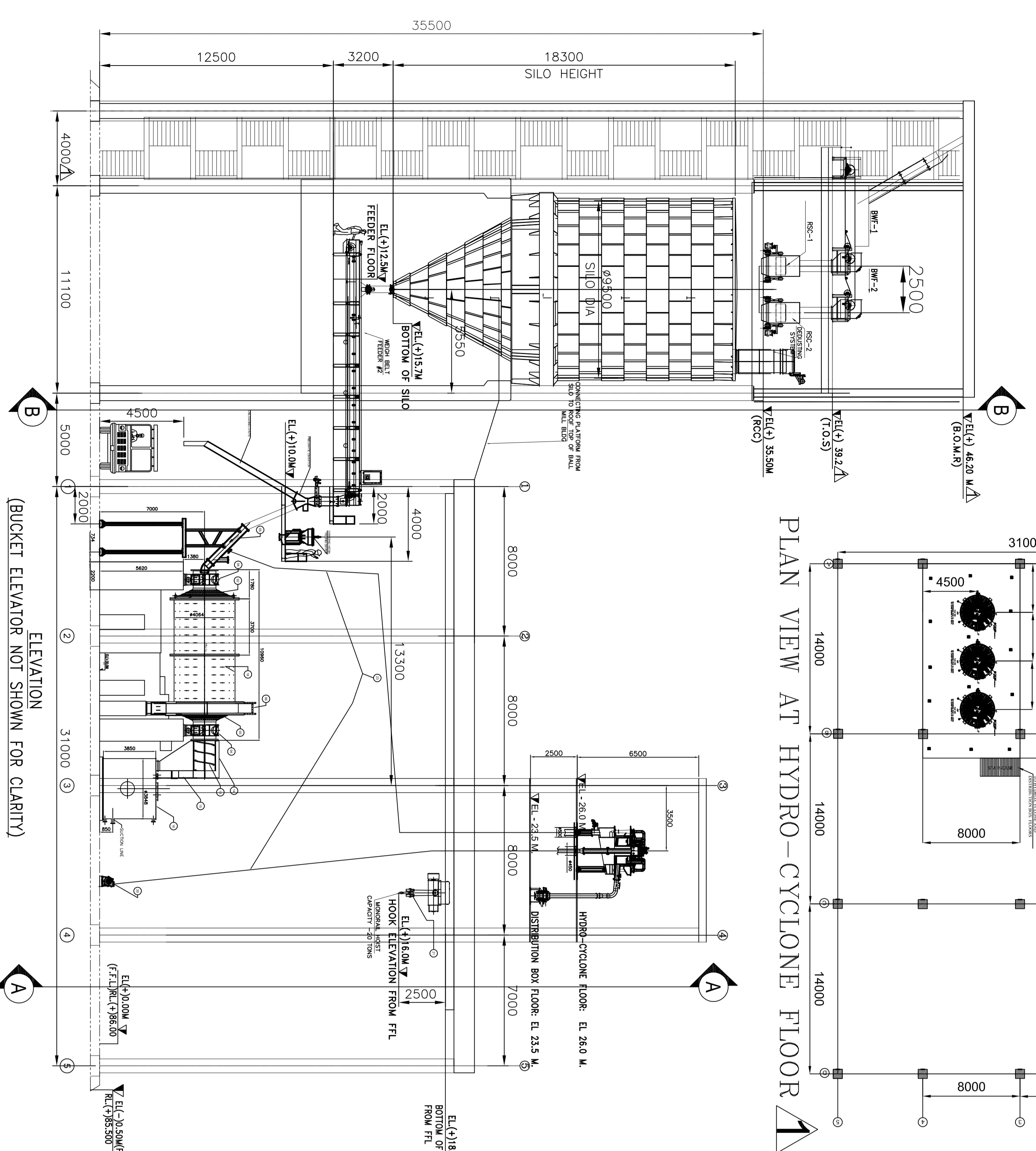

TABLE 1 - MATERIAL SPECIFICATION FOR SILO

Sl. No.	Particulars	Quantity	Unit	Remarks
01	STEEL SHEET PILING	1000	M	FOR SILO WALL
02	STEEL ROLLER	100	NO.	FOR SILO WALL
03	STEEL ROLLER	100	NO.	FOR SILO WALL
04	STEEL ROLLER	100	NO.	FOR SILO WALL
05	STEEL ROLLER	100	NO.	FOR SILO WALL
06	STEEL ROLLER	100	NO.	FOR SILO WALL
07	STEEL ROLLER	100	NO.	FOR SILO WALL
08	STEEL ROLLER	100	NO.	FOR SILO WALL
09	STEEL ROLLER	100	NO.	FOR SILO WALL
10	STEEL ROLLER	100	NO.	FOR SILO WALL

TABLE 2 - MATERIAL SPECIFICATION FOR SILO

Sl. No.	Particulars	Quantity	Unit	Remarks
11	STEEL SHEET PILING	1000	M	FOR SILO WALL
12	STEEL ROLLER	100	NO.	FOR SILO WALL
13	STEEL ROLLER	100	NO.	FOR SILO WALL
14	STEEL ROLLER	100	NO.	FOR SILO WALL
15	STEEL ROLLER	100	NO.	FOR SILO WALL
16	STEEL ROLLER	100	NO.	FOR SILO WALL
17	STEEL ROLLER	100	NO.	FOR SILO WALL
18	STEEL ROLLER	100	NO.	FOR SILO WALL
19	STEEL ROLLER	100	NO.	FOR SILO WALL
20	STEEL ROLLER	100	NO.	FOR SILO WALL



- NOTES:
1. ALL LEVELS AND GRIDS ARE INDICATED IN METERS. ALL DIMENSIONS ARE IN MM UNLESS OTHERWISE SPECIFICALLY MENTIONED.
 2. PPL CORRESPONDS TO ELEVATION WHICH IS 500MM ABOVE PGL. PGL IN THIS AREA CORRESPONDS TO RL+198.5M.
 3. THE EQUIPMENT/MACHINERY SIZES SHOWN IN THE DRAWING ARE INDICATIVE ONLY AND WILL BE CONFIRMED AFTER VENDOR DATA. THE MANUFACTURE ANTICIPATED SIZE AND LOADING IS PROVIDED IN THE DRAWING.
 4. FLOOR OPENINGS PIPE CROSSINGS SHALL BE CONSIDERED DURING DETAIL ENGINEERING.
 5. GRAVIMETRIC FEEDER DETAILS SHOWN IS TENTATIVE ONLY AND SHALL BE FINALIZED AFTER GETTING SUPPLIER DATA.
 6. GRAVIMETRIC FEEDER DETAILS SHOWN IS TENTATIVE ONLY AND SHALL BE FINALIZED AFTER GETTING SUPPLIER DATA.
 7. BUILDING TO BE BEAN IN CONNECTION WITH BELT-SC CONVEYOR AND LOAD DETAILS OF BE-1/2, BEP-1/2 AND DE FOR LIMESTONE DRY SILO FLOOR. REFER DRAWING NO. IS-1-6A-719-101-0010A.
 8. AND DE FOR LIMESTONE DRY SILO FLOOR. REFER DRAWING NO. IS-1-6A-719-101-0010A.

- REFERENCE Dwg. :-
1. FGD PLOT PLAN
 2. FLOT PLOT PLAN
 3. WET BALL MILL BUILDING- ARCH DRAWING
 4. LESTONE CRACKER BUILDING- ARCH DRAWING
 5. GENERAL ARRANGEMENT OF WET BALL MILL
 6. GENERAL ARRANGEMENT OF WET BALL MILL
 7. FOUNDATION PLAN OF WET BALL MILL

REVISIONS

REV	DATE	BY	CHK	APPD	REASON
01	02/05/2022	ABUL KALAM	AMAN SHRI	KMRK	ISSUED FOR PERFECTION

CUSTOMER: TELANGANA STATE POWER GENERATION CORPORATION LTD
 TELANGANA INDIA
 YADADRI TPS (5X600 MW)

OWNER'S CONSULTANT: TATA CONSULTING ENGINEERS LIMITED
 BANGALORE, INDIA

DESIGNER: BHARAT HEAVY ELECTRICALS LTD
 HYDERABAD

PROJECT: LIMESTONE DRY SILO AND WET BALL MILL AND SILO BUILDING

NO.	DATE	BY	CHK	APPD	REASON
01	02/05/2022	ABUL KALAM	AMAN SHRI	KMRK	ISSUED FOR PERFECTION

PROJECT: LIMESTONE DRY SILO AND WET BALL MILL AND SILO BUILDING

NO.	DATE	BY	CHK	APPD	REASON
01	02/05/2022	ABUL KALAM	AMAN SHRI	KMRK	ISSUED FOR PERFECTION