

**ANNEXURE A (BDS)****QUALIFICATION REQUIREMENT**

for

**Pre-Bid Tie up for 765kV GIS New Substation Package SS171T for a) Establishment of 765kV level at Kolhapur(PG) GIS. b) Extn. Of 400kV GIS at Kolhapur(PG) GIS associated with Network Expansion Scheme in Western Region to cater to pumped storage potential near Satara (up to 4500MW) - Part A" through Tariff Based Competitive Bidding (TBCB) route; Specification No..: CC/T/W-GIS/DOM/A00/26/06181**

**Name of Item: 765kV Gas Insulated Switchgear with Accessories**

**QUALIFICATION OF THE BIDDER**

Qualification of Bidder will be based on meeting the minimum pass/fail criteria specified below regarding the Bidder's Technical Experience and Financial Position as demonstrated by the Bidder's responses in the corresponding Bid Schedules. Technical experience and financial resources of any proposed subcontractor shall not be taken into account in determining the Bidder's compliance with the qualifying criteria. The bid can be submitted by an individual firm.

The Employer/POWERGRID may assess the capacity and capability of the bidder, to successfully execute the scope of work covered under the package within stipulated completion period. This assessment shall interalia include (i) document verification; (ii) bidders work/manufacturing facilities visit; (iii) manufacturing capacity, details of works executed, works in hand, anticipated in future & the balance capacity available for present scope of works; (iv) details of plant and machinery, manufacturing and testing facilities, manpower and financial resources; (v) details of quality systems in place; (vi) past experience and performance; (vii) customer feedback; (viii) banker's feedback etc.

**1.0 Technical Experience**

**(i)** The GIS must be offered from Indian manufacturer, who meets the requirement mentioned at **Route-1** or **Route-2** or **Route-3** as below. QR Credential must be submitted along with the bid.

**(ii)** GIS manufacturer must submit a Manufacturer Authorization Form (MAF) (format as per NIT) along with the Bid confirming that a legally enforceable Joint deed of Undertaking (format as per NIT) shall be submitted at the time of signing of contract.

**1.1 Route-1:**

The Bidder must have designed, manufactured, tested (as per IEC or equivalent standard), supplied and supervised erection & commissioning of at least One (1) nos. GIS Circuit Breaker bay\* of 715 kV or above voltage class in one (1) Substation or Switchyard and this bay must be in satisfactory operation# for at least Two (2) years as on the Originally scheduled last date of bid submission (soft copy) i.e. **28/05/2026**

**OR****1.2 Route-2:**

The Bidder, who has established manufacturing & testing facility in India for 715kV or above voltage level GIS but not meeting the requirement stipulated in para 1.1 above, shall also be considered provided that:

a.1) The bidder must have manufactured at least one (1) no. 715KV or above voltage level GIS Circuit Breaker bay\* based on the technological support of the Collaborator(s), provided that the Collaborator(s) meets the requirement stipulated in para 1.1 above. Further, the bidder must have either supplied or type tested the above GIS bay (as per IEC) as on the originally scheduled last date of bid submission (soft copy) mentioned above.

**ANNEXURE A (BDS)**

OR

a.2) i) The Bidder must have designed, manufactured, tested (as per IEC or equivalent standard), supplied and supervised erection & commissioning of at least Two (2) nos. GIS Circuit Breaker bays\* of 345 kV or above voltage level in one (1) Substation or Switchyard and these bays must be in satisfactory operation# for at least Two (2) years as on the Originally scheduled last date of bid submission (soft copy) mentioned above

a.2) ii) The Bidder must have technical collaboration for design, manufacture, test and supply 715kV or above voltage level GIS equipment with a GIS manufacture {Collaborator(s)} who meets the requirement stipulated in para 1.1 above.

b) The bidder shall also submit the following along with the bid:

i. A legally enforceable undertaking (jointly with the Collaborator(s)) to guarantee quality, timely supply, performance and warranty obligations as specified for the equipment(s);

ii. A confirmation letter from the Collaborator(s) stating that the Collaborator(s) shall furnish performance guarantee for an amount of 10% of the ex-works cost of such equipment(s). This performance guarantee shall be in addition to Contract Performance Guarantee to be submitted by the bidder.

iii. A valid collaboration agreement for technology transfer / license to design, manufacture, test and supply 715kV or above voltage level GIS equipment in India.

OR

**1.3 Route-3:**

The Bidder, who has established manufacturing & testing facility in India for 715kV or above voltage level GIS as Subsidiary/JVC/Group company by its parent/principal but not meeting the requirement stipulated in para 1.1 above, shall also be considered provided that-

a.1) The bidder must have manufactured at least one (1) no. 715KV or above voltage level GIS Circuit Breaker Bay\* based on the technological support of the parent/principal company, provided that the parent/principal meets the requirement stipulated in para 1.1 above. Further, the bidder must have either supplied or type tested the above GIS bay (as per IEC) as on the originally scheduled last date of bid submission (soft copy) mentioned above.

OR

a.2) i) The Bidder must have designed, manufactured, tested (as per IEC or equivalent standard), supplied and supervised erection & commissioning of at least Two (2) nos. GIS Circuit Breaker bays\* of 345 kV or above voltage level in one (1) Substation or Switchyard and these bays must be in satisfactory operation# for at least Two (2) years as on the Originally scheduled last date of bid submission (soft copy) mentioned above.

a.2) ii) The Parent/Principal of Bidder must meet the requirement stipulated in para 1.1 above.

b) The bidder shall also submit the following along with the bid:

i. A legally enforceable undertaking (jointly with the parent/principal company) to guarantee quality, timely supply, performance and warranty obligations as specified for the equipment(s);

ii. A confirmation letter from the parent/principal company stating that they shall furnish performance guarantee for an amount of 10% of the ex-works cost of such equipment(s). This

**ANNEXURE A (BDS)**

performance guarantee shall be in addition to Contract Performance Guarantee to be submitted by the bidder.	
iii. A valid collaboration agreement for technology transfer / license to design, manufacture, test and supply 715kV or above voltage level GIS equipment in India.	
<b>OR</b>	
<b>1.4</b>	<b>Route-4</b>
deleted	
<b>Note:-</b>	
<ol style="list-style-type: none"> <li>1. (#) Satisfactory operation means certificate issued by the Employer certifying the operation without any adverse remark.</li> <li>2. (*) For the purpose of qualifying requirement, one no. of circuit breaker bay shall be considered as a bay used for controlling a line or a transformer or a reactor or a bus section or a bus coupler and comprising of at least one circuit breaker, one disconnecter and three nos. of single phase CTs / Bushing CTs.</li> <li>3. In case bidder is a holding company, the technical experience referred to in Route-1, 2 &amp; 3 above as the case may be shall be of that holding company only (i.e. excluding its subsidiary/group companies). In case bidder is a subsidiary of a holding company, the technical experience referred to in Route-1, 2 &amp; 3 above as the case may be shall be of that subsidiary company only (i.e. excluding its holding company).</li> <li>4. In case bidder is an Indian entity and qualifying through Route-1, type test reports of Collaborator/ Parent Company/ Subsidiary Company/ Group Company shall also be acceptable, for which a confirmation shall be furnished along with the bid as per format attached in the bidding documents</li> <li>5. In case of package comprises of multiple voltage level in one GIS substation and/or Extension of more than one GIS Substation(s), GIS from different manufacturer(s) shall also be acceptable subject to the condition that one voltage class of GIS at any substation is supplied from one manufacturer only. In such cases bidder must submit MAF from all the proposed GIS Manufacturer(s) in their bid.</li> </ol>	
<b>2.0</b>	<b>FINANCIAL POSITION</b>
<i>Covered separately under Financial PQR of NIT</i>	
<b>3.0</b>	<b>JOINT VENTURE BID</b>
deleted	
<b>4.0</b>	The bidder shall furnish documentary evidence in support of the qualifying requirement stipulated as above.

PREPARED BY  
GORAV VIG  
DY. MANAGER-TBEM

4  
21/24  
5/6/26

REVIEWED BY  
MUNEET MEHTA  
Sr. DGM-TBEM

मूनीट

APPROVED BY  
MUNEET MEHTA  
Sr. DGM-TBEM

मूनीट

 <b>BHARAT HEAVY ELECTRICALS LIMITED</b> <b>TRANSMISSION BUSINESS ENGINEERING MANAGEMENT</b> <b>NOIDA</b>					
DOCUMENT NO.	Doc No. TB-PBTU-GIS-PGCIL-SS171T	Rev-00	Prepared	Checked	Approved
TYPE OF DOC.	TECHNICAL SPECIFICATION	NAME	GV	MM	MM
TITLE  765kV Gas Insulated Switchgear with accessories, and 400kV Gas Insulated Switchgear with accessories	SIGN		<i>[Signature]</i>	<i>[Signature]</i>	<i>[Signature]</i>
	DATE		04/06/26	04/06/26	04/06/26
	GROUP	TBEM			
	WO No.	--			
CUSTOMER	M/s Power Grid Corporation of India Limited (POWERGRID)				
CONSULTANT	---				
PROJECT	<b>Pre-Bid Tie up for 765kV GIS New Substation Package SS171T for</b> <b>a) Establishment of 765kV level at Kolhapur (PG) GIS.</b> <b>b) Extn. of 400kV GIS at Kolhapur (PG) GIS, associated with Network Expansion Scheme in Western Region to cater to pumped storage potential near Satara (up to 4500MW) - Part A" through Tariff Based Competitive Bidding (TBCB) route; Specification No.: CC/T/W-GIS/DOM/A00/26/06181</b>				
<b>Contents</b>					
Section No.	Description	Pages			
	Cover Sheet	01			
Section-1.1	Section-1 Part-A Scope Matrix for GIS Rev 05	16			
Section-1.2	Section-1 (Part-B)	03			
Section-1.3	Section-Project	22			
Section-1.4	Specific Requirement	30			
Section-1.5	BOQ (Bill of Quantity)	08			
Section-2	Equipment Specification under scope of Supplies	105			
Section-3	Project Details & General Technical Requirements	134			
Section-4	Annexures:				
	Standard Architecture drawing of 765kV GIS Building	03			
	Annexure V - Technical Specification for Scissor Man lift	03			
	Annexure- Drg - Existing Project drawings	03			
	Annexure A- Compliance Certificate	01			
	Annexure B- Schedule of Technical Deviations	01			
	Checklist for Technical Evaluation	01			
<b>Remarks:</b> Bidder to note that data and details of Guaranteed Technical Particulars shall not be reviewed during Technical Evaluation/ Review, hence compliance of Guaranteed Technical Particulars in line with Technical Specification has to be ensured by the bidder.					
Rev. No.	Date	Altered	Checked	Approved	
Distribution				To	
				Copies	

COPYRIGHT & CONFIDENTIAL  
 The information in this document is the property of BHARAT HEAVY ELECTRICALS LIMITED.  
 This must not be used directly or indirectly in anyway detrimental to the interest of the company.

## Contents

<b>1. SCOPE</b>	<b>2</b>
<b>2. SPECIFIC TECHNICAL REQUIREMENTS</b>	<b>3</b>
<b>3. GENERAL TECHNICAL REQUIREMENTS (Part-1 of 2)</b>	<b>3</b>
<b>4. GENERAL TECHNICAL REQUIREMENTS (Part-2 of 2)</b>	<b>5</b>
<b>5. MODE OF MEASUREMENT FOR GIB DUCT</b>	<b>6</b>
<b>6. STRUCTURE &amp; HARDWARE (INCLUDING STRUCTURE STEEL)</b>	<b>6</b>
<b>7. EARTHING MATERIALS OF GIS</b>	<b>8</b>
<b>8. INTERNAL CABLES</b>	<b>9</b>
<b>9. DRAWINGS / DOCUMENTS FOR MANUFACTURING CLEARANCE</b>	<b>9</b>
<b>10. TYPE TEST</b>	<b>10</b>
<b>11. QUALITY PLAN</b>	<b>11</b>
<b>12. SITE SERVICES</b>	<b>11</b>
<b>12.1.SUPERVISION AT SITE</b>	<b>11</b>
<b>12.2.TESTING &amp; COMMISSIONING</b>	<b>12</b>
<b>13. TESTING KITS, TOOLS &amp; TACKLES</b>	<b>13</b>
<b>14. SPARES</b>	<b>13</b>
<b>15. PACKING AND DISPATCH</b>	<b>14</b>
<b>16. SPECIFIC- EXCLUSIONS (NOT IN BIDDER'S SCOPE)</b>	<b>15</b>

This document covers broader guideline for bidder's scope of supply & services. The same shall be prevailing on all other section of technical specification.

## **1. SCOPE**

---

This technical specification covers the requirements of (1.) design, type testing, engineering, fabrication, manufacturing, shop assembly, inspection and testing at manufacturer's works, proper packing, supply and delivery to project site, (2.) supervision of material reconciliation, installation / erection, (3.) execution of site testing & commissioning along with necessary kits, tools & equipment , putting GIS with LCC & its Accessories into successful operation complete with all materials, support structures, anchoring bolts, chemical anchor, accessories, commissioning spares & maintenance spares, special spanners, special tools & tackles, any specific required ancillary services, SF6 gas for first filling & spare etc. including design studies, training of BHEL / Customer personnel for offered GIS & its Accessories complete in all respects for efficient & trouble-free operation mentioned under this specification.

The complete technical specification comprises of following sections:

- Section-1 : Scope, Project Specific Technical Specification & Bill of Quantities
- Section-2 : Equipment Specification under scope of Supplies
- Section-3 : Project Details & General Technical Requirements (For All Equipment under the Project)
- Section-4 : Annexures
  - Annexure A- Compliance Certificate
  - Annexure B- Schedule of Technical Deviations

The following order of priority shall be followed. In case of conflict between requirements specified in various documents, the more stringent one shall be followed. BHEL/Customer concurrence shall, however, be obtained before taking a final decision in such matters.

1. Statutory Regulations
2. Section-1(PART-A) Standard Scope Matrix
3. Section-1(PART-B)
4. Section-2
5. Section-3

Bidder shall furnish list of conflicts/ ambiguities/ deviations, if any, along with their technical offer and also furnish the basis that is considered for submitting technical offer. BHEL will address the bidder's listed conflicts prior to award. In case of ambiguity, bidder shall inform BHEL of their interpretation. In case bidder fails to convey the same prior to award, BHEL decision on interpretation shall be considered final if need arises during the execution. No additional cost or extra time on account of conflicts/ ambiguities/ deviations shall be admissible.

In general, no deviation from the requirements specified in various clauses of this specification shall be allowed and hence, a certificate to this effect shall have to be furnished along with the offer (Annexure-A), however bidder shall furnish list of conflicts/ ambiguities/ deviations (Annexure-B), if any.

**Please note**, any deviation not specifically brought out in Annexure-B (Schedule of Technical Deviations) shall not be admissible for any time and commercial implication at later stage. Except to the technical deviations listed in this schedule, bidder's offer shall be considered in full compliance to the tender specifications irrespective of any such deviation indicated / taken elsewhere in the submitted offer. Any conflicts/ ambiguities/ deviations mentioned elsewhere in technical offer shall not be reviewed.

The scope of supplies shall be as per commercial terms and conditions enclosed separately with the notice inviting tender/ enquiry.

## **2. SPECIFIC TECHNICAL REQUIREMENTS**

---

Project specific technical requirements shall be as per Section-1 (Part-B) of technical specification.

## **3. GENERAL TECHNICAL REQUIREMENTS (Part-1 of 2)**

---

1. SF6 gas for initial installation of complete GIS System, including wastage during installation, testing and successful commissioning shall be deemed included in the bidder's scope. Manufacturer to supply additional qty so as to cater the losses during installation, testing & commissioning.
2. The offered GIS with LCC & its Accessories shall be complete in all respect in compliance to technical specification and relevant IS / IEC / IEEE standards as applicable. Any other equipment/material required to complete the specified GIS scope of work are inclusive of bidder's scope of supply & services.
3. All essential and desirable accessories are deemed inclusive of offer i.e. and not limited to Gas Monitoring Devices, Pressure Switches, PD sensors, Pressure relief device, insulator, expansion joint/ flexible, bellows/ compensators like lateral mounting units, Axial compensators, Parallel compensators, tolerance compensators and vibration compensators etc. complete in all respect.
4. Total contract value may vary up to  $\pm 20\%$  at contract stage.
5. Any Item not quoted mentioned "**Not Applicable**" in bid price schedule and found applicable as per technical specification and system requirement shall be supplied free of cost by bidder without any time / cost implication to BHEL / Customer.
6. Length & route of GIB is purely indicative and same shall be finalized during detailed engineering stage.
7. BHEL reserve rights to amend Bay sequence during contract stage, no separate claim shall be admissible in this regard.
8. Supply scope of Testing & Maintenance Equipment – Scope of supply of following Equipments shall be applicable exclusively if covered in BOQ / BPS. However same shall not be used for erection/ installation, testing and commissioning of GIS, hence bidder to bring Special Tools &, tackles, Testing & Maintenance Equipment/ Instruments at site for during erection/ installation, testing & commissioning on returnable basis.
  - a. SF6 Gas leakage detector
  - b. Gas filling and evacuating plant: (Gas Processing unit)
  - c. SF6 gas analyser
  - d. Portable Partial Discharge(PD) monitoring system
  - e. Online Partial Discharge Monitoring System
9. Main Bus 1 / 2 / Transfer Bus etc. Gas Insulated Bus Bars running across the length of the switchgear to interconnect each of the bay modules (as per layout) and necessary interfaces (as applicable under the technical requirement) is

deemed inclusive in the scope. The same may or may not be indicated with break-up in BOQ / BPS.

#### **4. GENERAL TECHNICAL REQUIREMENTS (Part-2 of 2)**

---

Other general requirements GIS with LCC & its Accessories shall be as follows,

1. Guaranteed Technical Particulars: Bidder to submit detailed GTP in line with technical specification during contract stage for review and approval. GTP & drawings submitted with technical bid shall only be reviewed during contract stage only. Bidder to please note, deviations / conflict if any please be mentioned in schedule of technical deviations only.
2. The positioning of the circuit breaker in the GIS shall be such that it shall be possible to access the circuit breaker of any feeder from the front side for routine inspection, maintenance and repair without interfering with the operation of the adjacent feeders.
3. The physical layout shall ensure free movement of the SF6 Gas Cart and easy access to all components of the GIS for operation and maintenance purposes.
4. Bidder shall submit list of consumables with shelf life of less than six months and same shall be dispatched before commencement of erection or after clearance from BHEL/Customer whichever is earlier. No separate dispatch clearance shall be required for consumables. The service activities shall include consumables/ commissioning spares required during commencement of GIS installation, testing and commissioning in all respect. Cost of the same deemed inclusive.
5. Bidder shall offer their latest type tested model to accommodate the specified & allocated space as per attached layout drawing of GIS.
6. Bidder shall conduct insulation co-ordination studies in line with IEC for establishing surge arrester rating, quantity and any other requirement for successful operation of GIS. however, additional supply of surge arrester in line with above required shall be paid as per Bill of Quantity, as applicable.
7. Bidder to submit Study report of VFTO generated for 400kV GIS installation.
8. Bidder shall check and ensure adequacy of system protection for successful operation of GIS. After checking of system by bidder, GIS shall be installed and if any failure, malfunction of any part occurs after/ during commissioning, same shall be replaced immediately without any extra cost.
9. Final documentation shall be submitted in hard copy (Four prints) and soft (Three

CDs/DVDs)

10. In the case if CSD is specifically called in BPS / BOQ / Section-1(PART-B) of technical specifications, the same should have display facility at the front for the display of settings and measured values. In case where CSD does not have complete display facility for settings and measured values, bidder to supply one number laptop PC with pre-installed, licensed software for each site. Special cable required for integration is deemed inclusive in bidder's scope.
11. Bidder to submit all supporting documents in English. If document submitted by bidder is other than English language, self-attested English translated document should also be submitted.

## **5. MODE OF MEASUREMENT FOR GIB DUCT**

1. The price of Bus-duct inside the GIS hall (up to **outer** wall face of GIS Hall) shall be integral part of the respective bay module and it will not be paid separately. However, the payment of bus-duct for outside the GIS hall along with support structure shall be paid as per running meters in line with provision of Technical Specification & Bid Price schedule.
2. In the case of outdoor type GIS, Gas Insulated Bus Duct (GIB) length of bus duct outside the GIS BAY MODULE shall be considered for mode of measurement from the end of Bay equipment (VT, LA etc.) to end equipment (SF6 to air bushing / SF6 to oil bushing/ Cable connection module etc.).
3. Any change in bay pitch (distance between bays): In a case where shifting of GIS bays shall be called by BHEL (during contract stage) due to layout requirement / cost optimization / revision / change in civil architectural requirement or due to expansion joint requirement in the GIS building, Bidder to incorporate the same with full compliance of technical requirement. Payment equivalent of BPS / BOQ item under head "Gas Insulated Bus Duct" shall be operated for additional length of Main Bus, subject to such shifting is not attributed to bidder.

## **6. STRUCTURE & HARDWARE (INCLUDING STRUCTURE STEEL)**

Structural Steel, Support Structure, Walkway, Inserts & Hardware (required for installation & operation of complete GIS system with LCC & its Accessories etc.) are deemed inclusive of bidder's scope of supply. The same may or may not be indicated

with break-up in BOQ / BPS.

All steel structure members shall be hot-dip galvanized after fabrication (excluding floor embedded items for which standard practice is to be followed). All field assembly joints shall be bolted. Field welding shall generally not be acceptable. Noncorrosive metal or plated steel shall be used for bolts and nuts throughout the work.

The minimum weight of the zinc coating shall be 610 gm/sq.m and minimum average thickness of coating shall be 86 microns for all items having thickness 6mm and above and 900 gm/sq.m for coastal area (if defined in Section-1B / Section-2 of technical specification) For items lower than 6mm thickness requirement of coating thickness shall be as per relevant ASTM. For surface which shall be embedded in concrete, the zinc coating shall be 610 gm/sq.m minimum and **900 gm/sq.m for coastal area** (if defined in Section-1B / Section-2 of technical specification).

1. Lattice / Pipe structure Materials for support of GIS, Bus Ducts, SF6 to oil bushing/ SF6 to cable connection and SF6 to air bushing/ connection including Anchor Fastener Bolts, Foundation Bolts, Base Plate / Channel / Metallic / Structural Member for seating of GIS system, all floor and wall Embedded Items, wall crossing arrangements, Rails and/ or other items structural items as required. Manufacturer shall provide suitable foundation channels and anchor bolts to support the switchgear assemblies. All mounting bolts, Anchor Fasteners, foundation bolts, nuts and washers, equipment fixing hardware shall be provided to fasten the switchgear base frames to the foundation channels as applicable
2. Chemical / Mechanical Anchors Bolts are to be provided by bidder for GIS, GIB & SAB.
3. The GIS Equipment shall be complete with all necessary supports, ladders, galleries, staircases, catwalks, movable platforms or walkways (for accessing the equipment above two meters for maintenance and operation), mechanism cabinets, internal cable raceways etc. for each bay and it shall be of modular construction and extendable design.
4. Structural steel for complete GIS system with LCC & its Accessories is deemed inclusive in bidder's scope of supply.

**7. EARTHING MATERIALS OF GIS**

1. Earthing material of GIS are deemed inclusive of bidder's scope of supply. The same may or may not be indicated with break-up in BOQ / BPS.
2. Bidder to submit detailed calculations and layout drawings for earthing system during detailed engineering stage based on technical specification, bidder's design philosophy, IS/IEC/IEEE requirement as applicable. Bidder to provide the bill of quantity of entire GIS system with LCC & its Accessories
3. Supply of 40 mm MS ROD, 75X12 mm GI Flat, 50X06 mm GI Flat is not in bidder's scope of supply.
4. **COPPER GROUNDING MESH FOR GIS:** Bidder to consider scope of Copper Flat & hardware supply as follows

<b>A. If Requirement is called in Technical Specification</b>	
a. Bidder's Scope of Supply	If covered in BOQ / BPS.
b. Not in Bidder's Scope of Supply	If not covered in BOQ / BPS.
<b>c. In case COPPER GROUNDING MESH concluded as Not in Bidder's Scope of Supply (i.e. BHEL scope of supply) :</b> Copper Riser Connection for GIS equipment Shall be brought approximately <b>200</b> mm above the FINISHED FLOOR LEVEL shall be supplied by BHEL. Onward earthing connections for GIS equipment shall be in the scope of the bidder.	

<b>B. If Requirement is not exclusively called in Technical Specification but required as per manufacturer's design</b>	
a. Bidder's Scope of Supply	Required, even if a separate BOQ / BPS item is not indicated.

1. **All** other materials, including onward risers, earthing materials, hardware (nuts, bolts, washers, lugs, etc.) required as per the earthing design, shall be included in the GIS Manufacturer's scope of supply. However, the installation/erection of earthing will be carried out by the BHEL team under the supervision of the bidder/manufacturer, in accordance with the manufacturer's design.
2. Installation/ erection/ laying of earthing system for GIS shall be done by BHEL/ its contractor, however, supervision shall be provided by bidder as per approved design philosophy.
3. Special requirement for earthing (as mentioned in Section-2) shall be duly taken

care while designing the earthing system for GIS and its associated system.

Remark:- BPS: Bid Price Schedule & BOQ: Bill of Quantity with TS

## **8. INTERNAL CABLES**

1. Power, control & instrumentation cables for **Cabling** (1.) within GIS, (2.) GIS to LCC, (3.) LCC to LCC (excluding incoming power cable) shall be deemed inclusive in bidder's scope of supply. The same may or may not be indicated with break-up in BOQ / BPS.
2. Scope includes for completeness for GIS system with LCC & its Accessories
3. Cabling between LCC to LCC shall be applicable if required in bidder's design philosophy.
4. Cables required for bidder supplied GIS sub-system i.e. condition monitoring system (Gas monitoring system, PD monitoring system etc) are to be supplied by bidder as complete system.
5. Necessary Cable Lug, Glands & shroud etc. required for installation of bidder's supplied cable are deemed inclusive in bidder's scope.
6. Bidder to provide detailed "Bill of Quantity" during detailed engineering stage. Cabling & termination schedule for the same shall be provided by successful bidder along with AS BUILT drawing during contract stage.
7. Power Cable TB's (for both AC & DC incoming feeder cables) shall be suitable for termination of requisite cable.

## **9. DRAWINGS / DOCUMENTS FOR MANUFACTURING CLEARANCE**

The drawings/ documents, as follows shall be used for providing technical clearance for manufacturing of GIS and furthermore, it shall be used for delay analysis, if any, from bidder. The first drawing submission will be counted from the date of submitting reasonably correct drawings.

Sl. No.	Overall Drawings approval required in Cat I /Cat II
LOT-1	
1	GIS- Gas Schematics with Single Line Diagram (Including CT VT

	Parameters)
2	GIS- Guaranteed Technical Particulars (Including all GIS equipment)
3	GIS- Layout Plan & Section
4	GIS- Interfacing Drawings for Cable Connection Module / SF6 to Air Bushing / SF6 to Oil Module (as applicable under scope) with Guaranteed Technical Particulars
5	GIS- Type Test Reports (Including all GIS equipment)
6	GIS- Quality Assurance Plan & Inspection Test Schedule
LOT-2	
7	GIS- Secondary Engineering Base Design & Control Schematics for GIS and Local Control Cabinet
8	GIS- Maintenance Equipment Catalogue with Guaranteed Technical Particulars, test reports
9	GIS- Civil Design Specification with Foundation Loading Diagram (Including interfacing details)
10	GIS – Support Structure, Platform, Wall & Floor Inserts & Hardware drawing & BOM
11	GIS- Earthing Layout with Design
12	GIS- Quantification for main Items, Spares, Consumables
13	Design Calculations (Having interface on GIS Manufacturing)
OTHER	
14	GIS- 3D OGA Drawing (3D-Model with complete editable data base) compatible with Autocad & Primtech for complete GIS & its accessories.
15	Manuals on unloading, safe storage, transportation, installation, testing, commissioning, routine check, preventive maintenance

## **10. TYPE TEST**

Please refer Section-1(PART-B) and Section-2 of technical specification for the details of type test requirement. All equipment being supplied shall conform to type tests as per technical specification and shall be subject to routine & acceptance tests in accordance with requirements stipulated under respective sections of technical specification.

## 11. QUALITY PLAN

---

Bidder to follow valid customer approved (1.) Manufacturing Quality Pan, (2.) factory acceptance test (FAT) procedure & (3.) Site acceptance test (SAT) procedures, as per Customer procedure. In case the bidder doesn't have Customer approved Quality Plan, it will be the bidder's responsibility to get its Quality Plan approved from the ultimate Customer within 30 days from the date of issue of after award of LOI / PO whichever is earlier.

All materials shall be procured, manufactured, inspected and tested by vendor/ sub-vendor as per approved quality plan. The supplier shall perform all tests necessary to ensure that the material and workmanship conform to the relevant standards and comply with the requirements of the specification.

GIS and its associated materials shall be subject to inspection by BHEL/ Customer / authorized representative at bidder / manufacturing works. Hence, Bidder shall furnish all necessary information concerning the supply to BHEL. During fabrication, the equipment shall be subject to inspection by BHEL/ Customer or by an agency authorized by BHEL/ Customer to assess the progress of work as well as to ascertain that only quality raw material is used.

## 12. SITE SERVICES

---

Site service activities shall be carried out at in stages as per requirement or front availability at site, and hence multiple visits for completion of work are envisaged as per site requirements hence any claim in this regards shall not be admissible on account of multiple mobilization or idling during project execution stage.

### 12.1. SUPERVISION AT SITE

---

1. Supervision of complete installation / erection of GIS with LCC & its Accessories are in the scope of bidder.
2. Scope also includes verification of materials for proper storage with due

- instructions/ training to site persons for long storage.
3. Standard storage instruction manual specifically specifying the item detailed with details of type of storage.
  4. Supervision for reconciliation and spares / accessories and handing over to customer.
  5. Final documentation including AS BUILT documents

## **12.2. TESTING & COMMISSIONING**

---

1. The complete GIS System shall be subjected to the site tests as per technical specifications, IEC-62271-203. Bidder to submit site acceptance testing (SAT) procedures and get the same approved from BHEL / Customer before carrying out the site testing at site.
2. Carrying out successful HV/ Power Frequency Testing of GIS as per IEC shall be in scope of bidder, which includes HV test kit with operator, accessories & tools required for completion of HV testing. Bays may be commissioned separately.
3. BHEL shall provide extend support and assistance at site for smooth conduction of HV Testing including unloading, assembling of HV test kit, dismantling, packing & loading back for transportation.
4. Complete Field testing and commissioning of GIS system with LCC & its Accessories are under the scope of Bidder.
5. Bidder supplied special equipment, T&P if required OEM supervision, the same is to be arranged by bidder, cost of the same shall be deemed inclusive of respective item.
6. Bidder/ OEM shall coordinate with manufacturers of other equipment wherever required and shall freely and readily supply all technical information for this purpose as and when called for.
7. ETC work schedule for all the GIS may vary according to readiness of site. Respective dates for the commencement of erection, testing and commissioning activities of GIS shall be communicated to manufacturers from time to time as per the readiness of site.

### 13. TESTING KITS, TOOLS & TACKLES

---

1. All the Instruments/ Testing kits including HV Test Kit, SF6 Gas handling Equipments required for successful installation, testing, commissioning, maintenance of offered GIS are to be arranged by bidder on **returnable** basis. Cost of the same shall be deemed inclusive in the offer.
2. Special tools & tackles for installation, maintenance, testing & commissioning of GIS shall be in bidder's scope, it shall be brought at site on **returnable** basis only.
3. The general Tools and Tackles shall be provided by BHEL, list of the requirement i.e. general tools-tackle, spanners, gauges, slings and other lifting devices, crane, welding machines, drills, general instruments and appliances necessary for the installation of GIS is to be submit by bidder along the technical bid. In case bidder fails to convey the same along with technical bid, BHEL decision on interpretation of general tools tackle shall be considered final and any tools & tackles required shall be brought at site by bidder without any claim.
4. Bidder to furnish detailed BOQ for non-returnable special Tools and Tackles, if applicable along with unit prices to be handed over to ultimate customer. The prices for the same shall be considered during evaluation.

### 14. SPARES

---

1. Any equipment which is not supplied as main equipment or part of main equipment, mandatory spare for that is not applicable.
2. In case contractor offers circuit breaker, dis-connector, current transformer, SF6/Air Bushing etc. under main equipment of higher rating than equipment rating specified in the specifications, the mandatory spare of same higher rating offered by contractor identical to main equipment offered in the package shall be required to be supplied against spares without any cost implication.
3. The Mandatory Spares shall be included in the bid proposal by the bidder. The prices of these spares shall be given by the Bidder in the relevant schedule of Bid Price Schedule and shall be considered for evaluation of bid. It shall not be binding on the Employer to procure all of these mandatory spares.
4. The bidder is clarified that no mandatory spares shall generally be used during the commissioning of the equipment.
5. Start-up & Commissioning spares are included in bidder's scope of supply and

shall be included in the base price. Adequate stock of start-up & commissioning spares shall be made available at the site such that the start-up and commissioning of the equipment /systems, performance testing and handing over the equipment/ systems to the Purchaser can be carried out without any hindrance or delays. The unutilized Start-up & Commissioning spares brought for commissioning purpose by bidder shall be taken back by the bidder.

6. Wherever spares in BPS / BOQ/Technical Specification have been specified as "each type/each rating/each type & rating": If the offered spare/spares is sufficient to replace the respective main equipment of all types/ratings, then such offered spare/spares shall be acceptable. It implies that common spare/spare set fulfilling the spare requirement of all types/ratings shall also be acceptable, provided it is configurable at site itself without special assistance of OEM.
7. Mandatory Spares, wherever mentioned, are envisaged for the equipment/items being supplied under the main equipment heads under present scope meeting the requirements of Technical Specifications. The component/sub-component of an equipment/item specified in BPS / BOQ under Mandatory Spare, which is not applicable as per the offered design of respective main equipment, shall not be referred to.
8. Bidder to submit price break-up of spares during tender stage. It shall not be binding on the BHEL to procure all of these mandatory spares.
9. Bidder/ vendor shall ensure the availability of spare parts and maintenance support services for the offered equipment at least for 15 years from the date of supply. Bidder shall give a notice of at least one year to the Customer & BHEL (both) before phasing out the products/spares to enable the owner for placement of order for spares and services.

## **15. PACKING AND DISPATCH**

---

1. The equipment shall be carefully packed for transport by sea, rail and road in such a manner that it is protected against the climatic conditions and for any damage during transportation, transit and storage. Packing of the equipment shall be suitable for long storage (minimum 1 year).
2. The GIS transport units shall be shipped in the largest factory assembled units within transport and loading limitations and considering handling facilities on site to reduce the erection and installation work on site to a minimum. Where possible all items of equipment or factory assembled units shall be boxed in substantial

crates or containers to facilitate handling in a safe and secure manner.

3. Each individual piece to be shipped, whether crate, container or large unit, shall be marked special notations such as 'Fragile', 'This side up', 'Centre of gravity', 'Weight', 'Owner's particulars', 'PO no.' etc., and other details as per purchase order & technical specification.
4. The equipment may be stored outdoors for long periods before installation. The packing shall be completely suitable for outdoor storage in areas with heavy rains and high ambient temperature.
5. Special precautions shall be taken to protect any parts containing electrical insulation against the ingress of moisture. This applies particularly to the equipment of which each gas section shall be sealed and pressurized prior to shipping. Dry nitrogen/air or dry SF6 gas (in full compliance to technical requirement) shall be used and the pressure shall be such as to ensure that, allowing for reasonable leakage, it will always be greater than the atmospheric pressure for all variations in ambient temperature and the atmospheric pressure encountered during shipment to site and calculating the pressure to which the sections shall be filled to ensure positive pressure at all times during shipment.
6. All blanking plates, caps, seals, etc., necessary for sealing the gas sections during shipment to site shall be provided. Any seals, gaskets, 'O' rings, etc. that will be used as part of the arrangement for sealing off gas sections for shipment of site, shall not be used in the final installation of the equipment at site. Vendor to provide quantity of components accordingly considering permanent installation and commissioning.

## **16. SPECIFIC- EXCLUSIONS (NOT IN BIDDER'S SCOPE)**

---

The following items are specifically excluded from the bidder's scope of supply & services, irrespective of the same if covered under any section of technical specification other than Section-1 (PART-B). If specific requirement mentioned in the Section-1(PART-B) of technical specification shall overrule this specific exclusion.

1. Any scope of supply / services mentioned in Section-2 or Section-3 of technical specification but not having any relationship with GIS, LCC & its Accessories and not covered in Section-1(PART-B) or BPS / BOQ shall be deemed excluded from bidder's scope.

**Bharat Heavy Electricals Limited**  
**Standard Scope Matrix for Gas Insulated Switchgear**

**Section-1 (Part-A)**  
**Rev. 05**

2. Installation / Erection of GIS with LCC & its Accessories except supervision work.
3. Cable laying & terminations, however supervision work & termination of special cables shall be in bidder's scope.
4. Open & Closed stores at site. (Bidder to provide space requirement in tech bid)
5. Local transportation/ conveyance for bidder's engineers shall be arranged by BHEL between local stay and site.
6. Office assistance shall be provided BHEL including sitting facility etc.
7. Receipt & unloading of material at site except supervision work
8. Terminal connector for SF6 to Air Bushing to conductor or any other interfacing equipment.
9. Watch & Ward of GIS material at BHEL Store
10. Civil Works i.e. GIS Hall, civil works requirement for GIS System. (Please refer clause "Structure-Steel" for bidder's scope of supply)
11. EOT crane, Air Conditioning & Ventilation System, Illumination System & Fire detection & alarm system, however complete input shall be provided for EOT and other system
12. Control Relay & Protection Panels, Numerical Relays, Bus Bar Protection Panel, SAS & ECS system, ACDB, DCDB, Battery & Charger
13. Earthing material i.e. 40 mm MS Rod, 50X6 GI Flat & 75X12 GI Flat for earthing
14. Outdoor AIS Equipments
15. Power & Control cable beyond LCC towards ACDB, DCDB, CRP, SAS etc
16. BHEL / Customer / BHEL appointed 3rd party inspector travel, lodging & boarding charges during testing / inspection.

Rev Number	Date	Initiated by	Reviewed by	Approved by	Updates
Rev.0	19 Feb 2022	JAIK	SKS	AG	
Rev.1	04 March 22	JAIK			Clause 4.1 revised Clause 3.9 added Clause 5 900 gm/sq.m for coastal area
Rev.2	09 March 22	JAIK			Clause 5 updated (yellow highlight)
Rev.3 & 4	22 March 24	JAIK / DKS			Clarification on Copper Grounding Mesh. Ref clause 2.10 & other clauses
Rev.5	07/10/2024	JAIK/DKS			

Bharat Heavy Electricals Limited  
 Doc No. **TB-PBTU-GIS-PGCIL-SS71T**  
 Technical Specification  
**765kV and 400kV Gas Insulated Switchgear & its accessories**

**SECTION 1 (Part-B)**

This technical specification is required for Pre-bid tie-up before participation in the following tender:

Name of the Customer	Power Grid Corporation of India Ltd.
Name of Main Contractor	Bharat Heavy Electricals Limited
Name of the Project/ Tender	<b>Pre-Bid Tie up for 765kV GIS New Substation Package SS171T for a) Establishment of 765kV level at Kolhapur (PG) GIS. b) Extn. Of 400kV GIS at Kolhapur (PG) GIS associated with Network Expansion Scheme in Western Region to cater to pumped storage potential near Satara (up to 4500MW) - Part A" through Tariff Based Competitive Bidding (TBCB) route; Specification No.: CC/T/W-GIS/DOM/A00/26/06181</b>
Location	<b>Kolhapur in Maharashtra</b>

**[1] SPECIFIC TECHNICAL PARAMETERS:**

Please refer section 1.3 SECTION-PROJECT

**[2] BILL OF QUANTITIES:**

Please refer following:

**Section 1.5- ANNEXURE-BOQ\_GIS, Rev-00**

During tender stage, scope of GIS may vary. Exact Scope of GIS shall be finalized after receipt of Notification of award (NOA) from POWERGRID, however, overall contract value may vary upto +/- 20% during execution stage.

**[3] SPECIFIC TECHNICAL REQUIREMENTS:**

1. Please refer **SECTION.1.4 SPECIFIC REQUIREMENT FOR GIS (Rev.10)** for specific technical requirement & description of GIS modules/Equipment as per document.
2. Detailed technical requirement of GIS is as per **SECTION-2**.
3. Any other items not specifically mentioned in the specification but which are required for erection, testing and commissioning and satisfactory operation of the substation are deemed to be included in the scope of the specification unless specifically excluded.
4. Actions required in case of defects observed during Guarantee period:
  - a. a) SF6 gas leakage: Repair/ replacement
  - b. b) High Dew point of SF6 gas (> -36 deg C at atm press): Re-Processing of gas and replacement of Gas in case of no improvement
  - c. Replaced/Repaired/Refurbished Equipment (or part of equipment) shall have 2 years Guarantee without prejudice to contractual Guarantee period.
5. Any clarification(s) for **GIS** published by M/s POWERGRID with reference to subject project will also valid for this specification.
6. Zone tripping logic shall be developed in LCC by GIS vendor. Any contact multiplier and/or additional contacts required in density monitors shall be taken care by GIS vendor.

**[4] OTHER TECHNICAL REQUIREMENTS for GIS & OTHER ASSOCIATED EQUIPMENT:**

1. **SF6 GAS** REQUIRED FOR PLACING GIS INTO SUCCESSFUL OPERATION - Complete in all respect in compliance to technical specification and requirements.
2. **STRUCTURE MATERIAL** INCLUDING FOUNDATION BOLTS, EMBEDDED ITEMS, RAILS AND/ OR

OTHER MATERIALS ETC - Complete in all respect in compliance to technical specification and requirements.

3. **EARTHING MATERIAL**– Please review the "Reference Guidelines for GIS Grounding" in addition to Section-1 (Part-A) for a comprehensive requirement of the earthing material.

Please note (1.) 40 mm MS ROD, (2.) 75X12 GI Flat & (3.) 50X6 Cu Flat for GIS Floor earthing & Riser up to max 200 mm above FFL are NOT in Bidder's scope of supply.

**[5] SPECIFIC TECHNICAL REQUIREMENTS FOR CSD:**

1. CSD shall be deployed for optimization of switching behavior of bidder supplied GIS Breaker.
2. The limit for inrush current for switching of Transformer by CSD shall be 1.0 p.u. of rated current of transformer after fine tuning of CSD settings during pre-commissioning checks. For site acceptance of CSD, during online CSD test after fine tuning inrush current should be less than 1.0 P.U. of rated current in five consecutive operations.
3. All 765kV Circuit Breaker control schematics shall be finalized in such a way, that it may operate with or without CSD by using a suitable selector switch irrespective of whether circuit breakers to be supplied are envisaged along with CSD or not as per bid price schedules.
4. Complete interfacing with GIS and CSD shall be in bidder's scope. Any additional item like transducer, contact multiplication relay, switches, special/screened cables, modification hardwired, modification in schematics (if any) required for interfacing and for complying to the technical specification requirement shall be in bidder's scope and shall be included in quoted price. No price implication for the same shall be entertained during detailed engineering.
5. All wiring necessary for interface of GIS/ CRP with bidder supplied CSD is also deemed to be included in the scope of bidder. Cables, lugs, ties etc. required for connection of CSD in existing relay panel is deemed to be included in bidder's scope.
6. Supervision of Erection only and testing & Commissioning of CSD shall be in bidder's scope.
7. The CSD should have display facility at the front for the display of settings and measured values. In case where CSD does not have complete display facility for settings and measured values, bidder to supply one number laptop PC with pre-installed, licensed software for each site. Cost of the same shall be deemed included in offer.
8. Special cables (i.e., screened/ FO cable) other than 1100V LT Power & Control Cables required for CB / CSD / Relay Panel interfacing shall be in bidder's scope. Mode of measurement for special cable shall be cable-trench running length from GIS to CSD/ Relay panel. Total requirement of special cable qty. is to be estimated & supplied by bidder based on no. of runs etc.

**[6] TECHNICAL QUALIFYING REQUIREMENTS:**

Please refer following attached document for qualification criteria, Bidder to submit complete supporting documents required for technical qualifying requirement along with the bid.

Technical Qualifying Requirement shall be as per **Annexure-A (BDS)**

**[7] TYPE TESTING, INSPECTION, TESTING & INSPECTION CERTIFICATE:**

Please refer **Section-2** and **Section-3** of technical specification for the details of type test requirement.

All equipment being supplied shall conform to type tests as per technical specification and shall be subject to routine tests in accordance with requirements stipulated under respective sections.

The reports for all type tests as per technical specification shall be furnished by the bidder along with equipment / material drawings. However, type test reports of similar equipment / material already accepted in POWERGRID (in the projects similar to present project) shall be applicable for all projects with similar requirement. The type tests conducted earlier should have either been conducted in accredited laboratory (accredited based on ISO / IEC Guide 25 / 17025 or EN 45001 by the national accreditation body of the country where laboratory is located) or witnessed by POWERGRID/representative authorized by POWERGRID/representative of Utility /representative of accredited test lab/ representative of The National Accreditation Board for Certification Bodies (NABCB) certified agency shall also be acceptable.

Unless otherwise specified elsewhere, the type test reports submitted shall be of the tests conducted within last 15 (Fifteen) years from the originally scheduled last date of bid submission (soft copy) of tender of POWERGRID i.e. **28<sup>th</sup> May 2026**. In case the test reports are of the test conducted earlier than 15 (Fifteen) years from the originally scheduled last date of bid submission (soft copy) of tender of POWERGRID, the bidder shall repeat these test(s) at no extra cost to BHEL / POWERGRID.

Further, in the event of any discrepancy in the test reports i.e. any test report not acceptable due to any design/manufacturing changes or due to non-compliance with the requirement stipulated in the Technical Specification or any/all type tests not carried out, same shall be carried out without any additional cost and delivery implication to BHEL/POWERGRID.

The Bidder shall intimate BHEL with the detailed program about the type tests at least two (2) weeks in advance in case of domestic supplies & six (6) weeks in advance in case of foreign supplies.

Note – Type test report shall be reviewed for approval in detailed engineering stage only. However, for evaluation purpose, the test reports are to be submitted along with the technical bid.

**[8] ENCLOSED DOCUMENTS WITH SECTION-1:**

1. Section Project
2. Specific Requirements
3. Bill of Quantities
4. Technical Qualifying Requirement, Annexure-A (BDS)

-----XXXXX-----

**SECTION- PROJECT**

**TABLE OF CONTENTS**

<b>CLAUSE NO.</b>	<b>PARTICULARS</b>	<b>PAGE NO.</b>
1.0	GENERAL	2
2.0	SCOPE OF WORK	3
3.0	SPECIFIC EXCLUSIONS	15
4.0	PHYSICAL AND OTHER PARAMETERS	16
5.0	SCHEDULE OF QUANTITIES	16
6.0	BASIC REFERENCE DRAWINGS	17
7.0	DIFFERENT SECTIONS OF TECHNICAL SPECIFICATION	17
8.0	MANDATORY SPARES	18
9.0	SPECIFIC REQUIREMENT	19

*Technical Specification, Section – Project {Rev.00}*

*765kV GIS New Substation Package SS 171T for a) Establishment of 765kV level at Kolhapur (PG) GIS S/s and b) Extn. of 400kV GIS at Kolhapur (PG) GIS S/s associated with "Network Expansion Scheme in Western Region to cater to pumped storage potential near Satara (up to 4500MW) - Part A" through TBCB route*

## **SECTION- PROJECT**

### **1. GENERAL**

#### **1.1 Preamble:**

Power Grid Corporation of India Ltd. (POWERGRID), A Govt. of India Enterprise is responsible for Bulk Power Transmission of electrical energy from various central Govt. Power Projects to various utilities/ beneficiaries and interconnecting regional grids, operating and maintaining the National Electrical Grid of India. It is established with the mission of “We will become a Global Transmission Company with Dominant Leadership in Emerging Power Markets with World Class Capabilities by:

- a) World Class: Setting superior standards in capital project management and operations for the industry and ourselves
- b) Global: Leveraging capabilities to consistently generate maximum value for all stakeholders in India and in emerging and growing economies.
- c) Inspiring, nurturing and empowering the next generation of professionals.
- d) Achieving continuous improvements through innovation and state of the art technology.
- e) Committing to highest standards in health, safety, security and environment.”

**1.2** Govt. of India (MoP) has identified the execution of “*Network Expansion Scheme in Western Region to cater to pumped storage potential near Satara (up to 4500MW) - Part A*” through Tariff Based Competitive Bidding (TBCB) route. POWERGRID is intending to arrange for pre-bid tie-up for the scope envisaged.

**1.3** The following elements are envisaged under “*Network Expansion Scheme in Western Region to cater to pumped storage potential near Satara (up to 4500MW) - Part A*” through TBCB route:

#### **A. Substations:**

- i. Creation of 765kV level at Kolhapur (PG) GIS with installation of 2x1500 MVA, 765/400 kV ICTs at Kolhapur (PG) S/s along with upgradation of Kolhapur (PG) S/s to 765kV level.
- ii. Installation of 765 kV, 2x330 MVAR bus reactors at Kolhapur (PG) S/s.
- iii. Bay Works required for upgradation of Narendra (New) – Kolhapur (PG) 765 kV D/c line (presently charged at 400kV) to 765kV level.
- iv. Installation of 765kV, 330MVAR switchable line reactors on each circuit at Kolhapur (PG) end of Narendra (New) – Kolhapur (PG) 765kV D/c line.
- v. Establishment of 765/400 kV Satara Substation with 765/400 kV 3x1500 MVA ICTs, 765kV 2x330 MVAR bus reactors and 400 kV 1x125 MVAR bus reactor.
- vi. Creation of 400 kV Bus Section-II and augmentation of transformation capacity at 765/400 kV Satara S/s by 765/400 kV, 1x1500 MVA ICT (4th) along with 1x125 MVAR 400 kV bus reactor (on Bus Section-II).
- vii. 765kV, 240MVAR switchable line reactors on each circuit at Satara end of Kolhapur (PG) – Satara 765kV D/c line

#### **B. Transmission lines:**

- i. LILO of Pune-III – Pune (East) 765kV D/c line at Satara.
- ii. Kolhapur (PG) – Satara 765kV D/c line.
- iii. 765 kV line bays for Kolhapur (PG) – Satara 765kV D/c line

**1.4** It is the intent of this specification to describe primary features, materials, and design & performance requirements and to establish minimum standards for the work. The specification

*Technical Specification, Section – Project {Rev.00}*

*765kV GIS New Substation Package SS 171T for a) Establishment of 765kV level at Kolhapur (PG) GIS S/s and b) Extn. of 400kV GIS at Kolhapur (PG) GIS S/s associated with "Network Expansion Scheme in Western Region to cater to pumped storage potential near Satara (up to 4500MW) - Part A" through TBCB route*

## **SECTION- PROJECT**

is not intended to specify the complete details of various practices of manufactures/ bidders, but to specify the requirements with regard to performance, durability and satisfactory operation under the specified site conditions.

- 1.5** The work to be done under this specification shall include all labour, plant, equipment, material and performance of all work necessary for the complete installation and commissioning of switchyard. All apparatus, appliances, material and labour etc. not specifically mentioned or included, but are necessary to complete the entire work or any portion of the work in compliance with the requirements implied in this specification is deemed to be included in the scope of contractor.
- 1.6** Before proceeding with the construction work, the Contractor shall fully familiarize himself with the site conditions and General arrangements & scheme etc. Though the Employer shall endeavor to provide the information, it shall not be binding for the Employer to provide the same. The bidders are advised to visit the substation sites and acquaint themselves with the topography, infrastructure and also the design philosophy. The contractor shall be fully responsible for providing all equipment, materials, system and services specified or otherwise which are required to complete the construction and successful commissioning, operation & maintenance of the substation in all respects. All materials required for the Civil and construction/installation work including cement and steel shall be supplied by the Contractor.

Complete design (unless specified otherwise in specification elsewhere) and detailed engineering shall be done by the Contractor.

## **2. SCOPE OF WORK**

- 2.1 The broad scope for **Establishment of New 765kV Level at Kolhapur (PG) GIS & Extension of 400kV GIS at Kolhapur (PG) GIS** is as following:

S. No.	Scope
1.	<p><b>765/400kV Kolhapur (PG) GIS S/S</b></p> <p><b><u>765kV (Under scope of 765kV New GIS Substation Package-SS 171T):</u></b></p> <ul style="list-style-type: none"> <li>• 765/400kV, 1500 MVA ICT: 2 Nos. (7x500MVA single phase ICTs including 1x500MVA spare ICT) along with its auxiliaries</li> <li>• 765kV ICT bays: 2 Nos. (GIS)</li> <li>• 765kV, 330 MVAR Bus reactor: 2 Nos. (7x110 MVAR, 765/√3kV, 1-phase reactors including one spare unit for bus/line reactor) along with its auxiliaries</li> <li>• 765kV Bus Reactor bay: 2 Nos. (GIS)</li> <li>• 765kV, 330 MVAR Switchable Line Reactor: 2 Nos. (6x110 MVAR, 765/√3kV, 1-phase reactors) along with its auxiliaries</li> <li>• 765 kV Switchable Line Reactor bay: 2 Nos. (GIS)</li> <li>• 765kV Line Bays: 02 Nos. (GIS) (2Nos. for Kolhapur (PG)-Satara 765kV D/C line)</li> <li>• 765kV Line Bays: 02 Nos. (GIS) (2Nos. for Kolhapur (PG)-Narendra (New) 765kV D/C line (Presently charged at 400kV))</li> <li>• All associate Tie bays: 04 Nos. (GIS)</li> <li>• Future ICTs along with Bay: 1no.</li> <li>• Future Line with switchable reactor bays: 4nos.</li> <li>• Future Bus Reactor along with bay: 1no.</li> <li>• Future Tie bays: 3nos.</li> </ul>

*Technical Specification, Section – Project {Rev.00}*

*765kV GIS New Substation Package SS 171T for a) Establishment of 765kV level at Kolhapur (PG) GIS S/s and b) Extn. of 400kV GIS at Kolhapur (PG) GIS S/s associated with "Network Expansion Scheme in Western Region to cater to pumped storage potential near Satara (up to 4500MW) - Part A" through TBCB route*

## **SECTION- PROJECT**

	<p><b><u>400kV (Under scope of 765kV New GIS Substation Package-SS 171T):</u></b></p> <ul style="list-style-type: none"> <li>• 400kV ICT bays for 765/400kV ICT's: 2 Nos. (GIS)</li> <li>• 400kV Line Bay for interconnection with future Line#: 1 No. (“#”- 01 no. of 400kV GIS Line Feeder Bay shall be constructed for completion of 01 no. of diameter, which shall be utilized in future for termination of 400kV Line)</li> <li>• Line Bay with provision for interconnection with future Switchable Line Reactor Bay##: 1 No. (“##”- 01 no. of 400kV GIS Line Feeder Bay shall be constructed for completion of 01 no. of diameter, which shall be utilized in future for termination of 400kV Line along with Switchable Line Reactor)</li> <li>• Associate Tie Bay: 02 Nos. (GIS)</li> <li>• Extension of existing 400kV GIS Building for 2 Nos. Diameter under present scope.</li> <li>• Extension of existing 400kV GIS Main Bus-I &amp; II for interconnection with present scope 02 nos. 400kV Diameter.</li> </ul>
--	--

- Construction of 765/400 kV Satara Substation, Extension of 765kV Narendra GIS Substation and supply, erection, testing and commissioning of 765/400/33kV Transformers, 400/220/33kV Transformers, 765kV Reactors & 420kV Reactors are covered under separate package(s). However, associated work for 765/400/33kV Transformers & 765kV Reactors at Kolhapur (PG) GIS S/s, as described elsewhere in this document, is under present scope.

2.2 **The detailed scope of work of the substation package is brought out in subsequent clauses of this section.**

2.2.1 **765/400kV Kolhapur GIS Substation**

2.2.1.1 Design, engineering, manufacture, testing, supply including transportation & insurance, unloading, storage, erection, testing and commissioning at site of following equipment and items complete in all respect:

A **765kV Gas Insulated Switchgear**

The SF6 gas insulated switchgear (50 Hz) shall be of the indoor metal-enclosed type.

765kV SF6 gas insulated switchgear shall have one and a half breaker bus bar arrangement. The Switchgear shall be complete with all necessary terminal boxes, SF<sub>6</sub> gas filling, interconnecting power and control wiring, grounding connections, gas monitoring equipment & piping and support structures along with necessary base plate & foundation bolts. In addition all necessary stairs, platforms, supports, fixed ladders, portable scissor lift and walkways etc. as required for operation & maintenance work shall also be provided.

- a) 800kV GIS Modules/Equipment as per BPS and description given in **Annexure-IV**.
- b) Controlled Switching Devices as per BPS.
- c) Mandatory Spares for 800kV GIS as per BPS.
- d) Testing and Maintenance equipment & Motorised type Scissor lift as per BPS.
- e) EOT crane for GIS hall under present scope.
- f) Air conditioning system, Ventilation system and Fire Detection & Alarm System for GIS Hall & Relay Panel Room & AHU Room.
- g) Any other equipment/material required to complete the specified GIS scope of work.

*Technical Specification, Section – Project {Rev.00}*

*765kV GIS New Substation Package SS 171T for a) Establishment of 765kV level at Kolhapur (PG) GIS S/s and b) Extn. of 400kV GIS at Kolhapur (PG) GIS S/s associated with "Network Expansion Scheme in Western Region to cater to pumped storage potential near Satara (up to 4500MW) - Part A" through TBCB route*

## **SECTION- PROJECT**

### **B. 400kV Gas Insulated Switchgear**

The SF6 gas insulated switchgear (50 Hz) shall be of the indoor metal-enclosed type.

- The existing 400kV SF6 gas insulated switch gear is of **M/s HITACHI (ABB)** make and has one and a half breaker bus bar arrangement.
- Under Present scope, Extension of existing 400kV GIS Main Buses-I & II are envisaged for connection with present scope 400kV GIS bays, which is going to be placed in the extended portion of 400kV GIS Hall. The extension piece interface modules (for connection between present scope bus duct and existing bus duct) shall be as per BPS. Any modification required in the existing 400kV GIS building for this purpose is also deemed to be included in above BPS item(s).
- Extension of 400kV PEB GIS Building. Necessary Ventilation System, CRP room Illumination System, Fire Protection System, etc. for 400kV GIS Building extension portion will be designed and provided to meet the technical requirements. Building shall be extended in such a way that existing EOT crane can be used in areas of present scope for erection and maintenance purposes.

Further, present scope of work involves extension of EOT crane girders and all necessary Electrical & Mechanical accessories to facilitate movement of existing EOT crane in the extended portion of GIS hall. Cost of the same shall be deemed to be covered in the building cost.

The Switchgear shall be complete with all necessary terminal boxes, SF6 gas filling, interconnecting power and control wiring, earthing materials, grounding connections, gas monitoring equipment & piping and support structures along with necessary base plate & foundation bolts. In addition, all necessary stairs, platforms, supports, fixed ladders and walkways etc. as required for operation & maintenance work shall also be provided.

- a) 420kV GIS modules/Equipment as per BPS and description given in **Annexure-IV**.
- b) Controlled Switching devices as per BPS.
- c) Mandatory Spares for 420kV GIS as per BPS.
- d) Air conditioning system, Ventilation system and Fire detection & alarm system for extended portion of 400kV Hall & Local Control Relay Panel Room/AHU room.
- e) Any other equipment/material required to complete the specified GIS scope of work.

### **C. Air insulated switchgear (AIS) and Other Main Equipments**

- a) 765kV Class Bus Post Insulators including BPIs for Wave Trap (Pedestal Mounted), Surge Arresters, CVTs and Wave Traps as per BPS.
- b) 400kV Class Bus Post Insulators and Surge Arresters as per BPS.
- c) **ASSOCIATED WORK FOR 765kV CLASS POWER TRANSFORMERS & REACTORS:**

The following works pertaining to employer supplied 765kV Class Auto Transformers & Reactors, for the bays under present scope, as per details specified in Specific requirements rev-08, are covered under present scope

- i) Formation of neutral bus for each bank, auxiliary bus (765kV & 145kV) for switching of common spare reactor with Bus reactors and Switchable Line Reactors are in present scope of work.

*Technical Specification, Section – Project {Rev.00}*

*765kV GIS New Substation Package SS 171T for a) Establishment of 765kV level at Kolhapur (PG) GIS S/s and b) Extn. of 400kV GIS at Kolhapur (PG) GIS S/s associated with "Network Expansion Scheme in Western Region to cater to pumped storage potential near Satara (up to 4500MW) - Part A" through TBCB route*

## **SECTION- PROJECT**

- ii) Formation of neutral bus, Delta Bus for each bank of transformer, auxiliary bus (765kV & 400kV, neutral & Delta) for switching of spare transformer with Two banks of transformers are in present scope of work.
- iii) Overhead connection of HV, MV & LV bushings of  $(765/\sqrt{3})/(400/\sqrt{3})/33\text{kV}$  Autotransformers and HV & Neutral bushings of 765/ $\sqrt{3}$ kV Reactors to substation equipment's.
- iv) Supply, laying and termination of cables along with associated accessories from Common marshalling box of  $(765/\sqrt{3})/(400/\sqrt{3})/33\text{kV}$  Autotransformers & 765/ $\sqrt{3}$ kV Reactors to BMK /Switchyard Panel Rooms/Relay panel room/Control Room/Auxiliary Building as per requirement.
- v) NGR Bypass arrangement for Line Reactors through 145kV Circuit Breakers, Bus Post Insulators along with associated support structures, clamps and connectors, conductors, spacers etc.
- vi) 33kV neutral CT for each bank of transformers and Line Reactors.

d) **CONTROL, RELAY & PROTECTION SYSTEM:**

Complete control, relay and protection system as per Section–Control and Relay panels for the 765kV & 400kV bays covered under present scope.

**New 765kV Bus bar protection**

- New Decentralized (distributed) type of Low Impedance Bus bar Differential protection system shall be provided for Kolhapur GIS Substation at 765kV Level along with Peripheral units of the bays covered under present scope. However, Central unit must have capability to accommodate all present and future 765kV bays as per clause no 2.1 above.

**Augmentation of 400kV Bus bar Protection**

- Centralized type of Bus bar protection is available at Existing 400kV Voltage Level at Kolhapur GIS Substation of Make – Hitachi (ABB) and Model – REB670. Existing Bus bar Protection relay has the capacity to accommodate present scope 400kV GIS bays.
- Under present scope, Augmentation of existing Busbar Protection scheme for bays under present scope shall be carried out by contractor. Further, necessary modifications as required for completion of Bus bar protection including auxiliary / trip relays, wiring, etc. for completion of the bus bar protection scheme for bays under present scope must be carried out by contractor and cost of the same shall be deemed to be included under installation item for Augmentation of Bus bar protection of BPS. Any modification required in the existing protection scheme is also included in the present scope.

e) **SUBSTATION AUTOMATION SYSTEM:** Augmentation of Substation Automation System for bays as per BPS (bay as defined in technical specification, Section-Substation Automation System):

- 765kV Main bays - 8 Nos
- 765kV Tie bays - 4 Nos
- 765kV Switchable Line Reactor bays – 2 Nos
- 400kV Main bays - 4 Nos
- 400kV Tie bays - 2 No

*Technical Specification, Section – Project {Rev.00}*

*765kV GIS New Substation Package SS 171T for a) Establishment of 765kV level at Kolhapur (PG) GIS S/s and b) Extn. of 400kV GIS at Kolhapur (PG) GIS S/s associated with "Network Expansion Scheme in Western Region to cater to pumped storage potential near Satara (up to 4500MW) - Part A" through TBCB route*

## **SECTION- PROJECT**

Existing Kolhapur GIS Substation is equipped with substation automation system (based on IEC-61850) of Make – Hitachi (ABB - MicroSCADA). Under present scope, the Bidder shall include BCUs required for bays mentioned above, including all necessary hardware & software to integrate with the existing substation automation system.

Contractor shall integrate the present scope Auxiliary system control & monitoring signals with the existing SCADA by either making necessary Augmentation of existing Auxiliary BCU or making provision in present scope IEDs. Cost of the same is deemed to be included under Augmentation of SAS items of BPS.

The scope of bidder shall include but not limited to integration of bays under present scope of work with existing substation automation (which is based on IEC 61850) and capability enhancement of same as required, including License, up-dating of system database, displays, development of additional displays and reports as per requirement.

The necessary interface and integration work at Gateway for remote operation from NTAMC, Backup NTAMC, RTAMC & supervision from RLDC (RSCC)/NLDC through optical fibre based SDH communication link is also under present scope. However, no work is envisaged at remote end (RLDC/NLDC/NTAMC/RTAMC etc.) in the present scope.

Integration of CSD (under present scope), RTCC Relays (owner supplied), On-line Oil Drying system (owner supplied) and other accessories based on IEC-61850 for Owner supplied 765/400kV class Transformers/reactors, IEC 61850 compatible controllers for auxiliaries etc. with substation automation system along with supply of associated Ethernet switch, LIU patch cords etc. as required, is also included under present scope.

- f) The **lightning protection (DSLPP)** for area under present scope including 765/400kV Transformers (Owner supplied), 765kV Reactors (Owner supplied), 765kV New GIS Building, 400kV extended GIS Building is to be provided by the contractor. The contractor shall design the lightning protection by utilizing the existing Structures & structures being provided under present scope. In case, additional structures (Lightning Masts) are required to meet the lightning protection, same shall be paid in metric tonnage. The associated civil works shall be payable as per relevant item of BPS, however, earthing of the LMs, buildings as required shall be deemed to be included as part of Erection Hardware BPS item for bays & no additional payment shall be admissible under this head.
- g) **FIRE PROTECTION SYSTEM:**
- (i) Fire protection system including HVW spray system, hydrant system and complete piping including all accessories etc. for 765/400kV ICTs (Owner supplied) & 765kV Reactors (Owner supplied) under present scope. The existing piping (for Fire protection system) shall be suitably extended from the existing nearest available header at site for this purpose. Under the present scope, contractor shall integrate the annunciation/alarm signals of 765/400kV ICTs (Owner supplied) & 765kV Reactors (Owner supplied) with the existing Annunciation panels placed in the existing FFPH building & Control room Building. This shall include all necessary items/cables etc. including Capacity enhancement/augmentation of existing Fire protection panels as required. No additional payment shall be admissible under this head and cost of the same shall be deemed to be included under respective BPS item of Fire protection of Transformer/Reactors.
- (ii) Extension of existing hydrant system from the nearest available existing header for New 765kV GIS building, extended portion of 400kV GIS building & Auxiliary Building is envisaged under present scope of work. The cost of the same shall be deemed to be included under BPS item of Fire protection of system outside Pump House for Fire Protection of 765/400/220kV (Ext) Substation.

*Technical Specification, Section – Project {Rev.00}*

*765kV GIS New Substation Package SS 171T for a) Establishment of 765kV level at Kolhapur (PG) GIS S/s and b) Extn. of 400kV GIS at Kolhapur (PG) GIS S/s associated with "Network Expansion Scheme in Western Region to cater to pumped storage potential near Satara (up to 4500MW) - Part A" through TBCB route*

## **SECTION- PROJECT**

- (iii) Any dismantling, modification and shifting of existing piping (if required) at site for the above-mentioned scope for Transformers, Reactors, New/extended GIS buildings, Auxiliary Building is also envisaged under present scope of contractor. No additional payment shall be admissible under this head and cost of the same shall be deemed to be included under BPS item of Fire protection of system outside Pump House for Fire Protection of 765/400/220kV (Ext) Substation.
- (iv) Fire detection & Alarm system shall be provided for New 765kV GIS Hall including CRP Room/AHU room, extended portion of 400kV GIS Hall including CRP Room/AHU room and Auxiliary Building.

Integration of present scope Fire zone alarm & annunciation signals for New 765kV GIS Hall including CRP Room/AHU room, extended portion of 400kV GIS Hall including CRP Room/AHU room and Auxiliary Building with the existing Fire Fighting Annunciation cum Alarm Panel & further integration with existing SAS is also covered under present scope of contractor. All necessary items/cables etc. including Capacity enhancement/augmentation of existing Fire protection panels as required for the above said work shall be provided by the contractor under present scope & cost of the same shall be deemed to be included under respective BPS items of Fire detection & Alarm system for GIS Buildings/Auxiliary building.

- h) **Battery and Battery chargers:** The capacity of Battery & Battery charger shall be worked out by contractor for the New 765kV level being constructed under present scope of work including all present scope 765kV bays & all future 765kV bays as per clause no 2.1 above and shall be submitted for Employer's approval.

However, minimum capacity of each battery bank for 220V set and 48V set shall be 750AH. Further, the minimum rating of each battery charger for 220V set and 48V set shall be 100A. In case, battery and battery chargers of higher capacity/rating are required to cater the load requirement based on design calculations during detailed engineering, same shall be provided by contractor without additional cost.

New battery & Battery Charger shall be placed inside the New Auxiliary building under present scope of work.

- i) **LT SWITCHGEAR:**

- Adequate feeders for Oil filtration unit required for Owner supplied Transformers & Reactors are available in 415V MSB (located in Control Room building). Necessary cabling and connections of these modules with the existing 415V ACDB Busses shall be in the present scope.

- **ACDB EXTENSION:**

Extension of existing 415V ACDB placed in the existing Control room Building with the following requirement:

- a) Providing 2 nos. Panel (i.e. ACDB-1 & ACDB-2), which shall be placed in New Auxiliary building, for catering the AC loads required for 765kV system as per the specified present scope of work, including future provisions, in line with the LT SLD drawing no. C/ENGG/STD/LTSWGR765/SLD/01 Rev-0. These ACDB-1 & 2 panels shall be connected with the existing 415V ACDB Panel through 1.1kV, 3.5Cx300sqmm XLPE cable, to be paid under respective BPS item of XLPE Power Cable (i.e. ACDB-1 shall be connected with existing ACDB DG Section-1 & ACDB-2 shall be connected with existing ACDB NON-DG Section-2).
- b) Each 415V ACDB-1 & 2 Panels to be placed in New Auxiliary building as above,

*Technical Specification, Section – Project {Rev.00}*

*765kV GIS New Substation Package SS 171T for a) Establishment of 765kV level at Kolhapur (PG) GIS S/s and b) Extn. of 400kV GIS at Kolhapur (PG) GIS S/s associated with "Network Expansion Scheme in Western Region to cater to pumped storage potential near Satara (up to 4500MW) - Part A" through TBCB route*

## **SECTION- PROJECT**

shall include – One number incoming feeder module (400A, 4P MCCB), Ten number outgoing feeder modules (10x63A, 4P MCCB), Four number outgoing feeder modules (4x100A, 4P MCCB) & Eight number outgoing feeder modules (8x32A, 4P MCB).

- c) Existing 415V ACDB Panel in the Control room Building has sufficient vacant space available at each section & following work is envisaged under contractor scope:
- i. Providing 1 no. x Outgoing feeder module (400Amp, 4P MCCB), 1 no. x Outgoing feeder module (200Amp, 4P MCCB), 2 nos. x Outgoing feeder modules (63Amp, 4P MCCB) and 4 nos. x Outgoing feeder modules (32Amp, 4P MCB) at vacant space available in each section of existing ACDB.
  - ii. Suitable modification required in the existing ACDB panel for successful installation of above mentioned MCCBs/MCBs with necessary cabling and connections with the existing 415V ACDB Busses is also covered under the present scope of work.

➤ **MLDB EXTENSION:**

Extension of existing 415V Main Lighting Distribution Board (MLDB) placed in the existing Control room Building with the following requirement:

- i. Providing 4 nos. x Outgoing feeder modules (63Amp, 4P MCCB) at Existing 415V MLDB. The vacant space for mounting of these MCCBs are available in the existing 415V MLDB. Necessary cabling and connections of these modules with the existing 415V MLDB Busses shall be in the present scope.

➤ **ELDB EXTENSION:**

Extension of existing 415V Emergency Lighting Distribution Board (ELDB) placed in the existing Control room Building with the following requirement:

- i. Providing 4 nos. x Outgoing feeder modules (63Amp, 4P MCCB) at Existing 415V ELDB. The vacant space for mounting of these MCCBs are available in the existing 415V ELDB. Necessary cabling and connections of these modules with the existing 415V ELDB Busses shall be in the present scope.

➤ **220V DCDB EXTENSION:**

Extension of existing 220V DC Distribution Boards (DCDB-1 & 2) placed in the existing Control room Building with the following requirement:

- i. Providing 8 nos. x Outgoing feeder modules (32Amp, 2P MCB) at vacant space available in each existing 220V DCDB-1 & 2. The vacant space for mounting of these MCBs are available in the existing 220V DCDBs. Necessary cabling and connections of these modules with the existing 220V DCDBs Busses shall be in the present scope.

➤ **220V NEW DCDBs:**

Providing 2 nos. Panel (i.e. 220V DCDB-1 & DCDB-2), which shall be placed in the New Auxiliary building, for catering the 220V DC loads required for 765kV system as per the specified present scope of work, including future provisions, in line with the LT SLD drawing no. C/ENGG/STD/LTSWGR765/SLD/01 Rev-0. These New DCDBs

*Technical Specification, Section – Project {Rev.00}*

*765kV GIS New Substation Package SS 171T for a) Establishment of 765kV level at Kolhapur (PG) GIS S/s and b) Extn. of 400kV GIS at Kolhapur (PG) GIS S/s associated with "Network Expansion Scheme in Western Region to cater to pumped storage potential near Satara (up to 4500MW) - Part A" through TBCB route*

## **SECTION- PROJECT**

panel shall be connected with the new Battery & Battery charger envisaged under the present scope.

➤ **48V NEW DCDBs:**

Providing 2 nos. Panel (i.e. 48V DCDB-1 & DCDB-2), which shall be placed in the New Auxiliary building, for catering the 48V DC loads required for 765kV system as per the specified present scope of work, including future provisions, in line with the LT SLD drawing no. C/ENGG/STD/LTSWGR765/SLD/01 Rev-0. These New DCDBs panel shall be connected with the new Battery & Battery charger envisaged under the present scope.

- j) **1.1kV POWER & CONTROL CABLE:** 1.1 kV grade Power & Control cables (and special cables, if any) along with complete accessories including cables for oil filtration units and cabling from common marshalling box of owner supplied 765kV Transformers & Reactors to Relay panel room/control room. Power receptacle for oil filtration unit shall also be provided under present scope of work as per BPS. Cable Sizes Shall be used as per Sizing of 1.1kV Power & Control cables specified as per Annexure-S1 (Revised) enclosed with Section: Project at **Annexure-VI**.
- k) **AIR CONDITIONING & VENTILATION SYSTEM:** Air conditioning system for New 765/400kV CRP Room, Auxiliary Building and Ventilation system for New 765kV GIS Hall & extended portion of 400kV GIS Hall are covered under present scope of work.
- l) **MAIN EARTHMAT:** As per BPS
- The Main Earthmat in some parts of the present scope switchyard area is already existing. The existing main earthmat shall be extended for the balance portion of switchyard area covered under the present scope keeping the existing grid spacing (15m x 15m). The Payment against main earthmat shall be regulated as per actual Length laid at site. Existing Earthmat drawing shall be provided to successful bidder during detailed engineering.
- All the equipment's (including owner supplied 765kV class Transformers and Reactors), structures, Buildings, cable trenches, auxiliary earthmat etc. under present scope shall be earthed by connecting them to the main Earthmat by the contractor. Cost against the same shall be deemed to be included in the respective BPS items under Erection Hardware.
- For 765/400kV GIS grounding inside the GIS building, contractor shall refer Annexure-S10 of Specific requirement, Rev 10 and the same shall be deemed to be included as Part of GIS equipment.
- m) **Erection Hardware:** This item of BPS includes Long rod/Disc Insulators (as applicable), Insulator Strings Hardware, conductor(s), Al tube, bus-bar materials, cable trays & covers, Bay MB, spacers, clamps & connectors (including terminal connectors for 765kV, 400kV etc bushings of Employers supplied Transformers & Reactors), Junction box, earthwire, earthing material risers, auxiliary earthmat (excluding main earth mat), buried cable trenches/pipes for equipment & lighting, cable supporting angles/channels Cable pull pit, cable trays & covers, Insulating mats, cable sealing arrangement, insulator guy arrangement all accessories etc. as required.
- Erection Hardware under respective BPS Item shall also cover the Earthing of all the equipments including cable trenches etc & scope shall include Earthing of employer-supplied Transformers & Reactors by connecting them to the main Earthmat.
- n) **PLCC equipments** Supply, Erection, Testing & Commissioning of PLCC/DPC system for 765kV Kolhapur-Narendra D/C line and 765kV Kolhapur-Satara D/C line at Kolhapur GIS

*Technical Specification, Section – Project {Rev.00}*

*765kV GIS New Substation Package SS 171T for a) Establishment of 765kV level at Kolhapur (PG) GIS S/s and b) Extn. of 400kV GIS at Kolhapur (PG) GIS S/s associated with "Network Expansion Scheme in Western Region to cater to pumped storage potential near Satara (up to 4500MW) - Part A" through TBCB route*

## **SECTION- PROJECT**

Substation is covered under separate Package(s). However, Integration of these PLCC/DPC panels with CRP & SAS at Kolhapur GIS substation including necessary Cabling and connection works with PLCC/DPC Panel is envisaged under present scope.

**o) ILLUMINATION SYSTEM:**

LED based Lighting and illumination system for the switchyard area under present scope and Auxiliary Building, 765kV New GIS buildings & extended portion of 400kV GIS building (including relay panel rooms & AHU rooms) etc. shall be provided by the contractor. Illumination system shall be provided using the fixture types as specified in Technical Specification Section-Lighting System. Further, contractor shall submit lighting design calculation for finalizing the number of fixture in the Auxiliary Building, 765kV New GIS Buildings & extended portion of 400kV GIS building, in line with Annexure-III (Specific Requirement, Rev-10).

- p) Augmentation of Visual Monitoring System (VMS) for area under present scope.** Specification as described at Specific Requirement REV-10 to be referred to. Make of Existing VMS system is Milestone. The contractor shall provide total 6 no. of Fixed Color IP Camera suitably located in the 765kV/400kV GIS buildings and total 8nos Color IP camera with PAN, Tilt & Zoom facility suitably located in present scope 765kV and 400kV outdoor Switchyard. The scope of contractor shall include all items, accessories, line interface units, Fibre patch cards, Power supply units, Junction boxes, cables, Fibre optic cables, Hardware and software including License etc., as applicable to meet functional requirements. Compatibility and capability enhancement of exiting VMS system, if needed, shall be done to integrate present scope visual monitoring system with existing Visual monitoring system of the station.

The cameras to be supplied under present scope are also to be integrated with existing Qognify make (Formerly NICE Vision) NVR of NTAMC system at site. All SDK (Software development kit)/APIs (Application programming interface) is in the scope of bidder. Camera license(s) in NTAMC NVR shall also be under the scope of the bidder. Advisory on deployment of CCTV issued by Ministry of Electronics and Information Technology (MEITY) shall be followed.

**q) TELECOMMUNICATION SYSTEM:**

The broad Scope of the procurement of FO based Communication Equipment shall include planning, designing, engineering, supply, transportation, insurance, delivery at site, unloading handling, storage, installation, termination, testing, training and demonstration for acceptance, commissioning and documentation for following:

- i) SDH Equipment along with suitable interfaces and line cards.
- ii) All cabling, wiring, Digital Distribution frame patch facilities and interconnection to the supplied equipment at the defined interfaces,
- iii) System integration of all supplied subsystem
- iv) Integration with the existing communication system based on SDH and PDH of employer
- v) Integration of supplied subsystem with SCADA system, PLCC equipment, PABX of RLDC/SLDC, VOIP (SIP compliant) for voice.
- vi) Fibre Optic Approach Cable (FOAC) along with Duct, GI PIPE, GI Elbow, GI FLEXIBLE CONDUIT and Fibre Optic Distribution Panel (FODP)
- vii) Integration of new Communication equipment in the existing regional NMS. All required support to existing NMS vendor for integration of new Communication equipment.
- viii) Validity of Type Test for GA&C communication equipment (Like FOTE, Fibre Optics Cable, OPGW, DG Set, Battery bank and Charger etc.) shall be as per CEA Guidelines January 2026.

*Technical Specification, Section – Project {Rev.00}*

*765kV GIS New Substation Package SS 171T for a) Establishment of 765kV level at Kolhapur (PG) GIS S/s and b) Extn. of 400kV GIS at Kolhapur (PG) GIS S/s associated with "Network Expansion Scheme in Western Region to cater to pumped storage potential near Satara (up to 4500MW) - Part A" through TBCB route*

## **SECTION- PROJECT**

- r) **PHASOR MEASUREMENT UNIT (PMU):**
- i) The broad Scope of the procurement of PMU shall include planning, designing, engineering, supply, transportation, insurance, delivery at site, unloading handling, storage, installation, termination, testing and demonstration for acceptance, commissioning, and documentation for PMU as per BPS.
  - ii) The PMU shall comply with latest version of IEC/IS 60255-118-1-2018 and IEEE C 37.118.2 protocols standards.
  - iii) The PMU shall be integrated with Phasor data Concentrator (PDC) at respective Regional Load Dispatch Centre (RLDC)/State Load Dispatch Centre (SLDC).
  - iv) The Contractor shall extend technical support at Substation end for seamless integration of PMU with PDC at respective RLDC/SLDC end. The integration work at RLDC/SLDC end will not be under the scope of the Contractor. The PDC at RLDC/SLDC is of M/s GE make.
  - v) The PMU supplied in this project shall support measurement of voltages and currents of at least 2 feeders/bays.
  - vi) All cabling and interconnections for extension of CT/CVT, Digital inputs from the Line Bays, ICTs/Reactors/STATCOM bays up to PMU panel for measurement by PMU, shall be in the scope of the Contractor. Accordingly, the associated 1.1KV Control cables as required for Non-Adjacent Inter- Control and Relay panel (CRP) CT /PT connections & Digital input connections to PMU panel shall also be under the Contractor's scope. The scope of these cabling work (supply, laying & termination), as applicable in the subject project, shall be deemed to be included in the price of PMU equipment.
  - vii) Validity of Type Test for PMU shall be as per CEA Guidelines January 2026.
- s) Any other equipment/material required to complete the specified scope.

2.2.1.2 Design, engineering, manufacture, testing, supply including transportation & insurance, unloading, storage, testing at site of Mandatory spares as per bid price schedule. The Break-up of Mandatory Spares for items except GIS Equipment shall be as per Annexure-II.

### 2.2.1.3 Civil works

The design of foundation shall be based on the soil investigation report and other parameters as per relevant IS codes & technical specification.

#### A. The scope of civil work shall include but not be limited to the following based on drawings supplied by POWERGRID.

- i. **Foundation for Gantries, LM & Equipment support structure.**
- ii. **Road:** Road shall be constructed as per tender drawing. However, Road layout shall be prepared by contractor and submitted to POWERGRID for approval.
- iii. **Transformer and Reactors:** Foundation of all Transformers and Reactors including, Rail cum road, unloading platform, jacking pad, Oil Pit/Common Oil pit, pulling blocks as per technical specification.
- iv. **Auxiliary Building as per drawing.**
- v. **Cable Trenches:** Cable trenches including cable trenches in Reactor/Transformer area along with covers including road/rail crossing, sump pits, culverts etc. shall be constructed as per POWERGRID standard drawings provided in tender. However, Cable trench layout shall be prepared by vendor for approval of POWERGRID based on the cable trench sections available in Tender Drawings. Cable Trenches shall be measured in running meters. The rate

*Technical Specification, Section – Project {Rev.00}*

*765kV GIS New Substation Package SS 171T for a) Establishment of 765kV level at Kolhapur (PG) GIS S/s and b) Extn. of 400kV GIS at Kolhapur (PG) GIS S/s associated with "Network Expansion Scheme in Western Region to cater to pumped storage potential near Satara (up to 4500MW) - Part A" through TBCB route*

## **SECTION- PROJECT**

shall include the cost of all works such as excavation, PCC, RCC, Reinforcement Steel, Miscellaneous Structural Steel, inserts, embedment, NP-3 RCC Hume pipes in crossings etc. Cable Trench together with its cover shall be measured in running meter for payment purpose.

- vi. **Drains:** Storm water Drain layout shall be prepared by contractor based on the drain sections available in Tender drawings and to be submitted for approval of POWERGRID. Drains shall be measured in running meters. The rate shall include the cost of all works such as excavation, PCC, RCC, Reinforcement Steel, brickwork, screed concrete, plastering, MS grating, NP-3 RCC Hume pipes in crossings, culvert etc. as per drawings and technical specifications.
- vii. **Switchyard Gate** as per drawing.
- viii. **Switchyard barbed wire fencing:** Fence layout shall be prepared by vendor and to be submitted for approval of POWERGRID based on the standard sections.

### **B. The scope of civil work shall include but not be limited to the following based on drawings developed by Contractor.**

#### **i. Site levelling work**

- a. The item site levelling works include contouring of levelling area as per technical specification. The final area of levelling shall be decided during detailed engineering.
- b. The Quantity of earthwork cutting & filling, borrowed earth, FGL & layout of all terraces shall be proposed by vendor for approval of POWERGRID based on the contour drawing, site HFL data and Sub-station GA.
- c. Mode of measurement of this item is in Cum of earthwork as per BOQ and technical specification. The contouring of the plot area in scope as per technical specification is also deemed to be included in quoted rates of this item.

#### **ii. Soil Investigation work (2-borehole)**

- a. Soil investigation needs to be conducted as per the technical specification. The necessary soil investigation layout and soil report shall be submitted by vendor for approval of POWERGRID.
- b. Mode of measurement of this item is Lumpsum as per BOQ.

#### **iii. Structure and Foundation for transformers and reactors neutral and tertiary delta formation:** Structure and foundation for the equipment support structure and foundation for tertiary delta formation for Transformers and neutral formation & earthing arrangement for Reactors along with associated spare unit connection arrangement.

#### **iv. GIS Buildings, LCR and AHU Room (765 kV New and 400 kV Extn):**

- a) 765 kV GIS Hall Building, Relay room and AHU room shall be provided for the said scope of work. Indicative Drawing of 765 kV GIS Hall is attached with the tender drawings. The actual size of GIS Hall & Relay and AHU Room shall be finalized based on the Substation requirement during detailed engineering. The GIS layout shall be planned to suit the modular size of the GIS Hall. Accordingly, architectural drawings shall be prepared by the contractor as per actual dimensions & submitted for approval of employer.
- b) Extension of existing 400 kV GIS Hall building, Relay room & AHU room. The dimensions of this building shall be finalized during detailed engineering based on the equipment layout and requirement of technical specification. The design & drawings of the existing GIS Building shall be provided to the contractor during detailed engineering. Further the scope of work also involves extension of EOT crane girders and all necessary Electrical & Mechanical accessories to facilitate movement of existing EOT crane in the extended portion of GIS hall. Cost of the same shall be deemed to be covered in the building cost.

*Technical Specification, Section – Project {Rev.00}*

*765kV GIS New Substation Package SS 171T for a) Establishment of 765kV level at Kolhapur (PG) GIS S/s and b) Extn. of 400kV GIS at Kolhapur (PG) GIS S/s associated with "Network Expansion Scheme in Western Region to cater to pumped storage potential near Satara (up to 4500MW) - Part A" through TBCB route*

## **SECTION- PROJECT**

- c) EOT crane shall be provided in 765kV GIS Building as per relevant section of technical specification.
  - d) Complete Structural Design and Structural Drawings of the GIS Buildings shall be prepared by the contractor as per Technical Specifications and submitted for approval of employer.
  - e) Other details of the GIS Building like architecture, finishing, joinery, drainage, cable trenches etc. shall be prepared by the contractor as per Technical Specifications and submitted for approval of employer.
  - f) Any dismantling work (if any) required in the existing building/hall to support the present scope of the work. No extra payment shall be made towards it. Rates shall be deemed to be included in the plinth area rates for the new building/hall.
  - g) All civil works including foundations associated with erection of SF6 gas insulated metal enclosed switchgear along with its SF6 bus ducts upto the outer edge of the wall of GIS building. Civil works including all foundations for all equipment, grade slab foundation etc. inside GIS buildings.
  - h) The cable trenches inside GIS halls & associated LCC/Relay rooms.
  - i) Foundation for Bus duct supporting structures outside GIS Hall & GIS (SF6/Air) bushing.
- v. Pre-cast Fire wall:**
- a) The firewalls shall be precast RCC type.
  - b) The design and drawings shall be prepared and submitted by contractor for approval.
  - c) Minimum grade of concrete for precast members shall be M25 grade.
  - d) Precast members shall be reinforced with steel reinforcement which shall be as per Technical Specification.
  - e) Minimum thickness of precast members shall be 80 mm.
  - f) Minimum thickness of column and beam for fire resistance shall be governed by IS 456.
  - g) Wall portion shall have two number of precast panels (each 80 mm thick) with an air gap (minimum 200 mm) between these two panels.
  - h) Columns, beams and footings can be either cast in situ or precast.
  - i) Precast elements are not required to be finished with cement wash, only cast in situ members shall be finished with cement wash.
  - j) Standard Field Quality Plan for Pre-cast Concrete of Cable Trench/Precast Covers & Columns, Wall Panels of Boundary available on POWERGRID website shall be followed for precast firewalls as well.
  - k) Mode of measurement for precast firewall shall be in square meters (area of the fire wall shall be measured as length of firewall multiplied by height of firewall (above FGL)). The items Excavation, PCC, RCC, Reinforcement steel, Structural steel, erection, cement wash (if required) etc. wherever required and all other civil works required as per technical specification and drawings complete in all respect for successful completion of the works are deemed to be included in quoted rates. The work for foundations (shallow depth or deep foundations) shall be deemed to be included in these quoted rates itself. However, any ground improvement required for firewall (like stone packing etc.) shall be measured and paid separately.
- vi. Slope Protection Works & Retaining Walls:** Design & Drawings pertaining to slope protection works & retaining walls (if required during detailed engineering) and same shall be measured & paid under respective line items of BPS.
- vii.** Foundation for lighting poles, bay marshalling boxes, panels and control cubicles wherever required. The cost of these foundations shall be deemed to be included in erection/installation

*Technical Specification, Section – Project {Rev.00}*

*765kV GIS New Substation Package SS 171T for a) Establishment of 765kV level at Kolhapur (PG) GIS S/s and b) Extn. of 400kV GIS at Kolhapur (PG) GIS S/s associated with "Network Expansion Scheme in Western Region to cater to pumped storage potential near Satara (up to 4500MW) - Part A" through TBCB route*

## **SECTION- PROJECT**

of corresponding item/ equipment of BPS.

- viii. Anti-weed treatment, providing & laying non-woven geo-synthetic fabric and stone spreading in the new switchyard as per TS. The layout for the same shall be developed by the contractor.
- ix. Removing, cleaning, washing and respreading of existing stone, Anti-weed treatment, providing & laying of PCC (1:5:10) as per Annexure-VII and stone spreading in the existing switchyard wherever required as per TS. The layout for the same shall be developed by the contractor.

### **C. Lattice & Pipe Structures (Galvanized):**

- i. The scope shall include fabrication, proto-assembly, supply including transportation & insurance, unloading, storage, erection and commissioning of towers, beams and equipment support structures including nuts, bolts, fasteners and foundation bolts complete in all respect.
- ii. The fabrication drawings of towers and beams shall be provided by Employer during detailed engineering. Equipment support structures except support structures for Circuit Breaker shall be provided as per Employer's drawings during detailed engineering.
- iii. In case POWERGRID provides the Single Line Diagram (SLD) of the structures, contractor shall prepare the fabrication drawing based on the SLD and submit for approval. For equipment support structure, ht. of structure, mounting of equipment and fixing of MOM box etc. shall be taken care by the contractor as per the requirement of the equipment.
- iv. POWERGRID may also ask the Contractor to prepare the design and drawings of structures. In such case, Contractor shall prepare design and drawings and put up for Employer's approval. The design shall be payable as per relevant item of BPS.
- v. In the bid price schedule, the structures, nuts, bolts and fasteners & foundation bolts are indicated in Metric Ton (MT) and shall be paid as per respective items of BPS.
- vi. The civil work shall be payable as per relevant item of BPS.
- vii. All Proto-corrected drawings and Bill of Materials of all structures shall be in the scope of Contractor.
- viii. The proto corrected drawings along with BOMs are to be witnessed and certified by the contractor. Certified proto corrected drawings along with BOM shall be submitted to POWERGRID for information only. Contractor shall provide editable soft copies of design & drawings (including Proto corrected in AUTOCAD) & BOMs during detailed engineering.

- D. For buildings, the complete civil works including internal and external finishing, stone soling for flooring, plinth protection, drain along plinth protection, electrical conduit and junction boxes, fan boxes, Miscellaneous structural steel, cable transit system etc. required to complete the building in all respect as per the drawing shall be payable in the plinth area rate. However, the quantity of the earthwork (excavation, backfilling, disposal etc.), concrete (all types), reinforcement steel, shall be measured and paid under respective items under BPS.

### **3. SPECIFIC EXCLUSIONS**

The following items of work are specifically excluded from the scope of the specifications:

- a) Employer's site office and stores.
- b) Transit camp.
- c) Store building.
- d) Approach road outside Substation boundary wall.

*Technical Specification, Section – Project {Rev.00}*

---

*765kV GIS New Substation Package SS 171T for a) Establishment of 765kV level at Kolhapur (PG) GIS S/s and b) Extn. of 400kV GIS at Kolhapur (PG) GIS S/s associated with "Network Expansion Scheme in Western Region to cater to pumped storage potential near Satara (up to 4500MW) - Part A" through TBCB route*

## **SECTION- PROJECT**

- e) Control room Building.
- f) Boundary Wall & Security Hut.
- g) Supply, erection, testing & commissioning of 765kV class Transformers and Reactors.

### 4. PHYSICAL AND OTHER PARAMETERS

#### 4.1 Location of the Substation - The location of substation is indicated below:

Name of Substation	Name of State	Nearest Rail Head
Kolhapur (GIS) Substation	Maharashtra	Kolhapur

#### 4.2 Meteorological data

The meteorological data are as below

<b>Station Name</b>	Kolhapur (GIS) Substation
Altitude	Less than 1000 meter above mean sea level (MSL)
Snow fall	NIL
Seismic Zone	As per IS 1893 (Part 1)
Wind Zone	NBC 2016
Min./Max. Ambient Temperature	0 / 50 degree centigrade
Coastal Area consideration	<b>No</b>

#### 4.3 Fault level shall be considered as mentioned below:-

Sl. No.	Name of Substation	765kV	400kV
1.	Kolhapur (GIS) Substation	50kA for 1 Sec	63kA for 1 Sec

### 5. SCHEDULE OF QUANTITIES

The requirement of various items/equipments and civil works are indicated in Bid price Schedules.

All equipment/items, Structures and civil works for which quantities has been given in the BPS shall be payable on unit rate basis. During actual execution, any variation in such quantities shall be paid based on the unit rate under each item incorporated in Letter of award.

Wherever the quantities of items/works are indicated in Set/LOT/LS, the bidder is required to estimate the quantity required for entire execution and completion of works and incorporate their price in respective Bid price schedules. For erection hardware items, Bidders shall estimate the total requirement of the works and indicate module-wise lump sum price bay wise and include the same in relevant Bid price schedules. Any material/works for the modules not specifically mentioned in the description in BPS, as may be required shall be deemed to be included in the module itself.

No cost compensation shall be considered on account of "Set/LOT/LS" items in any case if number of bays specified in section project remains unchanged.

Bidder should include all such items in the bid proposal sheets, which are not specifically mentioned but are essential for the execution of the contract. Item which explicitly may not appear in various schedules and required for successful commissioning of substation shall be included in the bid price and shall be provided at no extra cost to Employer.

*Technical Specification, Section – Project {Rev.00}*

*765kV GIS New Substation Package SS 171T for a) Establishment of 765kV level at Kolhapur (PG) GIS S/s and b) Extn. of 400kV GIS at Kolhapur (PG) GIS S/s associated with "Network Expansion Scheme in Western Region to cater to pumped storage potential near Satara (up to 4500MW) - Part A" through TBCB route*

## SECTION- PROJECT

### 6. BASIC REFERENCE DRAWINGS

- a) Design of substation and its associated electrical & mechanical auxiliaries systems includes preparation of single line diagram, electrical layout, foundation & cable trench layouts (including invert levels), erection key diagrams, direct stroke lightning protection, electrical and physical clearance diagrams, Control and protection schematics, wiring and termination schedules, design of firefighting system, outdoor lighting/illumination and other relevant drawings & documents required for engineering of all facilities within the fencing to be provided under this contract, are covered under the scope of the Contractor.
- b) The substation shall be designed considering current ratings as indicated below-

Sl. No	Description of bay	Kolhapur (GIS) Substation	
		765kV	400kV
1.	Bus Bar	4000A	4000A
2.	Line bay	3150A	3150A
3.	ICT bay	3150A	3150A
4.	Tie bay	3150A	3150A
5.	Bus Reactor Bay	3150A	--
6.	Switchable Line Reactor Bay	3150A	--
7.	Auxiliary Busbar for Transformer	3150A	3150A
8.	Auxiliary Busbar for Reactor	3150A	--

- c) Following switching schemes are envisaged under present scope:

Name of substation	Bus switching scheme	
	765kV	400kV
Kolhapur GIS	One & half breaker scheme	One & half breaker scheme

- d) The reference drawings, which form a part of the specifications, are given at **Annexure-I**. The bidder shall maintain the phase to earth clearance, phase to phase clearance and sectional clearances, clearances between buses, bus heights but may alter the locations of equipment to obtain the statutory electrical clearances required for the substation.
- e) It is responsibility of contractor to develop general arrangement drawing, layout drawings, single line drawing, foundation & cable trench layout, erection key diagram & all other layout drawings for present scope of work.
- f) **INPUTS TO BE PROVIDED DURING DETAILED ENGINEERING**
- i) Location of identified land and Plot plan for land shall be provided to successful bidder during detailed engineering.
  - ii) Transmission line side conductor type & configuration of conductors for transmission lines of various voltage levels.

### 7. DIFFERENT SECTIONS OF TECHNICAL SPECIFICATION

For the purpose of present scope of work, technical specification (Vol. II) shall consist of following sections and they should be read in conjunction with each other.

*Technical Specification, Section – Project {Rev.00}*

*765kV GIS New Substation Package SS 171T for a) Establishment of 765kV level at Kolhapur (PG) GIS S/s and b) Extn. of 400kV GIS at Kolhapur (PG) GIS S/s associated with "Network Expansion Scheme in Western Region to cater to pumped storage potential near Satara (up to 4500MW) - Part A" through TBCB route*

**SECTION- PROJECT**

<b>Sl. No.</b>	<b>Description</b>	<b>Revision</b>
1.	Section - Project	Rev 00
2.	Section - General Technical Requirement	Rev 15
3.	Section - Gas Insulated Switchgear (GIS)	Rev 05A
4.	Section - Switchgear Instrument Transformer	Rev 12
5.	Section - Switchgear SA	Rev 13
6.	Section - Switchgear- CB	Rev 12
7.	Section - Lighting System	Rev 07
8.	Section- LT Switchgear	Rev. 05
9.	Section - Battery & Battery Charger	Rev. 07
10.	Section - Fire Protection System	Rev 06
11.	Section - Power & Control Cable	Rev 06
12.	Section - Air Conditioning System	Rev 04
13.	Section - Switchyard Erection	Rev 10
14.	Section – Structure	Rev 07
15.	Section - Civil Works with corr. Slip 1	Rev 12
16.	Section - Control & Relay Panel	Rev 09
17.	Section - Substation Automation System	Rev 04
18.	Section – PLCC	Rev. 05
19.	Section – Telecommunication System	Rev. 05
20.	Section – PMU	Rev. 01

In case of any discrepancy between Section-PROJECT, Section-GTR and other technical specifications on scope of works, Section-PROJECT shall prevail over all other sections.

In case of any discrepancy between Section-GTR and individual sections for various equipments, requirement of individual equipment section shall prevail.

In case of any discrepancy between Main body of Section-Project and Annexure(s) of Section-Project, provisions specified in Main body of Section-Project shall prevail.

In case of any discrepancy between BPS and other sections, BPS shall prevail over the other sections of the technical specifications. However, for rating of the BPS items, associated Section-Project shall be referred to.

**8. MANDATORY SPARES**

The Mandatory Spares shall be included in the bid proposal by the bidder. The prices of these spares shall be given by the Bidder in the relevant schedule of BPS and shall be considered for evaluation of bid. It shall not be binding on the Employer to procure all of these mandatory spares.

The bidder is clarified that no mandatory spares shall generally be used during the commissioning of the equipment. Any spares required for commissioning purpose shall be arranged by the Contractor. The unutilized spares if any brought for commissioning purpose shall be taken back by the contractor.

Wherever spares in BPS/Technical Specification have been specified as “each type/each rating/each type & rating”: If the offered spare/spares is sufficient to replace the respective main equipment of all types/ratings, then such offered spare/spares shall be acceptable. It implies that common spare/spare set fulfilling the spare requirement of all types/ratings shall also be acceptable, provided it is configurable at site itself without special assistance of OEM.

**Technical Specification, Section – Project {Rev.00}**

*765kV GIS New Substation Package SS 171T for a) Establishment of 765kV level at Kolhapur (PG) GIS S/s and b) Extn. of 400kV GIS at Kolhapur (PG) GIS S/s associated with "Network Expansion Scheme in Western Region to cater to pumped storage potential near Satara (up to 4500MW) - Part A" through TBCB route*

**SECTION- PROJECT**

Mandatory Spares, wherever mentioned, are envisaged for the equipment/items being supplied under the main equipment heads under present scope meeting the requirements of Technical Specifications. The component/sub-component of an equipment/item specified in BPS under Mandatory Spare, which is not applicable as per the offered design of respective main equipment, shall not be referred to.

**9. SPECIFIC REQUIREMENT**

9.1 Relevant/applicable clauses of Specific Requirements as mentioned at C/ENGG/SPEC/SEC-PROJECT/SPECIFIC REQUIREMENT Rev. no. 10 (attached as Annexure-III) shall also be referred for specified scope of work. Any discrepancy between clause 9.0 Section-PROJECT and Specific Requirements as mentioned at C/ENGG/SPEC/SEC-PROJECT/SPECIFIC REQUIREMENT Rev. no. 10 (attached at Annexure-III) on scope of works, the requirement stipulated at clause 9.0 of section project shall prevail.

9.2 **800kV & 420kV GIS Modules/Equipment description** given in **Annexure-IV** shall be referred. 800kV & 420kV GIS Modules/Equipment description provided at Annexure-S11 of Specific Requirements as mentioned at C/ENGG/SPEC/SEC-PROJECT/SPECIFIC REQUIREMENT Rev. no. 10 (attached as Annexure-III) stands deleted.

9.3 “Minimum specified creepage distance for insulator string/ longrod insulators/ outdoor bushings shall be 31 mm/kV”.

9.4 Each circuit of a double circuit transmission line shall be terminated in different diameters.

9.5 Transformers of same HV rating shall be placed in different diameters.

9.6 Bus reactors of same HV rating shall be placed in different diameters

9.7 Requirement Specified at clause no 29 of Section CRP Rev 9 for STANDALONE DISTURBANCE RECORDER (for 765 KV Feeders only) stands deleted.

9.8 **Annexure-S 1 attached at Specific requirement rev 10** is stand revised.

S.No.	Clause No.	Amended As
5.	Clause no 1.1.4	Refer Annexure-S1 (Revised) for METHODOLOGY FOR SIZING OF CABLES attached as Annexure-VI

9.9 Clause no C. Section Switchgear -CB Rev 11 of specific requirement stand deleted.

9.10 For 01 no. of 400kV Line Bay for interconnection with future Line (covered under present scope for diameter-1 completion), which shall be utilized in future, following scope is envisaged under present scope of work:

- a) 400kV GIS bus ducts shall be brought outside of the extended GIS building and provided with End Piece (Interface) module suitably with isolating test link for future connections with 400kV Line. Associated End Piece (Interface) module(s) shall be deemed to be part of outdoor bus duct. Outdoor bus duct including End Piece (Interface) Module for 400kV Line Bay, shall be measured from outer edge of the wall of extended GIS Building and shall be paid separately in running meter against BPS item of Bus duct (3150A).

9.11 For 01 no. of 400kV Line Bay with provision for interconnection with future Switchable Line Reactor Bay (covered under present scope for diameter-2 completion), which shall be utilized in future, following scope is envisaged under present scope of work:

- a) 400kV GIS bus ducts shall be brought outside of the extended GIS building and provided with End Piece (Interface) module suitably with isolating test link for future connections with 400kV Line. Associated End Piece (Interface) module(s) shall be deemed to be part of outdoor bus duct. Outdoor bus duct including End Piece (Interface) Module for 400kV Line

Technical Specification, Section – Project {Rev.00}

*765kV GIS New Substation Package SS 171T for a) Establishment of 765kV level at Kolhapur (PG) GIS S/s and b) Extn. of 400kV GIS at Kolhapur (PG) GIS S/s associated with "Network Expansion Scheme in Western Region to cater to pumped storage potential near Satara (up to 4500MW) - Part A" through TBCB route*

## **SECTION- PROJECT**

Bay, shall be measured from outer edge of the wall of extended GIS Building and shall be paid separately in running meter against BPS item of Bus duct (3150A).

- b) The 400kV GIS BAY MODULE for Line Bay, where line feeder is to be connected in future, shall have provision to connect the switchable line reactor bay. This GIS BAY MODULE shall be provided with End Piece (Interface) modules with isolating test link for future extension. This GIS BAY MODULE for Line Bay, along with end piece modules, shall be designed in such a way that the upcoming GIS modules shall be able to connect without any hindrance and without any dismantling of the existing GIS modules, associated accessories and structure, whether this GIS BAY MODULE for Line Bay is placed in the middle diameter or at the end in GIS hall. The above-provided end piece module shall be designed in such a way that the future GIS module may be tested without extending voltage to the existing bus by removing the test link. End piece (Interface) module shall be provided in one alignment.

### 9.12 **Clause 13.3 of GTR, Rev-15 is modified as follows:**

**For new as well as substation extn packages**, the contractor must ensure that the open storage platform (as per Drawing No. C-ENGG-CVL-STD-PLATFORM-01, Rev.0) is constructed for storage of outdoor type equipment/material prior to commencement of delivery at site. Outdoor equipment shall be stored on open storage platform, properly covered with waterproof and dustproof covers to protect them from water seepage and moisture ingress.

**In case of extn packages wherein vacant outdoor facility is existing at Substation premises, same shall be made available to contractor for storage of equipment without any financial implications. Same shall be allowed with approval of Engineer In-charge subject to availability at the time of execution on as and where basis. Notwithstanding the same, sole responsibility of security & upkeep of storage facilities lies with Contractor.**

However, all indoor equipments including control & protection panels, Communication equipments and operating mechanism boxes etc. of outdoor equipments shall be stored indoors. Storage of equipment on top of another one is not permitted if the wooden packing is used and there is possibility of equipment/ packing damage. Material opened for joint inspection shall be repacked properly as per manufacturer's recommendations. During storage of material regular periodic monitoring of important parameters like oil level / leakage, SF6 / Nitrogen pressure etc. shall be ensured by the contractor.

### 9.13 **Clause 13.9 of GTR, Rev-15 is amended as follows:**

**For new as well as substation extn packages**, the Contractor shall be responsible for making suitable indoor storage facilities, to store all equipment which requires indoor storage.

**In case of extn packages wherein vacant indoor facility is existing at Substation premises, same shall be made available to contractor for storage of indoor equipment without any financial implications. Same shall be allowed with approval of Engineer In-charge subject to availability at the time of execution on as and where basis. Notwithstanding the same, sole responsibility of security & upkeep of storage facilities lies with Contractor.**

### 9.14 **New Clause added for GTR, Rev-15 is as follows:**

**13.15** Contractor is responsible for assessment of existing storage facility/space for adequacy and suitability for intended storage of equipment. In case of non-availability of suitable existing storage facility/space in existing substation premises, the contractor shall make his own necessary arrangements at his own cost so that progress of work is not affected and Employer shall in no case be responsible for any delay in works because of non-availability of storage facility.

### 9.15 **Sl.No. A.5 of Annex-III of Section-Project [Specific Requirement Rev.10] is amended as follows:**

The reports for all type tests as per technical specification shall be furnished by the Contractor along with equipment / material drawings. However, type test reports of similar equipments/

*Technical Specification, Section – Project {Rev.00}*

*765kV GIS New Substation Package SS 171T for a) Establishment of 765kV level at Kolhapur (PG) GIS S/s and b) Extn. of 400kV GIS at Kolhapur (PG) GIS S/s associated with "Network Expansion Scheme in Western Region to cater to pumped storage potential near Satara (up to 4500MW) - Part A" through TBCB route*

## **SECTION- PROJECT**

material already accepted in POWERGRID shall be applicable for all projects with similar requirement. The type tests conducted earlier should have either been conducted in accredited laboratory (accredited based on ISO / IEC Guide 25 / 17025 or EN 45001 by the national accreditation body of the country where laboratory is located) or witnessed by POWERGRID/representative authorized by POWERGRID/representative of Utility /representative of accredited test lab/ representative of The National Accreditation Board for Certification Bodies (NABCB) certified agency shall also be acceptable.

Unless otherwise specified elsewhere, the type test reports submitted shall be of the tests conducted within the years specified below from **the originally scheduled last date of bid submission (Soft Copy)**. In case the test reports are of the test conducted earlier than the years specified below from the **originally scheduled last date of bid submission (Soft Copy)**, the contractor shall repeat these test(s) at no extra cost to the Employer: -

S. No.	Name of Equipment	Validity of type test (in years)
1	Power Transformer	10
2	LT Transformer	10
3	Shunt Reactor/ <b>Series Reactor /Neutral Grounding Reactor</b>	10
4	OLTC	10
5	Bushing of Power Transformers/Reactors	10
6	Fittings and accessories for Power transformers & Reactors	10
7	Circuit Breaker	15
8	Isolator	15
9	Lighting Arrester	15
10	Wave Trap	15
11	Instrument transformer	15
12	GIS & Hybrid GIS	15
13	LT Switchgear	10
14	Cable and associated accessories	10
15	Relays/ <b>BCU/Process Interface units /Standalone Merging unit</b>	10
16	Capacitors	10
17	Battery and Battery charger	10
18	Conductor & Earth wire	10
19	Insulators (Porcelain/Glass)	10
20	Composite Insulators	10
21	PLCC	10

**Note:-**

- For all other equipment's validity of type test shall be 10 years from **the originally scheduled last date of bid submission (Soft Copy)**.
- Equipment shall be supplied from the same manufacturing work, where from the sample unit was manufactured and successfully type tested as per relevant standard.

Further, where offered equipment is based on the design of technology transfer of Parent organization / Joint Venture (JV), type test reports of Parent organization / Joint Venture (JV) shall also be acceptable for the initial period of 03 years from the date of establishment manufacturing facility for offered equipment provided that the design, material, and manufacturing process of the offered equipment are identical to those of the type-tested sample of the original facility. In such cases, while submitting the Type Test Reports, the Original Equipment Manufacturer (OEM), shall furnish an undertaking with it declaring that there is

- No change in the Design
- No change in the material,
- No change in manufacturing process, and

Technical Specification, Section – Project {Rev.00}

765kV GIS New Substation Package SS 171T for a) Establishment of 765kV level at Kolhapur (PG) GIS S/s and b) Extn. of 400kV GIS at Kolhapur (PG) GIS S/s associated with "Network Expansion Scheme in Western Region to cater to pumped storage potential near Satara (up to 4500MW) - Part A" through TBCB route

## **SECTION- PROJECT**

- D. No amendment/revision in the relevant standard as regard to type test conditions, since the type test*
3. *In case of own manufacturing plant at different location within India, the type test of the original manufacturing works shall also be acceptable for the equipment manufactured and supplied from the different location subject to the following conditions:*
- i. The relevant standard does not bar the same,*
  - ii. The equipment being manufactured at different locations shall be identical in design, drawings, specifications, ratings to that of the type tested sample in the original facility (where it was manufactured and successfully type tested),*
  - iii. The equipment being manufactured at different locations shall be identical in material & critical components, manufacturing process/ practices, and quality control to that of the type tested sample in the original facility (where it was manufactured and successfully type tested),*
  - iv. Also, while submitting the Type Test Reports, the Original Equipment Manufacturer (OEM), shall furnish an undertaking for above conditions (i), (ii) and (iii).*

Further, in the event of any discrepancy in the test reports i.e. any test report not acceptable due to any design/manufacturing changes or due to non-compliance with the requirement stipulated in the Technical Specification or any/all type tests not carried out, same shall be carried out without any additional cost implication to the Employer.

The Contractor shall intimate the Employer the detailed program about the type tests at least two (2) weeks in advance in case of domestic supplies & six (6) weeks in advance in case of foreign supplies.

- 9.16 For Circuit breaker(s) controlling 400kV Transmission line(s), with or without Line Reactor and 765kV Transmission line(s) without Line Reactor, Controlled Switching Device (CSD) suitable for Line Switching Application in lieu of PIR shall also be acceptable.

The above CSD provided for the transmission line application shall be used for controlled energization to minimize the switching overvoltage in the line during dead-line charging as well as during re-energization as part of auto-reclosure sequence. It is required that the performance of the circuit breaker with CSD for transmission line switching shall be equivalent to or better than that of a circuit breaker equipped with a Pre-Insertion Resistor (PIR).

- 9.17 In Section-GTR and other technical specifications, the term 'Employer and/or 'Purchaser/Customer/Owner' may be read as Employer.

\*\*\*

*Technical Specification, Section – Project {Rev.00}*

*765kV GIS New Substation Package SS 171T for a) Establishment of 765kV level at Kolhapur (PG) GIS S/s and b) Extn. of 400kV GIS at Kolhapur (PG) GIS S/s associated with "Network Expansion Scheme in Western Region to cater to pumped storage potential near Satara (up to 4500MW) - Part A" through TBCB route*

**SECTION-104 OF TECHNICAL SPECIFICATION**  
**Doc No. TB-PBTU-GIS-PGCIL-SS171T**  
**765kV and 400kV Gas Insulated Switchgear & its accessories**

C/ENGG/SPEC/SEC-PROJECT/SPECIFIC REQUIREMENT REV NO 10

Employer has standardized its Specific Requirement for various equipment and works for different voltage levels. Items or clauses, which are not applicable for the scope of this package as per schedule of quantities described in BPS or as per scope defined elsewhere in Section Project, the technical specification/clauses for the items specified below should not be referred to.

S.No.	Clause No.	Amended As (As per Specific Requirement Rev 10)
<b>A. Section: GTR Rev 15</b>		
1.	Clause 2.1 (a)	"All equipment/materials/items, as per <b>Annexure-K (Rev 01)</b> , as applicable under present scope of works, shall be procured and supplied from domestic manufacturers only with Minimum Local Content for individual items as listed in the above annexure. Any imported equipment/material/item/parts/component (comprising of embedded systems) to be supplied under the contract shall be tested in the certified laboratories to check for any kind of embedded malware/trojans/cyber threats and for adherence to Indian Standards as per the directions issued by Ministry of Power/Govt. of India from time to time. In case of such import from specified "prior reference" countries, the requirement of prior permission from the Govt. of India including protocol for testing in certified and designated laboratories by Ministry of Power/Govt. of India shall also be complied with by the contractor. The bidder/contractor shall list out the products and components producing Toxic e-waste under the contract and shall furnish to the Employer the procedure of safe disposal at the time of closing of the contract."
2.	New Clause no 2.1 C	Equipment/Material/Items from a Indian manufacture who have specified transfer of technology (TOT) arrangement with an entity from a country which shares land border with India shall be accepted only if the Indian Manufacturer is complying the requirement of prevailing Guideline by Government of India under Rule 144(xi) of the General financial Rule (GFR) 2017
3.	New Clause No. 4.7	<b>Planning and Designing in purview of Vulnerability Atlas of India</b>  Vulnerability Atlas of India (VAI) is a comprehensive document which provides existing hazard scenario for the entire country and presents the digitized State/UT wise hazard, maps with respect to earthquakes, winds and floods for district wise identification of vulnerable areas. It also includes additional digitized maps for thunderstorms, cyclones and landslides. The main purpose of this Atlas is its use for disaster preparedness and mitigation at policy planning and project formulation stage.  This Atlas is one of its kind single point source for the various stakeholders including policy makers, administrators, municipal commissioners, urban managers, engineers, architects, planners, public etc. to ascertain proneness of any city/ location/ site to multi-hazard which includes earthquakes, winds, floods thunderstorms, cyclones and landslides. While project formulation, approvals and implementation of various urban housing, buildings and infrastructures schemes, this Atlas provides necessary information for risk analysis and hazard assessment.  The Vulnerability Atlas of India has been prepared by Building Materials and Technology Promotion Council under Ministry of Housing and Urban Affairs, Government of India and available at their website <a href="https://www.bmtpc.org/">https://www.bmtpc.org/</a> . It is mandatory for the bidders to refer Vulnerability Atlas of India for multi-hazard risk assessment and include the relevant hazard proneness specific to project location while planning and designing the project in terms of:  <ul style="list-style-type: none"> <li>i) Seismic zone for earthquakes,</li> <li>ii) Wind velocity</li> <li>iii) Area liable to floods and Probable max. surge height</li> <li>iv) Thunderstorms history</li> <li>v) Number of cyclonic storms/ severe cyclonic storms and max sustained wind specific to coastal Region</li> <li>vi) Landslides incidences with Annual rainfall normal</li> <li>vii) District wise Probable Max. Precipitation</li> </ul>
4.	New Clause No. 8.3	<b>8.3 INSPECTION, TESTING &amp; INSPECTION CERTIFICATE</b>  8.3.1 Contractor shall procure bought out items from sub-vendors as per the list in "Compendium of Vendors" available on POWERGRID web-site <a href="http://www.powergrid.in">www.powergrid.in</a> after ensuring compliance to the requirements/conditions mentioned therein. Contractor shall explore first the possibilities of procuring the bought out items from POWERGRID approved existing vendors. In case of their unavailability / non-response, Contractor may approach POWERGRID for additional sub-vendor approval. In that case, the assessment report of

S.No.	Clause No.	Amended As (As per Specific Requirement Rev 10)
		<p>proposed sub vendor by Contractor along with the enclosures as per <b>Annexure-F Rev 01</b> shall be submitted within 60 days of the award. The proposal shall be reviewed and approval will be accorded based on the verification of the document submitted and/or after the physical assessment of the works as the case may be. The physical assessment conducted by POWERGRID, if required, shall be on chargeable basis. Charges shall be as per the POWERGRID norms prevailing at that time, which shall be intimated by POWERGRID separately. If proposal for sub-vendor is submitted after 60 days, the Contractor's proposal normally will not be considered for current LOA. However, POWERGRID may process the case for developing more vendors for referred items, if found relevant. In all cases, It is the responsibility of the Contractor that Project activities do not suffer on account of delay in approval/non approval of a new sub-vendor.</p> <p>For Telecom/GA&amp;C packages, the makes/model of small items shall be finalized during approval of DRS by Telecom/GA&amp;C department.</p> <p>The responsibility and the basis of inspection for various items &amp; equipment is placed at <b>Annexure-G Rev 01</b> along with the requirement of MQP (Manufacturing Quality Plan), ITP(Inspection &amp; Test Plan), FAT(Factory Acceptance Test) which should be valid &amp; POWERGRID approved and Level of inspection envisaged against each item.</p> <p>Contractor shall ensure that order for items where MQP/ITP/FAT is required will be placed only on vendors having valid MQP/ITP/FAT and where the supplier's MQP/ITP/FAT is either not valid or has not been approved by POWERGRID, MQP shall be generally submitted as per POWERGRID format before placing order. A Copy of MQP format is placed at <b>Revised Annexure – M.</b></p> <p>Items not covered under MQP/ITP/FAT shall be offered for inspection as per POWERGRID LOA/technical Specifications/ POWERGRID approved data sheets/ POWERGRID approved drawings and relevant Indian / International standards.</p> <p><b>Inspection Levels:</b> For implementation of projects in a time bound manner and to avoid any delay in deputation of POWERGRID or its authorized representative, involvement of POWERGRID for inspection of various items / equipment will be based on the level below:</p> <p><b>Level –I:</b> Contractor to raise all inspection calls and review the report of tests carried out by the manufacturer, on his own, as per applicable standards/ POWERGRID specification, and submit to concerned POWERGRID inspection office/Inspection Engineer. CIP/MICC will be issued by POWERGRID based on review of test reports/certificates of manufacturers.</p> <p><b>Level – II:</b> Contractor to raise all inspection calls and carry out the inspection on behalf of POWERGRID on the proposed date of inspection as per applicable standards/specification. However, in case POWERGRID wishes to associate itself during inspection, the same would be intimated to Contractor and CIP/MICC will be issued by POWERGRID. Else, Contractor would submit their test reports/certificates to POWERGRID. CIP/MICC will be issued by POWERGRID based on review of test reports / certificates.</p> <p><b>Level - III:</b> Contractor to raise inspection calls for both, stage (as applicable) &amp; final inspection and carry out the stage inspections (if applicable) on behalf of POWERGRID on the proposed date of inspection as per applicable standards/specification. However, in case POWERGRID wishes to associate itself during stage inspection, the same would be intimated to Contractor and CIP will be issued by POWERGRID. Else, Contractor would submit the test reports / certificates of stage inspection after their own review and CIP will be issued by POWERGRID based on review of test reports / certificates. Final inspection will be carried out by POWERGRID and CIP/MICC will be issued by POWERGRID.</p> <p><b>Level – IV:</b> Contractor to raise inspection calls for both, stage (as applicable) &amp; final inspections. POWERGRID will carry out the inspection for both stage &amp; final inspection as per applicable standards/specification and CIP/MICC will be issued by POWERGRID.</p> <p>8.3.2 Contractor shall ensure that to implement the above inspection levels, particularly for the quality control and inspection at sub-vendor's works, they would depute sufficient qualified &amp; experienced manpower in their Quality Control and Inspection department. Further, to assure quality of construction, Contractor shall have a separate workforce having appropriate qualification &amp; experience and deploy suitable tools and plant for maintaining quality requirement during construction in line with applicable Field Quality Plan (FQP).</p> <p>8.3.3 The Employer, his duly authorized representative and/or outside inspection agency acting on behalf of the Employer shall have at all reasonable times access to the Contractor's premises or Works and shall have the power at all reasonable times to ensure that proper Quality Management practices / norms are adhered to, inspect and examine the materials &amp; workmanship of to carry out Quality/Surveillance Audit during manufacture or erection and if part of the Works is being manufactured or assembled at other premises or works. The Contractor shall obtain for the Employer and for his duly authorized representative permission</p>

S.No.	Clause No.	Amended As (As per Specific Requirement Rev 10)
		to inspect as if the works were manufactured or assembled on the Contractor's own premises or works. The item/equipment, if found unsatisfactory with respect to workmanship or material is liable to be rejected. The observations for improvements during product/ process inspection by POWERGRID shall be recorded in Quality Improvement Register (available & maintained at works) for review & timely compliance of observations.
	8.3.4	Contractor shall submit inspection calls over internet through POWERGRID website. The required vendor code and password to enable raising inspection call will be furnished to the main Contractor within 30 days of award of contract on submission of documents by Contractor. After raising the inspection calls, Contractor shall then proceed as per the message of that particular call which is available on the message board.
	8.3.5	The Employer reserves the right to witness any or all type, acceptance and routine tests specified for which the Contractor shall give the Employer/Inspector Twenty one (21) days written notice of any material being ready for testing for each stage of testing as identified in the approved quality plan as customer inspection point(CIP) for indigenous inspections. All inspection calls for overseas material shall be given at least forty five (45) days in advance. Such tests shall be to the Contractor's account except for the expenses of the Inspection Engineer. The Employer/inspector, unless witnessing of the tests is waived by Employer, will attend such tests within Twenty one (21) days of the date of which the equipment is notified as being ready for test/inspection, failing which the Contractor may proceed with the test which shall be deemed to have been made in the Inspector's presence and he shall forthwith forward to the Inspector three copies of tests, duly certified. Contractor shall ensure, before giving notice for type test, that all drawings and quality plans have been got approved. The equipment shall be dispatched to site only after approval of Routine and Acceptance test results and Issuance of Dispatch Clearance in writing by the Employer. CIP/Material Inspection clearance certificate (MICC) shall be issued by the Employer after inspection of the equipment or review of test reports as applicable. Employer may waive off the presence of Employer's inspecting engineer. In that case test will be carried out as per approved QP and test certificate will be furnished by the supplier for approval. CIP/MICC will be issued only after review and approval of the test reports.
	8.3.6	Contractor shall generally offer material for inspection as per supply bar chart approved by POWERGRID and not before 30 days from schedule indicated in the bar chart. In case Contractor offers material(s) for inspection prior to 30 days from the scheduled date with necessary approval of POWERGRID However, in such an exceptional case, MICC shall be issued only as per provision of original / revised approved supply schedule.
	8.3.7	Contractor shall minimize the number of inspection calls by offering optimum quantities in each inspection call at the respective manufacturer's works.
	8.3.8	Contractor shall inspect the material themselves and only after they are fully convinced about the Quality, they shall offer the material for POWERGRID inspection and shall also ensure that relevant portion of LOA/NOA, approved drawing and data sheets along with applicable Quality Plans are available at the works of Contractor or their Sub-vendor before the material is offered for inspection.
	8.3.9	Contractor shall ensure that material which has been cleared for dispatch after inspection will be dispatched within 30 days in case of domestic supplies and within 60 days in case of Off-shore supplies from the date of issuance of CIP. Material which is not dispatched within stipulated time as above will be reoffered for POWERGRID inspection or specific approval of POWERGRID QA&I shall be obtained for delayed dispatch .
	8.3.10	The Employer or IE shall give notice in writing to the Contractor, of any objection either to conformance to any drawings or to any equipment and workmanship which in his opinion is not in accordance with the Contract. The Contractor shall give due consideration to such objections and shall either make the modifications that may be necessary to meet the said objections or shall confirm in writing to the Employer/Inspection Engineer giving reasons therein, that no modifications are necessary to comply with the Contract.
	8.3.11	All Test Reports and documents to be submitted in English during final inspection of equipment by POWERGRID or as and when required for submission.
	8.3.12	When the factory tests have been completed at the Contractor's or Sub-Contractor's works, the Employer/Inspection Engineer(IE) shall issue a certificate to this effect within fifteen (15) days after completion of tests & submission of documents by Contractor/manufacturer but if the tests are not witnessed by the Employer/IE, the certificate shall be issued within fifteen (15) days of receipt of the Contractor's Test certificate by the Employer/IE. Contractor shall, on completion of all tests, submit test reports within Ten (10) days to POWERGRID IE. Failure of the Employer/IE to issue such a certificate shall not prevent the Contractor from

S.No.	Clause No.	Amended As (As per Specific Requirement Rev 10)
		proceeding with the Works. The completion of these tests or the issue of the certificate shall not bind the Employer to accept the equipment should, it, on further tests after erection, be found not to comply with the Contract.
	8.3.13	In all cases, where the Contract provides for tests whether at the premises or works of the Contractor or of any Sub- Contractor, the Contractor, except where otherwise specified, shall provide free of charge such items as labour, materials, electricity, fuel, water, stores, apparatus and instruments as may be reasonably demanded by the Employer/Inspector or his authorized representative to carry out effectively such tests of the equipment in accordance with the Contract and shall give facilities to the Employer/Inspection Engineer or to his authorized representative to accomplish testing.
	8.3.14	The inspection and acceptance by Employer and issue of Inspection Certificate thereon shall in no way limit the liabilities and responsibilities of the Contractor in respect of the agreed quality assurance programme forming a part of the Contract, or if such equipment is found to be defective at a later stage.
	8.3.15	The Employer will have the right of having at his own expenses any other test(s) of reasonable nature carried out at Contractor's premises or at site or in any other place in addition of aforesaid type and routine tests, to satisfy that the material comply with the specification.
	8.3.16	The Employer reserves the right for getting any additional field tests conducted on the completely assembled equipment at site to satisfy that material complies with specifications.
	8.3.17	Rework/ Re-engineering, if any, on any item/equipment shall be carried out only after mutual discussions and in accordance with mutually agreed procedure. Contractor shall submit Joint Inspection Report of equipment under Re-Work/Re-Engineering along with procedure for the same to POWERGRID for approval, before taking up the Re-Work/Re-Engineering, failing which POWERGRID reserves the right to reject the equipment.
	8.3.18	Contractor may establish a field test Laboratory to execute Civil Construction testing requirements at site with the condition that all testing equipment shall be calibrated from POWERGRID approved accredited Testing laboratories, with calibration certificates kept available at site and all testing personnel employed in the Field Testing Laboratories to be qualified and experienced Engineers or testing to be carried out at POWERGRID approved Third Party Laboratories.
	8.3.19	Contractor shall ensure that all possible steps are taken to avoid damage to the equipment during transport, storage and erection.
	8.3.20	Contractor shall implement additional stringent quality checks and preparation during installation of GIS at site (if applicable) as per POWERGRID approved guidelines/Technical specifications.
	8.3.21	Contractor shall ensure commissioning of all CSDs along with Circuit Breakers wherever applicable
	8.3.22	For EHV transformers/reactors: Insulation oil shall be as per POWERGRID Technical specifications and same grade shall be used for impregnation of the active part & testing at the works of Transformer/Reactor Manufacturer and as well as for filling the Transformer/Reactors at site. Contractor to ensure that windings for Transformer/Reactors are made in air-conditioned environment. Core-coil assembly shall be performed in positive pressurized dust-controlled environment. Dust measurements shall be monitored regularly at Transformer / Reactor Manufacturer works. Contractor shall ensure that respective civil foundations & Fire walls for Transformer/Reactors units to be commissioned, shall be made ready at concerned sites before receipt of Transformer/Reactors units. All the requisite material for Neutral & Delta Bus formation required for charging of complete bank of 765KV class 1-ph Transformer/Reactor units shall be made available at the concerned sites before receipt of the Transformer/Reactor units at site
	8.3.23	The Employer reserves the right to increase or decrease their involvement in inspections at Contractor's Works or at his Sub-Contractor's premises or at the Employer's site or at any other place of Work based on performance of Contractor/sub Contractor
	8.3.24	Contractor/sub-vendor, who has more than one contract running concurrently for supply of material of same design and specification from the same factory, may propose to offer material in a single lot. No deduction from payments on account of call combination shall be made to the Contractor. However, POWERGRID reserves the right to carry out call combination as per requirement and decision of POWERGRID shall be final in this regard
	8.3.25	Unless specified otherwise, inspection shall be made at the place of manufacturer prior to dispatch and shall be conducted so as not to interfere unnecessarily with the operation of the work

S.No.	Clause No.	Amended As (As per Specific Requirement Rev 10)																																																																																											
		<p>8.3.26 Should any item being supplied be found not to comply with the supplied design, it shall be liable to rejection. No item once rejected shall be resubmitted for inspection, except in cases where the Employer or his authorized representative considers that the defects can be rectified. All rejected material shall be disposed-off/destroyed under intimation to Employer QA&amp;I representative as per laid down procedures.</p> <p>8.3.27 The specified grade and quality of material from approved source shall be used by the Contractor. To ascertain the quality of material used, the inspector may at his discretion get the material tested at an approved laboratory.</p>																																																																																											
5.	Clause no. 9.2	<p>The reports for all type tests as per technical specification shall be furnished by the Contractor along with equipment / material drawings. However, type test reports of similar equipments/ material already accepted in POWERGRID shall be applicable for all projects with similar requirement. The type tests conducted earlier should have either been conducted in accredited laboratory (accredited based on ISO / IEC Guide 25 / 17025 or EN 45001 by the national accreditation body of the country where laboratory is located) or witnessed by POWERGRID/representative authorized by POWERGRID/representative of Utility /representative of accredited test lab/ representative of The National Accreditation Board for Certification Bodies (NABCB) certified agency shall also be acceptable.</p> <p>Unless otherwise specified elsewhere, the type test reports submitted shall be of the tests conducted within the years specified below from the date of NOA. In case the test reports are of the test conducted earlier than the years specified below from the date of NOA, the contractor shall repeat these test(s) at no extra cost to the Employer:-</p> <table border="1" style="width: 100%; border-collapse: collapse;"> <thead> <tr> <th>S. No.</th> <th>Name of Equipment</th> <th colspan="2">Validity of type test( in years )</th> </tr> </thead> <tbody> <tr><td>1</td><td>Power Transformer</td><td>5</td><td></td></tr> <tr><td>2</td><td>LT Transformer</td><td>5</td><td></td></tr> <tr><td>3</td><td>Shunt Reactor</td><td>5</td><td></td></tr> <tr><td>4</td><td>OLTC</td><td>10</td><td></td></tr> <tr><td>5</td><td>Bushing of Power Transformers/Reactors</td><td>7</td><td></td></tr> <tr><td>6</td><td>Fittings and accessories for Power transformers &amp; Reactors</td><td>10</td><td></td></tr> <tr><td>7</td><td>Circuit Breaker</td><td>10</td><td></td></tr> <tr><td>8</td><td>Isolator</td><td>10</td><td></td></tr> <tr><td>9</td><td>Lighting Arrester</td><td>10</td><td></td></tr> <tr><td>10</td><td>Wave Trap</td><td>10</td><td></td></tr> <tr><td>11</td><td>Instrument transformer</td><td>10</td><td></td></tr> <tr><td>12</td><td>GIS &amp; Hybrid GIS</td><td>15</td><td></td></tr> <tr><td>13</td><td>LT Switchgear</td><td>10</td><td></td></tr> <tr><td>14</td><td>Cable and associated accessories</td><td>10</td><td></td></tr> <tr><td>15</td><td>Relays</td><td>7</td><td></td></tr> <tr><td>16</td><td>Capacitors</td><td>10</td><td></td></tr> <tr><td>17</td><td>Battery and Battery charger</td><td>10</td><td></td></tr> <tr><td>18</td><td>Conductor &amp; Earth wire</td><td>10</td><td></td></tr> <tr><td>19</td><td>Insulators ( Porcelain/Glass)</td><td>10</td><td></td></tr> <tr><td>20</td><td>Composite Insulators</td><td>5</td><td></td></tr> <tr><td>21</td><td>PLCC</td><td>5</td><td></td></tr> </tbody> </table> <p>Note:- For all other equipment's validity of type test shall be 10 years from date of NOA. Further, in the event of any discrepancy in the test reports i.e. any test report not acceptable due to any design/manufacturing changes or due to non-compliance with the requirement stipulated in the Technical Specification or any/all type tests not carried out, same shall be carried out without any additional cost implication to the Employer.</p> <p>The Contractor shall intimate the Employer the detailed program about the type tests atleast two (2) weeks in advance in case of domestic supplies &amp; six (6) weeks in advance in case of foreign supplies.</p>				S. No.	Name of Equipment	Validity of type test( in years )		1	Power Transformer	5		2	LT Transformer	5		3	Shunt Reactor	5		4	OLTC	10		5	Bushing of Power Transformers/Reactors	7		6	Fittings and accessories for Power transformers & Reactors	10		7	Circuit Breaker	10		8	Isolator	10		9	Lighting Arrester	10		10	Wave Trap	10		11	Instrument transformer	10		12	GIS & Hybrid GIS	15		13	LT Switchgear	10		14	Cable and associated accessories	10		15	Relays	7		16	Capacitors	10		17	Battery and Battery charger	10		18	Conductor & Earth wire	10		19	Insulators ( Porcelain/Glass)	10		20	Composite Insulators	5		21	PLCC	5	
S. No.	Name of Equipment	Validity of type test( in years )																																																																																											
1	Power Transformer	5																																																																																											
2	LT Transformer	5																																																																																											
3	Shunt Reactor	5																																																																																											
4	OLTC	10																																																																																											
5	Bushing of Power Transformers/Reactors	7																																																																																											
6	Fittings and accessories for Power transformers & Reactors	10																																																																																											
7	Circuit Breaker	10																																																																																											
8	Isolator	10																																																																																											
9	Lighting Arrester	10																																																																																											
10	Wave Trap	10																																																																																											
11	Instrument transformer	10																																																																																											
12	GIS & Hybrid GIS	15																																																																																											
13	LT Switchgear	10																																																																																											
14	Cable and associated accessories	10																																																																																											
15	Relays	7																																																																																											
16	Capacitors	10																																																																																											
17	Battery and Battery charger	10																																																																																											
18	Conductor & Earth wire	10																																																																																											
19	Insulators ( Porcelain/Glass)	10																																																																																											
20	Composite Insulators	5																																																																																											
21	PLCC	5																																																																																											
6.	Clause No.12.3.6 S.No.4	S.No.	PIPE LINE	Base colour	Band colour																																																																																								
		4	Pylon support pipes	BLACK	-																																																																																								
7.	Clause No. 14.4	CCTV system for Construction Monitoring for Substation/STATCOM Packages – To be provided by the contractor																																																																																											



B. Section GIS Rev 5A		
1.	New Para under Clause no.1	For GIS equipment of 52kV and above voltage class envisaged in one substation under a single package, can be supplied from more than one GIS manufacturers, however GIS for each voltage level shall be supplied from a single GIS manufacturer. Further a legally enforceable undertaking (jointly with the each GIS Manufacturer) as per enclosed format to be submitted along with the bidding documents.
2.	Clause no 5.12	<i>“The maximum relative SF6 gas leakage rate shall not exceed 0.5% (half percent) per year for the whole equipment and for any individual gas compartment separately and the leakage rate shall be guaranteed for at least 10 years. In case the leakage under the specified conditions is found to be greater than 0.5% after commissioning <b>during warranty period, the contractor shall rectify the defects to meet the leakage requirement</b> and the manufacturer will have to supply free of cost, the total gas requirement for subsequent ten (10) years, based on actual leakage observed during the <b>warranty period.</b></i> <i><b>The maximum relative leakage rate for type tests shall be ≤ 0.1 % per year..”</b></i>
3.	Clause no 5. 24	<i>“The enclosure shall be designed to practically eliminate the external electromagnetic field and thereby electro-dynamic stresses even under short circuit conditions.”</i>
4.	Clause no 5.27	<i>Suitable portable scissor lift (as specified in BPS) for GIS shall be provided for access of distant portion of GIS installation.</i>
5.	Clause no. 5.31	Alarm circuit shall not respond to faults for momentary conditions. The following indications including those required elsewhere in the specifications shall be generally provided in the alarm and indication circuits. <b>Gas Insulating System:</b> i) Loss of Gas Density

S.No.	Clause No.	Amended As (As per Specific Requirement Rev 10)
		<p><b>Operating System:</b></p> <p>i) Low operating pressure  ii) Loss of operating power  iii) Loss of control supply  iv) Pole Discordance.</p>
6.	New Clause no. 5.39.8	Reference Guidelines for GIS Grounding shall be as per <b>Annexure-12 (Attached at Annexure-S10)</b>
7.	Clause no. 5.40	Adequate number of UHF sensors shall be provided in the offered GIS of voltage level 220kV and above for detection of Partial discharge (of 5pC and above) as per IEC 60270. The number and location of these sensors.....in close proximity to VT compartments. However, adequacy of number of sensors..... to complete the technical requirement. The calibration and frequency response.....couplers meeting this requirement.
8.	Clause no. 5.41	<i>“GIS manufacturer as per their design shall preferably use maximum <b>Fifteen</b> standard straight horizontal outdoor bus duct lengths for entire GIS installation to optimize the spare requirement.”</i>
9.	New Clause no. 5.41(10)	The price of Bus-duct inside the GIS hall shall be integral part of the respective bay module and it will not be paid separately. However, the payment of bus-duct for outside the GIS hall along with support structure shall be paid as per running meters in line with provision of Bid Price schedule.
10.	New Para added under Clause no. 5.43.2	The gas density monitoring devices shall have IP rating of IP65 or better and Suitable canopy shall be provided to prevent ingress of rain water for outdoor application.
11.	Clause no. 6.8.2	The CSD shall be provided in following circuit breakers: <ul style="list-style-type: none"> <li>a) 765kV <ul style="list-style-type: none"> <li>• Main and Tie bay for Auto Transformer</li> <li>• Main and Tie bay of Bus Reactor</li> <li>• Switchable Line Reactor bay</li> </ul> </li> <li>b) 400kV <ul style="list-style-type: none"> <li>• Main and Tie bay for 765/400kV &amp; 400/220kV Auto Transformer</li> <li>• Main and Tie bay of Bus Reactor</li> <li>• Switchable Line Reactor bay</li> </ul> </li> <li>c) 220 &amp; 132kV <ul style="list-style-type: none"> <li>• Bay for operation of Shunt reactor</li> </ul> </li> </ul> The requirement of CSD shall be explicitly specified in price schedule.
12.	New Clause 6.8.3 (n)	For Circuit breaker with CSD controlling a Transformer following is applicable <i>“The limit for inrush current for switching of Transformer by CSD shall be 1.0 p.u. of rated current of transformer after fine tuning of CSD settings during pre-commissioning checks. For site acceptance of CSD, during online CSD test after fine tuning inrush current should be less than 1.0 P.U. of rated current in five consecutive operations”.</i>
13.	New Clause no. 10.1.3(n)	For 400kV & above voltage class GIS bay module, CT cores shall be duly distributed on both side of circuit breaker. For 220 kV and below voltage level GIS bay module, CT on one side of the circuit breaker is also acceptable.
14.	New Clause no. 15.2.14	All 765kV & 400kV Circuit Breaker control schematics shall be finalized in such a way, that it may operate with or without CSD by using a suitable selector switch irrespective of whether circuit breakers to be supplied are envisaged along with CSD or not as per bid price schedules.
15.	Clause no. 17.1	<i>“For erection &amp; maintenance of largest/heaviest GIS component/assembly, one number of EOT Crane of suitable capacity shall be provided for GIS Hall. The crane shall consist of all special requirements for erection &amp; maintenance of GIS equipment.”</i> <i>On completion of erection of the switchgear, the Contractor shall completely service the crane before the Taking Over Certificate is issued.</i>
16.	Clause no 17.2	Deleted
17.	Clause no 17.3	Deleted
18.	New Para added under	During detailed engineering, the type test reports of GIS equipment of the parent company/subsidiary company/group company shall also be acceptable provided that the design of offered GIS is same as that of type tested GIS equipment.

S.No.	Clause No.	Amended As (As per Specific Requirement Rev 10)																		
	Clause no. 20																			
19.	Clause no 20, Sl. no. 14 of Table	14	Reactor current switching test for Inductive Current switching capability as per IEC 62271-110. Further, the manufacturer whose circuit breakers tested with smaller current w.r.t current limits specified for Reactor current switching test duty-2, 3 & 4 in IEC 62271-110 shall also be acceptable.																	
20.	Clause no 24.12	Deleted																		
21.	Annexure-1 S.No. 20 (i)	<table border="1"> <thead> <tr> <th>Parameter</th> <th>765kV system</th> <th>400kV system</th> <th>220kV system</th> <th>132 kV system</th> </tr> </thead> <tbody> <tr> <td>Pre-insertion resistor requirement</td> <td>As per BPS</td> <td>As per BPS</td> <td>NA</td> <td>NA</td> </tr> <tr> <td>Rating (ohms)</td> <td>Approx. 450 with tolerance as applicable</td> <td>Approx. 400 with tolerance as applicable</td> <td>NA</td> <td>NA</td> </tr> </tbody> </table>				Parameter	765kV system	400kV system	220kV system	132 kV system	Pre-insertion resistor requirement	As per BPS	As per BPS	NA	NA	Rating (ohms)	Approx. 450 with tolerance as applicable	Approx. 400 with tolerance as applicable	NA	NA
Parameter	765kV system	400kV system	220kV system	132 kV system																
Pre-insertion resistor requirement	As per BPS	As per BPS	NA	NA																
Rating (ohms)	Approx. 450 with tolerance as applicable	Approx. 400 with tolerance as applicable	NA	NA																
22.	Clause no 25 of Section GIS Rev 5A	<p><b>25. ON SITE TESTING</b></p> <p>After the GIS Switchgear has been fully installed at site and SF6 gas filled at rated filling density, the complete assembly shall be subjected to the site tests as per IEC-62271-203 and POWERGRID Asset Management Controlled Document No: D-3-01-09-01-02.</p> <p>25.1 Deleted</p> <p><b>25.2 Deleted.</b></p> <p>25.3. In case of a disruptive discharge in the gas as outlined in clause no: C.6.2.2 Procedure b), Annexure-C of IEC 62271-203 during the AC voltage test and a repeat test is performed due to this failure, then the repeat test shall be carried out at Specified voltage-</p> <p>25.4. Deleted.</p> <p>25.5. Method statement/ procedure of ON SITE high voltage testing, PD measurement and-test shall be submitted by contractor in advance</p>																		
23.	New Para under Clause no 26.	<p>Requirement for Mandatory spares for GIS</p> <p>a. Any equipment which is not supplied as main equipment or part of main equipment, mandatory spare for that is not applicable.</p> <p>b. It is recognized that the GIS manufacturer may have standardized the GIS design/equipment rating based on the manufacturer's standard practice. Alternate proposals, offering higher rating equipment (without additional cost implication), will also be considered provided such equipment meets the specified minimum designs rating, standard and performance requirements.</p> <p>c. In case contractor offers circuit breaker, dis-connector, current transformer, SF6/Air Bushing etc. under main equipment of higher rating than equipment rating specified in the specifications, the mandatory spare of same higher rating offered by contractor identical to main equipment offered in the package shall be required to be supplied against spares without any cost implication to POWERGRID.</p>																		
24.	Annexure-10 Rev-1	Annexure-10 Rev-1 (Standard Mandatory Spares for Gas Insulated Switchgear) of stands deleted.																		
25.	New Annexure-13	Standard GIS Module Description ( <b>Attached at Annexure-S11</b> )																		

**SECTION-GENERAL TECHNICAL REQUIREMENTS (GTR) Annexure K (Rev 01)**

<b>Sl. No.</b>	<b>Power System Equipment</b>	<b>Minimum Local Content (%)</b>
1	Power Transformers (up to 765 kV, including Generator Transformers)	60
2	Instrument Transformer (up to 765 kV)	60
3	Transformer Oil Dry Out System (TODOS)	60
4	Reactors up to 765 kV	60
5	Oil Impregnated Bushing (Up to 400kV)	60
6	Resin Insulated Paper (RIP) bushings (up to 145 kV)	50
7	Circuit Breakers (up to 765kV AC-Alternating Current)	60
8	Disconnectors, Isolators (up to 765kV AC)	60
9	Wave Trap (up to 765kV AC)	60
10	Oil Filled Distribution Transformers up to & including 33kV [Cold Rolled Grain Oriented (CRGO)/Amorphous, Aluminium/Copper wound]	60
11	Dry type Distribution Transformers up to & including 33kV (CRGO/Amorphous, Aluminium/Copper wound)	60
12	Conventional conductor	60
13	Accessories for conventional conductors	60
14	High Temperature/High Temperature Low Sag (HTLS) conductors (such as Composite core, GAP, ACSS, INVAR, AL59) and accessories	60
15	Optical ground wire (OPGW)- all designs	60
16	Fiber Optic Terminal Equipment (FOTE) for OPGW	50
17	OPGW related Hardware and accessories	60
18	Remote Terminal Unit (RTU)	50
19	Power Cables and accessories up to 33kV	60
20	Control cables including accessories	60
21	XLPE cables up to 220kV	60
22	Substation Structures	60
23	Transmission Line Towers	60
24	Porcelain (Disc/Long Rod) Insulators	60
25	Bus Post Insulators (Porcelain)	60
26	Porcelain Disc Insulators with Room Temperature Vulcanisation (RTV) coating	50
27	Porcelain Long Rod Insulators with Room temperature Vulcanisation (RTV) coating	50
28	Hardware Fittings for porcelain Insulators	60
29	Composite/Polymeric Long Rod Insulators	60
30	Hardware Fittings for Polymer Insulators	60
31	Bird Flight Diverter (BFD)	60
32	Power Line Carrier Communication (PLCC) system (up to 800kV)	60
33	Gas Insulated Switchgear (up to 400kV AC)	60
34	Gas Insulated Switchgear (above 400kV AC)	50
35	Surge/Lightning Arrester (up to 765kV AC)	60
36	Power Capacitors	60
37	Packaged Sub-station (6.6kV to 33kV)	60
38	Ring Main Unit (RMU) (up to 33kV)	60

**SECTION-GENERAL TECHNICAL REQUIREMENTS (GTR) Annexure K (Rev 01)**

39	Medium Voltage (MV) GIS panels (up to 33kV)	60
40	Automation and Control system/Supervisory Control and Data Acquisition (SCADA) system in Power system	50
41	Control and Relay panel (including Digital/Numerical relays)	50
42	Electrical motors 0.37kW to 1MW	60
43	Energy meters excluding smart meters	50
44	Control and Power cables and accessories (up to 1.1kV)	60
45	Diesel Generating (DG) set	60
46	DC system (DC Battery & Battery Charger)	60
47	AC and DC Distribution board	60
48	Indoor Air Insulated Switchgear (AIS) up to 33kV	60
49	Poles (PCC, PSCC, Rolled Steel Joist, Rail Pole, Spun, Steel Tubular)	60
50	Material for Grounding/earthing system	60
51	Illumination system	60
52	Overhead Fault Sensing Indicator (FSI)	50
53	Power Quality Meters	50
54	Auxiliary Relays	50
55	Load Break Switch	50
56	Cranes, EOT cranes, gantry crane & chain pulley blocks, etc	60
57	Elevator	60
Fire Protection and Detection system		
58	Motor driven fire water pumps	60
59	Diesel engine driven fire water pumps	60
60	Hydrant system	60
61	High velocity water spray system	60
62	Medium velocity water spray system	60
63	Foam Protection system	60
64	Inert gas flooding system	60
65	Fire tenders	60
66	Portable fire-extinguishers	60

## Annexure-G Rev 01

Sl. No	Item / Equipment	Reference document for inspection	Inspection Level
A.01	LT Transformer /Power Transformer/ Reactor/ Converter Transformer/ Filter Reactor	MQP/ITP	IV
A.02	Bushing	MQP	IV
A.03	Insulating Oil	POWERGRID TS	III
A.04	Oil storage tank for transformers	MQP	III
A.05	Nitrogen injection-based explosion prevention system	FAT/ITP	III
A.06	Online oil drying system for transformers	POWERGRID TS	II**
A.07	Online DGA and moisture monitoring system	POWERGRID TS	II**
A.08	Flow sensitive conservator isolation valve	POWERGRID TS	II**
A.09	Oil Filtration Machine	MQP	III
B.01	Circuit Breakers	MQP	IV
B.02	Current Transformers	MQP/ITP	IV
B.03	CVT/PT/IVT	MQP	IV
B.04	Isolators	MQP/ITP	IV
B.05	Surge Arrestors	MQP/ITP	III
B.06	Line Trap & Air Core Reactor	MQP/ITP	III
B.07	Point On switching device (CSD) for Circuit Breaker (wherever required)	FAT/ITP	I
C.01	STATCOM including Valve, valve base electronics, DC capacitor, series reactor and all accessories	ITP	IV
C.02	Mechanically switched Reactor bank (3-ph) including all accessories (MSR Branches)	ITP	IV
C.03	Mechanically switched Capacitor bank (3-ph) including all accessories (MSC Branches)	ITP	IV
C.04	Harmonic Pass filters	ITP	IV
C.05	HT Capacitor	MQP	IV
D.01	Thyristor Valve	FAT/ITP	III
D.02	PLC Capacitors for HVDC	FAT/ITP	III
D.03	Valve Cooling system for HVDC	FAT/ITP	III
D.04	AC/DC Filter Resistors	ITP	III
D.05	DC Current and Voltage measuring device for HVDC	FAT/ITP	III
D.06	Maintenance platform for valve hall	POWERGRID TS	II
D.07	Optical signal column for FSC	FAT/ITP	II
E.01	GIS including spares	MQP/ITP	IV
E.02	Dew Point Meter for GIS	POWERGRID TS	I*
E.03	Portable Partial Discharge monitoring system for GIS	POWERGRID TS	I*

Sl. No	Item / Equipment	Reference document for inspection	Inspection Level
E.04	Partial Discharge Monitoring System (Online) for GIS	ITP	III
E.05	PEB Structure and Puf Panels	MQP	III
F.01	Substation Automation system	FAT/MQP	III
F.02	Event Logger	POWERGRID TS	III
F.03	PLCC equipment Viz PLCC Terminal, Carrier equipment, Protection Coupler , Coupling Device but excluding EPABX / HF Cable	MQP	III
F.04	Control & Relay Panels	MQP	III
G.01	EHV Cables	MQP/ITP	III
G.02	Power Cables & Control Cables	MQP	III
G.03	Cable Joints (11 kV and above)	POWERGRID TS	II
G.04	Cable Lugs & Glands / Clamps/Terminations	POWERGRID TS	I
G.05	Distributed Temperature Sensing Instrument (DTS)	POWERGRID TS	II
H.01	LT Switchgear & ACDB/DCDB/MLDB/ELDB	MQP	III
H.02	Battery	POWERGRID TS	II
H.03	Battery Charger	MQP	III
H.04	UPS & Voltage Stabilizer	MQP/FAT	III
H.05	D. G. Set	FAT/ITP	III
H.06	Lighting Panel	POWERGRID TS	II
H.07	Lighting Poles	POWERGRID TS	II
H.08	Lighting Earthwire, Switches / sockets, Conduits, Lamps & fans including exhaust fans	POWERGRID TS	I
H.09	MS/GI /PVC Pipes for cable trenches and lighting	POWERGRID TS	I
H.10	Outdoor Receptacle	POWERGRID TS	I
H.11	Split A.C/window A.C./ precision AC/ Kiosk AC/ Cascade AC/ Tower AC	POWERGRID TS	I
H.12	Occupancy sensors for control of lighting	POWERGRID TS	I
H.13	Solar based street lighting pole including Solar Panel, Inverter, Controller, etc.	POWERGRID TS	III
H.14	Junction Box / Lighting Switch Boards / Bay MB / Portable Flood Light Panel	POWERGRID TS	II
H.15	Lighting transformer	POWERGRID TS	II
H.16	LED Lighting Fixtures	POWERGRID TS/FAT	III
I.01	SF6 gas processing unit, SF6 gas Leakage detector, SF6 gas Analyzer	POWERGRID TS	I*
I.02	SF6 Gas	POWERGRID TS	I
I.03	Spark Gap	FAT/ITP	III
I.04	Time synchronizing Equipment (GPS Clock)	POWERGRID TS	I
I.05	Galvanized Cable trays	POWERGRID TS	II
I.06	Video Monitoring System	FAT/ITP	I
I.07	Public Address System (All Components)	POWERGRID TS	I

Sl. No	Item / Equipment	Reference document for inspection	Inspection Level
I.08	Building Management System (All components)	POWERGRID TS	I
I.09	Access Control System (All Components)	POWERGRID TS	I
I.10	Video Display system/ Video Projection system	POWERGRID TS	I
I.11	VESDA (smoke detector)	POWERGRID TS	I
I.12	High Mast Pole	MQP	III
J.01	Aluminium ladder	POWERGRID TS	I
J.02	Hume Pipes	POWERGRID TS	I
J.03	Castle Key	POWERGRID TS	I
J.04	Water Treatment plant (All components).	POWERGRID TS	I
J.05	Furniture	POWERGRID TS	I
J.06	DOL Starter	POWERGRID TS	I
J.07	Oil Sample Bottles and Syringe	POWERGRID TS	I
J.08	Test & Measuring Equipment, T&P	POWERGRID TS	I*
K.01	EOT Crane	POWERGRID TS	II
K.02	Boom Crane/Golf Cart/Platform Truck/Man Lift/ Forklift/ Lifts	POWERGRID TS	II
L.00	Fire Protection System		
L.001	Panels, Hydro pneumatic tank for fire protection system.	POWERGRID TS	III
L.002	Deluge valve, Strainers, MS/GI pipes, Pumps, motors, air compressor, Solenoid and other valves, Diesel Engines	POWERGRID TS	II
L.003	Others	POWERGRID TS	I
M.00	HVAC SYSTEM		
M.001	Air Cooled Chiller	POWERGRID TS	III
M.002	Pump	POWERGRID TS	II
M.003	Air Handling Unit	POWERGRID TS	II
M.004	Fan Filter Unit With Centrifugal Blower	POWERGRID TS	II
M.005	Axial Flow Fan	POWERGRID TS	II
M.006	Main Climate Control Unit (Dehumidifier)	POWERGRID TS	I
M.007	Dampers	POWERGRID TS	II
M.008	Fire Dampers	POWERGRID TS	II
M.009	Pressure Gauge, Thermometers, Other Instruments / Sensors	POWERGRID TS	I
M.010	Grill, Diffuser, Jet Nozzle, Louvers etc	POWERGRID TS	I
M.011	Ducting	POWERGRID TS	III
M.012	M S Pipe	POWERGRID TS	II
M.013	Pipe Insulation Material	POWERGRID TS	I
M.014	Duct Insulation Material	POWERGRID TS	I
M.015	Underdeck Insulation Material	POWERGRID TS	I
M.016	Gate Valve & Non-Return valve	POWERGRID TS	I
M.017	Y Strainer	POWERGRID TS	II
M.018	Ball Valve/ Motorized Butterfly Valve/ Balancing Valve	POWERGRID TS	I

Sl. No	Item / Equipment	Reference document for inspection	Inspection Level
M.019	Closed Expansion Tank	POWERGRID TS	II
M.020	Air Separator	POWERGRID TS	I
M.021	MCC /PLC /Electrical Panels	POWERGRID TS	III
M.022	Propeller Fan/ Conduit	POWERGRID TS	II
M.023	Air Filter/ Mixing Valve with Thermostat	POWERGRID TS	I
N.01	SDH Equipment	FAT/ITP	IV
N.02	Termination Equipment Primary/ DI Multiplexer	FAT/ITP	IV
N.03	DACS	FAT/ITP	IV
N.04	Optical Amplifier	FAT/ITP	IV
N.05	FODP including pigtail, Joint Box, FDMS	FAT/ITP	II
N.06	IMPS	FAT/ITP	IV
N.07	Optical bypass switch	FAT/ITP	IV
N.08	Air Purifier	FAT/ITP	I
N.09	Patch cord & connector	FAT/ITP	I
N.10	NMS	FAT/ITP	IV
N.11	OPGW Cable	MQP/ITP/FAT	III
N.12	Hardware Fittings for OPGW cable	MQP/ITP	III
N.13	DCPS	FAT/ITP	III
N.14	Radio Links	FAT/ITP	III
N.15	SMPS based DC Power Supply (DCPS) system	FAT/ITP	III
N.16	WAMS (PMU & Accessories)	FAT/ITP	III
N.17	PUF Shelter	FAT/ITP	III
N.18	Aerial OFC/UGOFC/ADSS/FO Cable	FAT/ITP	III
N.19	DWDM	FAT/ITP	III
N.20	OTN	FAT/ITP	III
N.21	MPLS-TP Equipment	FAT/ITP	III
N.22	L2 Switch	FAT/ITP	III
N.23	IP-MPLS Router	FAT/ITP	III
N.24	HDPE Pipes	POWERGRID TS	II
N.25	Equipment Cabinets	POWERGRID TS	II
N.26	Main Distribution Frame	POWERGRID TS	I
N.27	Telephone system, EPABX, Telephone wires, Telephone sockets	POWERGRID TS	I
N.28	Fiber Optic Cable	MQP	III
N.29	Hardware Fittings for Fiber Optic cable	MQP	III
O.01	Re-rollers of MS/HT Angle Section and galvanized tower parts.	MQP	IV
O.02	Conductor	MQP	IV
O.03	Hardware fittings and Conductor & Earthwire Accessories	MQP	IV
O.04	Earth wire	MQP	IV

Sl. No	Item / Equipment	Reference document for inspection	Inspection Level
O.05	Insulator	MQP	IV
O.06	Bolts & Nuts of Gr 8.8 / 8	MQP	IV
O.07	Mono Pole	MQP	IV
O.08	Foundation Bolts and Anchor Bolts	POWERGRID TS	III
O.09	D-shackle/ Hanger / Links and associated Special bolt/nuts	MQP	III
O.10	Span Marker, Obstruction lights and Wind Measuring Equipment	POWERGRID TS	III
O.11	MS ROD rolled by Approved Re-roller of POWERGRID	MQP	III
O.12	MS ROD rolled by Approved steel producers of POWERGRID	POWERGRID TS	I
O.13	Spring Washers & Pack washers	POWERGRID TS	II
O.14	Bolts & Nuts Gr up to 5.6/5	POWERGRID TS	II
O.15	ACD & Barbed wire for ACD/Bird guard	POWERGRID TS	II
O.16	Danger Plate /Phase Plate / Number Plate / Circuit plate	POWERGRID TS	I
O.17	Sub Station Structure (lattice/pipe type)	MQP	III
O.18	Clamps & Connecters (including equipment connectors)	MQP	III
O.19	MS/ GI Flat, rod type, pipe type and other earthing material.	POWERGRID TS	II
O.20	Aluminium Tube & Busbar materials	POWERGRID TS	II
O.21	Pipe Type & Counter Poise Earthing	POWERGRID TS	II
O.22	Chemical and Mechanical Anchor Bolts	POWERGRID TS	I
O.23	Bird Flight Diverter	POWERGRID TS/FAT	II

For Equipment where requirement of MQP is envisaged, ITP/FAT will be followed If sourced from off shore. For items required in S/S or T/L or TELECOM/GA&C , same inspection level as specified shall be followed for all the cases.

\* MICC for test and measuring equipment (inspection level I or II) shall be issued only after actual verification/ demonstration of satisfactory performance at site.

\*\* Though level-2 items, CIP/MICC can be issued also on review of TCs and visual inspection of these item.

**MANUFACTURING QUALITY PLAN**

<b>Manufacturers Details (Name, Works Address etc.)</b>	<b>Customer</b> <b>POWERGRID</b>	<b>Vendor's Code:</b>	<b>Item:</b>	<b>Q.P. No.</b>  <b>Rev. No.</b>  <b>Date:</b>	<b>Valid From:</b>  <b>Valid Upto:</b>
---	-------------------------------------	-----------------------	--------------	--	--

Sr. No.	Components / Operations & Description of Test	Type of check	Quantum of Check / Sampling with basis	Reference document for Testing	Acceptance Norms	Format of Record	Applicable Codes						Remarks
							1	2	3	4	5	6	
A. Section: RAW MATERIAL INSPECTION													
B. Section : IN PROCESS INSPECTION													
C. Section: FINAL TESTING													
D. Section: PACKING & DISPATCH													

**MANUFACTURING QUALITY PLAN**

		Customer	Vendor's Code:	Item:	Q.P. No.	Valid From:
		<b>POWERGRID</b>			<b>Rev. No. Date:</b>	<b>Valid Upto:</b>
<b>Code 1</b>	Indicates place <b>where testing is planned</b> to be performed i.e. Inspection location					
A	At Equipment Manufacturer's works					
B	At Component Manufacturer's works					
C	At Authorized Distributor's place					
D	At Independent Lab					
E	At Turn Key Contractor's location					
F	Not specified					
<b>Code 2</b>	Indicates <b>who has to perform the tests</b> i.e. Testing Agency					
J	The Equipment Manufacturer					
K	The Component Manufacturer					
L	The Third Party					
M	The Turnkey Contractor					
<b>Code 3</b>	Indicates <b>who shall witness</b> the tests i.e. Witnessing Agency					
P	Component Manufacturer itself					
Q	Component Manufacturer and Equipment Manufacturer					
R	Component Manufacturer, Equipment Manufacturer and Contractor					
S	Equipment Manufacturer itself					
T	Equipment Manufacturer and Contractor					
U	Equipment Manufacturer and/or Contractor and POWERGRID					
V	Third Party itself					
<b>Code 4</b>	Review of Test Reports/Certificates					
W	By Equipment manufacturer during raw material/bought out component inspection.					
X	By Contractor during product/process inspection					
Y	By POWERGRID during product/process inspection					
Z	By Contractor and/or POWERGRID during product/process inspection					
<b>Code 5</b>	Whether specific approval of sub-vendor / Component make is envisaged?					
E	Envisaged					
	Not Envisaged					
<b>Code 6</b>	Whether test records required to be submitted after final inspection for issuance of CIP/MICC					
Y	Yes					
N	No					

### **Reference Guidelines for GIS Grounding**

#### **1. GIS Grounding**

These reference guidelines are minimum requirement and do not override manufacturer's recommendations or design criteria. These Reference Guidelines shall be read and implemented in conjunction with manufacturer recommendation/Criteria for GIS grounding design.

GIS Grounding system shall be designed to provide low-impedance grounding path for ground fault currents. Very Fast Transient generated due to electrical breakdown in the insulating gas, either across the contacts of a switching device during operation or under fault conditions shall also need to be considered in the overall grounding design for GIS. Grounding conductors or system of conductors shall be provided for connecting all designated metallic components of gas-insulated substation (GIS) to a substation grounding system.

**1.1. Power Frequency Grounding:** Manufacturer recommended designated grounding points of GIS equipment shall be connected with the risers directly coming from buried main GIS grounding mat. The Size of the conductor (copper) for making this connection shall be submitted by GIS manufacturer based on the specified fault current and its duration. The location and numbers of above said risers shall be as per the manufacturer recommended designated grounding points for GIS equipment. Main GIS grounding mat shall be buried at the level of station grounding mat. It shall be made up of same conductor as that of station grounding mat. The spacing of main GIS grounding mat for different voltage levels of GIS shall be as per attached Typical Drawing.

**1.2. High Frequency Grounding of GIS equipment:** Dedicated copper grounding mesh with specified spacing and cross-section shall be provided at the top of GIS building finished floor level. This dedicated copper grounding mesh shall be spread-over, beneath complete GIS switchgears installation and extended up to 500 mm away in all direction from GIS switchgears installation. This dedicated copper grounding mesh shall be directly connected to the GIS enclosures (min. at two distant points in each phase/bay) and to the risers directly coming from GIS grounding mat (min. at two distant locations per phase/bay) with the shortest path to the connection point. All Crossing of copper grounding mesh shall be suitably clamped/welded together. Bolted joint at crossings is not allowed, further this copper grounding mesh shall be clamped adequately to the floor at suitable locations. At the jointing of two different metals the joint shall be made using requisite bi-metallic jointer. This dedicated copper grounding mesh is laid at the top of GIS floor and shall also be connected with dedicated grounding rod electrodes provided at a regular interval of not more than 12 meters around periphery of GIS building. This copper grounding mesh shall be laid after the GIS bays are place on the floor and shall be suitably covered with Non-Electrostatic rubber mats to avoid damage to mesh and to avoid hinderance in regular operation of equipment. The Spacing, conductor detail and cross-section of copper grounding mesh shall be as per attached Typical Drawing.

Typical Drawing No, Standard/GIS/GROUNDING/01 for above said grounding recommendation is part of this document.

1 2 3 4 5 6 7 8

- A - TYPICAL SPACING FOR STATION GROUNDING MAT
- B - TYPICAL SPACING FOR MAIN GIS GROUNDING MAT
- C - COPPER GROUNDING MESH

- ✓ CONNECTION POINT OF COPPER GROUNDING MESH WITH GIS ENCLOSURE (TYP.)
- ⊗ CONNECTION POINT OF COPPER GROUNDING MESH WITH MAIN GIS GROUNDING MAT RISERS(75X12 MM GI FLAT) (TYP.)
- ⊕ COPPER CLAMP/WELDED JOINT (TYP.)
- 3000mm LONG, 40mm DIA ROD ELECTRODE

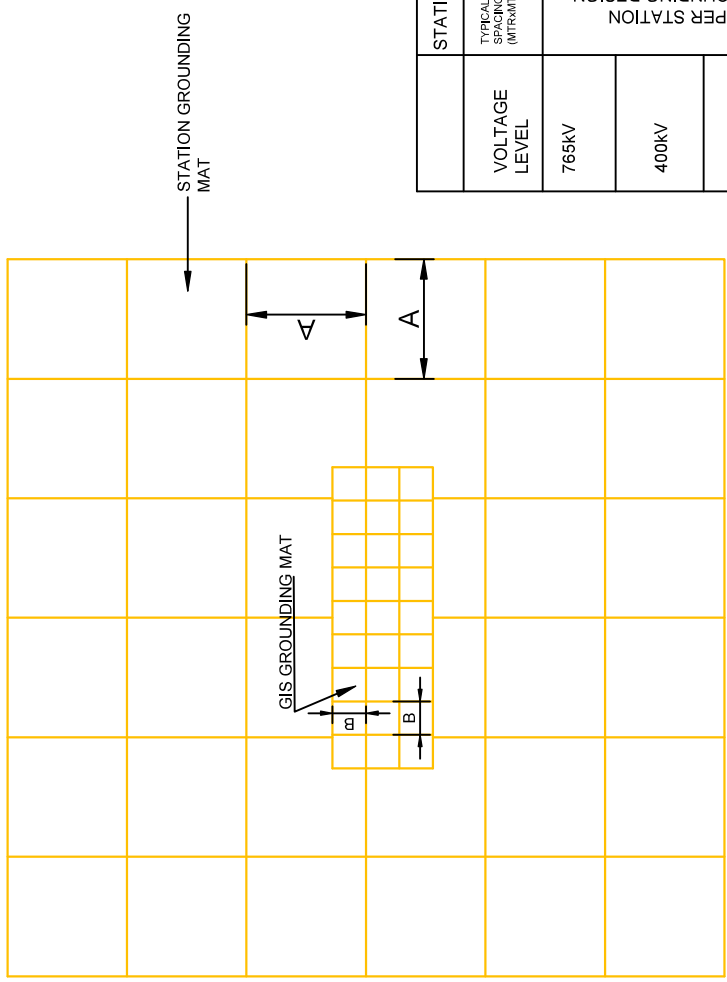

VOLTAGE LEVEL	STATION GROUNDING MAT		MAIN GIS GROUNDING MAT		COPPER GROUNDING MESH		
	TYPICAL SPACING (MTR/MTR)	PLACEMENT AT (TYP.)	CONDUCTOR (TYP.)	PLACEMENT AT (TYP.)	TYPICAL SPACING (MTR/MTR)	PLACEMENT AT (TYP.)	CONDUCTOR CROSS SECTION
765kV	AS PER STATION GROUNDING DESIGN	600MM BELOW FGL	40MM DIA. MS ROD	600MM BELOW FGL	5x5	GIS BUILDING FLOOR FFL	50x6mm
400kV					3x3		50x6mm
220kV & 132kV					3x3		---

**NOTES:-**

1. THIS DRAWING SHALL BE REFERRED AS COLORED PRINT ONLY.
2. THESE REFERENCE GUIDELINES DO NOT OVERRIDE MANUFACTURER'S RECOMMENDATIONS OR DESIGN CRITERIA. THESE REFERENCE GUIDELINES SHALL BE READ AND IMPLEMENTED IN CONJUNCTION WITH MANUFACTURER RECOMMENDATION/CRITERIA FOR GIS GROUNDING DESIGN.
3. THE MAIN GIS GROUNDING MAT SHALL BE LAID BENEATH GIS BUILDING COVERING LENGTH AND WIDTH OF GIS BUILDING.
4. ANNEXURE FOR "REFERENCE GUIDELINES FOR GIS GROUNDING" ENCLOSED.

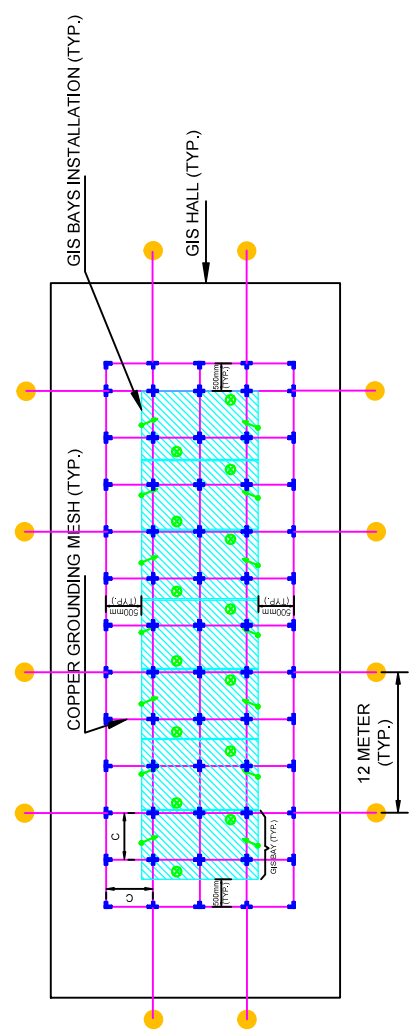

**POWER GRID CORPORATION OF INDIA LIMITED**  
(A GOVERNMENT OF INDIA ENTERPRISE)

**TITLE: TYPICAL GIS GROUNDING REFERENCE GUIDELINES**

DATE: 23/06/2026  
 SCALE: 1:1  
 SHEET NO: 01/01  
 OF: 01

1 2 3 4 5 6 7 8

DESCRIPTION OF GIS BAY MODULE & EQUIPMENTS

765kV Gas Insulated Switchgear (One & half breaker Scheme) .....

420kV Gas Insulated Switchgear (One & half breaker Scheme) .....

Gas Insulated Outdoor Bus Duct (GIB): .....

Gas Insulated SF6 to Air Termination: .....

## DESCRIPTION OF 800KV & 420kV GIS BAY MODULES & EQUIPMENTS

### **A. 765kV Gas Insulated Switchgear (One & half breaker Scheme)**

The SF6 gas insulated switchgear (50 Hz) shall be of the indoor metal-enclosed type & configuration of different GIS modules shall be as specified below:

#### **i) GIS Bus bar Module:**

**Three isolated phase, SF6 gas-insulated metal enclosed bus bar module, each set comprising of the following:**

- i. Three (3) no's individual bus bars enclosures running across the length of the switchgear to interconnect each of the bay modules in one and a half breaker bus system.
- ii. One (1) number 3-phase, single pole, group operated isolator switches, complete with manual and motor driven operating mechanisms.
- iii. One (1) number 3-phase, single pole, group operated safety grounding switches, complete with manual and motor driven operating mechanisms.
- iv. Three (3) numbers 1-phase Potential Transformers.
- v. Gas monitoring devices, barriers, pressure switches, UHF PD Sensors, Support structures etc., as required.
- vi. End Piece (Interface) modules with isolating test link for Future extension **on both sides** of Bus bar module. The end piece module shall be designed in such a way so that future GIS module may be tested without extending voltage to existing bus by removing the test link. End piece (interface) module for both the buses shall be in one alignment.
- vii. Three (3) numbers single phase, SF6 ducts (as required) inside GIS hall.
- viii. Local Control Cubicle (if required separately).

#### **ii) GIS Line Bay module:**

**SF6 gas-insulated metal enclosed Line feeder bay module, each set comprising of the following:**

- i. One (1) number 3-phase, SF6 insulated circuit breaker (#) with/without PIR complete with operating mechanism.
- ii. Three (3) numbers 1-phase, 3-core, multi ratio, current transformers (CTA) on one side of circuit breaker.
- iii. Three (3) numbers 1-phase, 2-core, multi ratio, current transformers (CTB) on other side of circuit breaker.
- iv. Three (3) numbers, 3-phase, single pole, group operated isolator switches, complete with manual and motor driven operating mechanisms.
- v. Two (2) numbers 3-phase, single pole, group operated safety grounding switches, complete with manual and motor driven operating mechanisms.

Technical Specification, Section – Project {Rev.01}

*765kV GIS New Substation Package SS 171T for a) Establishment of 765kV level at Kolhapur (PG) GIS S/s and b) Extn. of 400kV GIS at Kolhapur (PG) GIS S/s associated with "Network Expansion Scheme in Western Region to cater to pumped storage potential near Satara (up to 4500MW) - Part A" through TBCB route*

## **DESCRIPTION OF 800KV & 420kV GIS BAY MODULES & EQUIPMENTS**

- vi. One (1) number 3-phase, single pole, group operated high speed fault making grounding switch, complete with manual and motor driven operating mechanisms.
- vii. Three (3) numbers single phase, SF6 ducts inside GIS hall (up to the outer edge of the wall of GIS Hall).
- viii. Gas monitoring devices, barriers, pressure switches, UHF PD Sensors, support structures etc., as required.
- ix. Local Control Cubicle.

‘#’ As per BPS

### **iii) GIS Tie Bay module:**

**SF6 gas-insulated metal enclosed Tie bay module, each set comprising of the following:**

- i. One (1) number 3-phase, SF6 insulated circuit breaker (#) with/without PIR complete with operating mechanism.
- ii. Three (3) numbers 1-phase, 3-core, multi ratio, current transformers (CTA) on one side of circuit breaker.
- iii. Three (3) numbers 1-phase, 3-core, multi ratio, current transformers (CTA) on other side of circuit breaker.
- iv. Two (2) numbers 3-phase, single pole, group operated isolator switches, complete with manual and motor driven operating mechanisms.
- v. Two (2) numbers 3-phase, single pole, group operated safety grounding switches, complete with manual and motor driven operating mechanisms.
- vi. Gas monitoring devices, barriers, pressure switches, UHF PD Sensors, support structures etc. as required.
- vii. Local Control Cubicle.

‘#’ As per BPS

### **iv) GIS ICT Bay module:**

**SF6 gas-insulated metal enclosed ICT bay module, each set comprising of the following:**

- i. One (1) number 3-phase, SF6 gas insulated circuit breaker without PIR, complete with operating mechanism.
- ii. Three (3) numbers 1-phase, 3-core, multi ratio, current transformers (CTA) on one side of circuit breaker.
- iii. Three (3) numbers 1-phase, 2-core, multi ratio, current transformers (CTB) on other side of circuit breaker.
- iv. Two (2) numbers 3-phase, single pole, group operated isolator switches complete with manual and motor driven operating mechanisms.

*Technical Specification, Section – Project {Rev.01}*

*765kV GIS New Substation Package SS 171T for a) Establishment of 765kV level at Kolhapur (PG) GIS S/s and b) Extn. of 400kV GIS at Kolhapur (PG) GIS S/s associated with "Network Expansion Scheme in Western Region to cater to pumped storage potential near Satara (up to 4500MW) - Part A" through TBCB route*

## **DESCRIPTION OF 800KV & 420kV GIS BAY MODULES & EQUIPMENTS**

- v. Two (2) numbers 3-phase, single pole, group operated safety grounding switches complete with manual and motor driven operating mechanisms.
  - vi. Three (3) numbers 1-phase, individual pole operated isolator switches, complete with manual and motor driven operating mechanisms.
  - vii. Three (3) numbers 1-phase, individual pole operated safety grounding switches, complete with manual and motor driven operating mechanisms.
  - viii. Three (3) numbers 1-phase, individual pole operated isolator switches, complete with manual and motor driven operating mechanisms for switching of Spare ICT through Auxiliary bus. The isolator must meet the operational requirement in terms of Phase-phase insulation withstand capability.
  - ix. Three (3) numbers single phase, SF6 ducts inside the GIS hall (up to the outer edge of the wall of GIS Hall)
  - x. Gas monitoring devices, barriers, pressure switches, UHF PD sensors, support structures etc. as required.
  - xi. Local Control cubicle.
- v) **GIS Auxiliary Bus module for Spare ICT Connection:**  
**Set of isolated phase, SF6 gas-insulated metal enclosed Auxiliary bus bars module for ICT bays, each set comprising of the following:**
- i. One (1) number 1-Phase, Auxiliary bus bar enclosure running across the length of the switch gear to inter-connect the spare unit of ICT with all ICT bay Modules through GIS Duct and provision of extension for future ICT.
  - ii. One (1) number 1-Phase, single pole operated safety grounding switch, complete with manual and motor driven operating mechanisms.
  - iii. One (1) number single phase, SF6 ducts inside the GIS hall (up to the outer edge of the wall of GIS Hall).
  - iv. Gas monitoring devices, barriers, pressure switches, UHF PD sensors, support structures etc. as required.
  - v. End Piece (Interface) module with Isolating test link for Future extension **on both sides** of Auxiliary Bus bar module. The end piece module shall be designed in such a way so that future GIS module may be tested without extending voltage to existing bus by removing the test link.
- vi) **GIS Bus Reactor Bay module:**  
**SF6 gas insulated metal enclosed Bus Reactor Bay module, each set comprising of the following:**
- i. One (1) number 3-phase, SF6 gas insulated circuit breaker without PIR, complete with operating mechanism.

### **DESCRIPTION OF 800KV & 420kV GIS BAY MODULES & EQUIPMENTS**

- ii. Three (3) numbers 1-phase, 3-core, multi ratio, current transformers (CTA) on one side of circuit breaker.
  - iii. Three (3) numbers 1-phase, 2-core, multi ratio, current transformers (CTB) on other side of circuit breaker.
  - iv. Two (2) numbers 3-phase, single pole, group operated isolator switches complete with manual and motor driven operating mechanisms.
  - v. Two (2) numbers 3-phase, single pole, group operated safety grounding switches complete with manual and motor driven operating mechanisms.
  - vi. Three (3) numbers 1-phase, individual pole operated isolator switches, complete with manual and motor driven operating mechanisms.
  - vii. Three (3) numbers 1-phases, individual pole operated safety grounding switches, complete with manual and motor driven operating mechanisms.
  - viii. Three (3) numbers 1-phase, individual pole operated isolator switches, complete with manual and motor driven operating mechanisms for switching of Spare Bus reactor through Auxiliary bus. The isolator must meet the operational requirement in terms of Phase-phase insulation withstand capability.
  - ix. Three (3) numbers single phase, SF6 ducts inside the GIS hall (up to the outer edge of the wall of GIS Hall)
  - x. Gas monitoring devices, barriers, pressure switches, UHF PD sensors, support structures etc. as required.
  - xi. Local Control cubicle.
- vii) GIS Switchable Line Reactor Bay module:**  
**SF6 gas insulated metal enclosed Switchable Line reactor bay module, each set comprising of the following:**
- i. One (1) number 3-phase, SF6 gas insulated circuit breaker without PIR, complete with operating mechanism.
  - ii. One (1) number 3-phase, single pole, group operated isolator switches complete with manual and motor driven operating mechanisms.
  - iii. One (1) number 3-phase, single pole, group operated safety grounding switches complete with manual and motor driven operating mechanisms.
  - iv. Three (3) numbers 1-phase, individual pole operated isolator switches, complete with manual and motor driven operating mechanisms.
  - v. Three (3) numbers 1-phases, individual pole operated safety grounding switches, complete with manual and motor driven operating mechanisms.

## DESCRIPTION OF 800KV & 420kV GIS BAY MODULES & EQUIPMENTS

- vi. Three (3) numbers 1-phase, individual pole operated isolator switches, complete with manual and motor driven operating mechanisms for switching of Spare Line reactor through Auxiliary bus. The isolator must meet the operational requirement in terms of Phase-phase insulation withstand capability.
- vii. Three (3) numbers single phase, SF6 ducts inside the GIS hall (up to the outer edge of the wall of GIS Hall)
- viii. Gas monitoring devices, barriers, pressure switches, UHF PD sensors, support structures etc. as required.
- ix. Local Control cubicle.

### **viii) GIS Auxiliary Bus module for Spare Reactor Connection:**

**Set of isolated phase, SF6 gas-insulated metal enclosed Auxiliary bus bars module for Reactor bays, each set comprising of the following:**

- i. One (1) number 1-Phase, Auxiliary bus bar enclosure running across the length of the switch gear to inter-connect the spare unit of Reactor with all Reactor Bay Modules through GIS Duct and provision of extension for future Reactors.
- ii. One (1) number 1-Phase, single pole operated safety grounding switch, complete with manual and motor driven operating mechanisms.
- iii. One (1) number single phase, SF6 ducts inside the GIS hall (up to the outer edge of the wall of GIS Hall)
- iv. Gas monitoring devices, barriers, pressure switches, UHF PD sensors, support structures etc. as required.
- vi. End Piece (Interface) module with Isolating test link for Future extension **on both sides** of Auxiliary Bus bar module. The end piece module shall be designed in such a way so that future GIS module may be tested without extending voltage to existing bus by removing the test link.

### **B. 420kV Gas Insulated Switchgear (One & half breaker Scheme)**

The SF6 gas insulated switchgear (50 Hz) shall be of the indoor metal-enclosed type & configuration of different GIS modules shall be as specified below:

#### **i) GIS Bus bar Module Extension:**

**Extension of Three isolated phase, SF6 gas-insulated metal enclosed bus bar module, each set comprising of the following: -**

- i. Three (3) no's individual bus bars enclosures running across the length of the switchgear to interconnect each of the bay modules in one and a half breaker bus system.
- ii. Gas monitoring devices, barriers, pressure switches, UHF PD Sensors, Support structures etc., as required.

*Technical Specification, Section – Project {Rev.01}*

*765kV GIS New Substation Package SS 171T for a) Establishment of 765kV level at Kolhapur (PG) GIS S/s and b) Extn. of 400kV GIS at Kolhapur (PG) GIS S/s associated with "Network Expansion Scheme in Western Region to cater to pumped storage potential near Satara (up to 4500MW) - Part A" through TBCB route*

## **DESCRIPTION OF 800KV & 420kV GIS BAY MODULES & EQUIPMENTS**

- iii. End Piece (Interface) modules with isolating test link for Future extension of Bus bar module **on one side**. The end piece module shall be designed in such a way so that future GIS module may be tested without extending voltage to existing bus by removing the test link. End piece (interface) module for both the buses shall be in one alignment.
- iv. Three (3) numbers single phase, SF6 ducts (as required) inside GIS Hall.
- ii) **GIS Extension piece (Interface) module for Busbar:**  
**Extension of Three isolated phase, SF6 gas-insulated metal enclosed bus bar module, each set comprising of the following:**
- i. Extension piece (Interface) module, as required to extend existing Main Busbar.
- ii. Gas monitoring devices, barriers, pressure switches, Support structures etc., as required.
- iii. All associated consumable items (i.e., O-ring, adsorbents etc.) with supervision of existing OEM (as required).
- iii) **GIS Line Bay module:**  
**SF6 gas-insulated metal enclosed Line feeder bay module, each set comprising of the following:**
- i. One (1) number 3-phase, SF6 insulated circuit breaker (#) with/without PIR complete with operating mechanism.
- ii. Three (3) numbers 1-phase, 3-core, multi ratio, current transformers (CTA) on one side of circuit breaker.
- iii. Three (3) numbers 1-phase, 2-core, multi ratio, current transformers (CTB) on other side of circuit breaker.
- iv. Three (3) numbers, 3-phase, single pole, group operated isolator switches, complete with manual and motor driven operating mechanisms.
- v. Two (2) numbers 3-phase, single pole, group operated safety grounding switches, complete with manual and motor driven operating mechanisms.
- vi. One (1) number 3-phase, single pole, group operated high speed fault making grounding switch, complete with manual and motor driven operating mechanisms.
- vii. Three (3) numbers single phase, SF6 ducts inside GIS hall (up to the outer edge of the wall of GIS Hall).
- viii. Gas monitoring devices, barriers, pressure switches, UHF PD Sensors, support structures etc., as required.
- ix. Local Control Cubicle.
- '#' As per BPS
- iv) **GIS Tie Bay module:**  
**SF6 gas-insulated metal enclosed Tie bay module, each set comprising of the following:**

*Technical Specification, Section – Project {Rev.01}*

*765kV GIS New Substation Package SS 171T for a) Establishment of 765kV level at Kolhapur (PG) GIS S/s and b) Extn. of 400kV GIS at Kolhapur (PG) GIS S/s associated with "Network Expansion Scheme in Western Region to cater to pumped storage potential near Satara (up to 4500MW) - Part A" through TBCB route*

## **DESCRIPTION OF 800KV & 420kV GIS BAY MODULES & EQUIPMENTS**

- i. One (1) number 3-phase, SF6 insulated circuit breaker (#) with/without PIR complete with operating mechanism.
- ii. Three (3) numbers 1-phase, 3-core, multi ratio, current transformers (CTA) on one side of circuit breaker.
- iii. Three (3) numbers 1-phase, 3-core, multi ratio, current transformers (CTA) on other side of circuit breaker.
- iv. Two (2) numbers 3-phase, single pole, group operated isolator switches, complete with manual and motor driven operating mechanisms.
- v. Two (2) numbers 3-phase, single pole, group operated safety grounding switches, complete with manual and motor driven operating mechanisms.
- vi. Gas monitoring devices, barriers, pressure switches, UHF PD Sensors, support structures etc. as required.
- vii. Local Control Cubicle.

‘#’ As per BPS

**v) GIS ICT bay module (For 400kV side of 765/400kV ICT):**

**SF6 gas-insulated metal enclosed ICT bay module, each set comprising of the following:**

- i. One (1) number 3-phase, SF6 gas insulated circuit breaker without PIR, complete with operating mechanism.
- ii. Three (3) numbers 1-phase, 3-core, multi ratio, current transformers (CTA) on one side of circuit breaker.
- iii. Three (3) numbers 1-phase, 2-core, multi ratio, current transformers (CTB) on other side of circuit breaker.
- iv. Two (2) numbers 3-phase, single pole, group operated isolator switches complete with manual and motor driven operating mechanisms.
- v. Two (2) numbers 3-phase, single pole, group operated safety grounding switches complete with manual and motor driven operating mechanisms.
- vi. Three (3) numbers 1-phase, individual pole operated isolator switches, complete with manual and motor driven operating mechanisms.
- vii. Three (3) numbers 1-phase, individual pole operated safety grounding switches, complete with manual and motor driven operating mechanisms.
- viii. Three (3) numbers 1-phase, individual pole operated isolator switches, complete with manual and motor driven operating mechanisms for switching of Spare ICT through Auxiliary bus. The isolator must meet the operational requirement in terms of Phase-phase insulation withstand capability.

Technical Specification, Section – Project {Rev.01}

*765kV GIS New Substation Package SS 171T for a) Establishment of 765kV level at Kolhapur (PG) GIS S/s and b) Extn. of 400kV GIS at Kolhapur (PG) GIS S/s associated with "Network Expansion Scheme in Western Region to cater to pumped storage potential near Satara (up to 4500MW) - Part A" through TBCB route*

## **DESCRIPTION OF 800KV & 420kV GIS BAY MODULES & EQUIPMENTS**

- ix. Three (3) numbers single phase SF6, ducts inside the GIS hall (up to the outer edge of the wall of GIS Hall).
  - x. Gas monitoring devices, barriers, pressure switches, UHF PD sensors, support structures etc. as required.
  - xi. Local Control cubicle.
- vi) GIS Auxiliary Bus module for Spare ICT Connection (For 400kV side of 765/400kV ICT): Set of isolated phases, SF6 gas-insulated metal enclosed Auxiliary bus bars module for ICT bays, each set comprising of the following:**
- i. One (1) number 1-Phase, Auxiliary bus bar enclosure running across the length of the switch gear to inter-connect the spare unit of ICT with all ICT bay Modules through GIS Duct and provision of extension for future ICT.
  - ii. One (1) number 1-Phase, single pole operated safety grounding switch, complete with manual and motor driven operating mechanisms.
  - iii. One (1) number, single phase, SF6 ducts inside the GIS hall (up to the outer edge of the wall of GIS Hall)
  - iv. Gas monitoring devices, barriers, pressure switches, UHF PD sensors, support structures etc. as required.
  - v. End Piece (Interface) module with Isolating test link for Future extension **on both sides** of Auxiliary Bus bar module. The end piece module shall be designed in such a way so that future GIS module may be tested without extending voltage to existing bus by removing the test link.
- vii) GIS Switchable Line reactor bay module: SF6 gas insulated metal enclosed switchable Line reactor bay module, each set comprising of the following:**
- i. One (1) number 3-phase, SF6 gas insulated circuit breaker without PIR, complete with operating mechanism.
  - ii. One (1) number 3-phase, single pole, group operated isolator switches, complete with manual and motor driven operating mechanisms.
  - iii. One (1) number 3-phases, single pole, group operated safety grounding switches, complete with manual and motor driven operating mechanisms.
  - iv. Three (3) numbers single phase, SF6 ducts inside the GIS hall (up to the outer edge of the wall of GIS Hall).
  - v. Gas monitoring devices, barriers, pressure switches, UHF PD sensors, support structures etc., as required.
  - vi. Local Control cubicle.

*Technical Specification, Section – Project {Rev.01}*

*765kV GIS New Substation Package SS 171T for a) Establishment of 765kV level at Kolhapur (PG) GIS S/s and b) Extn. of 400kV GIS at Kolhapur (PG) GIS S/s associated with "Network Expansion Scheme in Western Region to cater to pumped storage potential near Satara (up to 4500MW) - Part A" through TBCB route*

## DESCRIPTION OF 800KV & 420kV GIS BAY MODULES & EQUIPMENTS

### **C. Gas Insulated Outdoor Bus Duct (GIB):**

#### i) 765kV GIB:

For making connections with outdoor overhead lines/Transformer/Reactor, Single Phase enclosed SF6 Gas Insulated Bus Duct (including support structure, gas monitoring device, gas barrier, pressure switch, UHF PD Sensor etc.) shall be provided. The GIB shall be measured in running meter as per actual at site and the same shall be paid as per unit rate quoted in Bid Price Schedule. This outdoor bus duct shall be measured from outer wall edge of GIS Building to centerline of SF6 to Air Bushing/SF6 to Oil Bushing (as applicable). SF6 gas duct inside GIS building are part of respective GIS Bay Module.

#### ii) 420kV GIB:

For making connections with outdoor overhead lines/Transformer/Reactor, Single Phase enclosed SF6 Gas Insulated Bus Duct (including support structure, gas monitoring device, gas barrier, pressure switch, UHF PD Sensor etc.) shall be provided. The GIB shall be measured in running meter as per actual at site and the same shall be paid as per unit rate quoted in Bid Price Schedule. This outdoor bus duct shall be measured from outer wall edge of GIS Building to centerline of SF6 to Air Bushing/SF6 to Oil Bushing (as applicable). SF6 gas duct inside GIS building are part of respective GIS Bay Module.

### **D. Gas Insulated SF6 to Air Termination:**

For making connections with overhead lines/Transformer/Reactor, SF6 to Air bushing including accessories shall be as specified below:

**For 765/420kV:** SF6 to air bushings along with terminal connectors & support structure etc. as required for outdoor connections to connect GIS with overhead line/Transformer/Reactor

\*\*\*

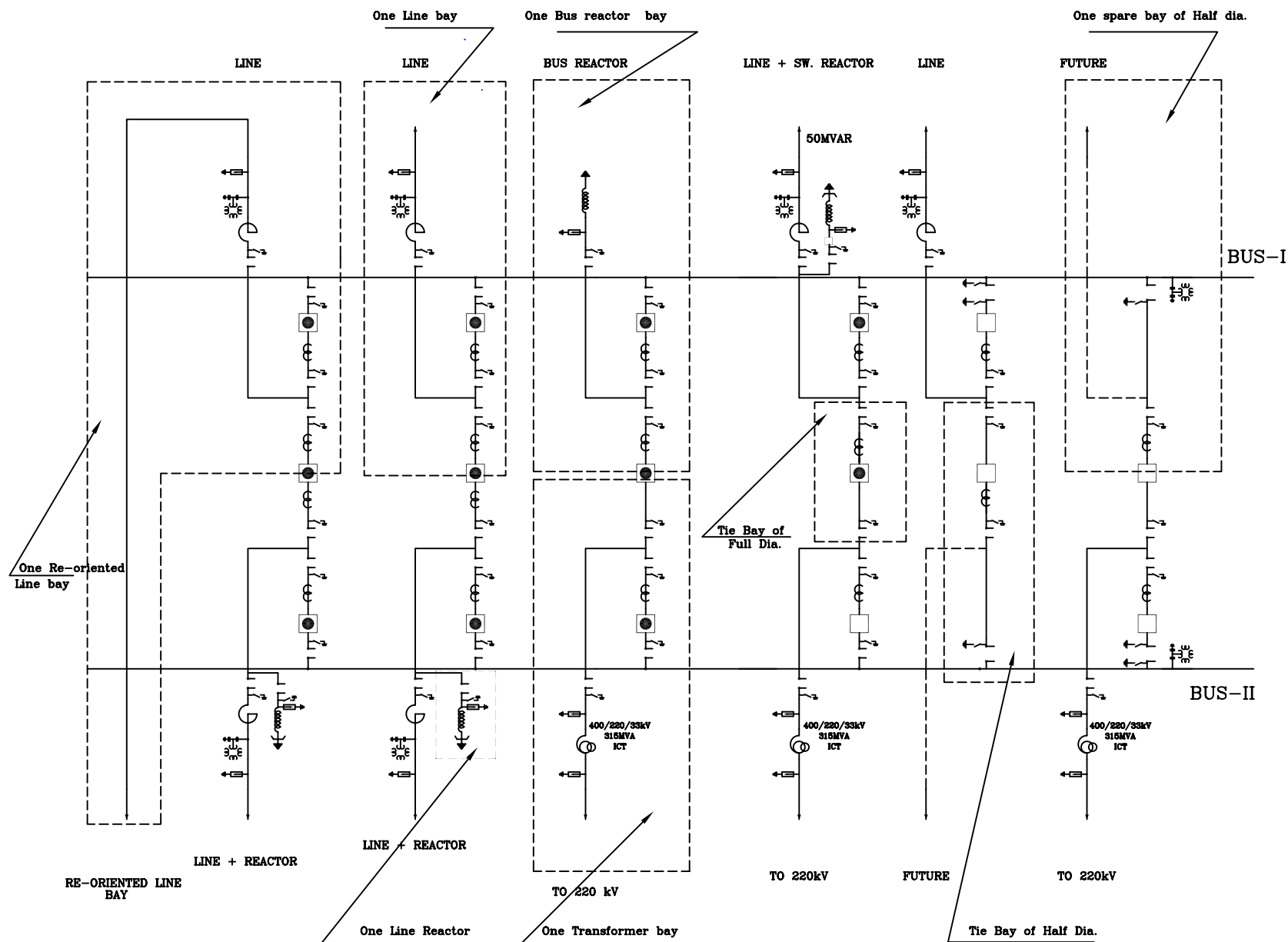

**765KV & 400kV (I-type layout)**

- Quantity to be filled against B.II of format as per above SLD
- B.II.1.1
- (i) Line Bay - 5 Sets
  - (ii) Transformer Bay - 3 Sets  
(3-ph. bank for 400 kV and 3 X 1-Ph. bank (with 1 no. spare unit) for 765 kV )
  - (iii) Bus Reactor Bay - 1 Set  
(3-ph. bank for 400 kV and 3 X 1-Ph. bank (with 1 no. spare unit) for 765 kV )
  - (iv) Spare Bay (Future) - 2 Sets
  - (v) Re-oriented Line bay - 1 Set
  - (vi) Line Reactors - 3 Sets
  - (vii) Bus Work (For Two diameters) - 3 Sets
  - (viii) Extension work for any feeder in existing half dia. - Nil

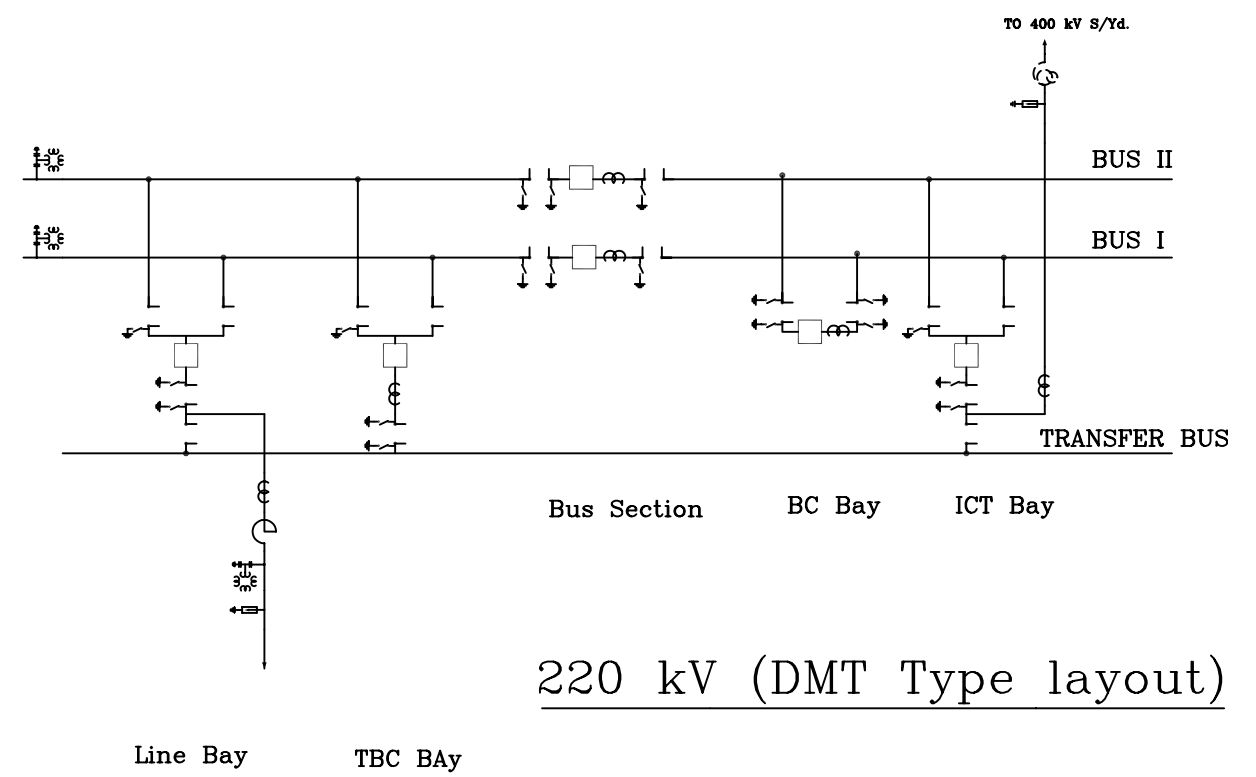

**220 kV (DMT Type layout)**

- Quantity to be filled against C.II of format as per above SLD
- C.II.1.0
- (i) Line Bay - 1 Set
  - (ii) Transformer Bay - 1 Set
  - (iii) TBC Bay - 1 Set
  - (iv) BC Bay - 1 Set
  - (v) Bus Work(For Three bays) - 2 Sets
  - (vi) Bus Section - 1 Set

**SECTION-1.5**  
**BILL OF QUANTITY**

ANNEXURE-BOQ

Sl. No.	ITEM DESCRIPTION	UNIT	QTY	REMARK
<b>A</b>	<b>Estab. of 765kV Kolhapur (PG) GIS Ss</b>			
<b>A.1</b>	<b>SUPPLY- GIS : 765kV, 50KA FOR 1S, GAS INSULATED SWITCHGEAR (GIS) AS PER TS</b>			
1.01	800kV, 3150 A, 50 kA, SF6 GIS ICT feederbay module as per Section-Project, Technical specification	SET	2	
1.02	800kV, 3150A, 50kA, SF6 GIS Bus Reactorfeeder bay module as perSection-Project, Technicalspecification	SET	2	
1.03	800kV, 3150A, 50kA, GIS Line feeder baymodule (with PIR) as perSection-Project, Technicalspecification	SET	4	
1.04	800 kV, 3150A, 50kA, SF6 GIS Tie baymodule(with PIR) as perSection-Project, Technicalspecification	SET	4	
1.05	800kV, 3150A, 50kA, SF6 GIS Auxiliarybus module for spare transformer as perSection-Project, Technicalspecification	SET	1	
1.06	800 KV, 3150A, 50KA, SF6 GIS AUXILIARY BUS MODULE FOR SPARE REACTOR ASPER SECTION-PROJECT, TECHNICAL SPECIFICATION	SET	1	
1.07	800kV, 3000/3150 A, 50kA, Single phase, SF6 Gas Insulated Bus Duct (GIB) outside GIS Hall along with associated support structure.	M	2800	
1.08	Controlled Switching Device for 765 kV, 3-ph Circuit Breaker	Nos.	10	
1.09	765KV, 3150A, 50KA FOR 1 SEC, SINGLE PHASE, SF6 TO AIR BUSHINGALONGWITH ASSOCIATED SUPPORT STRUCTURE	SET	32	
1.10	800kV, 3150A, 50kA, SF6 GIS SwitchableLine Reactor feeder bay module as perSection-Project, Technicalspecification	SET	2	
1.11	800KV, 5000A, 50KA, SF6 GIS BUS BAR MODULE as perSection-Project, Technicalspecification	SET	2	
<b>A.2</b>	<b>SUPPLY- GIS : 765KV, SPECIAL TOOLS AND TESTING &amp; MAINTENANCE EQUIPMENTS AS PER TS</b>			
2.01	SF6 Gas Filling and Evacuation Plant for 800kV GIS station	SET	1	
2.02	Portable Partial Discharge measurement test kitwith all necessary accessories,Industrial Grade Laptop and licensedsoftware as per Technicalspecification.	Nos.	1	
2.03	SF6 GAS ANALYZER	Nos.	1	
2.04	SF6 Gas Leakage Detector	Nos.	1	
2.05	SCISSOR LIFT	Nos.	1	
<b>A.3</b>	<b>SPARES- GIS : 765KV, 50KA FOR 1S, MANDATORY SPARES AS PER TS</b>			
3.01	765KV GIS-SF6 GAS PRESSURE RELIEF DEVICE ASSEMBLY OF EACH TYPE	SET	2	1 SET= 1 NUMBER OF EACH MAKE, TYPE AND RATING
3.02	SF6 PRESSURE GAUGE CUM SWITCH /DENSITY MONITORS AND PRESSURESWITCH AS APPLICABLE, OF EACH TYPE-765KV GIS	SET	3	
3.03	COUPLING DEVICE FOR PRESSURE GAUGE CUM SWITCH FOR CONNECTINGGAS HANDLING PLANT OF EACH TYPE-765KV GIS	SET	2	
3.04	RUBBER GASKETS, 'O' RINGS AND SEALS FOR SF6 GAS FOR GISENCLOSURE OF EACH TYPE-765KV GIS	SET	3	
3.05	765KV GIS-MOLECULAR FILTER FOR SF6 GAS WITH FILTER BAGS (5 % OF TOTALWEIGHT)	SET	1	
3.06	CONTROL VALVES FOR SF6 GAS OF EACH TYPE-765KV GIS	SET	3	
3.07	765KV GIS-SF6 GAS (5 % OF TOTAL GAS QUANTITY)	LOT	1	
3.08	LOCKING DEVICE TO KEEP THE DIS-CONNECTORS (ISOLATORS)AND EARTHING/FAST EARTHING SWITCHES IN CLOSE OR OPEN POSITION IN CASEOF REMOVAL OF THE DRIVING MECHANISM-765KV GIS	SET	3	
3.09	UHF PD SENSORS OF EACH TYPE ALONG WITH BNC CONNECTOR FOR 765KV GIS	SET	5	1 SET= 1 NUMBER OF EACH MAKE, TYPE AND RATING
3.10	765KV GIS-SUPPORT INSULATORS (GAS THROUGH) OF EACH TYPE (COMPLETE WITHMETAL RING ETC.) ALONG WITH ASSOCIATED CONTACTS AND SHIELDS	SET	5	1 SET= 1 NUMBER OF EACH MAKE, TYPE AND RATING
3.11	765KV GIS-GAS BARRIERS OF EACH TYPE (COMPLETE WITH METAL RING ETC.)ALONG WITH ASSOCIATED CONTACTS AND SHIELDS	SET	5	1 SET= 1 NUMBER OF EACH MAKE, TYPE AND RATING
3.12	765KV GIS- 3150A SF6 TO AIR BUSHING COMPLETE IN ALL RESPECT	SET	1	1 SET= 1 NUMBER OF EACH MAKE, TYPE AND RATING
3.13	LCC SPARES - AUX. RELAYS, CONTACTORS,PUSH BUTTONS, SWITCHES, LAMPS,ANNUNCIATION WINDOWS, MCB, FUSES,TIMERS, TERMINAL BLOCKS ETC. OF EACHTYPE & RATING-765KV GIS	SET	2	1 SET= 1 NUMBER OF EACH MAKE, TYPE AND RATING
3.14	765KV GIS-ONE POLE OF 3150A CIRCUIT BREAKER WITHOUT PIR WITHINTERRUPTER, MAIN CIRCUIT, ENCLOSURE AND OPERATING MECHANISM COMPLETEIN ALL RESPECT	SET	1	
3.15	765KV GIS-ONE POLE OF 3150A CIRCUIT BREAKER WITH PIR WITH INTERRUPTER,MAIN CIRCUIT, ENCLOSURE AND OPERATING MECHANISM COMPLETE IN ALLRESPECT	SET	1	
3.16	Trip coil assembly with resistor for765kV GIS Circuit Breaker (asapplicable)	SET	3	
3.17	Closing coil assembly with resistor for765 kV GIS Circuit Breaker (asapplicable)	SET	3	
3.18	RELAYS, POWER CONTACTORS, PUSH BUTTONS, TIMERS & MCBS ETC. (ASAPPLICABLE) OF EACH TYPE FOR 765KV GIS CIRCUIT BREAKER	SET	1	
3.19	Auxiliary switch assembly of each type for 765kV GIS Circuit Breaker	SET	3	

**SECTION-1.5**  
**BILL OF QUANTITY**

ANNEXURE-BOQ

Sl. No.	ITEM DESCRIPTION	UNIT	QTY	REMARK
3.20	765KV GIS CIRCUIT BREAKER-OPERATION COUNTER	SET	3	1 SET= 1 NUMBER OF EACH MAKE, TYPE AND RATING
3.21	765KV GIS CIRCUIT BREAKER-HYDRAULIC OPERATING MECHANISM WITH DRIVEMOTOR (FOR HYDRAULIC OPERATED MECHANISM, IF APPLICABLE)	SET	1	
3.22	HYDRAULIC FILTER OF EACH TYPE (FOR HYDRAULIC OPERATED MECHANISM, IFAPPLICABLE)-765KV GIS CIRCUIT BREKAER	SET	1	
3.23	765KV GIS CIRCUIT BREAKER- HOSE PIPE OF EACH TYPE (AS APPLICABLE) (FORHYDRAULIC OPERATED MECHANISM, IF APPLICABLE)	SET	1	
3.24	765KV GIS CIRCUIT BREAKER - N2 ACCUMULATOR (FOR HYDRAULIC OPERATEDMECHANISM, IF APPLICABLE)	SET	1	
3.25	VALVES OF EACH TYPE (FOR HYDRAULIC OPERATED MECHANISM, IFAPPLICABLE)-765KV GIS CIRCUIT BREKAER	SET	1	
3.26	PIPE LENGTH (COPPER & STEEL) OF EACH SIZE & TYPE (FOR HYDRAULICOPERATED MECHANISM, IF APPLICABLE)-765KV GIS CIRCUIT BREKAER	SET	1	
3.27	PRESSURE SWITCHES OF EACH TYPE (FOR HYDRAULIC OPERATED MECHANISM, IFAPPLICABLE)-765KV GIS CIRCUIT BREKAER	SET	1	
3.28	PRESSURE GAUGE WITH COUPLING DEVICE OF EACH TYPE (FOR HYDRAULICOPERATED MECHANISM, IF APPLICABLE)-765KV GIS CIRCUIT BREKAER	SET	1	
3.29	765KV GIS CIRCUIT BREAKER-HYDRAULIC OIL (5% OF TOTAL OIL QUANTITY)(FOR HYDRAULIC OPERATED MECHANISM, IF APPLICABLE)	SET	1	
3.30	PRESSURE RELIEF DEVICE OF EACH TYPE (FOR HYDRAULIC OPERATED MECHANISM,IF APPLICABLE)-765KV GIS CIRCUIT BREKAER	SET	1	
3.31	765KV GIS CIRCUIT BREAKER-COMPLETE SPRING OPERATING MECHANISMINCLUDING CHARGING MECHANISM ETC. (FOR SPRING OPERATED MECHANISM, IFAPPLICABLE)	SET	1	
3.32	765KV GIS CIRCUIT BREAKER- COMPLETE HYDRAULIC-SPRING OPERATINGMECHANISM INCLUDING CHARGING MECHANISM ETC. (FOR HYDRAULIC-SPRINGOPERATED MECHANISM, IF APPLICABLE)	SET	1	
3.33	PRESSURE SWITCHES OF EACH TYPE FOR 765KVGIS CIRCUIT BREAKER (ForHydraulic-Spring Operated Mechanism, ifapplicable)	SET	1	
3.34	PRESSURE GAUGE WITH COUPLING DEVICE OF EACH TYPE (FOR HYDRAULIC-SPRINGOPERATED MECHANISM, IF APPLICABLE)-765KV GIS CIRCUIT BREKAER	SET	1	
3.35	765KV GIS- Single phase of 3150Adisconnector switch including maincircuit, enclosure, driving mechanismand support insulator etc., complete inall respect	SET	4	1 SET= 1 NUMBER OF EACH MAKE, TYPE AND RATING (Note 1- The contractorshall supply spare for disconnectorswitch to ensure one to one replacementof all disconnector switch supplied asmain equipment without any requirementof modification in fittings at site tocover all different types ofdisconnector switch supplied. In case,quantity of supplied dis-connectorswitch types (for one to onereplacement) are more than the quantitymentioned in BPS for spare, thecontractor shall supply theseadditional types of disconnector switchwithout any additional priceimplication to POWERGRID and quantities of these additional type ofdisconnector switch are deem to beincluded in the quantities mentioned inBPS for spare disconnector. Note 2 - In case, Dis-connector Switch (DS) & EarthSwitch (ES) is provided in a sameenclosure with common operatingmechanism, then the module comprisingof Dis-connector & Earth switch insingle enclosure with common operatingmechanism is to be provided under thehead of spare Dis-connector only. Note3- In case, Dis-connector Switch (DS)&Earth Switch (ES) is provided in asame enclosure with separate operatingmechanism, then the module comprisingof Dis-connector & Earth switch insingle enclosure with separateoperating mechanism is to be providedunder the head of spare Dis-connectoronly.)
3.36	765KV GIS- SINGLE PHASE MAINTENANCE EARTHING SWITCH INCLUDING MAINCIRCUIT, ENCLOSURE, DRIVING MECHANISM AND SUPPORT INSULATOR ETC.,COMPLETE IN ALL RESPECT	SET	2	1 SET= 1 NUMBER OF EACH MAKE, TYPE AND RATING (NOTE 1 - IN CASE, DIS-CONNECTOR SWITCH (DS) &EARTH SWITCH (ES) IS PROVIDED IN A SAME ENCLOSURE WITH COMMONOPERATING MECHANISM, THEN THE MODULE COMPRISING OF DIS-CONNECTOR &EARTH SWITCH IN SINGLE ENCLOSURE WITH COMMON OPERATING MECHANISM IS TOBE PROVIDED UNDER THE HEAD OF SPARE DIS-CONNECTOR ONLY. NOTE 2 - INCASE, DIS-CONNECTOR SWITCH (DS) & EARTH SWITCH (ES) IS PROVIDED IN ASAME ENCLOSURE WITH SEPARATE OPERATING MECHANISM, THEN THE MODULECOMPRISING OF DIS-CONNECTOR & EARTH SWITCH IN SINGLE ENCLOSURE WITHSEPARATE OPERATING MECHANISM IS TO BE PROVIDED UNDER THE HEAD OF SPAREDIS-CONNECTOR ONLY.)

**SECTION-1.5**  
**BILL OF QUANTITY**

ANNEXURE-BOQ

Sl. No.	ITEM DESCRIPTION	UNIT	QTY	REMARK
3.37	765KV GIS - SINGLE PHASE FAST EARTHING SWITCH INCLUDING MAIN CIRCUIT, ENCLOSURE, DRIVING MECHANISM AND SUPPORT INSULATOR ETC., COMPLETE IN ALL RESPECT	SET	2	1 SET= 1 NUMBER OF EACH MAKE, TYPE AND RATING (NOTE 1 - IN CASE, DIS-CONNECTOR SWITCH (DS) & EARTH SWITCH (ES) IS PROVIDED IN A SAME ENCLOSURE WITH COMMON OPERATING MECHANISM, THEN THE MODULE COMPRISING OF DIS-CONNECTOR & EARTH SWITCH IN SINGLE ENCLOSURE WITH COMMON OPERATING MECHANISM IS TO BE PROVIDED UNDER THE HEAD OF SPARE DIS-CONNECTOR ONLY. NOTE 2 - IN CASE, DIS-CONNECTOR SWITCH (DS) & EARTH SWITCH (ES) IS PROVIDED IN A SAME ENCLOSURE WITH SEPARATE OPERATING MECHANISM, THEN THE MODULE COMPRISING OF DIS-CONNECTOR & EARTH SWITCH IN SINGLE ENCLOSURE WITH SEPARATE OPERATING MECHANISM IS TO BE PROVIDED UNDER THE HEAD OF SPARE DIS-CONNECTOR ONLY.)
3.38	OPEN/CLOSE CONTACTOR ASSEMBLY, TIMERS, KEY INTERLOCK, INTERLOCKING COILS, RELAYS, PUSH BUTTONS, INDICATING LAMPS, POWER CONTACTORS, RESISTORS, FUSES, MCBS & DRIVE CONTROL CARDS ETC. (AS APPLICABLE) ONE OF EACH TYPE FOR ONE COMPLETE MOM BOX FOR 765KV GIS DISCONNECTOR SWITCH	SET	1	
3.39	OPEN/CLOSE CONTACTOR ASSEMBLY, TIMERS, KEY INTERLOCK, INTERLOCKING COILS, RELAYS, PUSH BUTTONS, INDICATING LAMPS, POWER CONTACTORS, RESISTORS, FUSES, MCBS & DRIVE CONTROL CARDS ETC. (AS APPLICABLE) ONE OF EACH TYPE FOR ONE COMPLETE MOM BOX FOR 765KV GIS MAINTENANCE EARTH SWITCH	SET	1	
3.40	OPEN/CLOSE CONTACTOR ASSEMBLY, TIMERS, KEY INTERLOCK, INTERLOCKING COILS, RELAYS, PUSH BUTTONS, INDICATING LAMPS, POWER CONTACTORS, RESISTORS, FUSES, MCBS & DRIVE CONTROL CARDS ETC. (AS APPLICABLE) ONE OF EACH TYPE FOR ONE COMPLETE MOM BOX FOR 765KV GIS FAST EARTHING SWITCH	SET	1	
3.41	LIMIT SWITCHES AND AUX. SWITCHES FOR ONE COMPLETE MOM BOX FOR DISCONNECTOR-765KV GIS	SET	2	
3.42	LIMIT SWITCHES AND AUX. SWITCHES FOR ONE COMPLETE MOM BOX FOR MAINTENANCE EARTHING SWITCH-765KV GIS	SET	2	
3.43	LIMIT SWITCHES AND AUX. SWITCHES FOR ONE COMPLETE MOM BOX FOR FAST EARTHING SWITCH (IF APPLICABLE)-765KV GIS	SET	2	
3.44	DRIVE MECHANISM FOR 765KV GIS DISCONNECTOR SWITCH	SET	1	
3.45	DRIVE MECHANISM FOR 765KV GIS MAINTENANCE EARTH SWITCH	SET	1	
3.46	DRIVE MECHANISM FOR 765KV GIS FAST EARTHING SWITCH	SET	1	
3.47	MOTOR FOR DRIVE MECHANISM FOR 765KV GIS DISCONNECTOR SWITCH	SET	1	1 SET= 1 NUMBER OF EACH MAKE, TYPE AND RATING
3.48	MOTOR FOR DRIVE MECHANISM FOR 765KV GIS MAINTENANCE EARTH SWITCH	SET	1	1 SET= 1 NUMBER OF EACH MAKE, TYPE AND RATING
3.49	MOTOR FOR DRIVE MECHANISM FOR 765KV GIS FAST EARTHING SWITCH	SET	1	1 SET= 1 NUMBER OF EACH MAKE, TYPE AND RATING
3.50	765KV GIS- SINGLE PHASE OF CURRENT TRANSFORMER (3 CORES, TYPE-CTA) WITH ASSOCIATED ENCLOSURE AND PRIMARY CONDUCTOR COMPLETE IN ALL RESPECT	SET	1	1 SET= 1 NUMBER OF EACH MAKE, TYPE AND RATING
3.51	765KV GIS- SINGLE PHASE OF CURRENT TRANSFORMER (2 CORES, TYPE-CTB) WITH ASSOCIATED ENCLOSURE AND PRIMARY CONDUCTOR COMPLETE IN ALL RESPECT	SET	1	1 SET= 1 NUMBER OF EACH MAKE, TYPE AND RATING
3.52	765KV GIS- SINGLE PHASE VT WITH ASSOCIATED ENCLOSURE COMPLETE IN ALL RESPECT	SET	1	1 SET= 1 NUMBER OF EACH MAKE, TYPE AND RATING
3.53	Controlled Switching Device for 765 kV, 3-ph Circuit Breaker	SET	1	
<b>A.4</b>	<b>SERVICES- GIS : 765KV, 50KA FOR 1S, GAS INSULATED SWITCHGEAR (GIS) AS PER TS</b>			
4.01	SERVICES- GIS : 765KV, SUPERVISION OF ERECTION OF GIS	bays	14	Supervision of erection of GIS with main bus & auxiliary bus (if applicable), complete as per TS in all respect including LCC, its accessories and CSD (if applicable). It also includes verification of materials for proper storage at site for final storage. Earthing, SF6 Gas Filling works, Internal Cabling from GIS to LCC, interfacing of CSD (if applicable) with GIS/ CRP, including Structure Works are covered under this item. GIS Bus Duct & SF6 to Air Bushing (SAB) are not covered in this BOQ item.
4.02	SERVICES- GIS : 765KV, SUPERVISION OF ERECTION OF GAS INSULATED BUS DUCT	MTR	2800	Supervision of erection of GIB complete as per TS in all respect. GIB outside the GIS Hall wall shall be considered for mode of measurement. Earthing, SF6 Gas Filling works, Internal Cabling from GIS to LCC, including Structure Works are covered under this item. Inner side GIB / Aux Bus (if applicable) Module etc are to be considered as part of respective GIS Assembly and cost of the same shall be deemed inclusive.
4.03	SERVICES- GIS : 765KV, SUPERVISION OF ERECTION OF SF6 TO AIR BUSHING	SET	32	Earthing, SF6 Gas Filling works, Internal Cabling from GIS to LCC, including Structure Works are covered under this item.
4.04	SERVICES- GIS : 765KV, TESTING & COMMISSIONING OF GIS	bays	14	Testing and commissioning of complete GIS system including main bus, LCC and associated system is to be executed by bidder. All the special testing instruments, kits, T&P etc. are to be arranged by bidder on returnable basis. Please refer relevant section of technical specification for details.
4.05	SERVICES- GIS : 765KV, TESTING & COMMISSIONING OF GAS INSULATED BUS DUCT	MTR	2800	GIB outside the GIS Hall wall shall be considered for mode of measurement. Inner side GIB / Aux Bus (if applicable) Module e.t.c. are to be considered as part of respective GIS Assembly and cost of the same shall be deemed inclusive. All the special testing instruments, kits, T&P etc. are to be arranged by bidder on returnable basis. Please refer relevant section of technical specification for details.
4.06	SERVICES- GIS : 765KV, TESTING & COMMISSIONING OF SF6 TO AIR BUSHING	SET	32	

**SECTION-1.5**  
**BILL OF QUANTITY**

ANNEXURE-BOQ

Sl. No.	ITEM DESCRIPTION	UNIT	QTY	REMARK
4.07	SERVICES- ETC OF CONTROLLED SWITCHING DEVICE FOR 765 KV, 3-PH CIRCUIT BREAKER	SET	12	Installation and execution of Testing & commissioning complete as per TS in all respect. All the testing instruments, kits, T&P etc. are to be arranged by bidder on returnable basis. Please refer relevant section of technical specification for details.
4.08	SERVICES- GIS : 765KV, FINAL SUCCESSFUL HV/ POWER FREQUENCY TESTING OF GIS INCLUDING ARRANGING OF HV TEST KIT ALONG WITH OPERATOR	bays	14	Carrying out successful HV/ Power Frequency Testing of GIS as per IEC including Arrangement of HV Test kit with operator (on returnable basis) shall be in scope of bidder, which includes charges of HV test kit with operator, accessories & tools required for completion of HV testing. The quoted price shall include GIS bays including Main Bus, GIB & SAB and other common items as per TS complete in all respect. In this BOQ item, mobilization and demobilization for HV test kit is considered for once. In case of more, for reasons not attributable to bidder, same shall be paid extra as per BOQ Item.
4.09	SERVICES- GIS : INSULATION CO-ORDINATION STUDIES FOR GIS SYSTEM	LOT	1	1 Lot means Complete study report as per technical specification, Including VFTO report.
<b>A.5</b>	<b>SUPPLY- GIS : 765KV, 50KA FOR 1S, REFERENCE UNIT PRICE FOR ADDITION / DELETION OF SUPPLY ITEMS</b>			
	<i>(UNIT PRICES OF INDIVIDUAL EQUIPMENT INCLUDED HERE OR IN MANADATORY SPARES ARE REQUIRED FOR ANY ADDITION/DELETION OF EQUIPMENT AND REPLACEMENT OF DAMAGED ITEMS. VENDOR TO ENSURE THAT THE UNIT PRICES HAVE A LOGICAL RELATIONSHIP WITH PRICES OF ASSEMBLIES IN MAIN ITEMS. QUOTING FOR UNIT PRICES IS MANDATORY AND SHALL BE CONSIDERED FOR EVALUATION)</i>			
5.01	SUPPLY- GIS : 765KV, SINGLE PHASE BUS BAR	MTR	1	Complete in all respect.
5.02	SUPPLY- GIS : 765KV, GIS METALLIC ENCLOSURE	KG	50	
5.03	SUPPLY- GIS : 765KV, EXPANSION BELLOWS/ JOINTS	SET	1	For Single Phase of any type and any rating.
5.04	SUPPLY- GIS : 765KV, TEE BEND	SET	1	For Single Phase of any type and any rating.
5.05	SUPPLY- GIS : 765KV, ANGLE BEND	SET	1	For Single Phase of any type and any rating.
5.06	SUPPLY- GIS : 765KV, L-BEND	SET	1	For Single Phase of any type and any rating.
<b>A.6</b>	<b>SERVICES- GIS : 765KV, 50KA FOR 1S, REFERENCE UNIT PRICE FOR ADDITION / DELETION OF SERVICES</b>			
	<i>SERVICES- GIS : REFERENCE UNIT PRICE FOR ADDITION / DELETION OF SERVICES (UNIT PRICES OF INDIVIDUAL SERVICES INCLUDED HERE ARE REQUIRED FOR ANY ADDITION/DELETION OF EQUIPMENT AND REPLACEMENT OF DAMAGED ITEMS. VENDOR TO ENSURE THAT THE UNIT PRICES HAVE A LOGICAL RELATIONSHIP WITH PRICES OF ASSEMBLIES IN MAIN ITEMS. QUOTING FOR UNIT PRICES IS MANDATORY AND SHALL BE CONSIDERED FOR EVALUATION)</i>			
6.01	SERVICES- GIS : 765KV, REF. UNIT PRICE OF GIS INDIVIDUAL ITEM/ EQUIPMENT - SERVICES FOR SUPERVISION OF ERECTION OF GIS	MANDAY	10	Charges for repetition of services - (if required due to reasons not attributed to the contractor). This item will be executed only if repetition of services is required by BHEL.
6.02	SERVICES- GIS : 765KV, REF. UNIT PRICE OF GIS INDIVIDUAL ITEM/ EQUIPMENT - SERVICES FOR TESTING & COMMISSIONING OF GIS	MANDAY	10	Charges for repetition of services - (if required due to reasons not attributed to the contractor). This item will be executed only if repetition of services is required by BHEL.
	<b>DEMOBILIZATION AND REMOBILIZATION CHARGES</b>			
6.03	SERVICES- GIS : 765KV, DEMOBILIZATION AND REMOBILIZATION CHARGES FOR GIS ERECTION SUPERVISION TEAM	SET	1	THIS BOQ ITEM SHALL BE EXECUTED IF REQUIRED FOR REASONS NOT ATTRIBUTABLE TO BIDDER.
6.04	SERVICES- GIS : 765KV, DEMOBILIZATION AND REMOBILIZATION CHARGES FOR GIS TESTING & COMMISSIONING TEAM	SET	1	THIS BOQ ITEM SHALL BE EXECUTED IF REQUIRED FOR REASONS NOT ATTRIBUTABLE TO BIDDER.
6.05	SERVICES- GIS : 765KV, DEMOBILIZATION & REMOBILIZATION CHARGES OF HV TEST KIT ALONG WITH OPERATOR	LOT	1	Mobilization and demobilization charges for the HV test kit shall be applicable if it is required for a second time or more, due to reasons not attributable to the bidder.

**SECTION-1.5**  
**BILL OF QUANTITY**

ANNEXURE-BOQ

Sl. No.	ITEM DESCRIPTION	UNIT	QTY	REMARK
<b>B</b>	<b>Extn. of 400kV Kolhapur (PG) GIS Ss</b>			
<b>B.1</b>	<b>SUPPLY- GIS : 400kV, 63KA FOR 1S, GAS INSULATED SWITCHGEAR (GIS) AS PER TS</b>			
1.01	420kV, 3150 A, 63 kA, SF6 GIS AuxiliaryBus module for Spare Transformer as perSection-Project, Technicalspecification	SET	1	
1.02	420KV, 3150A, 63KA SF6 TO AIR BUSHING including support structure	SET	7	
1.03	Controlled Switching Device for 420 kV, 3-ph Circuit Breaker	Nos.	6	
1.04	420KV, 3150 A, 63 KA, SF6 GIS ICT FEEDER BAY MODULE FOR IV SIDECONNECTION WITH 765KV ICT AS PER SECTION-PROJECT, TECHNICALSPECIFICATION	SET	2	
1.05	420KV, 3000A, 63KA, SINGLE PHASE, SF6 GAS INSULATED BUS DUCT (GIB)OUTSIDE GIS HALL ALONGWITH ASSOCIATED SUPPORT STRUCTURE, ETC. AS PERTECHNICAL SPECIFICATION	M	650	
1.06	420 kV, 3150 A, 63 kA, SF6 GIS Linefeeder bay module(with PIR) as perSection-Project, Technicalspecification	SET	2	
1.07	420KV, 3150 A, 63 KA, SF6 GIS Tie baymodule(with PIR) as perSection-Project, Technicalspecification	SET	2	
1.08	420KV, 4000A, 63KA GIS BUSBAR MODULE EXTENSION	SET	2	
1.09	420KV,4000A, 63KA, 3-PHASE GIS EXTENSION PIECE (INTERFACE) MODULESUITABLE FOR EXTENDING EXISTING HITACHI MAKE GIS BUS BAR/DUCT AS PERTECHNICAL SPECIFICATION	SET	2	
1.10	420KV, 3150 A, 63 KA, SF6 GIS SWITCHABLE LINE REACTOR BAY MODULE ASPER SECTION-PROJECT, TECHNICAL SPECIFICATION	SET	2	
<b>B.2</b>	<b>SPARES- GIS : 400kV, 63KA FOR 1S, MANDATORY SPARES AS PER TS</b>			
2.01	400KV GIS-SF6 GAS PRESSURE RELIEF DEVICE ASSEMBLY OF EACH TYPE	SET	1	1 SET= 1 NUMBER OF EACH MAKE, TYPE AND RATING
2.02	SF6 PRESSURE GAUGE CUM SWITCH /DENSITY MONITORS AND PRESSURESWITCH AS APPLICABLE, OF EACH TYPE-400KV GIS	SET	2	
2.03	COUPLING DEVICE FOR PRESSURE GAUGE CUM SWITCH FOR CONNECTINGGAS HANDLING PLANT OF EACH TYPE-400KV GIS	SET	1	
2.04	RUBBER GASKETS, 'O' RINGS AND SEALS FOR SF6 GAS FOR GISENCLOSURE OF EACH TYPE-400KV GIS	SET	2	
2.05	400KV GIS-MOLECULAR FILTER FOR SF6 GAS WITH FILTER BAGS (5 % OF TOTALWEIGHT)	SET	1	
2.06	CONTROL VALVES FOR SF6 GAS OF EACH TYPE-400KV GIS	SET	2	
2.07	400KV GIS-SF6 GAS (5 % OF TOTAL GAS QUANTITY)	LOT	1	
2.08	LOCKING DEVICE TO KEEP THE DIS-CONNECTORS (ISOLATORS)AND EARTHING/FAST EARTHING SWITCHES IN CLOSE OR OPEN POSITION IN CASEOF REMOVAL OF THE DRIVING MECHANISM-400KV GIS	SET	2	
2.09	UHF PD SENSORS OF EACH TYPE ALONG WITH BNC CONNECTOR FOR 420KV GIS	SET	3	1 SET= 1 NUMBER OF EACH MAKE, TYPE AND RATING
2.10	400KV GIS-SUPPORT INSULATORS (GAS THROUGH) OF EACH TYPE (COMPLETE WITHMETAL RING ETC.) ALONG WITH ASSOCIATED CONTACTS AND SHIELDS	SET	3	1 SET= 1 NUMBER OF EACH MAKE, TYPE AND RATING
2.11	400KV GIS-GAS BARRIERS OF EACH TYPE (COMPLETE WITH METAL RING ETC.)ALONG WITH ASSOCIATED CONTACTS AND SHIELDS	SET	3	1 SET= 1 NUMBER OF EACH MAKE, TYPE AND RATING
2.12	400KV GIS- 3150A SF6 TO AIR BUSHING COMPLETE IN ALL RESPECT	SET	1	1 SET= 1 NUMBER OF EACH MAKE, TYPE AND RATING
2.13	LCC SPARES - AUX. RELAYS, CONTACTORS,PUSH BUTTONS, SWITCHES,LAMPS,ANNUNCIATION WINDOWS, MCB, FUSES,TIMERS, TERMINAL BLOCKS ETC. OF EACHTYPE & RATING-400kV GIS	SET	1	
2.14	400KV GIS-ONE POLE OF 3150A CIRCUIT BREAKER WITHOUT PIR WITHINTERRUPTER, MAIN CIRCUIT, ENCLOSURE AND OPERATING MECHANISM COMPLETEIN ALL RESPECT	SET	1	
2.15	400KV GIS-ONE POLE OF 3150A CIRCUIT BREAKER WITH PIR WITH INTERRUPTER,MAIN CIRCUIT, ENCLOSURE AND OPERATING MECHANISM COMPLETE IN ALLRESPECT	SET	1	
2.16	Trip coil assembly with resistor for420kV GIS Circuit Breaker (asapplicable)	SET	3	
2.17	Closing coil assembly with resistor for420kV GIS Circuit Breaker (asapplicable)	SET	3	
2.18	RELAYS, POWER CONTACTORS, PUSH BUTTONS, TIMERS & MCBS ETC. (ASAPPLICABLE) OF EACH TYPE FOR 400KV GIS CIRCUIT BREAKER	SET	1	
2.19	Auxiliary switch assembly of each type for 420kV GIS Circuit Breaker	SET	1	
2.20	400KV GIS CIRCUIT BREAKER-OPERATION COUNTER	SET	1	1 SET= 1 NUMBER OF EACH MAKE, TYPE AND RATING
2.21	400KV GIS CIRCUIT BREAKER-HYDRAULIC OPERATING MECHANISM WITH DRIVEMOTOR (FOR HYDRAULIC OPERATED MECHANISM, IF APPLICABLE)	SET	1	
2.22	HYDRAULIC FILTER OF EACH TYPE (FOR HYDRAULIC OPERATED MECHANISM, IFPLICABLE)-400KV GIS CIRCUIT BREKAER	SET	1	
2.23	400KV GIS CIRCUIT BREAKER- HOSE PIPE OF EACH TYPE (AS APPLICABLE) (FORHYDRAULIC OPERATED MECHANISM, IF APPLICABLE)	SET	1	
2.24	400KV GIS CIRCUIT BREAKER - N2 ACCUMULATOR (FOR HYDRAULIC OPERATEDMECHANISM, IF APPLICABLE)	SET	1	

**SECTION-1.5  
BILL OF QUANTITY**

**ANNEXURE-BOQ**

Sl. No.	ITEM DESCRIPTION	UNIT	QTY	REMARK
2.25	VALVES OF EACH TYPE (FOR HYDRAULIC OPERATED MECHANISM, IF APPLICABLE)-400KV GIS CIRCUIT BREKAER	SET	1	
2.26	PIPE LENGTH (COPPER & STEEL) OF EACH SIZE & TYPE (FOR HYDRAULIC OPERATED MECHANISM, IF APPLICABLE)-400KV GIS CIRCUIT BREKAER	SET	1	
2.27	PRESSURE SWITCHES OF EACH TYPE (FOR HYDRAULIC OPERATED MECHANISM, IF APPLICABLE)-400KV GIS CIRCUIT BREKAER	SET	1	
2.28	PRESSURE GAUGE WITH COUPLING DEVICE OF EACH TYPE (FOR HYDRAULIC OPERATED MECHANISM, IF APPLICABLE)-400KV GIS CIRCUIT BREKAER	SET	1	
2.29	400KV GIS CIRCUIT BREAKER-HYDRAULIC OIL (5% OF TOTAL OIL QUANTITY)(FOR HYDRAULIC OPERATED MECHANISM, IF APPLICABLE)	SET	1	
2.30	PRESSURE RELIEF DEVICE OF EACH TYPE (FOR HYDRAULIC OPERATED MECHANISM,IF APPLICABLE)-400KV GIS CIRCUIT BREKAER	SET	1	
2.31	400KV GIS CIRCUIT BREAKER-COMPLETE SPRING OPERATING MECHANISM INCLUDING CHARGING MECHANISM ETC. (FOR SPRING OPERATED MECHANISM, IF APPLICABLE)	SET	1	
2.32	400KV GIS CIRCUIT BREAKER- COMPLETE HYDRAULIC-SPRING OPERATING MECHANISM INCLUDING CHARGING MECHANISM ETC. (FOR HYDRAULIC-SPRING OPERATED MECHANISM, IF APPLICABLE)	SET	1	
2.33	PRESSURE SWITCHES OF EACH TYPE FOR 420KV GIS CIRCUIT BREAKER (For Hydraulic-Spring Operated Mechanism, if applicable)	SET	1	
2.34	PRESSURE GAUGE WITH COUPLING DEVICE OF EACH TYPE (FOR HYDRAULIC-SPRING OPERATED MECHANISM, IF APPLICABLE)-400KV GIS CIRCUIT BREKAER	SET	1	
2.35	400kV GIS- Single phase of 3150A disconnector switch including main circuit, enclosure, driving mechanism and support insulator etc., complete in all respect	SET	2	1 SET= 1 NUMBER OF EACH MAKE, TYPE AND RATING (Note 1- The contractor shall supply spare for disconnector switch to ensure one to one replacement of all disconnector switch supplied as main equipment without any requirement of modification in fittings at site to cover all different types of disconnector switch supplied. In case, quantity of supplied dis-connectors switch types (for one to one replacement) are more than the quantity mentioned in BPS for spare, the contractor shall supply these additional types of disconnector switch without any additional price implication to POWER GRID and quantities of these additional type of disconnector switch are deemed to be included in the quantities mentioned in BPS for spare disconnector. Note 2 - In case, Dis-connector Switch (DS) & Earth Switch (ES) is provided in a same enclosure with common operating mechanism, then the module comprising of Dis-connector & Earth switch in single enclosure with common operating mechanism is to be provided under the head of spare Dis-connector only. Note 3- In case, Dis-connector Switch (DS) & Earth Switch (ES) is provided in a same enclosure with separate operating mechanism, then the module comprising of Dis-connector & Earth switch in single enclosure with separate operating mechanism is to be provided under the head of spare Dis-connector only.)
2.36	400KV GIS- SINGLE PHASE MAINTENANCE EARTHING SWITCH INCLUDING MAIN CIRCUIT, ENCLOSURE, DRIVING MECHANISM AND SUPPORT INSULATOR ETC., COMPLETE IN ALL RESPECT	SET	1	1 SET= 1 NUMBER OF EACH MAKE, TYPE AND RATING (NOTE 1 - IN CASE, DIS-CONNECTOR SWITCH (DS) & EARTH SWITCH (ES) IS PROVIDED IN A SAME ENCLOSURE WITH COMMON OPERATING MECHANISM, THEN THE MODULE COMPRISING OF DIS-CONNECTOR & EARTH SWITCH IN SINGLE ENCLOSURE WITH COMMON OPERATING MECHANISM IS TO BE PROVIDED UNDER THE HEAD OF SPARE DIS-CONNECTOR ONLY. NOTE 2 - IN CASE, DIS-CONNECTOR SWITCH (DS) & EARTH SWITCH (ES) IS PROVIDED IN A SAME ENCLOSURE WITH SEPARATE OPERATING MECHANISM, THEN THE MODULE COMPRISING OF DIS-CONNECTOR & EARTH SWITCH IN SINGLE ENCLOSURE WITH SEPARATE OPERATING MECHANISM IS TO BE PROVIDED UNDER THE HEAD OF SPARE DIS-CONNECTOR ONLY.)
2.37	400KV GIS - SINGLE PHASE FAST EARTHING SWITCH INCLUDING MAIN CIRCUIT, ENCLOSURE, DRIVING MECHANISM AND SUPPORT INSULATOR ETC., COMPLETE IN ALL RESPECT	SET	1	1 SET= 1 NUMBER OF EACH MAKE, TYPE AND RATING (NOTE 1 - IN CASE, DIS-CONNECTOR SWITCH (DS) & EARTH SWITCH (ES) IS PROVIDED IN A SAME ENCLOSURE WITH COMMON OPERATING MECHANISM, THEN THE MODULE COMPRISING OF DIS-CONNECTOR & EARTH SWITCH IN SINGLE ENCLOSURE WITH COMMON OPERATING MECHANISM IS TO BE PROVIDED UNDER THE HEAD OF SPARE DIS-CONNECTOR ONLY. NOTE 2 - IN CASE, DIS-CONNECTOR SWITCH (DS) & EARTH SWITCH (ES) IS PROVIDED IN A SAME ENCLOSURE WITH SEPARATE OPERATING MECHANISM, THEN THE MODULE COMPRISING OF DIS-CONNECTOR & EARTH SWITCH IN SINGLE ENCLOSURE WITH SEPARATE OPERATING MECHANISM IS TO BE PROVIDED UNDER THE HEAD OF SPARE DIS-CONNECTOR ONLY.)
2.38	OPEN/CLOSE CONTACTOR ASSEMBLY, TIMERS, KEY INTERLOCK, INTERLOCKING COILS, RELAYS, PUSH BUTTONS, INDICATING LAMPS, POWER CONTACTORS, RESISTORS, FUSES, MCBS & DRIVE CONTROL CARDS ETC. (AS APPLICABLE) ONE OF EACH TYPE FOR ONE COMPLETE MOM BOX FOR 400KV GIS DISCONNECTOR SWITCH	SET	1	
2.39	OPEN/CLOSE CONTACTOR ASSEMBLY, TIMERS, KEY INTERLOCK, INTERLOCKING COILS, RELAYS, PUSH BUTTONS, INDICATING LAMPS, POWER CONTACTORS, RESISTORS, FUSES, MCBS & DRIVE CONTROL CARDS ETC. (AS APPLICABLE) ONE OF EACH TYPE FOR ONE COMPLETE MOM BOX FOR 400KV GIS MAINTENANCE EARTH SWITCH	SET	1	
2.40	OPEN/CLOSE CONTACTOR ASSEMBLY, TIMERS, KEY INTERLOCK, INTERLOCKING COILS, RELAYS, PUSH BUTTONS, INDICATING LAMPS, POWER CONTACTORS, RESISTORS, FUSES, MCBS & DRIVE CONTROL CARDS ETC. (AS APPLICABLE) ONE OF EACH TYPE FOR ONE COMPLETE MOM BOX FOR 400KV GIS FAST EARTHING SWITCH	SET	1	
2.41	LIMIT SWITCHES AND AUX. SWITCHES FOR ONE COMPLETE MOM BOX FOR DISCONNECTOR-400KV GIS	SET	1	
2.42	LIMIT SWITCHES AND AUX. SWITCHES FOR ONE COMPLETE MOM BOX FOR MAINTENANCE EARTHING SWITCH-400KV GIS	SET	1	
2.43	LIMIT SWITCHES AND AUX. SWITCHES FOR ONE COMPLETE MOM BOX FOR FAST EARTHING SWITCH (IF APPLICABLE)-400KV GIS	SET	1	

**SECTION-1.5**  
**BILL OF QUANTITY**

ANNEXURE-BOQ

Sl. No.	ITEM DESCRIPTION	UNIT	QTY	REMARK
2.44	DRIVE MECHANISM FOR 400KV GIS DISCONNECTOR SWITCH	SET	1	
2.45	DRIVE MECHANISM FOR 400KV GIS MAINTENANCE EARTH SWITCH	SET	1	
2.46	DRIVE MECHANISM FOR 400KV GIS FAST EARTHING SWITCH	SET	1	
2.47	MOTOR FOR DRIVE MECHANISM FOR 400KV GIS DISCONNECTOR SWITCH	SET	1	1 SET= 1 NUMBER OF EACH MAKE, TYPE AND RATING
2.48	MOTOR FOR DRIVE MECHANISM FOR 400KV GIS MAINTENANCE EARTH SWITCH	SET	1	1 SET= 1 NUMBER OF EACH MAKE, TYPE AND RATING
2.49	MOTOR FOR DRIVE MECHANISM FOR 400KV GIS FAST EARTHING SWITCH	SET	1	1 SET= 1 NUMBER OF EACH MAKE, TYPE AND RATING
2.50	400KV GIS- SINGLE PHASE OF CURRENT TRANSFORMER (3 CORES, TYPE-CTA)WITH ASSOCIATED ENCLOSURE AND PRIMARY CONDUCTOR COMPLETE IN ALLRESPECT	SET	1	1 SET= 1 NUMBER OF EACH MAKE, TYPE AND RATING
2.51	400KV GIS- SINGLE PHASE OF CURRENT TRANSFORMER (2 CORES, TYPE-CTB)WITH ASSOCIATED ENCLOSURE AND PRIMARY CONDUCTOR COMPLETE IN ALLRESPECT	SET	1	1 SET= 1 NUMBER OF EACH MAKE, TYPE AND RATING
2.52	Controlled Switching Device for 420 kV, 3-ph Circuit Breaker	SET	1	1 SET= 1 NUMBER OF EACH MAKE, TYPE AND RATING
<b>B.3</b>	<b>SERVICES- GIS : 400kV, 63KA FOR 1S, GAS INSULATED SWITCHGEAR (GIS) AS PER TS</b>			
3.01	SERVICES- GIS : 400kV, SUPERVISION OF ERECTION OF GIS	bays	8	Supervision of erection of GIS with main bus & auxiliary bus (if applicable), complete as per TS in all respect including LCC, its accessories and CSD (if applicable). It also includes verification of materials for proper storage at site for final storage. Earthing, SF6 Gas Filling works, Internal Cabling from GIS to LCC, interfacing of CSD (if applicable) with GIS/ CRP, including Structure Works are covered under this item. GIS Bus Duct & SF6 to Air Bushing (SAB) are not covered in this BOQ item.
3.02	SERVICES- GIS : 400kV, SUPERVISION OF ERECTION OF GAS INSULATED BUS DUCT	MTR	650	Supervision of erection of GIB complete as per TS in all respect. GIB outside the GIS Hall wall shall be considered for mode of measurement. Earthing, SF6 Gas Filling works, Internal Cabling from GIS to LCC, including Structure Works are covered under this
3.03	SERVICES- GIS : 400kV, SUPERVISION OF ERECTION OF SF6 TO AIR BUSHING	SET	7	Earthing, SF6 Gas Filling works, Internal Cabling from GIS to LCC, including Structure Works are covered under this item.
3.04	SERVICES- GIS : 400kV, TESTING & COMMISSIONING OF GIS	bays	8	Testing and commissioning of complete GIS system including main bus, LCC and associated system is to be executed by bidder. All the special testing instruments, kits, T&P etc. are to be arranged by bidder on returnable basis. Please refer relevant section of technical specification for details.
3.05	SERVICES- GIS : 400kV, TESTING & COMMISSIONING OF GAS INSULATED BUS DUCT	MTR	650	GIB outside the GIS Hall wall shall be considered for mode of measurement. Inner side GIB / Aux Bus (if applicable) Module e.t.c. are to be considered as part of respective GIS Assembly and cost of the same shall be deemed inclusive. All the special testing instruments, kits, T&P etc. are to be arranged by bidder on returnable basis. Please refer relevant section of technical specification for details.
3.06	SERVICES- GIS : 400kV, TESTING & COMMISSIONING OF SF6 TO AIR BUSHING	SET	7	
3.07	SERVICES- ETC OF CONTROLLED SWITCHING DEVICE FOR 420 KV, 3-PH CIRCUIT BREAKER	SET	6	Installation and execution of Testing & commissioning complete as per TS in all respect. All the testing instruments, kits, T&P etc. are to be arranged by bidder on returnable basis. Please refer relevant section of technical specification for details.
3.08	SERVICES- GIS : 400kV, FINAL SUCCESSFUL HV/ POWER FREQUENCY TESTING OF GIS INCLUDING ARRANGING OF HV TEST KIT ALONG WITH OPERATOR	bays	8	Carrying out successful HV/ Power Frequency Testing of GIS as per IEC including Arrangement of HV Test kit with operator (on returnable basis) shall be in scope of bidder, which includes charges of HV test kit with operator, accessories & tools required for completion of HV testing. The quoted price shall include GIS bays including Main Bus, GIB & SAB and other common items as per TS complete in all respect. In this BOQ item, mobilization and demobilization for HV test kit is considered for once. In case of more, for reasons not attributable to bidder, same shall be paid extra as per BOQ Item.
3.09	SERVICES- GIS : INSULATION CO-ORDINATION STUDIES FOR GIS SYSTEM	LOT	1	1 Lot means Complete study report as per technical specification, including VFTO report.

**SECTION-1.5**  
**BILL OF QUANTITY**

ANNEXURE-BOQ

Sl. No.	ITEM DESCRIPTION	UNIT	QTY	REMARK
<b>B.4</b>	<b>SUPPLY- GIS : 400kV, 63ka FOR 1S, REFERENCE UNIT PRICE FOR ADDITION / DELETION OF SUPPLY ITEMS</b>			
	<i>(Unit Prices of Individual Equipment included here or in mandatory spares are required for any Addition/Deletion of Equipment and replacement of damaged items. Vendor to ensure that the unit prices have a logical relationship with prices of assemblies in main items. Quoting for unit prices is mandatory and shall be considered for evaluation)</i>			
4.01	SUPPLY- GIS : 400kV, SINGLE PHASE BUS BAR	MTR	1	Complete in all respect.
4.02	SUPPLY- GIS : 400kV, GIS METALLIC ENCLOSURE	KG	50	
4.03	SUPPLY- GIS : 400kV, EXPANSION BELLOWS/ JOINTS	SET	1	For Single Phase of any type and any rating.
4.04	SUPPLY- GIS : 400kV, TEE BEND	SET	1	For Single Phase of any type and any rating.
4.05	SUPPLY- GIS : 400kV, ANGLE BEND	SET	1	For Single Phase of any type and any rating.
4.06	SUPPLY- GIS : 400kV, L-BEND	SET	1	For Single Phase of any type and any rating.
<b>B.5</b>	<b>SERVICES- GIS : 400kV, 63ka FOR 1S, REFERENCE UNIT PRICE FOR ADDITION / DELETION OF SERVICES</b>			
	<b>SERVICES- GIS : REFERENCE UNIT PRICE FOR ADDITION / DELETION OF SERVICES</b> <i>(Unit Prices of Individual services included here are required for any Addition/Deletion of Equipment and replacement of damaged items. Vendor to ensure that the unit prices have a logical relationship with prices of assemblies in main items. Quoting for unit prices is mandatory and shall be considered for evaluation)</i>			
5.01	SERVICES- GIS : 400kV, REF. UNIT PRICE OF GIS INDIVIDUAL ITEM/ EQUIPMENT - SERVICES FOR SUPERVISION OF ERECTION OF GIS	MANDAY	10	Charges for repetition of services - (if required due to reasons not attributed to the contractor). This item will be executed only if repetition of services is required by BHEL.
5.02	SERVICES- GIS : 400kV, REF. UNIT PRICE OF GIS INDIVIDUAL ITEM/ EQUIPMENT - SERVICES FOR TESTING & COMMISSIONING OF GIS	MANDAY	10	Charges for repetition of services - (if required due to reasons not attributed to the contractor). This item will be executed only if repetition of services is required by BHEL.
	<b>DEMOBILIZATION AND REMOBILIZATION CHARGES</b>			
5.03	SERVICES- GIS : 400kV, DEMOBILIZATION AND REMOBILIZATION CHARGES FOR GIS ERECTION SUPERVISION TEAM	SET	1	THIS BOQ ITEM SHALL BE EXECUTED IF REQUIRED FOR REASONS NOT ATTRIBUTABLE TO BIDDER.
5.04	SERVICES- GIS : 400kV, DEMOBILIZATION AND REMOBILIZATION CHARGES FOR GIS TESTING & COMMISSIONING TEAM	SET	1	THIS BOQ ITEM SHALL BE EXECUTED IF REQUIRED FOR REASONS NOT ATTRIBUTABLE TO BIDDER.
5.05	SERVICES- GIS : 400kV, DEMOBILIZATION & REMOBILIZATION CHARGES OF HV TEST KIT ALONG WITH OPERATOR	LOT	1	Mobilization and demobilization charges for the HV test kit shall be applicable if it is required for a second time or more, due to reasons not attributable to the bidder.

**SECTION-2 OF TECHNICAL SPECIFICATION**  
**Doc No. TB-PBTU-GIS-PGCIL-SS171T**  
**765kV and 400kV Gas Insulated Switchgear & its**  
**accessories**

**TECHNICAL SPECIFICATION**  
**SECTION-GAS INSULATED SWITCHGEAR**



**REMARKS: -**

**PLEASE READ TERMINOLOGY OF SECTION-2 OF TECHNICAL SPECIFICATION AS FOLLOWS:**

1. "GTR" as "Section-3 of technical specification".
2. "Powergrid" as "BHEL/Powergrid".
3. "Employer" as "Powergrid".
4. "Contractor" as "bidder".



**पावर ग्रिड कॉर्पोरेशन ऑफ इंडिया लिमिटेड**

*(भारत सरकार का उद्यम)*

**Power Grid Corporation of India Limited**

*(A Government of India Enterprises)*

**INDEX**

<b>S.No.</b>	<b>Description</b>	<b>Page No</b>
1.	GENERAL	1
2.	GENERAL CHARACTERISTICS	1
3.	REFERENCE STANDARDS	1
4.	DEFINITIONS	2
5.	GENERAL DESIGN AND SAFETY REQUIREMENT	3
6.	CIRCUIT BREAKERS	15
7.	DISCONNECTORS (ISOLATORS)	23
8.	SAFETY GROUNDING SWITCHES	25
9.	HIGH SPEED MAKE PROOF GROUNDING SWITCHES	26
10.	INSTRUMENT TRANSFORMERS	28
11.	SURGE ARRESTORS	31
12.	OUTDOOR SF6/Air BUSHINGS	34
13.	GIS TO CABLE TERMINATION (If applicable)	35
14.	TRANSFORMER / REACTOR TERMINATION	35
15.	LOCAL CONTROL CUBICLE (LCC)	36
16.	GIS BUILDING	39
17.	ELECTRIC OVERHEAD CRANE	40
18.	SEISMIC DESIGN CRITERIA	41
19.	DESIGN REVIEW	41
20.	TYPE TESTS	43
21.	MISCLLENOUS	44
22.	TRANSPORT OF EQUIPMENT TO SITE	44
23.	PACKING, STORAGE AND UNPACKING	45
24.	INSTALLATION OF GIS	46
25.	ON SITE TESTING	48
26.	MANDATORY SPARE	48
27.	TESTING & MAINTENACE EQUIPMENT	49

**Relevant Clauses undergoing Major Changes/Modifications, Proposed in Model Technical Specification for GIS Rev-5**

Clause No.	Description						
1	<p><b>1. GENERAL</b></p> <p>The GIS manufacturer shall design, manufacture, test, deliver and guarantee the GIS components and services as defined in this Technical Specification. The complete GIS based on the Single Line Diagram and as defined in Section Project, shall be provided for connection to Power Transformers/Reactors/Lines feeders with associated circuit breaker, disconnect switch and grounding switch (maintenance and high speed), instrument transformers, and surge arrester (if applicable) etc.</p>						
2.2	<p>All parts of the bus bar, switchgear and the bus ducts (for both indoor and outdoor applications) shall be as mentioned below:</p> <table border="1" data-bbox="373 678 1027 931"> <tr> <td data-bbox="373 678 592 775">765kV and 400 kV GIS</td> <td data-bbox="592 678 1027 775">Single phase enclosed</td> </tr> <tr> <td data-bbox="373 775 592 871">220kV GIS</td> <td data-bbox="592 775 1027 871">Single Phase/Three Phase enclosed</td> </tr> <tr> <td data-bbox="373 871 592 931">132 KV GIS</td> <td data-bbox="592 871 1027 931">Three Phase enclosed</td> </tr> </table>	765kV and 400 kV GIS	Single phase enclosed	220kV GIS	Single Phase/Three Phase enclosed	132 KV GIS	Three Phase enclosed
765kV and 400 kV GIS	Single phase enclosed						
220kV GIS	Single Phase/Three Phase enclosed						
132 KV GIS	Three Phase enclosed						
5.4	<p>All circuit breakers, disconnect switches and other component of GIS having identical rating shall have identical and interchangeable parts and operating mechanism as far as possible.</p>						
5.7	<p><b>5.7 Service continuity requirement:</b></p> <p>The GIS equipment with the given bus switching arrangement is divided into different gas compartments. During the work such as a fault repair or major maintenance, requiring the dismantling of a gas compartment for which more than one compartments may need to be de-gassed.</p> <p>Working conditions, method statements and procedures are to be furnished by the GIS manufacturer in order to ensure equipment and operating personnel’s safety and to achieve following Service continuity conditions to the extent possible:</p> <p>5.7.1 For One &amp; half breaker bus switching scheme during a fault in CB compartment, No bus bar and feeder is permitted out of service during maintenance and repair/replacement.</p> <p>5.7.2 For Double Main bus switching scheme during a fault in CB compartment, No bus bar permitted out of service during maintenance and repair/replacement.</p> <p>5.7.3 During a fault in GIS compartment other than CB compartment, maximum one bus bar and/or one feeder permitted out of service during maintenance and repair/replacement.</p>						
5.22	<p>The enclosure shall be of continuous design and shall meet the requirement as specified in of IEEE 80 2013 (special considerations for GIS).</p>						

**Relevant Clauses undergoing Major Changes/Modifications, Proposed in Model Technical Specification for GIS Rev-5**

5.27	For 400 kV and above voltage class GIS, wherever required, stairs, fixed ladder, platforms, and walkways for operation and maintenance access to the operating mechanism and monitoring devices should be provided to permit access. The structures shall be either aluminum or hot-dipped galvanized steel. All structures, stairs, platforms, and walkways shall conform to the relevant occupational health and safety regulations and designed in accordance with the latest industry standards and guidelines. The platforms and walkways shall have anti-skid surfaces that can be walked on. Handrails shall be provided where necessary. The GIS supplier shall provide 3-D arrangement drawing to show the location of equipment and access to it.
5.28	In addition to above suitable portable scissor lift shall be provided for access of distant portion of GIS installation.
5.29	New Gasket, sealant and desiccant shall be installed for permanent sealing of all site/field assembled joints. No gaskets are to be reused for any permanent seal broken or disturbed in the field/site.
5.31	The sealing provided between flanges of two modules / enclosures shall be such that long term tightness is achieved. <del>For outdoor portion of GIS a second sealing ring/Sealant or other suitable mean required to protect the gas seal from the external environment shall be provided.</del>
5.34	Temperature rise of all current carrying parts and enclosures shall be limited to the values stipulated in IEC-62271-1, under rated current and the climatic conditions as specified.
5.41	<p><b>UHF sensors for PD detection:</b></p> <p>Adequate number of UHF sensors shall be provided in the offered GIS for detection of Partial discharge (of 5 pC and above) as per IEC 60270. The number and location of these sensors shall be based on laboratory test on typical design of GIS as per recommendations of CIGRE Document No. 654 (<i>APPLICATION GUIDE FOR SENSITIVITY VERIFICATION for UHF PARTIAL DISCHARGE DETECTION SYSTEM FOR GIS</i>). Offered numbers and location of UHF sensors shall be submitted based on above said criteria along with attenuation calculation for approval of the employer. Further UHF sensors shall necessarily be provided in close proximity to VT compartments.</p> <p>However adequacy of number of sensors and their location shall be verified at site as per recommendations of above CIGRE Document No. 654. In case during site testing, additional UHF sensors are required, the same shall also be supplied &amp; installed to complete the technical requirement.</p> <p>The calibration and frequency response of PD couplers shall be as per NGC Technical Guidance note TGN (T) 121, issue 1, 1997. Data sheet shall be submitted for the UHF couplers meeting this requirement.</p>
5.42	<p><b>Gas Insulated Bus (GIB) layout :</b></p> <p>GIB shall be designed based on the following criteria</p> <p>(1) Maximum weight of gas in a gas tight section of GIB shall not exceed 400 Kg</p>

**Relevant Clauses undergoing Major Changes/Modifications, Proposed in Model Technical Specification for GIS Rev-5**

	<p>(for 765 kV &amp; 400 kV)/ 250 Kg (for 220 kV &amp; 132 kV).</p> <p>(2) GIB shall be generally in horizontal layer. However in exceptional circumstance GIB in vertical layers can be provided with the approval of employer.</p> <p>(3) The minimum vertical ground clearance of GIB at road crossing shall be 5.5 meters</p> <p>(4) The horizontal clearance between GIB and GIS building /any other building wall shall be preferably three (3) meters.</p> <p>(5) The GIB route inside the GIS Hall shall not obstruct easy access to GIS and control room buildings and shall not obstruct movement of crane, equipment including HV test equipment for maintenance works.</p> <p>(6) The GIB clear height outside the GIS hall in switchyard area shall be minimum 3.5 meter, so as not to obstruct easy access to GIB, movement of crane for maintenance work.</p> <p>(7) Optimization of outdoor GIB length using overhead AIS connection with Bus Post Insulator of respective voltage class is generally acceptable subject to meeting the electrical clearances as stipulated.</p> <p>(8) For the maintenance of GIB of one circuit, only that circuit shall be isolated. Adequate clearance between bus ducts of two circuit shall be ensured by the contractor during layout finalization.</p> <p>(9) GIS manufacturer as per their design shall preferably use maximum three standard straight horizontal outdoor bus duct lengths for entire GIS installation to optimize the spare requirement.</p>
<p>5.45</p>	<p><b>Documentation</b></p> <p>The contractor shall prepare and submit to the employer, drawings, details that show the GIS design in order for the employer to verify the equipment conform to the specifications. The Design Document to be submitted for review and approval are as follows:</p> <ol style="list-style-type: none"> <li>i. Design Review Document as per clause no. 20 of this specification</li> <li>ii. Single Line Diagram</li> <li>iii. Gas Schematic Diagram</li> <li>iv. GTP-Guaranteed Technical Particulars</li> <li>v. GIS layout (Plan and Section) including 3D drawing</li> <li>vi. GIS Component Drawings</li> <li>vii. Interface modules drawing for GIS extension</li> <li>viii. Rating and Name Plate Drawing</li> <li>ix. GIS/LCC Schematics Drawing</li> <li>x. Foundation loading plan and detail</li> <li>xi. GIS Support Structure Drawing</li> <li>xii. GIS platforms and Walkway Drawing</li> <li>xiii. GIS grounding plan and details along with design calculation for GIS</li> </ol>

**Relevant Clauses undergoing Major Changes/Modifications, Proposed in Model Technical Specification for GIS Rev-5**

	<p>grounding</p> <p>xiv. GIS key Diagram enlisting and marking each and every GIS Module clearly and separately identifiable (indoor and outdoor). This separately identified module shall be complete along with its enclosure, gasket and all active parts such as conductor, conductor joints, corona shield etc.</p> <p>xv. Method Statement along with sequential instruction for dismantling and assembling of all major components of GIS exhibiting service continuity requirement</p> <p>xvi. Type Test Reports</p> <p>xvii. Seismic Analysis Report</p> <p>xviii. Study report of VFTO generated for GIS installation for 400 kV and above.</p> <p>xix. The general arrangement drawing of interconnecting bus-duct from GIS bay module to XLPE cable termination end</p> <p>xx. The general arrangement drawing of Terminal connection arrangement to connect GIS duct to SF6/Oil bushing and duct mounting arrangement details</p> <p>xxi. Gas handling procedure</p> <p>xxii. The design &amp; construction proposal of the building along with necessary information, data, and drawings according to the complete requirements</p> <p>xxiii. Capacity calculation of EOT crane for GIS hall considering a factor of safety of 5</p> <p>xxiv. Method statement/ procedure of ON SITE high voltage testing with PD measurement and Switching Impulse test</p> <p>xxv. <b>Additional CB data to be furnished during detailed engineering :</b></p> <p style="padding-left: 20px;">a) Design data on capabilities of circuit breakers in terms of time and number of operations at duties ranging from 100 fault currents to load currents of the lowest possible value without requiring any maintenance or checks.</p> <p style="padding-left: 20px;">b) Curves supported by test data indicating the opening time under close open operation with combined variation of trip coil voltage and hydraulic pressure.</p> <p style="padding-left: 20px;">c) Contact Travel: Operating mechanism operating shaft travel and contact overlap of Circuit Breaker to be provided</p> <p>xxvi. PD Monitoring System</p> <p style="padding-left: 20px;">a) The technical proposal for PDM system along with detailed design documentation.</p> <p style="padding-left: 20px;">b) Data sheet for the UHF couplers.</p> <p style="padding-left: 20px;">c) The Sub-station GIS layout as a separate drawing indicating position of spacers, spread over of PD sensors with distance, sensor identification, the detector unit identification etc., total numbers of offered UHF Sensors along with attenuation calculation.</p> <p style="padding-left: 20px;">d) Guaranteed Technical Particulars &amp; Data Sheet for various components used in the PDM system.</p> <p style="padding-left: 20px;">e) Electromagnetic compatibility Test Reports.</p> <p style="padding-left: 20px;">f) List of critical spares.</p> <p>xxvii. Installation and Operation &amp; Maintenance Manual</p>
--	--

**Relevant Clauses undergoing Major Changes/Modifications, Proposed in Model Technical Specification for GIS Rev-5**

<p>13</p>	<p><b>13. GIS TO CABLE TERMINATION (If applicable)</b></p> <p>13.1. This scope covers the supply, erection, commissioning of connection assembly of fluid-filled or extruded cables to gas-insulated metal enclosed switchgear (GIS) as per IEC 62271-209</p> <p>13.2. The XLPE cables shall be connected to GIS by the interfacing of XLPE cable sealing end to GIS Cable termination enclosure.</p> <p>13.3. The GIS to XLPE cable termination shall conform to IEC-62271-209.</p> <p>13.4. The rating of XLPE cables for different voltages are specified in the Section project.</p> <p>13.5. The limits of supply of gas-insulated metal-enclosed switchgear and the cable termination shall be in accordance with IEC 62271-209.</p> <p>13.6. Cable termination and cable connection enclosure shall be suitable for the requirements for which it is designed. This interface section shall be designed in a manner which will allow ease of operation and maintenance.</p>
<p>14</p>	<p><b>14. TRANSFORMER / REACTOR TERMINATION</b></p> <p><b>14.1. TRANSFORMER / REACTOR Direct Connection with GIS (if applicable)</b></p> <p>14.1.1. The scope covers the supply, erection and commissioning of connection assembly of Oil filled Transformer to gas-insulated metal enclosed switchgear (GIS) as per IEC 62271-211.</p> <p>14.1.2. The limits of supply of gas-insulated metal-enclosed switchgear and the direct connection to oil filled transformer shall be in accordance with IEC 62271-211.</p> <p>14.1.3. The transformer / reactor termination module enables a direct transition from the SF6 gas insulation to the bushing of an oil-insulated transformer / reactor. For this purpose, the transformer/reactor bushing must be oil-tight, gas-tight and pressure resistant. Any temperature related movement and irregular setting of the switchgear's or transformer's/reactor's foundations are absorbed by the expansion fitting.</p> <p>14.1.4. Terminal connection arrangement to connect GIS duct to bushing and duct mounting arrangement details shall be submitted during detailed engineering for Employer's approval and for co-ordination with transformer and reactor supplier. Any modification suggested by transformer and reactor supplier shall have to be carried out by the GIS supplier to facilitate proper connection with the bushings of the transformer and reactors.</p> <p><b>14.2. TRANSFORMER / REACTOR Connection with SF6/Air Bushing</b></p> <p>14.2.1. The oil filled transformers and reactors are as shown in the substation SLD. The oil to air bushings of the transformers and reactors shall be supplied by the respective Transformer/Reactor supplier and the same shall be connected to the SF6 ducts thru air to SF6 bushings to be provided under present scope.</p> <p>14.3. In case of single phase Transformers/Reactors are being installed in the substation, HV&amp;IV auxiliary bus for the Transformer/Reactor bank for connecting spare unit shall be formed inside the GIS hall as per the SLD</p>

**Relevant Clauses undergoing Major Changes/Modifications, Proposed in Model Technical Specification for GIS Rev-5**

	<p>furnished and as specified in Section project.</p>
<p>15</p>	<p><b>15 LOCAL CONTROL CUBICLE (LCC)</b></p> <p><b>15.1 Functions</b></p> <p><b>15.1.6</b> Where plugs and sockets connect control cabling between the local control cubicle and the switchgear these shall not be interchanged. In plug in connector type cable arrangement, min 2 cores of the cable with connected condition on both side up to the TB to be left unused as spare.</p> <p><b>15.2 Constructional features</b></p> <p>15.2.3 For LCC panel of each feeder bay (i.e. line, transformer, and reactor etc.), separate AC/DC supply for power circuit of GIS switchgear shall be provided, fed directly from ACDB/DCDB. The control DC supply (for control, interlocking, signaling) shall be tapped from respective relay &amp; protection panel. For LCC panel illumination and heating purpose Loop in Loop out AC Supply can be provided.</p> <p>15.2.4 Each panel shall be provided with necessary arrangements for receiving, distributing and isolating of DC and AC supplies for various control, signaling, lighting and space heater circuits. The incoming and sub-circuits shall be separately provided with Fuses/MCBs. All fuses shall be HRC cartridge type conforming to IS: 13703 mounted on plug-in type fuse bases. The short time fuse rating of Fuses shall be not less than 9 KA. Fuse carrier base shall have imprints of the fuse 'rating' and 'voltage'.</p> <p><b>15.3 Cabling between LCC Panel and GIS equipment</b></p> <p>15.3.1 The unarmored screen cable shall be of 1.1kV grade, multi core, annealed copper conductor, Tinned copper braided screen (approx. 85% coverage).</p> <p>15.3.2 The core insulation and outer sheath of cable shall be of halogen-free special polymer.</p> <p>15.3.3 The cable shall be flame-retardant, flexible, abrasion-and wear-resistant</p> <p>15.3.4 The size of core shall not be less than 2.5 sq. mm for instrument transformers and 1.5 sq. mm for other control cable.</p> <p>15.3.5 Prefabricated cables with heavy duty multi-point plug-in connections on GIS end shall be provided.</p> <p>15.3.6 All instrument transformer connections shall be hard wired to terminal block via ring type connection.</p>
<p>16.</p>	<p><b>16 GIS BUILDING</b></p> <p>16.3 For finalizing the dimensions of GIS building the requirement of Turning radius to rotate the largest removable component for assembly/disassembly shall be taken in to consideration.</p>
<p>17</p>	<p><b>17 ELECTRIC OVERHEAD CRANE :</b></p>

**Relevant Clauses undergoing Major Changes/Modifications, Proposed in Model Technical Specification for GIS Rev-5**

	<p>17.1 Two EOT Cranes for 765 kV GIS hall and One EOT cranes for 400 kV GIS hall of suitable capacity shall be provided for erection &amp; maintenance of largest/heaviest GIS component/assembly. The crane shall consist of all special requirements for erection &amp; maintenance of GIS equipment.</p> <p>17.6 Crane shall be designed for operation under following variable speeds through VVVF drives at full load :</p> <p>Hoisting: 0.3 – 3 Meters per Minute</p> <p>Cross Travel: 1.6 – 16 Meters per Minute</p> <p>Long Travel: 2.0 – 20 Meters per Minute</p>
<p>19</p>	<p><b>19. DESIGN REVIEW</b></p> <p>19.7 Further, the manufacturer shall furnish the following information during detailed engineering:</p> <ul style="list-style-type: none"> <li>a) Study report of VFTO generated for GIS installation for 400 kV and above.</li> <li>b) Calculation for adequacy of UHF sensors to be provided in GIS Installation as per clause no 5.41.</li> <li>c) The calculations and documents in support of the average intensity of electromagnetic field on the surface of the enclosure.</li> <li>d) Calculations to show that there is no Ferro resonance due to capacitance of GIS for the voltage transformers.</li> <li>e) Calculations in support of touch &amp; step voltages in all enclosures and earthing of complete GIS installation.</li> <li>f) Measures to mitigate transient enclosure voltage by high frequency currents.</li> <li>g) The acceptance criteria and limits of impact (of impact recorder) in all three directions which can be withstood by the equipment during transportation and handling.</li> </ul>
<p>23.</p>	<p><b>23.6</b> Blanking plates, caps, seals, etc., necessary for sealing the gas sections during shipment to site which may on later stage necessarily be used during repair and maintenance shall remain the property of POWERGRID. Balance blanking plates, caps, seals, etc shall be returnable to the contractor. If considered necessary, blanking plates or other sealing devices shall be provided with facilities for measuring the gas pressure and recharging at any time during the transport period. Any seals, gaskets, 'O' rings, etc. that may be used as part of the arrangement for sealing off gas sections for shipment of site, shall not be used in the final installation of the equipment at site. Identification numbers shall be stamped into the blanking plates, etc., and on the switchgear equipment to which they are fitted so that they can easily be identified and refitted should it ever be necessary to ship sections of the switchgear back to the manufacturer's works for repair.</p> <p><b>23.7</b> The contractor shall ensure that during the period between arrival at site and erection, all materials and parts of the contract works are suitably stored in such approved manner as to prevent damage by weather, corrosion, insects, vermin or fungal growth. The scope of providing the necessary protection, storing on raised platform, as required etc. is included in the works to be performed by the contractor. Cost of the raised platform for temporary storage is deemed to be included in overall cost. The raised platform needs to be made ready before arrival of GIS equipment at site. The contractor may use the available storage</p>

**Relevant Clauses undergoing Major Changes/Modifications, Proposed in Model Technical Specification for GIS Rev-5**

	<p>areas at site with permission of site in charge.</p> <p><b>23.11</b> For the purpose of release of payment linked to receipt and physical verification in case of GIS equipment it shall mean random opening and physical verification of one number of packing unit of each type of main equipment (i.e. GIS CB/ISO/ES/PT/LA etc.) for each voltage level. Thereafter proper re-packing of the GIS unit shall be ensured as per manufacturer recommendation.</p>
<p><b>24</b></p>	<p><b>24 INSTALLATION OF GIS</b></p> <p>24.1 Civil works of GIS Hall shall be completed in all respects before taking up the installation and it shall be ensured that Ventilation System is operational and all dust and dirt in the hall are removed. <b>The GIS hall needs to be in positive pressure before starting Installation.</b></p> <p>24.3 Un-packaging of GIS modules shall be done outside the GIS hall and in no case module to be taken inside GIS hall with packing.</p> <p>24.7 GIS hall door shall have automatic close facility after entry of personnel to avoid dust and moisture entry. Walls and ceiling shall be in a condition so that neither dirt nor plaster might fall or rub off and formation of condensation water in ceiling shall be prevented under any circumstances.</p> <p>24.12 Maintenance room (as a part of LCR room) shall be constructed for carrying out repair works/ small part assembly All excess material (not required for immediate installation works) test equipment and tools and tackles to be stored separately from GIS hall in this room for rework.</p> <p>24.13 Erection agency shall submit method statement and make available formats for checking during each stage of hall preparation, assembly process and final checks to be approved by POWERGRID site before start of erection. Shock recorder down loaded data and analysis shall be submitted preferably before commencement of erection work. <b>In case of violation of shock limits, expert form manufacturer shall visit and do the joint internal inspection and shall submit analysis report before giving clearance for erection. If required the module shall be taken back to factory for further analysis and testing.</b></p>
<p><b>25</b></p>	<p><b>25. ON SITE TESTING</b></p> <p>After the GIS Switchgear has been fully installed at site and SF6 gas filled at rated filling density, the complete assembly shall be subjected to the site tests as per IEC-62271-203 and POWERGRID Asset Management Controlled Document No: D-3-01-09-01-01. After the above, Special Dielectric test (Switching Impulse test) shall be conducted for 765 kV GIS with the test voltages specified below:-</p> <p><b>25.1.</b> Application of Power Frequency voltage test for duration of 1 minute with the value 760 kV (r.m.s.) as per IEC 62271-203.</p> <p><b>25.2.</b> Directly after the above test at 25.1 Switching impulse test with three impulses of each polarity and with the value 1240 kVp(80 % of the rated switching Impulse withstand level) as per IEC 62271-203.</p> <p><b>25.3.</b> In case of a disruptive discharge in the gas as outlined in clause no: C.6.2.2</p>

**Relevant Clauses undergoing Major Changes/Modifications, Proposed in Model Technical Specification for GIS Rev-5**

	<p>Procedure b), Annexure-C of IEC 62271-203 during the AC voltage test and a repeat test is performed due to this failure, then the repeat test shall be carried out at Specified voltage.</p> <p><b>25.4.</b> In case of a disruptive discharge in the gas as outlined in clause no: C.6.2.2 Procedure b) Annexure-C of IEC 62271-203 during Oscillating Switching Impulse Test and a repeat test is performed due to this failure then the repeat test shall be carried out at a value equal to 90 % of the rated switching Impulse withstand level.</p> <p><b>25.5.</b> Method statement/ procedure of ON SITE high voltage testing, PD measurement and Switching Impulse test shall be submitted by contractor in advance.</p>						
<p><b>26</b></p>	<p><b>MANDATORY SPARE</b></p> <p>Design, engineering, manufacture, testing, supply on FOR destination site basis including transportation &amp; insurance, storage at site of Mandatory spares for the GIS(As specified in BPS). Standard list of Mandatory Spares is as per <b>Annexure-10</b></p>						
<p><b>27</b></p>	<p><b>27.2 Gas filling and evacuating plant : (Gas Processing unit)</b></p> <p>The minimum capacity parameters of evacuation plant will be as under :</p> <table border="0"> <tr> <td>Oil Free Suction (Recovery) Pump:</td> <td>30 M<sup>3</sup>/Hour</td> </tr> <tr> <td>Compressor (Two Stage):</td> <td>15 M<sup>3</sup>/Hour</td> </tr> <tr> <td>Oil Free Vacuum Pump:</td> <td>100 M<sup>3</sup>/Hour</td> </tr> </table>	Oil Free Suction (Recovery) Pump:	30 M <sup>3</sup> /Hour	Compressor (Two Stage):	15 M <sup>3</sup> /Hour	Oil Free Vacuum Pump:	100 M <sup>3</sup> /Hour
Oil Free Suction (Recovery) Pump:	30 M <sup>3</sup> /Hour						
Compressor (Two Stage):	15 M <sup>3</sup> /Hour						
Oil Free Vacuum Pump:	100 M <sup>3</sup> /Hour						
<p><b>27</b></p>	<p><b>27.5 Online Partial Discharge Monitoring System (Applicable for 765kV &amp; 400 kV GIS)</b></p> <p>The scope shall cover Engineering, supply, installation, testing and commissioning of partial discharge continuous monitoring system, with all necessary auxiliaries and accessories to make a complete system as per technical specification, including site demonstration of successful operation. Any items/accessories necessary to make the system fully functional for the trouble free online PD monitoring of complete GIS installation shall be considered as included in the scope.</p> <p>The PDM system shall be provided with all its hardware and software, with readily interfacing to the UHF PD couplers installed in the GIS of present bays and future bays as shown in SLD plus 20% additional as extra. Details of this shall be submitted during engineering stage for approval.</p> <p>The integration of UHF PD coupler in future GIS bays shall be done in respective package. The number of UHF PD coupler for future bays shall be decided based on GIS layout finalized under present scope (considering present GIS equipment with future provision).</p>						

**1. GENERAL**

The GIS manufacturer shall design, manufacture, test, deliver and guarantee the GIS components and services as defined in this Technical Specification. The complete GIS based on the Single Line Diagram and as defined in Section Project, shall be provided for connection to Power Transformers/Reactors/Lines feeders with associated circuit breaker, disconnect switch and grounding switch (maintenance and high speed), instrument transformers, and surge arrester (if applicable) etc.

**2. GENERAL CHARACTERISTICS**

- 2.1. The SF6 gas insulated metal enclosed switchgear shall be totally safe against inadvertent touch of any of its constituent parts. It should be designed for indoor application with meteorological conditions as specified.
- 2.2. All parts of the bus bar, switchgear and the bus ducts (for both indoor and outdoor applications) shall be as mentioned below:

765kV and 400 kV GIS	Single phase enclosed
220kV GIS	Single Phase/Three Phase enclosed
132 KV GIS	Three Phase enclosed

- 2.3. The design should be such that all parts subjected to wear and tear are easily accessible for maintenance purposes. The equipment offered shall be protected against all types of voltage surges and any equipment necessary to satisfy this requirement shall deemed to be included.

**3. REFERENCE STANDARDS**

The GIS offered shall confirm to IEC 62271-203 and other relevant IEC standard except to the extent explicitly modified in the specification and shall be in accordance with requirement specified in GTR.

The metal-enclosed gas-insulated switchgear, including the operating devices, accessories and auxiliary equipment forming integral part thereof, shall be designed, manufactured, assembled and tested in accordance with the following International Electro-technical Commission (IEC) Publications including their parts and supplements as amended or revised as on date of bid opening:

- IEC 62271-203** Gas Insulated metal-enclosed switchgear for rated voltages above 52 KV
- IEC 62271-207** Seismic qualification for gas-insulated switchgear assemblies for rated

	voltages above 52 kV
<b>IEC 60376</b>	New sulphur hexafluoride
<b>IEC 62271- 100</b>	High voltage alternating current Circuit breakers
<b>IEC 62271-1</b>	Common clauses for high voltage Switchgear and control-gear Standards
<b>IEC 62271-102</b>	Alternating current Disconnect Switch(isolators) and earthing switches
<b>IEC 61869</b>	General Requirements Instrument Transformers
<b>IEC 60137</b>	Bushings for alternating voltages above 1000 V
<b>IEC 62271-209</b>	Cable connections for gas-insulated switchgear
<b>IEC 60480</b>	Guide to checking of sulphur hexafluoride taken from electrical equipment
<b>IEC 60099 -1/4</b>	Non-linear resistor type arresters for AC systems
<b>IEC 60439</b>	Factory-built assemblies of low-voltage switchgear and control Gear.
<b>IEEE 80 2013</b>	IEEE Guide for Safety in AC Substation grounding.
<b>CIGRE-44</b>	Earthing of GIS- an application guide. (Electra no.151,Dec'93).
<b>IEC 62271-211</b>	Direct connection between Power Transformers and gas insulated metal enclosed switchgear for rated voltage 72.5 kV and above.

The components and devices which are not covered by the above standards shall conform to, and comply with, the applicable standards, rules, codes and regulations of the internationally recognized standardizing bodies and professional societies as may be approved by the Employer and the manufacturer shall list all such applicable standards, codes etc.

In case the requirements laid down herein differ from those given in above standard in any aspect the switchgear shall comply with the requirements indicated herein in regard thereto.

#### **4. DEFINITIONS**

- 4.1. **Assembly:** Assembly refers to the entire completed GIS equipment furnished under contract.
- 4.2. **Bay:** Bay refers to the area occupied by one Circuit Breaker and associated equipment.
- 4.3. **Compartment:** When used in conjunction with GIS equipment, compartment refers to a gas tight volume bounded by enclosure walls and gas tight isolating barriers.
- 4.4. **Enclosure:** When used in conjunction with GIS equipment, enclosure refers to the grounded metal housing or shell which contains and protects internal Power system equipment (breaker, disconnecting switch, grounding switch, voltage transformer, current transformer, surge arresters, interconnecting bus etc.)
- 4.5. **Manual Operation:** Manual operation means operation by hand without using any other source of power.

- 4.6. **Module:** When used in conjunction with GIS equipment, module refers to a portion of that equipment. Each module includes its own enclosure. A module can contain more than one piece of equipment, for example, a module can contain a disconnecting switch and a grounding switch.
- 4.7. **Reservoir:** When used in conjunction with GIS equipment reservoir refers to a larger gas-tight volume.

## 5. GENERAL DESIGN AND SAFETY REQUIREMENT

- 5.1. The GIS shall be designed, manufactured and tested in accordance with the best international engineering practices under strict quality control to meet the requirement stipulated in the technical specification. Adequate safety margin with respect to thermal, mechanical, dielectric stress and insulation coordination etc. shall be maintained during design, selection of raw material, manufacturing process etc. so that the GIS provides long life with least maintenance.

The workmanship shall be of the highest quality and shall conform to the latest modern practices for the manufacture of high technology machinery and electrical switchgear.

- 5.2. The GIS assembly shall consist of separate modular compartments e.g. Circuit Breaker compartment, Bus bar compartment filled with SF6 Gas and separated by gas tight partitions so as to minimize risk to human life, allow ease of maintenance and limit the effects of gas leaks failures & internal arcs etc. These compartments shall be such that maintenance on one feeder may be performed without de-energising the adjacent feeders. These compartments shall be designed to minimize the risk of damage to adjacent sections and protection of personnel in the event of a failure occurring within the compartments. Rupture diaphragms with suitable deflectors shall be provided to prevent uncontrolled bursting pressures developing within the enclosures under worst operating conditions, thus providing controlled pressure relief in the affected compartment.
- 5.3. The switchgear, which shall be of modular design, shall have complete phase isolation. The conductors and the live parts shall be mounted on high graded epoxy resin insulators. These insulators shall be designed to have high structural strength and electrical dielectric properties and shall be free of any voids and free of partial discharge at a voltage which is at least 5% greater than the rated voltage. These shall be designed to have high structural and dielectric strength properties and shall be shaped so as to provide uniform field distribution and to minimize the effects of particle deposition either from migration of foreign particles within the enclosures or from the by-products of SF6 breakdown under arcing conditions.
- 5.4. All circuit breakers, disconnect switches and other component of GIS having identical rating shall have identical and interchangeable parts and operating mechanism as far as possible.
- 5.5. Gas barrier insulators shall be provided so as to divide the GIS into separate compartments. These shall be suitably located in order to minimize disturbance in case of leakage or dismantling. They shall be designed to withstand any internal fault thereby keeping an internal arc inside the faulty compartment. Further, it is prohibited to work adjacent to a gas

compartment while it is fully pressurized on the other side. For such cases, the gas pressure in the adjacent compartments needs to be reduced.

5.6. The switchgear shall be of the free standing, self-supporting with easy accessibility to all the parts during installation & maintenance with all high-voltage equipment installed inside gas-insulated metallic and earthed enclosures. GIS should be suitably sub-divided into individual arc and gas-proof compartments preferably for:

- 1) Bus bars
- 2) Intermediate compartment
- 3) Circuit breakers
- 4) Feeder Disconnect Switch
- 5) Voltage Transformers
- 6) Gas Insulated bus duct section between GIS and XLPE cable/Overhead Conductor.
- 7) Gas Insulated bus section between GIS & Oil filled Transformer/ Reactor (if applicable)

Typical drawings indicating gas tight compartments are enclosed at **Annexure-A**. This is an indicative drawing only, however GIS manufacturer shall ensure the service continuity requirement as mentioned above.

5.7. **Service continuity requirement:**

The GIS equipment with the given bus switching arrangement is divided into different gas compartments. During the work such as a fault repair or major maintenance, requiring the dismantling of a gas compartment for which more than one compartments may need to be de-gassed.

Working conditions, method statements and procedures are to be furnished by the GIS manufacturer in order to ensure equipment and operating personnel's safety and to achieve following Service continuity conditions to the extent possible:

5.7.1. For One & half breaker bus switching scheme during a fault in CB compartment, No bus bar and feeder is permitted out of service during maintenance and repair/replacement.

5.7.2. For Double Main bus switching scheme during a fault in CB compartment, No bus bar permitted out of service during maintenance and repair/replacement.

5.7.3. During a fault in GIS compartment other than CB compartment, maximum one bus bar and/or one feeder permitted out of service during maintenance and repair/replacement.

5.8. The material and thickness of the enclosures shall be such as to withstand an internal flash over without burns through for a period of 300 ms at rated short time withstand current. The material shall be such that it has no effect of environment as well as from the by-products of SF6 breakdown under arcing condition. This shall be validated with Type Test.

5.9. Each section shall have plug- in or easily removable connection pieces to allow for easy replacement of any component with the minimum of disturbance to the remainder of the

equipment. Inspection windows (View Ports) shall be provided for Disconnect Switch and both type of earth switches i.e. Maintenance and fast operating.

- 5.10. The material used for manufacturing the switchgear equipment shall be of the type, composition and have physical properties best suited to their particular purposes and in accordance with the latest engineering practices. All the conductors shall be fabricated of aluminum/ copper tubes of cross sectional area suitable to meet the normal and short circuit current rating requirements. The finish of the conductors shall be smooth so as to prevent any electrical discharge. The conductor ends shall be silver plated and fitted into finger contacts or tulip contacts. The contacts shall be of sliding type to allow the conductors to expand or contract axially due to temperature variation without imposing any mechanical stress on supporting insulators.
- 5.11. Each pressure filled enclosure shall be designed and fabricated to comply with the requirements of the applicable pressure vessel codes and based on the design temperature and design pressures as defined in IEC-62271-203.
- 5.12. The maximum SF<sub>6</sub> gas leakage shall not exceed 0.5% (half percent) per year for the whole equipment and for any individual gas compartment separately. The SF<sub>6</sub> gas leakage should not exceed 0.5% per year and the leakage rate shall be guaranteed for at least 10 years. In case the leakage under the specified conditions is found to be greater than 0.5% after one year of commissioning, the manufacturer will have to supply free of cost, the total gas requirement for subsequent ten (10) years, based on actual leakage observed during the first year of operation after commissioning.
- 5.13. Each gas-filled compartment shall be equipped with static filters, density switches, filling valve and safety diaphragm. The filters shall be capable of absorbing any water vapor which may penetrate into the enclosures as well as the by-products of SF<sub>6</sub> during interruption. Each gas compartment shall be fitted with non-return valve connectors for evacuating & filling the gas and checking the gas pressure etc.
- 5.14. The switchgear when installed and operating under the ambient conditions shall perform satisfactorily and safely under all normal and fault conditions. Even repeated operations up to the permissible servicing intervals under 100% rated and fault conditions, shall not diminish the performance or significantly shorten the useful life of the switchgear. Any fault caused by external/internal reasons shall be positively confined to the originating compartment and shall not spread to other parts of the switchgear.
- 5.15. The thermal rating of all current carrying parts shall be minimum for one sec. for the rated symmetrical short-circuit current.
- 5.16. The arrangement of the individual switchgear bays shall be such so as to achieve optimum space-saving, neat and logical arrangement and adequate accessibility to all external components.
- 5.17. The layout of the substation equipment, bus bars and switchgear bays shall preferably be based on the principle of "phase grouping". Switchgear layout based on the "mixed phases" principle shall not be accepted without mutual agreement between supplier and employer.

The arrangement of the equipment offered must provide adequate access for operation, testing, Repair and maintenance.

- 5.18. All the elements shall be accessible without removing support structures for routine inspections. The removal of individual enclosure parts or entire breaker bays shall be possible without disturbing the enclosures of neighboring bays and LCC panels.
- 5.19. It should not be possible to unwillingly touch live parts of the switchgear or to perform operations that lead to arcing faults without the use of tools or brute force. All interlocks that prevent potentially dangerous mal-operations, shall be constructed such that they cannot be operated easily, i.e. the operator must use tools or brute force to over-ride them.
- 5.20. In general the contours of energized metal parts of the GIS and any other accessory shall be such, so as to eliminate areas or points of high electrostatic flux concentrations. The surfaces shall be smooth with no projection or irregularities which may cause visible corona. No corona shall be visible in complete darkness which the equipment is subjected to specified test voltage. There shall be no radio interference from the energized switchgear at rated voltage.
- 5.21. The GIS shall be designed, so as to take care of the VFT over voltages generated as a result of pre-strikes and re-strikes during isolator operation. Maximum VFT over voltages peak shall not be higher than rated lightning impulse withstand voltage (LIWV) of the equipment. Necessary measures shall be under taken by GIS manufacture to restrict maximum VFT over voltages lower than the LIWV. Manufacturer shall submit the study report of VFTO generated for GIS installation for 400 kV and above.
- 5.22. The enclosure shall be of continuous design and shall meet the requirement as specified in of IEEE 80 2013 (special considerations for GIS).

The enclosure shall be sized for carrying induced current equal to the rated current of the Bus. The conductor and the enclosure shall form the concentric pair with effective shielding of the field internal to the enclosure.
- 5.23. The fabricated metal enclosure shall be of Aluminium alloy having high resistance to corrosion, low electrical losses and negligible magnetic losses. However, 765kV CB Enclosure made of other proven material /alloy as per manufacturer's standard practice shall also be acceptable. The manufacturer shall clearly indicate the material used for different GIS enclosures in the GTP/design document during approval. All joint surfaces shall be machined and all castings shall be spot faced for all bolt heads or nuts and washers. All screws, bolts, studs and nuts shall conform to metric system."The elbows, bends, cross and T-sections of interconnections shall include the insulators bearing the conductor when the direction changes take place in order to ensure that live parts remain perfectly centered and the electrical field is not increased at such points.
- 5.24. The enclosure shall be designed to practically eliminate the external electromagnetic field and thereby electro-dynamic stresses even under short circuit conditions. The average intensity of electromagnetic field shall not be more than 50 micro Tesla on the surface of the enclosure.

- 5.25. The switchgear shall have provision for connection with ground mat risers through copper connections. This provision shall consist of grounding pads to be connected to the ground mat riser in the vicinity of the equipment.
- 5.26. For 400 kV and above voltage class GIS, wherever required, stairs, fixed ladder, platforms, and walkways for operation and maintenance access to the operating mechanism and monitoring devices should be provided to permit access. The structures shall be either aluminum or hot-dipped galvanized steel. All structures, stairs, platforms, and walkways shall conform to the relevant occupational health and safety regulations and designed in accordance with the latest industry standards and guidelines. The platforms and walkways shall have anti-skid surfaces that can be walked on. Handrails shall be provided where necessary. The GIS supplier shall provide 3-D arrangement drawing to show the location of equipment and access to it.
- 5.27. In addition to above suitable portable scissor lift shall be provided for access of distant portion of GIS installation.
- 5.28. New Gasket, sealant and desiccant shall be installed for permanent sealing of all site/field assembled joints. No gaskets are to be reused for any permanent seal broken or disturbed in the field/site.
- 5.29. The enclosure & support structure shall be designed such that person of 1780 mm in height and 80 Kg in weight is able to climb on the equipment for maintenance.
- 5.30. The sealing provided between flanges of two modules / enclosures shall be such that long term tightness is achieved.
- 5.31. Alarm circuit shall not respond to faults for momentary conditions. The following indications including those required elsewhere in the specifications shall be generally provided in the alarm and indication circuits.

**Gas Insulating System:**

- i) Loss of Gas Density
- ii) Any other alarm necessary to indicate deterioration of the gas insulating system.

**Operating System:**

- i) Low operating pressure
  - ii) Loss of Heater power
  - iii) Loss of operating power
  - iv) Loss of control supply
  - v) Pole Discordance.
- 5.32. The equipment will be operated under the following ambient conditions (or as defined in the section project):
- a) The ambient temperature varies between 0 degree-C and 50 degree-C. However, for design purposes, ambient temperature should be considered as 50 degree-C.
  - b) The humidity will be about 95% (indoors)
  - c) The elevation is less than 1000 meters

- 5.33. Temperature rise of all current carrying parts and enclosures shall be limited to the values stipulated in IEC-62271-1, under rated current and the climatic conditions as specified.
- 5.34. All cabinet heaters shall be rated for 240V AC (1-phase) supply and shall be complete with thermostat, control switches and fuses, connected as a balanced 3-phase 4-wire load. The heaters shall be so arranged and protected as to create no hazard to adjacent equipment from the heat produced.
- 5.35. **Bellows or Compensating Units:-** Adequate provision shall be made to allow for the thermal expansion of the conductors & enclosures and for differential thermal expansion between the conductors and the enclosures. The bellows metallic( preferably stainless steel) with suitable provision for permitting the movement during expansion and contraction may be provided and shall be of following types:.
1. Lateral / Vertical mounting units: These shall be inserted, as required, between sections of busbars, on transformer, shunt reactor and XLPE cable etc. Lateral mounting shall be made possible by a sliding section of enclosure and tubular conductors.
  2. Axial compensators: These shall be provided to accommodate changes in length of busbars due to temperature variations.
  3. Parallel compensators: These shall be provided to accommodate large linear expansions and angle tolerances.
  4. Tolerance compensators: These shall be provided for taking up manufacturing, site assembly and foundation tolerances.
  5. Vibration compensators: These bellow compensators shall be provided for absorbing vibrations caused by the transformers and shunt reactors when connected to SF6 switchgear by oil- SF6 bushings.

The electrical connections across the bellows or compensating units shall be made by means of suitable connectors. For sliding type compensators, markers/pointers shall be provided to observe expansion or contraction during climatic conditions.

- 5.36. **Indication and verification of switch positions:** Indicators shall be provided on all circuit breakers, isolators and earth-switches, which shall clearly show whether the switches are open or closed. The indicators shall be mechanically coupled directly to the main contact operating drive rod or linkages and shall be mounted in a position where they are clearly visible from the floor or the platform in the vicinity of the equipment.

Inspection windows shall also be provided with all isolators and earth switches so that the switch contact positions can be verified by direct visual inspection.

- 5.37. **Pressure relief device :** Pressure relief devices shall be provided in the gas sections to protect the gas enclosures from damage or distortion during the occurrence of abnormal pressure increase or shock waves generated by internal electrical fault arcs (preferably in downward direction).

Pressure relief shall be achieved either by means of diaphragms or plugs venting directly into the atmosphere in a controlled direction.

If the pressure relief devices vent directly into the atmosphere, suitable guards and deflectors shall be provided.

- 5.38. **Pressure vessel requirements:** The enclosure shall be designed for the mechanical and thermal loads to which it is subjected in service. The enclosure shall be manufactured and tested according to the Pressure Vessel Code (ASME/CENELEC code for pressure Vessel.)

The bursting strength of Aluminum castings has to be at least 5 times the design pressure. A bursting pressure test shall be carried out at 5 times the design pressure as a type test on each type of enclosure.

Each enclosure has to be tested as a routine test at 1.5 times the design pressure for one minute.

5.39. **Grounding:**

- 5.39.1. The grounding system shall be designed and provided as per IEEE-80-2013 and CIGRE-44 to protect operating staff against any hazardous touch voltages and electro-magnetic interferences.

- 5.39.2. The GIS supplier shall define clearly what constitutes the main grounding bus of the GIS. The contractor shall supply the entire material for grounding bus of GIS viz conductor, clamps, joints, operating and safety platforms etc. The contractor is also required to supply all the earthing conductors and associated hardware material for connecting all GIS equipment, bus ducts, enclosures, control cabinets, supporting structure, GIS surge arrestor etc. to the ground bus of GIS.

- 5.39.3. The enclosure of the GIS may be grounded at several points so that there shall be grounded cage around all the live parts. A minimum of two nos. of grounding connections should be provided for each of circuit breaker, cable terminals, surge arrestors, earth switches and at each end of the bus bars. The grounding continuity between each enclosure shall be effectively interconnected either internally or externally with Copper/Aluminum bonds of suitable size to bridge the flanges. Subassembly to subassembly bonding shall be provided to bridge the gap & safe voltage gradients between all intentionally grounded parts of the GIS assembly & between those parts and the main grounding bus of the GIS.

- 5.39.4. Each marshaling box, local control panel, power and control cable sheaths and other non-current carrying metallic structures shall be connected to the grounding system of GIS via connections that are separated from GIS enclosures.

- 5.39.5. The grounding connector shall be of sufficient mechanical strength to withstand electromagnetic forces as well as capable of carrying the anticipated maximum fault current without overheating. At least two grounding paths shall be provided to connect each point to the main grounding bus. Necessary precautions should be under taken to prevent excessive currents from being induced into adjacent frames, structures of reinforcing steel and to avoid establishment of current loops via other station equipment.

5.39.6. All flexible bonding leads shall be tinned copper. All connectors, for attaching flexible bonding leads to grounding conductors and grounding conductors to support structures shall be tinned bronze with stainless steel or tinned bronze hardware.

5.39.7. The contractor shall provide suitable measure to mitigate transient enclosure voltage caused by high frequency currents due to by lightning strikes, operation of surge arrestor, phase to earth fault and discharges between contacts during switching operation. The grounding system shall ensure safe touch & step voltages in all the enclosures.

**5.40. UHF sensors for PD detection:**

Adequate number of UHF sensors shall be provided in the offered GIS for detection of Partial discharge (of 5 pC and above) as per IEC 60270. The number and location of these sensors shall be based on laboratory test on typical design of GIS as per recommendations of CIGRE Document No. 654 (*APPLICATION GUIDE FOR SENSITIVITY VERIFICATION for UHF PARTIAL DISCHARGE DETECTION SYSTEM FOR GIS*). Offered numbers and location of UHF sensors shall be submitted based on above said criteria along with attenuation calculation for approval of the employer. Further UHF sensors shall necessarily be provided in close proximity to VT compartments.

However adequacy of number of sensors and their location shall be verified at site as per recommendations of above CIGRE Document No. 654. In case during site testing, additional UHF sensors are required, the same shall also be supplied & installed to complete the technical requirement.

The calibration and frequency response of PD couplers shall be as per NGC Technical Guidance note TGN (T) 121, issue 1, 1997. Data sheet shall be submitted for the UHF couplers meeting this requirement.

**5.41. Gas Insulated Bus (GIB) layout :**

GIB shall be designed based on the following criteria

- (1) Maximum weight of gas in a gas tight section of GIB shall not exceed 400 Kg (for 765 kV & 400 kV)/ 250 Kg (for 220 kV & 132 kV).
- (2) GIB shall be generally in horizontal layer. However in exceptional circumstance GIB in vertical layers can be provided with the approval of employer.
- (3) The minimum vertical ground clearance of GIB at road crossing shall be 5.5 meters
- (4) The horizontal clearance between GIB and GIS building /any other building wall shall be preferably three (3) meters.
- (5) The GIB route inside the GIS Hall shall not obstruct easy access to GIS and control room buildings and shall not obstruct movement of crane, equipment including HV test equipment for maintenance works.

- (6) The GIB clear height outside the GIS hall in switchyard area shall be minimum 3.5 meter, so as not to obstruct easy access to GIB, movement of crane for maintenance work.
- (7) Optimization of outdoor GIB length using overhead AIS connection with Bus Post Insulator of respective voltage class is generally acceptable subject to meeting the electrical clearances as stipulated.
- (8) For the maintenance of GIB of one circuit, only that circuit shall be isolated. Adequate clearance between bus ducts of two circuit shall be ensured by the contractor during layout finalization.
- (9) GIS manufacturer as per their design shall preferably use maximum three standard straight horizontal outdoor bus duct lengths for entire GIS installation to optimize the spare requirement.

#### 5.42. **Extension of GIS**

5.42.1. The arrangement of gas sections or compartments shall be such as to facilitate future extension of any make without any drilling, cutting or welding on the existing equipment. To add equipment, it shall not be necessary to move or dislocate the existing switchgear bays.

5.42.2. As the GIS is likely to be extended in future, during detailed engineering stage, the contractor shall make available the complete design detail of **interface module** such as cross section, enclosure material, enclosure dimensions (inner & outer), Flange diameter (inner & outer), conductor cross-section & connection arrangement, bolt spacing & dimension, rated gas pressure, Gasket detail etc. Further GIS manufacturer supplying GIS under present scope shall furnish all the required details in addition to mentioned above necessary for design and successful implementation of an interface module during later stage while extending GIS by any other GIS manufacturer, without any help of GIS manufacturer who has supplied the GIS equipment in present scope.

5.42.3. The Interface module shall be designed to provide Isolating link with access hole on enclosure. The Isolating link shall be provided in such a way so that HV test can be performed on either side of the interface module separately, keeping other side of GIS remained isolated. Interface Module drawing with necessary detail shall be submitted for approval. Conceptual Interface Module Drawing is attached as **Annexure-9**

5.42.4. Further the contractor who is extending the existing GIS installation, it shall be his responsibility to provide interface module matching with the existing GIS interface module. The drawing of existing GIS interface/end piece module shall be provided by the employer. However it shall be the responsibility of contractor to verify the existing details during site visit.

The Contractor shall optimally utilize the space inside the GIS hall (including the extension portion) for accommodating the interface module being supplied under the contract.

#### 5.43. **SF6 GAS**

The SF6 gas insulated metal-clad switchgear shall be designed for use with SF6 gas complying with the **recommendations** of IEC 60376, 60376A & 60376B, at the time of the first charging with gas. All SF6 gas supplied as part of the contract shall comply with the requirements of IEC & should be suitable in all respects for use in the switchgear under all operating conditions. Necessary statutory clearances from concerned authorities for import of the Gas and for storage of the Gas shall be obtained.

The high pressure cylinders in which SF6 gas is supplied & stored at site shall comply with the requirements of following standards & regulations :

- IS : 4379** Identification of the contents of industrial gas cylinders.
- IS : 7311** Seamless high carbon steel cylinders for permanent & high pressure liquefiable gases. The cylinders shall also meet latest Gas Cylinder Rules (PESO)

SF6 gas shall be tested for purity, dew point, air, hydrolysable fluorides and water contents as per IEC:60376, 60376A & 60376B and test certificates shall be furnished to the Employer indicating all test results as per IEC standards for each lot of SF6 gas. Further site tests for dew point and purity shall be done during commissioning of GIS. Gas bottles should be tested for leakage during receipt at site.

The contractor shall indicate diagnostic test methods for checking the quality of gas in the various sections of GIS during service. The method proposed shall have as a minimum check the moisture content & the percentage of purity of the gas on annual basis.

The contractor shall also submit clearly the precise procedure to be adopted by maintenance personnel for handling equipment that are exposed to the products of arcing in SF6 Gas so as to ensure that they are not affected by possible irritants of the skin and respiratory system. Recommendations shall be submitted for suitable protective clothing, method of disposal of cleaning utensils and other relevant matters.

The contractor shall also indicate the details and type of filters used in various gas sections, and should also submit the operating experience with such filters.

5.43.1. **SF6 gas monitoring devices and alarm circuits:** Dial type temperature compensated gas density monitoring devices with associated pressure gauge will be provided. The devices shall provide continuous & automatic monitoring of gas density. A separate device shall be provided for each gas tight compartment so that it can be monitored simultaneously as follows:-

Comparison/ Sl. No.	Compartments except CB	Circuit Breaker compartments
1	<b>“Gas Refill level:</b> This will be used to annunciate the need for the gas refilling. The contractor shall provide a	<b>'Gas Refill' level :</b> This will be used to annunciate the need for gas refilling. The contractor shall provide a contact

	contact for remote indication.	for remote indication.
2	<b>“SF6 low level”</b> : This will be used to announce the need for urgent gas filling . A contact shall be provided for remote indication	<b>“SF6 low level”</b> : This will be used to announce the need for urgent gas filling . A contact shall be provided for remote indication
3	<b>'Zone Trip' level:</b> This is the minimum level at which the manufacturer will guarantee the insulation rating of the assembly.	<b>Breaker Block' level :</b> This is the minimum gas density at which the manufacturer will guarantee the rated fault interrupting capability of the breaker .At this level the breaker block contact shall operate and the closing & tripping circuit shall be blocked
4	<b>Not Applicable</b>	<b>'Zone Trip' level:</b> This is the minimum level at which the manufacturer will guarantee the insulation rating of the assembly.

The density monitor/pressure switch contacts shall be in accordance with the above requirement.

It shall be possible to test all gas monitoring relays/devices without de-energizing the primary equipment & without reducing pressure in the main section. It shall also damp the pressure pulsation while filling the gas in service, so that flickering of the pressure switch contacts does not take place.

5.43.2. **Gas Supply:** The contractor shall include the supply of all SF6 gas necessary for filling & putting into operation the complete switchgear installation being supplied. The empty gas cylinders shall be returnable to the contractor.

5.44. **Documentation**

The contractor shall prepare and submit to the employer, drawings, details that show the GIS design in order for the employer to verify the equipment conform to the specifications. The Design Document to be submitted for review and approval are as follows:

- i. Design Review Document as per clause no. 19 of this specification
- ii. Single Line Diagram
- iii. Gas Schematic Diagram
- iv. GTP-Guaranteed Technical Particulars
- v. GIS layout (Plan and Section) including 3D drawing

- vi. GIS Component Drawings
- vii. Interface modules drawing for GIS extension
- viii. Rating and Name Plate Drawing
- ix. GIS/LCC Schematics Drawing
- x. Foundation loading plan and detail
- xi. GIS Support Structure Drawing
- xii. GIS platforms and Walkway Drawing
- xiii. GIS grounding plan and details along with design calculation for GIS grounding
- xiv. GIS key Diagram enlisting and marking each and every GIS Module clearly and separately identifiable (indoor and outdoor). This separately identified module shall be complete along with its enclosure, gasket and all active parts such as conductor, conductor joints, corona shield etc.
- xv. Method Statement along with sequential instruction for dismantling and assembling of all major components of GIS exhibiting service continuity requirement
- xvi. Type Test Reports
- xvii. Seismic Analysis Report
- xviii. Study report of VFTO generated for GIS installation for 400 kV and above.
- xix. The general arrangement drawing of interconnecting bus-duct from GIS bay module to XLPE cable termination end
- xx. The general arrangement drawing of Terminal connection arrangement to connect GIS duct to SF6/Oil bushing and duct mounting arrangement details
- xxi. Gas handling procedure
- xxii. The design & construction proposal of the building along with necessary information, data, and drawings according to the complete requirements
- xxiii. Capacity calculation of EOT crane for GIS hall considering a factor of safety of 5
- xxiv. Method statement/ procedure of ON SITE high voltage testing with PD measurement and Switching Impulse test
- xxv. **Additional CB data to be furnished during detailed engineering :**
  - a) Design data on capabilities of circuit breakers in terms of time and number of operations at duties ranging from 100 % fault currents to load currents of the lowest possible value without requiring any maintenance or checks.
  - b) Curves supported by test data indicating the opening time under close open operation with combined variation of trip coil voltage and hydraulic pressure.
  - c) Contact Travel: Operating mechanism operating shaft travel and contact overlap of Circuit Breaker to be provided

xxvi. PD Monitoring System

- a) The technical proposal for PDM system along with detailed design documentation.
- b) Data sheet for the UHF couplers.
- c) The Sub-station GIS layout as a separate drawing indicating position of spacers, spread over of PD sensors with distance, sensor identification, the detector unit identification etc., total numbers of offered UHF Sensors along with attenuation calculation.
- d) Guaranteed Technical Particulars & Data Sheet for various components used in the PDM system.
- e) Electromagnetic compatibility Test Reports.
- f) List of critical spares.

xxvii. Installation and Operation & Maintenance Manual

**6. CIRCUIT BREAKERS**

- 6.1. **General :** SF6 gas insulated metal enclosed circuit breakers and accessories shall conform to IEC: 62271-100, IEC: 62271-1 and other relevant IEC standards except to the extent explicitly modified in the specification and shall also be in accordance with requirements specified in Section-GTR.

Circuit breakers shall be equipped with the operating mechanism. Circuit breakers shall be of single pressure type. Complete circuit breaker with all necessary items for successful operation shall be supplied. The circuit breakers shall be designed for high speed single and three phase reclosing (as applicable) with an operating sequence and timing as specified.

- 6.2. **Duty Requirements:** Circuit breaker shall be C2 - M2 class as per IEC 62271-100.

Circuit breaker shall meet the duty requirements for any type of fault or fault location also for line charging and dropping when used on effectively grounded system and perform make and break operations as per the stipulated duty cycles satisfactorily.

- 6.3. **Pre insertion resistor:** 765kV/400 kV circuit breakers for line bay (as per the provisions of bid proposal sheet) shall be provided with single step pre insertion closing resistors (wherever the requirement of PIR is explicitly specified so ) to limit the switching surges to a value of less than 1.9 p.u for 765kV and 2.3 p.u for 400kV. PIR contacts should open immediately after closing of main contacts or At least 5 ms prior to opening of main contacts at rated air/gas pressure where the PIR contacts remain closed. The resistor shall have thermal rating for the following duties :

- a. **Terminal fault : Close.... 1 Min..... Open..... Close Open 2 min..... Close ..... 1 Min..... Open Close Open.**
- b. **Reclosing against trapped charges :** Duty same as under (a.) above. The first, third and fourth closures are to be on de-energised line while second closing is to be made with lines against trapped charge of 1.2 p.u. of opposite polarity.

- c. **Out of phase closing: One** closing operation under phase opposition that is with twice the voltage across the terminals.

No allowance shall be made for heat dissipation of resistor during time interval between successive closing operations. The resistors and resistor supports shall perform all these duties without deterioration. Calculations and test reports of resistors proving thermal rating for duties specified above shall be furnished during detailed engineering. The calculations shall take care of adverse tolerances on resistance values and time settings.

6.4. The circuit breaker shall be capable of:

1. Interrupting the steady and transient magnetizing current shall be as follows:

<b>Voltage Level</b>	<b>Type of Transformer</b>	<b>Rating (in MVA)</b>
<b>765kV</b>	<b>765/400kV</b>	<b>250 to 1500</b>
<b>400kV</b>	<b>765/400kV</b>	<b>250 to 1500</b>
	<b>400/220kV</b>	<b>250 to 630</b>
	<b>400/132kV</b>	<b>160 to 315</b>
<b>220kV</b>	<b>400/220kV</b>	<b>250 to 630</b>
	<b>220/132kV</b>	<b>50 to 200</b>
<b>132kV</b>	<b>220/132kV</b>	<b>50 to 200</b>
	<b>132/33kV</b>	<b>10 to 50</b>

2. Interrupting line/cable charging current as per IEC without re-strikes and without use of opening resistors. The breaker shall be able to interrupt the rated line charging current as per IEC-62271-100 with test voltage immediately before opening equal to the product of  $U/\sqrt{3}$  and 1.4
3. Clearing short line fault (Kilometric faults) with source impedance behind the bus equivalent to symmetrical fault current specified.
4. Breaking 25% the rated fault current at twice the rated voltage under phase opposition condition.
5. The breaker shall satisfactorily withstand the high stresses imposed on them during fault clearing, load rejection and re-energisation of shunt reactor and/or series capacitor compensated lines with trapped charges.

- 6. Withstanding all dielectric stresses imposed on it in open condition at lock out pressure continuously (i.e. shall be designed for 2 p.u. across the breaker continuously, for validation of which a power frequency withstand test conducted for a duration of at least 15 minutes is acceptable).
- 7. Circuit breakers shall be able to switch in and out the shunt reactor as detailed below:

Voltage Level	Reactor Rating (in MVAR)	Max. rise of overvoltage (in p.u.)
765kV	150 to 330	1.9
400kV	50 to 150	2.3
220kV	25 to 50	2.3

6.5. **Total Break Time :**The total break time shall not be exceeded under any of the following duties :

- a) Test duties T10,T30,T60,T100 (with TRV as per IEC- 62271-100 )
- b) Short line fault L90, L75 (with TRV as per IEC-62271-100 )

The Contractor may please note that total break time of the breaker shall not be exceeded under any duty conditions specified such as with the combined variation of the trip coil voltage (70-110%), pneumatic/hydraulic pressure and SF6 gas pressure etc. While furnishing the proof for the total break time of complete circuit breaker, the contractor may specifically bring out the effect of non-simultaneity between poles and show how it is covered in the total break time.

The values guaranteed shall be supported with the type test reports.

6.6. **Constructional features :**

The features and constructional details of breakers shall be in accordance with requirements stated hereunder:

- 6.6.1. If multi-break interrupters are used, these shall be so designed and augmented that a uniform voltage distribution is developed across them. Calculations/ test reports in support of the same shall be furnished. The thermal and voltage withstand rating of the grading elements shall be adequate for the service conditions and duty specified.
- 6.6.2. **Contacts:** All making and breaking contacts shall be sealed and free from atmospheric effects. Contacts shall be designed to have adequate thermal and current carrying capacity for the duty specified and to have a life expectancy so that frequent replacement due to excessive burning will not be necessary. Provision shall be made for rapid dissipation of heat generated by the arc on opening.

- 6.6.3. Any device provided for voltage grading to damp oscillations or, to prevent re-strike prior to the complete interruption of the circuit or to limit over voltage on closing, shall have a life expectancy comparable of that of the breaker as a whole.
- 6.6.4. Breakers shall be so designed that when operated within their specified rating, the temperature of each part will be limited to values consistent with a long life for the material used. The temperature rise shall not exceed that indicated in IEC-62271-100 under specified ambient conditions.
- 6.6.5. The breaker should be able to withstand all dielectric stresses imposed on it in open condition at lockout pressure continuously (i.e. 2 p.u. power frequency voltage across the breaker continuously)
- 6.6.6. In the interrupter assembly there shall be an adsorbing product box to minimize the effect of SF6 decomposition products and moisture. The material used in the construction of the circuit breakers shall be such as to be fully compatible with SF6 gas decomposition products.
- 6.6.7. Provisions shall be made for attaching an operational analyzer to record travel, speed and making measurement of operating timings etc. after installation at site. The contractor shall supply three set of transducer for each substation covered under the scope.
- 6.6.8. Circuit Breaker shall be supplied with auxiliary switch having additional 8 NO (normally open) and 8 NC ( normally closed) contacts for future use over and above those required for switchgear interlocking and other control and protection function. These spare NO and NC contacts shall be wired upto the local control cubicle.
- 6.6.9. The CO (Close-open) operation and its timing shall be such as to ensure complete travel/insertion of the contact during closing operation and then follow the opening operation

## 6.7. **Operating mechanism**

### 6.7.1. General Requirements :

- a) Circuit breaker shall be operated by spring charged mechanism or electro hydraulic mechanism or a combination of these. The mechanism shall be housed in a dust proof cabinet and shall have IP: 42 degree of protection.
- b) The operating mechanism **box** shall be strong, rigid, rebound free and shall be readily accessible for maintenance.
- c) The operating mechanism shall be suitable for high speed reclosing and other duties specified. During reclosing the breaker contacts shall close fully and then open. The mechanism shall be anti-pumping and trip free (as per IEC definition) under every method of closing.
- d) The mechanism shall be such that the failure of any auxiliary spring will not prevent tripping and will not cause unwanted trip or closing operation of the Circuit Breaker.

- e) A mechanical indicator shall be provided to show open and close position of the breaker. It shall be located in a position where it will be visible to a man standing on the ground level with the mechanism housing closed. An operation counter shall also be provided.
- f) Working parts of the mechanism shall be of corrosion resisting material, bearings which require grease shall be equipped with pressure type grease fittings. Bearing pin, bolts, nuts and other parts shall be adequately pinned or locked to prevent loosening or changing adjustment with repeated operation of the breaker.
- g) The contractor shall furnish detailed operation and maintenance manual of the mechanism along with the operation manual for the circuit breaker.

#### 6.7.2. **Control**

- a) The close and trip circuits shall be designed to permit use of momentary-contact switches and push buttons.
- b) Each breaker pole shall be provided with two (2) independent tripping circuits and trip coils which may be connected to a different set of protective relays.
- c) The breaker shall normally be operated by remote electrical control. Electrical tripping shall be performed by shunt trip coils. However, provisions shall be made for local electrical control. For this purpose a local/remote selector switch and close and trip control switch/push buttons shall be provided in the breaker control cabinet.
- d) The trip coil shall be suitable for trip circuit supervision during both open and close position of breaker.
- e) Closing coil and associated circuits shall operate correctly at all values of voltage between 85% and 110% of the rated voltage. Shunt trip and associated circuits shall operate correctly under all operating conditions of the circuit breaker upto the rated breaking capacity of the circuit breaker and at all values of supply voltage between 70% and 110% of rated voltage.
- f) Density meter contacts and pressure switch contacts shall be suitable for direct use as permissive in closing and tripping circuits. Separate contacts have to be used for each of tripping and closing circuits. If contacts are not suitably rated and multiplying relays are used then fail safe logic/schemes are to be employed. DC supplies shall be monitored for remote annunciations and operation lockout in case of dc failures.
- g) The auxiliary switch of the breaker shall be positively driven by the breaker operating rod.

#### 6.7.3. **Spring operated Mechanism**

- a) Spring operated mechanism shall be complete with motor as per manufacturer practice. Opening spring and closing spring with limit switch for automatic charging and other necessary accessories to make the mechanism a complete operating unit shall also be provided.

- b) As long as power is available to the motor, a continuous sequence of the closing and opening operations shall be possible. The motor shall have adequate thermal rating for this duty.
- c) After failure of power supply to the motor one close open operation shall be possible with the energy contained in the operating mechanism.
- d) Breaker operation shall be independent of the motor which shall be used solely for compressing the closing spring. Facility for manual charging of the closing spring shall also be provided. The motor rating shall be such that it required preferably not more than 90 seconds for full charging of the closing spring.
- e) Closing action of circuit breaker shall compress the opening spring ready for tripping.
- f) When closing springs are discharged after closing a breaker, closing springs shall automatically be charged for the next operation and an indication of this shall be provided in the local control cabinet & SAS .
- g) Provisions shall be made to prevent a closing operation of the breaker when the spring is in the partial charged condition.
- h) Mechanical interlocks shall be provided in the operating mechanism to prevent discharging of closing springs when the breaker is in the closed position.
- i) The spring operating mechanism shall have adequate energy stored in the operating spring to close and latch the circuit breaker against the rated making current and also to provide the required energy for the tripping mechanism in case the tripping energy is derived from the operating mechanism.
- j) The spring charging failure alarm shall be provided with a time delay relay having setting range from 0-3 minutes.
- k) Separate MCBs shall be provided for each spring charging motor and the rating of MCBs shall be suitably selected to match the starting, running and stalling time.
- l) An overload relay shall be provided for protection of the spring charging motor.

#### **6.7.4. Hydraulically Operated Mechanism :**

- a) Hydraulically operated mechanism shall comprise of operating unit with power cylinder, control valves, high and low pressure reservoir, motor etc.
- b) The hydraulic oil used shall be fully compatible for the temperature range to be encountered during operation.
- c) The oil pressure switch controlling the oil pump and pressure in the high pressure reservoir shall have adequate no. of spare contacts, for continuous monitoring of low pressure, high pressure etc. at switchyard control room.

- d) The mechanism shall be suitable for at-least two close open operations after failure of AC supply to the motor starting at pressure equal to the lowest pressure of auto reclose duty plus pressure drop for one close open operation.
- e) The mechanism shall be capable of operating the circuit breaker correctly and performing the duty cycle specified under all conditions with the pressure of hydraulic operated fluid in the operating mechanism at the lowest permissible pressure before make up.
- f) Trip lockout shall be provided to prevent operations of the circuit breaker below the minimum specified hydraulic pressure. Alarm contacts for loss of Nitrogen shall also be provided.
- g) All hydraulic joints shall have no oil leakage under the site conditions and joints shall be tested at factory against oil leakage.

**6.8. Controlled Switching Device(CSD):**

6.8.1. 765kV & 400KV Circuit Breaker shall be equipped with controlled switching device with consequent optimization of switching behavior, when used in:

- 1. Switching of transformer(from 765kV and 400kV side circuit breakers only)
- 2. Switching of shunt reactor

6.8.2. The CSD shall be provided in 765kV/400kV Circuit breakers for controlling transformers and reactors (ie for breakers of switchable line reactor and in Main& Tie circuit breakers of Transformers, Transmission lines with non-switchable line reactors and Bus reactors). The requirement of CSD shall be explicitly specified in price schedule

6.8.3. Technical Requirement for Controlled switching device:

- a) The CSD shall be designed to operate correctly and satisfactorily with the excursion of auxiliary A/C & DC voltages and frequency as specified in section - GTR.
- b) The CSD shall meet the requirements of IEC-61000-4 16 class IV regarding HF disturbance test and fast transient test shall be as per IEC-61000 – 4-4 level IV and insulation test as per 60255 – 5.
- c) The CSD shall have functions for switching ON & OFF the circuit breakers.
- d) The CSD shall get command to operate the breakers manually or through auto reclose relay at random. The controller shall be able to analyze the current and voltage waves available through the signals from secondaries of CTs & CVTs for the purpose of calculation of optimum moment of the switching the circuit breaker and issue command to circuit breaker to operate.
- e) The CSD shall have an adaptive control feature to consider the next operating time of the breaker in calculation of optimum time of issuing the switching command. In calculation of net operating time of the breaker the controller must consider all factors that may affect the operating time of the breaker such as, but not limited to, ambient temperature, control voltage variation, SF6 gas density variations etc. Schematic drawing for this purpose shall be provided by the contractor. The

- accuracy of the operating time estimation by the controller shall be better than + 0.5 ms.
- f) The CSD shall have communication port to facilitate online communication of the control switching device with SCADA directly on 61850 or through gateway which shall be under present scope.
  - g) The CSD shall be PC compatible for the setting of various parameters and down loading of the settings and measured values date time of switching etc. Window based software for this purpose shall be supplied by the contractor to be used on the owner's PC.
  - h) The CSD shall be suitable for current input of 1 amp from the secondary of the CTs. and 110 V (Ph to Ph) from the CVTs. The controller shall withstand transient and dynamic state values of the current from the secondary of the CTs and CVTs.
  - i) The CSD shall have time setting resolution of 0.1 ms or better.
  - j) The CSD shall have sufficient number of output/input potential free contacts for connecting the monitoring equipment and annunciation system available in the control room. Necessary details shall be worked out during engineering the scheme.
  - k) The CSD shall also record and monitor the switching operations and make adjustments to the switching instants to optimize the switching behavior as necessary. It shall provide self-diagnostic facilities, signaling of alarms and enable downloading of data captured from the switching events.
  - l) The provision for bypassing the Controlled switching device shall be provided through BCU and SCADA both so that whenever, the CSD is not healthy due to any reason (including auxiliary supply failure), uncontrolled trip/close command can be extended to the circuit Breaker. Alternatively, in case of any non-operation of the CSD after receiving a close/trip command after a pre-determined time delay, the CSD should automatically be bypassed so as to ensure that the trip and close commands are extended to the Trip/Close coils through subsequent command.
  - m) The CSD shall be provided with a communication port to facilitate online communication of the CSD with Substation automation system directly on IEC 61850 protocols. If the CSD does not meet the protocols of IEC 61850, suitable gateway shall be provided to enable the communication of CSD as per IEC 61850.

6.9. The technical parameters of Circuit breakers are as per Annexure –1

6.10. **Tests :**

6.10.1. **Type Tests:**

- i. In accordance with the requirements stipulated under Section GTR the circuit breaker along with its operating mechanism shall conform to the type tests as per IEC-62271-100.
- ii. The type test report of Electromagnetic Compatibility Test (EMC) of CSD shall be submitted for approval

- iii. Circuit breakers meant for controlled switching shall conform to requirements of IEC/TR-62271-302. The contractor shall submit test reports to demonstrate that the offered CB conforms to the requirements of performance verification tests and parameter definition tests as per IEC/TR 62271-302. The contractor shall also furnish the report for the re-ignition free arcing window for switching 3-phase shunt reactor as demonstrated in the shunt reactor switching test.

#### 6.10.2. Routine Tests:

Routine tests as per IEC: 62271-100 shall be performed on all circuit breakers.

In addition to the mechanical and electrical tests specified by IEC, the following shall also be performed.

- i. Speed curves for each breaker shall be obtained with the help of a suitable operation analyzer to determine the breaker contact movement during opening, closing, auto reclosing and trip free operation under normal as well as limiting operating **control** voltage conditions. The tests shall show the speed of contacts directly at various stages of operation, travel of contacts, opening time, closing time, shortest time between separation and meeting of contacts at break make operation etc. This test shall also be performed at site for which the necessary operation analyzer along with necessary transducers, cables, console etc. shall be **arranged by the contractor at his** own cost. After completion of site pre-commissioning test, 03 nos. travel transducer shall be handed over to POWERGRID.
- ii. During testing of CB, dynamic contact resistance measurement (DCRM) shall be carried out for close-open (CO) operations with delay of 300ms between close and trip operations. Minimum 100A current shall be injected for DCRM test. Travel characteristics, injected current, trip/close coil current shall also be recorded along with DCRM test.
- iii. Routine tests on Circuit breakers with Controlled switching device as per IEC/TR 62271-302.

### 7. DISCONNECTORS (ISOLATORS)

7.1. Disconnectors shall be three-pole group operated or Single-pole individual operated (as per single line diagram of the substation) and shall be installed in the switchgear to provide electrical isolation. The disconnectors shall conform to IEC- 62271-102 and shall have the ratings as specified in BPS.

#### 7.2. Construction & Design.

7.2.1. The disconnectors shall be operated by electric motor suitable for use on DC system and shall be equipped with a manual operating mechanism for emergency use. The motor shall be protected against over current and short circuit.

7.2.2. Disconnectors shall be suitable to switch the bus charging currents during their opening and closing and shall conform to all three test duties viz TD1,TD2 and TD3 as per Annexure –F

of IEC: 62271-102. They shall also be able to make and break rated bus transfer current at rated bus transfer voltage which appears during transfer between bus bars in accordance with Annexure –B of IEC: 62271-102. The contact shielding shall also be designed to prevent restrikes and high local stresses caused by transient recovery voltages when these currents are interrupted.

- 7.2.3. The disconnect switches shall be arranged in such a way that all the three phases operate simultaneously. All the parts of the operating mechanism shall be able to withstand starting torque of the motor mechanism without damage until the motor overload protection operates.
- 7.2.4. It shall be possible to operate the disconnect switches manually by cranks or hand wheels.
- 7.2.5. For motor-operated disconnect switches, the control should be electrically and/or mechanically uncoupled from the drive shaft when the switch is operated manually to prevent coincident power operation of the switch and the drive mechanism(s).
- 7.2.6. The operating mechanisms shall be complete with all necessary linkages, clamps, couplings, operating rods, support brackets and grounding devices. All the bearings shall be permanently lubricated or shall be of such a type that no lubrication or maintenance is required.
- 7.2.7. The opening and closing of the disconnectors shall be achieved by either local or remote control. The local operation shall be by means of a two-position control switch located in the Local Control Cabinet (LCC).
- 7.2.8. Remote control of the disconnectors from the control room/SAS shall be made by means of remote/ local transfer switch.
- 7.2.9. The disconnector operations shall be inter-locked electrically with the associated circuit breakers in such a way that the disconnector control is inoperative if the circuit breaker is closed.
- 7.2.10. Each disconnector shall be supplied with auxiliary switch having additional 8 NO (Normally Open) and 8 NC (Normally Closed) contacts for future use over and above those required for switchgear interlocking and automation purposes. These spare NO and NC contacts shall be wired up to the local control cabinet.
- 7.2.11. The signaling of the closed position of the disconnector shall not take place unless it is certain that the movable contacts will reach a position in which the rated normal current, peak withstand current and short-time withstand current can be carried safely.
- 7.2.12. The signaling of the open position of the disconnector shall not take place unless the movable contacts have reached such a position that the clearance between the contacts is at least 80 percent of the rated isolating distance.
- 7.2.13. The disconnectors and safety grounding switches shall have mechanical/electrical interlocks to prevent closing of the grounding switches when isolator switches are in the closed position and to prevent closing of the disconnectors when the grounding switch is in the

closed position. Integrally mounted lock when provided shall be equipped with a unique key for such three phase group. Master key is not permitted.

- 7.2.14. The local control of the Isolator and high-speed grounding switches from the Local Control Cabinet (LCC) should be achieved from the individual control switches with the remote/local transfer switch set to local.
- 7.2.15. All electrical sequence interlocks will apply in both remote and local control modes.
- 7.2.16. Each disconnecter shall have a clearly identifiable local, positively driven mechanical position indicator, together with position indicator on the local control cubicle (LCC) and provisions for taking the signals to the control room. The details of the inscriptions and colouring for the indicator are given as under :

	INSCRIPTION	COLOUR
Open position	OPEN	GREEN
Closed position	CLOSED	RED

- 7.2.17. All the disconnecting switches shall have arrangement allowing easy visual inspection of the travel of the switch contacts in both open and close positions, from the outside of the enclosure.
- 7.2.18. The disconnecting switches shall be provided with rating plates and shall be easily accessible.
- 7.2.19. The mechanical endurance class shall be M2 as per IEC for 765kV, 400kV 220 kV and 132kV disconnectors.
- 7.2.20. Mechanical position indication shall be provided locally at each disconnecter and Electrical indication at each Local Control Cabinet (LCC) / SAS.
- 7.3. The technical parameters of disconnectors are as per **Annexure-2**

**8. SAFETY GROUNDING SWITCHES**

- 8.1. Safety grounding switches shall be three-pole group operated or single-pole individual operated (as per single line diagram of the substation). It shall be operated by DC electric motor and shall be equipped with a manual operating mechanism for emergency use. The motor shall be protected against over-current and short circuit.
- 8.2. Each safety grounding switch shall be electrically interlocked with its associated disconnectors and circuit breaker such that it can only be closed if both the circuit breaker and disconnectors are in open position. Safety grounding switch shall also be mechanically key interlocked with its associated disconnectors.
- 8.3. Each safety grounding switch shall have clearly identifiable local positive driven mechanical indicator together with position indicator on the Local Control Cabinet (LCC) and provision for taking the signal to Control room.

8.4. The details of the inscription and colouring for the indicator are given as under :

	INSCRIPTION	COLOUR
Open position	OPEN	GREEN
Closed position	CLOSED	RED

- 8.5. Interlocks shall be provided so that manual operation of the switches or insertion of the manual operating device will disable the electrical control circuits.
- 8.6. Each ground switch shall be fitted with auxiliary switches having 4 NO (Normally Open) and 4 NC (Normally Closed) contacts for use by others over and above those required for local interlocking and position indication purposes.
- 8.7. Provision shall be made for padlocking / suitable locking arrangement for the ground switches in either the open or closed position.
- 8.8. All portions of the grounding switch and operating mechanism required for grounding shall be connected together utilizing flexible copper conductors having a minimum cross-sectional area of 100 sq. mm.
- 8.9. The main grounding connections on each grounding switch shall be rated to carry the full short circuit current for 1 sec. and shall be equipped with a silver-plated terminal connector suitable for steel strap of adequate rating for connection to the grounding grid.
- 8.10. The safety grounding switches shall conform to the requirements of IEC- 62271- 102 and shall have electrical endurance class: E0 & shall have mechanical endurance class M2 for 765/400 kV & M1 for 220/132 kV voltage level.
- 8.11. The grounding switch shall be provided with test provision (insulated link) to permit test voltage up to 10 kV and up to 200 A to be applied to the main conductor without removing SF6 gas from the enclosure and without disassembling the enclosure except for ground shunt leads.
- 8.12. Combined Disconnectors & Safety grounding switch arrangement shall also be acceptable.
- 8.13. Mechanical position indication shall be provided locally at each switch and Electrical indication at each Local Control Cabinet (LCC) / SAS.

**9. HIGH SPEED MAKE PROOF GROUNDING SWITCHES:**

- 9.1. Grounding switches located at the beginning of the line feeder bay modules shall be of the high speed, make proof type and will be used to discharge the respective charging currents, trapped charge in addition to their safety grounding function. These grounding switches shall be capable of interrupting the inductive and capacitive currents and to withstand the

associated TRV. These shall confirm to class B and electrical endurance class E1 as per annexure – C of IEC : 62271-102

- 9.2. High Speed Grounding switches shall be provided with individual/three pole operating mechanism suitable for operation from DC.
- 9.3. The switches shall be fitted with a stored energy closing system to provide fault making capacity.
- 9.4. The short circuit making current rating of each ground switch shall be at least equal to its peak withstand current rating as specified. The switches shall have inductive/ capacitive current switching capacity as per IEC-62271-102.
- 9.5. Each high speed make proof grounding switch shall have clearly identifiable local positive driven mechanical indicator together with position indicator on the Local Control Cabinet (LCC) and provision for taking the signal to Control Room/SAS.
- 9.6. The details of the inscription and colouring for the indicator shall be as under:-

	INSCRIPTION	COLOUR
Open position	OPEN	GREEN
Closed position	CLOSED	RED

- 9.7. High speed ground switch operation should be possible locally from Local Control Cabinet (LCC)
- 9.8. These high speed grounding switches shall be electrically interlocked with their associated circuit breakers and disconnectors so that the grounding switches cannot be closed if disconnectors are closed. Interlocks shall be provided so that the insertion of the manual operating devices will disable the electrical control circuits.
- 9.9. Each high speed ground switch shall be fitted with auxiliary switches having 4 NO (Normally Open) and 4 NC (Normally Closed) contacts for use by others, over and above these required for local interlocking and position indication. All contacts shall be wired to terminal blocks in the Local Control Cabinet. Provision shall be made for padlocking the ground switches in their open or closed position.
- 9.10. All portion of the grounding switches and operating mechanism required for connection to ground shall be connected together utilizing copper conductor having minimum cross-sectional area of 100 sq. mm.
- 9.11. The main grounding connection on each grounding switch shall be rated to carry the peak withstand current rating of the switch for 1 sec. and shall be equipped with a silver plated terminal connector suitable for steel strap of adequate design for connection to the grounding grid.
- 9.12. The high speed make proof grounding switches shall confirm to the requirements of IEC-62271-102.

- 9.13. The grounding switch shall be provided with test provision (insulated link) to permit test voltage up to 10 kV and up to 200 A to be applied to the main conductor without removing SF6 gas from the enclosure and without disassembling the enclosure except for ground shunt leads.

## 10. INSTRUMENT TRANSFORMERS

### 10.1. Current Transformers

The current transformers and accessories shall conform to IEC: 61869 and other relevant standards except to the extent explicitly modified in the specification.

- 10.1.1. **Ratios and Characteristics:** The CT core distribution for various voltage levels shall be as per Table 3A, 3B, 3C 3D & 3E. Further the numbers of cores, rating, ratios, accuracy class, etc. for the individual current transformers secondary cores shall be in accordance with above table attached at Annexure-3.

Where multi-ratio current transformers are required the various ratios shall be obtained by changing the effective number of turns on the secondary winding.

- 10.1.2. **Rating and Diagram Plates:** Rating and diagram plates shall be as specified in the IEC specification incorporating the year of manufacture. The rated current & extended current rating in case of current transformers and rated voltage, voltage factor & intermediate voltage in case of voltage transformers shall be clearly indicated on the name plate.

The diagram plates shall show the terminal markings and the relative physical arrangement of the current transformer cores with respect to the primary terminals (P1 & P2).

The position of each primary terminal in the current transformer SF6 gas section shall be clearly marked by two plates fixed to the enclosure at each end of the current transformer.

### 10.1.3. Constructional Details:

- a) The current transformers incorporated into the GIS will be used for protective relaying and metering purposes and shall be of metal- enclosed type.
- b) Each current transformer shall be equipped with a secondary terminal box with terminals for the secondary circuits, which are connected to the Local Control Cubicle. The star/delta configuration and the inter connection to the line protection panels will be done at the CT terminal block located in the local control cubicle.
- c) Current transformers guaranteed burdens and accuracy class are to be intended as simultaneous for all cores.
- d) The rated extended currents for 800 kV and 420 kV class Current transformers shall be as given below:

Tap Ratio	800kV, 3000A	400kV, 3000A
	Rated extended currents in % of rated current	
500/1	200	200
1000/1	---	---
2000/1	180	180
3000/1	120 (200 for 15 min)	120

- e) The secondary winding shall be rated for 2A continuously.
- f) Further, the intermediate tapping at 3000-2000 of metering core of 3000 A rated 400kV and 800kV CTs shall be suitable for using as 1000/1 ratio **also**. The Auxiliary reactor, **if used**, as referred at wiring diagram No.0000-000-T-E-L-028 (**Annexure-8**) shall be suitable for connecting to the selected taps.
- g) For 245/145 kV class CTs, the rated extended primary current shall be 120% (or 150% if applicable) on all cores of the CTs as specified in the Section – Project.
- h) For 800/420/245/145 kV current transformer, characteristics shall be such as to provide satisfactory performance of burdens ranging from 25% to 100% of rated burden over a range of 5% to 120%(or specified rated extended current whichever is higher) of rated current in case of metering CTs and up to the accuracy limit factor/knee point voltage in case of relaying CTs.
- i) For 800kV CTs, the instrument security factor at all ratios shall be less than ten (10) for metering core. For 420/245/145kV CTs, the instrument security factor at all ratios shall be less than five (5) for metering core. If any auxiliary CTs/reactor are used in the current transformers then all parameters specified shall have to be met treating auxiliary CTs as an integral part of the current transformer. The auxiliary CTs/reactor shall preferably be inbuilt construction of the CTs. In case these are to be mounted separately these shall be mounted in the LCC panel suitably wired upto the terminal blocks.
- j) The wiring diagram, for the interconnections of the three single phase CTs shall be provided inside the Secondary terminal box.
- k) The current transformers shall be suitable for high speed auto-reclosing.
- l) Provisions shall be made for primary injection testing either within CT or outside.
- m) All the current transformers shall have effective electromagnetic shields to protect against high frequency transients. Electromagnetic shields to be provided against high frequency transients typically 1-30 MHz.

## 10.2. VOLTAGE TRANSFORMERS

The voltage transformers shall conform to IEC- 61869 and other relevant standards except to the extent explicitly modified in the specification.

Voltage transformers shall be of the electromagnetic type with SF6 gas insulation. The earth end of the high voltage winding and the ends of the secondary winding shall be brought out in the terminal box.

10.2.1. **Ratios and Characteristics:** The rating, ratio, accuracy class, connection etc. for the voltage transformers shall be in accordance with Annexure 4 & Table 4A.

10.2.2. **Rating and diagram plates :** Rating and diagram plate shall be provided complying with the requirements of the IEC specification incorporating the year of manufacture and including turns ratio, voltage ratio, burden, connection diagram etc.

### 10.2.3. Secondary Terminals, Earthing

The beginning and end of each secondary winding shall be wired to suitable terminals accommodated in a terminal box mounted directly on the voltage transformer section of the SF6 switchgear.

All terminals shall be stamped or otherwise marked to correspond with the marking on the diagram plate. Provision shall be made for earthing of the secondary windings inside the terminal box.

10.2.4. The transformer shall be able to sustain full line to line voltage without saturation of transformer.

### 10.2.5. Constructional Details of Voltage Transformers :

- a) The voltage transformers shall be located as a separate bay module and will be connected phase to ground and shall be used for protection, metering and synchronization.
- b) The voltage transformers shall be of inductive type, nonresistant and shall be contained in their own-SF6 compartment, separated from other parts of installation. The voltage transformers shall be effectively shielded against high frequency electromagnetic transients. The supplier shall ensure that there is no risk of Ferro resonance due to the capacitance of the GIS.
- c) The voltage transformers shall have three secondary windings.
- d) Voltage transformers secondary shall be protected by Miniature Circuit breakers (MCBs) with monitoring contacts for all the windings. The secondary terminals of the VT's shall be terminated to preferably stud type non-disconnecting terminal blocks in the secondary boxes via the fuse.

- e) The voltage transformer should be thermally and dielectrically safe when the secondary terminals are loaded with the guaranteed thermal burdens.
- f) The accuracy of 0.2 on secondary III should be maintained throughout the entire burden range up to 50 VA on all the three windings without any adjustments during operation.
- g) The diagram for the interconnection of the VTs shall be provided inside secondary terminal box.
- h) It should be ensured that access to secondary terminals is without any danger of access to high voltage circuit.

### 10.3. Tests:

10.3.1. In accordance with the requirements in Section-GTR, Current Transformer and Voltage Transformer should have been type tested and shall be subjected to routine tests in accordance with relevant IEC.

10.3.2. The test reports of type tests, as applicable, as per IEC-61869-2 for CT, and IEC-61869-3 for IVT and following additional tests shall be submitted for the Employer's review. The type tests for which the procedure is under consideration as per above said IEC is not required to be considered.

- a) Current Transformers (CT): Transmitted over voltage test for 145kV and above voltage rating
- b) Inductive Voltage Transformers (IVT): Transmitted over voltage test for 145kV and above voltage rating

## 11. SURGE ARRESTORS

11.1. The surge arrestors shall conform in general to latest IEC –60099-4.

11.2. **Insulation co-ordination and selection of surge arrester:** The contractor shall be fully responsible for complete insulation co-ordination of switchyard including GIS. Contractor shall carry out detailed studies and design calculations to evolve the required parameters locations, energy capability etc. of surge arrestors such that adequate protective margin is available between peak impulse, surge and power frequency discharge voltages and BIL of the protected requirement. The locations of surge arrestors shown in single line diagram is indicative only. If the contractor feels that at some more locations the surge arrestors are required to be provided the same should also be deemed included in the offer.

The contractor shall perform all necessary studies and the report shall detail the limits of all equipment parameters which could affect the insulation co-ordination. The report shall also detail the characteristics of the surge arrester and shall demonstrate that the selected arrester's protective and withstand levels, discharge and coordinating currents and arrester ratings and comply with the requirement of this specification.

The contractor shall also consider in the studies the open circuit breaker condition, fast transients generated by slow operation of disconnecting switches. The study report and design calculations shall be submitted for Owner's approval.

### 11.3. Duty requirements of GIS Surge Arrestor

11.3.1. The surge arrestor shall be SF6 gas insulated metal oxide and gapless type. The metal housing of the arrestor shall be connected to the metal enclosure of the GIS with flange, bolted and gasketed joint so that the arrestor housing is grounded through GIS enclosure.

11.3.2. Surge arrestor shall be disconnect-link type and be attached to the gas-insulated system in such a manner that they can be readily disconnected from the system while the system is being dielectrically tested.

11.3.3. The surge arrester shall be of heavy duty station class and gapless (Metal oxide) type without any series or shunt gaps.

11.3.4. The surge arresters shall be capable of discharging over-voltages occurring during switching of unloaded transformers, reactors and long lines.

11.3.5. Surge arresters for the 765 kV network shall be capable of discharging of severe re-energisation switching surges on a 765kV line with surge impedance of 270hms and capacitance of 13 nF/Km.

765 kV class arrester shall be capable of discharging energy equivalent to class 5 of IEC for a 765 kV system on two successive operation followed immediately by 50 HZ energisation with a sequential voltage profile as specified below:

1000 kVp for 3 peaks

910 kVp for 0.1 Sec.

885 kVp for 1 Sec.

866 kVp for 10 Secs.

11.3.6. Surge arresters for the 400 kV network shall be capable of discharging of severe re-energisation switching surges on a 400 kV, 450 Km long line with surge impedance of 300 ohms and capacitance of 12 nF/Km and over voltage factor of 2.3 p.u at the arrestor terminals.

400 kV class arrester shall be capable of discharging energy equivalent to class 4 of IEC for a 400 kV system on two successive operation followed immediately by 50 HZ energisation with a sequential voltage profile as specified below:

650 kVp for 3 peaks

575 kVp for 0.1 Sec.

550 kVp for 1 Sec.

475 kVp for 10 Secs.

11.3.7. 245 & 145kV class arrester shall be capable of discharging energy equivalent to class 3 of IEC for 245 kV & 145 kV system respectively on two successive operations.

11.3.8. The reference current of the arresters shall be high enough to eliminate the influence of grading and stray capacitance on the measured reference voltage.

11.3.9. The surge arresters are being provided to protect the followings whose insulation levels are indicated in the table given below:-

Equipment to be protected	765kV system		400kV system		220KV system	132KV system
	Lightning impulse(kVp)	Switching surge (kVp)	Lightning impulse (kVp)	Switching surge (kVp)	Lightning impulse (kVp)	Lightning impulse (kVp)
Power Transformer	± 1950	± 1550	± 1300	± 1050	± 950	± 550
Instrument Transformer	± 2100	± 1550	± 1425	± 1050	± 1050	± 650
Reactor	± 1950	± 1550	± 1300	± 1050	-	-
CB/Isolator Phase to ground	± 2100	± 1550	± 1425	± 1050	± 1050	± 650
CB/Isolator Across open contacts	± 1300 (-/+457)	± 1200 (-/+653)	± 1425 (-/+240)	± 900 (-/+345)	± 1200	± 750

#### 11.3.10. Constructional Features

The nonlinear blocks shall be of sintered/infered metal oxide material. These shall be provided in such a way as to obtain robust construction, with excellent mechanical and electrical properties even after repeated operations.

The arrester enclosure shall be vertically or horizontally mounted to suit the layout of the switchgear as suggested by the supplier and each arrester shall be fitted with a Online continuous resistive leakage current monitoring system. The system shall be provided with an interface to integrate with the substation automation system.

The main grounding connection from the surge arrester to the earth shall be provided by the contractor. The size of the connecting conductor shall be such that all the energy is dissipated to the ground without getting overheated.

#### 11.4. Tests

- 11.4.1. In accordance with the requirements stipulated, the surge arrestors shall conform to type tests and shall be subjected to routine and acceptance tests in accordance with IEC document.
- 11.4.2. Each metal oxide block shall be tested for the guaranteed specific energy capability in addition to the routine/acceptance test as per IEC-60099.
- 11.4.3. Test on Surge Monitors: The Surge monitors shall also be connected in series with the test specimens during residual voltage and current impulse withstand tests to verify efficacy of the same. Additional routine/functional tests with one 100A and 10 kA current impulse, (8/20 micro sec.) shall also be performed on the surge monitor.
- 11.5. **Technical Parameters:** Technical parameters are as per Annexure 5.

#### 12. OUTDOOR SF6/Air BUSHINGS :

Outdoor bushings, for the connection of conventional external conductors to the SF6 metal enclosed switchgear, shall be provided where specified and shall conform to the requirements given in GTR.

The dimensional and clearance requirements for the metal enclosure will be the responsibility of the manufacturer and their dimensions must be coordinated with the switchgear.

Bushings shall generally be in accordance with the requirements of IEC -60137.

- 12.1. Insulation levels and Creepage distances: All bushings shall have an impulse and power frequency withstand level that is greater than or equal to the levels specified for GIS.

The creepage distance over the external surface of outdoor bushings shall not be less than 25 mm/kV and in highly polluted area it shall not be less than 31mm/kV (as per section- Project).

- 12.2. **Bushing types and fitting:** The details of bushing shall be as follows

SF6 to air Bushing shall be of Polymer / composite type and shall be robust and designed for adequate cantilever strength to meet the requirement of seismic condition, substation layout. The electrical and mechanical characteristics of bushings shall be in accordance with IEC: 60137. All details of the bushing shall be submitted for approval and design review.

Polymer / composite insulator shall be seamless sheath of a silicone rubber compound. The housing & weather sheds should have silicon content of minimum 30% by weight. It should protect the bushing against environmental influences, external pollution and humidity. The hollow silicone composite insulators shall comply with the requirements of the IEC publications IEC 61462 and the relevant parts of IEC 62217. The design of the composite insulators shall be tested and verified according to IEC 61462.

- 12.3. **Mechanical forces on bushing terminals:** Outdoor bushings must be capable of withstanding cantilever forces due to weight of bus duct (GIB) on one side & AIS conductor/Al tube on the other side and short circuit forces.
- 12.4. Type test reports as per applicable IEC including radio interference voltage (RIV) test shall be submitted in line with the requirement as specified in section GTR for approval.
- 12.5. The technical parameters of Bushing are as per **Annexure-6**

### **13. GIS TO CABLE TERMINATION (If applicable)**

- 13.1. This scope covers the supply, erection, commissioning of connection assembly of fluid-filled or extruded cables to gas-insulated metal enclosed switchgear (GIS) as per IEC 62271-209
- 13.2. The XLPE cables shall be connected to GIS by the interfacing of XLPE cable sealing end to GIS Cable termination enclosure.
- 13.3. The GIS to XLPE cable termination shall conform to IEC-62271-209.
- 13.4. The rating of XLPE cables for different voltages is specified in the Section project.
- 13.5. The limits of supply of gas-insulated metal-enclosed switchgear and the cable termination shall be in accordance with IEC 62271-209.
- 13.6. Cable termination and cable connection enclosure shall be suitable for the requirements for which it is designed. This interface section shall be designed in a manner which will allow ease of operation and maintenance.
- 13.7. The SF6 cable end unit and connection support structure should be equipped with provisions for isolating the cable sheath or pipe to permit cathodic protection of cable system.(see IEC62271-209)
- 13.8. The provision shall be made for a removable link. The gap created when the link is removed should have sufficient electric strength to withstand the switchgear high voltage site tests. The contractor may suggest alternative arrangements to meet these requirements. The corona rings/stress shields for the control of electrical field in the vicinity of the isolation gap shall be provided by the GIS manufacturer.
- 13.9. All supporting structures for the SF6 bus-duct connections between the XLPE cable sealing ends and the GIS shall be the scope of the contract. The supplier may specify alternative connecting & supporting arrangements for approval of the Employer.
- 13.10. The opening for access shall be provided in each phase terminal enclosures as necessary to permit removal of connectors to isolate the XLPE cables to allow carrying out the insulation tests. The general arrangement drawing of interconnecting bus-duct from GIS bay module to XLPE cable termination end shall also be submitted.

### **14. TRANSFORMER / REACTOR TERMINATION**

**14.1. TRANSFORMER / REACTOR Direct Connection with GIS (if applicable)**

- 14.1.1. The scope covers the supply, erection and commissioning of connection assembly of Oil filled Transformer to gas-insulated metal enclosed switchgear (GIS) as per IEC 62271-211.
- 14.1.2. The limits of supply of gas-insulated metal-enclosed switchgear and the direct connection to oil filled transformer shall be in accordance with IEC 62271-211.
- 14.1.3. The transformer / reactor termination module enables a direct transition from the SF6 gas insulation to the bushing of an oil-insulated transformer / reactor. For this purpose, the transformer/reactor bushing must be oil-tight, gas-tight and pressure resistant. Any temperature related movement and irregular setting of the switchgear's or transformer's/reactor's foundations are absorbed by the expansion fitting.
- 14.1.4. Terminal connection arrangement to connect GIS duct to bushing and duct mounting arrangement details shall be submitted during detailed engineering for Employer's approval and for co-ordination with transformer and reactor supplier. Any modification suggested by transformer and reactor supplier shall have to be carried out by the GIS supplier to facilitate proper connection with the bushings of the transformer and reactors.

**14.2. TRANSFORMER / REACTOR Connection with SF6/Air Bushing**

- 14.2.1. The oil filled transformers and reactors are as shown in the substation SLD. The oil to air bushings of the transformers and reactors shall be supplied by the respective Transformer/Reactor supplier and the same shall be connected to the SF6 ducts thru air to SF6 bushings to be provided under present scope.
- 14.3. In case of single phase Transformers/Reactors are being installed in the substation, HV&IV auxiliary bus for the Transformer/Reactor bank for connecting spare unit shall be formed inside the GIS hall as per the SLD furnished and as specified in Section project.

**15. LOCAL CONTROL CUBICLE (LCC)**

**15.1. Functions**

- 15.1.1. Each circuit-breaker bay shall be provided with a local control cubicle containing local control switches and a mimic diagram for the operation and semaphore/indicating lamp for status indication of the circuit-breaker and all associated isolators and earth switches together with selector switches to prevent local and remote and supervisory controls being in operation simultaneously.
- 15.1.2. Status indications in the LCC shall be semaphore type or LED type.
- 15.1.3. Closing of the circuit- breaker from the local control unit shall only be available when the breaker is isolated for maintenance purposes. Circuit-breaker control position selector, operating control switch and electrical emergency trip push button shall be installed in the Local Control Cubicle. Circuit-breaker control from this position will be used under

maintenance and emergency conditions only. The emergency trip push buttons shall be properly shrouded.

- 15.1.4. If Disconnect or earth switch is not in the fully open or closed position a "Control Circuit Faulty" alarm shall be initiated, and electrical operation shall be blocked.
- 15.1.5. 20% spare terminals shall be provided in each LCC apart from terminals provided for the termination and interconnection of all cabling associated with remote and supervisory control, alarms, indications, protection and main power supply etc .
- 15.1.6. Where plugs and sockets connect control cabling between the local control cubicle and the switchgear these shall not be interchanged. In plug in connector type cable arrangement, min 2 cores of the cable with connected condition on both side up to the TB to be left unused as spare.
- 15.1.7. Hydraulic/pneumatic and SF6 auxiliary equipment necessary for the correct functioning of the circuit breaker, isolators and earth switches shall be located in a separate cubicle compartment.
- 15.1.8. LCC shall be suitable for remote operation from substation automation system (SAS). Each gas tight compartment shall be monitored individually per phase basis through SAS

## 15.2. **Constructional features**

- 15.2.1. Local Control cubicle shall be either mounted on the GIS with front access or free standing, floor mounting type. It shall comprise structural frames completely enclosed with specially selected smooth finished, cold rolled sheet steel of thickness not less than 3 mm for weight bearing members of the panels such as base frame, front sheet and door frames, and 2.0mm for sides, door, top and bottom portions. There shall be sufficient reinforcement to provide level transportation and installation. Alternatively folded sheet panels of adequate thickness and strength is also acceptable.
- 15.2.2. Access to all compartments shall be provided by doors. All fastenings shall be integral with the panel or door and provision made for locking. Cubicles shall be well ventilated through vermin-proof louvers(if required) having anti insect screen. All doors shall be gasketed all around with suitably profiled Neoprene/EPDM/PU gaskets conforming to the provision of IS 11149. However, XLPE gaskets can also be used for fixing protective glass doors.
- 15.2.3. For LCC panel of each feeder bay (i.e. line, transformer, and reactor etc.), Bus Coupler bay and Bus Sectionalizer bay, separate AC/DC supply for power circuit of GIS switchgear shall be provided, fed directly from ACDB/DCDB. The control DC supply (for control, interlocking, signaling) shall be tapped from respective relay & protection panel. For LCC panel illumination and heating purpose Loop in Loop out AC Supply can be provided.
- 15.2.4. Each panel shall be provided with necessary arrangements for receiving, distributing and isolating of DC and AC supplies for various control, signaling, lighting and space heater circuits. The incoming and sub-circuits shall be separately provided with Fuses/MCBs. All fuses shall be HRC cartridge type conforming to IS: 13703 mounted on plug-in type fuse

bases. The short time fuse rating of Fuses shall be not less than 9 KA. Fuse carrier base shall have imprints of the fuse 'rating' and 'voltage'.

15.2.5. Each LCC Panel shall be provided with the following

1. **Plug Point:** 240V, Single phase 50Hz, AC socket with switch suitable to accept 5/15 Amps pin round standard Indian plug, shall be provided in the interior of each cubicle with ON-OFF switch.
2. **Interior Lighting:** Each panel shall be provided with a door-operated LED lighting fixture rated for 240 Volts, single phase, 50 Hz supply for the interior illumination of the panel controlled by the respective panel door switch.
3. **Space Heater:** Each panel shall be provided with a thermostatically connected space heater rated for 240V, single phase, 50 Hz AC supply for the internal heating of the panel to prevent condensation of moisture. The fittings shall be complete with switch unit.

15.2.6. Operating mechanisms, auxiliary switches and associated relays, control switches, control cable terminations, and other ancillary equipment shall be accommodated in sheet steel vermin proof cubicles.

15.2.7. The arrangement of equipment within cubicles shall be such that access for maintenance or removal of any item shall be possible with the minimum disturbance of associated apparatus. All the control switches shall be internal i.e. installed behind a lockable glass door, that allows a complete view of the annunciator and mimic diagram when the LCC door is closed. Necessary protection shall be provided to avoid inadvertent operation of control switches.

15.2.8. An interlocking scheme shall be provided that takes into account the following basic requirements.

- To safeguard maintenance personnel who may be working on one section of the equipment with other sections live.
- prevent incorrect switching sequences that could lead to a hazardous situation to plant, equipment and personnel.

15.2.9. Electrical bolt interlocks shall be energized only when the operating handle of the mechanism is brought to the working position. Visible indication shall be provided to show whether the mechanism is locked or free. Means, normally padlocked/handle lock, shall be provided whereby the bolt can be operated in the emergency of a failure of interlock supplies.

15.2.10. Where key interlocking is employed tripping of the circuit breaker shall not occur if any attempt is made to remove the trapped key from the mechanism. Any local emergency-tripping device shall be kept separate and distinct from the key interlocking.

15.2.11. Disconnecting switches shall be so interlocked that they cannot be operated unless the associated circuit-breaker is open except that where double bus bar arrangements are specified, on-load transfer of feeder circuits from one bus bar to another shall be made

possible by interlocks which ensure that the associated bus coupler and its isolators are closed.

- 15.2.12. Bus coupler circuit breaker shall be interlocked so that it shall not be possible to open a bus coupler circuit breaker while on load change over on that side of the breaker is in progress.-
- 15.2.13. All isolating devices shall be interlocked with associated circuit-breakers and isolators in the same station so that it shall not be possible to make or break current on an isolating device unless a parallel circuit in that station is already closed.

### **15.3. Cabling between LCC Panel and GIS equipment**

- 15.3.1. The unarmored screen cable shall be of 1.1kV grade, multi core, annealed copper conductor, Tinned copper braided screen (approx. 85% coverage).
- 15.3.2. The core insulation and outer sheath of cable shall be of halogen-free special polymer.
- 15.3.3. The cable shall be flame-retardant, flexible, abrasion-and wear-resistant.
- 15.3.4. The size of core shall not be less than 2.5 sq. mm for instrument transformers and 1.5 sq. mm for other control cable.
- 15.3.5. Prefabricated cables with heavy duty multi-point plug-in connections on GIS end shall be provided.
- 15.3.6. All instrument transformer connections shall be hard wired to terminal block via ring type connection.

## **16. GIS BUILDING**

- 16.1. The buildings shall house each voltage class Gas Insulated Switchgear (GIS) and other associated equipment inside each of the GIS buildings. GIS building(s) shall be constructed for the specified number of bays/diameters as per section project.
- 16.2. For finalizing the dimensions of GIS building the requirement of Turning radius to rotate the largest removable component for assembly/disassembly shall be taken in to consideration.
- 16.3. Wherever GIS Building of already exists, then the existing GIS Building(s) for respective voltage class shall be suitably extended keeping the width of the building same to accommodate the number of bays/diameters as specified in the Section Project/BPS.
- 16.4. The contractor shall submit the design & construction proposal of the building along with necessary information, data, and drawings during the detailed engineering according to the complete requirements.
- 16.5. The area for GIS Building(s) is indicated in the BPS. The area given is for reference only and may vary according to the requirement of the equipment to be installed inside. The

contractor shall finalize the dimensions according to the equipment offered by them providing enough space & access for erection, operation and maintenance.

- 16.6. The contractor shall place their panels i.e. Bay level units, bay mimic, relay and protection panels, RTCC panels, Communication panels etc. in a separate Relay Panel Room in the GIS building. The size of the room shall be such that all the panels for the bays/ diameters as per clause 16.1 shall be accommodated in the above room. The panel room shall be air-conditioned. Further, the temperature of the room shall be monitored through substation automation system by providing necessary temperature transducers.

**17. ELECTRIC OVERHEAD CRANE :**

- 17.1. Two EOT Cranes for 765 kV GIS hall and One EOT cranes for 400 kV GIS hall of suitable capacity shall be provided for erection & maintenance of largest/heaviest GIS component/assembly. The crane shall consist of all special requirements for erection & maintenance of GIS equipment.
- 17.2. The capacity of the crane shall be sized to lift the heaviest GIS switchgear component.
- 17.3. The Crane shall be used for the erection and maintenance of the GIS switchgear components installed in the GIS switchgear room. On completion of erection of the switchgear, the Contractor shall completely service the crane before the Taking Over Certificate is issued.
- 17.4. Crane hook approaches shall be of the minimum possible dimensions to ensure maximum coverage of the GIS building area.
- 17.5. The crane(s) shall be capable of lifting and accurately positioning all loads ranging from full crane rated capacity to at least 10% rated capacity.
- 17.6. Crane shall be designed for operation under following variable speeds through VVVF drives at full load :
- Hoisting: 0.3 – 3 Meters per Minute  
Cross Travel: 1.6 – 16 Meters per Minute  
Long Travel: 2.0 – 20 Meters per Minute
- 17.7. The electric overhead cranes shall be provided with walkways, platforms. shall be provided along the bridge rails and on the crab of EOT crane to facilitate cleaning/maintenance of the crane and to give access to the GIS room high bay lighting and ventilation duct and grilles.
- 17.8. The platform and walkways shall be designed to support any weight to be imposed upon them during crane overhaul.
- 17.9. An access platform shall be provided together with a guarded ladder to allow access to the bridge rails.
- 17.10. The crane shall be provided with pendant control and RF control.

- 17.11. Contractor shall submit the capacity calculation of crane for GIS hall considering a factor of safety of rope as at least 5.
- 17.12. The Capacity of Cranes to be provided for GIS Hall shall confirm following.
- a) The crane for 765kV GIS hall shall have capacity of minimum 12.5T safe working load & minimum hook height of crane has shall be 10.0 meters or as per actual requirement whichever is higher.
  - b) The crane for 400kV GIS hall shall have capacity of minimum 6T safe working load & minimum hook height of crane have shall be 9.0 meters or as per actual requirement whichever is higher.
  - c) The crane for 220kV GIS/132kV GIS shall have capacity of minimum 5T safe working load & minimum hook height of crane have shall be 8.0 meters or as per actual requirement whichever is higher.
- 17.13. In case the GIS hall is to be extended, the scope of work also involves extension of EOT crane girders and all necessary Electrical & Mechanical accessories to facilitate movement of existing EOT crane in the extended portion of GIS hall. Cost of the same shall be deemed to be covered in the building cost.
- 17.14. The following tests shall be carried out on EOT Crane.
- 1. The crane shall be tested at manufacturer work under full load and 25 percent overload of hoisting and cross transverse motions as a routine test.
  - 2. Further the following tests may be done at site after installation of the crane at site
    - a. Check all the accessories for proper function
    - b. No load test
    - c. Load test as per site conditions

**18. SEISMIC DESIGN CRITERIA:**

- 18.1. The equipment shall be designed for operation in seismic zone for earthquake resistance. The seismic loads are due to the horizontal and vertical acceleration which may be assumed to act on concurrently. Seismic Qualification requirements shall be as per IEC 62271-207 for the design of equipment. The equipment along with its parts shall be strong enough and sufficiently well connected to resist total operating stresses resulting from the forces in normal operation, but in case of abnormal condition shall also resist with forces superimposed due to earthquakes. Test Report/Analysis Report should be furnished.

**19. DESIGN REVIEW**

- 19.1. Design reviews shall be conducted by Employer; however the entire responsibility of design shall be with the supplier.
- 19.2. Employer may also visit to the supplier's works to inspect design, manufacturing and test facilities.

- 19.3. The design review will commence after placement of award with the successful contractor and shall be finalized before commencement of manufacturing activity. These design reviews shall be carried out in detail to the specific design with reference of the GIS under the scope of this specification. Employer reserve the right to waive off the design review during detailed engineering.
- 19.4. The design review shall be conducted generally following the, “User Guide for the application of Gas Insulator Switchgear (GIS) rated voltage of 72.5kV and above” – CIGRE report No. 125 prepared by CIGRE Working Group 23.10.
- 19.5. The manufacturer will be required to demonstrate the use of adequate safety margins for thermal, mechanical, dielectric, insulation coordination and vibration etc. design to take into the account the uncertainties of his design and manufacturing processes.
- 19.6. The scope of such a design review shall at least include the following:

1.	Dielectric Stress of Solid Insulation like Gas Barrier, support insulator etc.
2.	Dielectric stress of SF6 Gas Volume.
3.	Mechanical strength of enclosure, expansion joints etc.
4.	Criteria for providing expansion joint.
5.	Sealing system
6.	Insulation coordination
7.	Thermal stress and resulting increase in gas pressure during short circuit condition.
8.	Earthing of enclosure w.r.t circulating current.
9.	Seismic design, as per IEC 62271-207
10.	Circuit Breaker.
11.	Isolator and Earth switch.
12.	Voltage transformer.
13.	Current Transformer.
14.	Surge Arrester.
15.	Bushing.
16.	Ducting.
17.	Corrosion protection.
18.	Electrical and physical Interfaces with substation.
19.	Testing capabilities.
20.	Inspection and test plan.
21.	Transport and storage.
22.	Maintainability.
23.	Site Test.

19.7. Further, the manufacturer shall furnish the following information during detailed engineering:

- a) Study report of VFTO generated for GIS installation for 400 kV and above.
- b) Calculation for adequacy of UHF sensors to be provided in GIS Installation as per clause no 5.41.
- c) The calculations and documents in support of the average intensity of electromagnetic field on the surface of the enclosure.
- d) Calculations to show that there is no Ferro resonance due to capacitance of GIS for the voltage transformers.
- e) Calculations in support of touch & step voltages in all enclosures and earthing of complete GIS installation.
- f) Measures to mitigate transient enclosure voltage by high frequency currents.
- g) The acceptance criteria and limits of impact (of impact recorder) in all three directions which can be withstood by the equipment during transportation and handling.

## 20. TYPE TESTS

The offered GIS equipment shall conform to the type tests as per IEC-62271-203. Contractor shall submit type test reports for the following type tests & additional type tests.

Sl.	Description of the Type Test for GIS
1	Tests to verify the insulation level of the equipment and dielectric test on auxiliary circuits
2	Tests to prove the temperature rise of any part of the equipment and measurement of the resistance of the main circuit
3	Tests to prove the ability of the main and earthing circuits to carry the rated peak and rated short time withstand current
4	Tests to verify the making and breaking capacity of the included switching devices
5	Tests to prove the satisfactory operation of the included switching devices
6	Tests to prove the strength of the enclosures
7	Gas tightness tests
8	Tests on partitions
9	Tests to prove the satisfactory operation at limit temperatures
10	Tests to assess the effects of arcing due to internal fault
11	Verification of the degree of protection of the enclosure
12	Tests to prove performance under thermal cycling and gas tightness tests on insulators
13	Additional tests on auxiliary and control circuits
14	Reactor current switching test For Reactive Current switching capability as per Clause 6.4.1

15	Test to demonstrate the Power frequency withstand capability of breaker in open condition at lock out pressure.
16	Electromagnetic compatibility tests (if applicable)
17	Radio inference voltage tests

The test reports of the above type tests for GIS (including type test report on Circuit breaker, Disconnect Switch, Grounding switches, Current and Voltage transformers as per relevant IEC and type tests of SF6/Air & Oil bushing as per IEC 60137 shall be submitted for approval as per Section- GTR, Technical Specification.

**21. MISCELLANEOUS**

21.1. **Painting of enclosure:** All enclosures shall be painted externally as per manufacturer’s painting procedure.

21.2. **Heaters:** Wherever required, heaters shall be provided to prevent moisture condensation inside various Marshaling boxes.

21.3. **Identification & rating plate**

Each bay shall have a nameplate showing

- a) Each module will have its own Identification & rating plate. The rating plate marking for each individual equipment like Circuit breaker, Disconnect Switch Grounding switches, Current transformer, Voltage transformers, Surge arrester etc shall be as per their relevant IEC.
- b) A schematic diagram indicating their relative locations.

**22. TRANSPORT OF EQUIPMENT TO SITE**

The contractor shall be responsible for the loading, transport, handling and offloading of all equipment and materials from the place of manufacture or supply to site. The contractor shall be responsible to select and verify the route, mode of transportation and make all necessary arrangement with the appropriate authorities as well as determining any transport restrictions and regulations imposed by the government and other local authorities. All transport packages containing critical units viz Circuit breakers and Voltage transformers shall be provided with sufficient number of impact recorders (on returnable basis) during transportation to measure the magnitude and duration of the impact in all three directions. In case of electronic impact recorder, the recording shall commence in the factory and must continue till the units reach site. The data of electronic impact recorders shall be downloaded at site and a soft copy of it shall be handed over to Engineer – in –charge. Further, contractor shall communicate the interpretation of the data within three weeks.

### **23. PACKING, STORAGE AND UNPACKING**

- 23.1. All the equipment shall be carefully packed for transport by sea, rail and road in such a manner that it is protected against the climatic conditions and the variations in such conditions that will be encountered enroute from the manufacturer's works to the site.
- 23.2. The SF6 metal clad equipment shall be shipped in the largest factory assembled units that the transport and loading limitations and handling facilities on site will allow to reduce the erection and installation work on site to a minimum.
- 23.3. Where possible all items of equipment or factory assembled units shall be boxed in substantial crates or containers to facilitate handling in a safe and secure manner. Should the units be considered too large for packing in crates, they shall be suitably lagged and protected to prevent damage to any part, particularly small projections, during transport and handling. Special lugs or protective supports shall be provided for lifting to prevent slings and other lifting equipment from causing damage. Each crate, container or shipping unit shall be marked clearly on the outside to show where the weight is bearing and the correct position for the slings.
- 23.4. Each individual piece to be shipped, whether crate, container or large unit, shall be marked with a notation of the part or parts contained therein.
- 23.5. Special precautions shall be taken to protect any parts containing electrical insulation against the ingress of moisture. This applies particularly to the metal clad equipment of which each gas section shall be sealed and pressurized prior to shipping. Either dry nitrogen/air or dry SF6 gas shall be used and the pressure shall be such as to ensure that, allowing for reasonable leakage, it will always be greater than the atmospheric pressure for all variations in ambient temperature and the atmospheric pressure encountered during shipment to site and calculating the pressure to which the sections shall be filled to ensure positive pressure at all times during shipment.
- 23.6. Blanking plates, caps, seals, etc., necessary for sealing the gas sections during shipment to site which may on later stage necessarily be used during repair and maintenance shall remain the property of POWERGRID. Balance blanking plates, caps, seals, etc shall be returnable to the contractor. If considered necessary, blanking plates or other sealing devices shall be provided with facilities for measuring the gas pressure and recharging at any time during the transport period. Any seals, gaskets, 'O' rings, etc. that may be used as part of the arrangement for sealing off gas sections for shipment of site, shall not be used in the final installation of the equipment at site. Identification numbers shall be stamped into the blanking plates, etc., and on the switchgear equipment to which they are fitted so that they can easily be identified and refitted should it ever be necessary to ship sections of the switchgear back to the manufacturer's works for repair.
- 23.7. Valves and other gas couplings associated with the switchgear gas systems shall be adequately protected against damage from any bumps or physical blows. They shall also be capped to prevent ingress of dirt or moisture or damage to any coupling, pipes, threads or special fittings. Any explosion vents and other pressure relief devices, shall be suitably

sealed and protected to prevent accidental exposure of the sealed sections during shipment to site.

- 23.8. For bus ducts involving male and female joints of the current carrying conductor, the same shall be transported in disassembled condition to avoid any damage during transit. All bright parts liable to rust shall receive a coat of anti rusting composition and shall be suitably protected.
- 23.9. The contractor shall ensure that during the period between arrival at site and erection, all materials and parts of the contract works are suitably stored in such approved manner as to prevent damage by weather, corrosion, insects, vermin or fungal growth. The scope of providing the necessary protection, storing on raised platform, as required etc. is included in the works to be performed by the contractor. Cost of the raised platform for temporary storage is deemed to be included in overall cost. The raised platform needs to be made ready before arrival of GIS equipment at site. The contractor may use the available storage areas at site with permission of site in charge.
- 23.10. The equipment shall be unpacked immediately before Installation. They shall not be left lying unnecessarily in open crates or containers. Special precautions shall be taken when gas sections which have been sealed and pressurized for shipping are opened up to reduce the ingress of dirt and atmospheric moisture to a minimum. Whenever possible this shall only be done immediately prior to installation and if any section is to be left outside for any length of time after being opened, it shall be resealed and pressurized with either dry nitrogen or SF6 gas until required.
- 23.11. For the purpose of release of payment linked to receipt and physical verification in case of GIS equipment it shall mean random opening and physical verification of one number of packing unit of each type of main equipment (i.e. GIS CB/ISO/ES/PT/LA etc.) for each voltage level. Thereafter proper re-packing of the GIS unit shall be ensured as per manufacturer recommendation.

## **24. INSTALLATION OF GIS**

- 24.1. Civil works of GIS Hall shall be completed in all respects before taking up the installation and it shall be ensured that Ventilation System is operational and all dust and dirt in the hall are removed. The GIS hall needs to be in positive pressure before starting Installation.
- 24.2. The installation area shall be secured against entry of unauthorized personnel. Only certified manufacturer's engineer and supervisor shall undertake the erection works. Engineers and supervisors of the manufacturer shall submit authorization and competency certificate to POWERGRID.
- 24.3. Un-packaging of GIS modules shall be done outside the GIS hall and in no case module to be taken inside GIS hall with packing.
- 24.4. All assembly work shall be done by qualified personnel only who are to be identified and list submitted to POWERGRID site before starting of erection work.

- 24.5. Assembly drawing for GIS erection for the section under progress shall be available and displayed in GIS hall at the time of erection work.
- 24.6. Working personnel shall clean their shoes or apply covers on shoes before entering the immediate working area. The working clothes of authorized personnel shall be made of non-fluffy material.
- 24.7. GIS hall door shall have automatic close facility after entry of personnel to avoid dust and moisture entry. Walls and ceiling shall be in a condition so that neither dirt nor plaster might fall or rub off and formation of condensation water in ceiling shall be prevented under any circumstances.
- 24.8. Floor in the installation area shall have a firm surface and shall be kept dust free with a vacuum cleaner. Vacuum cleaning to be done on regular basis.
- 24.9. Only T&P and consumables required for GIS erection shall be kept in GIS during erection.
- 24.10. In case of outdoor installation of GIS or of GIS components open gas compartments shall be protected from dust and moisture ingress (by tarpaulin covers/protective enclosure/chamber etc)
- 24.11. Bus duct exits in the GIS hall's wall shall be kept covered by suitable means until permanent cover is provided after installation of bus ducts.
- 24.12. Maintenance room (as a part of LCR room) shall be constructed for carrying out repair works/ small part assembly. All excess material (not required for immediate installation works) test equipment and tools and tackles to be stored separately from GIS hall in this room for rework.
- 24.13. Erection agency shall submit method statement and make available formats for checking during each stage of hall preparation, assembly process and final checks to be approved by POWERGRID site before start of erection. Shock recorder down loaded data and analysis shall be submitted preferably before commencement of erection work. In case of violation of shock limits, expert from manufacturer shall visit and do the joint internal inspection and shall submit analysis report before giving clearance for erection. If required the module shall be taken back to factory for further analysis and testing.
- 24.14. Cleaning is of utmost importance and hence before assembly, all the loose metal parts, subassemblies and all contact & sealing surfaces shall be cleaned before installation. Cleaning shall be carried out with specified cleaning agents of the manufacturer, in no condition water is to be used except for external surfaces. Further, prior to opening of gas compartment, the same shall be thoroughly cleaned externally. The vacuum cleaning of the installation area shall also be done specially the immediate vicinity of the flanges to be connected.
- 24.15. All Civil Work inside building including internal cable trench shall be completed before GIS installation.

- 24.16. Installation of flanges shall be done immediately after removal of transport covers. Transport covers, O-rings and other packing material of GIS shall be taken out immediately after removal.
- 24.17. O Rings shall be properly stored and taken out only before installation. O Rings are also to be cleaned before use with manufacturer authorized cleaning agent.
- 24.18. At all points of time during installation authorized personnel shall use suitable gloves to avoid contamination.
- 24.19. Cable termination work shall commence only after completion of GIS equipment erection, as during GIS installation period laying and termination of cables interferes with the GIS erection work and affects cleanliness.
- 24.20. Approved Field Quality Plan shall be followed during site work.

## **25. ON SITE TESTING**

After the GIS Switchgear has been fully installed at site and SF6 gas filled at rated filling density, the complete assembly shall be subjected to the site tests as per IEC-62271-203 and POWERGRID Asset Management Controlled Document No: D-3-01-09-01-01. After the above, Special Dielectric test (Switching Impulse test) shall be conducted for 765 kV GIS with the test voltages specified below:-

- 25.1. Application of Power Frequency voltage test for duration of 1 minute with the value 760 kV (r.m.s.) as per IEC 62271-203.
- 25.2. Directly after the above test at 25.1, Switching impulse test with three impulses of each polarity and with the value 1240 kVp(80 % of the rated switching Impulse withstand level) as per IEC 62271-203.
- 25.3. In case of a disruptive discharge in the gas as outlined in clause no: C.6.2.2 Procedure b), Annexure-C of IEC 62271-203 during the AC voltage test and a repeat test is performed due to this failure, then the repeat test shall be carried out at Specified voltage.
- 25.4. In case of a disruptive discharge in the gas as outlined in clause no: C.6.2.2 Procedure b) Annexure-C of IEC 62271-203 during Oscillating Switching Impulse Test and a repeat test is performed due to this failure then the repeat test shall be carried out at a value equal to 90 % of the rated switching Impulse withstand level.
- 25.5. Method statement/ procedure of ON SITE high voltage testing, PD measurement and Switching Impulse test shall be submitted by contractor in advance.

## **26. MANDATORY SPARE**

Design, engineering, manufacture, testing, supply on FOR destination site basis including transportation & insurance, storage at site of Mandatory spares for the GIS(As specified in BPS). Standard list of Mandatory Spares is as per **Annexure-10**

## 27. TESTING & MAINTENACE EQUIPMENT

Testing & Maintenance equipment shall be offered, as per relevant schedule of BPS.

### 27.1. SF6 Gas leakage detector.

The detector shall be portable, battery operated, hand held type and having a minimum SF6 gas leakage sensitivity of 5gm/year. The sensor shall be connected through a flexible wand for easy accessibility to joints, seals and couplings in GIS equipment and provided with a protection filter. The equipment shall have on/off switch & suitable indicating lamps/LEDs, variable pitch audible signal for leakage indication. The equipment shall have automatic zeroing of background signals suitable for detecting SF6 gas leakage in charged switchyard. The test kit shall be compatible for EMI/EMC environment as per IEC 1000.

### 27.2. Gas filling and evacuating plant : (Gas Processing unit)

- The plant necessary for filling and evacuating the SF6 gas in the switchgear shall be supplied to enable any maintenance work to be carried out. This shall include all the necessary gas cylinders for temporarily storing the evacuated SF6 gas. The capacity of the temporary storage facilities shall at least be sufficient for storing the maximum quantity of gas that could be removed from at least one phase of one complete bay (switchgear and associated equipment).
- Where any item of the filling and evacuating plant is of such a weight that it cannot easily be carried by maintenance personnel, it shall be provided with lifting hooks for lifting and moving with the overhead cranes.
- The minimum capacity parameters of evacuation plant will be as under :
 

Oil Free Suction (Recovery) Pump:	30 M <sup>3</sup> /Hour
Compressor (Two Stage):	15 M <sup>3</sup> /Hour
Oil Free Vacuum Pump:	100 M <sup>3</sup> /Hour
- The evacuation equipment shall be provided with all the necessary pipes, couplings, flexible tubes and valves for coupling up to the switchgear for filling or evacuating all the gases.  
Details of the filling and evacuating plant that will be supplied, as well as the description of the filling and evacuating procedures shall be furnished

### 27.3. SF6 gas analyzer:

The SF6 gas analyser should be of portable type and instruments shall have following features:

- a. In-built calibration facility.
- b. Sensitivity of the equipment shall not be affected by any atmospheric conditions like dust, humidity, heat, wind etc.

- c. Equipment shall work on zero gas loss principle i.e. gas should be pumped back to the compartment after measurement without any exposure to the atmosphere.
- d. Equipment shall be supplied with suitable regulator which can be used to connect SF6 cylinder if required.
- e. Following acidic/impurities products should be detected as per IEC 60480 and IEC 60376
  - i) SF6 purity – Range: 0-100 % & Accuracy: +/- 2 deg
  - ii) Dew point - Range : -60 to +20 deg C & Accuracy: +/- 4 deg C
  - iii) SO2 - Range : 0-150 ppm & Accuracy : +/- 2 %
  - iv) HF - Range : 0-10ppm & Accuracy : +/- 10 %
- f. Instrument should work on AC source as well as on rechargeable battery
- g. Input pressure: upto 10 bar
- h. It should be housed in a robust IP67 case with wheels

**27.4. Portable Partial Discharge(PD) monitoring system (Shall generally applicable for 220kV&132 kV)**

- The equipment shall be used for detecting different types of defects in Gas Insulated Stations (GIS) such as Particles, Loose shields and Partial Discharges as well as for detection of Partial discharges in other types of equipment such as Cable Joints, CTs and PTs.
- It shall be capable for measuring PD in charged GIS environment as EHV which shall have bandwidth in order of 100 MHz–2GHz with possibility to select a wide range of intermediate bandwidths for best measurement results. The principle of operation shall be based on UHF principle of detection. The instrument should also be able to detect partial discharges in cable joints and terminations.
- Detection and measurement of PD and bouncing particles shall be displayed on built in large LCD display and the measurement shall be stored in the instrument and further downloadable to a PC for further analysis to locate actual source of PD such as free conducting particles, floating components, voids in spacers, particle on spacer surfaces etc. Software for display and diagnosis of PD signals and an expert software system for accurate interpretation of cause of PD shall also be supplied and installed by the contractor.
- The equipment shall meet the following requirements
  - 1. Measurement shall be possible in noisy environment.
  - 2. Stable reading shall be possible in presence of vibrations within complex GIS assemblies, which can produce signals similar to PD.
  - 3. Equipment should have necessary synchronizing circuits to obtain PD correlation with power cycle and power frequency.
  - 4. The equipment shall be battery operated with built-in-battery charger. It shall also be suitable for 230V AC/50 Hz input.

5. Measurement shall be possible in the charged switchyard in the presence of EMI/EMC. Supplier should have supplied similar detector for GIS application to other utilities. Performance certificate and the list of users shall be supplied along with the offer.
  6. Instrument shall be supplied with standard accessories i.e., re-locatable sensors with mounting arrangements, connecting cables (duly screened) to sensors, Lap-top PC, diagnostic and expert interpretation software, carrying case, rechargeable battery pack with charger suitable for 230V AC, 50Hz supply connecting cables (duly screened) to view in storage.
  7. The function of software shall be covering the following:
    - a) Data recording, storage and retrieval in computer
    - b) Data base analysis
    - c) Template analysis for easy location of fault inside the GIS
    - d) Evaluation of PD measurement i.e, Amplitude, Phase Synchronization etc.
    - e) Evaluation of bouncing/loose particles with flight time and estimation on size of particle.
    - f) Expert software system for accurate interpretation of cause of PD.
    - g) Report generation.
  8. To prove the suitability in charged switchyard condition, practical demonstration shall be conducted before acceptance.
  9. Supplier shall have “Adequate after sales service” facility in India and shall provide the document in support of this.
  10. Necessary training may be accorded to personnel to make use of the kit for locating PD sources inside the GIS
  11. Instrument shall be robust and conform to relevant standard.
- **Calibration:** The UHF Couplers have to be first calibrated as per CIGRE Document No. 654 as part of factory acceptance tests to guarantee detection sensitivity of 5pC or better. The GIS of same design shall be used as test specimen during the coupler calibration. The pulse injection level determined through above factory calibration tests shall only be used as reference for site sensitivity checks during commissioning of PDM system. The data sheet/frequency response characteristics shall be submitted for reference.
  - Pulse generator, same type as that of used during factory testing for UHF sensor sensitivity test shall be supplied as a standard accessory.

#### **27.5. Online Partial Discharge Monitoring System (Applicable for 765kV & 400 kV GIS)**

- GIS equipment shall be designed so as to minimize partial discharge or other electrical discharge. A state-of-the art Partial Discharge Monitoring system shall be provided to monitor the entire GIS installation.

- An on-line continuous Partial Discharge Monitoring (PDM) system shall be designed to provide an automatic facility for the simultaneous collection of PD data at multiple points on the GIS & its associated GIB ducts and Voltage Transformers adopting UHF technique. The data stored shall provide a historical record of the progress of PD sources and shall identify the areas of maximum activity.
- On-line continuous Partial Discharge Monitoring (PDM) system shall be capable for measuring PD in charged GIS environment as EHV which shall have bandwidth in order of 100 MHz–2GHz with possibility to select a wide range of intermediate bandwidths for best measurement results. The principle of operation shall be based on UHF principle of detection.
- The scope shall cover Engineering, supply, installation, testing and commissioning of partial discharge continuous monitoring system, with all necessary auxiliaries and accessories to make a complete system as per technical specification, including site demonstration of successful operation. Any items/accessories necessary to make the system fully functional for the trouble free online PD monitoring of complete GIS installation shall be considered as included in the scope.

The PDM system shall be provided with all its hardware and software, with readily interfacing to the UHF PD couplers installed in the GIS of present bays and future bays as shown in SLD plus 20% additional as extra. Details of this shall be submitted during engineering stage for approval.

The integration of UHF PD coupler in future GIS bays shall be done in respective package. The number of UHF PD coupler for future bays shall be decided based on GIS layout finalized under present scope (considering present GIS equipment with future provision).

The PD Monitoring PC Work Station shall be housed in a lockable cabinet with duplicate keys and shall be located in the control room of the GIS substation. Workstation PCs shall be pre-loaded with all necessary Hardware & Software. The PCs shall have each Combo drive & Retrievable disk drive (1 TB), Ethernet port 100Mbps, printer. The workstation PC shall be powered by suitable dedicated UPS and same is included in the present scope.

- Design of on-line PDM System
  1. The technical proposal for PDM system along with detailed design documentation shall be submitted for EMPLOYER'S approval during engineering stage.
  2. To guarantee that sufficient coverage is available for complete GIS installation to monitor PD activity all design details shall be submitted as part of the above for review.
  3. The sensitivity of the offered system shall be in accordance with CIGRE Document No. 654 that will be verified as part of site sensitivity tests.

4. UHF attenuation data of GIS shall be submitted for the switching devices, spacers, bends etc.
5. The signal attenuation level of co-axial cable per meter length and justification for the length of cable connection between the couplers and detector units shall be furnished.
6. The overall sensitivity of PD detection system shall take into account the spacing between couplers and the associated cabling, filters, amplifiers, etc.
7. The Sub-station GIS layout as a separate drawing indicating position of spacers, spread over of PD sensors with distance, sensor identification, the detector unit identification etc. shall be submitted during engineering stage for approval.
8. The PD sensors shall be identified / coordinated with the corresponding detector unit etc. with proper identification labeling and indicated in the substation PDM SLD.
9. Internal arrangement/wiring diagram is to be submitted for detector units/control cabinet etc. All internal items are to be identified / labeled to facilitate troubleshooting.
10. Supply requirement (AC & DC) to be specified for the complete monitoring system.
11. Power supply to PDM PC shall have protection against surges, overload and short circuit. A dedicated on-line UPS system shall also be provided as a backup during supply interruption, to ensure trouble-free & reliable running of the PDM System for a minimum of 15 minutes duration. Ratings of UPS shall be proposed for the approval of EMPLOYER'S. The UPS shall have enough capacity to initiate a 'safe' shut down of the PDM PC and the peripherals after this 15-minute period if normal supply fails to resume. The PDM PCs shall restart automatically on resumption of normal supply. The UPS shall not generate spikes during changeover of supply. UPS shall automatically give indication / alarm when it requires battery replacement. Potential Free Contacts shall be generated to signal these events. These contacts shall be wired out to Annunciation / Monitoring systems. Alternately, inverter of suitable capacity is also acceptable. Critical Process and Status alarms of the PDM system shall be displayed.
12. PDM System shall be provided with a user security for accessing the system with a log-on and password entry procedure. The user levels shall be defined as a Master User and other users for the modification of system, update, and entry of parameters or manual operation. System shall be able to generate 3D point on wave pattern whenever any PD activity detected by the system. System shall be able to give online 3D point on wave pattern, online PRPD (phase resolved PD) and online short time trend etc. System shall be able to generate the all the logs related to system fault, system access, PD event, and any changes in system setting etc.
13. Method of electrical isolation/protection provided between PD sensor and detector circuitry in case of flashover/high potential stress inside GIS should be furnished.
14. The selected mode of propagation of PD signal (electromagnetic wave) inside GIS for the design of sensors shall be furnished.
15. The protection available for electronics against transient over voltages caused by switching operations shall be furnished.

16. The capacity of each detector unit to be specified to accommodate as many numbers of PD sensors signal.
  17. The applicable standards to meet IEC & IEEE requirements for electromagnetic compatibility shall be specified. The offered system should have been tested for the same for working in a 400kV & above substation environment. The necessary documentation has to be submitted in this regard.
  18. Guaranteed technical particulars & data sheet for various components used in the system shall be submitted.
- **Calibration:** The UHF Couplers have to be first calibrated as per CIGRE procedure TF 15/330305 as part of factory acceptance tests to guarantee detection sensitivity of 5pC or better. The GIS of same design shall be used as test specimen during the coupler calibration. The pulse injection level determined through above factory calibration tests shall only be used as reference for site sensitivity checks during commissioning of PDM system. The data sheet/frequency response characteristics shall be submitted for reference.
  - **Every Day Use & Maintenance :** The system shall be designed suitable for an unmanned s/s and operate automatically. The system shall generate alarms if suspected partial discharge activity is noticed or the system itself is in failure, thereby eliminating the necessity of periodic system access by the user and one such alarm shall be connected to Substation automation system (SAS). The alarms shall be configured coupler wise.
  - **Computers and Peripherals:** The PC operating system shall be the latest version of MS Windows. It should be suitable for continuous process application and should have been tested for the same. The hardware configuration of PC should be the latest available in the market of industrial type subject to EMPLOYER'S / Engineer approval. For storing the historical PD database, sufficient storage facility in the form of hard disc and retrievable hard disk drive of 1TB as specified shall be available in the substation. The PC monitor shall be 21" LCD type of reputed make.
  - **Filtering Facility:** The filtering facility has to be provided in order to distinguish real PD from internal/external noise such as switching operations, self-test signal, radio, communication signal etc. The PDM system itself shall be able to discriminate the noise from real PD. The exposed gas barriers of the GIS shall be shielded effectively against noise interference & tested. The gas barrier shields/belts shall be suitable for outdoor use also & able to withstand high ambient temperature. Site measurements have to be performed after installation of the PDM system in order to identify the various sources of external noise to incorporate the same in the filtering facility. This filtering will preferably be through software by band pass, which can be manually activated (as an option) to filter out noise signals in the trend plot display. If hardware filtering is employed then adequate measures have to be taken to avoid masking of other signals, which may lie in the same frequency range. The method adopted for the above shall be specified taking into account the sensitivity requirement of PDM system as per CIGRE document. The noise filters shall be selectable individually coupler-wise.

- **Self-Test (Diagnostic) Facility:** Built-in self-checking facility shall be incorporated in the control system which will continuously verify the correct operation of the whole monitoring system with the simulated PD signal viz. checking of the sensitivity of individual detector units, response of PD sensors in addition to the checking of the system functioning. The periodicity of such self-check operation shall be specified. In case of system failure this shall trigger an alarm for communication to SAS. External check facility: Propose the arrangement/device available for externally checking the healthiness of PD sensors by pulse injection in addition to built-in monitoring facility.
- **Detector Units:** The sensitivity of each detector unit shall be furnished. The sensitivity level of individual detector units shall be selectable depending on the site background noise level.
- **Trend Plot:** The trend plot facility shall be available with the update period of hourly/daily/weekly/monthly/yearly. It shall be possible to view the historical trends for the complete archived data accumulated over several years.
- **PD Monitoring modes:** There shall be two different modes of system operation viz. a dedicated Continuous PD Monitoring mode for the normal day today operation of the system & a dedicated HV commissioning test mode which is exclusively for PD monitoring during HV commissioning test. The HV commissioning mode shall also operate as an independent feature.

In the HV Commissioning mode the real time display shall be possible for a minimum of two complete bays with associated bus bars and at with one second update period. The HV test software shall automatically record the HV voltage information along with PD so as to check PD inception & extinction voltages precisely. The complete HV & PD data recorded during HV test shall be possible to be reviewed in replay mode after the HV test.

- **Alarm Facility:** The PDM system shall generate alarm when action is required; viz. a) PD alarm (abnormal PD activity indicating a risk of failure) & b) PD system fail alarm to be connected to SAS.
- **Real Time Display:** The PDM system should have the facility of Real Time display, which will give an instant indication of PD activity coupler wise, with one-second-update period. The PDM system shall be able to capture the PD data triggered by associated switching operations of CBs & isolators.
- **Schematics:** The PDM system should have GIS schemes bay-wise incorporating PD sensor identification and location along with spacer location. The sectional view of typical bay arrangement of GIS showing active parts shall also be included as part of the PDM software.
- **Print Option/Facility:** PDM system should have the option/facility of printing all trend plots/reports/POW patterns/displays, etc. Laser Colour printer shall be provided for this purpose at substation.

- **Data Archives:** This is to provide access to historical data and file storage with date and time stamp. Sufficient storage facility shall be available to review historical data updated for the lifetime of switchgear. The substation & headquarters PCs shall have a backup device in the form of a retrievable disk drive of 1TB capacity for this purpose.

- **PD Fault Identification & Location/Pattern Recognition/Predictive Maintenance**

Diagnostic Software: In order to interpret various types of PD defects, intelligent diagnostics software (expert system) shall be built- in as part of the PDM software capability. This is mainly to reduce the dependence on PD specialist. The bidder shall also make available typical point-on-wave patterns as library pictures to train the user.

Software Updates: It shall be possible to upgrade / update the system software throughout the lifetime of the system with the ongoing development / refinement in PD technology.

- Fault investigation : In case of any indication of suspected PD activity by the on line system, further investigation has to be carried out by the contractor for the PD defect identification and location during the warranty period
- Special Tools / equipment, Spare Parts, software packages

Special Tools: Special tools for cutting and crimping of coaxial cable with ‘N Connectors’ shall be supplied.

Spare parts: The contractor has to supply critical spares with replacement procedure for the trouble free operation of the system during its expected lifetime as part of the contract. A detailed list shall be included in the tender and also submitted for EMPLOYER’S approval during the detailed engineering stage.

Software Packages: The complete software package shall be supplied as part of a back-up facility in the form of DVD/CDs viz. Windows operating system with end user license, PDM Software including HV Test, Drivers for modems etc., software for remote access, printer etc. The list shall be submitted for reference.

Pulse generator for UHF sensor sensitivity test shall also be supplied as a standard accessory.

- Operation & Maintenance Manual :A complete O&M manual covering all aspects of trouble shooting of PDM system in six sets in original shall be provided & also in CD’s. For diagram references colour pictures shall be provided. A step-by-step procedure for spare parts replacement shall also be included.
- **Factory / Site Test Formats:** The factory & site tests format to be submitted for approval. The format shall cover all possible tests to confirm healthiness of the system and to record the test values.
- List of References: The bidder shall provide a reference list of PD monitoring system, which is supplied by them and in successful operation worldwide in a power utility.

**TECHNICAL PARAMETERS FOR CIRCUIT BREAKER**

Sl.No.	Parameter	765kV system	400kV system	220kV system	132 kV system
1.	Rated voltage (U <sub>max</sub> ) kV (rms)	800	420	245	145
2.	Rated frequency (Hz)	50	50	50	50
3.	No. of poles	3	3	3	3
4.	Type of circuit breaker	SF6 gas insulated	SF6 gas insulated	SF6 gas insulated	SF6 gas insulated
5.	Rated continuous current (A) at an ambient temperature of 50 <sup>0</sup> C	3150/4000	2000/3150/4000 (as applicable)	1600/2500 (as applicable)	1250
6.	Rated short circuit capacity with percentage of DC component as per IEC-62271-100 corresponding to minimum opening time under operating conditions specified.	50kA (As applicable)	40/50/63kA (As applicable)	40/50 kA (As applicable)	31.5kA
7.	Symmetrical interrupting capability kA (rms)	50	40/50/63 (As applicable)	40/50 (As applicable)	31.5
8.	Rated short circuit making current kAp	125	100/125/157.5 (As applicable)	100/125 (As applicable)	80
9.	Short time current carrying capability kA (rms)	50 for one second	40/50/63 As applicable for one second	40/50 As applicable for one second	31.5 for one second
10.	Out of phase breaking current carrying capability kA (rms)	12.5	10/12.5/15.75 (As applicable)	<b>As per IEC</b>	<b>As per IEC</b>

			)		
11.	Rated line charging interrupting current at 90 deg. Leading power factor angle (A rms) (The breaker shall be able to interrupt the rated line charging current with test voltage immediately before opening equal to the product of $U/\sqrt{3}$ and 1.4 as per IEC-62271-100	900	600	As per IEC	As per IEC
12.	First pole to clear factor	1.3	1.3	1.3	1.3
13.	Temperature rise over an ambient temperature of 50°C	As per IEC: 62271-100	As per IEC: 62271-100	As per IEC: 62271-100	As per IEC: 62271-100
14.	Rated break time as IEC (ms)	40	40	60	60
15.	Total break time (ms)	45	45	65	65
16.	Total closing time (ms)	Not more than 150	Not more than 150	Not more than <b>150</b>	Not more than <b>150</b>
17.	Operating mechanism or a combination of these	Spring	Spring	Spring	Spring
18.	Rated operating duty cycle	O-0.3s-CO-3 min-CO	O-0.3s-CO-3 min-CO	O-0.3s-CO-3 min-CO	O-0.3s-CO-3 min-CO
19.	Reclosing	Single phase & Three phase auto reclosing.	Single phase & Three phase auto reclosing.	Single phase & Three phase auto reclosing.	Three phase auto reclosing. (Single phase auto reclosing if specified in section-project)
20.	Pre-insertion resistor requirement	As per BPS	As per BPS	NA	NA
i)	Rating (ohms)	450(max.) with tolerance as	400(max.) with tolerance	NA	NA

		applicable	as applicable		
ii)	Minimum electrical (mechanical insertion time +pre-arcing time) pre-insertion time (ms)	9	8	NA	NA
21.	Max. difference in the instants of closing/opening of contacts (ms) between poles at rated control voltage and rated operating & quenching media pressures	2.5(within a pole) 3.3(opening) 5.0(closing)	2.5(within a pole) 3.3(opening) 5.0(closing)	3.3(opening) 5.0(closing)	3.3(opening) 3.3(closing)
22.	Maximum allowable switching over voltage under any switching condition	1.9 p.u.	2.3 p.u.	As per IEC	As per IEC
23.	Trip coil and closing coil voltage with variation as specified	220V DC	220V DC	220V DC	220V DC or 110V DC
24.	Noise level at base and up to 50 m distance from base of circuit breaker	As per IEC	140dB (max.)	140dB (max.)	140dB (max.)
25.	Rating of Auxiliary contacts	10A at 220V DC	10A at 220V DC	10A at 220V DC	10A at 220V DC
26.	Breaking capacity of Aux. Contacts	2A DC with circuit time constant not less than 20ms	2A DC with circuit time constant not less than 20ms	2A DC with circuit time constant not less than 20ms	2A DC with circuit time constant not less than 20ms
27.	<b>Rated insulation levels</b>				
i)	Full wave impulse withstand (1.2 /50 $\mu$ s) between line terminals and ground	$\pm$ 2100kVp	$\pm$ 1425 kVp	$\pm$ 1050 kVp	$\pm$ 650 kVp
ii)	Full wave impulse withstand (1.2 /50 $\mu$ s) between terminals with circuit breaker open	2100kVp impulse on one terminal & 455 kVp	1425 kVp impulse on one terminal & 240	$\pm$ 1050 kVp	+ 650kVp

		power frequency voltage of opposite polarity on the other terminal	kVp power frequency voltage of opposite polarity on the other terminal		
iii)	Rated switching impulse withstand voltage (250/2500 $\mu$ s) Dry & wet between line terminals and ground	+ 1550kVp	+1050 kVp	NA	NA
iv)	Rated switching impulse withstand voltage (250/2500 $\mu$ s) Dry & wet Between terminals with circuit breaker open	1175kVp impulse on one terminal & 650 kVp power frequency voltage of opposite polarity on the other terminal	900 kVp impulse on one terminal & 345 kVp power frequency voltage of opposite polarity on the other terminal	NA	NA
v)	One minute power frequency dry withstand voltage between line terminals and ground	830kV rms	520 kV rms.	460 kV rms.	275 kV rms
vi)	One minute power frequency dry withstand voltage between terminals with circuit breaker open	1150kV rms	610 kV rms.	460 kV rms.	275 kV rms
28.	Minimum corona extinction voltage with CB in all positions	508 kV rms	320kV rms	156 kV rms	92 kV rms
29.	Max. radio interference voltage for frequency between 0.5 MHz and 2 MHz (Micro volts)	2500 $\mu$ V (at 508kV rms)	1000 $\mu$ V (at 266kV rms)	1000 $\mu$ V (at 156kV rms)	500 $\mu$ V (at 92kV rms)
30.	System neutral earthing	Effectively earthed			
31.	Auxiliary contacts	Besides requirement of technical specification, the			

		manufacturer/contractor shall wire up 10 NO + 10 NC contacts exclusively for purchaser's use and wired up to common marshalling box.
32.	No. of terminals	All contacts & control circuits to be wired out up to common marshalling box + minimum 24 terminals exclusively for purchaser's future use

## ANNEXURE-2

## TECHNICAL PARAMETERS FOR DISCONNECT SWITCH/ ISOLATORS

Sl. No	Particulars	765kV	400 kV	220 kV	132kV
1.	Rated voltage (rms) Un	800kV	420 kV	245 kV	145 kV
2.	Rated frequency	50 HZ	50 HZ	50 HZ	50 Hz
3.	System earthing	Effectively earthed	Effectively earthed	Effectively earthed	Effectively earthed
4.	Type	SF6 insulated	SF6 insulated	SF6 insulated	SF6 insulated
5.	Rated continuous current (A) at 50°C ambient temp.(as applicable)	2000/3150/4000 /5000	2000/3150/4000	1600/3000 (as applicable)	1200/600 (for line /transformer /bus coupler)
6.	Rated short time withstand current of isolator and earth switch(as applicable )	50/40 kA for 1 Sec.	63/50/40 kA for 1 Sec.	50/40 kA for 1 Sec.	31.5 kA for 1 second
7.	Rated dynamic short circuit withstand current of isolator and earth switch(As applicable )	125/100kAp	157.5/125/100 kAp	125/00 kAp.(As applicable )	80 kAp
8.	Rated insulation level:				
	One minute power freq. Withstand voltage: To earth :	960 kV rms	650 kV rms.	460 kV rms.	275 kV rms.
	One minute power freq. Withstand	1270 kVrms	815 kV rms.	530 kV rms.	315 kV rms.

	voltage: Across isolating distance				
	1.2/50 micro sec. Lighting impulse withstand voltage (+ve or -ve polarity) To earth:	$\pm 2100$ kVp	1425 kVp	$\pm 1050$ kVp	
	1.2/50 micro sec. Lighting impulse withstand voltage (+ve or -ve polarity) : Across Isolating distance	$\pm 2100/-+457$ kVp	$\pm 1425/-+240$ kVp	$\pm 1200$ kVp	
	Rated switching impulse withstand voltage (250/2500 micro-sec.) Dry & wet :between line terminals and ground:	$\pm 1550$ kVp	+/- 1050 kVp	N.A	
	Rated switching impulse withstand voltage (250/2500 micro-sec.) Dry & wet :Between terminals with Isolator open:	+/- 1200 kVp impulse on one terminal & 653 kVp of opposite polarity on the other terminal	+/- 900 kVp impulse on one terminal & 345 kVp of opposite polarity on the other terminal.	N.A	
9.	Mechanical Endurance clause as per IEC	M2	M2	M2	
10.	No. of spare auxiliary contacts on each isolator	4 NO and 4 NC	4 NO and 4 NC	4 NO and 4 NC	
11.	No. of spare auxiliary contacts on each earthing switch	4 NO and 4 NC	4 NO and 4 NC	4 NO and 4 NC	

## ANNEXURE-3

## TECHNICAL PARAMETERS FOR CURRENT TRANSFORMERS

S. No.	Description	765kV system	400kV system	220kV system	132 kV system
1	Rated voltage, $U_m$ (kVrms)	800	420	245	145
2	Rated frequency (Hz)	50	50	50	50
3	No. of Poles	1	1	1	1
4	Design ambient temperature (°C)	50	50	50	50
5	Rated Primary Current (A)	3000	3000	1600	800/600
6	Rated extended primary current	120%	120%	120%/150%	120%/150%
7	Rated short time thermal withstand current	40kA/50kA (as applicable) for 1 sec	40kA/50kA/63kA (as applicable) for 1 sec	40kA/50kA (as applicable) for 1 sec	31.5kA for 1 sec
8	Rated dynamic current	100kAp/125kAp (as applicable)	100kAp/125kAp / 157.5kAp (as applicable)	100kAp/125kAp (as applicable)	80kAp
9	Temperature rise over design ambient temperature	As per IEC			
10	Rated Insulation levels				
a)	Full wave impulse withstand voltage (1.2/50 microsecond)				
i)	between line terminals and ground(kVpeak)	±2100	±1425	±1050	±650
b)	Switching impulse withstand voltage (250/2500 microsecond) (dry and wet)				
i)	between line terminals and ground (kVpeak)	± 1550	± 1050	-NA-	-NA-
c)	One minute power frequency dry withstand voltage (dry and wet)				
i)	between line terminals and ground (kVrms)	975 (dry only)	630 (dry only)	460	275
d)	One minute power frequency withstand voltage between secondary terminals & earth (kVrms)	5kV			
11	Max. radio interference voltage for frequency between 0.5 MHz and 2 MHz	2500 at 508 kV rms	1000 at 266kV rms	1000 at 156kV rms	500 at 92kV rms

S. No.	Description	765kV system	400kV system	220kV system	132 kV system
	at (microvolts)				
12	Minimum Corona extinction voltage (kVrms)	508	320	-NA-	-NA-
13	Seismic acceleration (Horizontal)	0.3g	0.3g	0.3g	0.3g
14	Partial Discharge	As per IEC	As per IEC	As per IEC	As per IEC
15	Number of terminals	All terminals of control circuits are to be wired up to marshaling box plus 20% spare terminals evenly distributed on all TBs.			
17	System neutral earthing	Effectively Earthed			

For other parameters, refer respective Table for the applicable voltage class of CTs.

**TABLE -3A****REQUIREMENTS FOR 765 kV CURRENT TRANSFORMER**

No. of Cores.	Core No.	Application	Current Ratio	Output Burden (VA)	Accuracy Class	Min. Knee Pt. Voltage (Vk)	Max. CT Sec. wdg. Resistance (in $\Omega$ )	Max. Excit. Current at Vk (in mA)
<b>6</b>	1	BUS DIFF. CHECK	3000/ 2000/ 500/1	-	<b>PX</b>	3000/ 2000/ 500	15/10/2.5	20 on 3000/1 TAP; 30 on 2000/1; 120 on 500/1 tap
	2.	BUS DIFF. MAIN	3000/ 2000/ 500/1	-	<b>PX</b>	3000/ 2000/ 500	15/10/2.5	20 on 3000/1 TAP; 30 on 2000/1; 120 on 500/1 tap
	3.	METERING	3000/ 2000/ 500/1	20 20 20	0.2S 0.2S 0.2S	- - -		- - -
	4.	METERING	3000/ 2000/ 500/1	20 20 20	0.2S 0.2S 0.2S	- - -		- - -
	5.	TRANSF DIFF./ LINE PROT.N.	3000/ 2000/ 500/1	-	<b>PX</b>	3000/ 2000/ 500	15/10/2.5	20 on 3000/1 TAP; 30 on 2000/1; 120 on 500/1 tap
	6	LINE PROT.N/LBB PROT.N.	3000-2000- 500/1	-	<b>PX</b>	3000/ 2000/ 500	15/10/2.5	20 on 3000/1 Tap,30 on 2000/1 Tap,120 on 500/1 Tap

- Note: 1. Protection cores shall be of accuracy class PX as per IEC 61869.**  
**2. Metering Core shall be of accuracy class 0.2S as per IEC: 61869**

**TABLE-3B****REQUIREMENTS FOR 400 kV CURRENT TRANSFORMER**

No. of cores	Core No.	Application	Ratio	Output Burden	Accuracy Class	Min. Knee Pt. Voltage (Vk)	Max. CT Sec. wdg. Resistance (in $\square$ )	Max. Excit. Current at Vk (in mA)
6	1	BUS DIFF. CHECK	3000/ 2000/ 500/1	-	<b>PX</b>	3000/ 2000/ 500	15/10/2.5	20 on 3000/1 TAP; 30 on 2000/1; 120 on 500/1 tap
	2.	BUS DIFF. MAIN	3000/ 2000/ 500/1	-	<b>PX</b>	3000/ 2000/ 500	15/10/2.5	20 on 3000/1 TAP; 30 on 2000/1; 120 on 500/1 tap
	3.	METERING	3000/ 2000/ 500/1	20 20 20	0.2S 0.2S 0.2S	- - -		- - -
	4.	METERING	3000/ 2000/ 500/1	20 20 20	0.2S 0.2S 0.2S	- - -		- - -
	5.	TRANS. BACK UP/LINE PROTN.	3000/ 2000/ 500/1	-	<b>PX</b>	3000/ 2000/ 500	15/10/2.5	20 on 3000/1 TAP; 30 on 2000/1; 120 on 500/1 tap
	6.	TRANS. DIFF. /LINE PROTN.	3000/ 2000/ 500/1	-	<b>PX</b>	3000/ 2000/ 500	15/10/2.5	20 on 3000/1 TAP; 30 on 2000/1; 120 on 500/1 tap

- Note: 1. Protection cores shall be of accuracy class PX as per IEC 61869.**  
**2. Metering Core shall be of accuracy class 0.2S as per IEC: 61869**

**TABLE-3C****REQUIREMENTS FOR 220 kV CURRENT TRANSFORMER**

No.of Cores	Core No.	Appli- cation	Current ratio	Output burden (VA)	Accuracy class	Min. knee pt.volt- age (Vk)	Max. CT sec.wdg. resist- ance(ohms)	Max. Excit- ation cur- rent at Vk (in mA)
5	1	BUS DIFF CHECK	1600-800/1	-	PX	1600/800	8/4	25 on 1600/1 Tap; 50 on 800/1 Tap
	2	BUS DIFF MAIN	1600-800/1	-	PX	1600/800	8/4 Tap;	25 on 1600/1 Tap
			800/1		50 on			
	3	METERING	1600-800/1	20	0.2S	-	-	-
	4	TRANS. BACK UP/LINE PROTN.	1600-800/1	-	PX	1600/800	8/4	25 on 1600/1 Tap; 50 on 800/1 Tap
5	TRANS. DIFF/LINE PROTN	1600-800/1	-	PX	1600/800	8/4	25 on 1600/1 Tap; 50 on 800/1 Tap	

**Note: 1. Protection cores shall be of accuracy class PX as per IEC 61869.  
2. Metering Core shall be of accuracy class 0.2S as per IEC: 61869**

TABLE-3D

## REQUIREMENTS FOR 145 KV CURRENT TRANSFORMER

No.of Cores	Core No.	Appli- cation	Current ratio	Output burden (VA)	Accuracy class	Min. knee pt.volt- age Vk	Max. CT sec.wdg. resist- ance(ohms)	Max. Excit- ation cur- rent at Vk (in mA)
5	1	BUS DIFF CHECK	800-400/1	-	PX	800/400	8/4	25 on 800/1 Tap; 50 on 400/1 Tap
	2	BUS DIFF MAIN	800-400/1	-	PX	800/400	8/4	25 on 800/1 Tap; 50 on 400/1 Tap
	3	METERING	800-400/1	20	<b>0.2S</b>	-	-	-
	4	TRANS. BACK UP/LINE PROTN.	800-400/1	-	PX	800/400	8/4	25 on 800/1 Tap; 50 on 400/1 Tap
	5	TRANS. DIFF/LINE PROTN	800-400/1	-	PX	800/400	8/4	25 on 800/1 Tap; 50 on 400/1 Tap

**Note: 1. Protection cores shall be of accuracy class PX as per IEC 61869.**

**2. Metering Core shall be of accuracy class 0.2S as per IEC: 61869**

TABLE-3E

## REQUIREMENTS FOR 145 kV CURRENT TRANSFORMER

No.of Cores	Core No.	Appli- cation	Current ratio	Output burden (VA)	Accuracy class	Min. knee pt.volt- age Vk	Max. CT sec.wdg. resist- ance(ohms)	Max. Excit- ation cur- rent at Vk (in mA)
5	1	BUS DIFF CHECK	600- 300/1	-	PX	600/ 300	6/3	30 on 600/1 Tap; 60 on 300/1 Tap
	2	BUS DIFF	600- 300/1	-	PX	600/ 300	6/3	30 on 600/1 Tap; on 300/1 Tap
	3	METERING	300- 150/1	20	0.2S	-	-	-
	4	TRANS. BACK UP/LINE PROTN.	600- 300/1	-	PX	600/ 300	6/3	30 on 600/1 Tap; 60 on 300/1 Tap
	5	TRANS. DIFF/LINE PROTN	600- 300/1	-	PX	600/ 300	6/3	30 on 600/1 Tap; 60 on 300/1 Tap

**Note: 1. Protection cores shall be of accuracy class PX as per IEC 61869.**  
**2. Metering Core shall be of accuracy class 0.2S as per IEC: 61869**

## ANNEXURE-4

## TECHNICAL PARAMETERS FOR VOLTAGE TRANSFORMERS

S. No.	Description	765kV system	400kV system	220kV system	132 kV system
1	Type (CVT/IVT)	CVT	CVT/IVT	CVT/IVT	CVT/IVT
2	Rated voltage, $U_m$ (kVrms)	800	420	245	145
3	Rated frequency (Hz)	50	50	50	50
4	No. of Poles	1	1	1	1
5	Design ambient temperature (°C)	50	50	50	50
6	System fault level (kA)	40kA/50kA (as applicable) for 1 sec	40kA/50kA/63kA (as applicable) for 1 sec	40kA/50kA (as applicable) for 1 sec	31.5kA for 1sec
6	Standard reference range of frequencies for which the accuracies are valid	96% to 102% for protection and 99% to 101% for measurement			
7	High frequency capacitance for entire carrier frequency range (for CVT only)	Within 80% to 150% of rated capacitance			
8	Equivalent series resistance over entire carrier frequency range (for CVT)	Less than 40 Ohms			
9	Stray capacitance and stray conductance of HF terminal over entire carrier frequency range (for CVT)	As per IEC-60358			
10	Temperature rise over design ambient temperature	As per IEC			
11	Rated Insulation levels				
a)	Full wave impulse withstand voltage (1.2/50 microsecond)				
i)	between line terminals and ground (kVpeak)	±2100	±1425	±1050	±650
b)	Switching impulse withstand voltage (250/2500 microsecond) (dry and wet)				
i)	between line terminals and ground (kVpeak)	± 1550	± 1050	-NA-	-NA-
c)	One minute power frequency dry withstand voltage (dry and wet)				
i)	between line terminals and ground (kVrms)	975 (dry only)	630 (dry only)	460	275

S. No.	Description	765kV system	400kV system	220kV system	132 kV system
d)	One minute power frequency withstand voltage between secondary terminals & earth				
i)	between LV (HF) terminal and earth terminal (kVrms)	10kVrms for exposed terminals and 4kVrms for terminals enclosed in a weather proof box			
ii)	For secondary winding	3kVrms			
11	Max. radio interference voltage for frequency between 0.5 MHz and 2 MHz at (microvolts)	2500 at 508 kV rms	1000 at 266kV rms	1000 at 156kV rms	500 at 92kV rms
12	Minimum Corona extinction voltage (kVrms)	508	320	-NA-	-NA-
13	Partial Discharge	As per IEC	As per IEC	As per IEC	As per IEC
14	Number of terminals	All terminals of control circuits are to be wired up to marshaling box plus 20% spare terminals evenly distributed on all TBs.			
15	Rated Total Thermal Burden (VA)	300 VA (100VA/winding)			
17	System neutral earthing	Effectively Earthed			

For other parameters, refer respective Table for the applicable voltage class of IVTs.

**TABLE -4A**

**REQUIREMENT OF VOLTAGE TRANSFORMERS**

Sl. No	PARTICULARS	765 kV			400 kV			220 kV			132kV		
1	Rated primary voltage	765// $\sqrt{3}$ kV			400// $\sqrt{3}$ kV			220// $\sqrt{3}$ kV			132// $\sqrt{3}$ kV		
2	Type	Electromagnetic			Electromagnetic			Electromagnetic			Electromagnetic		
3	No. of secondaries	3			3			3			3		
4	Rated voltage factor	1.2 continuous			1.2 continuous			1.2 continuous			1.2 continuous		
		1.5 for 30 seconds			1.5 for 30 seconds			1.5 for 30 seconds			1.5 for 30 seconds		
5	Phase angle error	$\pm 10$ minutes (for metering core)			$\pm 10$ minutes (for metering core)			$\pm 10$ minutes (for metering core)			$\pm 10$ minutes (for metering core)		
		Sec I	Sec II	Sec III	Sec I	Sec II	Sec III	Sec I	Sec II	Sec III	Sec I	Sec II	Sec III
6.	Rated secondary voltage (V)	110// $\sqrt{3}$			110// $\sqrt{3}$			110// $\sqrt{3}$			110// $\sqrt{3}$		
7.	Application	Protection	Protection	Metering	Protection	Protection	Metering	Protection	Protection	Metering	Protection	Protection	Metering
8.	Accuracy	0.5/3P	0.5/3P	0.2	0.5/3P	0.5/3P	0.2	3P	3P	0.2	3P	3P	0.2
9.	Output burden (VA) (minimum)	50	50	50	50	50	50	50	50	50	50	50	50

## ANNEXURE-5

## TECHNICAL PARAMETERS OF GIS SURGE ARRESTOR

Sl. No.	Description	Unit	800kV SA	420kV SA	245kV SA	145kV SA
1	Nominal System Operating voltage	kV, rms	765	400	220	132
2	Rated frequency	Hz	50	50	50	50
3	No. of Poles	No.	1	1	1	1
4	Design ambient temperature	°C	50	50	50	50
5	Rated arrester voltage	kV	624	336	216	120
6	Continuous operating voltage at 50 deg.C	kV	490	267	168	102
7	Nominal discharge current		20 kA of 8/20 microsecond wave	20 kA of 8/20 microsecond wave	10 kA of 8/20 microsecond wave	10 kA of 8/20 microsecond wave
8	Discharge current at which insulation co-ordination will be done		20 kA of 8/20 microsecond wave	20 kA of 8/20 microsecond wave	10 kA of 8/20 microsecond wave	10 kA of 8/20 microsecond wave
9	Minimum discharge capability (referred to rated arrester Voltage) or corresponding to minimum discharge voltage as per clause-2.0 (d) whichever is higher	kJ/kV	13kJ/kV	12kJ/kV	5kJ/kV	5kJ/kV
10	Max. switching surge residual voltage	kVp	1180 (at 1kA) 1220 (at 2kA)	670(at 2kA) 650 (at 500A)	500 (at 1kA)	280 (at 1kA)
11	Max. residual voltage at					
i)	5kA	kVp	-	-	560	310

Sl. No.	Description	Unit	800kV SA	420kV SA	245kV SA	145kV SA
ii)	10 kA nominal discharge current	kVp	-	800	600	330
iii)	20 kA nominal discharge current	kVp	1480	850	-	-
iv)	Steep fronted wave residual voltage at 20 kA	kVp	1480	925	-	-
12	Long duration discharge class		5 {Refer clause 2.0(d)}	4 {Refer clause 2.0(d)}	3	3
13	High current short duration test value(4/10 micro second wave)	kAp	100	100	100	100
14	Current for pressure relief test	kA rms	63	40 / 50 / 63 (as applicable)	40 / 50 (as applicable)	40
15	Low current long duration test value	As per IEC				
16	Insulation Level					
a)	Full wave impulse withstand voltage (1.2/50 microsec.)					
i)	Arrester Housing	kVpeak	As per IEC:60099-4	±1425	±1050	±650
b)	Switching impulse withstand voltage (250/2500 micro-second) dry and wet					
i)	Arrester Housing	kV peak	As per IEC:60099-4	± 1050	-NA-	-NA-
c)	One minute power frequency dry withstand voltage					
i)	Arrester Housing	kV rms	830	630	460	275
18	Partial Discharge at 1.05 COV		≤ 10pC	≤ 10pC	≤ 10pC	≤ 10pC
19	System neutral earthing		Effectively Earthed	Effectively Earthed	Effectively Earthed	Effectively Earthed

**ANNEXURE-6****TECHNICAL PARAMETERS FOR SF6/AIR BUSHING**

<b>Sl. No.</b>	<b>Particular</b>	<b>765 kV</b>	<b>400 kV</b>	<b>220 kV</b>	<b>132kV</b>
1	Rated Voltage (kV)	800 kV(rms)	420 kV (rms)	245 kV (rms)	145 kV (rms)
2	Rated Current (Amp)	2000/3150 as applicable	2000/3150/5000 as applicable	1600	600
3	1.2/50 micro second impulse voltage (Lightning impulse withstand voltage)	2100 kVp	1425 kVp	1050 kVp	630 kVp
4	250/2500 micro second switching impulse voltage	1550 kVp	1050 kVp	-	
5	One minute power frequency withstand voltage	960 kV (rms)	650 kV (rms)		275 kV (rms)
6	Minimum total Creepage distance in mm	20000	10500	6125	3625
7	Minimum Cantilever strength (kN)	10	10	8	5

Wiring Diagram of VT

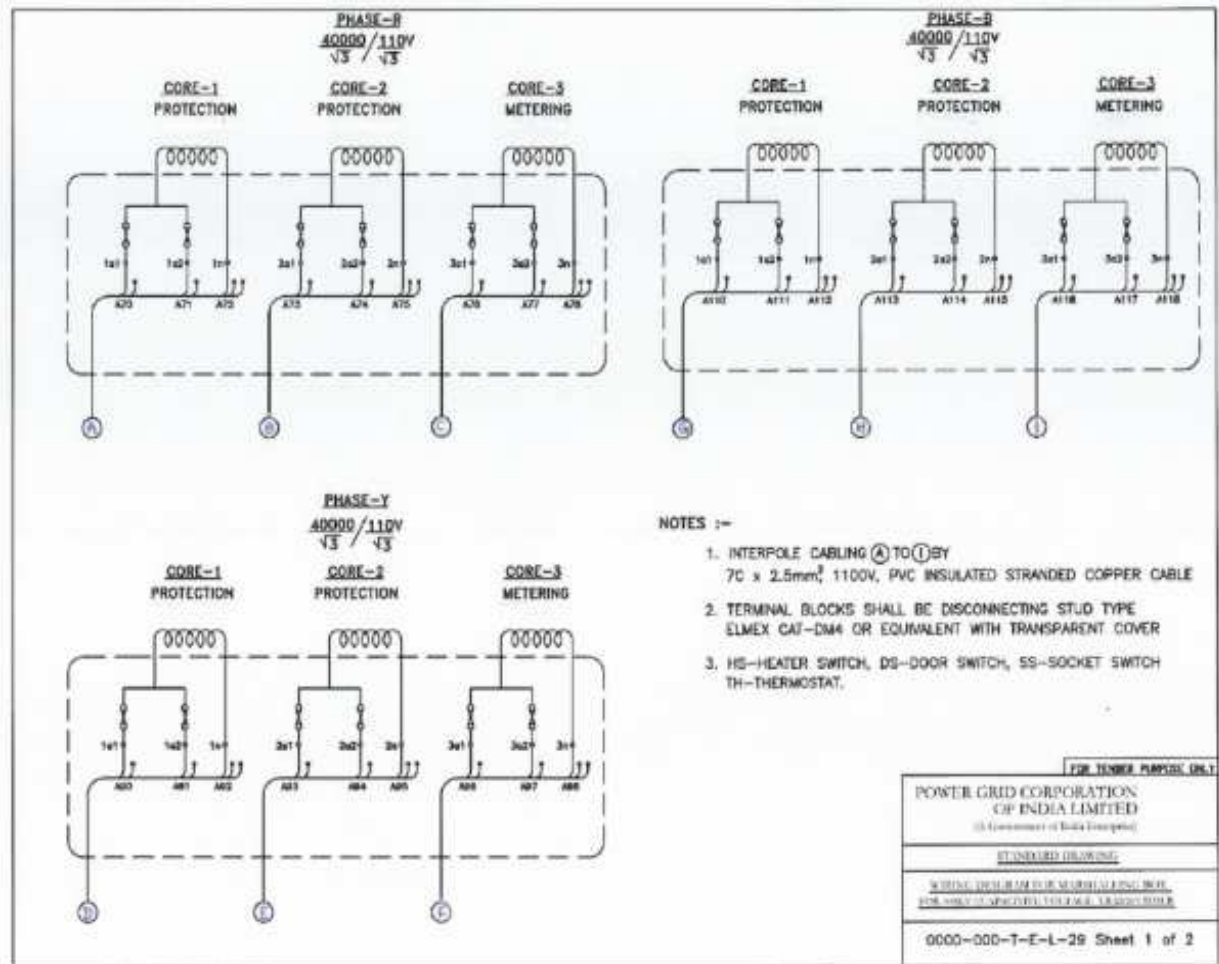

### Wiring Diagram of VT

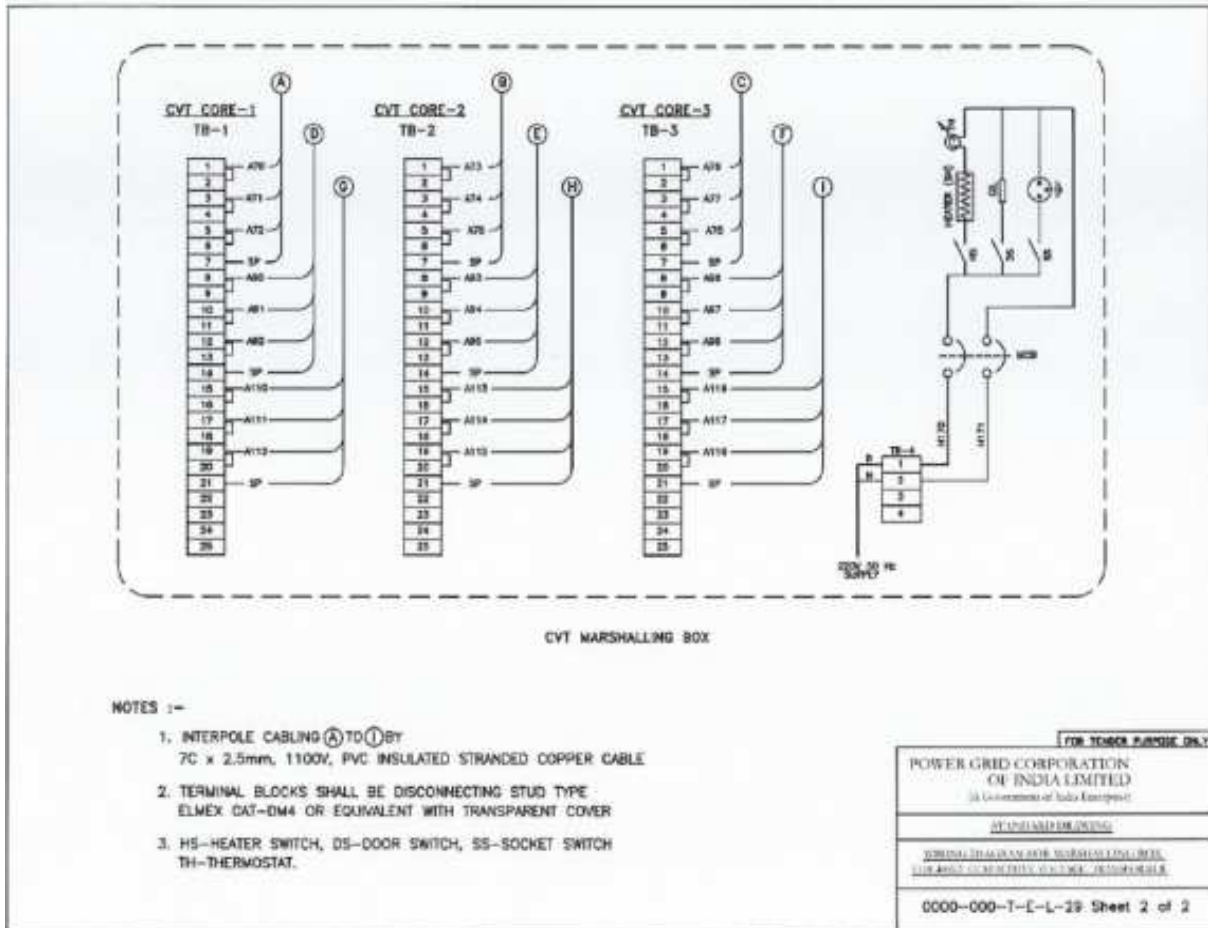

Wiring Diagram of CT

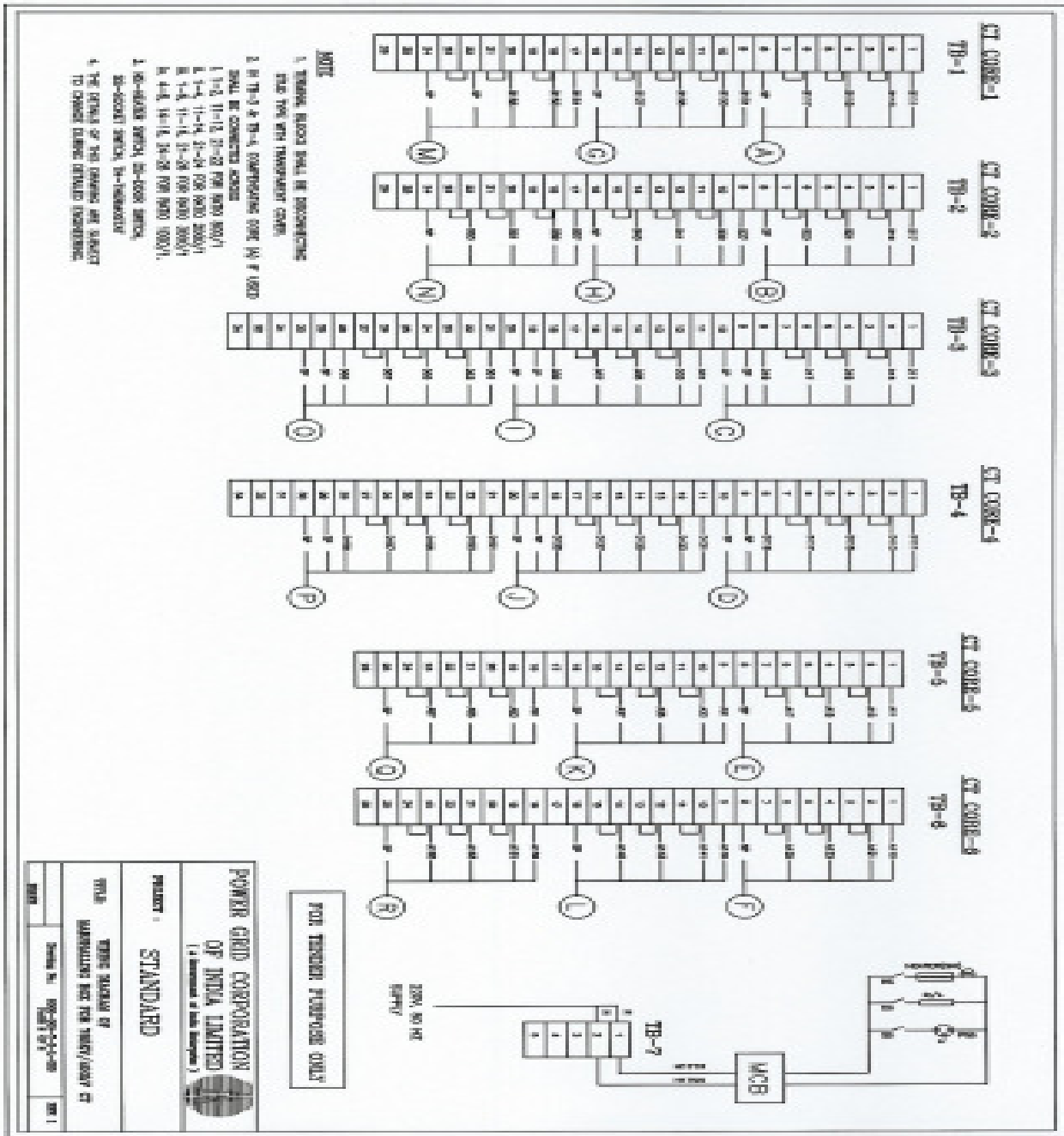

CONCEPTUAL GIS INTERFACE MODULE DRAWING

GIS EXTENSION PROCEDURE

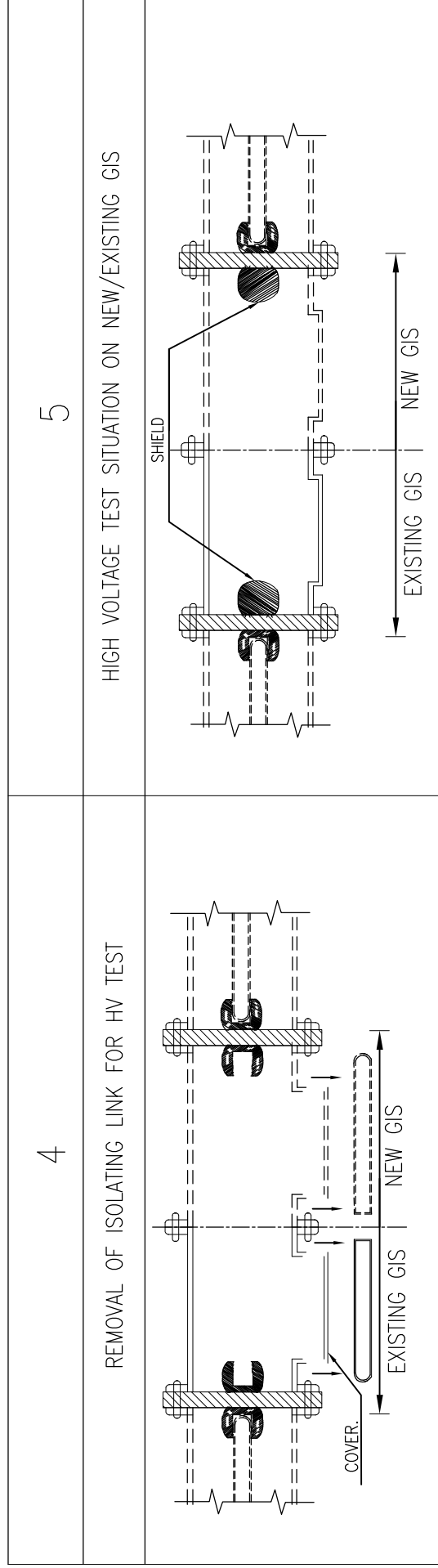
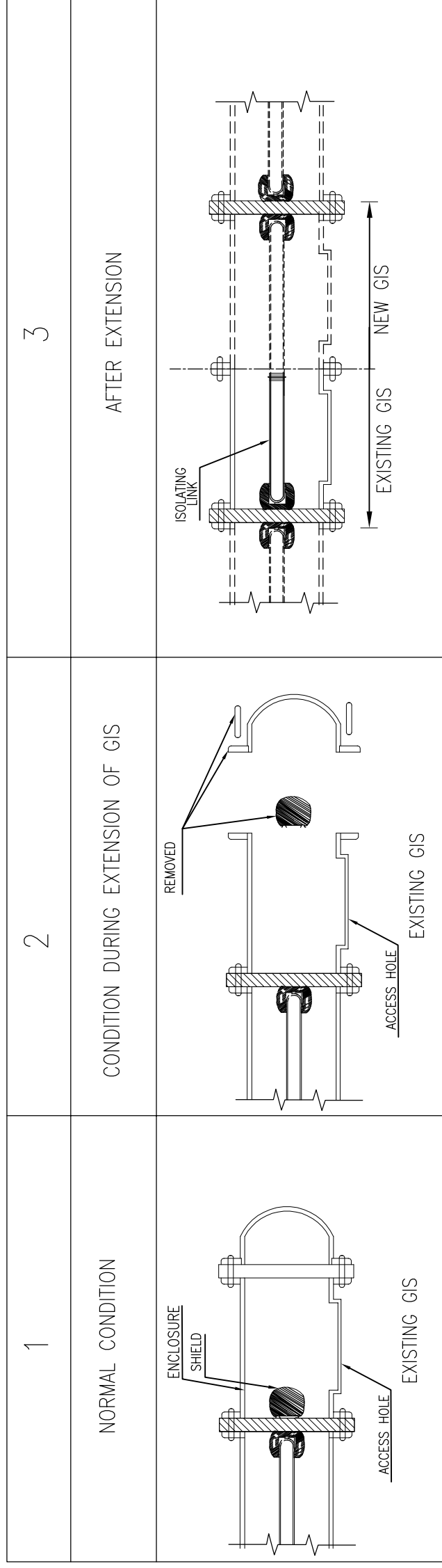

NOTES:

1. This drawing shall be read in conjunction with Model Technical Specification for GIS.
2. This is a conceptual drawing only, Interface module drawing for different projects shall be developed by respective GIS manufacturers.



POWER GRID CORPORATION  
OF INDIA LIMITED  
(A GOVERNMENT OF INDIA ENTERPRISE)

TITLE: STANDARD GIS INTERFACE MODULE DRAWING

DATE	DRAWN	SCALE	DWG. NO.	STD/GIS/INTERFACE/MODULE/01	REV
April 2017	Abuj	NIS			0

ED	GM	GM	GM	ED
(ENGG-S/S, CIVIL&T/L)	(ENGG-S/S)	(ENGG-S/S)	(ENGG-S/S)	(ENGG-S/S, CIVIL&T/L)
APPROVED BY				APPROVED BY

ACDE	CDE	GM	GM	GM
(ENGG-S/S)	(GIS-CORE)	(ENGG-S/S)	(ENGG-S/S)	(ENGG-S/S)
CHECKED BY				

## STANDARD MANDATORY SPARES FOR GAS INSULATED SWITCHGEAR

Sl. No.	Description	Unit	Quantity (New S/s)	Quantity (Extn. S/s)
<b>For 765 kV, 400 kV Voltage Class as applicable</b>				
1.0	<b>General</b>			
1.1	Complete GIS modules, along with enclosure, all active parts such as conductor, conductor joints, shields, end covers etc. for each type of <ul style="list-style-type: none"> <li>➤ Bus Bar Sections (including Bus Bar Interconnection Modules)</li> <li>➤ Bus Ducts Sections (including Compensators/expansion joints/bellows)</li> <li>➤ Bends</li> <li>➤ SF6/Air Bushing.</li> <li>➤ Oil/SF6 Bushing</li> <li>➤ Cable Termination kit</li> </ul>	Set	1	1
1.2	SF6 gas Pressure Relief Device assembly of each type	Set	1	1
1.3	SF6 Pressure gauge cum switch /Density monitors and pressure switch as applicable, of each type	Set	5	3
1.4	Coupling device for pressure gauge cum switch for connecting Gas handling plant of each type	Set	2	2
1.5	Rubber Gaskets, "O" Rings and Seals for SF6 gas for GIS enclosures of each type	Set	5	3
1.6	Molecular filter for SF6 gas with filter bags (10 % of total weight)	Set	1	1
1.7	Control Valves for SF6 gas of each type	Set	3	1
1.8	SF6 gas (20 % of total gas quantity)	Lot	1	1
1.9	Pipe length (Copper or Steel as applicable) for SF6 Circuit of each type (if applicable)	Set	2	1
1.10	Locking device to keep the Dis-connectors (Isolators) and Earthing/Fast Earthing switches in close or open position in case of removal of the driving Mechanism	Set	2	1
1.11	UHF PD Sensors of each type along with BNC Connector	Nos.	5	2
1.12	Support Insulators (gas through) of each type (complete with metal ring etc.)	Nos.	10	4
1.13	Gas Barriers of each type (complete with metal ring etc.)	Nos.	10	4
1.14	SF6 to air bushing of each type complete in all respect	No.	2	1
<b>2.0</b>	<b>SF6 CIRCUIT BREAKER:</b>			

## STANDARD MANDATORY SPARES FOR GAS INSULATED SWITCHGEAR

2.1	Complete Circuit Breaker (one phase) without PIR with interrupter, main circuit, enclosure and Marshalling Box with operating mechanism to enable one to one replacement of applicable type of CB by spare. (if applicable)	Set	2	1
2.2	Complete Circuit Breaker (one phase) with PIR with interrupter, main circuit, enclosure and Marshalling Box with operating mechanism to enable one to one replacement of applicable type of CB by spare. (if applicable)	Set	2	1
2.3	Fixed, moving and arcing contacts including insulating nozzles of each type (for Main Chamber & PIR Chamber as applicable)	Set	1	1
2.4	Trip coil assembly with resistor as applicable	Set	3	3
2.5	Closing coil assembly with resistor as applicable	Set	3	3
2.6	Relays, Power contactors, push buttons, timers & MCBs etc. of each type	Set	1	1
2.7	Auxiliary switch assembly of each type	Set	3	1
2.8	Operation Counter	Set	3	1
2.9	Windscope / Observing window of each type	Set	2	2
<b>2.11</b>	<b>For Hydraulic Operated Mechanism, if applicable</b>			
2.11.1	Hydraulic operating mechanism with drive motor of each type	Set	3	1
2.11.2	Ferrules, joints and couplings of each type	Set	3	1
2.11.3	Hydraulic filter of each type	Set	3	1
2.11.4	Hose pipe of each type	Set	3	1
2.11.5	N2 Accumulator of each type	Set	3	1
2.11.6	Valves of each type	Set	3	1
2.11.7	Pipe length (copper & steel) of each size & type	Set	3	1
2.11.8	Pressure switches of each type	Set	3	1
2.11.9	Pressure gauge with coupling device of each type	Set	3	1
2.11.10	Hydraulic oil (20% of total Oil quantity)	Set	1	1
2.11.11	Pressure Relief Device of each type	Set	3	1
<b>2.12</b>	<b>For Spring Operated Mechanism, if applicable</b>			
2.12.1	Complete Spring Operating Mechanism including charging mechanism etc. of each type	Set	3	1
2.12.2	Spring Charging Motor	Nos.	2	1
<b>2.13</b>	<b>For Hydraulic-Spring Operated Mechanism, if applicable</b>			
2.13.1	Complete Hydraulic-Spring Operating Mechanism including charging mechanism etc. of each type	Set	3	1
2.13.2	Spring Charging Motor	Nos.	2	1
2.13.3	Pressure switches of each type	Set	3	1

## STANDARD MANDATORY SPARES FOR GAS INSULATED SWITCHGEAR

2.13.4	Pressure gauge with coupling device of each type	Set	3	1
<b>3.0</b>	<b>Disconnecter Switches/Earthing Switchis:</b>			
3.1	Complete set of 3-phase dis-connector of each type including main circuit, enclosure, driving mechanism and support Insulator etc. to enable complete one to one replacement of all applicable type of Isolator by spare	Set	1	1
3.2	Complete set of 3-phase Maintenance Earthing switch of each type, including main circuit, enclosure, driving mechanism and support Insulator etc to enable complete one to one replacement of all applicable type of Earth Switch by spare	Set	1	1
3.3	Complete set of 3-phase Fast Earthing switch of each type, including main circuit, enclosure, driving mechanism and support Insulator etc. to enable complete one to one replacement of all applicable type of Earth Switch by spare (if applicable)	Set	1	1
3.4	Copper contact fingers & corona shield for dis-connector male & female contact–for one complete (3-phase) dis-connector of each type	Set	1	1
3.5	Copper contact fingers & corona shield for Maintenance Earthing switch male & female contacts, for one complete (3- phase) earthing switch of each type	Set	1	1
3.6	Copper contact fingers & corona shield for Fast Earthing switch male & female contacts, for one complete (3-phase) earthing switch of each type (if applicable)	Set	1	1
3.7	Open/Close contactor assembly, timers, key interlock, interlocking coils, relays, push buttons, indicating lamps, Power contactors, resistors, fuses, MCBs & drive control cards etc. one of each type for one complete MOM box			
3.7.1	For Disconnecter	Set	2	1
3.7.2	For Maintenance Earth switch	Set	2	1
3.7.3	For Fast Earthing Switch (if applicable)	Set	2	1
3.8	Limit switches and Aux. Switches for one complete MOM box			
3.8.1	For Disconnecter	Set	2	1
3.8.2	For Maintenance earth switch	Set	2	1
3.8.3	For Fast Earthing Switch (if applicable)	Set	2	1
3.9	Drive Mechanism of each type			
3.9.1	For Disconnecter	Set	2	1
3.9.2	For Maintenance earth switch	Set	2	1
3.9.3	For Fast Earthing Switch (if applicable)	Set	2	1
3.10	Motor for Drive Mechanism of each type			
3.10.1	For Disconnecter	Set	3	1
3.10.2	For Maintenance earth switch	Set	3	1

**STANDARD MANDATORY SPARES FOR GAS INSULATED SWITCHGEAR**

3.10.3	For Fast Earthing Switch (if applicable)	Set	3	1
<b>4.0</b>	<b>CURRENT TRANSFORMER</b>			
4.1	Complete CT of each type and rating as supplied with enclosure and primary conductors to enable one to one replacement of all applicable type/rating of CT by spare	Nos.	2	1
<b>5.0</b>	<b>Voltage Transformer</b>			
5.1	Complete PT of each type with enclosure to enable one to one replacement of all applicable type/rating of VT by spare (if applicable)	No.	1	1
<b>6.0</b>	<b>SURGE ARRESTOR</b>			
6.1	Complete Gas insulated Surge arrester of each type and ratings with enclosure and insulator (if applicable)	No.	1	1
6.2	Surge counter/ monitor of each type (if applicable)	No.	2	1
<b>7.0</b>	<b>Local Control Cubicle (LCC)</b>			
7.1	Aux. relays, Contactors, Push Buttons, Switches, Lamps, Annunciation Windows, MCB, Fuses, Timers, Terminal Blocks etc. of each type & rating	Set	5	2

Note:

1. Any equipment which is not supplied as main equipment, mandatory spare for that is not envisaged.
2. Any equipment specified in Technical Specification with different types (including different current ratings), if the contractor has supplied higher rating equipment against such different types of equipment, mandatory spare for higher rating only shall be acceptable.

## STANDARD MANDATORY SPARES FOR GAS INSULATED SWITCHGEAR

Sl. No.	Description	Unit	Quantity (New S/s)	Quantity (Extn. S/s)
<b>For 220kV and 132kV Voltage Class as applicable</b>				
1.0	<b>General</b>			
1.1	Complete GIS modules, along with enclosure, all active parts such as conductor, conductor joints, shields, end covers etc. for each type of <ul style="list-style-type: none"> <li>➤ Bus Bar Sections (including Bus Bar Interconnection Modules)</li> <li>➤ Bus Ducts Sections (including Compensators/expansion joints/bellows)</li> <li>➤ Bends</li> <li>➤ SF6/Air Bushing.</li> <li>➤ Oil/SF6 Bushing</li> <li>➤ Cable Termination kit</li> </ul>	Set	1	1
1.2	SF6 gas Pressure Relief Device assembly of each type	Set	1	1
1.3	SF6 Pressure gauge cum switch /Density monitors and pressure switch as applicable, of each type	Set	5	3
1.4	Coupling device for pressure gauge cum switch for connecting Gas handling plant of each type	Set	2	2
1.5	Rubber Gaskets, "O" Rings and Seals for SF6 gas for GIS enclosures of each type	Set	5	3
1.6	Molecular filter for SF6 gas with filter bags (10 % of total weight)	Set	1	1
1.7	Control Valves for SF6 gas of each type	Set	3	1
1.8	SF6 gas (20 % of total gas quantity)	Lot	1	1
1.9	Pipe length (Copper or Steel as applicable) for SF6 Circuit of each type (if applicable)	Set	2	1
1.10	Locking device to keep the Dis-connectors (Isolators) and Earthing/Fast Earthing switches in close or open position in case of removal of the driving Mechanism	Set	2	1
1.11	UHF PD Sensors of each type along with BNC Connector	Nos.	5	2
1.12	Support Insulators (gas through) of each type (complete with metal ring etc.)	Nos.	10	4
1.13	Gas Barriers of each type (complete with metal ring etc.)	Nos.	10	4
1.14	SF6 to air bushing of each type complete in all respect	No.	2	1
<b>2.0</b>	<b>SF6 CIRCUIT BREAKER:</b>			
2.1	Complete Circuit Breaker (Three Phase) with interrupter, main circuit, enclosure and Marshalling Box with operating mechanism to enable one to one replacement of applicable type of CB by spare. (if applicable)	Set	1	1

## STANDARD MANDATORY SPARES FOR GAS INSULATED SWITCHGEAR

2.3	Fixed, moving and arcing contacts including insulating nozzles of each type (for Main Chamber & PIR Chamber as applicable)	Set	1	1
2.4	Trip coil assembly with resistor as applicable	Set	3	3
2.5	Closing coil assembly with resistor as applicable	Set	3	3
2.6	Relays, Power contactors, push buttons, timers & MCBs etc. of each type	Set	1	1
2.7	Auxiliary switch assembly of each type	Set	3	1
2.8	Operation Counter	Set	3	1
2.9	Windscope / Observing window of each type	Set	2	2
<b>2.11</b>	<b>For Hydraulic Operated Mechanism, if applicable</b>			
2.11.1	Hydraulic operating mechanism with drive motor of each type	Set	3	1
2.11.2	Ferrules, joints and couplings of each type	Set	3	1
2.11.3	Hydraulic filter of each type	Set	3	1
2.11.4	Hose pipe of each type	Set	3	1
2.11.5	N2 Accumulator of each type	Set	3	1
2.11.6	Valves of each type	Set	3	1
2.11.7	Pipe length (copper & steel) of each size & type	Set	3	1
2.11.8	Pressure switches of each type	Set	3	1
2.11.9	Pressure gauge with coupling device of each type	Set	3	1
2.11.10	Hydraulic oil (20% of total Oil quantity)	Set	1	1
2.11.11	Pressure Relief Device of each type	Set	3	1
2.12	<b>For Spring Operated Mechanism, if applicable</b>			
2.12.1	Complete Spring Operating Mechanism including charging mechanism etc. of each type	Set	3	1
2.12.2	Spring Charging Motor	Nos.	2	1
2.13	<b>For Hydraulic-Spring Operated Mechanism, if applicable</b>			
2.13.1	Complete Hydraulic-Spring Operating Mechanism including charging mechanism etc. of each type	Set	3	1
2.13.2	Spring Charging Motor	Nos.	2	1
2.13.3	Pressure switches of each type	Set	3	1
2.13.4	Pressure gauge with coupling device of each type	Set	3	1
<b>3.0</b>	<b>Disconnecter Switches/Earthing Switches:</b>			
3.1	Complete set of 3-phase dis-connector of each type including main circuit, enclosure, driving mechanism and support Insulator etc. to enable complete one to one replacement of all applicable type of Isolator by spare	Set	1	1
3.2	Complete set of 3-phase Maintenance Earthing switch of each type, including main circuit, enclosure, driving mechanism and	Set	1	1

**STANDARD MANDATORY SPARES FOR GAS INSULATED SWITCHGEAR**

	support Insulator etc to enable complete one to one replacement of all applicable type of Earth Switch by spare			
3.3	Complete set of 3-phase Fast Earthing switch of each type, including main circuit, enclosure, driving mechanism and support Insulator etc. to enable complete one to one replacement of all applicable type of Earth Switch by spare (if applicable)	Set	1	1
3.4	Copper contact fingers & corona shield for dis-connector male & female contact—for one complete (3-phase) dis-connector of each type	Set	1	1
3.5	Copper contact fingers & corona shield for Maintenance Earthing switch male & female contacts, for one complete (3- phase) earthing switch of each type	Set	1	1
3.6	Copper contact fingers & corona shield for Fast Earthing switch male & female contacts, for one complete (3-phase) earthing switch of each type (if applicable)	Set	1	1
3.7	Open/Close contactor assembly, timers, key interlock, interlocking coils, relays, push buttons, indicating lamps, Power contactors, resistors, fuses, MCBs & drive control cards etc. one of each type for one complete MOM box			
3.7.1	For Disconnector	Set	2	1
3.7.2	For Maintenance Earth switch	Set	2	1
3.7.3	For Fast Earthing Switch (if applicable)	Set	2	1
3.8	Limit switches and Aux. Switches for one complete MOM Box			
3.8.1	For Disconnector	Set	2	1
3.8.2	For Maintenance earth switch	Set	2	1
3.8.3	For Fast Earthing Switch (if applicable)	Set	2	1
3.9	Drive Mechanism of each type			
3.9.1	For Disconnector	Set	2	1
3.9.2	For Maintenance earth switch	Set	2	1
3.9.3	For Fast Earthing Switch (if applicable)	Set	2	1
3.10	Motor for Drive Mechanism of each type			
3.10.1	For Disconnector	Set	3	1
3.10.2	For Maintenance earth switch	Set	3	1
3.10.3	For Fast Earthing Switch (if applicable)	Set	3	1
<b>4.0</b>	<b>CURRENT TRANSFORMER</b>			
4.1	Complete CT of each type and rating as supplied with enclosure and primary conductors to enable one to one replacement of all applicable type/rating of CT by spare	Nos.	2	1
<b>5.0</b>	<b>Voltage Transformer</b>			

**STANDARD MANDATORY SPARES FOR GAS INSULATED SWITCHGEAR**

5.1	Complete PT of each type with enclosure to enable one to one replacement of all applicable type/rating of VT by spare (if applicable)	No.	1	1
<b>6.0</b>	<b>SURGE ARRESTOR</b>			
6.1	Complete Gas insulated Surge arrester of each type and ratings with enclosure and insulator (if applicable)	No.	1	1
6.2	Surge counter/ monitor of each type (if applicable)	No.	2	1
<b>7.0</b>	<b>Local Control Cubicle (LCC)</b>			
7.1	Aux. relays, Contactors, Push Buttons, Switches, Lamps, Annunciation Windows, MCB, Fuses, Timers, Terminal Blocks etc. of each type & rating	Set	5	2

## Note:

1. Any equipment which is not supplied as main equipment, mandatory spare for that is not envisaged.
2. Any equipment specified in Technical Specification with different types (including different current ratings), if the contractor has supplied higher rating equipment against such different types of equipment, mandatory spare for higher rating only shall be acceptable.

## STANDARD MANDATORY SPARES FOR HYBRID GIS/MTS ASSEMBLY

Sl. No.	Description	Unit	Quantity
<b>For 220 kV Voltage Class</b>			
1.0	<b>General</b>		
1.1	Complete Hybrid Gas Insulated Switchgear (GIS) Assembly/ Complete Mixed Technology Gas Insulated Switchgear (MTS) Assembly-Line/ICT Feeder bay (As defined in Technical Specification)	Set	As Per BPS*
1.2	Complete Hybrid Gas Insulated Switchgear (GIS) Assembly/ Complete Mixed Technology Gas Insulated Switchgear (MTS) Assembly- Bus Sectionalizer bay (As defined in Technical Specification)	Set	1
1.3	Complete Hybrid Gas Insulated Switchgear (GIS) Assembly/ Complete Mixed Technology Gas Insulated Switchgear (MTS) Assembly- Bus Coupler bay (As defined in Technical Specification)	Set	1
1.4	Complete GIS modules, along with enclosure, all active parts such as conductor, conductor joints, shields, end covers etc. for each type of <ul style="list-style-type: none"> <li>➤ Straight Joints</li> <li>➤ Bends</li> <li>➤ SF6/Air Bushing.</li> <li>➤ Cable Termination kit</li> </ul>	Set	1
1.5	SF6 gas Pressure Relief Device assembly of each type	Set	1
1.6	SF6 Pressure gauge cum switch /Density monitors and pressure switch as applicable, of each type	Set	2
1.7	Coupling device for pressure gauge cum switch for connecting Gas handling plant of each type	Set	2
1.8	Rubber Gaskets, "O" Rings and Seals for SF6 gas for GIS enclosures of each type	Set	2
1.9	Molecular filter for SF6 gas with filter bags (10 % of total weight)	Set	1
1.10	Control Valves for SF6 gas of each type	Set	2
1.11	SF6 gas (20 % of total gas quantity)	Lot	1
1.12	Pipe length (Copper or Steel as applicable) for SF6 Circuit of each type (if applicable)	Set	1
1.13	Locking device to keep the Dis-connectors (Isolators) and Earthing/Fast Earthing switches in close or open position in case of removal of the driving Mechanism	Set	1
1.15	Support Insulators (gas through) of each type (complete with metal ring etc.)	Nos.	2
1.14	Gas Barriers of each type (complete with metal ring etc.)	Nos.	2
1.15	SF6 to air bushing of each type complete in all respect	No.	1
<b>2.0</b>	<b>SF6 CIRCUIT BREAKER:</b>		

**STANDARD MANDATORY SPARES FOR HYBRID GIS/MTS ASSEMBLY**

2.1	Complete Circuit Breaker (one phase) with interrupter, main circuit, enclosure and Marshalling Box with operating mechanism to enable one to one replacement of applicable type of CB by spare. (if applicable)	Set	1
2.3	Fixed, moving and arcing contacts including insulating nozzles of each type (for Main Chamber & PIR Chamber as applicable)	Set	1
2.4	Trip coil assembly with resistor as applicable	Set	3
2.5	Closing coil assembly with resistor as applicable	Set	3
2.6	Relays, Power contactors, push buttons, timers & MCBs etc. of each type	Set	1
2.7	Auxiliary switch assembly of each type	Set	1
2.8	Operation Counter	Set	3
2.9	Windoscope / Observing window of each type	Set	1
<b>2.11</b>	<b>For Hydraulic Operated Mechanism, if applicable</b>		
2.11.1	Hydraulic operating mechanism with drive motor of each type	Set	1
2.11.2	Ferrules, joints and couplings of each type	Set	1
2.11.3	Hydraulic filter of each type	Set	1
2.11.4	Hose pipe of each type	Set	1
2.11.5	N2 Accumulator of each type	Set	1
2.11.6	Valves of each type	Set	1
2.11.7	Pipe length (copper & steel) of each size & type	Set	1
2.11.8	Pressure switches of each type	Set	1
2.11.9	Pressure gauge with coupling device of each type	Set	1
2.11.10	Hydraulic oil (20% of total Oil quantity)	Set	1
2.11.11	Pressure Relief Device of each type	Set	1
<b>2.12</b>	<b>For Spring Operated Mechanism, if applicable</b>		
2.12.1	Complete Spring Operating Mechanism including charging mechanism etc. of each type	Set	1
2.12.2	Spring Charging Motor	Nos.	1
<b>2.13</b>	<b>For Hydraulic-Spring Operated Mechanism, if applicable</b>		
2.13.1	Complete Hydraulic-Spring Operating Mechanism including charging mechanism etc. of each type	Set	1
2.13.2	Spring Charging Motor	Nos.	1
2.13.3	Pressure switches of each type	Set	1
2.13.4	Pressure gauge with coupling device of each type	Set	1
<b>3.0</b>	<b>Disconnecter Switches/Earthing Switchis:</b>		

**STANDARD MANDATORY SPARES FOR HYBRID GIS/MTS ASSEMBLY**

3.1	Complete set of 3-phase dis-connector of each type including main circuit, enclosure, driving mechanism and support Insulator etc. to enable complete one to one replacement of all applicable type of Isolator by spare	Set	1
3.2	Complete set of 3-phase Maintenance Earthing switch of each type, including main circuit, enclosure, driving mechanism and support Insulator etc to enable complete one to one replacement of all applicable type of Earth Switch by spare	Set	1
3.3	Complete set of 3-phase Fast Earthing switch of each type, including main circuit, enclosure, driving mechanism and support Insulator etc. to enable complete one to one replacement of all applicable type of Earth Switch by spare (if applicable)	Set	1
3.4	Copper contact fingers & corona shield for dis-connector male & female contact—for one complete (3-phase) dis-connector of each type	Set	1
3.5	Copper contact fingers & corona shield for Maintenance Earthing switch male & female contacts, for one complete (3- phase) earthing switch of each type	Set	1
3.6	Copper contact fingers & corona shield for Fast Earthing switch male & female contacts, for one complete (3-phase) earthing switch of each type (if applicable)	Set	1
3.7	Open/Close contactor assembly, timers, key interlock, interlocking coils, relays, push buttons, indicating lamps, Power contactors, resistors, fuses, MCBs & drive control cards etc. one of each type for one complete MOM box		
3.7.1	For Disconnecter	Set	1
3.7.2	For Maintenance Earth switch	Set	1
3.7.3	For Fast Earthing Switch (if applicable)	Set	1
3.8	Limit switches and Aux. Switches for one complete MOM box		
3.8.1	For Disconnecter	Set	1
3.8.2	For Maintenance earth switch	Set	1
3.8.3	For Fast Earthing Switch (if applicable)	Set	1
3.9	Drive Mechanism of each type		
3.9.1	For Disconnecter	Set	1
3.9.2	For Maintenance earth switch	Set	1
3.9.3	For Fast Earthing Switch (if applicable)	Set	1
3.10	Motor for Drive Mechanism of each type		
3.10.1	For Disconnecter	Set	1
3.10.2	For Maintenance earth switch	Set	1
3.10.3	For Fast Earthing Switch (if applicable)	Set	1
<b>4.0</b>	<b>CURRENT TRANSFORMER</b>		

**STANDARD MANDATORY SPARES FOR HYBRID GIS/MTS ASSEMBLY**

4.1	Complete CT of each type and rating as supplied with enclosure and primary conductors to enable one to one replacement of all applicable type/rating of CT by spare	Nos.	1
<b>5.0</b>	<b>Voltage Transformer</b>		
5.1	Complete PT of each type with enclosure to enable one to one replacement of all applicable type/rating of VT by spare (if applicable)	No.	1
<b>6.0</b>	<b>Local Control Cubicle (LCC)</b>		
7.1	Aux. relays, Contactors, Push Buttons, Switches, Lamps, Annunciation Windows, MCB, Fuses, Timers, Terminal Blocks etc. of each type & rating	Set	2

## Note:

1. Any equipment which is not supplied as main equipment, mandatory spare for that is not envisaged.
2. Any equipment specified in Technical Specification with different types (including different current ratings), if the contractor has supplied higher rating equipment against such different types of equipment, mandatory spare for higher rating only shall be acceptable.
3. \*BPS Quantity for Mandatory spare of complete HYBRID GIS/MTS Assembly shall be minimum 1 (One) No. per 6 (six) feeders bays and shall be minimum 2 (Two) Nos. for more than 06 feeder bays.

ANNEXURE -A  
(SHEET 2 OF 2)

NOTES :

1). PROVISION OF RUPTURE DISC, ABSORBER, GAS FILLING & GAS MONITORING ARRANGEMENT TO BE KEPT IN EACH GAS COMPARTMENT.

\*\* NUMBER OF GAS COMPARTMENTS IN THIS SECTION SHALL BE AS PER THE ACTUAL LAYOUT & SHALL BE FINALISED DURING DETAILED ENGG.

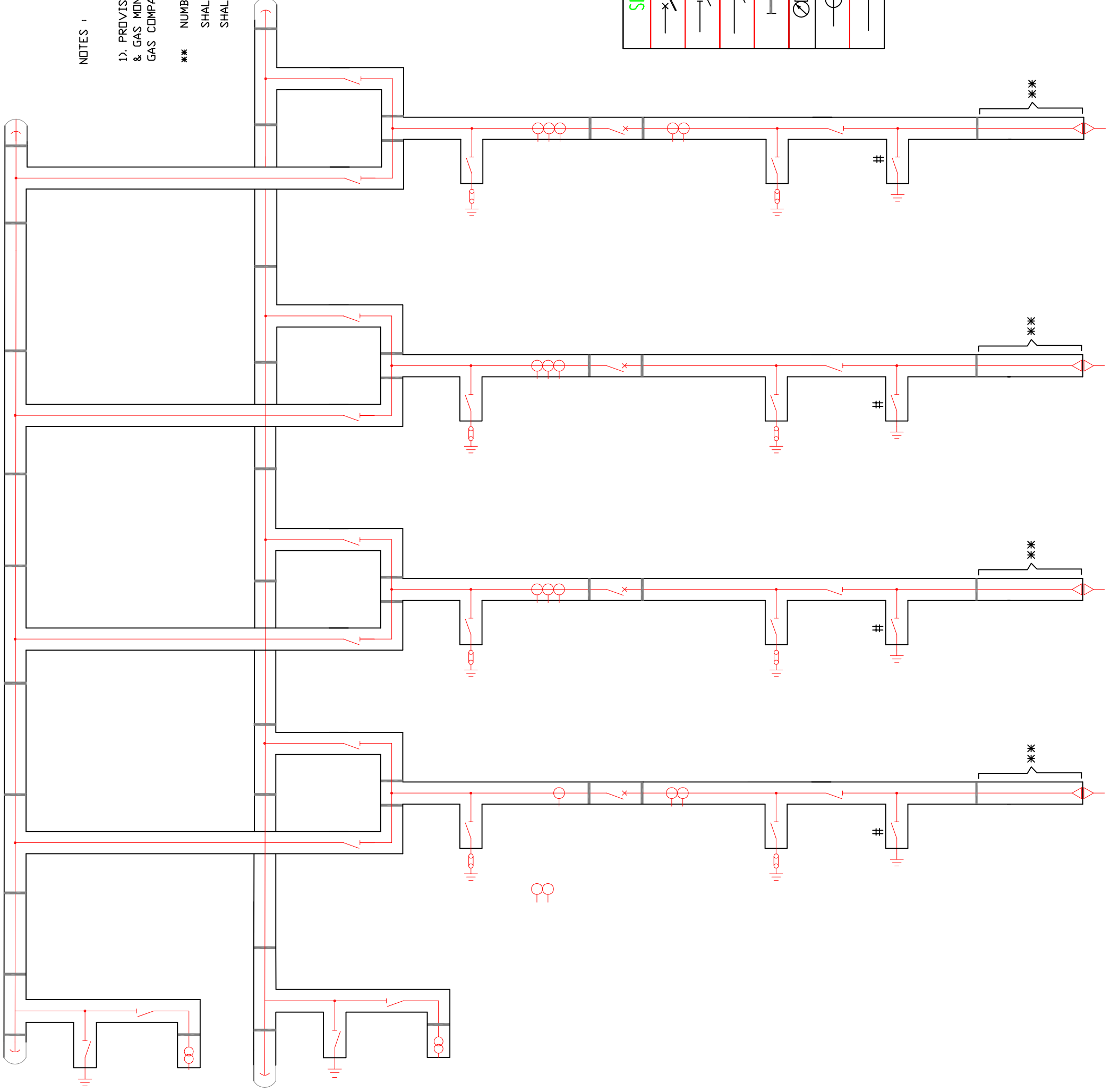

LEGENDS

SIGN	NAME	DESCRIPTION
	CB	CIRCUIT BREAKER
	DS	DISCONNECTING SWITCH
	ES/FES #	EARTHING SWITCH
	CT	CURRENT TRANSFORMER
	BSG	SF6/AIR BUSHING

FOR TENDER PURPOSE ONLY

POWER GRID CORPORATION OF INDIA LIMITED  
GOVERNMENT OF INDIA ENTERPRISE

PROJECT:	GIS SUBSTATION		
TITLE:	TYPICAL GAS SCHEMATIC DIAGRAM (DOUBLE MAIN SCHEME)		
DATE DRAWN	05.04.2018	CHKD	APPD
DRG. NO.	C/ENGG/GIS/GSD/02	REV.	2
NTS			

NIT No. 100798\_Enquiry No. 61G27000069 Dated 23-06-2026

REV. 1	DRG. NO. C/ENGG/GIS/GSD/01	NTS	APPD.	CHKD.	DRAWN.	DATE	29.04.2014
PROJECT: GIS SUBSTATION			P. JAYCHANDRAN		HIMANSHU		
TITLE: TYPICAL GAS SCHEMATIC DIAGRAM (ONE & HALF BREAKER SCHEME)			ANUJ BHUTANI		29.04.2014		

(A GOVERNMENT OF INDIA ENTERPRISE)

**POWER GRID CORPORATION OF INDIA LIMITED**

FOR TENDER PURPOSE ONLY

SIGN	NAME	DESCRIPTION
◇	BSG	SF6/AIR BUSHING
⊥	ES	INSULATING EARTH SWITCH
○	CT	CURRENT TRANSFORMER
◇	—	BARRIER INSULATOR
⊥	ES/FES#	EARTHING SWITCH
/	DS	DISCONNECTING SWITCH
/x	CB	CIRCUIT BREAKER
◇		

NOTES :

- PROVISION OF RUPTURE DISC, ABSORBER, GAS FILLING & GAS MONITORING ARRANGEMENT TO BE KEPT IN EACH GAS COMPARTMENT.
- THIS DRG IS INDICATIVE AND APPROVAL FOR GAS SLD FOR THE PROJECT SCOPE SHALL BE TAKEN DURING DETAILED ENGINEERING. SHALL BE AS PER THE ACTUAL LAYOUT & \*\* NUMBER OF GAS COMPARTMENTS IN THIS SECTION SHALL BE FINALISED DURING DETAILED ENGG.

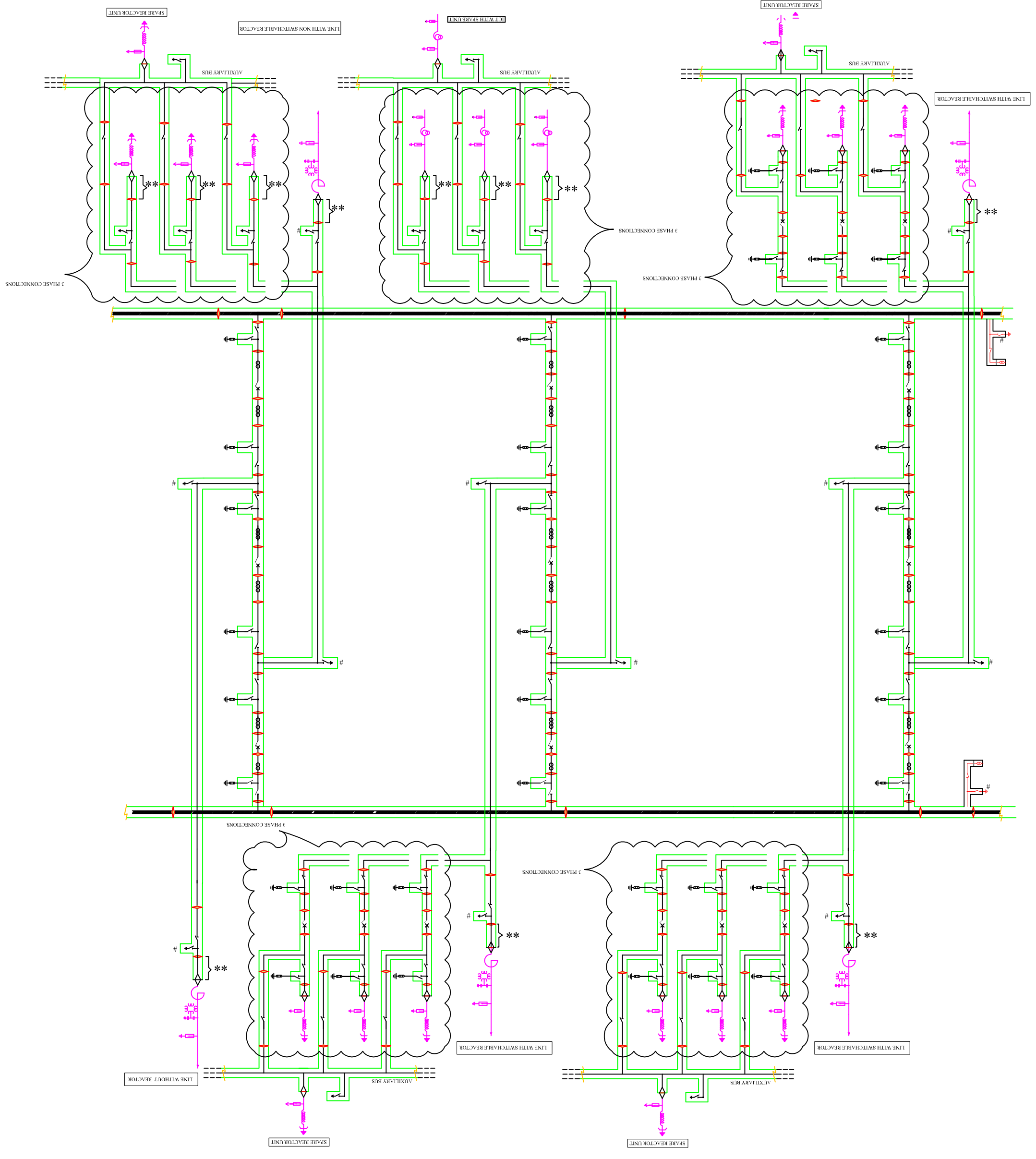

**SECTION-3 OF TECHNICAL SPECIFICATION  
Doc No. TB-PBTU-GIS-PGCIL-SS171T  
765kV and 400kV Gas Insulated Switchgear & its  
accessories**

## **TECHNICAL SPECIFICATION SECTION-GENERAL TECHNICAL REQUIREMENTS**



### **REMARKS**

**PLEASE READ TERMINOLOGY OF SECTION-3 OF TECHNICAL SPECIFICATION AS FOLLOWS:**

1. "GTR" as "Section-3 of technical specification"
2. "Powergrid" as "BHEL/Powergrid".
3. "Employer" as "Powergrid".
4. "Contractor" as "bidder".



**पावर ग्रिड कार्पोरेशन आफ इन्डिया लिमिटेड**

*(भारत सरकार का उद्यम)*

**Power Grid Corporation of India Limited**

*(A Government of India Enterprises)*

**SECTION-GENERAL TECHNICAL REQUIREMENTS (GTR)**

**Contents**

1.0	FOREWORD .....	2
2.0	GENERAL REQUIREMENT .....	2
3.0	STANDARDS .....	3
4.0	SERVICES TO BE PERFORMED BY THE EQUIPMENT BEING FURNISHED .....	3
5.0	ENGINEERING DATA AND DRAWINGS .....	6
6.0	MATERIAL/ WORKMANSHIP .....	8
7.0	DESIGN IMPROVEMENTS / COORDINATION .....	11
8.0	QUALITY ASSURANCE PROGRAMME .....	11
9.0	TYPE TESTING & CLEARANCE CERTIFICATE .....	17
10.0	TESTS .....	18
11.0	PACKAGING & PROTECTION.....	19
12.0	FINISHING OF METAL SURFACES .....	20
12.3	PAINTING .....	20
13.0	HANDLING, STORING AND INSTALLATION .....	22
14.0	TOOLS .....	23
15.0	AUXILIARY SUPPLY .....	24
16.0	SUPPORT STRUCTURE .....	24
17.0	CLAMPS AND CONNECTORS INCLUDING TERMINAL CONNECTORS .....	25
18.0	CONTROL CABINETS, JUNCTION BOXES, TERMINAL BOXES MARSHALLING BOXES .....	26
	FOR OUTDOOR EQUIPMENT .....	26
19.0	DISPOSAL OF PACKING MATERIAL & WASTE FROM CONSTRUCTION SITE.....	27
20.0	TERMINAL BLOCKS AND WIRING .....	27
21.0	LAMPS & SOCKETS.....	28
22.0	BUSHINGS, HOLLOW COLUMN INSULATORS, SUPPORT INSULATORS:.....	29
23.0	MOTORS .....	30
24.0	TECHNICAL REQUIREMENT OF EQUIPMENTS.....	31

Annexure-A : Corona and Radio Interface Voltage (RIV) Test

Annexure-B: Seismic Withstand Test Procedure

Annexure-C: List of General Standards and codes

Annexure-D: List of General Standard/Document for second advance

Annexure-E: Comprehensive List of Drawings

Annexure-F: Assessment report from Main Contractor for proposed sub vendor's-List of Enclosure

Annexure-G: MQP & Inspection Level Requirement

Annexure-H: Specification of RTV coating on porcelain insulators

Annexure-I: Standard Drawing for open platform

Annexure-J: List of make for which type test reports are not required to be submitted

Annexure-K: List of Equipment's to be supplied from domestic manufacturer only

Annexure-L: Major Changes in GTR rev 15

## **SECTION-GENERAL TECHNICAL REQUIREMENTS (GTR)**

### **1.0 FOREWORD**

The provisions under this section are intended to supplement requirements for the materials, equipment's and services covered under other sections of tender documents and are not exclusive.

### **2.0 GENERAL REQUIREMENT**

2.1 a) All equipment/materials/items, as per Annexure-K, as applicable under present scope of works, shall be procured and supplied from domestic manufacturers only

Any imported equipment/material/item/parts/component (comprising of embedded systems) to be supplied under the contract shall be tested in the certified laboratories to check for any kind of embedded malware/trojans/cyber threats and for adherence to Indian Standards as per the directions issued by Ministry of Power/Govt. of India from time to time. In case of such import from specified "prior reference" countries, the requirement of prior permission from the Govt. of India including protocol for testing in certified and designated laboratories by Ministry of Power/Govt. of India shall also be complied with by the contractor.

The bidder/contractor shall list out the products and components producing Toxic e-waste under the contract and shall furnish to the Employer the procedure of safe disposal at the time of closing of the contract

2.1 b) The contractor shall furnish catalogues, engineering data, technical information, design documents, drawings etc., fully in conformity with the technical specification during detailed engineering.

2.2 It is recognised that the Contractor may have standardised on the use of certain components, materials, processes or procedures different from those specified herein. Alternate proposals offering similar equipment based on the manufacturer's standard practice will also be considered provided such proposals meet the specified designs, standard and performance requirements and are acceptable to Employer.

2.3 Wherever a material or article is specified or defined by the name of a particular brand, Manufacturer or Vendor, the specific name mentioned shall be understood as establishing type, function and quality and not as limiting competition.

2.4 Equipment furnished shall be complete in every respect with all mountings, fittings, fixtures and standard accessories normally provided with such equipment and/or needed for erection, completion and safe operation of the equipment as required by applicable codes though they may not have been specifically detailed in the Technical Specifications unless included in the list of exclusions. Materials and components which are minor in nature and incidental to the requirement but not specifically stated in the specification and bid price schedule, which are necessary for commissioning and satisfactory operation of the switchyard/ substation unless specifically excluded shall be deemed to be included in the scope of the specification and shall be supplied without any extra cost. All similar standard components/parts of similar standard equipment provided, shall be inter-changeable with one another.

## 2.5 The Contractor shall also be responsible for the overall co-ordination with internal /external agencies; Supplier of Employer's supplied equipments, project management, training of Employer's manpower, loading, unloading, handling, insurance, moving to final destination for successful erection, testing and commissioning of the substation /switchyard.

## **SECTION-GENERAL TECHNICAL REQUIREMENTS (GTR)**

- ## 2.6 The Contractor shall be responsible for safety of human and equipment during the working. It will be the responsibility of the Contractor to co-ordinate and obtain Electrical Inspector's clearance before commissioning. Any additional items, modification due to observation of such statutory authorities shall be provided by the Contractor at no extra cost to the Employer.

### **3.0 STANDARDS**

- 3.1 The works covered by the specification shall be designed, engineered, manufactured, built, tested and commissioned in accordance with the Acts, Rules, Laws and Regulations of India.
- 3.2 The equipment offered by the contractor shall at least conform to the requirements specified under relevant IS standard. In case of discrepancy between IS and other international standard, provisions of IS shall prevail. The Contractor shall also note that the list of standards presented in this specification at Annex-C is not complete. Whenever necessary, the list of standards shall be considered in conjunction with specific IS. If the IS standard is not available for an equipment/material, then other applicable International standard (IEC/Equivalent), as per the specification, shall be accepted.
- 3.3 The Contractor shall note that standards mentioned in the specification are not mutually exclusive or complete in themselves, but intended to compliment each other.
- 3.4 When the specific requirements stipulated in the specifications exceed or differ than those required by the applicable standards, the stipulation of the specification shall take precedence.
- 3.5 Other internationally accepted standards which ensure equivalent or better performance than that specified in the standards specified under Annexure-C/ individual sections for various equipments shall also, be accepted, however the salient points of difference shall be clearly brought out during detailed engineering along with English language version of such standard. The equipment conforming to standards other than specified under Annexure-C/individual sections for various equipments shall be subject to Employer's approval.

### **4.0 SERVICES TO BE PERFORMED BY THE EQUIPMENT BEING FURNISHED**

- 4.1 Switching surge over voltage and power frequency over voltage is specified in the system parameters below. In case of the 400kV system, the initial value of the temporary overvoltages could be 2.0 p.u. for 1-2 cycles. The equipment furnished under this specification shall perform all its functions and operate satisfactorily without showing undue strain, restrike etc under such over voltage conditions.
- 4.2 All equipments shall also perform satisfactorily under various other electrical, electromechanical and meteorological conditions of the site of installation.
- 4.3 All equipment shall be able to withstand all external and internal mechanical, thermal and electromechanical forces due to various factors like wind load, temperature variation, ice & snow, (wherever applicable) short circuit etc for the equipment.
- # 4.4 The Contractor shall design terminal connectors of the equipment taking into account various forces as mentioned at Sl.No.4.3 that are required to withstand.
- 4.5 The equipment shall also comply to the following:
- a) To facilitate erection of equipment, all items to be assembled at site shall be "match marked".
- # If indicated in Section-1

**SECTION-GENERAL TECHNICAL REQUIREMENTS (GTR)**

- b) All piping, if any between equipment control cabinet/operating mechanism to marshalling box of the equipment, shall bear proper identification to facilitate the connection at site.

4.6

**System Parameter****765kV, 400kV & 220kV System**

SL No	Description of parameters	765kV System	400kV System	220kV System
1.	System operating voltage	765kV	400kV	220kV
2.	Maximum operating voltage of the system (rms)	800kV	420kV	245kV
3.	Rated frequency	50HZ	50Hz	50Hz
4.	No. of phase	3	3	3
5.	Rated Insulation levels			
i)	Full wave impulse withstand voltage (1.2/50 microsec.)	2100kVp	1550kVp	1050 kVp
ii)	Switching impulse withstand voltage (250/2500 micro sec.) dry and wet	1550kVp	1050kVp	-
iii)	One minute power frequency dry withstand voltage (rms)	830kV	630kV	-
iv)	One minute power frequency dry and wet withstand voltage (rms)	-	-	460kV
6.	Corona extinction voltage	508 kV	320kV	-
7.	Max. radio interference voltage for frequency between 0.5 MHz and 2 MHz	2500 $\mu$ V at 508 kV rms	1000 $\mu$ V at 266kV rms	1000 $\mu$ V at 156kV rms
8.	Minimum creepage distance - for Equipment other than Insulator string	20000 mm (24800 mm for coastal area)	10500 mm (13020 mm for coastal area)	6125 mm (7595 mm for coastal area)
	Minimum creepage distance - for Insulator String	As specified in Section-Switchyard Erection		
9.	Min. clearances			
i.	Phase to phase	7600mm (for conductor-conductor configuration) 9400mm (for rod-conductor configuration)	4000mm (for conductor-conductor configuration) 4200mm (for rod-conductor configuration)	2100 mm

**SECTION-GENERAL TECHNICAL REQUIREMENTS (GTR)**

SL No	Description of parameters	765kV System	400kV System	220kV System
ii.	Phase to earth	4900mm (for conductor-structure) 6400mm (for rod- structure)	3500 mm	2100 mm
iii)	Sectional clearances	10300 mm	6500 mm	5000 mm
10.	Rated short circuit current for 1 sec. duration	40kA/50kA (as applicable)	40kA/50kA/63 kA (as applicable)	40kA/50kA(as applicable)
11.	System neutral earthing	Effectively earthed	Effectively earthed	Effectively earthed

**132kV, 66kV, 52kV, 33kV & 11kV System**

SL No	Description of parameters	132 kV System	66kV System	52 kV System	33 kV System	11kV System
1.	System operating voltage	132kV	66kV	52kV	33kV	11kV
2.	Maximum operating voltage of the system(rms)	145kV	72.5kV	52kV	36kV	12kV
3.	Rated frequency	50Hz	50Hz	50Hz	50Hz	50Hz
4.	No. of phase	3	3	3	3	3
5.	Rated Insulation Levels					
i)	Full wave impulse withstand voltage (1.2/50 microsec.)	650 kVp	325 kVp	250 kVp	170 kVp	75 kVp
ii)	One minute power frequency dry and wet withstand voltage (rms)	275kV	140kV	95kV	70kV	28kV
6.	Max. radio interference voltage for frequency between 0.5 MHz and 2 MHz	500 $\mu$ V at 92kV rms	-	-	-	-
7.	Minimum creepage distance	3625 mm (4495mm for coastal area)	1813 mm (2248m m for coastal area)	1300m m (1612 mm for coastal area)	900 mm (1116m m for coastal area)	300 mm (372mm for coastal area)

**SECTION-GENERAL TECHNICAL REQUIREMENTS (GTR)**

SL No	Description of parameters	132 kV System	66kV System	52 kV System	33 kV System	11kV System
8.	Min. Clearance					
i.	Phase to phase	1300 mm	750 mm	530mm	320 mm	280 mm
ii.	Phase to earth	1300 mm	630 mm	480mm	320 mm	140 mm
iii.	Sectional clearances	4000 mm	3100 mm	3100m m	2800 mm	2800 mm
9.	Rated short circuit current	40kA/ 31.5 kA (as applicable) for 1 sec	31.5 kA for 3 sec/25kA for 3 Sec*	25kA for 1 Sec	25 kA for 3 sec	25 kA for 3 sec
10.	System neutral earthing	Effectively earthed	Effectively earthed	Effectively earthed	Effectively earthed	Effectively earthed

**Notes:**

1. The above parameters are applicable for installations up to an altitude of 1000m above mean sea level. For altitude exceeding 1000m, necessary altitude correction factor shall be applicable as per relevant IEC/IS.
2. The insulation and RIV levels of the equipments shall be as per values given in the Technical Specification of respective equipment.
3. Corona and radio interference voltage test and seismic withstand test procedures for equipments shall be in line with the procedure given at **Annexure-A** and **Annexure-B** respectively.
4. "\*" For tertiary loading Equipment's fault level shall be 25kA for 3 Sec. For other switchyard equipment shall be as specified in Section project.
5. Costal Area is to be considered only if defined in Section project.

**5.0 ENGINEERING DATA AND DRAWINGS**

5.1 The list of drawings/documents which are to be submitted to the Employer is enclosed in **Annexure-E**. In case any additional drawings/documents are required, the same shall also be submitted during execution of the contract.

5.2 The contractor shall submit all engineering Documents (Drawings/Design documents/data/detailed bill of quantity/ type test reports) through online Document Review and Engineering Approval Management System ( Herein after DREAMS) for the approval of the employer

**5.3 Drawings**

5.3.1 All drawings submitted by the Contractor shall be in sufficient detail to indicate the type, size, arrangement, material description, Bill of Materials, weight of each component, break-up for packing and shipment, dimensions, internal & the external connections, fixing arrangement required and any other information specifically requested in the specifications.

**SECTION-GENERAL TECHNICAL REQUIREMENTS (GTR)**

- 5.3.2 Drawings submitted by the Contractor shall be clearly marked with the name of the Employer, the unit designation, the specifications title, the specification number and the name of the Project. POWERGRID has standardized a large number of drawings/documents of various make including type test reports which can be used for all projects having similar requirements and in such cases no project specific approval (except for list of applicable drawings alongwith type test reports) is required. However, distribution copies of standard drawings/documents shall be submitted as per provision of the contract. All titles, noting, markings and writings on the drawing shall be in English. All the dimensions should be in SI units.
- 5.3.3 The review of these data by the Employer will cover only general conformance of the data to the specifications and documents, interfaces with the equipment provided under the specifications, external connections and of the dimensions which might affect substation layout. This review by the Employer may not indicate a thorough review of all dimensions, quantities and details of the equipment, materials, any devices or items indicated or the accuracy of the information submitted. This review and/or approval by the Employer shall not be considered by the Contractor, as limiting any of his responsibilities and liabilities for mistakes and deviations from the requirements, specified under these specifications and documents.
- 5.5 All manufacturing and fabrication work in connection with the equipment prior to the approval of the drawings shall be at the Contractor’s risk. The Contractor may make any changes in the design which are necessary to make the equipment conform to the provisions and intent of the Contract and such changes will again be subject to approval by the Employer. Approval of Contractor’s drawing or work by the Employer shall not relieve the contractor of any of his responsibilities and liabilities under the Contract.
- 5.6 All engineering data submitted by the Contractor after final process including review and approval by the Employer shall form part of the Contract Document and the entire works performed under these specifications shall be performed in strict conformity, unless otherwise expressly requested by the Employer in Writing.

**5.7 Approval Procedure**

The following schedule shall be followed generally for approval and for providing final documentation.

- i) Approval/comments/ by Employer on initial submission
- ii) Resubmission (whenever required)
- iii) Approval or comments
- iv) Furnishing of distribution copies (2 hard copies to each substation and one scanned copy (pdf format)
- v) Furnishing of distribution copies of test reports
  - (a) Type test reports (one scanned softcopy in

Please refer Activity Schedule attached along with commercial terms and conditions of tender specification

**SECTION-GENERAL TECHNICAL REQUIREMENTS (GTR)**

pdf format to each substation  
plus one for corporate centre  
& one hardcopy per substation)

- (b) Routine Test Reports -do-  
(one copy for each substation)
- vi) Furnishing of instruction/ operation manuals (2 copies per substation and one softcopy (pdf format) for corporate centre & per substation) On completion of Engineering
- (vii) As built drawings (two sets of hardcopy per substation & one softcopy (pdf format) for corporate centre & per substation) On completion of entire works

**NOTE :**

- (1) The contractor may please note that all resubmissions must incorporate all comments given in the earlier submission by the Employer or adequate justification for not incorporating the same must be submitted failing which the submission of documents is likely to be returned.
- (2) All drawings should be submitted in “DREAMS” Portal, further substation design drawings like SLD, GA, all layouts etc. shall also be submitted in AutoCAD Version as a supporting document in DREAMS. SLD, GA & layout drawings shall be submitted for the entire substation in case of substation extension also.  
  
For civil drawings associated documents shall be submitted in STAAD/excel format as supporting document in DREAMS.
- (3) The instruction Manuals shall contain full details of drawings of all equipment being supplied under this contract, their exploded diagrams with complete instructions for storage, handling, erection, commissioning, testing, operation, trouble shooting, servicing and overhauling procedures.
- (4) If after the commissioning and initial operation of the substation, the instruction manuals require any modifications/additions/changes, the same shall be incorporated and the updated final instruction manuals shall be submitted by the Contractor to the Employer.
- (5) The Contractor shall furnish to the Employer catalogues of spare parts.
- (6) All As-built drawings/documents shall be certified by site indicating the changes before final submission.

5.8 The list of major drawings/documents to be approved to qualify for second advance as per Section SCC, shall be as per **Annexure-D**.

**6.0 MATERIAL/ WORKMANSHIP**

**6.1 General Requirement**

6.1.1 Where the specification does not contain references to workmanship, equipment, materials and components of the covered equipment, it is essential that the same must be new, of highest grade of the best quality of their kind, conforming to best engineering practice and suitable for the purpose for which they are intended.

## **SECTION-GENERAL TECHNICAL REQUIREMENTS (GTR)**

- 6.1.2 In case where the equipment, materials or components are indicated in the specification as “similar” to any special standard, the Employer shall decide upon the question of similarity. When required by the specification or when required by the Employer the Contractor shall submit, for approval, all the information concerning the materials or components to be used in manufacture. Machinery, equipment, materials and components supplied, installed or used without such approval shall run the risk of subsequent rejection, it is to be understood that the cost as well as the time delay associated with the rejection shall be borne by the Contractor.
- 6.1.3 The design of the Works shall be such that installation, future expansions, replacements and general maintenance may be undertaken with a minimum of time and expenses. Each component shall be designed to be consistent with its duty and suitable factors of safety, subject to mutual agreements. All joints and fastenings shall be devised, constructed and documented so that the component parts shall be accurately positioned and restrained to fulfill their required function. In general, screw threads shall be standard metric threads. The use of other thread forms will only be permitted when prior approval has been obtained from the Employer.
- 6.1.4 Whenever possible, all similar part of the Works shall be made to gauge and shall also be made interchangeable with similar parts. All spare parts shall also be interchangeable and shall be made of the same materials and workmanship as the corresponding parts of the Equipment supplied under the Specification. Where feasible, common component units shall be employed in different pieces of equipment in order to minimize spare parts stocking requirements. All equipment of the same type and rating shall be physically and electrically interchangeable.
- 6.1.5 All materials and equipment shall be installed in strict accordance with the manufacturer’s recommendation(s). Only first-class work in accordance with the best modern practices will be accepted. Installation shall be considered as being the erection of equipment at its permanent location. This, unless otherwise specified, shall include unpacking, cleaning and lifting into position, grouting, levelling, aligning, coupling of or bolting down to previously installed equipment bases/foundations, performing the alignment check and final adjustment prior to initial operation, testing and commissioning in accordance with the manufacturer’s tolerances, instructions and the Specification. All factory assembled rotating machinery shall be checked for alignment and adjustments made as necessary to re-establish the manufacturer’s limits suitable guards shall be provided for the protection of personnel on all exposed rotating and / or moving machine parts and shall be designed for easy installation and removal for maintenance purposes. The spare equipment(s) shall be installed at designated locations and tested for healthiness.
- 6.1.6 The Contractor shall apply oil and grease of the proper specification to suit the machinery, as is necessary for the installation of the equipment. Lubricants used for installation purposes shall be drained out and the system flushed through where necessary for applying the lubricant required for operation. The Contractor shall apply all operational lubricants to the equipment installed by him.
- 6.1.7 All oil, grease and other consumables used in the Works/Equipment shall be purchased in India unless the Contractor has any special requirement for the specific application of a type of oil or grease not available in India. If such is the case, he shall declare source of oil/grease /other consumables in the GTP/Drawings, where such oil or grease is available. He shall help Employer in establishing equivalent Indian make and Indian Contractor. The same shall be applicable to other consumables too.

### **6.2 Provisions For Exposure to Hot and Humid climate**

## **SECTION-GENERAL TECHNICAL REQUIREMENTS (GTR)**

Outdoor equipment supplied under the specification shall be suitable for service and storage under tropical conditions of high temperature, high humidity, heavy rainfall and environment favourable to the growth of fungi and mildew. The indoor equipments located in non-air conditioned areas shall also be of same type.

### **6.2.1 Space Heaters**

6.2.1.1 The heaters shall be suitable for continuous operation at 240V as supply voltage. On-off switch and fuse shall be provided.

6.2.1.2 One or more adequately rated thermostatically connected heaters shall be supplied to prevent condensation in any compartment. The heaters shall be installed in the compartment and electrical connections shall be made sufficiently away from below the heaters to minimize deterioration of supply wire insulation. The heaters shall be suitable to maintain the compartment temperature to prevent condensation.

### **6.2.2 FUNGI STATIC VARNISH**

Besides the space heaters, special moisture and fungus resistant varnish shall be applied on parts which may be subjected or predisposed to the formation of fungi due to the presence or deposit of nutrient substances. The varnish shall not be applied to any surface of part where the treatment will interfere with the operation or performance of the equipment. Such surfaces or parts shall be protected against the application of the varnish.

### **6.2.3 Ventilation opening**

Wherever ventilation is provided, the compartments shall have ventilation openings with fine wire mesh of brass to prevent the entry of insects and to reduce to a minimum the entry of dirt and dust.

### **6.2.4 Degree of Protection**

The enclosures of the Control Cabinets, Junction boxes and Marshalling Boxes, panels etc. to be installed shall comply with following degree of protection as detailed here under:

- a) Installed out door: IP- 55
- b) Installed indoor in air conditioned area: IP-31
- c) Installed in covered area: IP-52
- d) Installed indoor in non-air conditioned area where possibility of entry of water is limited: IP-41.
- e) For LT Switchgear (AC & DC distribution Boards): IP-52

The degree of protection shall be in accordance with IS/IEC60947; IS/IEC/60529 . Type test report for of relevant Degree of Protection test, shall be submitted for approval.

## **6.3 RATING PLATES, NAME PLATES AND LABELS**

6.3.1 Each main and auxiliary item of substation is to have permanently attached to it in a conspicuous position a rating plate of non-corrosive material upon which is to be engraved manufacturer's name, Customer Name, year of manufacture, equipment name, type or serial number together with details of the loading conditions under which the item of substation in question has been designed to operate, and such diagram plates as may be required by the Employer. The rating plate of each equipment shall be according to IS/ IEC requirement.

6.3.2 All such nameplates, instruction plates, rating plates of transformers, reactors, CB, CT, CVT, SA, Isolators, C & R panels and PLCC equipments shall be bilingual with Hindi

## **SECTION-GENERAL TECHNICAL REQUIREMENTS (GTR)**

inscription first followed by English. Alternatively two separate plates one with Hindi and the other with English inscriptions may be provided.

### **6.4 FIRST FILL OF CONSUMABLES, OIL AND LUBRICANTS**

All the first fill of consumables such as oils, lubricants, filling compounds, touch up paints, soldering/brazing material for all copper piping of circuit breakers and essential chemicals etc. which will be required to put the equipment covered under the scope of the specifications, into operation, shall be furnished by the Contractor unless specifically excluded under the exclusions in these specifications and documents.

### **7.0 DESIGN IMPROVEMENTS / COORDINATION**

7.1 The bidder shall offer the equipment meeting the requirement of the technical specification. However, the Employer or the Contractor may propose changes in the specification of the equipment or quality thereof and if the contractor & Employer agree upon any such changes, the specification shall be modified accordingly.

7.2 If any such agreed upon change is such that it affects the price and schedule of completion, the parties shall agree in writing as to the extent of any change in the price and/or schedule of completion before the Contractor proceeds with the change. Following such agreement, the provision thereof, shall be deemed to have been amended accordingly.

7.3 The Contractor shall be responsible for the selection and design of appropriate equipments to provide the best co-ordinated performance of the entire system. The basic design requirements are detailed out in this Specification. The design of various components, sub-assemblies and assemblies shall be so done that it facilitates easy field assembly and maintenance.

7.4 The Contractor has to coordinate designs and terminations with the agencies (if any) who are Consultants/Contractor for the Employer. The names of agencies shall be intimated to the successful bidders.

7.5 The Contractor will be called upon to attend design co-ordination meetings with the Engineer, other Contractor's and the Consultants of the Employer (if any) during the period of Contract. The Contractor shall attend such meetings at his own cost at POWERGRID Corporate Centre, Gurgaon (Haryana) or at mutually agreed venue as and when required and fully cooperate with such persons and agencies involved during those discussions.

### **8.0 QUALITY ASSURANCE PROGRAMME**

8.1 To ensure that the equipment and services under the scope of this Contract, whether manufactured or performed within the Contractor's Works or at his Sub-Contractor's premises or at the Employer's site or at any other place of Work as applicable, are in accordance with the specifications, the Contractor shall ensure suitable quality assurance programme to control such activities at all points necessary. A quality assurance programme of the Contractor shall be in line with ISO requirements & shall generally cover the following:

- a) The organisation structure for the management and implementation of the proposed quality assurance programme.
- b) System for Document and Data Control.
- c) Qualification and Experience data of Bidder's key personnel.

### **SECTION-GENERAL TECHNICAL REQUIREMENTS (GTR)**

- d) The procedure for purchases of materials, parts, components and selection of sub-Contractor's services including vendor analysis, source inspection, incoming raw material inspection, verification of material purchases etc.
- e) System for shop manufacturing and site erection controls including process controls, fabrication and assembly control.
- f) System for Control of non-conforming products including deviation dispositioning, if any and system for corrective and preventive actions based on the feedback received from the Customers and also internally documented system for Customer complaints.
- g) Inspection and test procedure both for manufacture and field activities.
- h) System for Control of calibration of testing and measuring equipment and the indication of calibration status on the instruments.
- i) System for indication and appraisal of inspection status.
- j) System of Internal Quality Audits, Management review and initiation of corrective and Preventive actions based on the above.
- k) System for authorising release of manufactured product to the Employer.
- l) System for maintenance of records.
- m) System for handling, storage and delivery.
- n) A quality plan detailing out the specific quality control measures and procedure adopted for controlling the quality characteristics relevant to each item of equipment furnished and /or service rendered.
- o) System for various field activities i.e. unloading, receipt at site, proper storage, erection, testing and commissioning of various equipment and maintenance of records. In this regard, the Employer has already prepared Standard Field Quality Plan for transmission line/substation equipments as applicable, Civil/erection Works which is required to be followed for associated works.

The Employer or his duly authorised representative reserves the right to carry out quality audit and quality surveillance of the system and procedure of the Contractor/his vendor's quality management and control activities.

#### **8.2 Quality Assurance Documents**

The Contractor shall ensure availability of the following Quality Assurance Documents:

- i) All Non-Destructive Examination procedures, stress relief and weld repair procedure actually used during fabrication, and reports including radiography interpretation reports.
- ii) Welder and welding operator qualification certificates.
- iii) Welder's identification list, welding operator's qualification procedure and welding identification symbols.
- iv) Raw Material test reports on components as specified by the specification and in the quality plan.
- v) The Manufacturing Quality Plan(MQP) indicating Customer Inspection Points (CIPs) at various stages of manufacturing and methods used to verify that the inspection and testing points in the quality plan were performed satisfactorily.

## **SECTION-GENERAL TECHNICAL REQUIREMENTS (GTR)**

- vi) Factory test results for testing required as per applicable quality plan/technical specifications/GTP/Drawings etc.
- vii) Stress relief time temperature charts/oil impregnation time temperature charts, wherever applicable.

### **8.3 INSPECTION, TESTING & INSPECTION CERTIFICATE**

8.3.1 Contractor shall procure bought out items from sub-vendors as per the list in "Compendium of Vendors" available on POWERGRID web-site [www.powergridindia.com](http://www.powergridindia.com) after ensuring compliance to the requirements/conditions mentioned therein. Contractor shall explore first the possibilities of procuring the bought out items from POWERGRID approved existing vendors. In case of their unavailability / non-response, Contractor may approach POWERGRID for additional sub-vendor approval. In that case, the assessment report of proposed sub vendor by Contractor along with the enclosures as per **Annexure-F** shall be submitted within 60 days of the award. The proposal shall be reviewed and approval will be accorded based on the verification of the document submitted and/or after the physical assessment of the works as the case may be. The physical assessment conducted by POWERGRID, if required, shall be on chargeable basis. Charges shall be as per the POWERGRID norms prevailing at that time, which shall be intimated by POWERGRID separately. If proposal for sub-vendor is submitted after 60 days, the Contractor's proposal normally will not be considered for current LOA. However, POWERGRID may process the case for developing more vendors for referred items, if found relevant. In all cases, It is the responsibility of the Contractor that Project activities do not suffer on account of delay in approval/non approval of a new sub-vendor.

The responsibility and the basis of inspection for various items & equipment is placed at **Annexure-G** along with the requirement of MQP (Manufacturing Quality Plan), ITP(Inspection & Test Plan), FAT(Factory Acceptance Test) which should be valid & POWERGRID approved and Level of inspection envisaged against each item.

Contractor shall ensure that order for items where MQP/ITP/FAT is required will be placed only on vendors having valid MQP/ITP/FAT and where the supplier's MQP/ITP/FAT is either not valid or has not been approved by POWERGRID, MQP shall be generally submitted as per POWERGRID format before placing order.

Items not covered under MQP/ITP/FAT shall be offered for inspection as per POWERGRID LOA/technical Specifications/POWERGRID approved data sheets/ POWERGRID approved drawings and relevant Indian/International standards.

**Inspection Levels:** For implementation of projects in a time bound manner and to avoid any delay in deputation of POWERGRID or its authorized representative, involvement of POWERGRID for inspection of various items / equipment will be based on the level below:

**Level –I:** Contractor to raise all inspection calls and review the report of tests carried out by the manufacturer, on his own, as per applicable standards/ POWERGRID specification, and submit to concerned POWERGRID inspection office/Inspection Engineer. CIP/MICC will be issued by POWERGRID based on review of test reports/certificates of manufacturers.

**Level – II:** Contractor to raise all inspection calls and carry out the inspection on behalf of POWERGRID on the proposed date of inspection as per applicable standards/specification. However, in case POWERGRID wishes to associate itself during inspection, the same would be intimated to

### **SECTION-GENERAL TECHNICAL REQUIREMENTS (GTR)**

Contractor and CIP/MICC will be issued by POWERGRID. Else, Contractor would submit their test reports/certificates to POWERGRID. CIP/MICC will be issued by POWERGRID based on review of test reports/certificates.

**Level - III:** Contractor to raise inspection calls for both, stage (as applicable) & final inspection and carry out the stage inspections (if applicable) on behalf of POWERGRID on the proposed date of inspection as per applicable standards/specification. However, in case POWERGRID wishes to associate itself during stage inspection, the same would be intimated to Contractor and CIP will be issued by POWERGRID. Else, Contractor would submit the test reports / certificates of stage inspection after their own review and CIP will be issued by POWERGRID based on review of test reports / certificates. Final inspection will be carried out by POWERGRID and CIP/MICC will be issued by POWERGRID.

**Level - IV:** Contractor to raise inspection calls for both, stage (as applicable) & final inspections. POWERGRID will carry out the inspection for both stage & final inspection as per applicable standards/specification and CIP/MICC will be issued by POWERGRID.

- 8.3.2 Contractor shall ensure that to implement the above inspection levels, particularly for the quality control and inspection at sub-vendor's works, they would depute sufficient qualified & experienced manpower in their Quality Control and Inspection department. Further, to assure quality of construction, Contractor shall have a separate workforce having appropriate qualification & experience and deploy suitable tools and plant for maintaining quality requirement during construction in line with applicable Field Quality Plan (FQP).
- 8.3.3 The Employer, his duly authorised representative and/or outside inspection agency acting on behalf of the Employer shall have at all reasonable times access to the Contractor's premises or Works and shall have the power at all reasonable times to ensure that proper Quality Management practices / norms are adhered to, inspect and examine the materials & workmanship of the Works, to carry out Quality/Surveillance Audit during manufacture or erection and if part of the Works is being manufactured or assembled at other premises or works. The Contractor shall obtain for the Employer and for his duly authorised representative permission to inspect as if the works were manufactured or assembled on the Contractor's own premises or works. The item/equipment, if found unsatisfactory with respect to workmanship or material is liable to be rejected. The observations for improvements during product/ process inspection by POWERGRID shall be recorded in Quality Improvement Register (available & maintained at works) for review & timely compliance of observations.
- 8.3.4 Contractor shall submit inspection calls over internet through POWERGRID website. The required vendor code and password to enable raising inspection call will be furnished to the main Contractor within 30 days of award of contract on submission of documents by Contractor. After raising the inspection calls, Contractor shall then proceed as per the message of that particular call which is available on the message board.
- 8.3.5 The Employer reserves the right to witness any or all type, acceptance and routine tests specified for which the Contractor shall give the Employer/Inspector Twenty one (21) days written notice of any material being ready for testing for each stage of testing as identified in the approved quality plan as customer inspection point(CIP) for indigenous inspections. All inspection calls for overseas material shall be given at least forty five (45) days in advance. Such tests shall be to the Contractor's account

**SECTION-GENERAL TECHNICAL REQUIREMENTS (GTR)**

- except for the expenses of the Inspection Engineer. The Employer/inspector, unless witnessing of the tests is waived by Employer, will attend such tests within Twenty one (21) days of the date of which the equipment is notified as being ready for test/inspection, failing which the Contractor may proceed with the test which shall be deemed to have been made in the Inspector's presence and he shall forthwith forward to the Inspector three copies of tests, duly certified. Contractor shall ensure, before giving notice for type test, that all drawings and quality plans have been got approved. The equipment shall be dispatched to site only after approval of Routine and Acceptance test results and Issuance of Dispatch Clearance in writing by the Employer. CIP/Material Inspection clearance certificate (MICC) shall be issued by the Employer after inspection of the equipment or review of test reports as applicable. Employer may waive off the presence of Employer's inspecting engineer. In that case test will be carried out as per approved QP and test certificate will be furnished by the supplier for approval. CIP/MICC will be issued only after review and approval of the test reports.
- 8.3.6 Contractor shall generally offer material for inspection as per supply bar chart approved by POWERGRID and not before 30 days from schedule indicated in the bar chart. In case Contractor offers material(s) for inspection prior to 30 days from the scheduled date with necessary approval of POWERGRID, POWERGRID shall inspect the material and issue CIP only. However, in such an exceptional case, MICC shall be issued only as per provision of original / revised approved supply schedule.
- 8.3.7 Contractor shall minimize the number of inspection calls by offering optimum quantities in each inspection call at the respective manufacturer's works.
- 8.3.8 Contractor shall inspect the material themselves and only after they are fully convinced about the Quality, they shall offer the material for POWERGRID inspection and shall also ensure that relevant portion of LOA/NOA, approved drawing and data sheets along with applicable Quality Plans are available at the works of Contractor or their Sub-vendor before the material is offered for inspection.
- 8.3.9 Contractor shall ensure that material which has been cleared for dispatch after inspection will be dispatched within 30 days in case of domestic supplies and within 60 days in case of Off-shore supplies from the date of issuance of CIP. Material which is not dispatched within stipulated time as above will be reoffered for POWERGRID inspection or specific approval of POWERGRID QA&I shall be obtained for delayed dispatch.
- 8.3.10 The Employer or IE shall give notice in writing to the Contractor, of any objection either to conformance to any drawings or to any equipment and workmanship which in his opinion is not in accordance with the Contract. The Contractor shall give due consideration to such objections and shall either make the modifications that may be necessary to meet the said objections or shall confirm in writing to the Employer/Inspection Engineer giving reasons therein, that no modifications are necessary to comply with the Contract.
- 8.3.11 All Test Reports and documents to be submitted in English during final inspection of equipment by POWERGRID or as and when required for submission.
- 8.3.12 When the factory tests have been completed at the Contractor's or Sub-Contractor's works, the Employer/Inspection Engineer(IE) shall issue a certificate to this effect within fifteen (15) days after completion of tests & submission of documents by Contractor/manufacturer but if the tests are not witnessed by the Employer/IE, the certificate shall be issued within fifteen (15) days of receipt of the Contractor's Test certificate by the Employer/IE. Contractor shall, on completion of all tests, submit test reports within Ten (10) days to POWERGRID IE. Failure of the Employer/IE to issue such a certificate shall not prevent the Contractor from proceeding with the Works.

### **SECTION-GENERAL TECHNICAL REQUIREMENTS (GTR)**

The completion of these tests or the issue of the certificate shall not bind the Employer to accept the equipment should, it, on further tests after erection, be found not to comply with the Contract.

- 8.3.13 In all cases, where the Contract provides for tests whether at the premises or works of the Contractor or of any Sub- Contractor, the Contractor, except where otherwise specified, shall provide free of charge such items as labour, materials, electricity, fuel, water, stores, apparatus and instruments as may be reasonably demanded by the Employer/Inspector or his authorised representative to carry out effectively such tests of the equipment in accordance with the Contract and shall give facilities to the Employer/Inspection Engineer or to his authorised representative to accomplish testing.
- 8.3.14 The inspection and acceptance by Employer and issue of Inspection Certificate thereon shall in no way limit the liabilities and responsibilities of the Contractor in respect of the agreed quality assurance programme forming a part of the Contract, or if such equipment is found to be defective at a later stage.
- 8.3.15 The Employer will have the right of having at his own expenses any other test(s) of reasonable nature carried out at Contractor's premises or at site or in any other place in addition of aforesaid type and routine tests, to satisfy that the material comply with the specification.
- 8.3.16 The Employer reserves the right for getting any additional field tests conducted on the completely assembled equipment at site to satisfy that material complies with specifications.
- 8.3.17 Rework/ Re-engineering, if any, on any item/equipment shall be carried out only after mutual discussions and in accordance with mutually agreed procedure. Contractor shall submit Joint Inspection Report of equipments under Re-Work/Re-Engineering alongwith procedure for the same to POWERGRID for approval, before taking up the Re-Work/Re-Engineering, failing which POWERGRID reserves the right to reject the equipment.
- 8.3.18 Contractor may establish a field test Laboratory to execute Civil Construction testing requirements at site with the condition that all testing equipment shall be calibrated from POWERGRID approved accredited Testing laboratories, with calibration certificates kept available at site and all testing personnel employed in the Field Testing Laboratories to be qualified and experienced Engineers or testing to be carried out at POWERGRID approved Third Party Laboratories.
- 8.3.19 Contractor shall ensure that all possible steps are taken to avoid damages to the equipment during transport, storage and erection.
- 8.3.20 Contractor shall implement additional stringent quality checks and preparation during installation of GIS at site (if applicable) as per POWERGRID approved guidelines/Technical specifications.
- 8.3.21 Contractor shall ensure commissioning of all CSDs along with Circuit Breakers wherever applicable.
- 8.3.22 For EHV transformers/reactors:**
- Insulation oil shall be as per POWERGRID Technical specifications and same grade shall be used for impregnation of the active part & testing at the works of Transformer/Reactor Manufacturer and as well as for filling the Transformer/Reactors at site. Contractor to ensure that windings for Transformer/Reactors are made in air-conditioned environment. Core-coil assembly shall be performed in positive pressurized dust controlled environment. Dust measurements shall be monitored

**SECTION-GENERAL TECHNICAL REQUIREMENTS (GTR)**

regularly at Transformer / Reactor Manufacturer works. Contractor shall ensure that respective civil foundations & Fire walls for Transformer/Reactors units to be commissioned, shall be made ready at concerned sites before receipt of Transformer/Reactors units. All the requisite material for Neutral & Delta Bus formation required for charging of complete bank of 765KV class 1-ph Transformer/Reactor units shall be made available at the concerned sites before receipt of the Transformer/Reactor units at site.

8.3.23 The Employer reserves the right to increase or decrease their involvement in inspections at Contractor's Works or at his Sub-Contractor's premises or at the Employer's site or at any other place of Work based on performance of Contractor/sub-Contractor.

**9.0 TYPE TESTING & CLEARANCE CERTIFICATE**

9.1 All equipment being supplied shall conform to type tests as per technical specification and shall be subject to routine tests in accordance with requirements stipulated under respective sections.



**SECTION-GENERAL TECHNICAL REQUIREMENTS (GTR)**



- 9.3 The Employer intends to repeat those type tests which are indicated in the price schedule and the same shall be payable as per provision of contract. The price of conducting type tests shall be included in Bid price and break up of these shall be given in the relevant schedule of Bid Proposal Sheets. These Type test charges would be considered in bid evaluation. In case Bidder does not indicate charges for any of the type tests or does not mention the name of any test in the price schedules, it will be presumed that the particular test has been offered free of charge. Further, in case any Bidder indicates that he shall not carry out a particular test, his offer shall be considered incomplete and shall be liable to be rejected. The Employer reserves the right to waive the repeating of type tests partly or fully and in case of waiver, test charges for the same shall not be payable.
- 9.4 The Employer reserves the right to witness any or all the type tests. The Employer shall bear all expenses for deputation of Employer's representative(s) for witnessing the type tests except in the case of re-deputation if any, necessitated due to no fault of the Employer.
- 9.5 The list of makes of various items, for which Type test reports are not required to be submitted are specified at Annexure-J.

**10.0 TESTS**

**10.1 Pre-commissioning Tests**

On completion of erection of the equipment and before charging, each item of the equipment shall be thoroughly cleaned and then inspected jointly by the Employer and the Contractor for correctness and completeness of installation and acceptability for charging, leading to initial pre-commissioning tests at Site. The list of pre-commissioning tests to be performed are given in respective chapters and shall be included in the Contractor's quality assurance programme.

**10.2 Commissioning Tests**

- 10.2.1 The available instrumentation and control equipment will to be used during such tests and the Employer will calibrate, all such measuring equipment and devices as far as practicable.
- 10.2.2 Any special equipment, tools and tackles required for the successful completion of the Commissioning Tests shall be arranged by the Contractor at his own cost.

### **SECTION-GENERAL TECHNICAL REQUIREMENTS (GTR)**

10.2.3 The specific tests requirement on equipment have been brought out in the respective chapters of the technical specification.

#### 10.3.4 **PRECOMMISSIONING, COMMISSIONING, TRIAL-RUN & COMPLETION**

As soon as the Facilities covered by these specifications are physically completed in all respects, the Pre commissioning, Commissioning, Trial-run and Completion of the Facilities, as mentioned below, shall be attained in accordance with the procedure given in the Conditions of Contract, Vol.-I of the Bidding Documents.

- (i) Pre commissioning : As per relevant Sections  
 (ii) Commissioning : Charging of the Facilities at rated voltage.

Further, wherever appearing in these specifications, the words-‘commissioning checks’, ‘installation checks’, ‘site tests’, ‘performance guarantee tests for fire protection system’, are to be considered as ‘pre commissioning checks’.

- (iii) Trial-run : Operation of the Facilities or any part thereof by the Contractor immediately after the Commissioning for a continuous period of 72 (Seventy two) hours continuously. In case of interruption due to problem/failure in the respective equipment, the contractor shall rectify the problem and after rectification, continuous 72 (Seventy two) hours period start after such rectification.

- (iv) Completion : Upon successful completion of Trial-run.

‘Guarantee Test(s)’ and/or ‘Functional Guarantees’ are applicable only for Substation Automation System as specified in Section-‘Substation Automation System.’

10.3. The Contractor shall be responsible for obtaining statutory clearances from the concerned authorities for commissioning the equipment and the switchyard. However necessary fee shall be reimbursed by POWERGRID on production of requisite documents.

#### **11.0 PACKAGING & PROTECTION**

11.1 All the equipments shall be suitably protected, coated, covered or boxed and crated to prevent damage or deterioration during transit, handling and storage at Site till the time of erection. On request of the Employer, the Contractor shall also submit packing details/associated drawing for any equipment/material under his scope of supply, to facilitate the Employer to repack any equipment/material at a later date, in case the need arises. While packing all the materials, the limitation from the point of view of availability of Railway wagon sizes in India should be taken into account. The Contractor shall be responsible for any loss or damage during transportation, handling and storage due to improper packing. Any demurrage, wharfage and other such charges claimed by the transporters, railways etc. shall be to the account of the Contractor. Employer takes no responsibility of the availability of the wagons.

11.2 All coated surfaces shall be protected against abrasion, impact, discolouration and any other damages. All exposed threaded portions shall be suitably protected with either a metallic or a non-metallic protecting device. All ends of all valves and pipings and conduit equipment connections shall be properly sealed with suitable devices to protect them from damage.

## SECTION-GENERAL TECHNICAL REQUIREMENTS (GTR)

### 12.0 FINISHING OF METAL SURFACES

12.1 All metal surfaces shall be subjected to treatment for anti-corrosion protection. All ferrous surfaces for external use unless otherwise stated elsewhere in the specification or specifically agreed, shall be hot-dip galvanized after fabrication. All steel conductors including those used for earthing/grounding (above ground level) shall also be galvanized according to IS: 2629.

### 12.2 HOT DIP GALVANISING

12.2.1 The minimum weight of the zinc coating shall be 610 gm/sq.m and minimum average thickness of coating shall be 86 microns for all items having thickness 6mm and above **and 900 gm/sq.m for coastal area (if defined in Section Project)** For items lower than 6mm thickness requirement of coating thickness shall be as per relevant ASTM. For surface which shall be embedded in concrete, the zinc coating shall be 610 gm/sq.m minimum **and 900 gm/sq.m for coastal area (if specified in Section-Project)**.

12.2.2 The galvanized surfaces shall consist of a continuous and uniform thick coating of zinc, firmly adhering to the surface of steel. The finished surface shall be clean and smooth and shall be free from defects like discoloured patches, bare spots, unevenness of coating, spelter which is loosely attached to the steel globules, spiky deposits, blistered surface, flaking or peeling off, etc. The presence of any of these defects noticed on visual or microscopic inspection shall render the material liable to rejection.

12.2.3 After galvanizing, no drilling or welding shall be performed on the galvanized parts of the equipment excepting that nuts may be threaded after galvanizing. Sodium dichromate or alternate approved treatment shall be provided to avoid formation of white rust after hot dip galvanization.

12.2.4 The galvanized steel shall be subjected to four numbers of one minute dips in copper sulphate solution as per IS-2633.

12.2.5 Sharp edges with radii less than 2.5 mm shall be able to withstand four immersions of the Standard Preece test. All other coatings shall withstand six immersions. The following galvanizing tests should essentially be performed as per relevant Indian Standards.

- Coating thickness
- Uniformity of zinc
- Adhesion test
- Mass of zinc coating

12.2.6 Galvanised material must be transported properly to ensure that galvanised surfaces are not damaged during transit. Application of touch-up zinc rich paint at site shall be allowed with approval of Engineer Incharge.

### 12.3 PAINTING

12.3.1 All sheet steel work shall be degreased, pickled, phosphated in accordance with the IS-6005 "Code of practice for phosphating iron and sheet". All surfaces, which will not be easily accessible after shop assembly, shall beforehand be treated and protected for the life of the equipment. The surfaces, which are to be finished painted after installation or require corrosion protection until installation, shall be shop painted with at least two coats of primer. Oil, grease, dirt and swaf shall be thoroughly removed by emulsion cleaning. Rust and scale shall be removed by pickling with dilute acid followed by washing with running water, rinsing with slightly alkaline hot water and drying.

### **SECTION-GENERAL TECHNICAL REQUIREMENTS (GTR)**

- 12.3.2 Hot Phosphating shall be done for phosphating process under pretreatment of sheets After phosphating, thorough rinsing shall be carried out with clean water followed by final rinsing with dilute dichromate solution and oven drying. The phosphate coating shall be sealed with application of two coats of ready mixed, stoving type zinc chromate primer. The first coat may be “flash dried” while the second coat shall be stoved.
- 12.3.3 After application of the primer, two coats of finishing synthetic enamel paint shall be applied, each coat followed by stoving. The second finishing coat shall be applied after inspection of first coat of painting.
- 12.3.4 The exterior and interior colour of the paint in case of new substations shall preferably be RAL 7032 for all equipment, marshalling boxes, junction boxes, control cabinets, panels etc. unless specifically mentioned under respective sections of the equipments. Glossy white colour inside the equipments /boards /panels/junction boxes is also acceptable. The exterior colour for panels shall be matching with the existing panels in case of extension of a substation. Each coat of primer and finishing paint shall be of slightly different shade to enable inspection of the painting. A small quantity of finishing paint shall be supplied for minor touching up required at site after installation of the equipments.
- 12.3.5 In case the contractor proposes to follow his own standard surface finish and protection procedures or any other established painting procedures, like electrostatic painting etc., the procedure shall be submitted during detailed engineering for Employer’s review & approval.
- 12.3.6 The colour scheme as given below shall be followed for Fire Protection and Air Conditioning systems

S.No.	PIPE LINE	Base colour	Band colour
<b><u>Fire Protection System</u></b>			
1	Hydrant and Emulsifier system pipeline/NIFPS	FIRE RED	-
2	Emulsifier system detection line - water	FIRE RED	Sea Green
3	Emulsifier system detection line -Air	FIRE RED	Sky Blue
4	Pylon support pipes	FIRE RED	
<b><u>Air Conditioning Plant</u></b>			
5	Refrigerant gas pipeline - at compressor suction	Canary Yellow	-
6	Refrigerant gas pipeline - at compressor discharge	Canary Yellow	Red
7	Refrigerant liquid pipeline	Dark Admiralty Green	-
8	Chilled water pipeline	Sea Green	-
9	Condenser water pipeline	Sea Green	Dark Blue

The direction of flow shall be marked by → (arrow) in black colour.



Base Colour Direction of flow Band Colour

- 12.3.7 For aluminium casted surfaces, the surface shall be with smooth finish. Further, in case of aluminium enclosures, the surface shall be coated with powder (coating thickness of 60 microns) after surface preparation for painting. For stainless steel surfaces, no painting is envisaged.

## **SECTION-GENERAL TECHNICAL REQUIREMENTS (GTR)**

12.3.8 Band colour is required for Emulsifier system detection line only if both water and air detection lines are present at the same substation. Further, band colour shall be applied at an interval of 2 meters approx. along the length and minimum width of band shall be 25mm.

### **13.0 HANDLING, STORING AND INSTALLATION**

13.1 In accordance with the specific installation instructions as shown on manufacturer's drawings or as directed by the Employer or his representative, the Contractor shall unload, store, erect, install, wire, test and place into commercial use all the equipment included in the contract. Equipment shall be installed in a neat, workmanlike manner so that it is level, plumb, square and properly aligned and oriented. Commercial use of switchyard equipment means completion of all site tests specified and energisation at rated voltage.

13.2 Contractor may engage manufacturer's Engineers to supervise the unloading, transportation to site, storing, testing and commissioning of the various equipment being procured by them separately. Contractor shall unload, transport, store, erect, test and commission the equipment as per instructions of the manufacturer's supervisory Engineer(s) and shall extend full cooperation to them.

13.3 The contractor must ensure that the open storage platform (as per Drawing No. C-ENGG-CVL-STD-PLATFORM-01, Rev.0) is constructed for storage of outdoor type equipment/material prior to commencement of delivery at site. Outdoor equipment shall be stored on open storage platform, properly covered with waterproof and dustproof covers to protect them from water seepage and moisture ingress.

However, all indoor equipments including control & protection panels, Communication equipments and operating mechanism boxes etc. of outdoor equipments shall be stored indoors.

Storage of equipment on top of another one is not permitted if the wooden packing is used and there is possibility of equipment/packing damage. Material opened for joint inspection shall be repacked properly as per manufacturer's recommendations.

During storage of material regular periodic monitoring of important parameters like oil level / leakage, SF6 / Nitrogen pressure etc. shall be ensured by the contractor.

13.4 In case of any doubt/misunderstanding as to the correct interpretation of manufacturer's drawings or instructions, necessary clarifications shall be obtained from the Employer. Contractor shall be held responsible for any damage to the equipment consequent to not following manufacturer's drawings/instructions correctly.

13.5 Where assemblies are supplied in more than one section, Contractor shall make all necessary mechanical and electrical connections between sections including the connection between buses. Contractor shall also do necessary adjustments/alignments for proper operation of circuit breakers, isolators and their operating mechanisms. All components shall be protected against damage during unloading, transportation, storage, installation, testing and commissioning. Any equipment damaged due to negligence or carelessness or otherwise shall be replaced by the Contractor at his own expense.

13.6 Contractor shall be responsible for examining all the shipment and notify the Employer immediately of any damage, shortage, discrepancy etc. for the purpose of Employer's information only. The Contractor shall submit to the Employer every week a report detailing all the receipts during the weeks. However, the Contractor shall be solely responsible for any shortages or damages in transit, handling and/or in storage and

**SECTION-GENERAL TECHNICAL REQUIREMENTS (GTR)**

- erection of the equipment at Site. Any demurrage, wharfage and other such charges claimed by the transporters, railways etc. shall be to the account of the Contractor.
- 13.7 The Contractor shall be fully responsible for the equipment/material until the same is handed over to the Employer in an operating condition after commissioning. Contractor shall be responsible for the maintenance of the equipment/material while in storage as well as after erection until taken over by Employer, as well as protection of the same against theft, element of nature, corrosion, damages etc.
- 13.8 Where material / equipment is unloaded by Employer before the Contractor arrives at site or even when he is at site, Employer by right can hand over the same to Contractor and there upon it will be the responsibility of Contractor to store the material in an orderly and proper manner.
- 13.9 The Contractor shall be responsible for making suitable indoor storage facilities, to store all equipment which requires indoor storage.
- 13.10 The words 'erection' and 'installation' used in the specification are synonymous.
- 13.11 Exposed live parts shall be placed high enough above ground to meet the requirements of electrical and other statutory safety codes.
- 13.12 The design and workmanship shall be in accordance with the best engineering practices to ensure satisfactory performance throughout the service life. If at any stage during the execution of the Contract, it is observed that the erected equipment(s) do not meet the above minimum clearances the Contractor shall immediately proceed to correct the discrepancy at his risks and cost.

**13.13 Equipment Bases**

A cast iron or welded steel base plate shall be provided for all rotating equipment which is to be installed on a concrete base unless otherwise agreed to by the Employer. Each base plate shall support the unit and its drive assembly, shall be of a neat design with pads for anchoring the units, shall have a raised lip all around, and shall have threaded drain connections.

- 13.14 Erection, testing and commissioning of Transformers, Reactors, Circuit breakers, Isolators, Substation automation system, Control & protection panels, PLCC, PMU, Telecommunication Equipments, NIFPS System etc. shall be done by the contractor under the supervision of respective equipment manufacturers. Charges for the above supervision shall be included by the bidder in the erection charges for the respective equipment in the BPS.

**14.0 TOOLS**

- 14.1 TOOLS & PLANTS (T&P)** Please refer section-1 for scope under 14.1

The Contractor shall arrange all T&P (such as necessary supports, cranes, ladders, platforms etc.) for erection, testing & commissioning of the system at his own cost. Further, all consumables, wastage and damages shall be to the account of contractor.

All such T&P shall be taken back by the contractor after commissioning of the system.

**14.2 SPECIAL TOOLS AND TACKLES**

The contractor shall supply all special tools and tackles required for Operation and maintenance of equipment. The special tools and tackles shall only cover items which are specifically required for the equipment offered and are proprietary in nature. The list of special tools and tackles, if any, shall be finalized during detail engineering and the same shall be supplied without any additional cost implication to the Employer.

## **SECTION-GENERAL TECHNICAL REQUIREMENTS (GTR)**

### **14.3 FACILITIES TO BE PROVIDED BY THE EMPLOYER**

14.3.1 Employer shall make available the auxiliary supplies at a single point in the substation on chargeable basis. The prevailing energy rates of the state shall be applicable. All further distribution from the same for construction supply shall be made by the contractor. However, in case of failure of power due to any unavoidable circumstances, the contractor shall make his own necessary arrangements like diesel generator sets etc. at his own cost so that progress of work is not affected and Employer shall in no case be responsible for any delay in works because of non-availability of power.

14.3.2 Employer shall make available construction water supply at a single point in the substation. All further distribution for the same shall be made by the Contractor. In case of non-availability or inadequate availability of water for construction work, the contractor shall make his own arrangement at his own cost and the Employer shall in no case be responsible for any delay in works because of non-availability or inadequate availability of water.

### **15.0 AUXILIARY SUPPLY**

15.1 The auxiliary power for station supply, including the equipment drive, cooling system of any equipment, air-conditioning, lighting etc shall be designed for the specified Parameters as under. The DC supply for the instrumentation and PLCC system shall also conform the parameters as indicated in the following table:

<b>Normal Voltage</b>	<b>Variation in Voltage</b>	<b>Frequency in HZ</b>	<b>Phase/Wire</b>	<b>Neutral connection</b>
415V	± 10%	50 ± 5%	3/4 Wire	Solidly Earthed.
240V	± 10%	50 ± 5%	1/2 Wire	Solidly Earthed.
220V	190V to 240V	DC	Isolated 2 wire System	-
110V	95V to 120V	DC	Isolated 2 wire System	-
48V	--	DC	2 wire system (+) earthed	-

Combined variation of voltage and frequency shall be limited to ± 10%.

15.2 Pickup value of binary input modules of Intelligent Electronic Devices, Digital protection couplers, Analog protection couplers shall not be less than 50% of the specified rated station auxiliary DC supply voltage level.

### **16.0 SUPPORT STRUCTURE**

16.1 The equipment support structures shall be suitable for equipment connections at the first level i.e 14.0 meter, 8.0 meter, 5.9 meter and 4.6 meter from plinth level for 765kV, 400kV, 220kV and 132kV substations respectively. All equipment support structures shall be supplied alongwith brackets, angles, stools etc. for attaching the operating mechanism, control cabinets & marshalling box (wherever applicable) etc.

**SECTION-GENERAL TECHNICAL REQUIREMENTS (GTR)**

16.2 The minimum vertical distance from the bottom of the lowest porcelain/polymer part of the bushing, porcelain/polymer enclosures or supporting insulators to the bottom of the equipment base, where it rests on the foundation pad shall be 2.55 metres.

**17.0 CLAMPS AND CONNECTORS INCLUDING TERMINAL CONNECTORS**

17.1 All power clamps and connectors shall conform to IS:5561 or other equivalent international standard and shall be made of materials listed below :

Sl. No.	Description	Materials
a)	For connecting ACSR conductors/AAC conductors/ Aluminium tube	Aluminum alloy casting, conforming to designation <b>4600</b> of IS:617 and all test shall conform to IS:617
b)	For connecting equipment terminals mad of copper with ACSR conductors/AAC conductors/ Aluminium tube	Bimetallic connectors made from aluminum alloy casting, conforming to designation <b>4600</b> of IS:617 with 2mm thick bimetallic liner/strip and all test shall conform to IS:617
c)	For connecting G.I	Galvanised mild steel shield wire
d)	Bolts, nuts & plain washers	Electro-galvanised for sizes below M12, for others hot dip galvanised.
e)	Spring washers	Electro-galvanised mild steel suitable for atleast service condition-3 as per IS:1573

17.2 Necessary clamps and connectors shall be supplied for all equipment and connections. If corona rings are required to meet these requirements they shall be considered as part of that equipment and included in the scope of work.

17.3 Where copper to aluminum connections are required, bi-metallic clamps shall be used, which shall be properly designed to ensure that any deterioration of the connection is kept to a minimum and restricted to parts which are not current carrying or subjected to stress.

17.4 Low voltage connectors, grounding connectors and accessories for grounding all equipment as specified in each particular case, are also included in the scope of Work.

17.5 No current carrying part of any clamp shall be less than 10 mm thick. All ferrous parts shall be hot dip galvanised. Copper alloy liner/strip of minimum 2 mm thickness shall be cast integral with aluminum body or 2 mm thick bi-metallic liner/strips shall be provided for Bi-metallic clamps.

17.6 All casting shall be free from blow holes, surface blisters, cracks and cavities. All sharp edges and corners shall be blurred and rounded off.

17.7 Flexible connectors, braids or laminated straps made for the terminal clamps for bus posts shall be suitable for both expansion or through (fixed/sliding) type connection of IPS AL tube as required. In both the cases the clamp height (top of the mounting pad to centre line of the tube) should be same.

17.8 Current carrying parts (500A and above) of the clamp/connector shall be provided with minimum four numbers of bolts preferably for 132kV and above.

17.9 All current carrying parts shall be designed and manufactured to have minimum contact resistance.

17.10 Power Clamps and connectors shall be designed to control corona as per requirement.

## **SECTION-GENERAL TECHNICAL REQUIREMENTS (GTR)**

### **17.11 Tests**

Clamps and connectors should be type tested on minimum three samples as per IS:5561 and shall also be subjected to routine tests as per IS:5561. Following type test reports shall be submitted for approval. Type test once conducted shall hold good. The requirement of test conducted within last ten years, shall not be applicable.

- i) Temperature rise test (maximum temperature rise allowed is 35°C over 50°C ambient)
- ii) Short time current test
- iii) Corona (dry) and RIV (dry) test [for 132kV and above voltage level clamps]
- iv) Resistance test and Pullout strength test
- v) Cantilever Strength test on bus support clamps & connectors

### **18.0 CONTROL CABINETS, JUNCTION BOXES, TERMINAL BOXES MARSHALLING BOXES FOR OUTDOOR EQUIPMENT**

18.1 All types of boxes, cabinets etc. shall generally conform to & be tested in accordance with IS/IEC 61439-0, as applicable, and the clauses given below:

18.2 Control cabinets, junction boxes, Marshalling boxes & terminal boxes, Out door ACDB cum DCDB panels shall be made of stainless steel of atleast 1.5 mm thick or aluminum enclosure of atleast 1.6 mm thick and shall be dust, water and vermin proof. Stainless steel used shall be of grade SS304 (SS316 for coastal area) or better. The box shall be properly braced to prevent wobbling. There shall be sufficient reinforcement to provide level surfaces, resistance to vibrations and rigidity during transportation and installation. In case of aluminum enclosed box the thickness of aluminum shall be such that it provides adequate rigidity and long life as comparable with sheet steel of specified thickness.

Control cabinets, junction boxes, marshalling boxes & terminal boxes, out-door ACDB cum DCDB panels shall have adequate space/clearance as per guidelines/technical specifications to access/replace any component. Necessary component labelling to be also done on non-conducting sheet.

For CONTROL CABINETS, JUNCTION BOXES, TERMINAL BOXES MARSHALLING BOXES FOR OUTDOOR EQUIPMENT Junction Box, wire should be as per IS or equivalent IEC with FRLS grade

Machine laid PU Foam gasket may be permitted for use in Control Cabinets etc.

18.3 A canopy and sealing arrangements for operating rods shall be provided in marshalling boxes / Control cabinets to prevent ingress of rain water.

18.4 Cabinet/boxes with width more than 700 mm shall be provided with double hinged doors with padlocking arrangements. The distance between two hinges shall be adequate to ensure uniform sealing pressure against atmosphere.

18.5 All doors, removable covers and plates shall be gasketed all around with suitably profiled EPDM/Neoprene/PU gaskets. The gasket shall be tested in accordance with approved quality plan, IS:11149 and IS:3400. Ventilating Louvers, if provided, shall have screen and filters. The screen shall be fine wire mesh made of brass.

Further, the gasketing arrangement shall be such that gaskets are pasted in slots (in door fabrication/gasket itself) in order to prevent ingress of dust and moisture

## **SECTION-GENERAL TECHNICAL REQUIREMENTS (GTR)**

- inside the panels so that no internal rusting occurs in panels during the operation of the equipment.
- 18.6 All boxes/cabinets shall be designed for the entry of cables by means of weather proof and dust-proof connections. Boxes and cabinets shall be designed with generous clearances to avoid interference between the wiring entering from below and any terminal blocks or accessories mounted within the box or cabinet. Suitable cable gland plate above the base of the marshalling kiosk/box shall be provided for this purpose along with the proper blanking plates. Necessary number of cable glands shall be supplied and fitted on this gland plate. Gland plate shall have provision for some future glands to be provided later, if required. The Nickel plated glands shall be dust proof, screw on & double compression type and made of brass. The gland shall have provision for securing armour of the cable separately and shall be provided with earthing tag. The glands shall conform to BS:6121.
- 18.7 A 240V, single phase, 50 Hz, 15 amp AC plug and socket shall be provided in the cabinet with ON-OFF switch for connection of hand lamps. Plug and socket shall be of industrial grade.
- 18.8 LED based illumination of minimum 9 watts shall be provided. The switching of the fittings shall be controlled by the door switch.
- For junction boxes of smaller sizes such as lighting junction box, manual operated earth switch mechanism box etc., plug socket, heater and illumination is not required to be provided.
- 18.9 All control switches shall be of MCB/rotary switch type and Toggle/piano switches shall not be accepted.
- 18.10 Earthing of the cabinet shall be ensured by providing two separate earthing pads. The earth wire shall be terminated on to the earthing pad and secured by the use of self etching washer. Earthing of hinged door shall be done by using a separate earth wire.
- 18.11 The bay marshalling kiosks shall be provided with danger plate and a diagram showing the numbering/connection/feruling by pasting the same on the inside of the door.
- 18.12 The following routine tests alongwith the routine tests as per IS:5039 shall also be conducted:
- i) Check for wiring
  - ii) Visual and dimension check
- 18.13 The enclosure of bay marshalling kiosk, junction box, terminal box and control cabinets shall conform to IP-55 as per IS/IEC60947 including application of 1kV rms for 1 (one) minute, after IP-55 test.
- 19.0 DISPOSAL OF PACKING MATERIAL & WASTE FROM CONSTRUCTION SITE**
- After completion of the work, Contractor shall dispose-off all the packing & waste materials including empty conductor drums, cable drums, wooden containers, oil drums, gas cylinders and other waste/scrapped materials from construction site at his own cost and shall make the substation area properly cleaned.
- 20.0 TERMINAL BLOCKS AND WIRING**
- 20.1 Control and instrument leads from the switchboards or from other equipment will be brought to terminal boxes or control cabinets in conduits. All interphase and external connections to equipment or to control cubicles will be made through terminal blocks.
- 20.2 Terminal blocks shall be 650V grade and have continuous rating to carry the maximum expected current on the terminals and non-breakable type. These shall be of moulded

## **SECTION-GENERAL TECHNICAL REQUIREMENTS (GTR)**

- piece, complete with insulated barriers, stud type terminals, washers, nuts and lock nuts. Screw clamp, overall insulated, insertion type, rail mounted terminals can be used in place of stud type terminals. But the terminal blocks shall be non-disconnecting stud type except for the secondary junction boxes of Current Transformer and Voltage Transformer.
- 20.3 Terminal blocks for current transformer and voltage transformer secondary leads shall be provided with test links and isolating facilities. The current transformer secondary leads shall also be provided with short circuiting and earthing facilities.
- 20.4 The terminal shall be such that maximum contact area is achieved when a cable is terminated. The terminal shall have a locking characteristic to prevent cable from escaping from the terminal clamp unless it is done intentionally.
- 20.5 The conducting part in contact with cable shall preferably be tinned or silver plated however Nickel plated copper or zinc plated steel shall also be acceptable.
- 20.6 The terminal blocks shall be of extensible design, multilayer terminal arrangement is not allowed in any junction box (Common MB, Individual MB, JB etc.). There should be sufficient space at both sides of terminals so that ferrule number of wires / TB numbers are clearly visible during wire removal or insertion.
- 20.7 The terminal blocks shall have locking arrangement to prevent its escape from the mounting rails.
- 20.8 The terminal blocks shall be fully enclosed with removable covers of transparent, non-deteriorating type plastic material. Insulating barriers shall be provided between the terminal blocks. These barriers shall not hinder the operator from carrying out the wiring without removing the barriers.
- 20.9 Unless otherwise specified terminal blocks shall be suitable for connecting the following conductors on each side.
- |    |                                    |   |
|----|------------------------------------|---|
| a) | All circuits except CT/PT circuits | Minimum of two of 2.5 sq mm copper flexible.    |
| b) | All CT/PT circuits                 | Minimum of 4 nos. of 2.5 sq mm copper flexible. |
- 20.10 The arrangements shall be in such a manner so that it is possible to safely connect or disconnect terminals on live circuits and replace fuse links when the cabinet is live.
- 20.11 Atleast 20 % spare terminals shall be provided on each panel/cubicle/box and these spare terminals shall be uniformly distributed on all terminals rows.
- 20.12 There shall be a minimum clearance of 250 mm between the First/bottom row of terminal block and the associated cable gland plate for outdoor ground mounted marshalling box and the clearance between two rows of terminal blocks shall be a minimum of 150 mm.
- 20.13 The Contractor shall furnish all wire, conduits and terminals for the necessary interphase electrical connections (where applicable) as well as between phases and common terminal boxes or control cabinets.
- 21.0 LAMPS & SOCKETS**
- 21.1 Lamps & Sockets**

All lamps shall use a socket base as per IS-1258, except in the case of signal lamps.

All sockets (convenience outlets) shall be suitable to accept both 5 Amp & 15 Amp pin round Standard Indian plugs. They shall be switched sockets with shutters.

## **SECTION-GENERAL TECHNICAL REQUIREMENTS (GTR)**

### **21.2 Hand Lamp:**

A 240 Volts, single Phase, 50 Hz AC plug point shall be provided in the interior of each cubicle with ON-OFF Switch for connection of hand lamps.

### **21.3 Switches and Fuses:**

21.3.1 Each panel shall be provided with necessary arrangements for receiving, distributing, isolating and fusing of DC and AC supplies for various control, signaling, lighting and space heater circuits. The incoming and sub-circuits shall be separately provided with miniature circuit breaker / switch fuse units. Selection of the main and Sub-circuit fuse ratings shall be such as to ensure selective clearance of sub-circuit faults. Potential circuits for relaying and metering shall be protected by HRC fuses.

21.3.2 All fuses shall be of HRC cartridge type conforming to relevant IS mounted on plug-in type fuse bases. Miniature circuit breakers with thermal protection and alarm contacts will also be accepted. All accessible live connection to fuse bases shall be adequately shrouded. Fuses shall have operation indicators for indicating blown fuse condition. Fuse carrier base shall have imprints of the fuse rating and voltage.

### **22.0 BUSHINGS, HOLLOW COLUMN INSULATORS, SUPPORT INSULATORS:**

22.1 Bushings shall be manufactured and tested in accordance with IS:2099 & IEC-60137 while hollow column insulators shall be manufactured and tested in accordance with IEC-62155/IS:5621. The support insulators shall be manufactured and tested as per IS:2544/IEC-60168 and IEC-60273. The insulators shall also conform to IEC-60815 as applicable.

The bidder may also offer composite hollow insulators, conforming to IEC-61462.

22.2 Support insulators, bushings and hollow column insulators shall be manufactured from high quality porcelain. Porcelain used shall be homogeneous, free from laminations, cavities and other flaws or imperfections that might affect the mechanical or dielectric quality and shall be thoroughly vitrified tough and impervious to moisture.

22.3 Glazing of the porcelain shall be uniform brown in colour, free from blisters, burrs and similar other defects.

22.4 Support insulators/bushings/hollow column insulators shall be designed to have ample insulation, mechanical strength and rigidity for the conditions under which they will be used.

22.5 When operating at normal rated voltage there shall be no electric discharge between the conductors and bushing which would cause corrosion or injury to conductors, insulators or supports by the formation of substances produced by chemical action. No radio interference shall be caused by the insulators/bushings when operating at the normal rated voltage.

22.6 Bushing porcelain shall be robust and capable of withstanding the internal pressures likely to occur in service. The design and location of clamps and the shape and the strength of the porcelain flange securing the bushing to the tank shall be such that there is no risk of fracture. All portions of the assembled porcelain enclosures and supports other than gaskets, which may in any way be exposed to the atmosphere shall be composed of completely non hygroscopic material such as metal or glazed porcelain.

22.7 All iron parts shall be hot dip galvanised and all joints shall be air tight. Surface of joints shall be trued up porcelain parts by grinding and metal parts by machining. Insulator/bushing design shall be such as to ensure a uniform compressive pressure on the joints.

## **SECTION-GENERAL TECHNICAL REQUIREMENTS (GTR)**

22.8 Void

### 22.9 **RTV Coating on porcelain insulators (for coastal area)**

RTV coating shall be done at site on all porcelain insulators (i.e. bushings, hollow and solid insulators, disc insulators etc.) for substation(s) in coastal area if defined in section Project. The cost of RTV coating shall be deemed to be included in the respective equipment/items' erection cost. The technical details of RTV coating is attached in **Annexure-H**.

22.10 In case, different designs of lattice and pipe structures other than Employer supplied structures are required to be adopted in view of higher creep age (31mm/kV) of the switchgear/equipment's, insulator strings, bushings & bus post insulators etc., Design, supply & erection of such structures shall be in the scope of contractor against respective standard structure. However dimensional details (except height) shall not be less than that specified in standard structure drawing of respective equipment's.

### 23.0 **MOTORS**

Motors shall be "Squirrel Cage" three phase induction motors of sufficient size capable of satisfactory operation for the application and duty as required for the driven equipment and shall be subjected to routine tests as per applicable standards. The motors shall be of approved make.

#### 23.1 **Enclosures**

- a) Motors to be installed outdoor without enclosure shall have hose proof enclosure equivalent to IP-55 as per IS: 4691. For motors to be installed indoor i.e. inside a box, the motor enclosure, shall be dust proof equivalent to IP-44 as per IS: 4691.
- b) Two independent earthing points shall be provided on opposite sides of the motor for bolted connection of earthing conductor.
- c) Motors shall have drain plugs so located that they will drain water resulting from condensation or other causes from all pockets in the motor casing.
- d) Motors weighing more than 25 Kg. shall be provided with eyebolts, lugs or other means to facilitate lifting.

#### 23.2 **Operational Features**

- a) Continuous motor rating (name plate rating) shall be at least ten (10) percent above the maximum load demand of the driven equipment at design duty point and the motor shall not be over loaded at any operating point of driven equipment that will rise in service.
- b) Motor shall be capable at giving rated output without reduction in the expected life span when operated continuously in the system having the particulars as given in Clause 15.0 of this Section.

#### 23.3 **Starting Requirements:**

- a) All induction motors shall be suitable for full voltage direct-on-line starting. These shall be capable of starting and accelerating to the rated speed alongwith the driven equipment without exceeding the acceptable winding temperature even when the supply voltage drops down to 80% of the rated voltage.

### **SECTION-GENERAL TECHNICAL REQUIREMENTS (GTR)**

- b) Motors shall be capable of withstanding the electrodynamic stresses and heating imposed if it is started at a voltage of 110% of the rated value.
- c) The locked rotor current shall not exceed six (6) times the rated full load current for all motors, subject to tolerance as given in IS:325.
- d) Motors when started with the driven equipment imposing full starting torque under the supply voltage conditions specified under Clause 15.0 shall be capable of withstanding atleast two successive starts from cold condition at room temperature and one start from hot condition without injurious heating of winding. The motors shall also be suitable for three equally spread starts per hour under the above referred supply condition.
- e) The locked rotor withstand time under hot condition at 110% of rated voltage shall be more than starting time with the driven equipment of minimum permissible voltage by at least two seconds or 15% of the accelerating time whichever is greater. In case it is not possible to meet the above requirement, the Bidder shall offer centrifugal type speed switch mounted on the motor shaft which shall remain closed for speed lower than 20% and open for speeds above 20% of the rated speed. The speed switch shall be capable of withstanding 120% of the rated speed in either direction of rotation.

#### **23.4 Running Requirements:**

- a) The maximum permissible temperature rise over the ambient temperature of 50 degree C shall be within the limits specified in IS:325 (for 3-phase induction motors) after adjustment due to increased ambient temperature specified.
- b) The double amplitude of motor vibration shall be within the limits specified in IS: 4729. Vibration shall also be within the limits specified by the relevant standard for the driven equipment when measured at the motor bearings.
- c) All the induction motors shall be capable of running at 80% of rated voltage for a period of 5 minutes with rated load commencing from hot condition.

#### **23.5 TESTING AND COMMISSIONING**

An indicative list of tests is given below. Contractor shall perform any additional test based on specialities of the items as per the field Q.P./Instructions of the equipment Contractor or Employer without any extra cost to the Employer. The Contractor shall arrange all instruments required for conducting these tests alongwith calibration certificates and shall furnish the list of instruments to the Employer for approval.

- (a) Insulation resistance.
- (b) Phase sequence and proper direction of rotation.
- (c) Any motor operating incorrectly shall be checked to determine the cause and the conditions corrected.

#### **24. TECHNICAL REQUIREMENT OF EQUIPMENTS**

Following equipment shall be offered from the **Indian Manufacturing facilities** of manufacturer(s) who meets the technical requirements as stipulated here, provided the same equipment are not covered under the Bidder's Qualifying requirement of the Bidding Documents.

##### **Legend:**

\* : voltage class of respective equipment as applicable.

**SECTION-GENERAL TECHNICAL REQUIREMENTS (GTR)**

# : **satisfactory operation** means certificate issued by the Employer/Utility certifying the operation without any adverse remark.

@ : **Circuit Breaker Bay** means a bay used for controlling a line or a transformer or a reactor or a bus section or a bus coupler and comprising of at least one circuit breaker, one disconnecter and three nos. of single phase CTs / Bushing CTs

NOA: means Notification Of Award

**24.1 Technical requirements for 765/400/220/132/110kV\* Air Insulated Switchgear (AIS) Equipment\* (i.e Circuit Breaker, Isolator, Current Transformer, Capacitive Voltage transformer, Inductive Voltage transformer, Surge Arrester and Wave Trap)**

- (i) The manufacturer(s) whose 765/400/220/132/110kV\* equipment(s) are offered, must have, manufactured, type tested (as per IEC/IS or equivalent standard) and supplied 715/345/220/132/110kV\* or higher voltage class equipment(s), which are in satisfactory operation# for atleast two (2) years as on the date of NOA.
- (ii) Alternatively, the manufacturer, who have established manufacturing and testing facilities in India for the offered equipment and not meeting the requirement stipulated in (i) above, can also be considered provided that
  - a) 715/345/220/132/110kV\* or higher Voltage class equipment(s) must have been manufactured in the above Indian works & type tested (as per IEC/IS standard) and supplied as on the date of NOA.
  - b) In case manufacturer meets the technical requirement through clause (ii) above, warranty obligations for additional warranty of two(2) years over & above the warranty period as specified in the bidding documents shall be applicable for the entire quantity of the offered equipment to be supplied under the contract. Further, contractor shall furnish performance guarantee for an amount of 3% of the ex-works cost of the equipments(s)\* for the additional warranty period in addition to the contract performance guarantee to be submitted by the contractor

**24.2 Technical Requirement for 765kV class Transformer**

- (i) The Manufacturer whose 765kV Transformer(s) are offered must have designed, manufactured, tested & supplied 715 kV or higher voltage class one (1) number 1-phase Transformer of at least 500 MVA capacity or at least three (3) numbers 1-phase Transformers each having a capacity of at least 166 MVA, and the same transformer (s) should have been in satisfactory operation# for atleast two (2) years as on the date of NOA.
- (ii) Alternatively, the manufacturer, who have established manufacturing and testing facilities in India and not meeting the requirement stipulated in (i) above, can also be considered provided that
  - a) 715 kV or higher voltage class either One (1) no. 1-phase Transformer of at least 166 MVA capacity or One (1) no. 1-phase Reactor of at least 80 MVAR capacity must have been manufactured in the above Indian works based on

### **SECTION-GENERAL TECHNICAL REQUIREMENTS (GTR)**

technological support of collaborator, type tested (as per IEC/IS standard) and same should have been supplied as on the date of NOA.

- b) The collaborator meets the requirements stipulated in (i) above. A valid collaboration agreement for technology transfer / license to design, manufacture, test and supply 765kV transformer in India, shall be submitted.
- c) the collaborator shall furnish performance guarantee for an amount of **3%** of the ex-works cost of such equipment(s) and this performance guarantee shall be in addition to contract performance guarantee to be submitted by the contractor

#### **24.3 Technical Requirement for 765kV class Reactor**

- (i) The Manufacturer whose 765kV Reactor(s) are offered must have designed, manufactured, tested & supplied 715 kV or higher voltage class one (1) number 1-phase Reactor of at least 110 MVAR capacity or at least three (3) numbers 1-phase Reactors each having a capacity of at least 36.7 MVAR and the same Reactor(s) should have been in satisfactory operation# for atleast two (2) years as on the date of NOA.

OR

The Manufacturer must have designed, manufactured, tested & supplied 715 kV or higher voltage class one (1) number 1-phase Transformer of at least 500 MVA capacity or at least three (3) numbers 1-phase Transformers each having a capacity of at least 166 MVA and the bidder should have designed, manufactured, tested & supplied 345 kV or higher voltage class one (1) number 3-phase Reactor of at least 50 MVAR capacity or at least three (3) numbers 1-phase Reactors each having a capacity of at least 16.7 MVAR and the same Transformer(s) & Reactor(s) should have been in satisfactory operation# for atleast two (2) years as on the date of NOA.

- (ii) Alternatively, the manufacturer, who have established manufacturing and testing facilities in India and not meeting the requirement stipulated in (i) above, can also be considered provided that
  - a) 715 kV or higher voltage class either One (1) no. 1-phase Reactor of at least 80 MVAR capacity or One (1) no. 1-phase Transformer of at least 166 MVA capacity must have been manufactured in the above Indian works based on technological support of collaborator, type tested (as per IEC/IS standard) and same should have been supplied as on the date of NOA.
  - b) The collaborator meets the requirements stipulated in (i) above. A valid collaboration agreement for technology transfer/license to design, manufacture, test and supply 765kV Reactor in India, shall be submitted.
  - c) the collaborator shall furnish performance guarantee for an amount of **3%** of the ex-works cost of such equipment(s) and this performance guarantee shall be in addition to contract performance guarantee to be submitted by the contractor.

#### **24.4 Technical Requirement for 400kV, 220kV, 132kV class Transformer**

**SECTION-GENERAL TECHNICAL REQUIREMENTS (GTR)**

- (i) The manufacturer whose transformer(s) are offered must have designed, manufactured, tested and supplied transformers as per table below:

345kV or above class 3-phase transformers of at least 200 MVA or at least three (3) nos. 1-phase Transformers each having capacity of at least 66.7 MVA	applicable for supply of 400kV class Transformer
220kV or above class 3-phase transformers of at least 50 MVA or at least three (3) nos. 1-phase Transformers each having capacity of at least 16.7 MVA	applicable for supply of 220kV class Transformer
commissioned 132kV or above class 3-phase transformers of at least 20 MVA or at least three (3) nos. 1-phase Transformers each having capacity of at least 6.7 MVA	applicable for supply of 132kV class Transformer

These Transformer(s) must have been in satisfactory operation# for atleast two (2) years as on the date of NOA.

- (ii) Alternatively, the manufacturer, who have established manufacturing and testing facilities in India and not meeting the requirement stipulated in (i) above, can also be considered provided that
- a) 220kV (applicable for supply of 400kV class Transformer)/ 132kV (applicable for supply of 220kV class Transformer)/ 66kV (applicable for supply of 132kV class Transformer) or higher voltage class transformers must have been designed, manufactured in the above Indian works based on technological support of collaborator, type tested (as per IEC/IS standard) and supplied as on the date of NOA.
- b) The collaborator meets the requirements stipulated in (i) above. A valid collaboration agreement for technology transfer / license to design, manufacture, test and supply 400kV/220kV/132kV\* transformer in India, shall be submitted.
- c) The collaborator shall furnish performance guarantee for an amount of 3% of the ex-works cost of such equipment(s) and this performance guarantee shall be in addition to contract performance guarantee to be submitted by the contractor.

**24.5 Technical Requirement for 400kV, 220kV and 132kV class Reactor**

- (i) The Manufacturer whose 400kV/220kV/132kV\* Reactor(s) are offered must have designed, manufactured, tested & supplied Reactor as per table below:

345kV or above class 3-phase shunt	applicable for supply of 400kV class
------------------------------------	--------------------------------------

**SECTION-GENERAL TECHNICAL REQUIREMENTS (GTR)**

reactor of at least 50 MVAR capacity or at least three (3) nos. 1-phase Shunt Reactors, each having capacity of at least 16.7 MVAR	Reactors
220kV or above class 3-phase shunt reactor of at least 20 MVAR capacity or at least three (3) nos. 1-phase Shunt Reactors each having capacity of at least 6.67 MVAR	applicable for supply of 220kV class Transformer
132kV or above class 3-phase shunt reactor of at least 15 MVAR capacity or at least three (3) nos. 1-phase Shunt Reactors each having capacity of at least 5 MVAR	applicable for supply of 132kV class Transformer

These Reactor(s) must have been in satisfactory operation# for atleast two (2) years as on the date of NOA.

- (ii) Alternatively, the manufacturer, who have established manufacturing and testing facilities in India and not meeting the requirement stipulated in (i) above, can also be considered provided that
  - a) Such manufacturer has designed, manufactured based on technological support of collaborator, type tested (as per IEC/IS standard) and supplied 400kV class transformer or 220kV or above class shunt reactors (applicable for supply of 400kV class Reactors) / 220kV class transformer or 132kV or above class shunt reactors (applicable for supply of 220kV class Reactors)/ 132kV class transformer or 66kV or above class shunt reactors (applicable for supply of 132kV class Reactors) as on the date of NOA.
  - b) The collaborator meets the requirements stipulated in (i) above. A valid collaboration agreement for technology transfer/license to design, manufacture, test and supply the Reactor in India, shall be submitted.
  - c) the collaborator shall furnish performance guarantee for an amount of 3% of the ex-works cost of such equipment(s) and this performance guarantee shall be in addition to contract performance guarantee to be submitted by the contractor.

**24.6 Technical Requirement for 400 kV Grade XLPE Power Cables**

- (i) The manufacturer(s) whose XLPE Power Cables are offered must have designed, manufactured, type tested and supplied in a single contract atleast 5 (five) km of single core, 400kV grade XLPE insulated cable which must be in operation for atleast 2 (two) years as on the date of NOA.
- (ii) Alternatively, the manufacturer, who have established manufacturing and testing facilities in India and not meeting the requirement stipulated in (i) above, can also be considered provided that

**SECTION-GENERAL TECHNICAL REQUIREMENTS (GTR)**

- a) The manufacturer must have designed, manufactured, type tested and supplied 400kV grade XLPE insulated cable and which must be in satisfactory operation# for atleast one (1) year as on the date of NOA.

OR

- b) The manufacturer must have designed, manufactured, type tested and completed Pre-qualification (PQ) tests as per IEC for 400kV grade XLPE insulated Cable as on the date of NOA.

Note: In case manufacturer meets the technical requirement through clause (ii) above, warranty obligations for additional warranty of two(2) years over & above the warranty period as specified in the bidding documents shall be applicable for the entire quantity of cable to supplied under the contract. Further, contractor shall furnish performance guarantee for an amount of 3% of the ex-works cost of the equipments(s)\* and this performance guarantee shall be in addition to the contract performance guarantee to be submitted by the contractor.

**24.7 Technical Requirement for 220KV,132kV,110kV Grade XLPE Power Cables**

- (i) The manufacturer(s) whose XLPE Power Cables are offered must have designed, manufactured, type tested and supplied in a single contract atleast 5 (five) km of single core, 220kV/132kV/110kV\* or higher grade XLPE insulated cable which must be in operation for atleast 2 (two) years as on the date of NOA.

- (ii) Alternatively, the manufacturer, who have established manufacturing and testing facilities in India and not meeting the requirement stipulated in (i) above, can also be considered provided that

- a) The manufacturer must have designed, manufactured, type tested and supplied 220kV/132kV/110kV\* or higher grade XLPE insulated cable and which must be in satisfactory operation# for atleast one (1) year as on the date of NOA.

OR

- b) The manufacturer must have designed, manufactured, type tested and completed Pre-qualification (PQ) tests as per IEC for 220kV/132kV/110kV\* or higher grade XLPE insulated Cable as on the date of NOA.

Note: In case manufacturer meets the technical requirement through clause (ii) above, warranty obligations for additional warranty of two(2) years over & above the warranty period as specified in the bidding documents shall be applicable for the entire quantity of cable to supplied under the contract. Further, contractor shall furnish performance guarantee for an amount of 3% of the ex-works cost of the equipments(s)\* and this performance guarantee shall be in addition to the contract performance guarantee to be submitted by the contractor

**24.8 Technical Requirement for 66kV Grade XLPE Power Cables**

- (i) The manufacturer(s) whose XLPE Power Cables are offered must have designed, manufactured, type tested and supplied in a single contract atleast 5 (five) km of single core, 66kV or higher grade XLPE insulated cable which must be in satisfactory operation# for atleast two (2) years as on the date of NOA.

- (ii) Alternatively, the manufacturer, who have established manufacturing and testing facilities in India and not meeting the requirement stipulated in (i) above, can also be considered provided that

**SECTION-GENERAL TECHNICAL REQUIREMENTS (GTR)**

- a) The manufacturer must have designed, manufactured, type tested and supplied 66kV or higher grade XLPE insulated cable and which must be in satisfactory operation# for atleast one (1) year as on the date of NOA.

**24.9 Technical Requirement for 1.1 KV Grade PVC Control Cable**

The manufacturer(s), whose PVC control cables are offered, must have designed, manufactured, tested and supplied in a single contract atleast 100 Kms of 1.1kV grade PVC insulated control cables as on the date of NOA. Further the manufacturer must also have designed, manufactured, tested and supplied atleast 1 km of 27C x 2.5 Sq.mm or higher size as on the date of NOA.

**24.10 Technical Requirement for 1.1 KV Grade PVC Power Cable**

The manufacturer(s), whose PVC Power Cables are offered, must have designed, manufactured, tested and supplied in a single contract atleast 100 Kms of 1.1kV or higher grade PVC insulated power cables as on the date of NOA. Further the manufacturer must also have designed, manufactured, tested and supplied atleast 1 km of 1C x 150 Sq. mm or higher size as on the date of NOA.

**24.11 Technical Requirement for 1.1 KV Grade XLPE Power Cables**

The manufacturer(s), whose XLPE Power cables are offered, must have designed, manufactured, tested and supplied in a single contract atleast 25 Kms of 1.1 KV or higher grade XLPE insulated power cables as on the date of NOA. Further the manufacturer must also have designed, manufactured, tested and supplied atleast 1 km of 1C x 630 Sq. mm or higher size as on the date of NOA.

**24.12 Technical Requirement for LT Switchgear**

- i) The manufacturer whose LT Switchgear(s) are offered, must be a manufacturer of LT Switchboards of the type and rating being offered. He must have designed, manufactured, tested and supplied atleast 50 nos. draw out circuit breaker panels, out of which atleast 5 nos. should have been with relay and protection schemes with current transformer. He must have also manufactured atleast 50 nos. MCC panels comprising of MCCBs (ie Moulded Case Circuit Breakers) modules of the type offered which must be in satisfactory operation# as on the date of NOA.
- ii) The Switchgear items (such as circuit breakers, fuse switch units, contactors etc.), may be of his own make or shall be procured from reputed manufacturers and of proven design, atleast one hundred circuit breakers of the make and type being offered must have been in satisfactory operation# as on the date of NOA.

**24.13 Technical Requirements for Battery**

The manufacturer whose Batteries are offered, must have designed, manufactured and supplied DC Batteries of the type specified and being offered, having a capacity of atleast 600 AH and these must be satisfactory operation# for atleast two (2) years in power sector or industrial installations as on the date of NOA.

**24.14 Technical Requirements for Battery Charger**

The manufacturer, whose Battery Chargers are offered, must have designed, manufactured and supplied Battery Chargers generally of the type offered, with static automatic voltage regulators and having a continuous output of atleast ten (10) KW and these must have been in satisfactory operation# as on the date of NOA.

**24.15 Technical Requirements for LT Transformer**

- i) The manufacturer, whose LT transformer(s) are offered, must have designed, manufactured, type tested including short circuit test as per IEC/IS or equivalent

### **SECTION-GENERAL TECHNICAL REQUIREMENTS (GTR)**

standards and supplied transformer(s) of atleast 33kV class of 315kVA or higher. The transformer must have been in satisfactory operation# for atleast two (2) years as on the date of NOA.

- ii) Alternatively, the manufacturer, who have established manufacturing and testing facilities in India and not meeting the requirement stipulated in (i) above, can also be considered provided that At least 33kV class of 315kVA or higher rating LT transformer(s) must have been designed, manufactured in the above Indian works, type tested (as per IEC/IS standard) including short circuit test and supplied as on the date of NOA.

Note In case manufacturer meets the technical requirement through clause (ii) above, warranty obligations for additional warranty of two(2) years over & above the warranty period as specified in the bidding documents shall be applicable for the entire quantity of the offered equipment to be supplied under the contract. Further, contractor shall furnish performance guarantee for an amount of 3% of the ex-works cost of the equipments(s)\* for the additional warranty period in addition to the contract performance guarantee to be submitted by the contractor

#### **24.16 Technical Requirements for Composite Long Rod Polymer Insulator (765kV & 400kV)**

- (i) The manufacturer whose Composite Long rod Insulator are offered, must have designed, manufactured, tested and supplied Composite Long rod Insulator of 120KN or higher electro-mechanical strength for 765kV/400kV\* or higher voltage class and the same must have been in satisfactory operation# for atleast two (2) years as on the date of NOA.
- (ii) Alternatively, the manufacturer, who have established manufacturing and testing facilities in India and not meeting the requirement stipulated in (i) above, can also be considered provided that
- a) The manufacturer must have designed, manufactured, type tested and supplied Composite Long rod Insulator of 120KN or above electro-mechanical strength for 765kV/400kV\* or higher voltage class and the same must have been in satisfactory operation# as on the date of NOA.
- b) Contractor shall furnish performance guarantee for an amount of 10% of the ex-works cost of the equipments(s)\* and this performance guarantee shall be in addition to the contract performance guarantee to be submitted by the contractor.

Note: In case manufacturer meets the technical requirement through clause (ii) above, warranty obligations for additional warranty of two(2) years over & above the warranty period as specified in the bidding documents shall be applicable for the entire quantity of the offered equipment to be supplied under the contract. Further, contractor shall furnish performance guarantee for an amount of 3% of the ex-works cost of the equipments(s)\* for the additional warranty period in addition to the contract performance guarantee to be submitted by the contractor

#### **24.17 Technical Requirements for Control, Relay & Protection System and Sub-station Automation System**

The manufacturer whose Control, Relay & Protection System (Control & protection Intelligent Electronic Devices (IEDs)), and Sub-station Automation System (as applicable) are offered, must have designed, manufactured, tested, installed and

### **SECTION-GENERAL TECHNICAL REQUIREMENTS (GTR)**

commissioned Control, Relay & Protection system along with Sub-station Automation System which must have been in satisfactory operation# on (i) 400 kV system [applicable for 765kV substation] & (ii) specified voltage level or above [applicable for 400kV & below substation] for atleast two (2) years as on the date of NOA.

AND

The Manufacturer or their joint venture or subsidiary company or parent company must be a manufacturer of control and protection IEDs and must have established repair, testing and integration (atleast for 4 bays) facilities for Control, Relay & Protection System and Sub-station Automation System in India.

#### **24.18 Technical Requirements for analog and digital PLCC panels (765kV, 400kV, 220kV & 132kV)**

- (i) The manufacturer whose PLCC panels are offered, must have designed, manufactured, tested, supplied and commissioned PLCC panels for (i) 400kV system or above [applicable for 765 kV & 400 kV substation], (ii) 220 kV System or above [applicable for 220 kV Substation] & (iii) 132 kV system or above [applicable for 132 kV substation] and the same must have been in satisfactory operation# for atleast two (2) years as on the date of NOA.
- (ii) Alternatively, the manufacturer, who have established manufacturing and testing facilities in India and not meeting the requirement stipulated in (i) above, can also be considered provided that
  - a) PLCC panels must have been manufactured in the above Indian works based on technological support of collaborator, type tested (as per IEC/IS standard) and supplied as on the date of NOA.
  - b) collaborator shall furnish performance guarantee for an amount of 3% of the ex-works cost of such equipment(s) and this performance guarantee shall be in addition to contract performance guarantee to be submitted by the contractor.
  - c) The collaborator meets the requirements stipulated in (i) above. A valid collaboration agreement for technology transfer / license to design, manufacture, test and supply PLCC panels in India, shall be submitted.

#### **24.19 Technical Requirement of Communication Equipment**

The SDH equipment shall be offered from a manufacturer(s) who is a “**Local Supplier**” as per DPIIT PP notification & has been Manufacturing SDH equipments for the last three (3) years and SDH equipment Manufactured by such manufacturer(s) shall have been satisfactory operation in 110kV or higher voltage Power Substations for at least two (2) years as on the date of NOA

#### **24.20 Technical Requirement for 400kV GIS Equipment**

- (i) The manufacturer whose 400kV GIS bays are offered must have designed, manufactured, type tested\*\* (as per IEC or equivalent standard), supplied and supervised erection & commissioning of at least two (2) nos. Gas Insulated Switchgear (GIS) circuit breaker bays@ of 345kV or above voltage class in one (1) Substation or Switchyard during the last seven (7) years and these bays must be in satisfactory operation# for at least two (2) years as on the date of NOA.

**SECTION-GENERAL TECHNICAL REQUIREMENTS (GTR)**

- (ii) Alternatively, the manufacturer, who have established manufacturing and testing facilities in India and not meeting the requirement stipulated in (i) above, can also be considered provided that
- a) Atleast one no. 345kV or above voltage class GIS Circuit Breaker bay@ must have been manufactured in the above Indian works based on the technological support of the Collaborator(s) and either supplied or type tested the above CB bay (as per IEC or equivalent standard) as on the date of NOA.
  - b) The collaborator(s) meets the requirements stipulated in (i) above. A valid collaboration agreement for technology transfer / license to design, manufacture, test and supply 400kV or above voltage level GIS equipment in India, shall be submitted.
  - c) The Collaborator(s) shall furnish performance guarantee for an amount of 3% of the ex-works cost of such equipment(s) and this performance guarantee shall be in addition to Contract Performance Guarantee to be submitted by the bidder.

Note :-

(\*\*) Type test reports of the collaborator/ parent company/ subsidiary company/ group company shall also be acceptable

**25.0 Technical Requirement of Sub-contractors:**

The sub-contractor must have either of the following experience of having successfully completed similar works during last 7 years as on the last day of month previous to the one in which the sub-contractor is proposed to be engaged:

- a) Three similar works costing not less than the amount equal to 40% of the cost of the work to be sub-contracted.

**OR**

- b) Two similar works costing not less than the amount equal to 50% of the cost of the work to be sub-contracted.

**OR**

- c) One similar work costing not less than the amount equal to 80% of the cost of the work to be sub-contracted.

1. Minimum Average Annual Turnover **\*\***(MAAT) for best three years i.e. 36 months out of last five financial years of the sub-contractor should be.....:

**\*\***Annual Gross Revenue from operations/ Gross operating income as incorporated in the profit & loss account excluding Other Income.

**Note:**

**SECTION-GENERAL TECHNICAL REQUIREMENTS (GTR)**

- a) Similar work shall mean the work which are of similar in nature to the work to be sub-contracted e.g. for the scope of civil work to be sub-contracted, the experience should be of civil work.
- b) The aforesaid qualifying requirement shall however, not be applicable for engaging labour as per extant policy.
- c) The cost of the work to be sub-contracted shall be considered as available in the Contract Agreement. However, if the value is not available in the Contract Agreement, the same shall be the estimated value for such work.
- d) The above criteria is in addition to extant policy on selection of sub-contractor as per WPPP, Vol-II.
- e) The MAAT requirement shall be worked out basis the following formula:

$$\text{Minimum Average Annual Turnover (MAAT)} = \frac{\text{Cost of the work to be sub-contracted} \times 1.5}{\text{Completion period in years}^{**}}$$

\*\*The completion period shall be considered as 1 year even if the same is less than 1 year.

**26.0 Technical Requirement of Sub-contractors of GIS Packages**

In case of GIS is supplied from Indian GIS manufacturer, the erection, testing & commissioning of GIS shall be executed either by the bidder himself or by the Subcontractor meeting the following technical requirement:

The bidder/Subcontractor must have erected, tested and commissioned at least two (2) nos. GIS/AIS Circuit breaker equipped bays@ of voltage class\*\* as specified below or higher in one (1) substation or switchyard during the last seven (7) years and these bays must be in satisfactory operation# as on the date of NOA.

S.no	Voltage class of GIS Package	Minimum Voltage class Circuit Breaker Equipped of Bay(**)
1	765kV & 400kV GIS	345kV
2	220kV	220kV
3	132kV	110kV
4	66kV	66kV

Further, the sub-contractor shall also meet the requirement specified at Clause No. 25.0 of this section.

**Note:**

1. (@) For the purpose of technical requirement, one no. of circuit breaker bay shall be considered as a bay used for controlling a line or a transformer or a reactor or a bus section or a bus coupler and comprising of at least one circuit breaker, one disconnecter and three nos. of single phase CTs / Bushing CTs. GIS means SF6 Gas insulated Switchgear. AIS Means Air Insulated Switchgear.

**SECTION-GENERAL TECHNICAL REQUIREMENTS (GTR)**

2. # satisfactory operation means certificate issued by the Owner/Utility certifying the operation without any adverse remark.

**SECTION-GENERAL TECHNICAL REQUIREMENTS (GTR)**ANNEXURE-A**CORONA AND RADIO INTERFERENCE VOLTAGE (RIV) TEST****1. General**

Unless otherwise stipulated, all equipment together with its associated connectors, where applicable, shall be tested for external corona (for 400kV & above) both by observing the voltage level for the extinction of visible corona under falling power frequency voltage and by measurement of radio interference voltage (RIV) for 132kV and above.

**2. Test Levels:**

The test voltage levels for measurement of external RIV and for corona extinction voltage are listed under the relevant clauses of the specification.

**3. Test Methods for RIV:**

3.1 RIV tests shall be made according to measuring circuit as per International Special-Committee on Radio Interference (CISPR) Publication 16-1(1993) Part -1. The measuring circuit shall preferably be tuned to frequency with 10% of 0.5 Mhz but other frequencies in the range of 0.5 MHz to 2 MHz may be used, the measuring frequency being recorded. The results shall be in microvolts.

3.2 Alternatively, RIV tests shall be carried out in accordance with relevant IEC of respective equipment or NEMA standard Publication No. 107-1964.

3.3 In measurement of, RIV, temporary additional external corona shielding may be provided. In measurements of RIV only standard fittings of identical type supplied with the equipment and a simulation of the connections as used in the actual installation will be permitted in the vicinity within 3.5 meters of terminals.

3.4 Ambient noise shall be measured before and after each series of tests to ensure that there is no variation in ambient noise level. If variation is present, the lowest ambient noise level will form basis for the measurements. RIV levels shall be measured at increasing and decreasing voltages of 85%, 100%, and 110% of the specified RIV test voltage for all equipment unless otherwise specified. The specified RIV test voltage for 765kV, 400 kV, 220 KV is listed in the detailed specification together with maximum permissible RIV level in microvolts.

3.5 The metering instruments shall be as per CISPR recommendation or equivalent device so long as it has been used by other testing authorities.

3.6 The RIV measurement may be made with a noise meter. A calibration procedure of the frequency to which noise meter shall be tuned shall establish the ratio of voltage at the high voltage terminal to voltage read by noise meter.

**4. Test Methods for Visible Corona**

The purpose of this test is to determine the corona extinction voltage of apparatus, connectors etc. The test shall be carried out in the same manner as RIV test described above with the exception that RIV measurements are not required during test and a search technique shall be used near the onset and extinction voltage, when the test voltage is raised and lowered to determine their precise values. The test voltage shall be raised to 110% of specified corona extinction voltage and maintained there for five minutes. In case corona inception does not take place at 110%, test shall be stopped,

## **SECTION-GENERAL TECHNICAL REQUIREMENTS (GTR)**

### **ANNEXURE-A**

otherwise test shall be continued and the voltage will then be decreased slowly until all visible corona disappears. The procedure shall be repeated at least 3 times with corona inception and extinction voltage recorded each time. The corona extinction voltage for purposes of determining compliance with the specification shall be the lowest of the three values at which visible corona (negative or positive polarity) disappears.

The test to determine the visible corona extinction voltage need not be carried out simultaneously with test to determine RIV levels.

However, both test shall be carried out with the same test set up and as little time duration between tests as possible. No modification on treatment of the sample between tests will be allowed. Simultaneous RIV and visible corona extinction voltage testing may be permitted at the discretion of Employer's inspector if, in his opinion, it will not prejudice other test

#### **5. Test Records:**

In addition to the information previously mentioned and the requirements specified as per CISPR or NEMA 107-1964 the following data shall be included in test report:

- a) Background noise before and after test.
- b) Detailed procedure of application of test voltage.
- c) Measurements of RIV levels expressed in micro volts at each level.
- d) Results and observations with regard to location and type of interference sources detected at each step.
- e) Test voltage shall be recorded when measured RIV passes through 100 microvolts in each direction.
- f) Onset and extinction of visual corona for each of the four tests required shall be recorded.

**SECTION-GENERAL TECHNICAL REQUIREMENTS (GTR)**

**ANNEXURE-B**

**SEISMIC WITHSTAND TEST PROCEDURE**

The seismic withstanding test on the complete equipment (for 400kV and above) shall be carried out along with supporting structure. Seismic Withstand Test carried out using either lattice or pipe structure is acceptable.” **Seismic Calculations certified by NABL Labs shall also be acceptable**

The Bidder shall arrange to transport the structure from his Contractor’s premises/ POWERGRID sites for the purpose of seismic withstand test only.

The seismic level specified shall be applied at the base of the structure. The accelerometers shall be provided at the Terminal Pad of the equipment and any other point as agreed by the Employer. The seismic test shall be carried out in all possible combinations of the equipment. The seismic test procedure shall be furnished for approval of the Employer.

The frequency range for the earthquake spectra shall be as per IEC-62271-300.

**SECTION-GENERAL TECHNICAL REQUIREMENTS (GTR)****ANNEXURE-C****LIST OF GENERAL STANDARDS AND CODES**

<b>CODES</b>	<b>TITLE</b>
--	India Electricity Rules
--	Indian Electricity Act
--	Indian Electricity (Supply) Act
--	Indian Factories Act
IS-5	Colors for Ready Mixed Paints and Enamels
IS-335	New Insulating Oils
IS-617	Aluminium and Aluminium Alloy Ingots and Castings for General Engineering Purposes
IS-1448 (P1 to P 145)	Methods of Test for Petroleum and its Products
IS-2071 (P1 to P3)	Methods of High Voltage Testing
IS-12063	Classification of degrees of protection provided by enclosures of electrical equipment
IS-2165 ; P1:1997, P2:1983	Insulation Coordination
IS-3043	Code of Practice for Earthing
IS-6103	Method of Test for Specific Resistance (Resistivity) of Electrical Insulating Liquids
IS-6104	Method of Test for Interfacial Tension of Oil against Water by the Ring Method
IS-6262	Method of test for Power factor & Dielectric Constant of Electrical Insulating Liquids
IS-6792	Method for determination of electric strength of insulating oils
IS-5578	Guide for marking of insulated conductors
IS-11353	Guide for uniform system of marking & identification of conductors & apparatus terminals.
IS-8263	Methods for Radio Interference Test on High voltage Insulators
IS-9224 (Part 1,2&4)	Low Voltage Fuses
IEC-60060 (Part 1 to P4)	High Voltage Test Techniques
IEC 60068	Environmental Test
IEC-60117	Graphical Symbols
IEC-60156	Method for the Determination of the Electrical Strength of Insulation Oils
IEC-60270	Partial Discharge Measurements
IEC-60376	Specification and Acceptance of New Sulphur Hexafluoride
IEC-60437	Radio Interference Test on High Voltage Insulators
IEC-60507	Artificial Pollution Tests on High Voltage Insulators to be used on AC Systems
IEC-62271-1	Common Specification for High Voltage Switchgear & Control gear Standards
IEC-60815	Guide for the Selection of Insulators in respect of Polluted Conditions

**SECTION-GENERAL TECHNICAL REQUIREMENTS (GTR)****ANNEXURE-C**

<b>CODES</b>	<b>TITLE</b>
IEC-60865 (P1 & P2)	Short Circuit Current - Calculation of effects
ANSI-C.1/NFPA.70	National Electrical Code
ANSI-C37.90A	Guide for Surge Withstand Capability (SWC) Tests
ANSI-C63.21, C63.3	Specification for Electromagnetic Noise and Field Strength Instrumentation 10 KHz to 1 GHZ
C36.4ANSI-C68.1	Techniquet for Dielectric Tests
ANSI-C76.1/EEE21	Standard General Requirements and Test Procedure for Outdoor Apparatus Bushings
ANSI-SI-4	Specification for Sound Level Meters
ANSI-Y32-2/C337.2	Drawing Symbols
ANSI-Z55.11	Gray Finishes for Industrial Apparatus and Equipment No. 61 Light Gray
NEMA-107T	Methods of Measurements of RIV of High Voltage Apparatus
NEMA-ICS-II	General Standards for Industrial Control and Systems Part ICSI-109
CISPR-1	Specification for CISPR Radio Interference Measuring Apparatus for the frequency range 0.15 MHz to 30 MHz
CSA-Z299.1-1978h	Quality Assurance Program Requirements
CSA-Z299.2-1979h	Quality Control Program Requirements
CSA-Z299.3-1979h	Quality Verification Program Requirements
CSA-Z299.4-1979h	Inspection Program Requirements
<b>TRANSFORMERS AND REACTORS</b>	
IS:10028 (Part 2 & 3)	Code of practice for selection, installation & maintenance of Transformers (P1:1993), (P2:1991), (P3:1991)
IS-2026 (P1 to P4)	Power Transformers
IS-3347 (part 1 to Part 8)	Dimensions for Porcelain transformer Bushings for use in lightly polluted atmospheres
IS-3639	Fittings and Accessories for Power Transformers
IS-6600	Guide for Loading of oil immersed Transformers
IEC-60076 (Part 1 to 5)	Power Transformers
IEC-60214	On-Load Tap-Changers
IEC-60289	Reactors
IEC- 60354	Loading Guide for Oil - Immersed power transformers
IEC-60076-10	Determination of Transformer and Reactor Sound Levels
ANSI-C571280	General requirements for Distribution, Power and Regulating Transformers
ANSI-C571290	Test Code for Distribution, Power and Regulation Transformers
ANSI-C5716	Terminology & Test Code for Current Limiting Reactors
ANSI-C5721	Requirements, Terminology and Test Code for Shunt Reactors Rated Over 500 KVA
ANSI-C5792	Guide for Loading Oil-Immersed Power Transformers upto and including 100 MVA with 55 deg C or 65 deg C Winding Rise

**SECTION-GENERAL TECHNICAL REQUIREMENTS (GTR)****ANNEXURE-C**

<b>CODES</b>	<b>TITLE</b>
ANSI-CG,1EEE-4	Standard Techniques for High Voltage Testing
IEC 60076	Power transformers
IEC 60076-1	Part 1: General
IEC 60076-2	Part 2: Temperature rise
IEC 60076-3	Part 3: Insulation levels, dielectric tests and external clearances in air
IEC 60076-4	Part 4: Guide to the lightning impulse and switching impulse testing - Power transformers and reactors
IEC 60076-3-1	Part 3-1: Insulation Levels and Dielectric Tests –External Clearances in Air
IEC 60076-5	Part 5: Ability to withstand short circuit
IEC 60076-6	Part 6: Reactors
IEC 60076-7	Part 7: Loading guide for oil-immersed power transformers
IEC 60076-8	Part 8: Application guide
IEC 60076-10	Part 10: Determination of sound levels
IEC 60076-10-1	Part 10-1: Determination of sound levels - Application guide
IEC 60076-11	Part 11: Dry-type transformers
IEC 60076-12	Part 12: Loading guide for dry-type power transformers
IEC 60076-13	Part 13: Self-protected liquid-filled transformers
IEC 60076-14	Part 14: Design and application of liquid-immersed power transformers using high-temperature insulation materials
IEC 60076-15	Part 15: Gas-filled power transformers
IEC 60076-16	Part 16: Transformers for wind turbine applications
IEC 60076-18	Part 18: Measurement of frequency response
IEC 60076-19	Part 19: Rules for the determination of uncertainties in the measurement of losses in power transformers and reactors
IEC 60076-21	Part 21: Standard requirements, terminology, and test code for step-voltage regulators
IEC 60044, BS 3938	Current transformers
IEC 60050	International Electrotechnical Vocabulary
IEC 60050(421)	International Electrotechnical vocabulary- Chapter 421 : Power Transformers and Reactors
IEC 60060	High Voltage test techniques
IEC 60060-1	General definitions and test requirements
IEC 60060-2	Measuring systems
IEC 60071	Insulation co-ordination
IEC 60071-1	Part 1: Definitions, principles and rules
IEC 60071-2	Part 2 : Application guide
IEC 60137	Bushing for alternating voltage above 1000V
IEC 60214	On-Load Tap changers
IEC 255-21-3	Relays vibration

**SECTION-GENERAL TECHNICAL REQUIREMENTS (GTR)****ANNEXURE-C**

<b>CODES</b>	<b>TITLE</b>
IEC 60270	Partial discharge measurements
IEC 60296	Specification for Unused Mineral Oil for Transformers and Switchgear
IEC 60422	Supervision and Maintenance guide for Mineral Insulating Oil in Electrical Equipment
IEC 60475	Method of Sampling Liquid dielectrics
IEC 60529	Classification of Degrees of Protection provided by Enclosures
IEC 60542	Application Guide for On-Load Tap-Changers
IEC 60567	Guide for the Sampling of Gases and of Oil from Oil-filled Electrical Equipment for the Analysis of Free and Dissolved Gases
IEC 60651	Sound Level Meters
IEC 61083	Digital Recorders and Software for High Voltage Impulse testing
IEC 61083-1	Part 1: Requirements for digital recorders in high voltage impulse tests
IEC 61083-2	Part 2: Evaluation of software used for the determination of the parameters of impulse waveforms
CISPR 16	Specification for radio disturbance and immunity measuring apparatus
CISPR 16-1	Radio disturbance and immunity measuring apparatus
CISPR-18	Radio Interference Characteristics of Power Lines and High Voltage Equipment
ISO 9001	Quality system-Model for Quality Assurance in Design /development
Cigre Publication 202	Guidelines for conducting design reviews for transformers 100 MVA and 123 kV and above. August 2002-Cigre Working Group 12.22
WG 12-15	Guide for Customers Specifications for Transformers 100 MVA and 123 kV and above
WG 12 19	Short Circuit Performance of Transformers.
BS-4360	Specification for weldable structural steel
BS-5135	Specification for arc welding of carbon and carbon manganese steels
BS-5500	Specification for unfired fusion welded pressure vessels
IS-3618	Specification for phosphate treatment of iron & steel for protection against corrosion
IS-6005	Code of practice for phosphating of Iron and Steel
ISO-8501	Preparation of steel surface before application of Paints and related product
IEC-60599	Mineral oil impregnated electrical equipment in service – guide to the interpretation of dissolved and free gases analysis
IS-10593	Method of evaluating the analysis of gases in oil filled electrical equipment in service
IS-2099	Bushings for alternating voltages above 1000 volts

**SECTION-GENERAL TECHNICAL REQUIREMENTS (GTR)****ANNEXURE-C**

<b>CODES</b>	<b>TITLE</b>
IS-3347 Part I to 8	Dimension for porcelain transformer bushing
DIN-42530	Bushing up to 1000kV from 250A-5000A for liquid filled Transformer
IS-2026 Part 1 to 5	Power transformer
IS-4691	Degrees of protection provided by enclosure for rotating electrical machinery
IEC-60034-5	Degrees of protection provided by integral design of rotating electrical machines(IP Code) classification
IS:325 / IEC -60034	Performance of cooling fan / oil pump motor
IS-13947 part 1 to 5	Specification for low voltage switchgear and control gear
IS:3400	Methods of test for vulcanised rubber
IS:7016 part 1 to 14	Methods of test for coated and treated fabrics
IS:803	Code of practice for design, fabrication and erection of vertical mild steel cylindrical welded oil storage tanks.
IS:3637	Gas operated Relays
IS:335	New Insulating oils – Specification
IEC-62271-203	Gas insulated metal enclosed switchgear for rated voltage above 52kV
IEC-61639	Direct connection between power transformers and gas-insulated metal enclosed switchgear for rated voltages of 52.5 kV and above.
IS:3400 / BS 903 / IS:7016	Air cell ( Flexible Air Separator)
IEC 60529 / IP : 55	Degree of protection for cooler control cabinet , MOLG, Cooling fan , oil pump, Buchholz Relay
IEC 60529 / IP : 56	Degree of protection for Pressure Relief Device
IEC 60529 / IP : 43	Degree of protection for Remote tap Changer cubicle (RTCC)
<b>CIRCUIT BREAKERS</b>	
IEC-62271-100	High-voltage switchgear and control gear - Part 100: Alternating current circuit-breakers
IEC-62271-101	High-voltage switchgear and control gear - Part 101: Synthetic testing
IEC-62155	Hollow pressurized and unpressurized ceramic and glass insulators for use in electrical equipment with rated voltages greater than 1000 V
IEC-62271-110	High-voltage switchgear and control gear - Part 110: Inductive load switching
IEC-62271-109	High-voltage switchgear and control gear - Part 110: Inductive load switching
<b>CURRENT TRANSFORMERS, VOLTAGE TRANSFORMERS AND COUPLING CAPACITOR VOLTAGE TRANSFORMERS</b>	
IS-2705- (P1 to P4)	Current Transformers

**SECTION-GENERAL TECHNICAL REQUIREMENTS (GTR)****ANNEXURE-C**

<b>CODES</b>	<b>TITLE</b>
IS:3156- (P1 to P4)	Voltage Transformers
IS-4379	Identification of the Contents of Industrial Gas Cylinders
IEC-61869 (Part-1)	Instrument transformers - Part 1: General requirements
IEC-61869 (Part-2)	Instrument transformers - Part 2: Additional requirements for current transformers
IEC-61869 (Part-3)	Instrument transformers - Part 3: Additional requirements for inductive voltage transformers
IEC-61869 (Part-4)	Instrument transformers - Part 4: Additional requirements for combined transformers
IEC-61869 (Part-5)	Instrument transformers - Part 5: Additional requirements for capacitor voltage transformers
IEC-61869 (Part-6)	Instrument transformers - Part 6: Additional general requirements for low-power instrument transformers
IEC-61869 (Part-9)	Instrument transformers - Part 9: Digital interface for instrument transformers
IEC-61869 (Part-102)	Instrument transformers - Part 102: Ferroresonance oscillations in substations with inductive voltage transformers
IEC-61869 (Part-103)	Instrument transformers - The use of instrument transformers for power quality measurement
<b>BUSHING</b>	
IS-2099	Bushings for Alternating Voltages above 1000V
IEC-60137	Insulated Bushings for Alternating Voltages above 1000V
<b>SURGE ARRESTERS</b>	
IS-3070 (PART2)	Lightning arresters for alternating current systems : Metal oxide lightning arrestors without gaps
IEC-60099-4	Metal oxide surge arrestors without gaps
IEC-60099-5	Selection and application recommendation
ANSI-C62.1	IEE Standards for S A for AC Power Circuits
NEMA-LA 1	Surge Arresters
<b>CUBICLES AND PANELS &amp; OTHER RELATED EQUIPMENTS</b>	
IS-722, IS-1248	Electrical relays for power system
IS-3231, 3231 (P-3)	Protection
IS:5039	Distributed pillars for Voltages not Exceeding 1000 Volts
IEC-60068.2.2	Basic environmental testing procedures Part 2: Test B: Dry heat
IEC-60529	Degree of Protection provided by enclosures
IEC-60947-4-1	Low voltage switchgear and control gear
IEC-61095	Electromechanical Contactors for household and similar purposes
IEC-60439 (P1 & 2)	Low Voltage Switchgear and control gear assemblies
ANSI-C37.20	Switchgear Assemblies, including metal enclosed bus
ANSI-C37.50	Test Procedures for Low Voltage Alternating Current Power

**SECTION-GENERAL TECHNICAL REQUIREMENTS (GTR)****ANNEXURE-C**

<b>CODES</b>	<b>TITLE</b>
	Circuit Breakers
ANSI-C39	Electric Measuring instrument
ANSI-C83	Components for Electric Equipment
IS: 8623: (Part I to 3)	Specification for Switchgear & Control Assemblies
NEMA-AB	Moulded Case Circuit and Systems
NEMA-CS	Industrial Controls and Systems
NEMA-PB-1	Panel Boards
NEMA-SG-5	Low voltage Power Circuit breakers
NEMA-SG-3	Power Switchgear Assemblies
NEMA-SG-6	Power switching Equipment
NEMA-5E-3	Motor Control Centers
1248 (P1 to P9)	Direct acting indicating analogue electrical measuring instruments & their accessories
<b>Disconnecting switches</b>	
IEC-62271-102	High-voltage switchgear and control gear - Part 102: Alternating current disconnectors and earthing switches
IEC-60265 (Part 1 & 2)	High Voltage switches
ANSI-C37.32	Schedule of preferred Ratings, Manufacturing Specifications and Application Guide for high voltage Air Switches, Bus supports and switch accessories
ANSI-C37.34	Test Code for high voltage air switches
NEMA-SG6	Power switching equipment
<b>PLCC and line traps</b>	
IS-8792	Line traps for AC power system
IS-8793	Methods of tests for line traps
IS-8997	Coupling devices for PLC systems
IS-8998	Methods of test for coupling devices for PLC systems
IEC-60353	Line traps for A.C. power systems
IEC-60481	Coupling Devices for power line carrier systems
IEC-60495	Single sideboard power line carrier terminals
IEC-60683	Planning of (single Side-Band) power line carrier systems
CIGRE	Teleprotection report by Committee 34 & 35
CIGRE	Guide on power line carrier 1979
CCIR	International Radio Consultative Committee
CCITT	International Telegraph & Telephone Consultative Committee
EIA	Electric Industries Association
<b>Protection and control equipment</b>	
IEC-60051: (P1 to P9)	Recommendations for Direct Acting indicating analogue electrical measuring instruments and their accessories
IEC-60255 (Part 1 to 23)	Electrical relays
IEC-60297 (P1 to P4)	Dimensions of mechanical structures of the 482.6mm (19 inches)

**SECTION-GENERAL TECHNICAL REQUIREMENTS (GTR)****ANNEXURE-C**

<b>CODES</b>	<b>TITLE</b>
	series
IEC-60359	Expression of the performance of electrical & electronic measuring equipment
IEC-60387	Symbols for Alternating-Current Electricity meters
IEC-60447	Man machine interface (MMI) - Actuating principles
IEC-60521	Class 0.5, 1 and 2 alternating current watt hour metres
IEC-60547	Modular plug-in Unit and standard 19-inch rack mounting unit based on NIM Standard (for electronic nuclear instruments)
ANSI-81	Screw threads
ANSI-B18	Bolts and Nuts
ANSI-C37.1	Relays, Station Controls etc
ANSI-C37.2	Manual and automatic station control, supervisory and associated telemetering equipment
ANSI-C37.2	Relays and relay systems associated with electric power apparatus
ANSI-C39.1	Requirements for electrical analog indicating instruments
<b>MOTORS</b>	
IS-325	Three phase induction motors
IS-4691	Degree of protection provided by enclosure for rotating electrical machinery
IEC-60034 (P1 to P19:)	Rotating electrical machines
IEC-Document 2	Three phase induction motors
(Central Office) NEMA-MGI	Motors and Generators
<b>Electronic equipment and components</b>	
MIL-21B, MIL-833 & MIL-2750	Environmental testing
EC-60068 (P1 to P5)	Printed boards
IEC-60326 (P1 to P2)	Material and workmanship standards
IS-1363 (P1 to P3)	Hexagon head bolts, screws and nuts of product grade C
IS-1364 (P1 to P5)	Hexagon head bolts, screws and nuts of products grades A and B
IS-3138	Hexagonal Bolts and Nuts (M42 to M150)
ISO-898	Fasteners: Bolts, screws and studs
ASTM	Specification and tests for materials
<b>Clamps &amp; connectors</b>	
IS-5561	Electric power connectors
NEMA-CC1	Electric Power connectors for sub station
NEMA-CC 3	Connectors for Use between aluminium or aluminum-Copper Overhead Conductors
<b>Bus hardware and insulators</b>	
IS: 2121	Fittings for Aluminum and steel cored Al conductors for overhead

**SECTION-GENERAL TECHNICAL REQUIREMENTS (GTR)****ANNEXURE-C**

<b>CODES</b>	<b>TITLE</b>
	power lines
IS-731	Porcelain insulators for overhead power lines with a nominal voltage greater than 1000 V
IS-2486 (P1 to P4)	Insulator fittings for overhead power lines with a nominal voltage greater than 1000 V
IEC-60120	Dimensions of Ball and Socket Couplings of string insulator units
IEC-60137	Insulated bushings for alternating voltages above 1000 V
IEC-60168	Tests on indoor and outdoor post insulators of ceramic material or glass for Systems with Nominal Voltages Greater than 1000 V
IEC-62155	Hollow pressurized and unpressurized ceramic and glass insulators for use in electrical equipment with rated voltages greater than 1 000 V
IEC-60273	Characteristics of indoor and outdoor post insulators for systems with nominal voltages greater than 1000V
IEC-61462	Pressurized and un-pressurized insulator for use in electrical equipment with rated voltage greater than 1000V – Definitions, Test methods, acceptance criteria and design recommendations
IEC-60305	Insulators for overhead lines with nominal voltage above 1000V-ceramic or glass insulator units for ac systems Characteristics of String Insulator Units of the cap and pin type
IEC-60372 (1984)	Locking devices for ball and socket couplings of string insulator units : dimensions and tests
IEC-60383 (P1 and P2)	Insulators for overhead lines with a nominal voltage above 1000 V
IEC-60433	Characteristics of string insulator units of the long rod type
IEC-60471	Dimensions of Clevis and tongue couplings of string insulator units
ANSI-C29	Wet process porcelain insulators
ANSI-C29.1	Test methods for electrical power insulators
ANSI-C92.2	For insulators, wet-process porcelain and toughened glass suspension type
ANSI-C29.8	For wet-process porcelain insulators apparatus, post-type
ANSI-G.8	Iron and steel hardware
CISPR-7B	Recommendations of the CISPR, tolerances of form and of Position, Part 1
ASTM A-153	Zinc Coating (Hot-Dip) on iron and steel hardware
<b>Strain and rigid bus-conductor</b>	
IS-2678	Dimensions & tolerances for Wrought Aluminum and Aluminum Alloys drawn round tube
IS-5082	Wrought Aluminum and Aluminum Alloy Bars. Rods, Tubes and Sections for Electrical purposes
ASTM-B 230-82	Aluminum 1350 H19 Wire for electrical purposes

**SECTION-GENERAL TECHNICAL REQUIREMENTS (GTR)****ANNEXURE-C**

<b>CODES</b>	<b>TITLE</b>
ASTM-B 231-81	Concentric - lay - stranded, aluminum 1350 conductors
ASTM-B 221	Aluminum - Alloy extruded bar, rod, wire, shape
ASTM-B 236-83	Aluminum bars for electrical purpose (Bus-bars)
ASTM-B 317-83	Aluminum-Alloy extruded bar, rod, pipe and structural shapes for electrical purposes (Bus Conductors)
<b>Batteries</b>	
IS:1651	Stationary Cells and Batteries, Lead-Acid Type (with Tubular Positive Plates)
IS:1652	Stationary Cells and Batteries, Lead-Acid Type (with Plante Positive Plates)
IS:1146	Rubber and Plastic Containers for Lead-Acid Storage Batteries
IS:6071	Synthetic Separators for Lead-Acid Batteries
IS:266	Specification for Sulphuric Acid
IS:1069	Specification for Water for Storage Batteries
IS:3116	Specification for Sealing Compound for Lead-Acid Batteries
IS:1248	Indicating Instruments
IS:10918	Vented type nickel Cadmium Batteries
IEC:60896-21&22	Lead Acid Batteries Valve Regulated types – Methods of Tests & Requirements
IEC: 60623	Vented type nickel Cadmium Batteries
IEC:60622	Secondary Cells & Batteries – Sealed Ni-Cd rechargeable single cell
IEC:60623	Secondary Cells & Batteries – Vented Ni-Cd rechargeable single cell
IEC:60896-11	Stationary Lead Acid Batteries – Vented Type – General requirements & method of tests
IEEE-485	Recommended practices for sizing of Lead Acid Batteries
IEEE-1115	Sizing of Ni-Cd Batteries
IEEE-1187	Recommended practices for design & installation of VRLA Batteries
IEEE-1188	Recommended practices for design & installation of VRLA Batteries
IEEE-1189	Guide for selection of VRLA Batteries
<b>Battery Charger</b>	
IS:3895	Mono-crystalline Semiconductor Rectifier Cells and Stacks
IS:4540	Mono-crystalline Semiconductor Rectifier Assemblies and Equipment
IS:6619	Safety Code for Semiconductor Rectifier Equipment
IS:2026	Power Transformers

**SECTION-GENERAL TECHNICAL REQUIREMENTS (GTR)****ANNEXURE-C**

<b>CODES</b>	<b>TITLE</b>
IS:2959	AC Contactors for Voltages not Exceeding 1000 Volts
IS:1248	Indicating Instruments
IS:2208	HRC Fuses
IS:13947 (Part-3)	Air break switches, air break disconnectors & fuse combination units for voltage not exceeding 1000V AC or 1200V DC
IS:2147	Degree of protection provided by enclosures for low voltage switchgear and control gear
IS:6005	Code of practice for phosphating of Iron and Steel
IS:3231	Electrical relays for power system protection
IS:3842	Electrical relay for AC Systems
IS:5	Colours for ready mix paint
IEEE-484	Recommended Design for installation design and installation of large lead storage batteries for generating stations and substations
IEEE-485	Sizing large lead storage batteries for generating stations and substations
<b>Wires and cables</b>	
ASTMD-2863	Measuring the minimum oxygen concentration to support candle like combustion of plastics (oxygen index)
IS-694	PVC insulated cables for working voltages upto and including 1100 Volts
IS-1255	Code of practice for installation and maintenance of power cables, upto and including 33 kV rating
IS-1554 (P1 and P2)	PVC insulated (heavy duty) electric cables (part 1) for working voltage upto and including 1100 V Part (2) for working voltage from 3.3 kV upto and including 11kV
IS:1753	Aluminium conductor for insulated cables
IS:2982	Copper Conductor in insulated cables
IS-3961 (P1 to P5)	Recommended current ratings for cables
IS-3975	Mild steel wires, formed wires and tapes for armouring of cables
IS-5831	PVC insulating and sheath of electric cables
IS-6380	Elastometric insulating and sheath of electric cables
IS-7098	Cross linked polyethylene insulated PVC sheathed cables for working voltage upto and including 1100 volts
IS-7098	Cross-linked polyethylene insulated PVC sheathed cables for working voltage from 3.3kV upto and including 33 kV
IS-8130	Conductors for insulated electrical cables and flexible cords
IS-1753	Aluminum Conductors for insulated cables
IS-10418	Specification for drums for electric cables
IEC-60096 (part 0 to p4)	Radio Frequency cables
IEC-60183	Guide to the Selection of High Voltage Cables

**SECTION-GENERAL TECHNICAL REQUIREMENTS (GTR)****ANNEXURE-C**

<b>CODES</b>	<b>TITLE</b>
IEC-60189 (P1 to P7)	Low frequency cables and wires with PVC insulation and PVC sheath
IEC-60227 (P1 to P7)	Polyvinyl Chloride insulated cables of rated voltages up to and including 450/750V
IEC-60228	Conductors of insulated cables
IEC-60230	Impulse tests on cables and their accessories
IEC-60287 (P1 to P3)	Calculation of the continuous current rating of cables (100% load factor)
IEC-60304	Standard colours for insulation for low-frequency cables and wires
IEC-60331	Fire resisting characteristics of Electric cables
IEC-60332 (P1 to P3)	Tests on electric cables under fire conditions
IEC-60502	Extruded solid dielectric insulated power cables for rated voltages from 1 kV upto to 30 kV
IEC-754 (P1 and P2)	Tests on gases evolved during combustion of electric cables
<b>AIR conditioning and ventilation</b>	
IS-659	Safety code for air conditioning
IS-660	Safety code for Mechanical Refrigeration
ARI:520	Standard for Positive Displacement Refrigeration Compressor and Condensing Units
IS:4503	Shell and tube type heat exchanger
ASHRAE-24	Method of testing for rating of liquid coolers
ANSI-B-31.5	Refrigeration Piping
IS:2062	Steel for general structural purposes
IS:655	Specification for Metal Air Dust
IS:277	Specification for Galvanised Steel Sheets
IS-737	Specification for Wrought Aluminium and Aluminium Sheet & Strip
IS-1079	Hot rolled cast steel sheet & strip
IS-3588	Specification for Electrical Axial Flow Fans
IS-2312	Propeller Type AC Ventilation Fans
BS-848	Methods of Performance Test for Fans
BS-6540 Part-I	Air Filters used in Air Conditioning and General Ventilation
BS-3928	Sodium Flame Test for Air Filters (Other than for Air Supply to I.C. Engines and Compressors)
US-PED-2098	Method of cold DOP & hot DOP test
MIL-STD-282	DOP smoke penetration method
ASHRAE-52	Air cleaning device used in general ventilation for removing particle matter
IS:3069	Glossary of Terms, Symbols and Units Relating to Thermal Insulation Materials

**SECTION-GENERAL TECHNICAL REQUIREMENTS (GTR)****ANNEXURE-C**

<b>CODES</b>	<b>TITLE</b>
IS:4671	Expanded Polystyrene for Thermal Insulation Purposes
IS:8183	Bonded Mineral Wool
IS:3346	Evaluation of Thermal Conductivity properties by means of guarded hot plate method
ASTM-C-591-69	Standard specification for rigid preformed cellular urethane thermal insulation
IS:4894	Centrifugal Fans
BS:848	Method of Performance Test for Centrifugal Fans
IS:325	Induction motors, three-phase
IS:4722	Rotating electrical machines
IS:1231	Three phase foot mounted Induction motors, dimensions of
IS:2233	Designations of types of construction and mounting arrangements of rotating electrical machines
IS:2254	Vertical shaft motors for pumps, dimensions of
IS:7816	Guide for testing insulation resistance of rotating machines
IS:4029	Guide for testing three phase induction motors
IS: 4729	Rotating electrical machines, vibration of, Measurement and evaluation of
IS:4691	Degree of protection provided by enclosures for rotating electrical machinery
IS:7572	Guide for testing single-phase ac motors
IS:2148	Flame proof enclosure for electrical apparatus
BS:4999(Part-51)	Noise levels
<b>Galvanizing</b>	
IS-209	Zinc Ingot
IS-2629	Recommended Practice for Hot-Dip galvanizing on iron and steel
IS-2633	Methods for testing uniformity of coating of zinc coated articles
ASTM-A-123	Specification for zinc (Hot Galvanizing) Coatings, on products Fabricated from rolled, pressed and forged steel shapes, plates, bars and strips
ASTM-A-121-77	Zinc-coated (Galvanized) steel barbed wire
<b>Painting</b>	
IS-6005	Code of practice for phosphating of iron and steel
ANSI-Z551	Gray finishes for industrial apparatus and equipment
SSPEC	Steel structure painting council
<b>Fire protection system</b>	
--	Fire protection manual issued by tariff advisory committee (TAC) of India
<b>HORIZONTAL CENTRIFUGAL PUMPS</b>	
IS:1520	Horizontal centrifugal pumps for clear, cold and fresh water
IS:9137	Code for acceptance test for centrifugal & axial pumps

**SECTION-GENERAL TECHNICAL REQUIREMENTS (GTR)****ANNEXURE-C**

<b>CODES</b>	<b>TITLE</b>
IS:5120	Technical requirement – Rotodynamic special purpose pumps
API-610	Centrifugal pumps for general services Hydraulic Institutes Standards
BS:599	Methods of testing pumps
PTC-8.2	Power Test Codes - Centrifugal pumps
<b>DIESEL ENGINES</b>	
IS:10000	Methods of tests for internal combustion engines
IS:10002	Specification for performance requirements for constant speed compression ignition engines for general purposes (above 20 kW)
BS:5514	The performance of reciprocating compression ignition (Diesel) engines, utilizing liquid fuel only, for general purposes
ISO:3046	Reciprocating internal combustion engines performance
IS:554	Dimensions for pipe threads where pressure tight joints are required on threads
ASME Power Test Code	Internal combustion engine PTC-17
--	Codes of Diesel Engine Manufacturer's Association, USA
<b>PIPING VALVES &amp; SPECIALITIES</b>	
IS:636	Non percolating flexible fire-fighting delivery hose
IS:638	Sheet rubber jointing and rubber inserting jointing
IS:778	Gun metal gate, globe and check valves for general purpose
IS:780	Sluice valves for water works purposes (50 to 300 mm)
IS:901	Couplings, double male and double female instantaneous pattern for fire fighting
IS:902	Suction hose couplings for fire-fighting purposes
IS:903	Fire hose delivery couplings branch pipe nozzles and nozzle spanner
IS:1538	Cast iron fittings for pressure pipes for water, gas and sewage
IS:1903	Ball valve (horizontal plunger type) including floats for water supply purposes
IS:2062	SP for weldable structural steel
IS:2379	Colour Code for the identification of pipelines
IS:2643	Dimensions of pipe threads for fastening purposes
IS:2685	Code of Practice for selection, installation and maintenance of sluice valves
IS:2906	Sluice valves for water-works purposes (350 to 1200 mm size)
IS:3582	Basket strainers for fire-fighting purposes (cylindrical type)
IS:3589	Electrically welded steel pipes for water, gas and sewage (150 to 2000 mm nominal diameter)
IS:4038	Foot valves for water works purposes
IS:4927	Unlined flax canvas hose for fire fighting

**SECTION-GENERAL TECHNICAL REQUIREMENTS (GTR)****ANNEXURE-C**

<b>CODES</b>	<b>TITLE</b>
IS:5290	Landing valves (internal hydrant)
IS:5312 (Part-I)	Swing check type reflex (non-return) valves
IS:5306	Code of practice for fire extinguishing installations and equipment on premises
Part-I	Hydrant systems, hose reels and foam inlets
Part-II	Sprinkler systems
BS:5150	Specification for cast iron gate valves
<b>MOTORS &amp; ANNUNCIATION PANELS</b>	
IS:325	Three phase induction motors
IS:900	Code of practice for installation and maintenance of induction motors
IS:996	Single phase small AC and universal electric motors
IS:1231	Dimensions of three phase foot mounted induction motors
IS:2148	Flame proof enclosure of electrical apparatus
IS:2223	Dimensions of flange mounted AC induction motors
IS:2253	Designations for types of construction and mounting arrangements of rotating electrical machines
IS:2254	Dimensions of vertical shaft motors for pumps
IS:3202	Code of practice for climate proofing of electrical equipment
IS:4029	Guide for testing three phase induction motors
IS:4691	Degree of protection provided by enclosure for rotating electrical machinery
IS:4722	Rotating electrical machines
IS:4729	Measurement and evaluation of vibration of rotating electrical machines
IS:5572	Classification of hazardous areas for electrical (Part-I) installations (Areas having gases and vapours)
IS:6362	Designation of methods of cooling for rotating electrical machines
IS:6381	Construction and testing of electrical apparatus with type of protection 'e'
IS:7816	Guide for testing insulation for rotating machine
IS:4064	Air break switches
IEC DOCUMENT 2 (Control Office) 432	Three Phase Induction Motor
VDE 0530 Part I/66	Three Phase Induction Motor
IS:9224 (Part-II)	HRC Fuses
IS:6875	Push Button and Control Switches
IS:694	PVC Insulated cables
IS:1248	Indicating instruments
IS:375	Auxiliary wiring & busbar markings

**SECTION-GENERAL TECHNICAL REQUIREMENTS (GTR)****ANNEXURE-C**

<b>CODES</b>	<b>TITLE</b>
IS:2147	Degree of protection
IS:5	Colour Relay and timers
IS:2959	Contactors
<b>PG Test Procedures</b>	
NFPA-13	Standard for the installation of sprinkler system
NFPA-15	Standard for water spray fixed system for the fire protection
NFPA-12A	Standard for Halong 1301 Fire Extinguishing System
NFPA-72E	Standard on Automatic Fire Detectors
--	Fire Protection Manual by TAC (Latest Edition)
NFPA-12	Standard on Carbon dioxide extinguisher systems
IS:3034	Fire of industrial building
--	Electrical generating and distributing stations code of practice
IS:2878	CO <sub>2</sub> (Carbon dioxide) Type Extinguisher
IS:2171	DC (Dry Chemical Powder) type
IS:940	Pressurised Water Type
<b>D.G. SET</b>	
IS:10002	Specification for performance requirements for constant speed compression ignition (diesel engine) for general purposes
IS:10000	Method of tests for internal combustion engines
IS:4722	Rotating electrical machines-specification
IS:12063	Degree of protection provided by enclosures
IS:12065	Permissible limit of noise levels for rotating electrical machines
--	Indian Explosive Act 1932
<b>Steel structures</b>	
IS-228 (1992)	Method of Chemical Analysis of pig iron, cast iron and plain carbon and low alloy steels.
IS-802 (P1 to 3)	Code of practice for use of structural steel in overhead transmission line towers
IS-806	Code of practice for use of steel tubes in general building construction
IS-808	Dimensions for hot rolled steel beam, column channel and angle sections
IS-814	Covered electrodes for manual arc welding of carbon of carbon manganese steel
IS-816	Code of Practice for use of metal arc welding for general construction in Mild steel
IS-817	Code of practice for training and testing of metal arc welders. Part 1 : Manual Metal arc welding
IS-875 (P1 to P4)	Code of practice for design loads (other than earthquake) for buildings and structures
IS-1161	Steel tubes for structural purposes

**SECTION-GENERAL TECHNICAL REQUIREMENTS (GTR)****ANNEXURE-C**

<b>CODES</b>	<b>TITLE</b>
IS-1182	Recommended practice for radiographic examination of fusion welded butt joints in steel plates
IS-1363 (P1 to P3)	Hexagonal head bolts, screws & nuts of products grade C
IS-1364	Hexagon head bolts, screws and nuts of product grades A and B
IS-1367 (P1 to P18)	Technical supply condition for threaded steel fasteners
IS-1599	Methods for bend test
IS-1608	Method for tensile testing of steel products
IS-1893	Criteria for earthquake resistant design of structures
IS-1978	Line Pipe
IS-2062	Steel for general structural purposes
IS-2595	Code of practice for Radiographic testing
IS-3063	Single coil rectangular section spring washers for bolts, nuts and screws
IS-3664	Code of practice for ultrasonic pulse echo testing by contact and immersion methods
IS-7205	Safety code for erection of structural steel work
IS-9595	Recommendations for metal arc welding of carbon and carbon manganese steels
ANSI-B18.2.1	Inch series square and Hexagonal bolts and screws
ANSI-B18.2.2	Square and hexagonal nuts
ANSI-G8.14	Round head bolts
ASTM-A6	Specification for General Requirements for rolled steel plates, shapes, sheet piling and bars of structural use
ASTM-A36	Specifications of structural steel
ASTM-A47	Specification for malleable iron castings
ASTM-A143	Practice for safeguarding against embilement of Hot Galvanized structural steel products and procedure for detaching embriement
ASTM-A242	Specification for high strength low alloy structural steel
ASTM-A283	Specification for low and intermediate tensile strength carbon steel plates of structural quality
ASTM-A394	Specification for Galvanized steel transmission tower bolts and nuts
ASTM-441	Specification for High strength low alloy structural manganese vanadium steel
ASTM-A572	Specification for High strength low alloy colombium-Vanadium steel of structural quality
AWS D1-0	Code for welding in building construction welding inspection
AWS D1-1	Structural welding code
AISC	American institute of steel construction
NEMA-CG1	Manufactured graphite electrodes

**SECTION-GENERAL TECHNICAL REQUIREMENTS (GTR)****ANNEXURE-C**

<b>CODES</b>	<b>TITLE</b>
<b>Piping and pressure vessels</b>	
IS-1239 (Part 1 and 2)	Mild steel tubes, tubulars and other wrought steel fittings
IS -3589	Seamless Electrically welded steel pipes for water, gas and sewage
IS-6392	Steel pipe flanges
ASME	Boiler and pressure vessel code
ASTM-A120	Specification for pipe steel, black and hot dipped, zinc-coated (Galvanized) welded and seamless steel pipe for ordinary use
ASTM-A53	Specification for pipe, steel, black, and hot-dipped, zinc coated welded and seamless
ASTM-A106	Seamless carbon steel pipe for high temperature service
ASTM-A284	Low and intermediate tensile strength carbon-silicon steel plates for machine parts and general construction
ASTM-A234	Pipe fittings of wrought carbon steel and alloy steel for moderate and elevated temperatures
ASTM-S181	Specification for forgings, carbon steel for general purpose piping
ASTM-A105	Forgings, carbon steel for piping components
ASTM-A307	Carbon steel externally threaded standard fasteners
ASTM-A193	Alloy steel and stainless steel bolting materials for high temperature service
ASTM-A345	Flat rolled electrical steel for magnetic applications
ASTM-A197	Cupola malleable iron
ANSI-B2.1	Pipe threads (Except dry seal)
ANSI-B16.1	Cast iron pipe flanges and flanged fitting. Class 25, 125, 250 and 800
ANSI-B16.1	Malleable iron threaded fittings, class 150 and 300
ANSI-B16.5	Pipe flanges and flanged fittings, steel nickel alloy and other special alloys
ANSI-B16.9	Factory-made wrought steel butt welding fittings
ANSI-B16.11	Forged steel fittings, socket-welding and threaded
ANSI-B16.14	Ferrous pipe plug, bushings and locknuts with pipe threads
ANSI-B16.25	Butt welding ends
ANSI-B18.1.1	Fire hose couplings screw thread
ANSI-B18.2.1	Inch series square and hexagonal bolts and screws
ANSI-B18.2.2	Square and hexagonal nuts
ANSI-B18.21.1	Lock washers
ANSI-B18.21.2	Plain washers
ANSI-B31.1	Power piping
ANSI-B36.10	Welded and seamless wrought steel pipe
ANSI-B36.9	Stainless steel pipe
<b>Other civil works standards</b>	

**SECTION-GENERAL TECHNICAL REQUIREMENTS (GTR)****ANNEXURE-C**

<b>CODES</b>	<b>TITLE</b>
IS-269	33 grade ordinary portland cement
IS2721	Galvanized steel chain link fence fabric
IS-278	Galvanized steel barbed wire for fencing
IS-383	Coarse and fine aggregates from natural sources for concrete
IS-432 (P1 and P2)	Mild steel and medium tensile steel bars and hard-dawn steel wire for concrete reinforcement
IS-456	Code of practice for plain and reinforced concrete
IS-516	Method of test for strength of concrete
IS-800	Code of practice for general construction in steel
IS-806	Steel tubes for structural purposes
IS-1172	Basic requirements for water supply, drainage and sanitation
IS-1199	Methods of sampling and analysis of concrete
IS-1566	Hard-dawn steel wire fabric for concrete reinforcement
IS-1742	Code of Practice for Building drainage
IS-1785	Plain hard-drawn steel wire for pre-stressed concrete
IS-1786	High strength deformed Steel Bars and wires for concrete reinforcement
IS-1811	Methods of sampling Foundry sands
IS-1893	Criteria for earthquake resistant design of structures
IS-2062	Steel for general structural purposes
IS-2064	Selection, installation and maintenance of sanitary appliances-code of practices
IS-2065	Code of practice for water supply in buildings
IS-2090	High tension steel bars used in pre-stressed concrete
IS-2140	Standard Galvanized steel wire for fencing
IS-2470 (P1 & P2)	Code of practice for installation of septic tanks
IS-2514	Concrete vibrating tables
IS-2645	Integral cement waterproofing compounds
IS-3025 (Part 1 to Part 48)	Methods of sampling and test (Physical and chemical) for water and waste water
IS-4091	Code of practice for design and construction of foundations for transmission line towers and poles
IS-4111 (Part 1 to P5)	Code of practice for ancillary structures in sewerage system
IS-4990	Plywood for concrete shuttering work
IS-5600	Sewage and drainage pumps
<b>National building code of India 1970</b>	
USBR E12	Earth Manual by United States Department of the interior Bureau of Reclamation
ASTM-A392-81	Zinc/Coated steel chain link fence fabric
ASTM-D1557-80	test for moisture-density relation of soils using 10-lb (4.5 kg)

**SECTION-GENERAL TECHNICAL REQUIREMENTS (GTR)****ANNEXURE-C**

<b>CODES</b>	<b>TITLE</b>
	rame land 18-in. (457 mm) Drop
ASTM-D1586(1967)	Penetration Test and Split-Barrel Sampling of Soils
ASTM-D2049-69	Test Method for Relative Density of Cohesionless Soils
ASTM-D2435	Test method for Unconsolidated, (1982) Undrained Strengths of Cohesive Soils in Triaxial Compression
BS-5075	Specification for accelerating Part I Admixtures, Retarding Admixtures and Water Reducing Admixtures
CPWD	Latest CPWD specifications
<b>ACSR MOOSE CONDUCTOR</b>	
IS:6745 BS:443-1969	Methods for Determination of Mass of zinc coating on zinc coated Iron and Steel Articles
IS:8263	Methods for Radio Interference
IEC:437-1973 NEMA:107-1964 CISPR	Test on High Voltage Insulators
IS:209, BS:3436-1961	Zinc Ingot
IS:398 Part - V IEC:209-1966	Aluminum Conductors for Overhead Transmission Purposes
BS:215(Part-II), IEC:209-1966	Aluminium Conductors galvanized steel reinforced extra high voltage (400 kV and above)
IS:1778, BS:1559-1949	Reels and Drums for Bare Conductors
IS:1521, ISO/R89-1959	Method for Tensile Testing of steel wire
IS:2629	Recommended practice for Hot dip Galvanising on Iron and Steel
IS:2633	Method for Testing Uniformity of coating of zinc Coated Articles
IS:4826/ ASTMA-472-729	Hot dip galvanised coatings on round steel wires
<b>GALVANISED STEEL EARTHWIRE</b>	
IS:1521, ISO/R:89-1959	Method for Tensile Testing of Steel Wire
IS:1778	Reels and Drums for Bare Conductors
IS:2629	Recommended practice for Hot Dip Galvanising on Iron and Steel
IS:2633	Methods for testing Uniformity of Coating of Zinc Coated Articles
IS:4826/ ASTM: A 475-72a BS:443-1969	Hot dip Galvanised Coatings on Round Steel Wires
IS:6745/ BS:443-1969	Method for Determination of mass of Zinc Coating on Zinc coated Iron and Steel Articles.
IS:209/ BS:3463-1961	Zinc ingot
IS:398 (Pt. I to P5:1992)/ BS:215 (Part-II	Aluminum Conductors for overhead transmission purposes

**SECTION-GENERAL TECHNICAL REQUIREMENTS (GTR)****ANNEXURE-C**

<b>CODES</b>	<b>TITLE</b>
<b>Lighting Fixtures and Accessories</b>	
IS:1913	General and safety requirements for electric lighting fittings
IS:3528	Water proof electric lighting fittings
IS:4012	Dust proof electric lighting fittings
IS:4013	Dust tight proof electric lighting fittings
IS:10322	Industrial lighting fittings with metal reflectors
IS:10322	Industrial lighting fittings with plastic reflectors
IS:2206	Well glass lighting fittings for use under ground in mines (non-flameproof type)
IS:10322	Specification for flood light
IS:10322	Specification for decorative lighting outfits
IS:10322	Luminaries for street lighting
IS:2418	Tubular fluorescent lamps
IS:9900	High pressure mercury vapour lamps
IS:1258	Specification for Bayonet lamp fluorescent lamp
IS:3323	Bi-pin lamp holder tubular fluorescent lamps
IS:1534	Ballasts for use in fluorescent lighting fittings. (Part-I)
IS:1569	Capacitors for use in fluorescent lighting fittings
IS:2215	Starters for fluorescent lamps
IS:3324	Holders for starters for tubular fluorescent lamps
IS:418	GLS lamps
IS:3553	Water tight electric fittings
IS:2713	Tubular steel poles
IS:280	MS wire for general engg. Purposes
<b>Conduits, Accessories and Junction Boxes</b>	
IS:9537	Rigid steel conduits for electrical wiring
IS:3480	Flexible steel conduits for electrical wiring
IS:2667	Fittings for rigid steel conduits for electrical wiring
IS:3837	Accessories for rigid steel conduits for electrical wiring
IS:4649	Adaptors for flexible steel conduits
IS:5133	Steel and Cast Iron Boxes
IS:2629	Hot dip galvanising of Iron & Steel
<b>Lighting Panels</b>	
IS:13947	LV Switchgear and Control gear(Part 1 to 5)
IS:8828	Circuit breakers for over current protection for house hold and similar installations
IS:5	Ready mix paints
IS:2551	Danger notice plates
IS:2705	Current transformers

**SECTION-GENERAL TECHNICAL REQUIREMENTS (GTR)****ANNEXURE-C**

<b>CODES</b>	<b>TITLE</b>
IS:9224	HRC Cartridge fuse links for voltage above 650V(Part-2)
IS:5082	Wrought aluminium and Al. alloys, bars, rods, tubes and sections for electrical purposes
IS:8623	Factory built Assemblies of Switchgear and Control Gear for voltages upto and including 1000V AC and 1200V DC
IS:1248	Direct Acting electrical indicating instruments
<b>Electrical Installation</b>	
IS:1293	3 pin plug
IS:371	Two to three ceiling roses
IS:3854	Switches for domestic and similar purposes
IS:5216	Guide for safety procedures and practices in electrical work
IS:732	Code of practice for electrical wiring installation (system voltage not exceeding 650 Volts.)
IS:3043	Code of practice for earthing
IS:3646	Code of practice of interior illumination part II & III
IS:1944	Code of practice for lighting of public through fares
IS:5571	Guide for selection of electrical equipment for hazardous areas
IS:800	Code of practice for use of structural steel in general building construction
IS:2633	Methods of Testing uniformity of coating on zinc coated articles
IS:6005	Code of practice for phosphating iron and steel
	INDIAN ELECTRICITY ACT
	INDIAN ELECTRICITY RULES
<b>LT SWITCHGEAR</b>	
IS:8623 (Part-I)	Specification for low voltage switchgear and control gear assemblies
IS:13947 (Part-I)	Specification for low voltage switchgear and control gear, Part 1 General Rules
IS:13947 (part-2)	Specification for low voltage switchgear and control gear, Part 2 circuit breakers
IS:13947 (part-3)	Specification for low voltage switchgear and control gear. Part 3 Switches, Disconnectors, Switch-disconnectors and fuse combination units
IS:13947 (part-4)	Specification for low voltage switchgear and control gear. Part 4 Contactors and motors starters
IS:13947 (part-5)	Specification for low voltage switchgear and control gear. Part 5 Control-circuit devices and switching elements
IS:13947 (part-6)	Specification for low voltage switchgear and control gear. Part 6 Multiple function switching devices
IS:13947 (part-7)	Specification for low voltage switchgear and control gear. Part 7 Ancillary equipments
IS:12063	Degree of protection provided by enclosures

**SECTION-GENERAL TECHNICAL REQUIREMENTS (GTR)****ANNEXURE-C**

<b>CODES</b>	<b>TITLE</b>
IS:2705	Current Transformers
IS:3156	Voltage Transformers
IS:3231	Electrical relays for power system protection
IS:1248	Electrical indicating instruments
IS:722	AC Electricity meters
IS:5578	Guide for Marking of insulated conductors of apparatus terminals
IS:13703 (part 1)	Low voltage fuses for voltage not exceeding 1000V AC or 1500V DC Part 1 General Requirements
IS:13703 (part 2)	Low voltage fuses for voltage not exceeding 1000V AC or 1500V DC Part 2 Fuses for use of authorized persons
IS:6005	Code of practice of phosphating iron and steel
IS:5082	Wrought Aluminum and Aluminum alloys for electrical purposes
IS:2633	Hot dip galvanising

Note: If any standard is expired or does not exist anymore than other standard which has substituted it, shall be applicable.

**SECTION-GENERAL TECHNICAL REQUIREMENTS (GTR)**

ANNEXURE-D

**LIST OF DRAWINGS/DOCUMENTS FOR SECOND ADVANCE**

**A. ELECTRICAL DRAWINGS/DOCUMENTS FOR SWITCHYARD**

- (1) Single Line Diagram
- (2) Electrical Layout – Plan and Sections
- (3) DSLP Calculation and drawing
- (4) Structure Layout (Plan & Section) drawing
- (5) Foundation & Cable Trench Layout
- (6) Earthmat Layout
- (7) Short circuit Force and Critical Span Calculations (for non-standard span)
- (8) Cantilever Strength calculations (for non-standard span)

**B. CIVIL DRAWINGS/DOCUMENTS**

- (1) Soil Investigation Report (if applicable)
- (2) Structure Design, Foundation Design & Drawing, Plinth Beam Design & Drawing and column Design & Drawing up to G.F. Level of control room building
- (3) Structure Design, Foundation Design & Drawing, Plinth Beam Design & Drawing and column Design & Drawing of GIS building(s)

**C. DRAWINGS/DOCUMENTS OF EQUIPMENT**

- (1) Circuit Breaker, Isolator, CT, CVT, IVT, Surge Arrestor, Bus Post Insulator
  - Drawing, GTP and Type test Reports
- (2) Control and Relay Panels
  - GTP and Type test Reports
- (3) Substation Automation System (SAS)
  - GTP and Type test Reports

**D. DRAWINGS/DOCUMENTS OF POWER TRANSFORMER**

- (1) Design Review documents
- (2) GA drawings for transformer, bushings
- (3) Foundation Plan
- (4) GTP
- (5) RTCC -GA and schematic drawings
- (6) Rating and Diagram Plate
- (7) Power Transformer foundation design & drawings (if Applicable)
- (8) For Single Phase Autotransformer (if Applicable)
  - Single Line Diagram
  - Electrical Layout & Section
  - Foundation Layout including Neutral & Delta Formation

**SECTION-GENERAL TECHNICAL REQUIREMENTS (GTR)**

ANNEXURE-D

**LIST OF DRAWINGS/DOCUMENTS FOR SECOND ADVANCE**

**E. DRAWINGS/DOCUMENTS OF REACTOR**

- (1) Design Review documents
- (2) GA drawings for reactor, NGR, LA, bushings
- (3) Foundation Plan
- (4) GTP
- (5) Rating and Diagram Plate
- (6) Shunt Reactor, NGR & SA foundation design & drawings (if Applicable)
- (7) For Single Phase Reactor (if Applicable)
  - Single Line Diagram
  - Electrical Layout & Section
  - Foundation Layout including Neutral Formation

**F. DRAWINGS/DOCUMENTS OF GIS**

- (1) GTP
- (2) Gas Line Diagram
- (3) GIS Layout Drawing

**G. DRAWINGS/DOCUMENTS OF EHV Cable (132kV of Above)**

- (1) GTP
- (2) Cross Section Drawing

**NOTES:-**

1. The list of drawings/ documents mentioned above is a standard list. Some of the items may not be applicable and need not to be referred for a particular substation package.
2. In case type tests are to be repeated/conducted, then approval of type test reports is not required at this stage.
3. Category-II approved drawings shall also be considered for release of second/engineering advance.

**SECTION-GENERAL TECHNICAL REQUIREMENTS (GTR)****ANNEXURE-E**

<b>Comprehensive List of Drawing Submission Schedule</b>		
<b>SL.NO.</b>	<b>DRAWINGS/DOCUMENTS TITLE</b>	<b>CATEGORY</b>
<b>1.00</b>	<b>DRAWING FOR SWITCHYARD</b>	
1.01	Over all General Arrangement Drawing	A
1.02	Single Line Diagram	A
1.03	Electrical layout plan & section	A
1.04	Structure loading diagram cum layout arrangement	A
1.05	DSLPP Calculation & layout	A
1.06	Switchyard Foundation & cable Trench Layout	A
1.07	Indoor Cable Trench Layout ( As applicable for Control Room Building, GIS Hall ,Switchyard panel Room, FFPH Building)	A
1.08	Buried Cable Trench layout	A
1.09	Erection Key Diagram (plan & section) & Erection Bill of Quantity	A
1.10	Earthmat layout	A
1.11	Indoor Illumination layout ( As applicable for Control Room Building, FFPH Building, Transit Camp, Switchyard panel Room, GIS Hall )	A
1.12	Out door illumination Layout	A
1.13	SLD of LT AC/DC System	A
1.14	Panel arrangement layout in Control Room Building	A
1.15	Panel arrangement layout in Switchyard panel room/LCR Room of GIS Hall	A
1.16	Fire detection and alarm system for control Room building, GIS Building and Switchyard panel room	A
1.17	Air Conditioning Layout ( As applicable for Control Room Building, LCR room in GIS Hall ,Switchyard panel Room)	
1.18	LT Station Layout	A
1.19	Power and control cable schedule	A
<b>2.00</b>	<b>DESIGN CALCULATION</b>	
2.01	DSLPP calculation	R
2.02	Lighting system design calculation (if applicable)	R
2.03	Earthing system design calculation (if applicable)	R
2.04	Battery sizing calculation (if applicable)	R
2.05	Hydrolic Calculation for Fire protection (if applicable)	R
2.06	AC and ventilation calculation for GIS Building ( if applicable)	R
2.07	EOT crane sizing calculation	R
<b>3.00</b>	<b>GAS INSULATED SWITCHGEAR</b>	
3.01	Design Review along with all supporting documents for new design of GIS	A

**SECTION-GENERAL TECHNICAL REQUIREMENTS (GTR)****ANNEXURE-E**

<b>Comprehensive List of Drawing Submission Schedule</b>		
3.02	Guaranteed Technical Particular (GTP)	A
3.03	Type Test Reports of GIS	A
3.04	Drawings, GTP & Type Test Reports of SF6/Air Bushing	A
3.05	Component Drawing of Each type of GIS Equipment	R
3.06	Single Line Diagram	A
3.07	Layout for GIS Arrangement (Plan and Section View and plate form arrangement)	A
3.08	Foundation for GIS (Including Loading Data)	A
3.09	Earthing Layout including Special Earthing Requirement for GIS	R
3.10	Gas System Diagram	A
3.11	GIS support Structure layout including Details of Support Structure.	A
3.12	GIS Key Diagram	R
3.13	PD Location Layout along with sensitivity attenuation calculation	R
3.14	GA & Schematic drawings of Local Control Cabinets (LCC)	A
3.15	Type Test Reports of Local Control Cabinets (LCC)	A
3.16	Spare Parts List (Based on Contract)	A
3.17	Special Tools List (Based on Contract)	A
3.18	Name Plates	A
3.19	GA, Data Sheet and Catalogues for	
a)	SF6 gas leakage detector	R
b)	SF6 gas filling & evacuation plant	R
c)	SF6 gas Analyser	R
d)	Partial discharge monitoring system	R
e)	catalogue of UHF sensors	R
3.20	GA & Schematic drawings of overhead crane	A
<b>4.00</b>	<b>AUTOTRANSFORMER</b>	
4.01	Design Review	R
4.02	Guaranteed Technical Particulars	A
4.03	Outline General Arrangement Drawing with Bill of material (OGA parts list) & Shipping details	A
4.04	Foundation Plan	A
4.05	GA & schematic drawing of Cooler control cabinet/Marshalling Box and Write up	A
4.06	GA & schematic drawing of Common Marshalling Box and Write up (as applicable)	A
4.07	GA & schematic drawing of Drive Mechanism Box and Write up	A
4.08	Bushing dwg and GTP (HV, IV, LV and Neutral as applicable)	A
4.09	Radiator Details	A
4.10	Magnetising Characteristics of bushings CT	A
4.11	Rating and Diagram plate	A

**SECTION-GENERAL TECHNICAL REQUIREMENTS (GTR)****ANNEXURE-E**

<b>Comprehensive List of Drawing Submission Schedule</b>		
4.12	Valve Schedule plate rating	A
4.13	Twin-Bi directional roller	A
4.14	Type Test Report	A
4.15	Instruction Manual	R
<b>5.00</b>	<b>REACTOR</b>	
5.01	Design Review	R
5.02	Guaranteed Technical Particulars	A
5.03	Outline General Arrangement Drawing with Bill of material (OGA parts list) & Shipping details	A
5.04	Foundation Plan	A
5.05	Bushing dwg and GTP (HV and Neutral)	A
5.06	GA & schematic drawing of Marshalling Box and Write up	A
5.07	Magnetization characteristics of Reactor Core and bushing CTs	A
5.08	Rating and diagram plate	A
5.09	Twin bi-directional roller	A
5.10	Radiator Details	A
5.11	Type test Report	A
5.12	Instruction Manual	R
<b>6.0</b>	<b>NEUTRAL GROUNDING REACTOR (NGR)</b>	
<b>A</b>	<b>Air Core NGR</b>	
6.01	Design Review	R
6.02	Guaranteed Technical Particulars	A
6.03	General Arrangement Drawing with pedestal details and Bill of material (OGA parts list) & Shipping details	A
6.04	Foundation Plan	A
6.05	Rating and diagram plate	A
<b>B</b>	<b>Oil Filled Type NGR</b>	
6.06	Design Review	R
6.07	Guaranteed Technical Particulars	A
6.08	General Arrangement Drawing with Bill of material (OGA parts list) & Shipping details	A
6.09	Foundation Plan including Combined Foundation for NGR & LA	A
6.10	Rating and diagram plate	A
<b>7.00</b>	<b>CIRCUIT BREAKER</b>	
7.01	GA drg of SF6 CB	A
17.02	OGA drawing of control unit	A
7.03	OGA drawing of support insulator, interrupter insulator	R
7.04	Support structure & foundation plan drawing	A

**SECTION-GENERAL TECHNICAL REQUIREMENTS (GTR)****ANNEXURE-E**

<b>Comprehensive List of Drawing Submission Schedule</b>		
7.05	Electrical schematic diagram	A
7.06	Rating and name plate drawing	A
7.07	Hydraulic/SF6 gas connection diagram	R
7.08	Schematic diagram of operating mechanism	R
7.09	Wiring diagram	R
7.10	Terminal connector and corona rings	R
7.11	Sectional view of interrupter	R
7.12	GTP	A
7.13	Type Test Reports	A
7.14	Instruction Manual	R
<b>8.00</b>	<b>ISOLATOR</b>	
8.01	GA drawing of Isolator without earth switch	A
8.02	Contact blade assembly (main & earth switch)	R
8.03	Terminal pad & hinge contacts	R
8.04	GA of MOM - main switch	R
8.05	Schematic & wiring drg. for main switch	R
8.06	Name plate - details	A
8.07	GA of terminal connectors	A
8.08	GA of post insulator for isolator	R
8.09	GTP	A
8.10	Type Test Report	A
8.11	Instruction Manual	R
<b>9.00</b>	<b>INSTRUMENT TRANSFORMER (CT/CVT/IVT)</b>	
9.01	GTP	A
9.02	General Arrangement	A
9.03	Sectional view	R
9.04	Sec. terminal box GA	R
9.05	GA of Junction box	R
9.06	Data sheet of junction box	A
9.07	Wiring drg of JB incl. interpole	R
9.08	Terminal connectors	A
9.09	Schematic & rating plate	R
9.10	Porcelain insulator	R
9.11	Corona ring	R
9.12	Type Test Reports	A
9.13	Instruction Manual	R
<b>10.00</b>	<b>SURGE ARRESTER</b>	

**SECTION-GENERAL TECHNICAL REQUIREMENTS (GTR)****ANNEXURE-E**

<b>Comprehensive List of Drawing Submission Schedule</b>		
10.01	GA of Surge Arrester	A
10.02	GTP	A
10.03	Porcelain insulator	R
10.04	Cross sectional view	R
10.05	Arrestor and unit name plate	A
10.06	Grading rings	R
10.07	Insulating base / surge counter detail	R
10.08	Outline drg of surge counter	R
10.09	Circuit diagram of surge counter	R
10.10	GA of ZnO element	R
10.11	Line terminal bracket with corona rings	R
10.12	Drawing showing pressure relief arrangement.	R
10.13	Type Test Report	A
10.14	Instruction Manual	R
<b>11.00</b>	<b>BUS POST INSULATOR</b>	
11.01	GA drawing & GTP	A
11.02	Type Test Reports	A
<b>12.00</b>	<b>Marshaling Box, Junction Boxes</b>	
12.01	GA Drawings	A
12.02	Schematic Drawing	A
12.03	Type Test reports	A
<b>13.00</b>	<b>Conductor, Al Tube &amp; GS Earth Switch</b>	
13.01	Type Test Reports (if applicable)	A
<b>14.00</b>	<b>DISC INSULATOR (if applicable)</b>	
14.01	GA drawing	A
14.02	Type Test Reports	A
<b>15.00</b>	<b>LONG ROD POLYMER INSULATOR</b>	
15.01	GA drawing	A
15.02	Type Test Reports	A
<b>16.00</b>	<b>INSULATOR STRINGS WITH HARDWARE ASSEMBLY</b>	
16.01	GA DRG	A
16.02	Component drawings	R
16.03	Type Test Reports	A

**SECTION-GENERAL TECHNICAL REQUIREMENTS (GTR)****ANNEXURE-E**

<b>Comprehensive List of Drawing Submission Schedule</b>		
<b>17.00</b>	<b>CLAMPS &amp; CONNECTORS</b>	
17.01	Drawings	A
17.02	Type Test Reports	A
<b>18.00</b>	<b>HORN GAP FUSE</b>	
18.01	GA OF HG FUSE	A
18.02	Type Test Reports	A
<b>19.00</b>	<b>BATTERY AND BATTERY CHARGER</b>	
19.01	GTP	A
19.02	Drawings	A
19.03	Type Test Reports	A
<b>20.00</b>	<b>ILLUMINATION</b>	
20.01	GTP of all types of fittings/fixtures & control gear	A
20.02	GA drg. of lighting poles/posts	A
20.03	Wiring drgs. of panel/LDBs to fixtures	R
20.04	GA of Junction box	A
20.05	GA street lighting panel/outdoor lighting panel	A
20.06	GA of Receptacles	A
<b>21.00</b>	<b>LT SWITCHGEAR</b>	
21.01	GA drg of ACDB	A
21.02	SLD of ACDB	A
21.03	GA drg of 220V DCDB	A
21.04	SLD of 220V DCDB	A
21.05	GA drg of 50V DCDB	A
21.06	SLD of 50V DCDB	A
21.07	Data sheet	A
21.08	Sch. of each type of module	R
21.09	Type Test Reports	A
21.10	Instruction Manual	R
<b>22.00</b>	<b>HT Power Cable</b>	
22.01	GTP & Catalogue	A
22.02	Type Test Reports	A
<b>23.00</b>	<b>POWER &amp; CONTROL CABLE</b>	
23.01	Type Test Reports for Power Cable	A
23.02	<b>Type Test Reports for Control Cable</b>	<b>A</b>

**SECTION-GENERAL TECHNICAL REQUIREMENTS (GTR)****ANNEXURE-E**

<b>Comprehensive List of Drawing Submission Schedule</b>		
<b>24.00</b>	<b>CONTROL AND RELAY PANELS &amp; SUBSTATION AUTOMATION SYSTEM (SAS)</b>	
24.01	GTP & detailed technical literature & O&M manuals of all types of relays, SAS Equipments	A/R
24.02	Type Test Reports of all relays & equipments	R
	GA and schematic drgs. for :-	
a)	Relay and protection panels for all type line(s)	A
b)	Relay and protection panels for all type autotransformer(s) including tertiary loading	A
c)	Relay and protection panels for bus/line reactor(s)	A
d)	Relay and protection panels for tie bay(s)	
e)	Relay and protection panels for TBC bay(s)	A
f)	Relay and protection panels for BC bay(s)	A
g)	Busbar protection panel (s)	A
h)	Circuit Breaker relay panel(s)	
24.03	Panel Construction Details	A
24.04	SAS Architecture	A
24.05	Relay Settings	A
<b>25.00</b>	<b>Visual Monitoring System</b>	
25.01	GTP/Catalogue of VMS Equipment and Camera	A
25.02	VMS Architectural Drawing	A
<b>26.00</b>	<b>PLCC EQUIPMENTS</b>	
26.01	GTP & technical literature	A/R
26.02	Type Test Reports of all PLCC equipment	A
26.03	GA & GTPs for wave trap	A
26.04	GA drg of PLCC terminal	R
26.05	Digital/ Analog Protection coupler	R
26.06	SNR calculation (if applicable)	R
26.07	Coupling device	R
26.08	GTP of HF cable	A
26.09	Testing & maintenance equipments	R
26.10	Frequency Planning	A
<b>27.00</b>	<b>DG SET</b>	
27.01	GTP	A
27.02	Drawings/manuals	A
<b>28.00</b>	<b>AIR CONDITIONING &amp; VENTILATION SYSTEM</b>	

**SECTION-GENERAL TECHNICAL REQUIREMENTS (GTR)****ANNEXURE-E**

<b>Comprehensive List of Drawing Submission Schedule</b>		
28.01	GTP	A
28.02	Drawings	A
28.03	A/C sizing calculation	A
<b>29.00</b>	<b>LT TRANSFORMER</b>	
29.01	GTP	A
29.02	Drawings	A
29.03	Type Test Reports	A
<b>30.00</b>	<b>FIRE PROTECTION SYSTEM</b>	
30.01	Piping layout in the switchyard	A
30.02	HVW spray system drawings (plan, elevation, side view , isometric view and pylon support details)	R
30.03	Pylon support locations	R
30.04	Schematic and GA for LCP for deluge valve operation	A
30.05	Hydraulic calculations for HVW spray network	R
30.06	Drawing for deluge valve housing	A
30.07	GTP & drawings for stainers (Y type & basket strainer)	A
30.08	Drawing of valve pit details	A
30.09	System writeup with various settings	A
30.10	GTP & drgs. for gate valve, check valve, solenoid valve, outdoor hydrant valve	A
30.11	GTP & catalogue for deluge valve, spray nozzles & projectors	A
30.12	GTP & catalogue for quatrroid bulb detector	A
30.13	GTP & drg. for pressure switch, pressure gauge	A
30.14	GTP for G.I. & M.S. pipes & pipe accessories	A
<b>31.00</b>	<b>CONTROL ROOM BUILDING / TRANSIT CAMP /FFPH BUILDING/SWITCHAYRD PANEL ROOM/INDOOR HT SWITCHGEAR ROOM/TOWNSHIP BUILDINGS (AS applicable)</b>	
31.01	Architectural drawing	
a)	Plan, Section & elevation	A
b)	Doors and Window Schedule	A
31.02	Building design calculation( if applicable)	A
31.03	Civil Construction Drawings	A
<b>32.00</b>	<b>DRAWING FOR GIS BUILDING ( if Applicable)</b>	A
31.01	Architectural drawing	A
a)	Plan, section & elevation	A
b)	Doors & windows schedule	A

**SECTION-GENERAL TECHNICAL REQUIREMENTS (GTR)****ANNEXURE-E**

<b>Comprehensive List of Drawing Submission Schedule</b>		
31.02	GIS Building Superstructure drawings & design calculation	A
31.03	Civil Construction Drawings	A
31.04	GIS Equipment foundation inside GIS building	A
<b>33.0</b>	<b>SWITCHYARD CIVIL CONSTRUCTION DRAWING (AS APPLICABLE)</b>	
33.01	Tower Foundation	A
33.02	Equipment Foundation	A
33.03	Transformer Foundation	A
33.04	Reactor Foundation	A
33.05	Road Construction including culverts, rail cum roads	A
33.06	Switchyard fencing and Gate	A
33.07	Cable trench section	A
33.08	Drain Section	A
33.09	Rain water harvesting	A
33.10	Boundary wall	A
33.11	DG Set foundation	A
33.12	LT transformer foundation	A
33.13	Car parking Shed/Security Room	A
33.14	Out Door GIB foundations	A
33.15	Outdoor Sf6/Air Bushing Foundation	A
33.16	BMK/Lighting pole foundation	A
33.17	Fire wall	A
33.18	Contour layout	A
33.19	Drawing of formation level	A
33.20	Soil investigation Report	A
33.21	Any other foundation in Switchyard	A
<b>34.00</b>	<b>DESIGN, FABRICATION &amp; PROTO CORRECTED DRAWINGS OF ALL TYPES OF TOWERS &amp; BEAMS</b>	R
<b>35.00</b>	<b>DESIGN, FABRICATION DRAWINGS FOR EQUIPMENT SUPPORT STRUCTURES</b>	R
<b>36.00</b>	<b>MISCELLANEOUS CIVIL DRGS</b>	A

LEGEND:- A- for Approval; R:- for Record

Note: i) The above list of Drawing is indicative. The same shall be used for formulation of Master Drawing List (MDL) in DREAMS System.

**SECTION-GENERAL TECHNICAL REQUIREMENTS (GTR)**

**Annexure- F**

**Assessment report from Contractor for proposed sub-vendor along with following enclosures (to the extent available):**

1. Registration / License of the works
2. Organization chart with name and qualification of key persons
3. List of Plant and Machinery.
4. List of testing equipment with their calibration status.
5. List of Raw material, bought out items with sourcing details
6. List of out-sourced services with sourcing details.
7. List of supply in last three years.
8. Third party approval, if any (viz. ISO, BIS),
9. Pollution clearance wherever applicable
10. Energy Conservation & Efficiency report  
(Applicable to industries having contract load more than 100 KVA)
11. Formats for RM, in process and acceptance testing
12. Type test approvals conducted in last 5 years, if applicable
13. Performance Certificates from customers
14. Photographs of factory, plant and machinery & testing facilities

**SECTION-GENERAL TECHNICAL REQUIREMENTS (GTR)****Annexure-G****MQP & INSPECTION LEVEL REQUIREMENT**

Sl. No	Item / Equipment	Reference document for inspection	Inspection Level
A.01	LT Transformer /Power Transformer/ Reactor/ Converter Transformer/ Filter Reactor	MQP/ITP	IV
A.02	Bushing	MQP	IV
A.03	Insulating Oil	POWERGRID TS	III
A.04	Oil storage tank for transformers	MQP	III
A.05	Nitrogen injection based explosion prevention system	FAT/ITP	III
A.06	On Line oil drying system for transformers	POWERGRID TS	II**
A.07	On Line DGA and moisture monitoring system	POWERGRID TS	II**
A.08	Flow sensitive conservator isolation valve	POWERGRID TS	II**
A.09	Oil Filtration Machine	MQP	III
B.01	Circuit Breakers	MQP	IV
B.02	Current Transformers	MQP/ITP	IV
B.03	CVT/PT/IVT	MQP	IV
B.04	Isolators	MQP/ITP	IV
B.05	Surge Arrestors	MQP/ITP	III
B.06	Line Trap & Air Core Reactor	MQP/ITP	III
B.07	Point On switching device (CSD) for Circuit Breaker (wherever required)	FAT/ITP	IV
C.01	STATCOM including Valve, valve base electronics, DC capacitor, series reactor and all accessories	ITP	IV
C.02	Mechanically switched Reactor bank (3-ph) including all accessories (MSR Branches)	ITP	IV
C.03	Mechanically switched Capacitor bank (3-ph) including all accessories (MSC Branches)	ITP	IV
C.04	Harmonic Pass filters	ITP	IV
C.05	HT Capacitor	MQP	IV
D.01	Thyristor Valve	FAT/ITP	III
D.02	PLC Capacitors for HVDC	FAT/ITP	III
D.03	Valve Cooling system for	FAT/ITP	III

**SECTION-GENERAL TECHNICAL REQUIREMENTS (GTR)****Annexure-G**

Sl. No	Item / Equipment	Reference document for inspection	Inspection Level
	HVDC		
D.04	AC/DC Filter Resistors	ITP	III
D.05	DC Current and Voltage measuring device for HVDC	FAT/ITP	III
D.06	Maintenance platform for valve hall	POWERGRID TS	II
D.07	Optical signal column for FSC	FAT/ITP	II
E.01	GIS including spares	MQP/ITP	IV
E.02	Dew Point Meter for GIS	POWERGRID TS	I*
E.03	Portable Partial Discharge monitoring system for GIS	POWERGRID TS	I*
E.04	Partial Discharge Monitoring System (Online) for GIS	ITP	III
E.05	PEB Structure and Puf Panels	MQP	III
F.01	Substation Automation system	FAT/MQP	III
F.02	Event Logger	POWERGRID TS	III
F.03	PLCC equipment Viz PLCC Terminal ,Carrier equipment, Protection Coupler , Coupling Device but excluding EPAX / HF Cable	MQP	III
F.04	Control & Relay Panels	MQP	III
G.01	EHV Cables	MQP/ITP	III
G.02	Power Cables & Control Cables	MQP	III
G.03	Cable Joints (11 kV and above)	POWERGRID TS	II
G.04	Cable Lugs & Glands / Clamps/Terminations	POWERGRID TS	I
H.01	LT Switchgear & ACDB/DCDB/MLDB/ELDB	MQP	III
H.02	Battery	POWERGRID TS	II
H.03	Battery Charger	MQP	III
H.04	UPS & Voltage Stabilizer	MQP/FAT	III
H.05	D. G. Set	FAT/ITP	III
H.06	Lighting Panel	POWERGRID TS	II
H.07	Lighting Poles	POWERGRID TS	II
H.08.1	Lighting Fixtures, Lighting Earthwire, Switches / sockets, Conduits, Lamps & fans including exhaust fans	POWERGRID TS	I
H.8.2	Solar based LEDs System including street light/pole solar panel, Inverter controller/LED fixture	FAT	III
H.09	MS/GI /PVC Pipes for cable	POWERGRID TS	I

**SECTION-GENERAL TECHNICAL REQUIREMENTS (GTR)****Annexure-G**

<b>Sl. No</b>	<b>Item / Equipment</b>	<b>Reference document for inspection</b>	<b>Inspection Level</b>
	trenches and lighting		
H.10	Outdoor Receptacle	POWERGRID TS	I
H.11	Split A.C/window A.C./ precision AC/ Kiosk AC/ Cascade AC/ Tower AC	POWERGRID TS	I
H.12	Occupancy sensors for control of lighting	POWERGRID TS	I
H.13	Solar based street lighting pole including Solar Panel, Inverter, Controller, etc.	POWERGRID TS	III
H.14	Junction Box / Lighting Switch Boards / Bay MB / Portable Flood Light Panel	POWERGRID TS	II
H.15	Lighting transformer	POWERGRID TS	II
I.01	SF6 gas processing unit, SF6 gas Leakage detector, SF6 gas Analyzer	POWERGRID TS	I*
I.02	SF6 Gas	POWERGRID TS	I
I.03	Spark Gap	FAT/ITP	III
I.04	Time synchronizing Equipment (GPS Clock)	POWERGRID TS	I
I.05	Galvanized Cable trays	POWERGRID TS	II
I.06	Video Monitoring System	FAT/ITP	I
I.07	Public Address System (All Components)	POWERGRID TS	I
I.08	Building Management System (All components)	POWERGRID TS	I
I.09	Access Control System (All Components)	POWERGRID TS	I
I.10	Video Display system/ Video Projection system	POWERGRID TS	I
I.11	VESDA (smoke detector)	POWERGRID TS	I
I.12	High Mast Pole	MQP	III
J.01	Aluminium ladder	POWERGRID TS	I
J.02	Hume Pipes	POWERGRID TS	I
J.03	Castle Key	POWERGRID TS	I
J.04	Water Treatment plant (All components).	POWERGRID TS	I
J.05	Furniture	POWERGRID TS	I
J.06	DOL Starter	POWERGRID TS	I
J.07	Oil Sample Bottles and Syringe	POWERGRID TS	I
J.08	Test & Measuring Equipment, T&P	POWERGRID TS	I*
K.01	EOT Crane	POWERGRID TS	II

**SECTION-GENERAL TECHNICAL REQUIREMENTS (GTR)****Annexure-G**

Sl. No	Item / Equipment	Reference document for inspection	Inspection Level
K.02	Boom Crane/Golf Cart/Platform Truck/Man Lift/ Fork Lift/ Lifts	POWERGRID TS	II
L.00	Fire Protection System		
L.001	Panels, Hydro pneumatic tank for fire protection system.	POWERGRID TS	III
L.002	Deluge valve, Strainers, MS/GI pipes, Pumps, motors, air compressor, and other valves, Diesel Engines	POWERGRID TS	II
L.003	Others	POWERGRID TS	I
M.00	HVAC SYSTEM		
M.001	Air Cooled Chiller	POWERGRID TS	III
M.002	Pump	POWERGRID TS	II
M.003	Air Handling Unit	POWERGRID TS	II
M.004	Fan Filter Unit With Centrifugal Blower	POWERGRID TS	II
M.005	Axial Flow Fan	POWERGRID TS	II
M.006	Main Climate Control Unit (Dehumidifier)	POWERGRID TS	I
M.007	Dampers	POWERGRID TS	II
M.008	Fire Dampers	POWERGRID TS	II
M.009	Pressure Gauge, Thermometers, Other Instruments / Sensors	POWERGRID TS	I
M.010	Grill, Diffuser, Jet Nozzle, Louvers etc	POWERGRID TS	I
M.011	Ducting	POWERGRID TS	III
M.012	M S Pipe	POWERGRID TS	II
M.013	Pipe Insulation Material	POWERGRID TS	I
M.014	Duct Insulation Material	POWERGRID TS	I
M.015	Underdeck Insulation Material	POWERGRID TS	I
M.016	Gate Valve & Non Return valve	POWERGRID TS	I
M.017	Y Strainer	POWERGRID TS	II
M.018	Ball Valve/ Motorised Butterfly Valve/ Balancing Valve	POWERGRID TS	I
M.019	Closed Expansion Tank	POWERGRID TS	II
M.020	Air Separator	POWERGRID TS	I
M.021	MCC /PLC /Electrical Panels	POWERGRID TS	III
M.022	Propeller Fan/ Conduit	POWERGRID TS	II
M.023	Air Filter/ Mixing Valve with Thermostat	POWERGRID TS	I

**SECTION-GENERAL TECHNICAL REQUIREMENTS (GTR)****Annexure-G**

<b>Sl. No</b>	<b>Item / Equipment</b>	<b>Reference document for inspection</b>	<b>Inspection Level</b>
N.01	SDH Equipment	FAT/ITP	IV
N.02	Termination Equipment Primary/ DI Multiplexer	FAT/ITP	IV
N.03	DACS	FAT/ITP	IV
N.04	Optical Amplifier	FAT/ITP	IV
N.05	FODP including pigtail, Joint Box, FDMS	FAT/ITP	II
N.06	IMPS	FAT/ITP	IV
N.07	Optical bypass switch	FAT/ITP	IV
N.08	Air Purifier	FAT/ITP	I
N.09	Patch cord & connector	FAT/ITP	I
N.10	NMS	FAT/ITP	IV
N.11	OPGW Cable	MQP/ITP/FAT	III
N.12	Hardware Fittings for OPGW cable	MQP/ITP	III
N.13	DCPS	FAT/ITP	III
N.14	Radio Links	FAT/ITP	III
N.15	SMPS based DC Power Supply (DCPS) system	FAT/ITP	III
N.16	WAMS (PMU & Accessories)	FAT/ITP	III
N.17	PUF Shelter	FAT/ITP	III
N.18	Aerial OFC/UGOFC/ADSS/FO Cable	FAT/ITP	III
N.19	DWDM	FAT/ITP	III
N.20	OTN	FAT/ITP	III
N.21	MPLS-TP Equipment	FAT/ITP	III
N.22	L2 Switch	FAT/ITP	III
N.23	IP-MPLS Router	FAT/ITP	III
N.24	HDPE Pipes	POWERGRID TS	II
N.25	Equipment Cabinets	POWERGRID TS	II
N.26	Main Distribution Frame	POWERGRID TS	I
N.27	Telephone system, EPAX, Telephone wires, Telephone sockets	POWERGRID TS	I
N.28	Fibre Optic Cable	MQP	III
N.29	Hardware Fittings for Fibre Optic cable	MQP	III
O.01	Re-rollers of MS/HT Angle Section and galvanized tower parts.	MQP	IV
O.02	Conductor	MQP	IV
O.03	Hardware fittings and Conductor & Earthwire Accessories	MQP	IV
O.04	Earth wire	MQP	IV

**SECTION-GENERAL TECHNICAL REQUIREMENTS (GTR)****Annexure-G**

Sl. No	Item / Equipment	Reference document for inspection	Inspection Level
O.05	Insulator	MQP	IV
O.06	Bolts & Nuts of Gr 8.8 / 8	MQP	IV
O.07	Mono Pole	MQP	IV
O.08	Foundation Bolts & Anchor Bolts	POWERGRID TS	III
O.09	D-shackle/ Hanger / Links and associated Special bolt/nuts	MQP	III
O.10	Span Marker, Obstruction lights and Wind Measuring Equipment	POWERGRID TS	III
O.11	MS ROD rolled by Approved Re-roller of POWERGRID	MQP	III
O.12	MS ROD rolled by Approved steel producers of POWERGRID	POWERGRID TS	I
O.13	Spring Washers & Pack washers	POWERGRID TS	II
O.14	Bolts & Nuts Gr up to 5.6/5	POWERGRID TS	II
O.15	ACD & Barbed wire for ACD/Bird guard	POWERGRID TS	II
O.16	Danger Plate /Phase Plate / Number Plate / Circuit plate	POWERGRID TS	I
O.17	Sub Station Structure (lattice/pipe type)	MQP	III
O.18	Clamps & Connecters (including equipment connectors)	MQP	III
O.19	MS/ GI Flat, rod type, pipe type and other earthing material.	POWERGRID TS	II
O.20	Aluminium Tube & Busbar materials	POWERGRID TS	II
O.21	Pipe Type & Counter Poise Earthing	POWERGRID TS	II
O.22	DTS System	POWERGRID TS	II

For Equipment where requirement of MQP is envisaged, ITP/FAT will be followed If sourced from off shore. For items required in S/S or T/L or TELECOM/LD&C , same inspection level as specified shall be followed for all the cases.

\* MICC for test and measuring equipment (inspection level I or II) shall be issued only after actual verification/ demonstration of satisfactory performance at site.

\*\* Though level-2 items, CIP/MICC can be issued also on review of TCs and visual inspection of these item.

**SECTION-GENERAL TECHNICAL REQUIREMENTS (GTR)****ANNEXURE-H****RTV Silicone high voltage insulation coating (HVIC)****1. SCOPE**

The scope of work shall include supply, transportation and application of RTV-1 silicone rubber high voltage insulator coating and cleaning/removal of waste from the equipment.

- a) All the required materials, tools & tackles, testing equipments including man lift etc. are in the scope of successful bidders/contractor.
- b) Surface preparation:  
All equipment surfaces to be coated should be made free from dust, grease, oil etc. & other foreign matter. Also the surface meant for application must be dry.
- c) The RTV coating supplied for application should be properly mixed before application as per the recommendations of manufacturer. The coating should cover complete surface and should be applied in manner that prevents runs, sags, drips, spills etc. The application shall be done by certified applicator of Manufacturer.
- d) Successful bidder/contractor shall submit the detailed field quality plan for approval. It is not the intention of this specification to specify completely herein all details and design requirements. However, the materials offered & work execution shall confirm in all respects to high standards of engineering and workmanship and be capable of performing in continuous commercial operation up to guarantee in a manner acceptable to purchaser.

**2. CLIMATIC CONDITIONS:**

The overall climate is moderate hot, humid, tropical, highly polluted and conducive to rust and fungus growth. The climatic conditions are prone to wide range of outdoor service conditions.

**3. APPLICABLE CODES AND STANDARDS**

The latest revision/amendments of the following Codes and Standards shall be applicable for the equipment/material covered in this Technical Specification. In case of conflict, the vendor/manufacturer may propose equipment/material conforming to one group of Industry Codes and Standards quoted hereunder without jeopardizing the requirements of this Technical Specification.

IEC 60243-1	Electric strength of insulating materials - Test methods - Part 1: Tests at power frequencies
IEC TR 62039	Selection guide for polymeric materials for outdoor use under HV stress
IEC 60250	Recommended methods for the determination of the permittivity and dielectric dissipation factor of electrical materials at power, audio and radio frequencies including meter wavelengths
IEC 60587	Electrical insulating materials used under severe ambient conditions - Test methods for evaluating resistance to tracking and erosion
IEC TS 62073	Guidance on the measurement of hydrophobicity of insulator surfaces
IEC 61621	Dry, solid insulating materials-Resistance test to high - voltage, low - current arc discharges
IEC 62217	Polymeric HV insulators for indoor and outdoor use-General definitions, test methods and acceptance criteria

**SECTION-GENERAL TECHNICAL REQUIREMENTS (GTR)****ANNEXURE-H****RTV Silicone high voltage insulation coating (HVIC)**

IEC 62631-3-2	Dielectric and resistive properties of solid insulating materials - Part 3-2: Determination of resistive properties (DC methods) - Surface resistance and surface resistivity
IEEE Std 957	IEEE Guide for Cleaning Insulators
IEEE Std 1523	IEEE Guide for the Application, Maintenance and Evaluation of Room Temperature Vulcanizing (RTV) Silicone Rubber Coatings for Outdoor Insulation Applications.
ASTM D149-09	Standard Test Method for Dielectric Breakdown Voltage and Dielectric Strength of Solid Electrical Insulating Materials at Commercial Power Frequencies
ASTM D150-11	Standard Test Methods for AC Loss Characteristics and Permittivity (Dielectric Constant) of Solid Electrical Insulation
ASTM D257-14	Standard Test Methods for DC Resistance or Conductance of Insulating Materials
ASTM D495-14	Standard Test Method for High - Voltage, Low - Current, Dry Arc Resistance of Solid Electrical Insulation
CEA LWIWG-02 (1996)	Line Post Composite Insulator for Overhead Distribution Lines

**4. Technical Parameters**

4.1 RTV Silicon compound in its liquid form shall have the following properties:

<b>Material Properties</b>	<b>Requirement</b>
Material Type	One part RTV
Appearance	Paint
Filler type	ATH, Quartz or both
Color	Gray
Percent of solids by weight	≥ 70%
Substrate Application Temperature Range °C	-4°C to 121°C
Tack free at 25°C and 50% RH	30 minutes

4.2 RTV Silicon coating after cured form shall have the following properties:

<b>Parameters</b>	<b>Requirement</b>
Application Area	Glass, Porcelain, station insulators, as well as bushing, instrument transformers and related devices
Full cure time	≥ 24 hours
Coating thickness	500 microns + 10% tolerance, dry film thickness
Dielectric Strength	≥ 20 kV/mm
Volume Resistivity	≥ 1.0*10 <sup>12</sup> ohm.m
Tracking and Erosion test	1000 Hours
Min. Salinity Level withstood during "Artificial Pollution Test using Salt Fog Method"	≥160 kg/m <sup>3</sup>
Hydrophobic Recovery Test	HC2 or HC1
Method of Application	Airless Spray
Dry Arc resistance	Tract ≥ 140 seconds Burn Out ≥ 420 seconds

**SECTION-GENERAL TECHNICAL REQUIREMENTS (GTR)****ANNEXURE-H****RTV Silicone high voltage insulation coating (HVIC)**

<b>Parameters</b>	<b>Requirement</b>
Tracking and Erosion (IEC 60587, Method 1: Application of constant tracking voltage)	Class 1A 4.5kV or better
Primer Required	No primer material shall be allowed
Resistant to	Marine salt fog, Water, Industrial (cement dust, fly ash, acid emission etc.), Rough Weather Conditions
Other Properties	Non Hazardous to environment, surface after full cure shall be smooth

**4.3 Materials**

- 4.3.1 The RTV Silicone high voltage insulation coating shall be ultraviolet (UV) radiation exposure resistant. The finished product shall withstand the adverse atmospheric conditions due to weather, proximity to the coast, fumes, ozone, acids (particularly nitric acid in the coastal areas and sulphuric acid in the oil field areas), bases/alkalis, and hydrocarbon components, dust or rapid changes to air temperature (temperature extremes). There shall not be significant material degradation such as development of surface cracks and unacceptable increase in surface hardness etc.
- 4.3.2 The RTV Silicone high voltage insulation coating shall be resistant to atmospheric and chemical degradation. Salt air, airborne pollutants, industrial pollutants such as cement dust, sulphur, rain and humidity shall not result in flashover on the coating.
- 4.3.3 The RTV Silicone high voltage insulation coating shall be resistant to arcing and corona. The Coating shall exhibit high tracking resistance to reduce damage during salt-storms (storms arising from the sea) or other severe contamination events. The track resistance of the RTV Silicone Rubber Insulator Coating material shall meet the requirements of IEC 60587, Method 1, Class 1A 4.5kV.
- 4.3.5 The RTV Silicone high voltage insulation coating shall be a single component, ready-to-use after simple mixing. It shall not require excessive mixing/shaking and thinning/dilution before use. The Coating shall be moisture curable at room temperature.
- 4.3.6 The RTV Silicone high voltage insulation coating shall exhibit long-term water repellency and hydrophobicity.
- 4.3.7 The RTV Silicone high voltage insulation coating shall not require use of any primer on the ceramic insulators for adhesion purposes.
- 4.3.8 The RTV Silicone high voltage insulation coating shall be easy to be reapplied. The Coating shall have excellent arc resistance, excellent unprimed adhesion, easy to apply and spray-able as well as paint-able.
- 4.3.9 The RTV Silicone high voltage insulation coating shall have a minimum 12 months shelf life, which shall effect from the date of manufacturing. The manufacturer shall submit the warranty to this effect. The expiry date shall be marked on the containers. The remaining shelf life of the material shall be at least six (6) months when delivered to site. The coating shall be supplied in cans weighing not more than 25kg.

**4.4 Composition and Properties**

- 4.4.1 The RTV Silicone high voltage insulation coating shall be capable of withstanding high-pressure water power washing. To prove this property, a power wash test shall be performed per requirements stated hereafter in this standard.

**SECTION-GENERAL TECHNICAL REQUIREMENTS (GTR)**

**ANNEXURE-H**

**RTV Silicone high voltage insulation coating (HVIC)**

- 4.4.2 The RTV Silicone high voltage insulation coating shall protect the ceramic insulators (porcelain and glass) against flashovers caused by pollution.
- 4.4.3 The manufacturer shall advise/recommend suitable method of application and submit written application instructions and shall suggest suitable equipment set-up (size of pump and compressors, etc.) and the compatibility of his product to be reapplied on the RTV coating from other manufacturers.
- 4.4.4 The warranty for RTV coating on the equipments shall be for a period of 5 years

**4.5 Markings**

The packing and expiry dates of coating shall be labeled on the coating cans. The expiry date shall be considered from the packaging date and not from the date of shipment of the coating.

The cans shall be marked for “flammable” or “non-flammable” depending upon the type of solvent used for the dispersion of the coating.

**5.0 TESTS**

All test results shall be provided for review and acceptance by customer.

**5.1 Type Tests**

5.1.1 Type tests as prescribed in relevant standards shall be performed on RTV coated sample tiles or RTV coated insulators as applicable to verify the suitability of the design, materials and method of manufacture. Testing shall include, but not limited to following. These tests shall be performed only on the new design of RTV silicone high voltage insulation coating. The test reports shall be submitted from tests done in a NABL/International accredited lab.

a) Tracking and erosion resistance test (IEC 60587, Method 1, Class 1A 4.5kV). Samples shall consist of smooth porcelain plates of 6mm ( $\pm$  0.5mm) thickness coated with the thickness of the material as proposed by the manufacturer for the offered coating. Breaking of porcelain substrate shall not be allowed.

b) Salt-fog tests

The 1000 hour Tracking and erosion test outlined in IEC-62217 shall be carried out.

c) Dry arc resistance test

Dry arc resistance test shall be carried out as per ASTM D495.

d) Contact Angle Measurement Test:

Receding contact angle measurement test shall be performed in accordance with IEC TS 62073.

e) BDV testing of fully cured coating.

The test shall be carried out as per IEC:60243-1 or ASTM D149.

f) Volume Resistivity Test

**SECTION-GENERAL TECHNICAL REQUIREMENTS (GTR)****ANNEXURE-H****RTV Silicone high voltage insulation coating (HVIC)**

The test shall be carried out as per IEC:60093. Sample thickness shall be 2mm which can be obtained by using an open mould casting technique. The minimum volume resistivity as specified shall be achieved.

- g) Artificial Pollution Test in general with IEC 60507 without the pre-condition test.
- h) Adhesion Test as type test:

Adhesion test shall be performed in accordance with Canadian Electric Association (CEA) specification LWIWG-02 (96) or any other equivalent standard to verify the bonding characteristics of the RTV Silicone Rubber Coating when applied to ceramic insulators. Three (3) coated insulators shall be put in water having 0.1% by weight of NaCl and boiled for 100 hours (each sample separately). At the end of boiling, allow each insulator to remain in the water until the water cools to about 50°C. The coating shall not exhibit any water blisters at the interface between the insulator surface and the coating.

**5.2 Acceptance Tests (at Site or Factory)**

- a) Thickness measurement:

Dry film thickness (DFT) of the coating shall be measured at site on all Equipments randomly at least at one point of the Equipment.

- b) Adhesion Test as acceptance test:

Adhesion test shall be performed at site in accordance with CEA specification LWIWG-02 (96) or any other equivalent standard to verify the bonding characteristics of the RTV Silicone Rubber Coating when applied to ceramic insulators. Three (3) coated insulators shall be put in water having 0.1% by weight of NaCl and boiled for 2 hours (each sample separately). At the end of boiling, allow each insulator to remain in the water until the water cools to about 50°C. The coating shall not exhibit any water blisters at the interface between the insulator surface and the coating.

- c) High Pressure Water Withstand Test:

A power water wash test shall be performed at site on 5% sample in accordance with IEEE Std 957 to demonstrate that the RTV coated insulators can be power washed without any damage to RTV coating. The test shall be a water spray of a solid stream through a 6mm diameter nozzle at 3800 kPa for a period of 10 (ten) minutes. The nozzle of the spray equipment shall be at a distance of 3m from the insulator surface. There should not be any damage to the coating.

- d) Hydrophobicity test :

Hydrophobicity test shall be carried out on virgin material at site on 5% sample on 1-2 coated equipment as per STRI guidelines and the results shall be HC2 class or better. Hydrophobicity test shall be carried out after completion of high pressure water withstand test.

Annexure-I

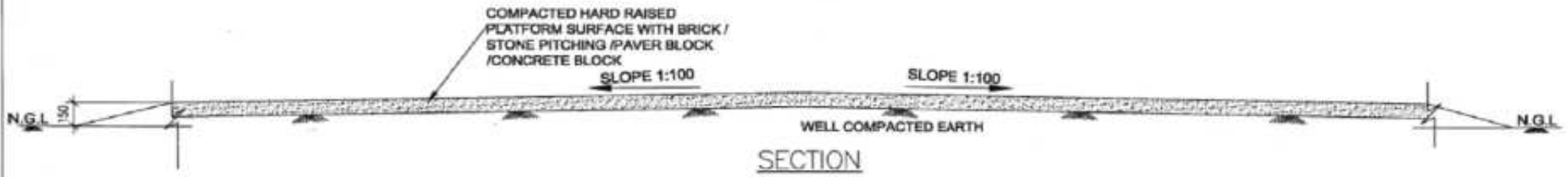

INDICATIVE DRAWING ONLY  
(SIZE SHALL BE AS PER WORK  
REQUIREMENT)

POWER GRID CORPORATION  
OF INDIA LIMITED  
(A Government of India Enterprise)



PROJECT: STANDARD DRAWING FOR OPEN PLATFORM

TITLE: INDICATIVE DRAWINGS FOR OPEN STORAGE PLATFORM

<i>HEM</i> 11/9/16	<i>[Signature]</i>	<i>[Signature]</i>	<i>[Signature]</i>	11/9/16
CHKD BY AGM/ENG CIVIL	CHKD BY CIB/ENG CIVIL	CHKD BY AGM/ENG CIVIL	CHKD BY CIB/ENG CIVIL	DATE

DRAWING NO.	C-ENGG-CVL-STD-PLATFORM-01	SCALE	REV
			0

**ANNEXURE-J****LIST OF THE MAKES FOR WHICH TYPE TEST REPORTS NOT REQUIRED TO BE SUBMITTED**

Sl. No.	ITEM DESCRIPTION	MAKE
<b>A.</b>	<b><i>Substation Accessories [Type Testing is not envisaged]</i></b>	
1.	Out door receptacles	CGL/B&C/BCH/Sakti, Chennai/Indo Asian/AVAIDS
2.	Trefoil clamp	Moulded Fibre Glass Products, Calcutta
3.	Diesel Engine	Cummins/Ruston & Hornsby/Greaves Cotton/Kirloskar/Mahindra/Ashok Leyland
4.	Alternator	AVK/KIRLOSKAR/STAMFORD/ Leroy Somer
5.	Motors	KEC/Siemens/NGEF/Crompton/ABB
6.	Cable Glands	Sunil & Co./Arup/ Comet/QPIE
7.	Junction Box	Sarvana/ECS/C&S/Vikas/ Maktel/Unilac/Jasper/ Amara raja/AVAIDS
8.	EPAX	MATRIX, BPL
9.	ACSR Conductor (Bersimis/Moose/Zebra)	Sterlite/Apar/HVPL/Sharavathy/Hiren Aluminium Ltd./Smita/Deepak Cables/Polycab wires/Cabcon/JSK
10.	AAC Conductor (BULL)	Sterlite/Cabcon /JSK
11.	G.S. Earthwire	Sharavathy/Bharat Wire Ropes/Ramswarup
12.	Lighting Fixtures	Phillips/CGL/Bajaj /Havels
13.	Lighting Transformer	Gujarat-Plug-In
14.	Lighting Panels	Vikas/Makel/Nitya/AVAIDS
15.	MCCB/ACB/Protective relays of LT Switchgear Boards	All approved makes as per Compendium of Vendors
16.	EOT Crane	Reva
<b>B.</b>	<b><i>ACCESSORIES FOR TRANSFORMER &amp; REACTOR [Earlier approved type test reports is applicable and not required to be submitted]</i></b>	
17.	BUCHHOLZ RELAY [Upto 765kV Transformer & Reactor]	(i) M/S CEDESPE, ITLAY [Model Type-EE 3 (Plug & Socket type)]/ (ii) M/s VIAT INSTRUMENTS PVT. LTD.KOLKATA [Model type-GOR-3M (Plug & Socket type)]
18.	PRESSURE RELIEF DEVICE [Upto 765kV Transformer & Reactor]	(i) M/S SUKRUT UDYOG, Pune [Model type-T-6-MS-15-SHB-PS (Plug & Socket type)] /
19.	MAGNETIC OIL LEVEL GAUGE [Upto 765kV Transformer & Reactor]	(i) M/S SUKRUT UDYOG PUNE [Model type-SO-HE-10-M-ATMS-PS (Plug & Socket type)], [Model Type:- SO-6-M-P-PS (Plug & Socket type)]/
20.	AIR CELL (FLEXIBLE AIR SEPARATOR) [Upto 765kV Transformer & Reactor]	Type test of following makes are not to be submitted (i) M/S PRONAL FRANCE / (ii) FUJIKURA,JAPAN / (iii) PRONAL ASIA, MALAYSIYA / (iv) SHENYANG HONGDA GENERAL RUBBER FACTORY /

**ANNEXURE-J****LIST OF THE MAKES FOR WHICH TYPE TEST REPORTS NOT REQUIRED TO BE SUBMITTED**

Sl. No.	ITEM DESCRIPTION	MAKE
		(v) BAODING XINKE RUBBER PRODUCT INSTITUTE, CHINA / (vi) M/S ZENITH INDUSTRIAL RUBBER PRODUCTS PVT. LTD. THANE / (vii) M/S UNIRUB TECHNO PUNE
21.	OTI & WTI [Upto 765kV Transformer & Reactor]	(i) M/S PRESIMEASURE BANGALORE [Model type-1005A]
22.	OIL PUMP [Upto 765kV Transformer & Reactor]	(i) FLOWWELL PUMPS & METERS, BANGALORE [Model type-1220D, 1250D]
23.	COOLING FAN AND MOTOR ASSEMBLY [Upto 765kV Transformer & Reactor]	(i) M/S MARATHON LTD KOLKATA [Model Type:- 36M/K75-P8, 0.7kW, 725RPM, 22J/K37-P6, 0.25kW, 940RPM, AFF 915103, 0.625kW, 550RPM]
24.	Sudden Pressure Relay [Upto 765kV Transformer & Reactor]	(i) Qualitrol [Model/Drawing No.900-003-02 CS-46518, 900-003-32 CS-46369] / (ii) Shenyang KEQI Electrical Equipment Co. Ltd. [Model/Drawing No.SYJ9-50-25 <sup>TH</sup> ]
25.	BUCHHOLZ RELAY [Upto 400kV Transformer & Reactor]	(i) M/S CEDASPE, ITALY [Model type-EE3 (Plug & Socket type)]/ (ii) VIAT INSTRUMENTS [Model type-GOR-3M (Plug & Socket type)]
26.	PRESSURE RELIEF DEVICE [Upto 400kV Transformer & Reactor]	(i) M/S SKURUT UDYOG, PUNE [Model type-T-6-MS-15-SHB-PS (Plug & Socket type)]
27.	MAGNETIC OIL LEVEL GAUGE [Upto 400kV Transformer & Reactor]	(i) M/S SUKRUT UDYOG PUNE [Model type-SO-HE-10-M-ATMS-PS (Plug & Socket type)], [Model Type: SO-6-M-P-PS (Plug & Socket type)]/ (ii) M/S YOGYA ENTERPRISES, JHANSI [Model type-SO-10 (Plug & Socket type)]
28.	AIR CELL (FLEXIBLE AIR SEPARATOR) [Upto 400kV Transformer & Reactor]	Type test of following makes are not to be submitted (i) M/S THE RUBBER PRODUCTS MUMBAI / (ii) M/S UNIRUB TECHNO PUNE / (iii) M/S PRONAL FRANCE / (iv) M/S ZENITH INDUSTRIAL RUBBER PRODUCTS PVT. LTD. THANE / (v) SHENYANG HONGDA GENERAL RUBBER FACTORY, CHINA
29.	Sudden Pressure Relay [Upto 400kV Transformer & Reactor]	(i) Qualitrol [Model/Drawing No.900-003-02 CS-46518, 900-003-32 CS-46369] / (ii) VIAT INSTRUMENTS [Model/Drawing No.950 / (iii) Shenyang KEQI Electrical Equipment Co. Ltd. [Model/Drawing No.SYJ9-50-25 <sup>TH</sup> ]
30.	RIP Bushing (52kV, 3150A)	ABB Micafil, Switzerland [Model/Drawing No. 1ZCD073617 (Rev F)]
31.	RIP Bushing (420kV, 1250A)	ABB, SWEDEN [Model/Drawing No.1ZSC005378A0001 REV. K]
32.	RIP Bushing (245kV, 1250A)	ABB, SWEDEN [Model/Drawing No.1ZSC005416A0001 (Rev. D)]
33.	RIP Bushing (245kV, 2000A)	ABB, SWEDEN [Model/Drawing No.1ZSC005373A0001

**ANNEXURE-J****LIST OF THE MAKES FOR WHICH TYPE TEST REPORTS NOT REQUIRED TO BE SUBMITTED**

<b>Sl. No.</b>	<b>ITEM DESCRIPTION</b>	<b>MAKE</b>
		(Rev. C)]
34.	RIP Bushing (420kV, 1250A)	HSP Germany [Model/Drawing No.327470]
35.	RIP Bushing (245kV, 2000A)	HSP Germany [Model/Drawing No.329260]
36.	RIP Bushing (52kV, 3150A)	HSP Germany [Model/Drawing No.329280]
37.	RIP Bushing (420kV, 1250A)	Izolyator, Russia [Model/Drawing No.686354.603]
38.	RIP Bushing (245kV, 2000A)	Izolyator, Russia [Model/Drawing No.686353.602]
39.	RIP Bushing (52kV, 3150A)	Izolyator, Russia [Model/Drawing No.686351.601]
40.	RIP Bushing (145kV, 1250A)	Izolyator, Russia [Model/Drawing No.686352.604]
41.	RIP Bushing (420kV, 1250A)	TRENCH, CHINA [Model/Drawing No.ECT 707 (C2)]
42.	RIP Bushing (245kV, 2000A)	TRENCH, CHINA [Model/Drawing No.ECT 617 (C3)]
43.	RIP Bushing (245kV, 1250A)	TRENCH, CHINA [Model/Drawing No.ECT 616 (C3)]
44.	RIP Bushing (145kV, 1250A)	TRENCH, CHINA [Model/Drawing No.ECT 516 (C3)]
45.	RIP Bushing (52kV, 1250A)	TRENCH, CHINA [Model/Drawing No.ECT 415 (C3)]
46.	RIP Bushing (52kV, 3150A)	TRENCH, CHINA [Model/Drawing No.ECT 419 (C3)]
47.	RIP Bushing (420kV, 1250A)	Xian China [Model/Drawing No.75706 (Rev 09)]
48.	RIP Bushing (245kV,2000A)	Xian China [Model/Drawing No.75618 (Rev 09)]
49.	RIP Bushing (52kV, 3150A)	Xian China [Model/Drawing No.75366 (Rev 03)]
50.	RIP Bushing (52kV, 3150A)	Xian China [Model/Drawing No.75332 (Rev 08)]
51.	OIP Bushing (800kV, 2500A)	ABB, SWEDEN [Model / Drawing No. GOE-2550-1600-2500-0.6-B, 1ZSC026186-AAM REV. H]
52.	OIP Bushing (420kV, 2500A)	ABB, SWEDEN [Model / Drawing No.GOE-1425-1150-2500-0.6, 1ZSC026186-AAL REV. F]
53.	OIP Bushing (800kV, 2500A)	TBEA, CHINA [Model / Drawing No.TBEA-500-765T-A0035-01, REV. 02]
54.	OIP Bushing (420kV, 2500A)	TBEA, CHINA [Model / Drawing No.TBEA-500-765T-A0035-02, REV. 02]
55.	OIP Bushing (420kV, 2500A)	TRENCH, CHINA [Model / Drawing No.OT-738-1 (C 5)]
56.	OLTC (500MVA, 765kV ICT)	MR Germany [Model/Drawing No. MI 1503 72.5/RC- 12231WR]
57.	OLTC (500MVA, 400kV ICT)	Easun MR, Chennai [Model/Drawing No. 3 x MI 1200 300/D 10.19.3W]
58.	OLTC (220kV & below rating transformer)	BHEL, Bhopal [Model/Drawing No.MIII 600 110/C 10.19.3W]
<b>C.</b>	<b>TESTING EQUIPMENT FOR TRANSFORMER &amp; REACTOR</b>	
59.	Oil BDV Test Kit	Baur [Model/Drawing No.DTA 100C]
60.	Oil BDV Test Kit	Megger [Model/Drawing No.OTS 100AF]

**ANNEXURE-J****LIST OF THE MAKES FOR WHICH TYPE TEST REPORTS NOT REQUIRED TO BE SUBMITTED**

<b>Sl. No.</b>	<b>ITEM DESCRIPTION</b>	<b>MAKE</b>
61.	Online Dissolved Gas (Multi-gas) and Moisture Analyser	A Eberle GmbH & Co. KG [Model/Drawing No.HYDROCAL 1008]
62.	Online Dissolved Gas (Multi-gas) and Moisture Analyser	Ningbo Ligong Online Monitoring Technology Co. LTD [Model/Drawing No.MGA2000]
63.	Online Dissolved Gas (Multi-gas) and Moisture Analyser	GE Energy [Model/Drawing No.KELMAN TRANSFIX]
64.	Online Dissolved Gas (Multi-gas) and Moisture Analyser	Qualitrol Company LLC [Model/Drawing No.SERVERON TM 8]
65.	On line Insulating Oil Drying System	CEE DEE Vacuum Equipment Pvt. Ltd. [Model/Drawing No.TRANSDRY CD-002]
66.	On line Insulating Oil Drying System	PTSS [Model/Drawing No.PTSS-TDS1GA6XS]
67.	Portable Dissolved Gas Analysis of Insulating Oil	GE Energy [Model/Drawing No. KELMAN TRANSPORT X]

**NOTES:-**

1. For sub-station accessories mentioned at Sr. No. A above, model specific separate approval of type test report is not required.
2. For Transformer/Reactor accessories & testing equipment mentioned at Sr. No. B & C above, wherever, model/drawing no. is specified separate approval of type test report and drawing/documents is not required, thus requirement of type test report validity of 10 years is not applicable.

**SECTION-GENERAL TECHNICAL REQUIREMENTS (GTR)**ANNEXURE-K

<b>SL.NO.</b>	<b>Power System Equipment</b>
<b>A</b>	<b>Power System Equipment</b>
<b>1</b>	Transformers and Reactors (66 kV to 765 kV AC)
<b>2</b>	Air Insulated Switchgear (Circuit Breakers, Disconnectors), Surge Arrester, Wave trap (66 kV to 765 kV AC)
<b>3</b>	Gas Insulated Switchgear (66 kV to 400 kV AC)
<b>4</b>	Instrument Transformers (66 kV to 765 kV AC)
<b>5</b>	Bus Post Insulators
<b>6</b>	Substation structure material
<b>7</b>	Transmission line tower material
<b>8</b>	Conventional conductors and accessories
<b>9</b>	Porcelain Insulators and hardware fittings
<b>10</b>	Control & power cables
<b>11</b>	High Voltage Cables (upto 220 kV AC)
<b>12</b>	Control and Protection System including Substation Automation System
<b>13</b>	DG set
<b>14</b>	DC system (DC Battery & Battery Charger) in a substation
<b>15</b>	AC & DC Distribution Board for substation
<b>16</b>	Material for Grounding system
<b>17</b>	Items for illumination system
<b>B</b>	<b>Telecom Products, Services and Works</b>
<b>1</b>	Encryption/UTM platforms (TDM and IP)
<b>2</b>	IP/MPLS Core routers/ Edge/ Enterprise Router
<b>3</b>	Managed Leased line Network equipment
<b>4</b>	Ethernet Switches (L2 and L3), Hubs
<b>5</b>	IP based Soft Switches, IMS, Unified Communication Systems

**SECTION-GENERAL TECHNICAL REQUIREMENTS (GTR)****ANNEXURE-K**

6	Wireless/Wireline PABXs / IP PBX & / Media Gateways
7	CPE (including Wi-Fi Access points and Routers, Media Converters), 2G/3G/4G/LTE Modems, Leased-line Modems, NFV/SDN CPE
8	Set-Top Boxes
9	SDH/Carricr-Ethernct/MPLS- TP/Packet Optical Transport equipment/PTN/OTN systems
10	DWDM/CWDM systems
11	GPON/XGS-PON, NG-PON2 equipment (including ONT and OLT)
12	Optical/SDH/PDH Cross Connects/OTN Cross-connects and optical MUX, OADM
13	Small size 2 G/3 G GSM based Base Station Systems, with its various derivatives including rural & disaster response, Macro & Micro BTS, Small Cells, NIB, C-RAN BBU and RRH
14	2 G/3 G GSM based Base Station Systems, with its various derivatives including rural & disaster response, Macro & Micro BTS, Small Cells, NIB, C-RAN BBU and RRH
15	Small Size LTE/LTE-R Based Mobile Systems, with its various derivatives including rural & disaster communications, Macro & Micro eNodeB, Small Cells, EPC, NIB C-RAN BBU and RRH, LTE/LTE-R/4.5 G/ 5 G based broadband wireless access systems (eNodeB, gNB, EPC, etc.)
16	LTE/LTE-R Based Mobile Systems, with its various derivatives including rural & disaster communications, Macro & Micro eNode B, Small Cells, EPC, NIB C-RAN BBU and RRH, LTE/LTE-R/4.5 G/ 5 G based broadband wireless access systems (eNodeB, gNB, EPC, etc.)
17	Wi-Fi based broadband wireless access systems (Including Access Point, Aggregation Block, Core Block), Integrated Broadband system
18	Microwave Radio systems (IP/Hybrid), Mobile Front haul BBU and RRH (CPRI, eCPRI, FlexE, RoE, NGFI)
19	Software Defined Radio, Cognitive Radio systems
20	Repeaters (RF/RF-over-Optical), IBS, and Distributed Antenna system
21	Satellite based systems-Hubs, VSAT Disaster Communication Systems etc.
22	Copper access systems (DSL/DSLAM), high-speed xDSL (G.fast)
23	Network Management systems (NMS) with its various derivatives

**SECTION-GENERAL TECHNICAL REQUIREMENTS (GTR)****ANNEXURE-K**

24	Security and Surveillance Communication Systems (video and sensors based) including Perimeter Security Systems
25	Optical Fiber
26	Optical Fiber Cable
27	Telecom Power System (Including Solar Power)
28	Telecom Batteries (Lead Acid & Li-ion)
29	IP audio phones / IP video Phones / Analog adaptor
30	SDN Software Controllers, NVF and CNF software
31	Telecom Cloud infrastructure, Telecom Data centers
32	2 way Analog/Digital radio including Walkie-Talkie & Mobile Radio
33	Batteries of 2 way Analog/Digital radio including Walkie-Talkie
34	Fiber Monitoring System
35	M2M/IOT Subsystems
36	Telecom Services/Works

**SECTION-GENERAL TECHNICAL REQUIREMENTS (GTR)****ANNEXURE-L**

## Major Changes in Section GTR ( Rev 15)

S.No	Clause ref	Existing Clause	Proposed Text	Reason/Back ground for proposed changes
1.	Clause 2.1 a)		<p>All equipment/materials/items, as per Annexure-K, as applicable under present scope of works, shall be procured and supplied from domestic manufacturers only</p> <p>Any imported equipment/material/item/parts/component (comprising of embedded systems) to be supplied under the contract shall be tested in the certified laboratories to check for any kind of embedded malware/trojans/cyber threats and for adherence to Indian Standards as per the directions issued by Ministry of Power/Govt. of India from time to time. In case of such import from specified “prior reference” countries, the requirement of prior permission from the Govt. of India including protocol for testing in certified and designated laboratories by Ministry of Power/Govt. of India shall also be complied with by the contractor.</p> <p>The bidder/contractor shall list out the products and components producing Toxic e-waste under the contract and shall furnish to the Employer the procedure of safe disposal at the time of closing of the contract</p>	New Clause Added..
2.	Clause 2.6	The bidder shall be responsible for safety of human and equipment during the working.....	The <b>contractor</b> shall be responsible for safety of human and equipment during the working.	
3.	Clause 3.2	The equipment to be furnished under this specification shall conform to latest issue with all amendments (as on the originally scheduled date of bid opening) of standard specified under Annexure-C of this section, unless specifically mentioned in the specification.	The equipment offered by the contractor shall at least conform to the requirements specified under relevant IS standard. In case of discrepancy between IS and other international standard, provisions of IS shall prevail. The Contractor shall also note that the list of standards presented in this specification at Annex-C is not complete. Whenever necessary, the list of standards shall be considered in conjunction with specific IS. If the IS standard is not available for an equipment/material, then other applicable International standard	Changes incorporated In line with recent Guidelines from GOI.

**SECTION-GENERAL TECHNICAL REQUIREMENTS (GTR)****ANNEXURE-L**

## Major Changes in Section GTR ( Rev 15)

			(IEC/Equivalent), as per the specification, shall be accepted.	
4.	<b>Clause 3.3</b>	The Bidder shall note that standards mentioned in the specification are not mutually exclusive or complete in themselves, but intended to compliment each other.	The Contractor shall note that standards mentioned in the specification are not mutually exclusive or complete in themselves, but intended to compliment each other.	
5.	<b>Clause 3.4</b>	The Contractor shall also note that list of standards presented in this specification is not complete. Whenever necessary the list of standards shall be considered in conjunction with specific IS/IEC.	<b>The equipment offered by the contractor shall confirm to relevant IS standard. The list of such IS standards are given at Annexure-C. In case There is discrepancy between IS and other international standard then provision in IS shall prevail.</b> The Contractor shall also note that list of standards presented in this specification is not complete. Whenever necessary the list of standards shall be considered in conjunction with specific IS. <b>If the IS standard is not available for relevant equipment's/ Material is supplied from foreign country, then other internationally standard (IEC/Equivalent) will be accepted.</b>	Changes incorporated In line with recent Guidelines from GOI
6.	<b>Clause 4.1</b>	The 800kV and 420kV system is being designed to limit the switching surge over voltage of 1.9 p.u. and 2.5 p.u., respectively and the power frequency over voltage of 1.4 p.u. and 1.5 p.u., respectively. In case of the 420kV system, the initial value of the temporary overvoltages could be 2.0 p.u. for 1-2 cycles. The equipment furnished under this specification shall perform all its functions and operate satisfactorily without showing undue strain, restrike etc under such over voltage conditions.	<b>Switching surge over voltage and power frequency over voltage is specified in the system parameters below.</b> In case of the 420kV system, the initial value of the temporary over voltages could be 2.0 p.u. for 1-2 cycles. The equipment furnished under this specification shall perform all its functions and operate satisfactorily without showing undue strain, restrike etc under such over voltage conditions.	To avoid repetition.
7.	<b>Clause 4.4</b>	The bidder shall design terminal connectors of the equipment taking into account various forces that are required to withstand.	The <del>bidder</del> Contractor shall design terminal connectors of the equipment taking into account various forces <b>as mentioned at SI.No.4.3</b> that are required to withstand.	

**SECTION-GENERAL TECHNICAL REQUIREMENTS (GTR)**

**ANNEXURE-L**

**Major Changes in Section GTR ( Rev 15)**

8.	<b>Clause 4.6</b>	<p>4.6 System parameters 132kV,66kV,33kV &amp; 11kV System</p> <table border="1" data-bbox="436 300 992 427"> <thead> <tr> <th>S.No</th> <th>Description of parameters</th> <th>66kV System</th> </tr> </thead> <tbody> <tr> <td>9</td> <td>Rated Short circuit current</td> <td>31.5kA</td> </tr> </tbody> </table>	S.No	Description of parameters	66kV System	9	Rated Short circuit current	31.5kA	<p>4.6 System parameters 132kV,52kV 66kV,33kV &amp; 11kV System</p> <table border="1" data-bbox="1019 300 1608 547"> <thead> <tr> <th>S.No</th> <th>Description of parameters</th> <th>66kV System</th> </tr> </thead> <tbody> <tr> <td>9</td> <td>Rated Short circuit current</td> <td>31.5kA/25kA* for 3 Sec/</td> </tr> </tbody> </table> <p>* For Tertiary loading Equipment's fault level shall be 25kA for 3 Sec. For Other Switchyards shall be as specified in Section Project</p> <ul style="list-style-type: none"> <li>• Further Parameters of 52 kV System is also added</li> <li>• Sectional Clearance of 66kV System is updated in line with Safety regulation of CEA</li> </ul>	S.No	Description of parameters	66kV System	9	Rated Short circuit current	31.5kA/25kA* for 3 Sec/	
S.No	Description of parameters	66kV System														
9	Rated Short circuit current	31.5kA														
S.No	Description of parameters	66kV System														
9	Rated Short circuit current	31.5kA/25kA* for 3 Sec/														
9.	<b>Clause 5.2</b>	<p>The Contractor shall submit 4 (four) sets of drawings/ design documents /data detailed bill of quantity and 1 (one) set of test reports for the approval of the Employer. The contractor shall also submit the softcopy of the above documents in addition to hardcopy.</p>	<p>The Contractor shall submit <del>4 (four) sets of</del> All Engineering Documents ( drawings/ design documents /data / detailed bill of quantity and 1 (one) set of test reports) through Online Document Review and Engineering Approval Management System( Herein after DREAMS) for the approval of the Employer. <del>The contractor shall also submit the softcopy of the above documents in addition to hardcopy</del></p>													
10.	<b>Clause 5.7</b>	<p>Approval Procedure Note (2) All drawings should be submitted in softcopy form, however substation design drawings like SLD, GA, all layouts etc. shall also be submitted in AutoCAD Version. SLD, GA &amp; layout drawings shall be submitted for the entire substation in case of substation extension also</p>	<p>Approval Procedure Note (2) All drawings should be submitted in <del>softcopy form</del> DREAMS, however further substation design drawings like SLD, GA, all layouts etc. shall also be submitted in AutoCAD Version as supporting documents in DREAMS. SLD, GA &amp; layout drawings shall be submitted for the entire substation in case of substation extension also.</p> <p>For Civil drawings, associated documents shall be submitted in</p>													

**SECTION-GENERAL TECHNICAL REQUIREMENTS (GTR)****ANNEXURE-L**

## Major Changes in Section GTR ( Rev 15)

			<b>STAAD/Excel format as supporting document in DREAMS.</b>	
11.	<b>Clause 6.1.7</b>	All oil, grease and other consumables used in the Works/Equipment shall be purchased in India unless the Contractor has any special requirement for the specific application of a type of oil or grease not available in India. If such is the case, he shall declare in the proposal, where such oil or grease is available. He shall help Employer in establishing equivalent Indian make and Indian Contractor. The same shall be applicable to other consumables too.	All oil, grease and other consumables used in the Works/Equipment shall be purchased in India unless the Contractor has any special requirement for the specific application of a type of oil or grease not available in India. If such is the case, he shall declare <b>source of oil/grease /other consumables</b> in the <del>proposal</del> <b>GTP/Drawings</b> , where such oil or grease is available. He shall help Employer in establishing equivalent Indian make and Indian Contractor. The same shall be applicable to other consumables too.	
12.	<b>Clause 6.2.4</b>	Degree of Protection  The degree of protection shall be in accordance with IS:13947(Part-I)/IEC-60947 (Part-I)/IS 12063/IEC-60529. Type test report for IP-55 or higher degree of protection shall be submitted for approval.	Degree of Protection  The degree of protection shall be in accordance with <b>IS/IEC60947; IS/IEC60529</b> . Type test report <b>of relevant Degree of Protection test</b> , shall be submitted for approval.	IS 13947 is superseded by IS/IEC 60947 IS 12063 is superseded by IS/IEC 60529
13.	<b>Clause 6.3.1</b>	Each main and auxiliary item of substation is to have permanently attached to it in a conspicuous position a rating plate of non-corrosive material upon which is to be engraved manufacturer's name, , year of manufacture, equipment name, type or serial number together with details of the loading conditions under which the item of substation in question has been designed to operate, and such diagram plates as may be required by the Employer. The rating plate of each equipment shall be according to IEC requirement.	Each main and auxiliary item of substation is to have permanently attached to it in a conspicuous position a rating plate of non-corrosive material upon which is to be engraved manufacturer's name, <b>Customer Name</b> , year of manufacture, equipment name, type or serial number together with details of the loading conditions under which the item of substation in question has been designed to operate, and such diagram plates as may be required by the Employer. The rating plate of each equipment shall be according to <b>IS/ IEC</b> requirement.	
14.	<b>Clause 9.2</b>	The reports for all type tests as per technical specification shall be furnished by the Contractor alongwith equipment / material drawings. However, type test reports of similar equipments/ material already accepted in POWERGRID shall	The reports for all type tests as per technical specification shall be furnished by the Contractor alongwith equipment / material drawings. However, type test reports of similar equipments/ material already accepted in POWERGRID shall be applicable for all projects with similar requirement. The type tests conducted earlier should have	In line with CEA Guidelines for Validity of Type tests

**SECTION-GENERAL TECHNICAL REQUIREMENTS (GTR)**

**ANNEXURE-L**

**Major Changes in Section GTR ( Rev 15)**

		<p>be applicable for all projects with similar requirement. The type tests conducted earlier should have either been conducted in accredited laboratory (accredited based on ISO / IEC Guide 25 / 17025 or EN 45001 by the national accreditation body of the country where laboratory is located) or witnessed by POWERGRID or representative authorized by POWERGRID or Utility or representative of accredited test lab.</p> <p>Unless otherwise specified elsewhere, the type test reports submitted shall be of the tests conducted within last 10 (ten) years from the date of NOA. In case the test reports are of the test conducted earlier than 10 (ten) years from the date of NOA, the contractor shall repeat these test(s) at no extra cost to the Employer</p>	<p>either been conducted in accredited laboratory (accredited based on ISO / IEC Guide 25 / 17025 or EN 45001 by the national accreditation body of the country where laboratory is located) or witnessed by POWERGRID/representative authorized by POWERGRID/representative of Utility /representative of accredited test lab/ representative of NABCB certified agency shall also be acceptable.</p> <p>Unless otherwise specified elsewhere, the type test reports submitted shall be of the tests conducted within the years specified below from the date of NOA. In case the test reports are of the test conducted earlier than the years specified below from the date of NOA, the contractor shall repeat these test(s) at no extra cost to the Employer.</p> <table border="1" data-bbox="1019 715 1601 1305"> <thead> <tr> <th>S. No</th> <th>Name of Equipment</th> <th>Validity of type test( in years )</th> </tr> </thead> <tbody> <tr> <td>1</td> <td>Power Transformer</td> <td>5</td> </tr> <tr> <td>2</td> <td>LT Transformer</td> <td>5</td> </tr> <tr> <td>3</td> <td>Shunt Reactor</td> <td>5</td> </tr> <tr> <td>4</td> <td>OLTC</td> <td>10</td> </tr> <tr> <td>5</td> <td>Bushing of Power Transformers/Reactors</td> <td>7</td> </tr> <tr> <td>6</td> <td>Fittings and accessories for Power transformers &amp; Reactors</td> <td>10</td> </tr> <tr> <td>7</td> <td>Circuit Breaker</td> <td>10</td> </tr> <tr> <td>8</td> <td>Isolator</td> <td>10</td> </tr> <tr> <td>9</td> <td>Lighting Arrester</td> <td>10</td> </tr> <tr> <td>10</td> <td>Wave Trap</td> <td>10</td> </tr> <tr> <td>11</td> <td>Instrument transformer</td> <td>7</td> </tr> <tr> <td>12</td> <td>GIS &amp; Hybrid GIS</td> <td>10</td> </tr> </tbody> </table>	S. No	Name of Equipment	Validity of type test( in years )	1	Power Transformer	5	2	LT Transformer	5	3	Shunt Reactor	5	4	OLTC	10	5	Bushing of Power Transformers/Reactors	7	6	Fittings and accessories for Power transformers & Reactors	10	7	Circuit Breaker	10	8	Isolator	10	9	Lighting Arrester	10	10	Wave Trap	10	11	Instrument transformer	7	12	GIS & Hybrid GIS	10	
S. No	Name of Equipment	Validity of type test( in years )																																									
1	Power Transformer	5																																									
2	LT Transformer	5																																									
3	Shunt Reactor	5																																									
4	OLTC	10																																									
5	Bushing of Power Transformers/Reactors	7																																									
6	Fittings and accessories for Power transformers & Reactors	10																																									
7	Circuit Breaker	10																																									
8	Isolator	10																																									
9	Lighting Arrester	10																																									
10	Wave Trap	10																																									
11	Instrument transformer	7																																									
12	GIS & Hybrid GIS	10																																									

**SECTION-GENERAL TECHNICAL REQUIREMENTS (GTR)**

**ANNEXURE-L**

Major Changes in Section GTR ( Rev 15)

			<table border="1"> <tr> <td>13</td> <td>LT Switchgear</td> <td>10</td> </tr> <tr> <td>14</td> <td>Cable and associated accessories</td> <td>10</td> </tr> <tr> <td>15</td> <td>Relays</td> <td>7</td> </tr> <tr> <td>16</td> <td>Capacitors</td> <td>10</td> </tr> <tr> <td>17</td> <td>Battery &amp; Battery Charger</td> <td>7</td> </tr> <tr> <td>18</td> <td>Conductor &amp; Earth wire</td> <td>10</td> </tr> <tr> <td>19</td> <td>Insulators ( Porcelain/Glass)</td> <td>10</td> </tr> <tr> <td>20</td> <td>Composite Insulators</td> <td>5</td> </tr> <tr> <td>21</td> <td>PLCC</td> <td>5</td> </tr> </table> <p>Note For all other equipment's validity of type test shall be 10 years from date of NOA</p> <p>Further, in the event of any discrepancy in the test reports i.e. any test report not acceptable due to any design/manufacturing changes or due to non-compliance with the requirement stipulated in the Technical Specification or any/all type tests not carried out, same shall be carried out without any additional cost implication to the Employer.</p> <p>The Contractor shall intimate the Employer the detailed program about the type tests atleast two (2) weeks in advance in case of domestic supplies &amp; six (6) weeks in advance in case of foreign supplies</p>	13	LT Switchgear	10	14	Cable and associated accessories	10	15	Relays	7	16	Capacitors	10	17	Battery & Battery Charger	7	18	Conductor & Earth wire	10	19	Insulators ( Porcelain/Glass)	10	20	Composite Insulators	5	21	PLCC	5	
13	LT Switchgear	10																													
14	Cable and associated accessories	10																													
15	Relays	7																													
16	Capacitors	10																													
17	Battery & Battery Charger	7																													
18	Conductor & Earth wire	10																													
19	Insulators ( Porcelain/Glass)	10																													
20	Composite Insulators	5																													
21	PLCC	5																													
15.	<b>Clause no. 9.5</b>	The list of makes of various items, for which Type test reports are not required to be submitted are specified in Compendium of Vendors (COV).	The list of makes of various items, for which Type test reports are not required to be submitted are specified <del>in Compendium of Vendor (COV)</del> <b>at Annex-J</b>																												
16.	<b>Clause 12.2</b>	The minimum weight of the zinc coating shall be 610 gm/sq.m and minimum average thickness of coating shall be 86 microns for all items having thickness 6mm and above <b>and 900 gm/sq.m for coastal area (30km from sea shore approximately ) or as specified in Section-</b>	The minimum weight of the zinc coating shall be 610 gm/sq.m and minimum average thickness of coating shall be 86 microns for all items having thickness 6mm and above <b>and 900 gm/sq.m for coastal area (30km from sea shore approximately if defined in Section Project) or as specified in Section-Project</b> . For items lower than 6mm thickness requirement of coating thickness shall be as per relevant ASTM. For																												

**SECTION-GENERAL TECHNICAL REQUIREMENTS (GTR)**

ANNEXURE-L

Major Changes in Section GTR ( Rev 15)

		<b>Project.</b> For items lower than 6mm thickness requirement of coating thickness shall be as per relevant ASTM. For surface which shall be embedded in concrete, the zinc coating shall be 610 gm/sq.m minimum <b>and 900 gm/sq.m for coastal area as specified in Section-Project</b>	surface which shall be embedded in concrete, the zinc coating shall be 610 gm/sq.m minimum <b>and 900 gm/sq.m for coastal area as specified in Section-Project</b>																	
17.	<b>Clause 12.3.2</b>	After phosphating, thorough rinsing shall be carried out with clean water followed by final rinsing with dilute dichromate solution and oven drying. The phosphate coating shall be sealed with application of two coats of ready mixed, stoving type zinc chromate primer. The first coat may be “flash dried” while the second coat shall be stoved	<b>Hot Phosphating shall be done for phosphating process under pretreatment of sheets</b> After phosphating, thorough rinsing shall be carried out with clean water followed by final rinsing with dilute dichromate solution and oven drying. The phosphate coating shall be sealed with application of two coats of ready mixed, stoving type zinc chromate primer. The first coat may be “flash dried” while the second coat shall be stoved																	
18.	<b>Clause 12.3.6</b>	<table border="1"> <thead> <tr> <th>S.No</th> <th>PIPE LINE</th> <th>BASE COLOUR</th> <th>BAN D COLOUR</th> </tr> </thead> <tbody> <tr> <td>1</td> <td>Hydrant and Emulsifier system pipeline</td> <td>Fire red</td> <td></td> </tr> </tbody> </table>	S.No	PIPE LINE	BASE COLOUR	BAN D COLOUR	1	Hydrant and Emulsifier system pipeline	Fire red		<table border="1"> <thead> <tr> <th>S.No</th> <th>PIPE LINE</th> <th>BASE COLOUR</th> <th>BAND COLOUR</th> </tr> </thead> <tbody> <tr> <td>1</td> <td>Hydrant and Emulsifier system pipeline /NIFPS</td> <td>Fire red</td> <td></td> </tr> </tbody> </table>	S.No	PIPE LINE	BASE COLOUR	BAND COLOUR	1	Hydrant and Emulsifier system pipeline /NIFPS	Fire red		
S.No	PIPE LINE	BASE COLOUR	BAN D COLOUR																	
1	Hydrant and Emulsifier system pipeline	Fire red																		
S.No	PIPE LINE	BASE COLOUR	BAND COLOUR																	
1	Hydrant and Emulsifier system pipeline /NIFPS	Fire red																		
19.	<b>Clause no. 12.3.8</b>		Band colour is required for Emulsifier system detection line only if both water and air detection lines are present at the same substation. Further, band colour shall be applied at an interval of 2 meters approx. along the length and minimum width of band shall be 25mm.	New Clause added																
20.	<b>Clause No. 13.14</b>		Erection, testing and commissioning of Transformers, Reactors, Circuit breakers, Isolators, Substation automation system, Control & protection panels, PLCC, PMU, Telecommunication Equipments, NIFPS System ,	New Clause added																

**SECTION-GENERAL TECHNICAL REQUIREMENTS (GTR)**

ANNEXURE-L

Major Changes in Section GTR ( Rev 15)

			etc. shall be done by the contractor under the supervision of respective equipment manufacturers. Charges for the above supervision shall be included by the bidder in the erection charges for the respective equipment in the BPS.																
21.	<b>Clause no. 15.2</b>		Pickup value of binary input modules of Intelligent Electronic Devices, Digital protection couplers, Analog protection couplers shall not be less than 50% of the specified rated station auxiliary DC supply voltage level.	New Clause added															
22.	<b>Clause no. 16.2</b>	The minimum vertical distance from the bottom of the lowest porcelain part of the bushing, porcelain enclosures or supporting insulators to the bottom of the equipment base, where it rests on the foundation pad shall be 2.55 metres.	The minimum vertical distance from the bottom of the lowest porcelain/ <b>polymer</b> part of the bushing, porcelain/ <b>polymer</b> enclosures or supporting insulators to the bottom of the equipment base, where it rests on the foundation pad shall be 2.55 metres.																
23.	<b>Clause 17.1</b>	<table border="1"> <thead> <tr> <th>S.No</th> <th>Description</th> <th>Material</th> </tr> </thead> <tbody> <tr> <td>a</td> <td>For connecting ACSR conductors/AAC conductors/Aluminium tube</td> <td>Aluminum alloy casting, conforming to designation A6 of IS:617 and all test shall conform to IS:617</td> </tr> <tr> <td>b</td> <td>For connecting equipment terminals made of</td> <td>Bimetallic connectors made from aluminum alloy casting, conforming</td> </tr> </tbody> </table>	S.No	Description	Material	a	For connecting ACSR conductors/AAC conductors/Aluminium tube	Aluminum alloy casting, conforming to designation A6 of IS:617 and all test shall conform to IS:617	b	For connecting equipment terminals made of	Bimetallic connectors made from aluminum alloy casting, conforming	<table border="1"> <thead> <tr> <th>Sl. No.</th> <th>Description</th> <th>Materials</th> </tr> </thead> <tbody> <tr> <td>a)</td> <td>For connecting ACSR conductors/AAC conductors/Aluminium tube</td> <td>Aluminum alloy casting, conforming to designation <del>A6</del> <b>4600</b> of IS:617 and all test shall conform to IS:617</td> </tr> </tbody> </table>	Sl. No.	Description	Materials	a)	For connecting ACSR conductors/AAC conductors/Aluminium tube	Aluminum alloy casting, conforming to designation <del>A6</del> <b>4600</b> of IS:617 and all test shall conform to IS:617	
S.No	Description	Material																	
a	For connecting ACSR conductors/AAC conductors/Aluminium tube	Aluminum alloy casting, conforming to designation A6 of IS:617 and all test shall conform to IS:617																	
b	For connecting equipment terminals made of	Bimetallic connectors made from aluminum alloy casting, conforming																	
Sl. No.	Description	Materials																	
a)	For connecting ACSR conductors/AAC conductors/Aluminium tube	Aluminum alloy casting, conforming to designation <del>A6</del> <b>4600</b> of IS:617 and all test shall conform to IS:617																	

**SECTION-GENERAL TECHNICAL REQUIREMENTS (GTR)**

ANNEXURE-L

Major Changes in Section GTR ( Rev 15)

		<p>copper with ACSR conductors/AAC conductors/ Aluminium tube</p> <p>to designation A6 of IS:617 with 2mm thick bimetallic liner/strip and all test shall conform to IS:617</p>	<p>b)</p> <p>For connecting equipment terminals made of copper with ACSR conductors/AAC conductors/ Aluminium tube</p> <p>Bimetallic connectors made from aluminum alloy casting, conforming to designation A64600 of IS:617 with 2mm thick bimetallic liner/strip and all test shall conform to IS:617</p>	
24.	<b>Clause 17.11</b>	<p>Clamps and connectors should be type tested on as per IS:5561 and shall also be subjected to routine tests as per IS:5561. Following type test reports shall be submitted for approval. Type test once conducted shall hold good. The requirement of test conducted within last ten years, shall not be applicable</p> <p>i) Temperature rise test (maximum temperature rise allowed is 35°C over 50°C ambient)</p> <p>ii) Short time current test</p> <p>iii) Corona (dry) [for 400kV and above] and RIV (dry) test [for 132kV and above voltage level clamps]</p>	<p>Clamps and connectors should be type tested on <b>minimum three samples</b> as per IS:5561 and shall also be subjected to routine tests as per IS:5561. Following type test reports shall be submitted for approval. <b>Type test once conducted shall hold good. The requirement of test conducted within last ten years, shall not be applicable</b></p> <p>i) Temperature rise test (maximum temperature rise allowed is 35°C over 50°C ambient)</p> <p>ii) Short time current test</p> <p>iii) Corona (dry) [<del>for 400kV and above</del>] and RIV (dry) test [for 132kV and above voltage level clamps]</p> <p>iv) Resistance test and <del>tensile test</del> <b>Pullout strength test</b></p> <p><b>v) Cantilever strength test on bus support clamps &amp; connectors</b></p>	

**SECTION-GENERAL TECHNICAL REQUIREMENTS (GTR)**

ANNEXURE-L

Major Changes in Section GTR ( Rev 15)

		iv) Resistance test and tensile test	
25.	<b>Clause 18.1</b>	All types of boxes, cabinets etc. shall generally conform to & be tested in accordance with IS-5039/IS-8623, IEC-60439, as applicable, and the clauses given below:	All types of boxes, cabinets etc. shall generally conform to & be tested in accordance with <del>IS-5039/IS-8623, IEC-60439</del> <b>IS/IEC 61439-0</b> , as applicable, and the clauses given below:
26.	<b>Clause 18.2</b>	Control cabinets, junction boxes, Marshalling boxes, & terminal boxes shall be made of stainless steel of atleast 1.5 mm thick or aluminum enclosure of atleast 1.6 mm thick and shall be dust, water and vermin proof. Stainless steel used shall be of grade SS304 (SS316 for coastal area) or better. The box shall be properly braced to prevent wobbling. There shall be sufficient reinforcement to provide level surfaces, resistance to vibrations and rigidity during transportation and installation. In case of aluminum enclosed box the thickness of aluminum shall be such that it provides adequate rigidity and long life as comparable with sheet steel of specified thickness.	Control cabinets, junction boxes, Marshalling boxes & terminal boxes, <b>Out door ACDB cum DCDB panels</b> shall be made of stainless steel of atleast 1.5 mm thick or aluminum enclosure of atleast 1.6 mm thick and shall be dust, water and vermin proof. Stainless steel used shall be of grade SS304 (SS316 for coastal area) or better. The box shall be properly braced to prevent wobbling. There shall be sufficient reinforcement to provide level surfaces, resistance to vibrations and rigidity during transportation and installation. In case of aluminum enclosed box the thickness of aluminum shall be such that it provides adequate rigidity and long life as comparable with sheet steel of specified thickness.  <b>Control cabinets, junction boxes, marshalling boxes &amp; terminal boxes, out-door ACDB cum DCDB panels shall have adequate space/clearance as per guidelines/technical specifications to access/replace any component. Necessary component labelling to be also done on non-conducting sheet.</b>  <b>For CONTROL CABINETS, JUNCTION BOXES, TERMINAL BOXES MARSHALLING BOXES FOR OUTDOOR EQUIPMENT Junction Box, wire should be as per IS or equivalent IEC with FRLS grade</b>  <b>Machine laid PU Foam gasket may be permitted for use in Control Cabinets etc.</b>

**SECTION-GENERAL TECHNICAL REQUIREMENTS (GTR)****ANNEXURE-L**

## Major Changes in Section GTR ( Rev 15)

27.	<b>Clause 18.4</b>	Cabinet/boxes shall be provided with double hinged doors with padlocking arrangements. The distance between two hinges shall be adequate to ensure uniform sealing pressure against atmosphere	Cabinet/boxes shall be provided with double hinged doors with padlocking arrangements. The distance between two hinges shall be adequate to ensure uniform sealing pressure against atmosphere.  Cabinet boxes with width more than 700 mm shall be double door double hinged with padlocking type.	
28.	<b>Clause 18.13</b>	The enclosure of bay marshalling kiosk, junction box, terminal box and control cabinets shall conform to IP-55 as per IS:13947 including application of 2KV rms for 1 (one) minute, insulation resistance and functional test after IP-55 test	The enclosure of bay marshalling kiosk, junction box, terminal box and control cabinets shall conform to IP-55 as per <b>IS/IEC60947</b> including application of <b>minimum 1KV rms for 1 (one) minute, insulation resistance and functional test</b> after IP-55 test	
29.	<b>Clause 20.13</b>	The Contractor shall furnish all wire, conduits and terminals for the necessary interphase electrical connections (where applicable) as well as between phases and common terminal boxes or control cabinets. <b>For equipments rated for 400 kV and above the wiring required in these items shall be run in metallic ducts or shielded cables in order to avoid surge over voltages either transferred through the equipment or due to transients induced from the EHV circuits.</b>	The Contractor shall furnish all wire, conduits and terminals for the necessary interphase electrical connections (where applicable) as well as between phases and common terminal boxes or control cabinets. <del>For equipments rated for 400 kV and above the wiring required in these items shall be run in metallic ducts or shielded cables in order to avoid surge over voltages either transferred through the equipment or due to transients induced from the EHV circuits.</del>	
30.	<b>Clause 20.14</b>	All input and output terminals of each control cubicle shall be tested for surge withstand capability in accordance with the relevant IEC Publications, in both longitudinal and transverse modes. The Contractor shall also provide all necessary filtering, surge protection, interface relays and any other measures necessary to achieve an impulse withstand level at the cable interfaces of the equipment.	-	Clause deleted
31.	<b>Clause 21.3.2</b>	All fuses shall be of HRC cartridge type	All fuses shall be of HRC cartridge type conforming to <b>relevant IS</b>	

**SECTION-GENERAL TECHNICAL REQUIREMENTS (GTR)****ANNEXURE-L**

## Major Changes in Section GTR ( Rev 15)

		conforming to IS:9228 mounted on plug-in type fuse bases. Miniature circuit breakers with thermal protection and alarm contacts will also be accepted. All accessible live connection to fuse bases shall be adequately shrouded. Fuses shall have operation indicators for indicating blown fuse condition. Fuse carrier base shall have imprints of the fuse rating and voltage	mounted on plug-in type fuse bases. Miniature circuit breakers with thermal protection and alarm contacts will also be accepted. All accessible live connection to fuse bases shall be adequately shrouded. Fuses shall have operation indicators for indicating blown fuse condition. Fuse carrier base shall have imprints of the fuse rating and voltage	
32.	<b>Clause 22.8</b>	<b>Tests</b>  In bushing, hollow column insulators and support insulators shall conform to type tests and shall be subjected to routine tests in accordance with IS:2099 & IS:2544 & IS:5621.	-	Clause deleted
33.	<b>Clause No. 22.10</b>		All switchgear/equipments, insulator strings, bushings, bus post insulators shall be designed for minimum creepage distance of 31mm/kV or 25mm/kV as mentioned against each substation in section project under "PHYSICAL AND OTHER PARAMETERS" Zinc coating for galvanized lattice and pipe structures, all ferrous parts of composite long rod insulators and earthing conductors shall not be less than 900 gm/sq-m irrespective of other values mentioned elsewhere in technical specification/drawings at substations where creepage distance is considered as 31mm/kV. In case, different designs of lattice and pipe structures other than Employer supplied structures are required to be adopted in view of higher creepage (31mm/kV) of the switchgear/equipments, insulator strings, bushings & bus post insulators etc., Design, supply & erection of such structures shall be in the scope of contractor against respective standard structure. However dimensional details (except height) shall not be less than that specified in standard structure drawing of respective equipments.  <b>Silicon RTV coating:-</b> Equipment/insulators (except equipments with polymer insulator) including mandatory spares being supplied at	New Clause added

**SECTION-GENERAL TECHNICAL REQUIREMENTS (GTR)****ANNEXURE-L**

## Major Changes in Section GTR ( Rev 15)

			substations where creepage distance is considered as 31mm/kV shall be with Silicon RTV coating. The price of RTV coating shall be included in the installation cost of respective equipment.	
34.	<b>Clause No. 24</b>	<b>TECHNICAL REQUIREMENT OF EQUIPMENTS</b> Following equipment shall be offered from the manufacturer(s) who meets the technical requirements as stipulated here, provided the same equipment are not covered under the Bidder's Qualifying requirement of the Bidding Documents.	<b>24. TECHNICAL REQUIREMENT OF EQUIPMENTS</b> <b>24.1</b> Following equipment shall be offered from the <b>Indian Manufacturing Facilities</b> of manufacturer(s) who meets the technical requirements as stipulated here, provided the same equipment are not covered under the Bidder's Qualifying requirement of the Bidding Documents.	
35.	<b>Clause 24.1</b>	<b>24.1 Technical requirements for 765/400/220/132/110kV* Air Insulated Switchgear (AIS) Equipment* (i.e Circuit Breaker, Isolator, Current Transformer, Capacitive Voltage transformer, Inductive Voltage transformer, Surge Arrester and Wave Trap)</b>  (i) The manufacturer(s) whose 765/400/220/132/110kV* equipment(s) are offered, must have, manufactured, type tested (as per IEC/IS or equivalent standard) and supplied 715/345/220/132/110kV* or higher voltage class equipment(s), which are in satisfactory operation# for atleast two (2) years as on the date of NOA.	<b>24.1 Technical requirements for 765/400/220/132/110kV* Air Insulated Switchgear (AIS) Equipment* (i.e Circuit Breaker, Isolator, Current Transformer, Capacitive Voltage transformer, Inductive Voltage transformer, Surge Arrester and Wave Trap)</b>  (i) The manufacturer(s) whose 765/400/220/132/110kV* equipment(s) are offered, must have, manufactured, type tested (as per IEC/IS or equivalent standard) and supplied 715/345/220/132/110kV* or higher voltage class equipment(s), which are in satisfactory operation# for atleast two (2) years as on the date of NOA.  (ii) Alternatively, the manufacturer, who have established manufacturing and testing facilities in India for the offered equipment and not meeting the requirement stipulated in (i) above, can also be considered provided that	

**SECTION-GENERAL TECHNICAL REQUIREMENTS (GTR)**

**ANNEXURE-L**

**Major Changes in Section GTR ( Rev 15)**

		<p>(ii) Alternatively, the manufacturer, who have established manufacturing and testing facilities in India for the offered equipment and not meeting the requirement stipulated in (i) above, can also be considered provided that</p> <p>a) 715/345/220/132/110kV* or higher Voltage class equipment(s) must have been manufactured in the above Indian works &amp; type tested (as per IEC/IS standard) and supplied as on the date of NOA.</p> <p>Contractor shall furnish performance guarantee for an amount of 10% of the ex-works cost of the equipments(s)* and this performance guarantee shall be in addition to the contract performance guarantee to be submitted by the contractor.</p>	<p>a) 715/345/220/132/110kV* or higher Voltage class equipment(s) must have been manufactured in the above Indian works &amp; type tested (as per IEC/IS standard) and supplied as on the date of NOA.</p> <p>In case manufacturer meets the technical requirement through clause (ii) above, warranty obligations for additional warranty of two(2) years over &amp; above the warranty period as specified in the bidding documents shall be applicable for the entire quantity of the offered equipment to be supplied under the contract. Further, contractor shall furnish performance guarantee for an amount of 3% of the ex-works cost of the equipments(s)* for the additional warranty period in addition to the contract performance guarantee to be submitted by the contractor.</p>	
25.	<b>Clause No. 24.2</b>	<p><b>Technical Requirement for 765kV class Transformer</b></p> <p>(i) The Manufacturer whose 765kV Transformer(s) are offered must have designed, manufactured, tested &amp; supplied 715 kV or higher voltage class one (1) number three phase Transformer of atleast 500 MVA capacity (or equivalent capacity in a bank of three (3) numbers single phase units). These transformer(s) must have been in satisfactory operation# for atleast two</p>	<p><b>Technical Requirement for 765kV class Transformer</b></p> <p>(i) The Manufacturer whose 765kV Transformer(s) are offered must have designed, manufactured, tested &amp; supplied 715 kV or higher voltage class one (1) number 1-phase Transformer of at least 500 MVA capacity or at least three (3) numbers 1-phase Transformers each having a capacity of at least 166 MVA, and the same transformer (s) should have been in satisfactory operation# for atleast two (2) years as on the date of NOA.</p>	

**SECTION-GENERAL TECHNICAL REQUIREMENTS (GTR)**

**ANNEXURE-L**

**Major Changes in Section GTR ( Rev 15)**

		<p>(2) years as on the date of NOA.</p> <p>(ii) Alternatively, the manufacturer, who have established manufacturing and testing facilities in India and not meeting the requirement stipulated in (i) above, can also be considered provided that</p> <p>a) 715kV or higher voltage class one (1) number three phase Transformer of atleast 500 MVA capacity (or equivalent capacity in a bank of three (3)numbers single phase units) must have been manufactured in the above Indian works based on technological support of collaborator, type tested (as per IEC/IS standard) and supplied as on the date of NOA.</p> <p>b) The collaborator meets the requirements stipulated in (i) above. A valid collaboration agreement for technology transfer / license to design, manufacture, test and supply 765kV transformer in India, shall be submitted.</p> <p>c) the collaborator shall furnish performance guarantee for an amount of 10% of the ex-works cost of such equipment(s) and this performance guarantee shall be in addition to contract performance guarantee to be submitted by the contractor.</p>	<p>(ii) Alternatively, the manufacturer, who have established manufacturing and testing facilities in India and not meeting the requirement stipulated in (i) above, can also be considered provided that</p> <p>a) 715 kV or higher voltage class either One (1) no. 1-phase Transformer of at least 166 MVA capacity or One (1) no. 1-phase Reactor of at least 80 MVAR capacity must have been manufactured in the above Indian works based on technological support of collaborator, type tested (as per IEC/IS standard) and same should have been supplied as on the date of NOA.</p> <p>b) The collaborator meets the requirements stipulated in (i) above. A valid collaboration agreement for technology transfer / license to design, manufacture, test and supply 765kV transformer in India, shall be submitted.</p> <p>c) the collaborator shall furnish performance guarantee for an amount of <b>10-3%</b> of the ex-works cost of such equipment(s) and this performance guarantee shall be in addition to contract performance guarantee to be submitted by the contractor</p>	
26.	<b>Clause No. 24.3</b>	<del>24.3— Technical Requirement for 765kV class Reactor</del>	<b>24.3 Technical Requirement for 765kV class Reactor</b>	
			(i) The Manufacturer whose 765kV Reactor(s) are offered must have designed, manufactured, tested & supplied 715 kV or	

**SECTION-GENERAL TECHNICAL REQUIREMENTS (GTR)**

**ANNEXURE-L**

**Major Changes in Section GTR ( Rev 15)**

		<p>(i) <del>The Manufacturer whose 765kV Reactor(s) are offered must have designed, manufactured, tested &amp; supplied 715kV or higher voltage class one (1) number three phase Reactor of atleast 240 MVAR capacity (or equivalent capacity in a bank of three (3) numbers single phase units). These Reactor(s) must have been in satisfactory operation# for atleast two (2) years as on the date of NOA.</del></p> <p style="text-align: center;"><del>OR</del></p> <p>(ii) <del>The Manufacturer must have designed, manufactured, tested &amp; supplied 715kV or higher voltage class one (1) number three phase Transformer of atleast 500MVA capacity (or equivalent capacity in a bank of three (3) numbers single phase units). These Transformer(s) must have been in satisfactory operation# for atleast two (2) years as on the date of NOA. And the manufacturer must have designed, manufactured, tested &amp; supplied 345kV or higher voltage class one (1) number three phase Reactor of atleast 50MVAR capacity (or equivalent capacity in a bank of three (3) numbers single phase units). These Reactors must have been in satisfactory operation# for atleast two (2) years as on the date of NOA.</del></p> <p>(iii) <del>Alternatively, the manufacturer, who have established manufacturing and testing facilities in India and not meeting the requirement stipulated in (i) above, can also be considered provided that</del></p>	<p>higher voltage class one (1) number 1-phase Reactor of at least 110 MVAR capacity or at least three (3) numbers 1-phase Reactors each having a capacity of at least 36.7 MVAR and the same Reactor(s) should have been in satisfactory operation# for atleast two (2) years as on the date of NOA.</p> <p style="text-align: center;"><b>OR</b></p> <p>The Manufacturer must have designed, manufactured, tested &amp; supplied 715 kV or higher voltage class one (1) number 1-phase Transformer of at least 500 MVA capacity or at least three (3) numbers 1-phase Transformers each having a capacity of at least 166 MVA and the bidder should have designed, manufactured, tested &amp; supplied 345 kV or higher voltage class one (1) number 3-phase Reactor of at least 50 MVAR capacity or at least three (3) numbers 1-phase Reactors each having a capacity of at least 16.7 MVAR and the same Transformer(s) &amp; Reactor(s) should have been in satisfactory operation# for atleast two (2) years as on the date of NOA.</p> <p>(ii) Alternatively, the manufacturer, who have established manufacturing and testing facilities in India and not meeting the requirement stipulated in (i) above, can also be considered provided that</p> <p style="margin-left: 40px;">a) 715 kV or higher voltage class either One (1) no. 1-phase Reactor of at least 80 MVAR capacity or One (1) no. 1-phase Transformer of at least 166 MVA capacity must have been manufactured in the above Indian works based on technological support of collaborator, type tested (as per IEC/IS standard) and same should have been supplied as on the date of NOA.</p> <p style="margin-left: 40px;">b) The collaborator meets the requirements stipulated in (i)</p>	
--	--	---	---	--

**SECTION-GENERAL TECHNICAL REQUIREMENTS (GTR)**

**ANNEXURE-L**

Major Changes in Section GTR ( Rev 15)

		<p><del>(iv) 715kV or higher voltage class one (1) number three phase Reactor of atleast 240MVAR capacity (or equivalent capacity in a bank of three (3) numbers single phase units) must have been manufactured in the above Indian works based on technological support of collaborator, type tested (as per IEC/IS standard) and supplied as on the date of NOA.</del></p> <p><del>(v) The collaborator meets the requirements stipulated in (i) above. A valid collaboration agreement for technology transfer/license to design, manufacture, test and supply 765kV Reactor in India, shall be submitted.</del></p> <p><del>(vi) the collaborator shall furnish performance guarantee for an amount of 10% of the ex works cost of such equipment(s) and this performance guarantee shall be in addition to contract performance guarantee to be submitted by the contractor.</del></p>	<p>above. A valid collaboration agreement for technology transfer/license to design, manufacture, test and supply 765kV Reactor in India, shall be submitted.</p> <p>c) the collaborator shall furnish performance guarantee for an amount of 3% of the ex-works cost of such equipment(s) and this performance guarantee shall be in addition to contract performance guarantee to be submitted by the contractor.</p>	
27.	Clause 24.4	<p><b>24.4 Technical Requirement for 400kV, 220kV, 132kV and 110kV class Transformer</b></p> <p>(i) The manufacturer whose transformer(s) are offered must have designed, manufactured, tested and supplied 400kV/220kV/132kV/110kV* or</p>	<p><b>24.4 Technical Requirement for 400kV, 220kV, 132kV and 110kV class Transformer</b></p> <p>(i) The manufacturer whose transformer(s) are offered must have designed, manufactured, tested and supplied transformers as per table below:</p>	

**SECTION-GENERAL TECHNICAL REQUIREMENTS (GTR)**

**ANNEXURE-L**

**Major Changes in Section GTR ( Rev 15)**

		<p>higher voltage class transformers. These Transformer(s) must have been in satisfactory operation# for atleast two (2) years as on the date of NOA.</p> <p>(ii) Alternatively, the manufacturer, who have established manufacturing and testing facilities in India and not meeting the requirement stipulated in (i) above, can also be considered provided that</p> <p>a) 220kV (applicable for supply of 400kV and 220kV class Transformer)/ 132kV (applicable for supply of 132kV &amp; 110kV class Transformer) or higher voltage class transformers must have been designed, manufactured in the above Indian works based on technological support of collaborator, type tested (as per IEC/IS standard) and supplied as on the date of NOA.</p> <p>b) The collaborator meets the requirements stipulated in (i) above. A valid collaboration agreement for technology transfer / license to design, manufacture, test and supply</p>	<table border="1" data-bbox="1077 304 1742 986"> <tr> <td data-bbox="1077 304 1462 544">345kV or above class 3-phase transformers of at least 200 MVA or at least three (3) nos. 1-phase Transformers each having capacity of at least 66.7 MVA</td> <td data-bbox="1462 304 1742 544">applicable for supply of 400kV class Transformer</td> </tr> <tr> <td data-bbox="1077 544 1462 746">220kV or above class 3-phase transformers of at least 50 MVA or at least three (3) nos. 1-phase Transformers each having capacity of at least 16.7 MVA</td> <td data-bbox="1462 544 1742 746">applicable for supply of 220kV class Transformer</td> </tr> <tr> <td data-bbox="1077 746 1462 986">commissioned 132kV or above class 3-phase transformers of at least 20 MVA or at least three (3) nos. 1-phase Transformers each having capacity of at least 6.7 MVA</td> <td data-bbox="1462 746 1742 986">applicable for supply of 132kV class Transformer</td> </tr> </table> <p>These Transformer(s) must have been in satisfactory operation# for atleast two (2) years as on the date of NOA.</p> <p>(ii) Alternatively, the manufacturer, who have established manufacturing and testing facilities in India and not meeting the</p>	345kV or above class 3-phase transformers of at least 200 MVA or at least three (3) nos. 1-phase Transformers each having capacity of at least 66.7 MVA	applicable for supply of 400kV class Transformer	220kV or above class 3-phase transformers of at least 50 MVA or at least three (3) nos. 1-phase Transformers each having capacity of at least 16.7 MVA	applicable for supply of 220kV class Transformer	commissioned 132kV or above class 3-phase transformers of at least 20 MVA or at least three (3) nos. 1-phase Transformers each having capacity of at least 6.7 MVA	applicable for supply of 132kV class Transformer	
345kV or above class 3-phase transformers of at least 200 MVA or at least three (3) nos. 1-phase Transformers each having capacity of at least 66.7 MVA	applicable for supply of 400kV class Transformer									
220kV or above class 3-phase transformers of at least 50 MVA or at least three (3) nos. 1-phase Transformers each having capacity of at least 16.7 MVA	applicable for supply of 220kV class Transformer									
commissioned 132kV or above class 3-phase transformers of at least 20 MVA or at least three (3) nos. 1-phase Transformers each having capacity of at least 6.7 MVA	applicable for supply of 132kV class Transformer									

**SECTION-GENERAL TECHNICAL REQUIREMENTS (GTR)**

ANNEXURE-L

Major Changes in Section GTR ( Rev 15)

		<p>400kV/220kV/132kV/110kV* transformer in India, shall be submitted.</p> <p>the collaborator shall furnish performance guarantee for an amount of 10% of the ex-works cost of such equipment(s) and this performance guarantee shall be in addition to contract performance guarantee to be submitted by the contractor.</p>	<p>requirement stipulated in (i) above, can also be considered provided that</p> <p>a) <b>220kV (applicable for supply of 400kV and 220kV class Transformer)/ 132kV (applicable for supply of 220kV class Transformer)/ 66kV (applicable for supply of 132kV class Transformer)</b> or higher voltage class transformers must have been designed, manufactured in the above Indian works based on technological support of collaborator, type tested (as per IEC/IS standard) and supplied as on the date of NOA.</p> <p>b) The collaborator meets the requirements stipulated in (i) above. A valid collaboration agreement for technology transfer / license to design, manufacture, test and supply 400kV/220kV/132kV/110kV* transformer in India, shall be submitted.</p> <p>the collaborator shall furnish performance guarantee for an amount <b>of 3%</b> of the ex-works cost of such equipment(s) and this performance guarantee shall be in addition to contract performance guarantee to be submitted by the contractor.</p>	
28.	<b>Clause 24.5</b>	<p><b>24.5 Technical Requirement for 400kV, 220kV and 132kV class Reactor</b></p> <p>(i) The Manufacturer whose 400kV/220kV/132kV* Reactor(s) are offered must have designed, manufactured, tested &amp; supplied</p>	<p><b>24.5 Technical Requirement for 400kV, 220kV and 132kV class Reactor</b></p> <p>(i) The Manufacturer whose 400kV/220kV/132kV* Reactor(s) are offered must have designed, manufactured, tested &amp; supplied Reactor as per table below:</p>	

**SECTION-GENERAL TECHNICAL REQUIREMENTS (GTR)****ANNEXURE-L****Major Changes in Section GTR ( Rev 15)**

		<p>400kV/220kV/132kV* or higher voltage class. These Reactor(s) must have been in satisfactory operation# for atleast two (2) years as on the date of NOA.</p> <p>(ii) Alternatively, the manufacturer, who have established manufacturing and testing facilities in India and not meeting the requirement stipulated in (i) above, can also be considered provided that</p> <p>a) Such manufacturer has designed, manufactured based on technological support of collaborator, type tested (as per IEC/IS standard) and supplied 400kV class transformer or 220kV or above class shunt reactors as on the date of NOA.</p> <p>b) The collaborator meets the requirements stipulated in (i) above. A valid collaboration agreement for technology transfer/license to design, manufacture, test and supply the</p>		<p>345kV or above class 3-phase shunt reactor of at least 50 MVAR capacity or at least three (3) nos. 1-phase Shunt Reactors, each having capacity of at least 16.7 MVAR</p> <p>220kV or above class 3-phase shunt reactor of at least 20 MVAR capacity or at least three (3) nos. 1-phase Shunt Reactors each having capacity of at least 6.67 MVAR</p> <p>132kV or above class 3-phase shunt reactor of at least 15 MVAR capacity or at least three (3) nos. 1-phase Shunt Reactors each having capacity of at least 5 MVAR</p> <p>These Reactor(s) must have been in satisfactory operation# for atleast two (2) years as on the date of NOA.</p> <p>(ii) Alternatively, the manufacturer, who have established manufacturing and testing facilities in India and not meeting the requirement stipulated</p>	<p>applicable for supply of 400kV class Reactors</p> <p>applicable for supply of 220kV class Transformer</p> <p>applicable for supply of 132kV class Transformer</p>	
--	--	--	--	---	--	--

**SECTION-GENERAL TECHNICAL REQUIREMENTS (GTR)****ANNEXURE-L**

## Major Changes in Section GTR ( Rev 15)

		<p>Reactor in India, shall be submitted.</p> <p>the collaborator shall furnish performance guarantee for an amount of 10% of the ex-works cost of such equipment(s) and this performance guarantee shall be in addition to contract performance guarantee to be submitted by the contractor.</p>	<p>in (i) above, can also be considered provided that</p> <p>a) Such manufacturer has designed, manufactured based on technological support of collaborator, type tested (as per IEC/IS standard) and supplied 400kV class transformer or 220kV or above class shunt reactors (applicable for supply of 400kV class Reactors) / 220kV class transformer or 132kV or above class shunt reactors (applicable for supply of 220kV class Reactors)/ 132kV class transformer or 66kV or above class shunt reactors (applicable for supply of 132kV class Reactors) as on the date of NOA.</p> <p>b) The collaborator meets the requirements stipulated in (i) above. A valid collaboration agreement for technology transfer/license to design, manufacture, test and supply the Reactor in India, shall be submitted.</p> <p>the collaborator shall furnish performance guarantee for an amount of 3% of the ex-works cost of such equipment(s) and this performance guarantee shall be in addition to contract performance guarantee to be submitted by the contractor.</p>	
29.	<b>Clause 24.6</b>	<p><b>24.6 Technical Requirement for 400 kV Grade XLPE Power Cables</b></p> <p>(i) The manufacturer(s) whose XLPE Power Cables are offered must have designed, manufactured, type tested and</p>	<p><b>24.6 Technical Requirement for 400 kV Grade XLPE Power Cables</b></p> <p>(i) The manufacturer(s) whose XLPE Power Cables are offered must have designed, manufactured, type tested and supplied in a single contract atleast 5 (five) km of single core, 400kV grade</p>	

**SECTION-GENERAL TECHNICAL REQUIREMENTS (GTR)**

**ANNEXURE-L**

Major Changes in Section GTR ( Rev 15)

		<p>supplied in a single contract atleast 5 (five) km of single core, 400kV grade XLPE insulated cable which must be in operation for atleast 2 (two) years as on the date of NOA.</p> <p>(ii) Alternatively, the manufacturer, who have established manufacturing and testing facilities in India and not meeting the requirement stipulated in (i) above, can also be considered provided that</p> <p>a) The manufacturer must have designed, manufactured, type tested and supplied 400kV grade XLPE insulated cable and which must be in satisfactory operation# for atleast one (1) year as on the date of NOA.</p> <p style="text-align: center;">OR</p> <p>b) The manufacturer must have designed, manufactured, type tested and completed Pre-qualification (PQ) tests as per IEC for 400kV grade XLPE insulated Cable as on the date of NOA.</p>	<p>XLPE insulated cable which must be in operation for atleast 2 (two) years as on the date of NOA.</p> <p>(ii) Alternatively, the manufacturer, who have established manufacturing and testing facilities in India and not meeting the requirement stipulated in (i) above, can also be considered provided that</p> <p>a) The manufacturer must have designed, manufactured, type tested and supplied 400kV grade XLPE insulated cable and which must be in satisfactory operation# for atleast one (1) year as on the date of NOA.</p> <p style="text-align: center;">OR</p> <p>b) The manufacturer must have designed, manufactured, type tested and completed Pre-qualification (PQ) tests as per IEC for 400kV grade XLPE insulated Cable as on the date of NOA.</p> <p><b>Note: In case manufacturer meets the technical requirement through clause (ii) above, warranty obligations for additional warranty of two(2) years over &amp; above the warranty period as specified in the bidding documents shall be applicable for the entire quantity of cable to supplied under the contract. Further, contractor shall furnish performance guarantee for an amount of 3% of the ex-works cost of the equipments(s)* and this performance guarantee shall be in addition to the contract performance guarantee to be submitted by the contractor.</b></p>	
30.	<b>Clause 24.7</b>	<b>24.7 Technical Requirement for 220KV Grade XLPE Power Cables</b>	<b>24.7 Technical Requirement for 220KV, 132KV,110KV Grade XLPE Power Cables</b>	

**SECTION-GENERAL TECHNICAL REQUIREMENTS (GTR)**

**ANNEXURE-L**

Major Changes in Section GTR ( Rev 15)

			<p>(i) The manufacturer(s) whose XLPE Power Cables are offered must have designed, manufactured, type tested and supplied in a single contract atleast 5 (five) km of single core, 220kV/<b>132kV/110kV*</b> or higher grade XLPE insulated cable which must be in operation for atleast 2 (two) years as on the date of NOA.</p> <p>(ii) Alternatively, the manufacturer, who have established manufacturing and testing facilities in India and not meeting the requirement stipulated in (i) above, can also be considered provided that</p> <p>a) The manufacturer must have designed, manufactured, type tested and supplied 220kV/<b>132kV/110kV*</b> or higher grade XLPE insulated cable and which must be in satisfactory operation# for atleast one (1) year as on the date of NOA.</p> <p style="text-align: center;">OR</p> <p>b) The manufacturer must have designed, manufactured, type tested and completed Pre-qualification (PQ) tests as per IEC for 220kV/<b>132kV/110kV*</b> or higher grade XLPE insulated Cable as on the date of NOA.</p> <p><b>Note: In case manufacturer meets the technical requirement through clause (ii) above, warranty obligations for additional warranty of two(2) years over &amp; above the warranty period as specified in the bidding documents shall be applicable for the</b></p>	
--	--	--	--	--

**SECTION-GENERAL TECHNICAL REQUIREMENTS (GTR)****ANNEXURE-L**

## Major Changes in Section GTR ( Rev 15)

			entire quantity of cable to supplied under the contract. Further, contractor shall furnish performance guarantee for an amount of 3% of the ex-works cost of the equipments(s)* and this performance guarantee shall be in addition to the contract performance guarantee to be submitted by the contractor.	
31.	Clause 24.8	<p><b>24.8 Technical Requirement for 132KV, 110kV, 66kV Grade XLPE Power Cables</b></p> <p>(i) The manufacturer(s) whose XLPE Power Cables are offered must have designed, manufactured, type tested and supplied in a single contract atleast 5 (five) km of single core, 132KV/110kV/66kV* or higher grade XLPE insulated cable which must be in satisfactory operation# for atleast two (2) years as on the date of NOA.</p> <p>(ii) Alternatively, the manufacturer, who have established manufacturing and testing facilities in India and not meeting the requirement stipulated in (i)above, can also be considered provided that</p>	<p><b>24.8 Technical Requirement for <del>132KV, 110kV</del>, 66kV Grade XLPE Power Cables</b></p> <p>(i) The manufacturer(s) whose XLPE Power Cables are offered must have designed, manufactured, type tested and supplied in a single contract atleast 5 (five) km of single core, <del>132KV/110kV</del>/66kV* or higher grade XLPE insulated cable which must be in satisfactory operation# for atleast two (2) years as on the date of NOA.</p> <p>Alternatively, the manufacturer, who have established manufacturing and testing facilities in India and not meeting the requirement stipulated in (i)above, can also be considered provided that the manufacturer must have designed, manufactured, type tested and supplied <del>132KV/110kV</del>/66kV* or higher grade XLPE insulated cable and which must be in satisfactory operation# for atleast one (1) year as on the date of NOA.</p>	

**SECTION-GENERAL TECHNICAL REQUIREMENTS (GTR)****ANNEXURE-L**

## Major Changes in Section GTR ( Rev 15)

		a) The manufacturer must have designed, manufactured, type tested and supplied 132KV/110kV/66kV* or higher grade XLPE insulated cable and which must be in satisfactory operation# for atleast one (1) year as on the date of NOA.		
32.	<b>Clause No. 24.9</b>	<b>Technical Requirement for 1.1 KV Grade PVC Control Cable</b>  The manufacturer(s), whose PVC control cables are offered, must have designed, manufactured, tested and supplied in a single contract atleast 100 Kms of 1.1kV grade PVC insulated control cables as on the originally scheduled date of bid opening. Further the manufacturer must also have designed, manufactured, tested and supplied atleast 1 km of 27C x 2.5 Sq.mm or higher size as on the date of NOA	<b>Technical Requirement for 1.1 KV Grade PVC Control Cable</b>  The manufacturer(s), whose PVC control cables are offered, must have designed, manufactured, tested and supplied in a single contract atleast 100 Kms of 1.1kV grade PVC insulated control cables as on <del>the originally scheduled date of bid opening</del> <b>the date of NOA</b> . Further the manufacturer must also have designed, manufactured, tested and supplied atleast 1 km of 27C x 2.5 Sq.mm or higher size as on the date of NOA	
33.	<b>Clause No. 24.10</b>	<b>Technical Requirement for 1.1 KV Grade PVC Power Cable</b>  The manufacturer(s), whose PVC Power Cables are offered, must have designed, manufactured, tested and supplied in a single contract atleast 100 Kms of 1.1kV or higher grade PVC insulated power cables as on the date of NOA/award. Further the manufacturer must also have designed, manufactured, tested and supplied atleast 1 km of 1C x 150 Sq. mm or higher size as on the date of NOA.	<b>Technical Requirement for 1.1 KV Grade PVC Power Cable</b>  The manufacturer(s), whose PVC Power Cables are offered, must have designed, manufactured, tested and supplied in a single contract atleast 100 Kms of 1.1kV or higher grade PVC insulated power cables as on the date of NOA/award. Further the manufacturer must also have designed, manufactured, tested and supplied atleast 1 km of 1C x 150 Sq. mm or higher size as on the date of NOA.	
34.	<b>Clause 24.15</b>	<b>24.15 Technical Requirements for LT</b>	<b>24.15 Technical Requirements for LT Transformer</b>	

**SECTION-GENERAL TECHNICAL REQUIREMENTS (GTR)****ANNEXURE-L****Major Changes in Section GTR ( Rev 15)**

		<p><b>Transformer</b></p> <p>i) The manufacturer, whose LT transformer(s) are offered, must have designed,manufactured, type tested including short circuit test as per IEC/IS or equivalent standards and supplied transformer(s) of atleast 33kV class of 630kVA or higher. The transformer must have been in satisfactory operation# for atleast two (2) years as on the date of NOA.</p> <p>ii) Alternatively, the manufacturer, who have established manufacturing and testing facilities in India and not meeting the requirement stipulated in (i) above, can also be considered provided that</p> <p>a) At least 33kV class of 630 kVA or higher rating LT transformer(s) must have been designed, manufactured in the above Indian works, type tested (as perIEC/IS standard) including short circuit test and supplied as on the date of NOA.</p> <p>b) the contractor shall furnish performance guarantee for an amount of 10% of the ex-works cost of the equipment(s) and this performance guarantee shall be in addition to contract performance guarantee to be submitted by the contractor.</p>	<p>i) The manufacturer, whose LT transformer(s) are offered, must have designed, manufactured, type tested including short circuit test as per IEC/IS or equivalent standards and supplied transformer(s) of atleast 33kV class of <del>630kVA</del> 315kVA or higher. The transformer must have been in satisfactory operation# for atleast two (2) years as on the date of NOA.</p> <p>ii) Alternatively, the manufacturer, who have established manufacturing and testing facilities in India and not meeting the requirement stipulated in (i) above, can also be considered provided that At least 33kV class of <del>630 kVA</del> 315kVA or higher-rating LT transformer(s) must have been designed, manufactured in the above Indian works, type tested (as perIEC/IS standard) including short circuit test and supplied as on the date of NOA.</p> <p>In case manufacturer meets the technical requirement through clause (ii) above, warranty obligations for additional warranty of two(2) years over &amp; above the warranty period as specified in the bidding documents shall be applicable for the entire quantity of the offered equipment to be supplied under the contract. Further, contractor shall furnish performance guarantee for an amount of 3% of the ex-works cost of the equipments(s)* for the additional warranty period in addition to the contract performance guarantee to be submitted by the contractor</p>	
35.	<b>Clause 24.16</b>	<p><b>24.16 Technical Requirements for Composite Long Rod Polymer Insulator (765kV &amp; 400kV)</b></p> <p>(i) The manufacturer whose Composite Long rod Insulator are</p>	<p><b>24.16 Technical Requirements for Composite Long Rod Polymer Insulator (765kV &amp; 400kV)</b></p> <p>(i) The manufacturer whose Composite Long rod Insulator are offered, must have designed, manufactured, tested and supplied Composite Long</p>	

**SECTION-GENERAL TECHNICAL REQUIREMENTS (GTR)**

**ANNEXURE-L**

Major Changes in Section GTR ( Rev 15)

		<p>offered, must have designed, manufactured, tested and supplied Composite Long rod Insulator of 120KN or higher electro-mechanical strength for 765kV/400kV* or higher voltage class and the same must have been in satisfactory operation# for atleast two (2) years as on the date of NOA.</p> <p>(ii) Alternatively, the manufacturer, who have established manufacturing and testing facilities in India and not meeting the requirement stipulated in (i) above, can also be considered provided that</p> <p>a) The manufacturer must have designed, manufactured, type tested and supplied Composite Long rod Insulator of 120KN or above electro-mechanical strength for 765kV/400kV* or higher voltage class and the same must have been in satisfactory operation# as on the date of NOA.</p>	<p>rod Insulator of 120KN or higher electro-mechanical strength for 765kV/400kV* or higher voltage class and the same must have been in satisfactory operation# for atleast two (2) years as on the date of NOA.</p> <p>(ii) Alternatively, the manufacturer, who have established manufacturing and testing facilities in India and not meeting the requirement stipulated in (i) above, can also be considered provided that</p> <p>a) The manufacturer must have designed, manufactured, type tested and supplied Composite Long rod Insulator of 120KN or above electro-mechanical strength for 765kV/400kV* or higher voltage class and the same must have been in satisfactory operation# as on the date of NOA.</p> <p>In case manufacturer meets the technical requirement through clause (ii) above, warranty obligations for additional warranty of two(2) years over &amp; above the warranty period as specified in the bidding documents shall be applicable for the entire quantity of the offered equipment to be supplied under the contract. Further, contractor shall furnish performance guarantee for an amount of 3% of the ex-works cost of the equipments(s)* for the additional warranty period in addition to the contract performance guarantee to be submitted by the contractor.</p>	
--	--	--	--	--

**SECTION-GENERAL TECHNICAL REQUIREMENTS (GTR)****ANNEXURE-L**

## Major Changes in Section GTR ( Rev 15)

		Contractor shall furnish performance guarantee for an amount of 10% of the exworks cost of the equipments(s)* and this performance guarantee shall be in addition to the contract performance guarantee to be submitted by the contractor		
36.	<b>Clause 24.19</b>	<p><b>24.19 Technical Requirement of Communication Equipment</b></p> <p><del>The SDH equipment shall be offered from a manufacturer(s) who has been manufacturing SDH equipments for the last three (3) years and SDH equipment manufactured by such manufacturer(s) shall have been satisfactory operation in 110kV or higher voltage Power Substations for at least two (2) years as on the date of NOA.</del></p>	<p><b>24.19 Technical Requirement of Communication Equipment</b></p> <p>The SDH equipment shall be offered from a manufacturer(s) who is a <b>“Local Supplier”</b> as per DPIIT PP notification &amp; has been Manufacturing SDH equipments for the last three (3) years and SDH equipment Manufactured by such manufacturer(s) shall have been satisfactory operation in 110kV or higher voltage Power Substations for at least two (2) years as on the date of NOA</p>	
37.	<b>Clause 24.20</b>	<p><b>24.20 Technical Requirement of “Indian Associate” for execution of on shore supply and services for 765 kV Transformer &amp; Reactor package</b></p> <p>Indian associate must have erected at least two (2) or more circuit breaker equipped bays of 345 kV or above voltage level or at least two (2) nos. of 345 kV or above voltage class transformer/reactor; during last seven (7) years and above bays/transformer/reactors must be in satisfactory operation# as on the date of NOA</p>	.	Clause Deleted
38.	<b>Clause 24.20</b>		<b>24.20 Technical Requirement for 400kV GIS Equipment</b>	New Clause added

**SECTION-GENERAL TECHNICAL REQUIREMENTS (GTR)**

**ANNEXURE-L**

Major Changes in Section GTR ( Rev 15)

			<p>(i) The manufacturer whose 400kV GIS bays are offered must have designed, manufactured, type tested** (as per IEC or equivalent standard), supplied and supervised erection &amp; commissioning of at least two (2) nos. Gas Insulated Switchgear (GIS) circuit breaker bays@ of 345kV or above voltage class in one (1) Substation or Switchyard during the last seven (7) years and these bays must be in satisfactory operation# for at least two (2) years as on the date of NOA.</p> <p>(ii) Alternatively, the manufacturer, who have established manufacturing and testing facilities in India and not meeting the requirement stipulated in (i) above, can also be considered provided that</p> <p>a) Atleast one no. 345kV or above voltage class GIS Circuit Breaker bay@ must have been manufactured in the above Indian works based on the technological support of the Collaborator(s) and either supplied or type tested the above CB bay (as per IEC or equivalent standard) as on the date of NOA.</p> <p>b) The collaborator(s) meets the requirements stipulated in (i) above. A valid collaboration agreement for technology transfer / license to design, manufacture, test and supply 400kV or above voltage level GIS equipment in India, shall be submitted.</p> <p>c) The Collaborator(s) shall furnish performance guarantee for an amount of 3 % of the ex-works cost of such equipment(s) and this performance guarantee shall be in addition to Contract Performance Guarantee to be submitted by the bidder.</p>	
--	--	--	--	--

**SECTION-GENERAL TECHNICAL REQUIREMENTS (GTR)**

**ANNEXURE-L**

Major Changes in Section GTR ( Rev 15)

			<p>Note :-</p> <p>(**) Type test reports of the collaborator/ parent company/ subsidiary company/ group company shall also be acceptable</p>	
39.	Clause 25.0		<p><b>25.0 Technical Requirement of Sub-contractors:</b></p> <p>The sub-contractor must have either of the following experience of having successfully completed similar works during last 7 years as on the last day of month previous to the one in which the sub-contractor is proposed to be engaged:</p> <p>a) Three similar works costing not less than the amount equal to 40% of the cost of the work to be sub-contracted.</p> <p style="text-align: center;"><b>OR</b></p> <p>b) Two similar works costing not less than the amount equal to 50% of the cost of the work to be sub-contracted.</p> <p style="text-align: center;"><b>OR</b></p> <p>c) One similar work costing not less than the amount equal to 80% of the cost of the work to be sub-contracted.</p> <p>1. Minimum Average Annual Turnover <b>** (MAAT)</b></p>	New Clause added

**SECTION-GENERAL TECHNICAL REQUIREMENTS (GTR)**

ANNEXURE-L

Major Changes in Section GTR ( Rev 15)

			<p>for best three years i.e. 36 months out of last five financial years of the sub-contractor should be.....:</p> <p><b>**Annual Gross Revenue from operations/ Gross operating income as incorporated in the profit &amp; loss account excluding Other Income.</b></p> <p><b>Note:</b></p> <p>a) Similar work shall mean the work which are of similar in nature to the work to be sub-contracted e.g. for the scope of civil work to be sub-contracted, the experience should be of civil work.</p> <p>b) The aforesaid qualifying requirement shall however, not be applicable for engaging labour as per extant policy.</p> <p>c) The cost of the work to be sub-contracted shall be considered as available in the Contract Agreement. However, if the value is not available in the Contract Agreement, the same shall be the estimated value for such work.</p> <p>d) The above criteria is in addition to extant policy on selection of sub-contractor as per WPPP, Vol-II.</p> <p>e) The MAAT requirement shall be worked out basis the following formula:</p>	
--	--	--	---	--

**SECTION-GENERAL TECHNICAL REQUIREMENTS (GTR)**

ANNEXURE-L

Major Changes in Section GTR ( Rev 15)

			Minimum Annual Turnover (MAAT)	Average =	Cost of the work contractedx1.5/years**	work to be completed in period	sum																
			**The completion period shall be considered as 1 year even if the same is less than 1 year.																				
40.			<p><b>26.0 Technical Requirement of Sub-contractors of GIS Packages</b></p> <p>In case of GIS is supplied from Indian GIS manufacturer, the erection, testing &amp; commissioning of GIS shall be executed either by the bidder himself or by the Subcontractor meeting the following technical requirement:</p> <p>The bidder/Subcontractor must have erected, tested and commissioned at least two (2) nos. GIS/AIS Circuit breaker equipped bays@ of voltage class** as specified below or higher in one (1) substation or switchyard during the last seven (7) years and these bays must be in satisfactory operation# as on the date of NOA.</p> <table border="1"> <thead> <tr> <th>S. no</th> <th>Voltage class of GIS Package</th> <th>Minimum Voltage class Circuit Breaker Equipped of Bay(**)</th> </tr> </thead> <tbody> <tr> <td>1</td> <td>765kV &amp; 400kV GIS</td> <td>345kV</td> </tr> <tr> <td>2</td> <td>220kV</td> <td>220kV</td> </tr> <tr> <td>3</td> <td>132kV</td> <td>110kV</td> </tr> <tr> <td>4</td> <td>66kV</td> <td>66kV</td> </tr> </tbody> </table>					S. no	Voltage class of GIS Package	Minimum Voltage class Circuit Breaker Equipped of Bay(**)	1	765kV & 400kV GIS	345kV	2	220kV	220kV	3	132kV	110kV	4	66kV	66kV	New Clause added
S. no	Voltage class of GIS Package	Minimum Voltage class Circuit Breaker Equipped of Bay(**)																					
1	765kV & 400kV GIS	345kV																					
2	220kV	220kV																					
3	132kV	110kV																					
4	66kV	66kV																					

**SECTION-GENERAL TECHNICAL REQUIREMENTS (GTR)****ANNEXURE-L**

## Major Changes in Section GTR ( Rev 15)

			<p>Further, the sub-contractor shall also meet the requirement specified at Clause No. 25.0 of this section.</p> <p><b>Note:</b></p> <p>1. (@) For the purpose of technical requirement, one no. of circuit breaker bay shall be considered as a bay used for controlling a line or a transformer or a reactor or a bus section or a bus coupler and comprising of at least one circuit breaker, one disconnecter and three nos. of single phase CTs / Bushing CTs. GIS means SF6 Gas insulated Switchgear. AIS Means Air Insulated Switchgear.</p> <p>2. # satisfactory operation means certificate issued by the Owner/Utility certifying the operation without any adverse remark.</p>	
41.	<b>Section GTR Rev 14 Annexure-A</b>	Annex-A: Corona and Radio Interface Voltage(RIV) Test		Annexure updated
42.	<b>Section GTR Rev 14 Para-1 at Annexure-B</b>		<p>“The seismic withstanding test on the complete equipment (for 400kV and above) shall be carried out along with supporting structure. Seismic Withstand Test carried out using either lattice or pipe structure is acceptable.”</p> <p><b>Seismic Calculations certified by NABL Labs shall also be acceptable</b></p>	Annexure updated
43.	<b>Annexure-D</b>	List of General Standard/Document for second advance		The Annexure is updated with incorporation of requirement for GIS & EHV cables (

**SECTION-GENERAL TECHNICAL REQUIREMENTS (GTR)****ANNEXURE-L**

## Major Changes in Section GTR ( Rev 15)

				above 132kV)
44.	<b>Annexure F</b>	Assessment report from main Contractor for proposed sub vendors list of enclosure		The Annexure is updated
45.	<b>Annexure-G</b>	MOP & Inspection Level Requirement		The Annexure is updated
46.	<b>Section GTR Rev 14 Annexure-H</b>	Annex-H:RTV Silicon high voltage insulation coating(HVIC)		Annexure updated
47.	<b>Annexure J</b>		List of make for which type test reports are not required	The New Annexure is added
48.	<b>Annexure K</b>		List of Equipment's to be supplied from domestic manufacture only	The New annexure added

Note: The details mentioned in this annexure are only for the purpose of identification of changes in this revision of Technical Specification only, how ever details mentioned at respective clause shall be referred for execution purpose.

**SECTION - 4**

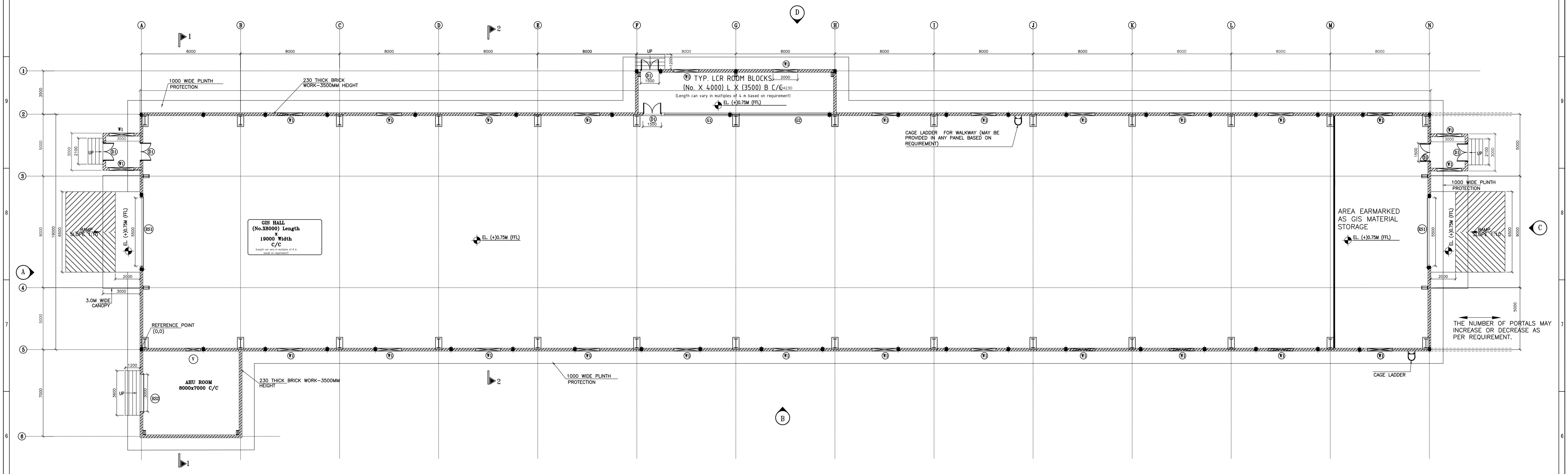

**FLOOR PLAN**

**NOTES:**

1. ALL DIMENSIONS ARE IN MILLIMETERS.
2. ONLY WRITTEN DIMENSIONS SHALL BE FOLLOWED. DO NOT SCALE THE DRAWING.
3. ALL DIMENSIONS SHALL BE CHECKED PRIOR TO EXECUTION OF THE WORK.
4. GIS HALL SHALL BE MADE IN MODULAR SIZE OF 8(L)x19(W) METER. THE NUMBER OF PORTALS MAY INCREASE OR DECREASE AS PER REQUIREMENT.
5. LCR ROOM TO BE MADE IN MODULAR SIZE OF 4(L)x3.5(W) METER AND SHALL BE PLACED SUITABLY AS PER REQUIREMENT OF LAYOUT( PREFERABLY AT CENTER OF GIS HALL). IF LENGTH IS TO BE INCREASED COLUMNS SHALL BE ADDED AT DISTANCE OF 3.0M EACH.
6. AHU ROOM TO BE MADE IN BLOCK SIZE OF 8(L)x7(W) METER AND SHALL BE PLACED AT CORNER OF GIS HALL. INCASE MORE THAN ONE AHU ROOM ARE REQUIRED SAME SHALL BE PLACED ON SAME SIDE OF GIS HALL.
7. CLEAR INTERNAL HEIGHT OF THE BUILDING FROM FFL SHALL BE 16.5 METER
8. NO CROSS BRACING SHALL BE PROVIDED BETWEEN HEIGHT OF 2.5 METER TO 7 MTR HEIGHT FROM FFL.
9. REFERENCE COORDINATE (0,0) MARKED IN THIS DRAWING. THIS SHALL USED TO FREEZE THE REFERENCE POINT OF GIS EQUIPMENT.
10. BUILDING PLINTH SHALL BE MINIMUM 750MM ABOVE FINISHED GROUND LEVEL.
11. FOR LOCATION AND SIZE OF COLUMNS AND PEDESTALS, REFER STRUCTURAL DRAWING.
12. FOR FINISHING SCHEDULE, DOOR, WINDOW AND VENTILATOR DETAILS SHALL BE SUBMITTED SEPARATELY
13. ALL EXTERIOR AND INTERIOR WALLS WILL BE OF 230MM THICK BRICK MASONRY
14. ALL THE BRICK WORK SHALL BE DONE IN BRICK MASONRY WITH 1:6 CM.
15. ALL DRAWING SHALL BE COORDINATED WITH OTHER RELATED DRAWINGS OF STRUCTURAL, HVAC, FIRE FIGHTING AND ELECTRICAL ETC.
16. BRACED BAY & WALL LIGHTS SHOWN IN THIS DRAWING ARE TENTATIVE ONLY. FOR DETAILS REFER STRUCTURAL DRAWING.
17. ROLLING SHUTTER RS1 CAN BE PLACED IN GRIDS 2-3,3-4,4-5,A-B ON EITHER SIDE AS DECIDED DURING DETAILED ENGINEERING. THE LOCATION OF DOORS/WINDOWS SHALL BE INTERCHANGED ACCORDINGLY.
18. AHU ROOM SHALL NOT BE CONSTRUCTED IF IT IS NOT IN THE BPS.
19. EOT CRANE HOOK BLIND ZONE ALONG CROSS TRAVEL SHALL NOT BE MORE THAN 1200 MM.
20. DUCT SEALING ARRANGEMENT SHALL BE PROVIDED BY THE PEB VENDOR

21. THIS DRAWING SHOWS MODULAR ARRANGEMENT OF GIS HALL AND LCR ROOM. IF LENGTH IS INCREASED IN THESE AREAS THEN THE WINDOWS/VENTILATORS/SKYLIGHTS SHALL BE ADDED IN THE SAME PATTERN AS SHOWN IN THE DRAWING.
22. CAGE LADDER LOCATION SHOWN HERE IS TENTATIVE. THE SAME SHALL BE FINALIZED IN THE STRUCTURAL DRAWING BASED ON OPERATIONAL REQUIREMENT.
23. GIS STORE:  
AREA FOR GIS STORE SHALL BE PROVIDED AT THE END OF THE GIS HALL AS SHOWN. THE AREA DESIGNATED FOR THE STORE SHALL BE SAME AS SHOWN IN THE DRAWING I.E. 8MX19M. CRANE FROM THE GIS HALL SHALL RUN INTO THE GIS STORE AREA ALSO.

**LEGEND:-**

- FFL - FINISHED FLOOR LEVEL
- FGL - FINISHED GROUND LEVEL
- TYP - TYPICAL
- FC - FALSE CEILING
- G - GLAZED PARTITION
- W - WINDOW
- V - VENTILATOR
- D - DOOR
- RS - ROLLING SHUTTER
- ▨ - 230MM THK. BLOCK WALL

RELEASED FOR CONSTRUCTION

1.	R0	21.02.2025	--
No.	Rev. No.	Date	Remarks
			
PROJECT:- SUB-STATION PACKAGE 765/400 kV			
TITLE : STANDARD 765 kV GIS BUILDING ARCHITECTURAL DRAWING (PLAN)			
DRAWING No.- C/ENGG/CIVIL/765KV/GIS/ ARCH/DRW/01			
SCALE	Sheet	REVISION	
N.T.S.	1 OF 3	0	

PREP.	REVD.	REVD. (ELEC.)	REVD.	APPD.	DATE
-------	-------	---------------	-------	-------	------

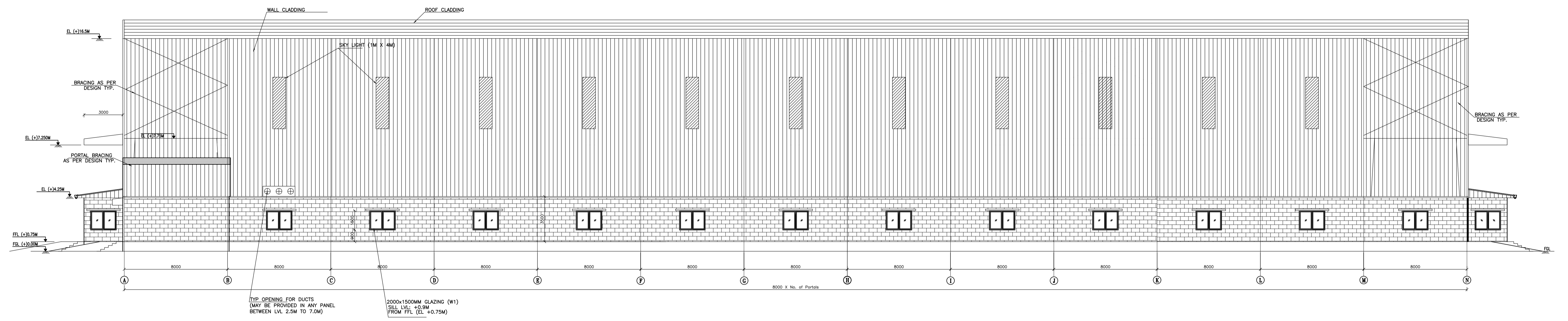

ELEVATION -B

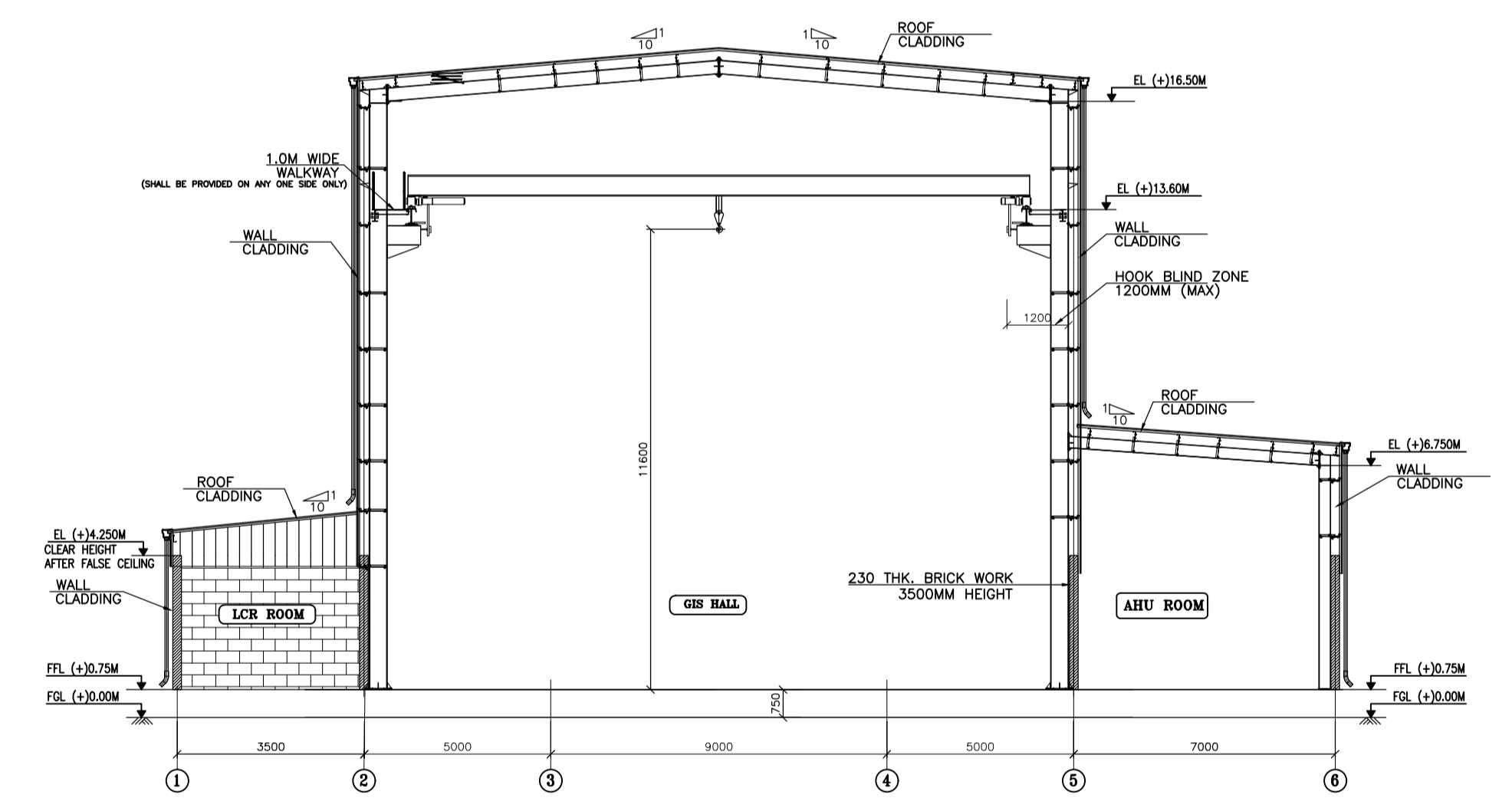

SECTION 1-1

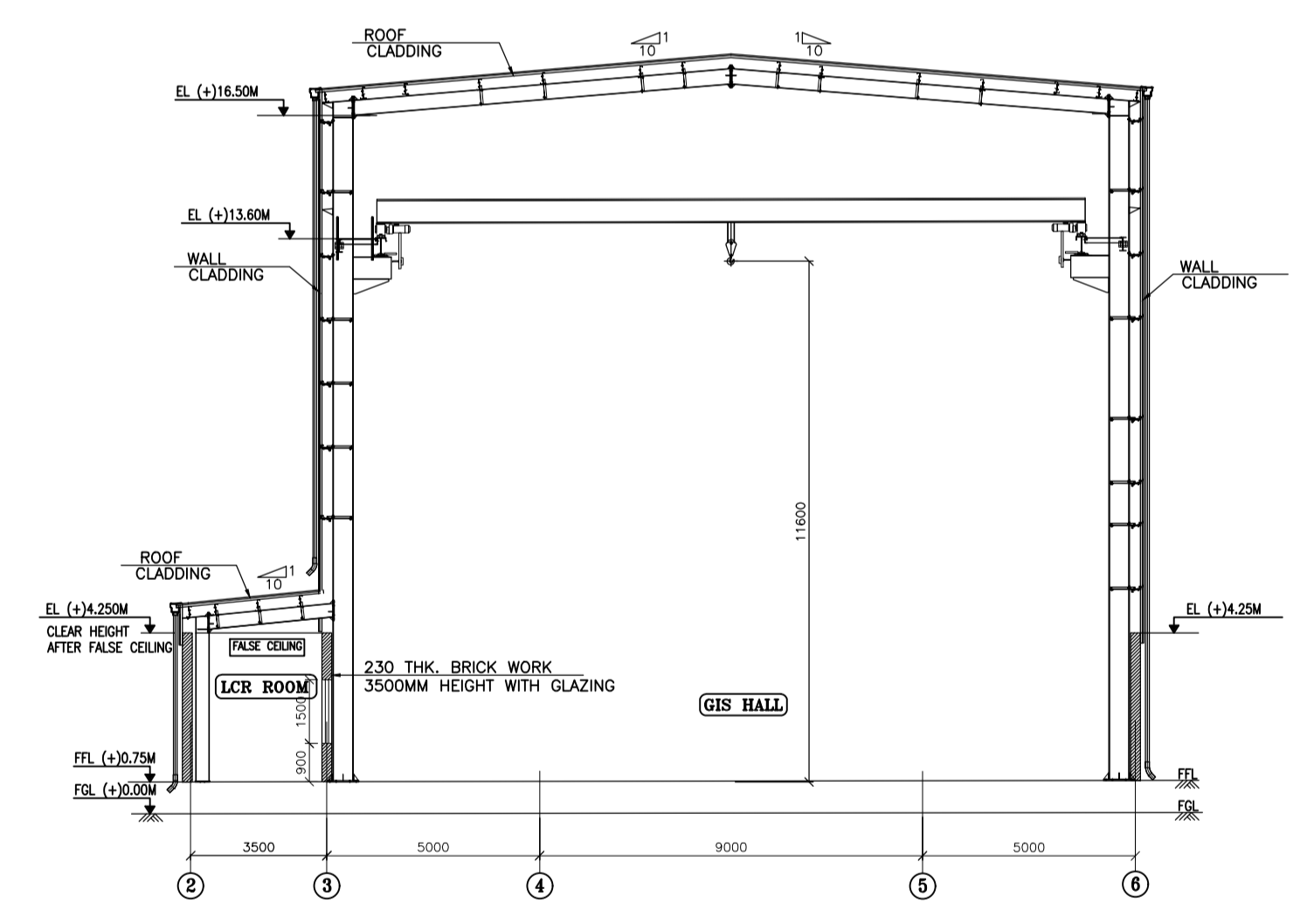

SECTION 2-2

RELEASED FOR CONSTRUCTION

No.	Rev. No.	Date	Remarks
1.	R0	21.02.2025	--



PROJECT:-  
SUB-STATION PACKAGE  
765/400 kV

TITLE :  
STANDARD 765 kV GIS  
BUILDING ARCHITECTURAL  
DRAWING (ELEVATION &  
SECTIONS)

DRAWING No.-  
C/ENGG/CIVIL/765KV/GIS/  
ARCH/DRW/01

PREP.	REVD.	REVD. (ELEC.)	REVD.	APPD.	DATE

SCALE	Sheet	REVISION
N.T.S.	1 OF 3	0

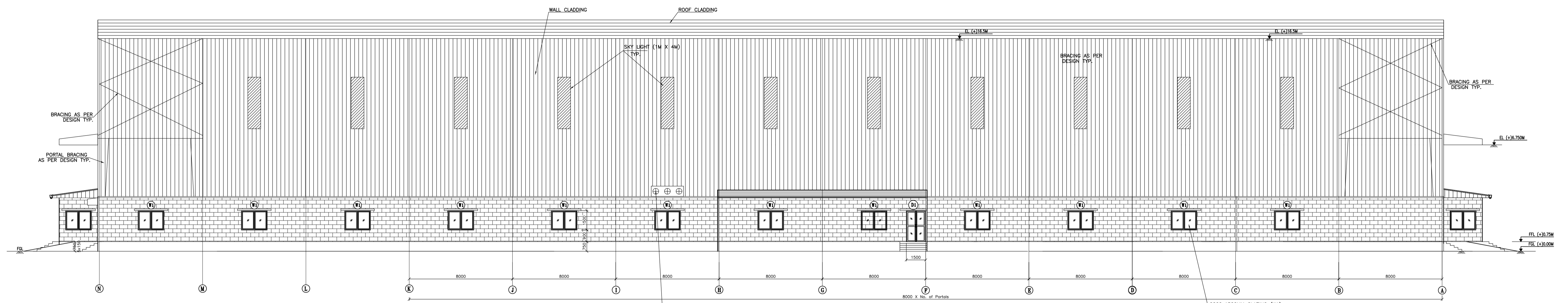

ELEVATION -D

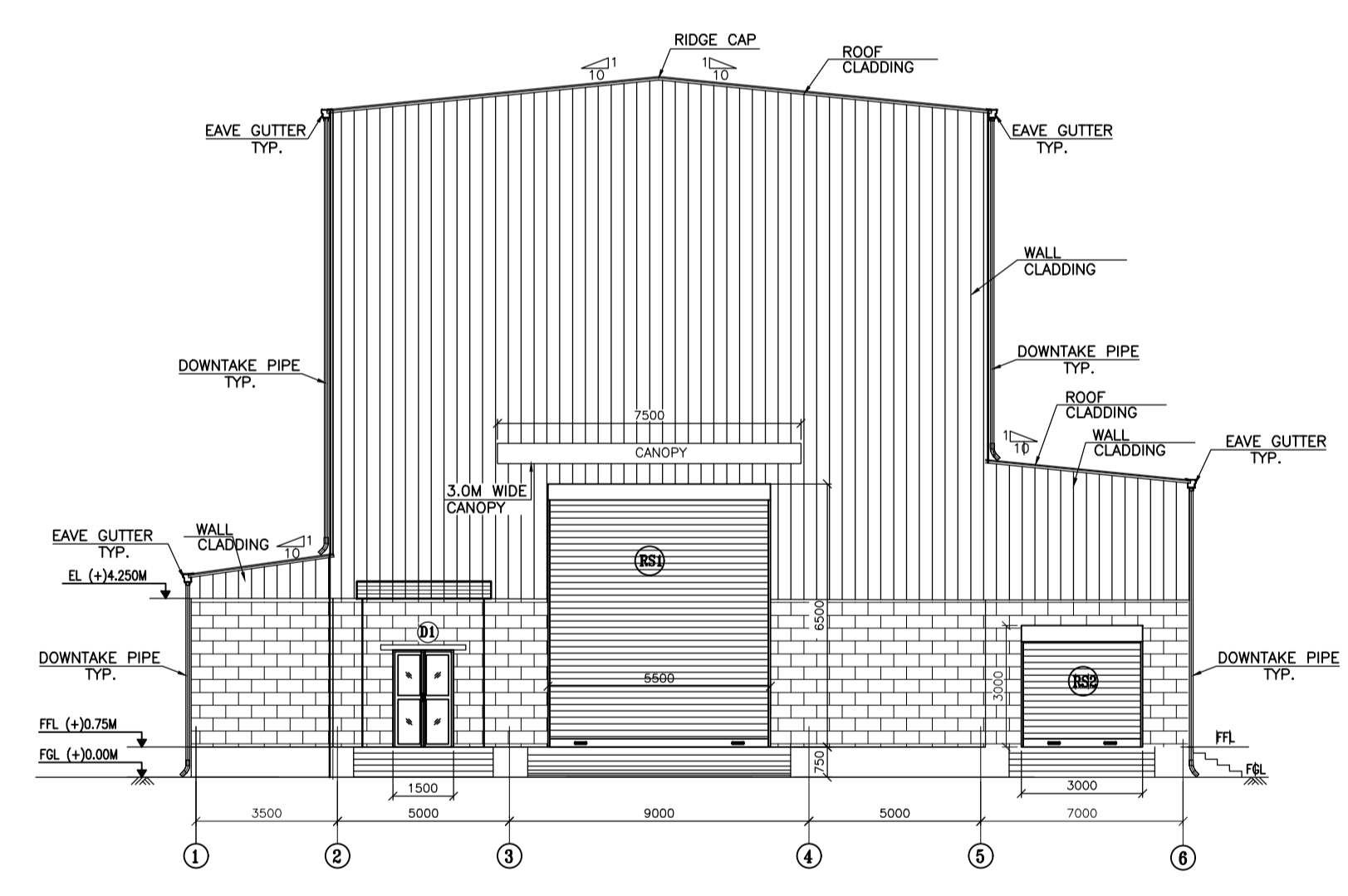

ELEVATION -A

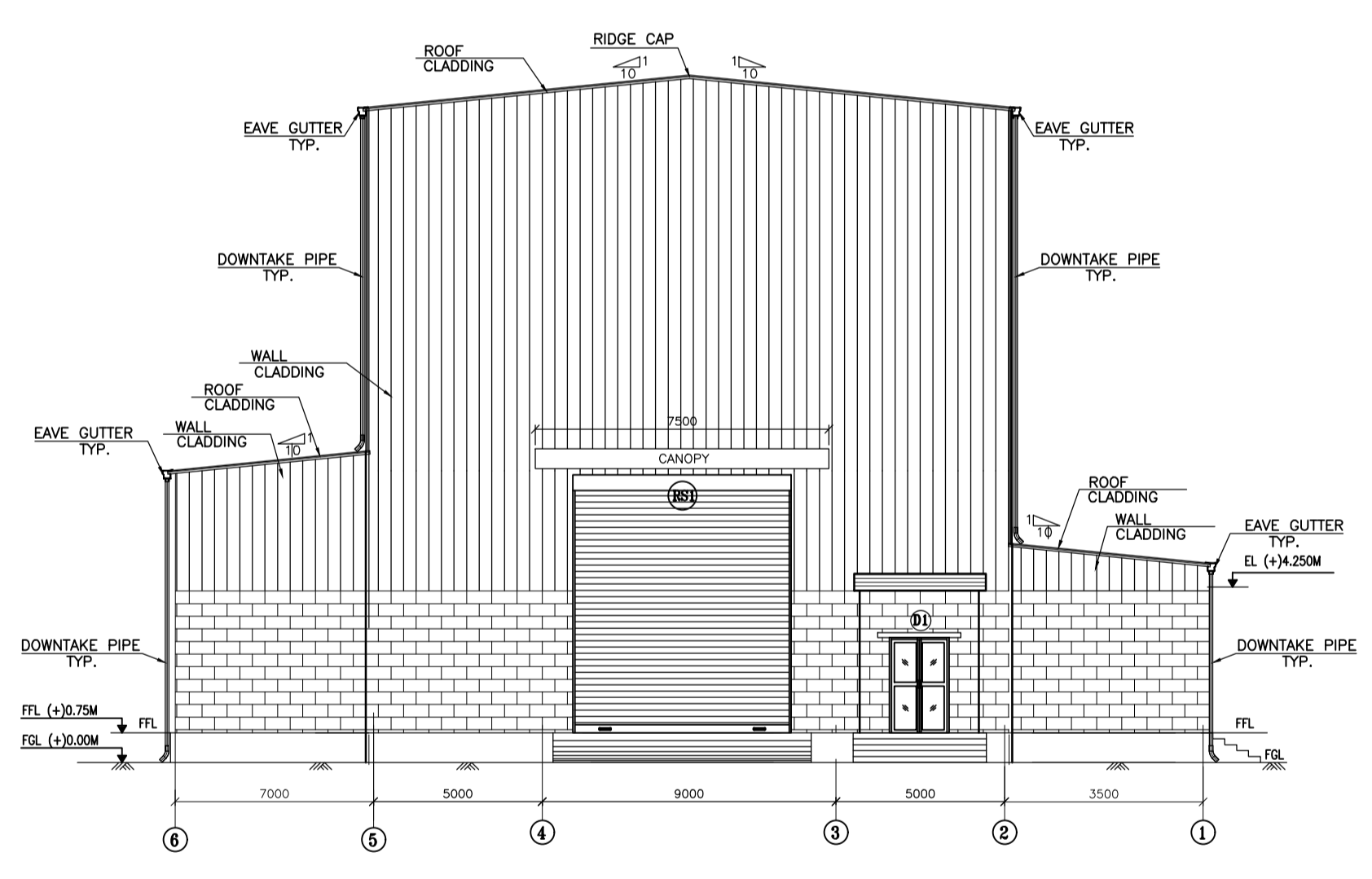

ELEVATION -C

RELEASED FOR CONSTRUCTION

No.	Rev. No.	Date	Remarks
1.	R0	21.02.2025	--



PROJECT:-  
SUB-STATION PACKAGE  
765/400 kV

TITLE :  
STANDARD 765 kV GIS  
BUILDING ARCHITECTURAL  
DRAWING (ELEVATION &  
SECTIONS)

DRAWING No.-  
C/ENGG/CIVIL/765KV/GIS/  
ARCH/DRW/01

PREP.	REVD.	REVD. (ELEC.)	REVD.	APPD.	DATE

SCALE	Sheet	REVISION
N.T.S.	1 OF 3	0

## Technical Specification for Scissor Man Lift

### 1. General:

The specification is intended to provide the technical requirement of scissor man lift designed for vertical elevation of personnel and equipment in Gas Insulated Substations (GIS) near Indoor and outdoor GIS and GIB installation. The scissor man lift shall be of reputed Indian make with service support available in India.

The scope of supply includes design, engineering, manufacturing, testing, inspection, packing, forwarding, delivery on FOR destination basis, assembly of parts at site (if required), other services required for successful commissioning, demonstration, and training (at site) of scissor man lift compliance to this technical specification.

### 2. Technical Requirement:

S.No.	Description	Parameter
1.	Minimum load capacity	300 Kg for 765kV
2.	Minimum attainable platform height	7.5 meter for 765kV
3.	Power Source	<ul style="list-style-type: none"> <li>Electrically powered, Battery-operated.</li> <li>Provision for both AC and DC power input.</li> <li>Provided with in-built automatic charger suitable for Single phase 230/240VAC, 50Hz or 3- phase, 415V, 50Hz AC supply</li> </ul>
4.	Lifting Mechanism	Hydraulic Scissors Type.
5.	Mobility	Self-propelled with variable speed control.
6.	Continues operation time	12 hours on a single charge.
7.	Drive In Raised Condition	Facility to drive in Raised Conditions
8.	Maximum drive speed (stowed) Maximum drive speed (raised)	4.0 km/h 0.8 km/h
9.	Terrain capabilities	Inside GIS building and outdoor switchyard.
10.	Platform Size	Minimum platform dimensions: 1.5m x 0.5m. (LXW) Scissor Man Lift shall accommodate at least two persons along with tools, facilitating maintenance and inspection activities of GIS installation. Platform shall be Basket Type with handrail.
11.	Platform Extension	Extendable platform for increased workspace to facilitates access to GIS components. Minimum horizontal extension outreach should be 0.90 Meters
12.	Applicable Standard	Scissor Man Lift should comply with the international standards (BS EN 280 or EN 280 OR ANSI or any other applicable standards of country of origin)

<p>13.</p>	<p>Safety Features (Minimum)</p>	<ul style="list-style-type: none"> <li>• Emergency stop button with instantaneous cut-off for all power sources.</li> <li>• Overload protection to prevent strain on the lift mechanism.</li> <li>• Safety railing around the platform with a self-closing gate, meeting the height and strength requirements for GIS environments.</li> <li>• Audible and visual alarms for movement and height limits.</li> <li>• Non-marking tires designed to protect the flooring in indoor GIS areas.</li> <li>• Elevated platform shall be provided with tilt monitoring system and slope monitoring system with safety shutdown feature.</li> <li>• Battery main switch shall be provided on the chassis for emergency switch OFF of the power supply.</li> </ul>
<p>14.</p>	<p>Controls</p>	<ul style="list-style-type: none"> <li>• Joystick controls for precise movement, allowing operators to navigate through confined spaces in GIS Hall and switchyards.</li> <li>• Emergency descent mechanism in case of power failure, ensuring a safe return to ground level.</li> <li>• Control panel with clear indicators for battery status, elevation height, and system faults.</li> <li>• The Scissor Man Lift shall be suitable for reaching elevated equipment in GIS and switchyard installations and shall be provided with specialized features for working on GIS structures, ensuring precise positioning near equipment.</li> </ul>
<p>15.</p>	<p>Material and Construction:</p>	<ul style="list-style-type: none"> <li>• Corrosion-resistant materials, especially suited for corrosive atmosphere.</li> <li>• Robust and durable steel structure to withstand the rigors of EHV Substation maintenance.</li> <li>• Platform floor with an anti-slip surface for safety during operation.</li> <li>• It shall be possible to work at the rated heights up to rated capacity without “out-riggers”. If the outriggers are provided, the chassis dimension shall not exceed the dimensions provided in the above specifications.</li> </ul>
<p>16.</p>	<p>Operational Environment</p>	<ul style="list-style-type: none"> <li>• Temperature range: -10°C to 50°C, suitable for the diverse climate conditions experienced in India.</li> <li>• Weatherproofing for outdoor use, ensuring reliable operation during adverse weather conditions.</li> <li>• Suitable for use in dusty or mildly corrosive environments.</li> </ul>

17.	Maintenance and Serviceability	<ul style="list-style-type: none"><li>• Easy access panels for routine maintenance.</li><li>• Comprehensive user manual with maintenance schedule and guidelines.</li><li>• Commissioning of the Equipment at Site, initial one-time training to users and first year complete maintenance shall deemed to be included.</li></ul>
-----	--------------------------------	---

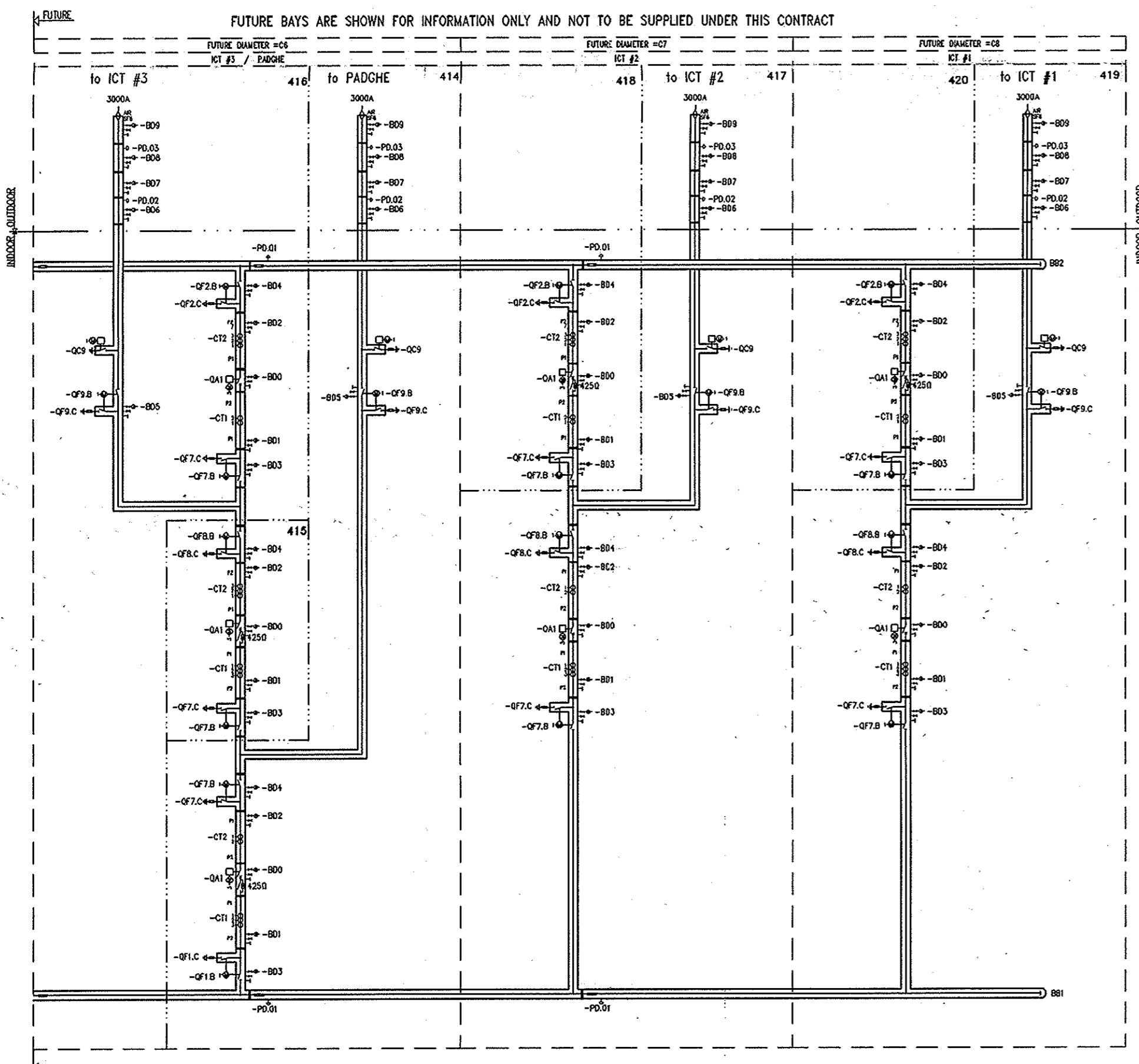
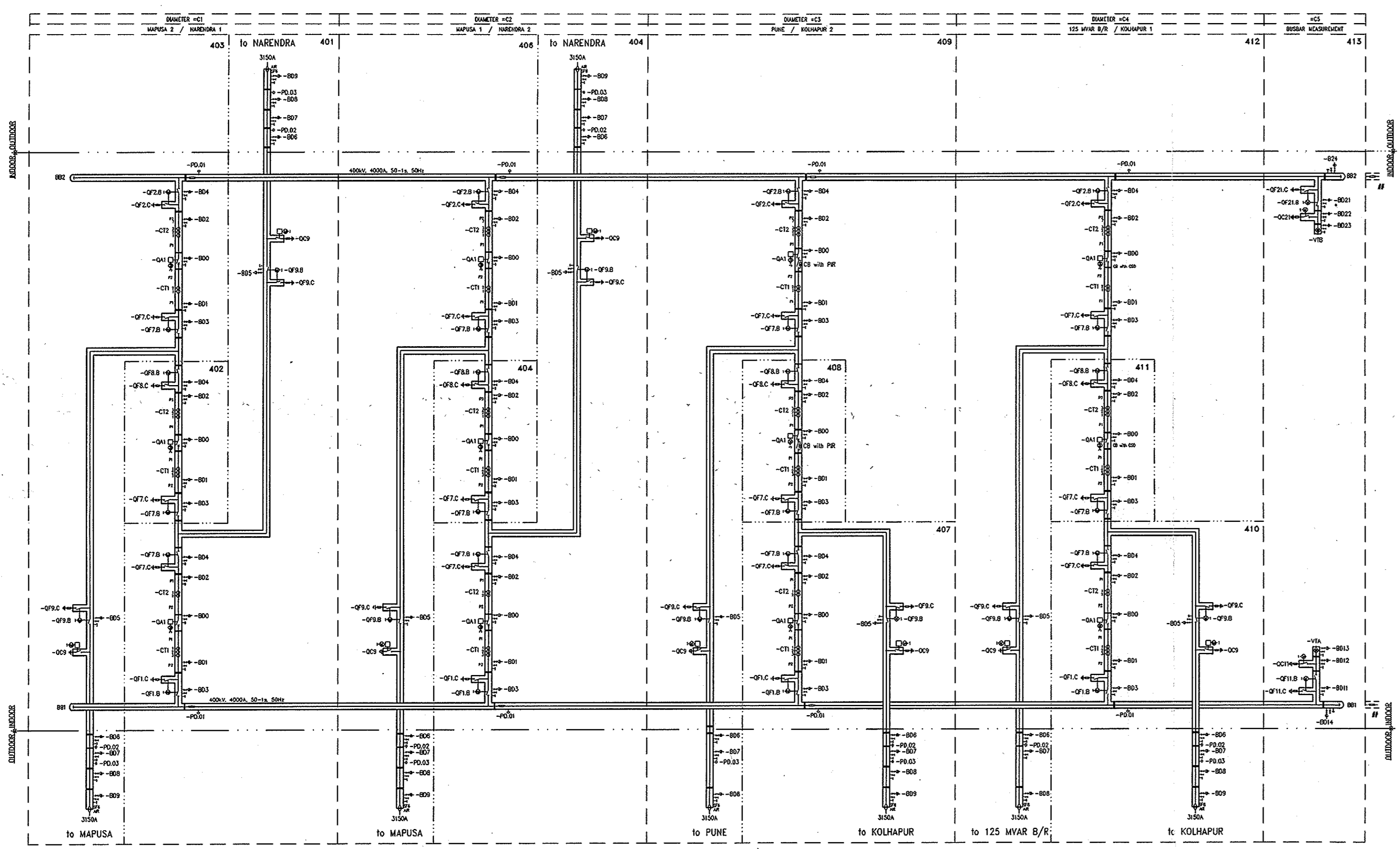

### LEGEND/BILL OF QUANTITY

	CIRCUIT BREAKER, ELK-SP3 / OPERATING MECHANISM, ELK-HMB4 (3 MOTORS FOR 3 PHASES)	30/30
	CIRCUIT BREAKER WITH CLOSING RESISTOR, ELK-SP3CR / OPERATING MECHANISM, ELK-HMB8 (3 MOTORS FOR 3 PHASES)	06/06
	DISCONNECTOR/EARTHING SWITCH WITH 10KV INSULATION, ELK-TK3 / OPERATING MECHANISM, ELK-BAC (1 MOTOR FOR 3 PHASES)	102/34
	MAINTENANCE EARTHING SWITCH WITH 10KV INSULATION, ELK-TK3 / OPERATING MECHANISM, ELK-BAC (1 MOTOR FOR 3 PHASES)	06/02
	HIGH SPEED EARTHING SWITCH WITH 10KV INSULATION, ELK-EB3 / OPERATING MECHANISM, ELK-BAE (1 MOTOR / 3 CLOSING SPRINGS FOR 3 PHASES)	24/08
	CURRENT TRANSFORMER, ELK-CN3	72
	VOLTAGE TRANSFORMER, ELK-PI3	06
	SF6/AIR BUSHING, ELK-H...3	24
	END COVER, ELK-ZX3	12
	REMOVABLE LINK / LATERAL DISMANTLING PIECE, ELK-V03	18
	BARRIER INSULATOR, ELK-...3	316
	DENSITY MONITOR WITH OPEN RETURN VALVE	316
	SF6 CONNECTION WITH CLOSED RETURN VALVE	316
	PRESSURE RELIEF DEVICE WITH ADSORBENT	316
	PARTIAL DISCHARGE SENSOR; NOT MONITORED FOR SENSITIVITY CHECK ONLY	42

	BARRIER INSULATOR, ELK-...3	316
	DENSITY MONITOR WITH OPEN RETURN VALVE	316
	SF6 CONNECTION WITH CLOSED RETURN VALVE	316
	PRESSURE RELIEF DEVICE WITH ADSORBENT	316
	PARTIAL DISCHARGE SENSOR; NOT MONITORED FOR SENSITIVITY CHECK ONLY	42

### NOTES

NO	DESCRIPTION
1	ALL CIRCUIT BREAKERS ARE EQUIPPED WITH 3 DRIVES FOR 3 PHASES
2	ALL DISCONNECTORS AND ALL EARTHING SWITCHES ARE EQUIPPED WITH 1 DRIVE FOR 3 PHASES
3	EACH GAS COMPARTMENT IS EQUIPPED WITH ONE GAS VALVE, ONE DENSITY MONITOR AND ONE PRESSURE RELIEF DEVICE.

### REFERENCE DOCUMENTS

DOCUMENT TITLE:	ABB DOCUMENT NO.:
GIS LAYOUT	1HC0102825
PROJECT SPECIFIC GIS PARAMETERS	1HC0102800
TABLE OF SF6 GAS VOLUMES	1HC0102803

FOR APPROVAL

NO. NO. REF: CC-CS/203-WR1/GS-2224/1/GS/R/NOA-I/4878 DT.12.02.2014  
 REF: CC-CS/203-WR1/GS-2224/1/GS/R/NOA-II/4879 DT.12.02.2014  
 REF: CC-CS/203-WR1/GS-2224/1/GS/R/NOA-III/4880 DT.12.02.2014  
 CLIENT: Power Grid Corporation Of India Ltd. (A Govt. Of India Enterprise)  
 SUBSTATION PACKAGE - P290-S02 FOR CONSTRUCTION OF 400KV GIS KOLHAPUR SUBSTATION NEW ASSOCIATED WITH SYSTEM STRENGTHENING - XVII IN SOUTHERN REGION

Draft: 2014-02-19 GEISSMANN	Derived from: 1HC5109655	Separate BOM: Without separate BOM	Scale: %	Doc type: DRA	Format: A1
Approved: 2014-02-19 KRIENBUEHL	Replaces: -	Replaces: SF6-SWITCHGEAR ELK-3/420			
Released: 2014-02-19 GEISSMANN	Responsible department: PPHV-SFE1	400KV PGCL KOLHAPUR			Language: EN
Order number: 17055	Revision: AC 2014-03-05	SINGLE LINE & GAS SCHEMATIC DIAGRAM			No. Sheets: 002
		Document number: 1HC0102824			Sheet no.: 001

REVISION	DATE	MODIFICATION
AC	2014-03-05	REVISED ACCORDING MEETING WITH PGCL DATED 2014-03-04
AB	2014-02-25	REVISED ACCORDING MAIL DATED 2014-02-24 AND TELCON
AA	2014-02-19	FIRST ISSUE

We reserve all rights in this document and in the information contained therein. Reproduction, use or disclosure to third parties without express authority is strictly forbidden.  
 © Copyright 2014 ABB. All rights reserved.

Ca-I  
 30/03/2014  
 6/3/2014  
 6/3/2014





Bharat Heavy Electricals Limited  
Doc No. **TB-PBTU-GIS-PGCIL-SS171T**  
Technical Specification

**SECTION 4**

**765kV and 400kV Gas Insulated Switchgear & its accessories**

**Pre-Bid Tie up for 765kV GIS New Substation Package SS171T for a) Establishment of 765kV level at Kolhapur(PG) GIS. b) Extn. Of 400kV GIS at Kolhapur(PG) GIS associated with Network Expansion Scheme in Western Region to cater to pumped storage potential near Satara (up to 4500MW) - Part A" through Tariff Based Competitive Bidding (TBCB) route; Specification No.: CC/I/W-GIS/DOM/A00/26/06181**

## **ANNEXURE-A**

### **COMPLIANCE CERTIFICATE OF TECHNICAL SPECIFICATION**

The bidder shall confirm compliance to the following by signing/ stamping this compliance certificate and furnishing same with the offer.

1. The scope of supply, technical details, construction features, design parameters etc. shall be as per technical specification & there are no exclusion/ deviation with regard to same.
2. There are no deviation(s) with respect to specification other than those furnished in the 'schedule of technical deviations'.
3. Only those technical submittals which are specifically asked for in NIT to be submitted at tender stage shall be considered as part of offer. Any other submission, even if made, shall not be considered as part of offer.
4. Any comments/ clarifications on technical/ inspection requirements furnished as part of bidder's covering letter shall not be considered by BHEL, and bidder's offer shall be construed to be in conformance with the specification.
5. Any changes made by the bidder in the price schedule with respect to the description/ quantities from those given in 'BOQ' of the specification shall not be considered (i.e., technical description & quantities as per the specification shall prevail).

Date:

Bidder's Stamp & Signature

Bharat Heavy Electricals Limited

SECTION 4

Doc No. **TB-PBTU-GIS-PGCIL-SS171T**

Technical Specification

**765kV and 400kV Gas Insulated Switchgear & its accessories**

**Pre-Bid Tie up for 765kV GIS New Substation Package SS171T for a) Establishment of 765kV level at Kolhapur(PG) GIS. b) Extn. Of 400kV GIS at Kolhapur(PG) GIS associated with Network Expansion Scheme in Western Region to cater to pumped storage potential near Satara (up to 4500MW) - Part A" through Tariff Based Competitive Bidding (TBCB) route; Specification No.: CC/T/W-GIS/DOM/A00/26/06181**

**ANNEXURE – B****SCHEDULE OF TECHNICAL DEVIATIONS**

Bidder shall list below all technical deviation clause wise w.r.t. tender specifications:

S.No.	Technical Section & Page No	Clause No.	Deviation	Reason / Justification

**Any deviation not specifically brought out in this section shall not be admissible for any commercial implication at later stage. Except to the technical deviations listed in this schedule, bidder's offer shall be considered in full compliance to the tender specifications irrespective of any such deviation indicated / taken elsewhere in the submitted offer.**

Date:

Bidder's Stamp &amp; Signature

Bharat Heavy Electricals Limited Doc No. <b>TB-PBTU-GIS-PGCIL-SS171T</b> Technical Specification <b>765kV and 400kV Gas Insulated Switchgear &amp; its accessories</b>	<b>SECTION 4</b>
<b>Pre-Bid Tie up for 765kV GIS New Substation Package SS171T for a) Establishment of 765kV level at Kolhapur(PG) GIS. b) Extn. Of 400kV GIS at Kolhapur(PG) GIS associated with Network Expansion Scheme in Western Region to cater to pumped storage potential near Satara (up to 4500MW) - Part A" through Tariff Based Competitive Bidding (TBCB) route; Specification No.: CC/T/W-GIS/DOM/A00/26/06181</b>	

---

**CHECKLIST FOR TECHNICAL EVALUATION**

Along with the technical offer/ bids, the bidder should submit this checklist confirming the inclusion of the enclosures as listed below,

Sl.No.	Documents to be enclosed	Bidder to confirm (Please tick "Confirmed")
1.	Supporting documents for compliance of Technical Qualifying Requirement.	Confirmed
2.	Unpriced BOQ duly mentioning "Quoted" for all the items, signed and sealed.	Confirmed
3.	Annexure- A duly filled signed and attached & Annexure- B duly filled signed and attached	Confirmed

Note: Any bidder not meeting the above requirement shall be liable for non-evaluation.

The above checklist is reviewed and verified for,

NIT Reference No.:

Name of Bidder:

Name of Project:

Email & Contact Number of Bidder Representative:

Date:

Bidder's Stamp & Signature