



BHARAT HEAVY ELECTRICALS LIMITED

TRANSMISSION PROJECTS ENGINEERING MANAGEMENT

BHEL DOCUMENT No.	TB-418-302-002	Rev.	00	Prepared	Checked	Approved
Customer Doc. No.		NAME	MSP	NK	SKS	
TYPE OF DOC.	TECHNICAL SPECIFICATION	SIGN	SIGNED	SIGNED	SIGNED	
TITLE	220V & 48V BATTERY CHARGER	DATE	25.11.2022	25.11.2022	25.11.2022	
		GROUP	TBEM			
		W.O. No	I22TB0001			
CUSTOMER	POWER GRID COPORATION OF INDIA LIMITED					
PROJECT	NEEMUCH 400/220kV SUBSTATION					

<u>CONTENTS</u>		
Section	Description	No. of Sheets
1.0	Scope, Specific Technical Requirements & Bill of Quantity	5
2.0	Detailed Technical Requirement- Equipment specification	6
	Annexure-1 to Section-2: Standard Scheme drawing for Charger	3
3.0	Project Details and General Specification	66
4.0	Schedule of Guaranteed Technical Particulars (to be filled at Contract stage)	3
5.0	Checklist (to be filled at tender stage)	3
	Annexure-A (Schedule of Technical deviation)	1

COPYRIGHT AND CONFIDENTIALITY
 The information on this document is the property of BHARAT HEAVY ELECTRICALS LTD.
 It must not be used directly or indirectly in anyway detrimental to the interest of the company

Rev No.	Date	Altered	Checked	Approved	REVISION DETAILS
Distribution				To	TBPM
				Copies	TBMM
					TBQM

	Project:	NEEMUCH 400/220 kV Substation
	Customer:	POWER GRID CORPORATION OF INDIA LIMITED
	Contractor:	Bharat Heavy Electricals Limited
	Document No.	TB-418-302-002, Rev.00
	Technical Specification:	220V & 48V Battery Charger

SECTION - 1

1.1 SCOPE

This technical specification covers the requirements of design, manufacture, testing at works, packing, dispatch and supervision of installation & commissioning of Float cum Boost Battery Charger complete in all respects for efficient and trouble free operation.

Battery chargers shall be fitted with all accessories including foundation bolts, fixing channels for mounting the charger on the floor.

This section covers the scope and quantities of 220V & 48V Battery chargers. The Specific Technical Requirements for the above item as specified by the customer (POWERGRID) are given in Section-2. The offered equipment shall also comply with the General Technical Requirements for the project as detailed under section-3 of this specification.

In case of any discrepancies between the requirements mentioned under Section-1/Section-2 and those specified in the Section-3, the specifications given under Section-1/Section-2 shall prevail and shall be treated as binding requirements.

The equipment is required for the following project:

Name of customer: POWER GRID CORPORATION OF INDIA LIMITED

Name of Projects: NNEMUCH 400/220kV Substation

The scope of supplies shall be as per commercial terms and conditions enclosed separately with the enquiry.

1.2 SPECIFIC TECHNICAL REQUIREMENTS

Equipment and system shall be designed to meet the following major technical parameters as brought out hereunder. For detailed technical requirements, please refer Section-2.

1	Nominal Voltage Rating (V)	220 V	48 V
2	Rated Current Capacity	120 A	120 A
3	Voltage regulation in		



Project:	NEEMUCH 400/220 kV Substation
Customer:	POWER GRID CORPORATION OF INDIA LIMITED
Contractor:	Bharat Heavy Electricals Limited
Document No.	TB-418-302-002, Rev.00
Technical Specification:	220V & 48V Battery Charger

a	- float charging	±1%	±1%
b	- boost charging	±1%	±1%
4	Short Circuit Level		
a	A.C. (for 1 Sec.)	20 kA	20 kA
b	D.C. (for 1 Sec.)	20 kA (DC)	20 kA (DC)
	Battery Data	220V	48V
1	Rating	700 (AH)	750 (AH)
2	Type of Battery	Valve Regulated Lead-Acid type	
3	Volts per Cell		
a	Float Charging	-----2.13-2.27 V-----	
b	Boost Charging	-----2.28-2.32 V-----	
	<u>Note:</u> 220 V DC system is unearthed & 48 V DC system is +ve earthed		
	System Condition		
1	3 phase A.C. supply	415 V - 50 Hz	415 V - 50 Hz
2	1 phase A.C. supply	240 V - 50 Hz	240 V - 50 Hz
3	Voltage Variation	± 10 %	± 10 %
4	Frequency Variation	± 5 %	± 5 %

1.3 BILL OF QUANTITIES

The following items are required:

A) 220V Battery Charger:

S. No.	Details	Unit	Qty
1.	220V, 120A Float cum Boost Charger as per specification complete in all respects	Sets	2
2.	Supervision of installation and commissioning of 220V Battery charger as per Cl. No. 1.7	Sets	2

B) 48V Battery Charger:

S. No.	Details	Unit	Qty
3.	48V, 120A Float cum Boost Charger as per specification complete in all respects	Sets	2
4.	Supervision of installation and commissioning of 48V Battery charger as per Cl. No. 1.7	Sets	2

	Project:	NEEMUCH 400/220 kV Substation
	Customer:	POWER GRID CORPORATION OF INDIA LIMITED
	Contractor:	Bharat Heavy Electricals Limited
	Document No.	TB-418-302-002, Rev.00
	Technical Specification:	220V & 48V Battery Charger

Note: Distance from Battery to Battery Charger is approx. 35m. Length of wiring for temperature sensors between Battery & respective chargers may be provided accordingly.

1.4 OTHER TECHNICAL REQUIREMENT

The manufacturer, whose Battery Chargers are offered, should have designed, manufactured and supplied Battery Chargers generally of the type offered, with static automatic voltage regulators and having a continuous output of at least ten (10) kW and these should be in successful as on the date of NOA (i.e., 23.09.2022).

1.5 TYPE TESTING

All equipment being supplied shall conform to type tests as per technical specification and shall be subject to routine tests in accordance with requirements stipulated under respective sections. Bidder shall submit valid type test reports (as per relevant IEC/IS Standard) for approval in line with clause 1.2.14 of Section-2. However, type test reports of similar equipments/material already accepted in POWERGRID shall be applicable with similar requirement. The type test reports submitted shall be of tests conducted within last 7 years prior to the date of NOA i.e. dated 23.09.2022. The type tests conducted earlier should have either been conducted in accredited laboratory (accredited based on ISO / IEC Guide 25 / 17025 or EN 45001 by the national accreditation body of the country where laboratory is located) or witnessed by POWERGRID/representative authorized by POWERGRID/representative of Utility /representative of accredited test lab/ representative of The National Accreditation Board for Certification Bodies (NABCB) certified agency shall also be acceptable.

In case the test reports are of the test conducted earlier than the years specified from the date of NOA, the contractor shall repeat these test(s) at no extra cost to the Employer. In case type test reports are found to be technically unacceptable to BHEL/POWERGRID, the type test shall be conducted without cost and delivery implication to BHEL.

Battery Charger shall conform to all type tests as per relevant Indian Standards. Performance test on the Chargers as per specification shall be carried out on each charger. Rectifier transformer shall conform to all type tests specified in IS:4540 and short circuit test as per IS:2026.

However, following **type tests** shall be carried out for compliance of specification requirements:

	Project:	NEEMUCH 400/220 kV Substation
	Customer:	POWER GRID CORPORATION OF INDIA LIMITED
	Contractor:	Bharat Heavy Electricals Limited
	Document No.	TB-418-302-002, Rev.00
	Technical Specification:	220V & 48V Battery Charger

- i) Voltage regulation test
- ii) Load limiter characteristics test
- iii) Efficiency tests
- iv) High voltage tests
- v) Temperature rise test
- vi) Short circuit test at no load and full load at rated voltage for sustained short-circuit.
- vii) Degree of protection test
- viii) Measurement of ripple by oscilloscope
- ix) Temperature compensation feature demonstration

1.6 SUPERVISION OF INSTALLATION & COMMISSIONING

Bidder shall quote for the following supervision charges:

- Supervision of testing and commissioning at site for all offered Battery chargers.
- The manufacturer will demonstrate that the chargers conform to the specification particularly regarding continuous rating, ripple free output, voltage regulation and load limiting characteristic before dispatch as well as after installation at site.

Following tests shall be carried out by manufacturer:

- i) Insulation resistance test
- ii) Checking of proper annunciation system operation.

Note: All testing instruments required for testing & commissioning of battery chargers shall be brought to site by the supplier and after successful completion of tests, these instruments can be taken back.

- If a Charger fails to meet the specified requirements, the Contractor shall replace the same with appropriate Charger without affecting the commissioning schedule of the Sub-station, and without any extra cost to the BHEL/POWERGRID.
- The Contractor shall present for inspection, the type and routine test certificates for the following components whenever required by the BHEL/POWERGRID:
 - (i) Switches.
 - (ii) Relays/MCCBs
 - (iii) Instruments.

	Project:	NEEMUCH 400/220 kV Substation
	Customer:	POWER GRID CORPORATION OF INDIA LIMITED
	Contractor:	Bharat Heavy Electricals Limited
	Document No.	TB-418-302-002, Rev.00
	Technical Specification:	220V & 48V Battery Charger

- (iv) DC fuses.
- (v) SCR.
- (vi) Diodes.
- (vii) Condensers.
- (viii) Potentiometers.
- (ix) Semiconductor
- (x) Annunciator.
- (xi) Control wiring
- (xii) Push buttons and contactors.

Makes of above equipment shall be subject to POWERGRID approval.

1.7 DRAWINGS/ DATA SHEETS

Bidder shall submit POWERGRID approved/Standard drawings wherever available for approval extension.

Minimum indicative requirement of Potential Free contacts which should be available at 220V & 48V Battery Charger for remote indication & control from Auxiliary BCU located in S/s control room is as follows:

- a. CHARGER-1 : AC power failure
- b. CHARGER-1: Rectifier/chargers fuse blown
- c. CHARGER-1 : Over voltage across the battery when boost charging
- d. CHARGER-1 : Abnormal voltage (High/Low)
- e. CHARGER-1 : FLOAT MODE
- f. CHARGER-1 : BOOST MODE

- g. CHARGER-2 : AC power failure
- h. CHARGER-2: Rectifier/chargers fuse blown
- i. CHARGER-2 : Over voltage across the battery when boost charging
- j. CHARGER-2 : Abnormal voltage (High/Low)
- k. CHARGER-2 : FLOAT MODE
- l. CHARGER-2 : BOOST MODE

-- X X --

	Project:	NEEMUCH 400/220 kV Substation
	Customer:	POWER GRID CORPORATION OF INDIA LIMITED
	Contractor:	Bharat Heavy Electricals Limited
	Document No.	TB-418-302-002, Rev.00
	Technical Specification:	220V & 48V Battery Charger

SECTION – 2

1.1 GENERAL TECHNICAL REQUIREMENTS

- 1.1.1. All materials/components used in battery chargers and batteries shall be free from flaws and defects and shall conform to the relevant Indian/IEC standards and good engineering practice.
- 1.1.2. DC System shall consist of two (2) float- cum-boost chargers and two (2) battery sets for each of 220V and 48 V systems respectively. The standard scheme drawing is enclosed with this specification.
- 1.1.3. Bidder shall select number of cells, float and Boost voltage to achieve the following system requirement:

System Voltage	Maximum Voltage during Float operation	Minimum voltage available when no charger working and battery fully discharged upto 1.85V per cell.	Minimum Nos of cell
220 Volt	242 Volt	198 Volt	108
48 Volt	52.8 Volt	43.2 Volt	24

APPLICABLE STANDARDS

IS:3895	Mono-crystalline Semiconductor Rectifier Cells and Stacks
IS:4540	Mono-crystalline Semiconductor Rectifier Assemblies and Equipment.
IS:6619	Safety Code for Semiconductor Rectifier Equipment
IS:2026	Power Transformers
IS:2959	AC Contactors for Voltages not Exceeding 1000 Volts
IS:1248	Indicating Instruments
IS:2208	HRC Fuses
IS:13947 (Part-3)	Air break switches, air break disconnectors & fuse combination units for voltage not exceeding 1000V AC or 1200V DC
IS:2147	Degree of protection provided by enclosures for low voltage switchgear and control-gear
IS:6005	Code of practice for phosphating of Iron and Steel
IS:3231	Electrical relays for power system protection
IS:3842	Electrical relay for AC Systems
IS:5	Colors for ready mix paint
IEEE-484	Recommended Design for installation design and installation of large lead storage batteries for generating stations and substations.
IEEE-485	Sizing large lead storage batteries for generating stations and substations

1.2. BATTERY CHARGER

The DC system for 220 V DC is unearthed and for 48 V DC is +ve earthed. The Battery Chargers as well as their automatic regulators shall be of static type and shall be compatible with offered VRLA batteries. All battery chargers shall be capable of

	Project:	NEEMUCH 400/220 kV Substation
	Customer:	POWER GRID CORPORATION OF INDIA LIMITED
	Contractor:	Bharat Heavy Electricals Limited
	Document No.	TB-418-302-002, Rev.00
	Technical Specification:	220V & 48V Battery Charger

continuous operation at the respective rated load in float charging mode, i.e. Float charging the associated Lead-Acid Batteries at 2.13 to 2.27 Volts per cell while supplying the DC load. The chargers shall also be capable of Boost charging the associated DC Battery at 2.28 to 2.32 volts per cell at the desired rate.

Charger shall regulate the float/boost voltage in case of prescribed temperature rise of battery as per manufacturer's recommendation to avoid thermal runaway. Necessary temperature sensors shall be provided in mid location of battery banks and shall be wired up to the respective charger for feedback control. The manufacturer shall demonstrate this feature during testing of each charger.

- 1.3.1. All Battery Chargers shall be provided with facility for both automatic and manual control of output voltage and current. A selector switch shall be provided for selecting the mode of output voltage/current control, whether automatic or manual. When on automatic control mode during Float charging, the Charger output voltage shall remain within $\pm 1\%$ of the set value, for AC input voltage variation of $\pm 10\%$, frequency variation of $\pm 5\%$, a combined voltage and frequency variation of $\pm 10\%$, and a DC load variation from zero to full load.
- 1.3.2. All battery chargers shall have a constant voltage characteristic throughout the range (from zero to full load) at the floating value of the voltage so as to keep the battery fully charged but without harmful overcharge.
- 1.3.3. All chargers shall have load limiters having drooping characteristic, which shall cause, when the voltage control is in automatic mode, a gradual lowering of the output voltage when the DC load current exceeds the Load limiter setting of the Charger. The Load-limiter characteristics shall be such that any sustained overload or short circuit in DC System shall not damage the Charger, nor shall it cause blowing of any of the Charger fuses. The Charger shall not trip on overload or external short circuit.
- 1.3.4. Uniform and step less adjustments of voltage setting (in both manual and automatic modes) shall be provided on the front of the Charger panel covering the entire float charging output range specified. Step less adjustments of the Load- limiter setting shall also be possible from 80% to 100% of the rated output current for charging mode.
- 1.3.5. During Boost Charging, the Battery Charger shall operate on constant current mode (when automatic regulator is in service). It shall be possible to adjust the Boost charging current continuously over a range of 50 to 100% of the rated output current for Boost charging mode.
- 1.3.6. The Charger output voltage shall automatically go on rising, when it is operating on Boost mode, as the Battery charges up. For limiting the output voltage of the Charger, a potentiometer shall be provided on the front of the panel, whereby it shall be possible to set the upper limit of this voltage anywhere in the output range specified for Boost Charging mode.
- 1.3.7. The Charger manufacturer may offer an arrangement in which the voltage setting device

	Project:	NEEMUCH 400/220 kV Substation
	Customer:	POWER GRID CORPORATION OF INDIA LIMITED
	Contractor:	Bharat Heavy Electricals Limited
	Document No.	TB-418-302-002, Rev.00
	Technical Specification:	220V & 48V Battery Charger

for Float charging mode is also used as output voltage limit setting device for Boost charging mode and the Load-limiter of Float charging mode is used as current setting device in boost charging mode.

1.3.8. Suitable filter circuits shall be provided in all the chargers to limit the ripple content (Peak to Peak) in the output voltage to 1%, irrespective of the DC load level, when they are not connected to a Battery.

1.3.9. **MCCB**

All Battery Chargers shall have 2 Nos. MCCBs on the input side to receive cables from two sources. Mechanical interlock should be provided such that only one shall be closed at a time. It shall be of P2 duty and suitable for continuous duty. MCCB's should have auxiliary contacts for annunciation.

1.3.10. **Rectifier Transformer**

The rectifier transformer shall be continuously rated, dry air cooled (A.N) and of class F insulation type. The rating of the rectifier transformer shall have 10% overload capacity.

1.3.11. **Rectifier Assembly**

The rectifier assembly shall be fully/half controlled bridge type and shall be designed to meet the duty as required by the respective Charger. The rectifier shall be provided with heat sink having their own heat dissipation arrangements with natural air cooling. Necessary surge protection devices and rectifier type fast acting HRC fuses shall be provided in each arm of the rectifier connections.

1.3.12. **Instruments**

One AC voltmeter and one AC ammeter along with selector switches shall be provided for all chargers. One DC voltmeter and DC ammeter (with shunt) shall be provided for all Chargers. The instruments shall be flush type, dust proof and moisture resistant. The instruments shall have easily accessible means for zero adjustment. The instruments shall be of 1.5 accuracy class. In addition to the above a centre zero voltmeter with selector switch shall also be provided for 220 V chargers for testing purpose.

1.3.13. **Air Break Switches**

One DC output switch shall be provided in all chargers. They shall be air break type suitable for 500 volts AC/ 250 DC. The contacts of the switches shall open and close with a snap action. The operating handle of the switch shall be fully insulated from circuit. 'ON' and 'OFF' position on the switch shall be clearly indicated. Rating of switches shall be suitable for their continuous load. Alternatively, MCCB's of suitable ratings shall also acceptable in place of Air Break Switch.

1.3.14. **Fuses**

All fuses shall be HRC Link type. Fuses shall be mounted on fuse carriers which are in turn mounted on fuse bases. Wherever it is not possible to mount fuses on carriers, fuses shall be directly mounted on plug-in type base. In such case one insulated fuse pulling handle shall be supplied for each charger. Fuse rating shall be chosen by the Bidder depending on the circuit requirement. All fuses in the chargers shall be monitored. Fuse failure

	Project:	NEEMUCH 400/220 kV Substation
	Customer:	POWER GRID CORPORATION OF INDIA LIMITED
	Contractor:	Bharat Heavy Electricals Limited
	Document No.	TB-418-302-002, Rev.00
	Technical Specification:	220V & 48V Battery Charger

annunciation shall be provided on the failure of any fuse.

1.3.15. Blocking Diode

Blocking diode shall be provided in the positive pole of the output circuit of each charger to prevent current flow from the DC Battery into the Charger.

1.3.16. Annunciation System

Audio-visual indications through bright LEDs shall be provided in all Chargers for the following abnormalities:

- a) AC power failure
- b) Rectifier/chargers fuse blown.
- c) Over voltage across the battery when boost charging.
- d) Abnormal voltage (High/Low)
- e) Any other annunciation if required.

Potential free NO Contacts of above abnormal conditions shall also be provided for common remote indication "CHARGER TROUBLE" in ultimate customer's Control Board. Indication for charger in float mode and boost mode through indication lamps shall be provided for chargers. A potential free contact for float/boost mode shall be provided for external interlocks.

1.3.17. Name Plates and Marking

The name plates shall be white with black engraved letters. On top of each Charger, on front as well as rear sides, larger and bold name plates shall be provided to identify the Charger. Name plates with full and clear inscriptions shall also be provided on and inside of the panels for identification of the various equipments and ease of operation and maintenance.

1.3.18. Charger Construction

The Chargers shall be indoor, floor-mounted, self-supporting sheet metal enclosed cubicle type. The manufacturer shall supply all necessary base frames, anchor bolts and hardware. The Chargers shall be fabricated from 2.0mm cold rolled sheet steel and shall have folded type of construction. Removable gland plates for all cables and lugs for power cables shall be supplied by the manufacturer. The lugs for power cables shall be made of electrolytic copper with tin coat. Power cable sizes shall be informed to the manufacturer during detailed engineering stage for provision of suitable lugs and drilling of gland plates. The Charger shall be tropicalized and vermin proof. Ventilation louvers, if provided shall be backed with screens. All doors and covers shall be fitted with synthetic rubber gaskets. The chargers shall have hinged double leaf doors provided on front and on backside for adequate access to the Charger's internals. All the charger cubicle doors shall be properly earthed. The degree of protection of Charger enclosure shall be at least IP-42 as per IS:13947 Part I.

1.3.18.1. All indicating instruments, control switches and indicating lamps shall be mounted on the front side of the Charger.

	Project:	NEEMUCH 400/220 kV Substation
	Customer:	POWER GRID CORPORATION OF INDIA LIMITED
	Contractor:	Bharat Heavy Electricals Limited
	Document No.	TB-418-302-002, Rev.00
	Technical Specification:	220V & 48V Battery Charger

1.3.18.2. Each Charger shall be furnished completely wired up to power cable lugs and terminal blocks and ready for external connections. The control wiring shall be carried out with PVC insulated, 1.5 sq.mm. stranded copper wires. Control terminals shall be suitable for connecting two wires, with 2.5 sq.mm stranded copper conductors. All terminals shall be numbered for ease of connections and identification. Each wire shall bear a ferrule or tag on each end for identification. At least 20% spare terminals shall be provided for control circuits.

1.3.18.3. The insulation of all circuits, except the low voltage electronic circuits shall withstand test voltage of 2 KV AC for one minute. An air clearance of at least ten (10) mm shall be maintained throughout for such circuits, right up to the terminal lugs. Whenever this clearance is not available, the live parts shall be insulated or shrouded.

1.3.19. **Painting**

All sheet steel work shall be pre-treated, in tanks, in accordance with IS:6005. Degreasing shall be done by alkaline cleaning. Rust and scale shall be removed by pickling with acid. After pickling, the parts shall be washed in running water. Then these shall be rinsed in slightly alkaline hot water and dried. The phosphate coating shall be `Class-C` as specified in IS:6005. Welding shall not be done after phosphating. The phosphating surfaces shall be rinsed and passivated prior to application of stoved lead oxide primer coating. After primer application, two coats of finishing synthetic enamel paint of shade-692 (smoke grey) of IS:5 shall be applied, unless required otherwise by the ultimate customer. The inside of the chargers shall be glossy white. Each coat of finishing synthetic enamel paint shall be properly staved. The paint thickness shall not be less than fifty (50) microns.

1.3.20. **TESTS**

1.3.20.1. Battery chargers shall conform to all type tests as per relevant Indian Standard. Performance test on the Chargers as per Specification shall also be carried out on each Charger as per specification. Rectifier transformer shall conform to all type tests specified in IS : 4540 and short circuit test as per IS:2026. Following type tests shall be carried out for compliance of specification requirements:

- i) Voltage regulation test
- ii) Load limiter characteristics test
- iii) Efficiency tests
- iv) High voltage tests
- v) Temperature rise test
- vi) Short circuit test at no load and full load at rated voltage for sustained short-circuit.
- vii) Degree of protection test
- viii) Measurement of ripple by oscilloscope.
- ix) Temperature compensation feature demonstration

1.3.20.2. The Bidder may be required to demonstrate to the BHEL/POWERGRID that the Chargers conform to the specification particularly regarding continuous rating, ripple free output, voltage regulation and load limiting characteristic, before despatch as well as after

	Project:	NEEMUCH 400/220 kV Substation
	Customer:	POWER GRID CORPORATION OF INDIA LIMITED
	Contractor:	Bharat Heavy Electricals Limited
	Document No.	TB-418-302-002, Rev.00
	Technical Specification:	220V & 48V Battery Charger

installation at site. At site the following tests shall be carried out:

- i) Insulation resistance test
- ii) Checking of proper annunciation system operation.

1.3.20.3. If a Charger fails to meet the specified requirements, the manufacturer shall replace the same with appropriate Charger without affecting the commissioning schedule of the Sub-station, and without any extra cost to the BHEL/POWERGRID.

1.3.20.4. The manufacturer shall present for inspection, the type and routine test certificates for the following components whenever required by the BHEL/POWERGRID.

- i) Switches.
- ii) Relays/ MCCBs
- iii) Instruments.
- iv) DC fuses.
- v) SCR.
- vi) Diodes.
- vii) Condensers.
- viii) Potentiometers.
- ix) Semiconductor
- x) Annunciator.
- xi) Control wiring
- xii) Push buttons and contactors.

Makes of above equipment shall be subject to POWERGRID approval.

--- XX ---

ANNEXURE-1 TO SECTION-2

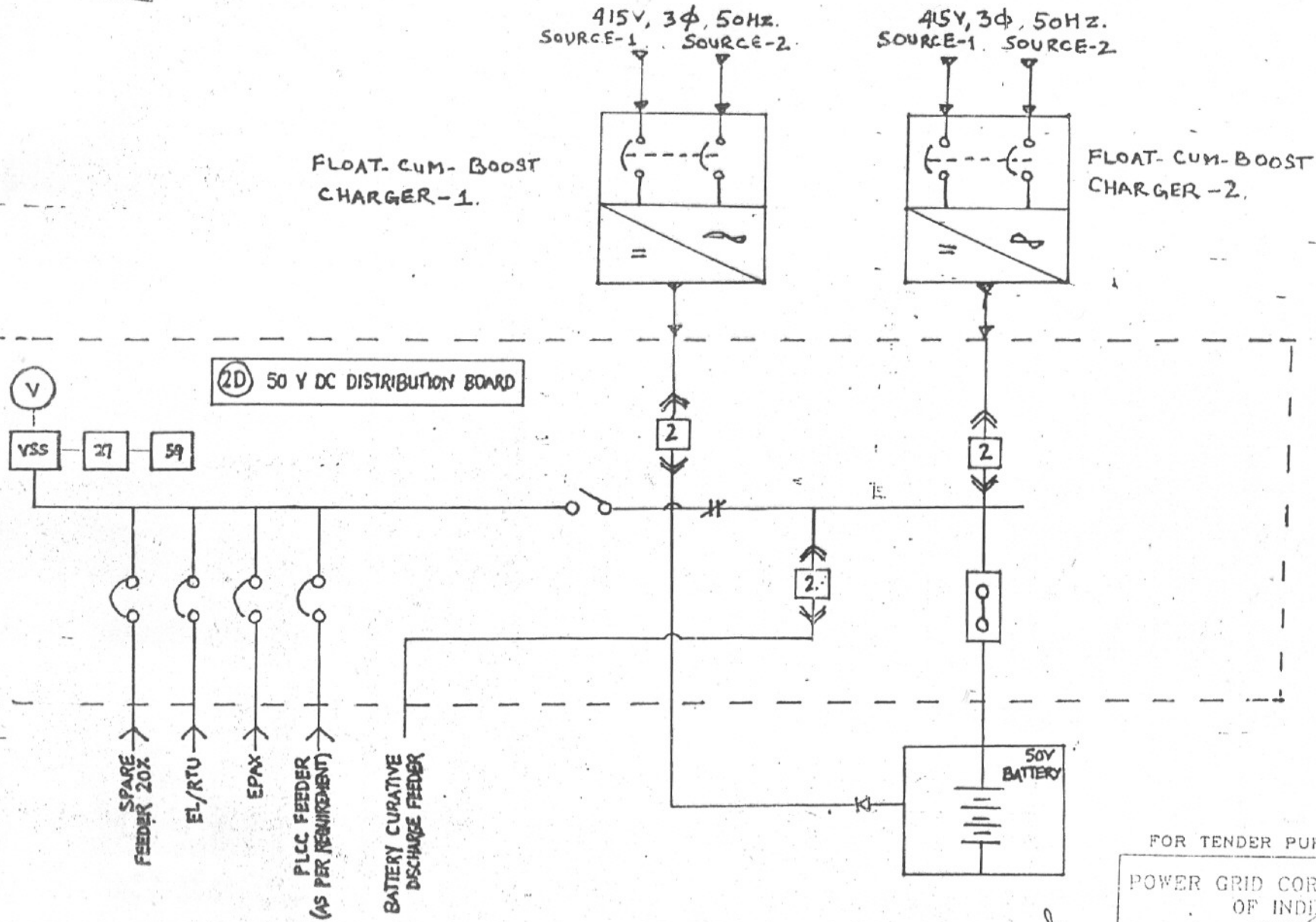

NOTE:-
 1. ELECTRICAL INTERLOCK SHALL BE PROVIDED BETWEEN SOURCE-1 & SOURCE-2 FOR EACH CHARGER

FOR TENDER PURPOSE ONLY.
 POWER GRID CORPORATION
 OF INDIA LIMITED
AN GOVERNMENT OF INDIA ENTERPRISE
 SCHEMATIC OF SOY CHARGER
 FOR 132KV S/STN

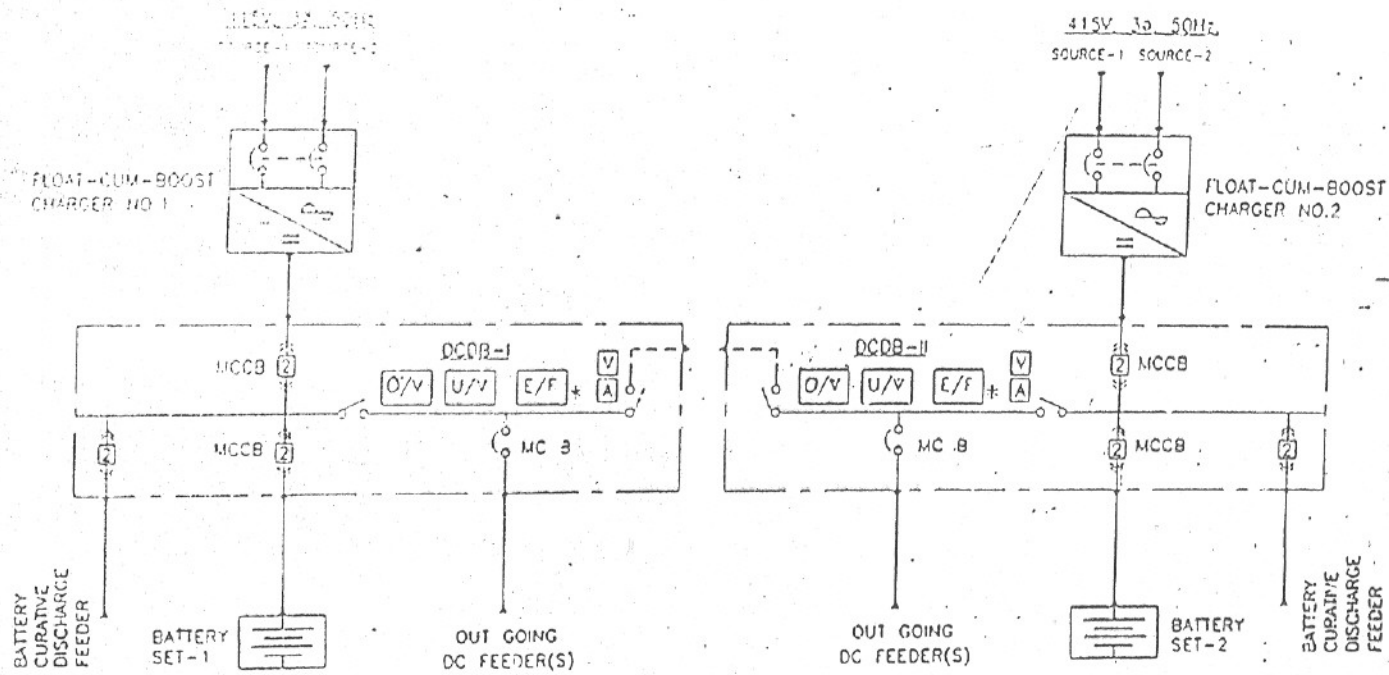

* ONLY FOR 110/220 V DC SYSTEM

NOTE:

- ELECTRICAL INTERLOCK SHALL BE PROVIDED BETWEEN SOURCE-1 & SOURCE-2 FOR EACH CHARGER.

/DOC-9/C:/PGCIL/CUPTA/SLD.DWG

POWER GRID CORPORATION OF INDIA LIMITED (A Government of India Enterprise)		
DRN.		PROJECT : STANDARDIZATION
CHKD.	S.S.	
APPD.	S.S.	DRG. TITLE : STANDARD DC SYSTEM
DEPT.		
DATE	SCALE	DRAWING NO. C:/ENGC/STD/DC/01
DESIGNED BY DCC (ENGC) DRAWN BY	NTS	REV 2 (SH-1 OF 2)

ANNEXURE-1 TO SECTION-2

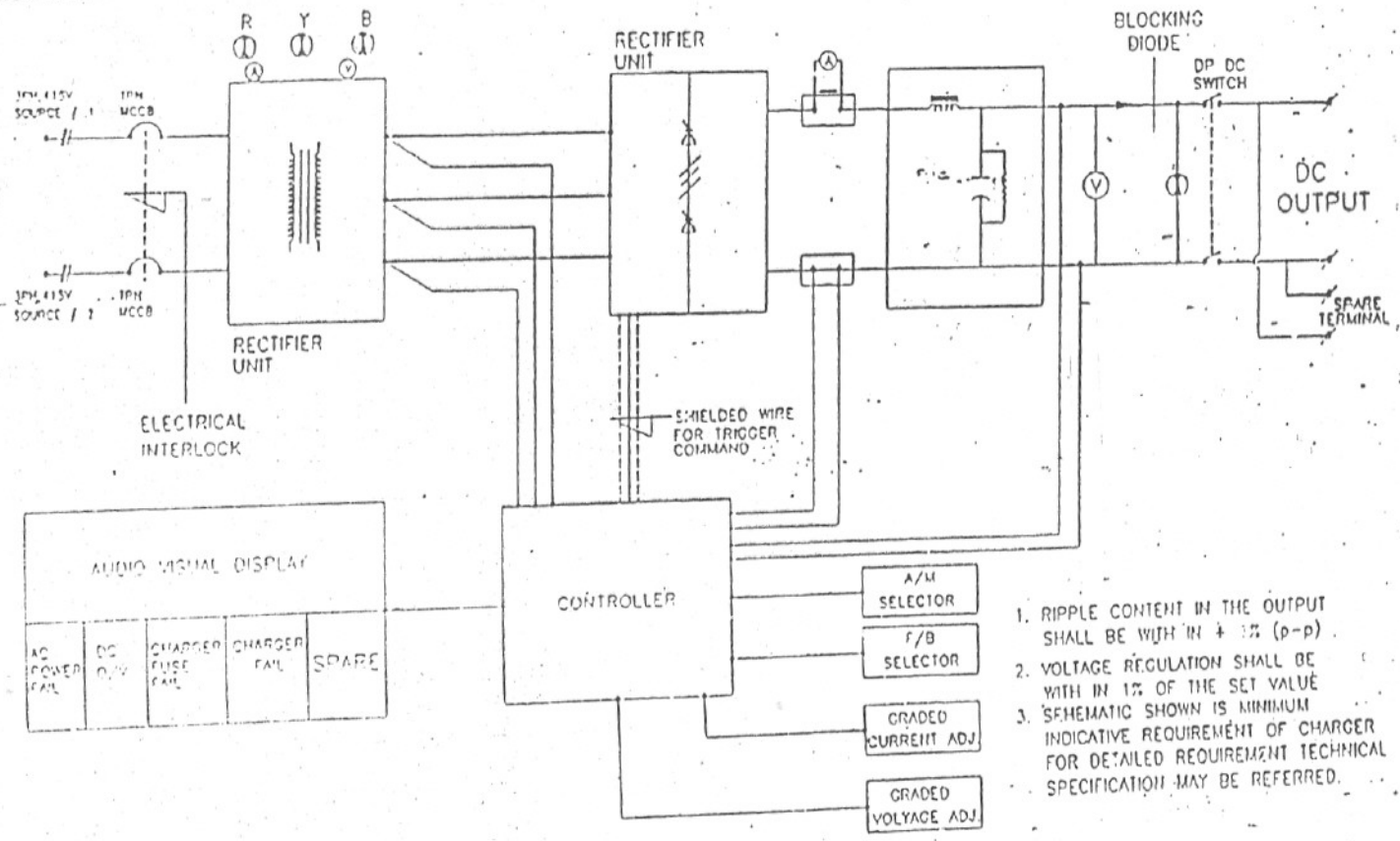

1. RIPPLE CONTENT IN THE OUTPUT SHALL BE WITH IN $\pm 1\%$ (p-p)
2. VOLTAGE REGULATION SHALL BE WITH IN 1% OF THE SET VALUE
3. SCHEMATIC SHOWN IS MINIMUM INDICATIVE REQUIREMENT OF CHARGER FOR DETAILED REQUIREMENT TECHNICAL SPECIFICATION MAY BE REFERRED.

POWER GRID CORPORATION OF INDIA LIMITED
(A Government of India Enterprise)

PROJECT	STANDARDIZATION
DESIGN	SCHEMATIC OF CHARGER
DATE	01/08/2010
BY	
CHECKED	
APPROVED	



BHARAT HEAVY ELECTRICALS LIMITED
TRANSMISSION BUSINESS ENGINEERING MANAGEMENT

COPYRIGHT AND CONFIDENTIALITY
 The information on this document is the property of BHARAT HEAVY ELECTRICALS LTD.
 It must not be used directly or indirectly in anyway detrimental to the interest of the company

DOCUMENT No.	TB-418-316-000	Rev. No.	00	Prepared	Checked	Approved		
TYPE OF DOC.	TECHNICAL SPECIFICATION			SIGN	<i>Satyaki Chaudhary</i>	<i>Vijay</i> <i>Sankar</i>		
TITLE	GENERAL TECHNICAL REQUIREMENTS-SECTION 3			NAME	SC	NK	SKS	
				DATE	15.10.22	15.10.22	15.10.22	
				GROUP	TBEM	W.O.	Awaited	
CUSTOMER	Powergrid Corporation of India Ltd. (POWERGRID)							
PROJECT	Substation Package SS01 for (i) 400/220kV AIS Neemuch New S/S including 400kV class Transformer & Bus Reactor, (ii) Extension of 400kV Chittorgarh S/S and (iii) Extension of 400kV Mandsaur S/S associated with Transmission system for evacuation of power from Neemuch REZ through TBCB route							
NOA NO.	TBCB/Neemuch REZ/400kV AIS/SS01/G5/NOA-I/05 dtd. 23/09/2022 & TBCB/Neemuch REZ/400kV AIS/SS01/G5/NOA-II/06 dtd. 23/09/2022							
Station	400/220kV AIS Neemuch New S/S, Madhya Pradesh Extension of 400kV Chittorgarh S/S, Rajasthan Extension of 400kV Mandsaur S/S, Madhya Pradesh							
S.No.	Description					Sheet		
1	General Technical Requirements – Site Information					2,3		
2	General Technical Requirements					4-32		
3	Annexure -A					2 Sheets		
4	Annexure -B					1 Sheets		
5	Annexure -C					23 Sheets		
6	Annexure -G					6 Sheets		
7	Annexure -K					2 Sheets		
RevNo.	Date	Altered	Checked	Approved	REVISION DETAILS			
Distribution				To	TBEM	TBMM	TBQM	Supplier
				Copies	1	1	1	4



Substation Package SS01 for (i) 400/220kV AIS Neemuch New S/S including 400kV class Transformer & Bus Reactor, (ii) Extension of 400kV Chittorgarh S/S and (iii) Extension of 400kV Mandsaur S/S associated with Transmission system for evacuation of power from Neemuch REZ through TBCB route.

General Technical Requirements- Section 3

Doc. No. : TB-418-316-000 Rev 00

GENERAL TECHNICAL REQUIREMENTS-SECTION 3

Site Information

S.No.	Particular	Details
a)	Owner	Neemuch Transmission Limited - a 100% wholly owned subsidiary of Power Grid Corporation of India Limited
b)	Customer	Neemuch Transmission Limited - a 100% wholly owned subsidiary of Power Grid Corporation of India Limited
c)	Project Title	Substation Package SS01 for (i) 400/220kV AIS Neemuch New S/S including 400kV class Transformer & Bus Reactor, (ii) Extension of 400kV Chittorgarh S/S and (iii) Extension of 400kV Mandsaur S/S associated with Transmission system for evacuation of power from Neemuch REZ through TBCB route
d)	Location	Neemuch, MP Chittorgarh, Rajasthan Mandsaur, MP
e)	Transport Facilities	Road/Train Nearest Rail Head For Neemuch: Neemuch Nearest Rail Head For Chittorgarh: Chittorgarh Nearest Rail Head For Mandsaur: Mandsaur Nearest Airport : Udaipur
SITE CONDITIONS		
a)	Max. ambient air temp.	50°C
b)	Min. ambient air temp.	0°C
c)	Max. design ambient temp.	50°C
d)	Design reference temp.	50°C
e)	Average Humidity	Max. 100%
f)	Special corrosion conditions	No
g)	Solar Radiation	2 kW/sqmtr
h)	Atmospheric UV radiation	High
i)	Altitude above sea level	Less than 1000 meter above mean sea level (MSL)
j)	Pollution Severity	High Pollution level



Substation Package SS01 for (i) 400/220kV AIS Neemuch New S/S including 400kV class Transformer & Bus Reactor, (ii) Extension of 400kV Chittorgarh S/S and (iii) Extension of 400kV Mandasaur S/S associated with Transmission system for evacuation of power from Neemuch REZ through TBCB route.

General Technical Requirements- Section 3

Doc. No. : TB-418-316-000 Rev 00

k)	Seismic Zone	Zone-II
WIND DATA		
	Wind Zone	47m/sec
	Average No. of thunderstorm days per annum	As per IS
Main Electrical Parameters:		
	Fault Levels:	400kV: 63kA for 1 sec. 220kV : 50kA for 1 sec.
	Creepage Distance	25mm/kV for All Equipment i.e BPI/Bushings, CB, Isolator, CT, CVT, LA, WT etc. 31mm/kV for string insulators



Substation Package SS01 for (i) 400/220kV AIS Neemuch New S/S including 400kV class Transformer & Bus Reactor, (ii) Extension of 400kV Chittorgarh S/S and (iii) Extension of 400kV Mandsaur S/S associated with Transmission system for evacuation of power from Neemuch REZ through TBCB route.

General Technical Requirements- Section 3

Doc. No. : TB-418-316-000 Rev 00

GENERAL TECHNICAL REQUIREMENTS-SECTION 3

1.0 FOREWORD

The provisions under this section are intended to supplement requirements for the materials, equipment's and services covered under other sections of tender documents and are not exclusive.

The Supplier shall note that the standards mentioned herein are not mutually exclusive or complete in themselves, but are intended to complement each other, with minimum repetition, to define the requirements of the Specification. In the event of a conflict between requirements of any two clauses of the Specification/ documents or requirements of different codes/ standards specified, the more stringent requirement as per the interpretation of the owner shall apply, unless confirmed otherwise by the owner in writing based on a written request from the Supplier.

In case of conflicting requirements between this document (General Technical Requirement Section 3) and equipment specification (Section 1 & Section 2), equipment specification shall prevail.

When specific requirements stipulated in the Specification exceed or change those required by the applicable standards, the stipulations of the Specification shall take precedence.

Unless specifically agreed to by the Purchaser prior to Award of Contract, the Work shall be in accordance with the standards indicated and the requirements of the Specification. The Supplier shall be held responsible for any deviation.

In case of conflict between the various standards, the decision of owner shall be binding & final.

The following words and expressions shall have the meanings hereby assigned to them throughout this document

"Employer/Owner" means Power Grid Corporation of India Ltd.

"Purchaser" means Bharat Heavy Electricals Limited

"Supplier/Manufacturer/Bidder" means the person or persons, firm or company assigned to execute the works as defined by the scope of supply, described here.

"Specification" refers to this document.

The supplier should be approved by Power Grid. If not, it is the responsibility of the vendor to be assessed and approved by Power Grid, before placement of order by BHEL. Any cost involved in vendor assessment/approval must be borne by the vendor himself.



Substation Package SS01 for (i) 400/220kV AIS Neemuch New S/S including 400kV class Transformer & Bus Reactor, (ii) Extension of 400kV Chittorgarh S/S and (iii) Extension of 400kV Mandsaur S/S associated with Transmission system for evacuation of power from Neemuch REZ through TCB route.

General Technical Requirements- Section 3

Doc. No. : TB-418-316-000 Rev 00

2.0 GENERAL REQUIREMENT

2.1 a) All equipment/materials/items, as per Annexure-K, as applicable under present scope of works, shall be supplied by domestic manufacturers only.

Any imported equipment/material/item/parts/component (comprising of embedded systems) to be supplied under the contract shall be tested in the certified laboratories to check for any kind of embedded malware/trojans/cyber threats and for adherence to Indian Standards as per the directions issued by Ministry of Power/Govt. of India from time to time. In case of such import from specified "prior reference" countries, the requirement of prior permission from the Govt. of India including protocol for testing in certified and designated laboratories by Ministry of Power/Govt. of India shall also be complied with by the Bidder.

The bidder/contractor shall list out the products and components producing Toxic e-waste under the contract and shall furnish to the Employer the procedure of safe disposal at the time of closing of the contract.

2.1 b) The Supplier/Manufacturer shall furnish catalogues, engineering data, technical information, design documents, drawings etc., fully in conformity with the technical specification during detailed engineering.

2.2 It is recognised that the Bidder may have standardised on the use of certain components, materials, processes or procedures different from those specified herein. Alternate proposals offering similar equipment based on the manufacturer's standard practice will also be considered provided such proposals meet the specified designs, standard and performance requirements and are acceptable to Employer.

2.3 Wherever a material or article is specified or defined by the name of a particular brand, Manufacturer or Vendor, the specific name mentioned shall be understood as establishing type, function and quality and not as limiting competition.

2.4 Equipment furnished shall be complete in every respect with all mountings, fittings, fixtures and standard accessories normally provided with such equipment and/or needed for erection, completion and safe operation of the equipment as required by applicable codes though they may not have been specifically detailed in the Technical Specifications unless included in the list of exclusions. Materials and components which are minor in nature and incidental to the requirement but not specifically stated in the specification, which are necessary for commissioning and satisfactory operation of the switchyard/ substation unless specifically excluded shall be deemed to be included in the scope of the specification and shall be supplied without any extra cost. All similar standard components/parts of similar standard equipment provided, shall be interchangeable with one another.

2.5 Deleted.

2.6 Deleted.



Substation Package SS01 for (i) 400/220kV AIS Neemuch New S/S including 400kV class Transformer & Bus Reactor, (ii) Extension of 400kV Chittorgarh S/S and (iii) Extension of 400kV Mandsaur S/S associated with Transmission system for evacuation of power from Neemuch REZ through TBCB route.

General Technical Requirements- Section 3

Doc. No. : TB-418-316-000 Rev 00

3.0 STANDARDS

- 3.1 The works covered by the specification shall be designed, engineered, manufactured, built, tested and commissioned in accordance with the Acts, Rules, Laws and Regulations of India.
- 3.2 The equipment offered by the Bidder shall at least conform to the requirements specified under relevant IS standard. In case of discrepancy between IS and other international standard, provisions of IS shall prevail. The Bidder shall also note that the list of standards presented in Annexure-C is not complete. Whenever necessary, the list of standards shall be considered in conjunction with specific IS. If the IS standard is not available for an equipment/material, then other applicable International standard (IEC/Equivalent), as per the specification, shall be accepted.
- 3.3 The Bidder shall note that standards mentioned in the specification are not mutually exclusive or complete in themselves, but intended to complement each other.
- 3.4 When the specific requirements stipulated in the specifications exceed or differ than those required by the applicable standards, the stipulation of the specification shall take precedence.
- 3.5 Other internationally accepted standards which ensure equivalent or better performance than that specified in the standards specified under Annexure-C / individual sections for various equipments shall also, be accepted, however the salient points of difference shall be clearly brought out during detailed engineering along with English language version of such standard. The equipment conforming to standards other than specified under Annexure-C /individual sections for various equipments shall be subject to Employer's approval.

4.0 SERVICES TO BE PERFORMED BY THE EQUIPMENT BEING FURNISHED

- 4.1 Switching surge over voltage and power frequency over voltage is specified in the system parameters below. In case of the 400kV system, the initial value of the temporary overvoltages could be 2.0 p.u. for 1-2 cycles. The equipment furnished under this specification shall perform all its functions and operate satisfactorily without showing undue strain, restriking etc under such over voltage conditions.
- 4.2 All equipments shall also perform satisfactorily under various other electrical, electromechanical and meteorological conditions of the site of installation.
- 4.3 All equipment shall be able to withstand all external and internal mechanical, thermal and electromechanical forces due to various factors like wind load, temperature variation, ice & snow, (wherever applicable) short circuit etc. for the equipment.
- 4.4 The Bidder shall design terminal connectors of the equipment taking into account various forces as above at Sl.No.4.3 that are required to withstand.
- 4.5 The equipment shall also comply to the following:
 - a) To facilitate erection of equipment, all items to be assembled at site shall be "match marked".
 - b) All piping, if any between equipment control cabinet/operating mechanism to marshalling box of the equipment, shall bear proper identification to facilitate the connection at site.



Substation Package SS01 for (i) 400/220kV AIS Neemuch New S/S including 400kV class Transformer & Bus Reactor, (ii) Extension of 400kV Chittorgarh S/S and (iii) Extension of 400kV Mandsaur S/S associated with Transmission system for evacuation of power from Neemuch REZ through TBCB route.

General Technical Requirements- Section 3

Doc. No. : TB-418-316-000 Rev 00

4.6 System Parameter

400kV & 220kV System

SL No	Description of parameters	400kV System	220kV System
1.	System operating voltage	400kV	220kV
2.	Maximum operating voltage of the system (rms)	420kV	245kV
3.	Rated frequency	50Hz	50Hz
4.	No. of phase	3	3
5.	Rated Insulation levels		
i)	Full wave impulse withstand voltage (1.2/50 microsec.)	1550kVp	1050 kVp
ii)	Switching impulse withstand voltage (250/2500 micro sec.) dry and wet	1050kVp	-
iii)	One minute power frequency dry withstand voltage (rms)	630kV	-
iv)	One minute power frequency dry and wet withstand voltage (rms)	-	460kV
6.	Corona extinction voltage	320kV	-
7.	Max. radio interference voltage for frequency between 0.5 MHz and 2 MHz	1000 μ V at 266kV rms	1000 μ V at 156kV rms
8.	Minimum creepage distance - for Equipment other than Insulator string	10500 mm	6125 mm
	Minimum creepage distance - for Insulator String	13020 mm	7595 mm
9.	Min. clearances		



Substation Package SS01 for (i) 400/220kV AIS Neemuch New S/S including 400kV class Transformer & Bus Reactor, (ii) Extension of 400kV Chittorgarh S/S and (iii) Extension of 400kV Mandsaur S/S associated with Transmission system for evacuation of power from Neemuch REZ through TBCB route.

General Technical Requirements- Section 3

Doc. No. : TB-418-316-000 Rev 00

i.	Phase to phase	4000mm (for conductor conductor configuration) 4200mm (for rod - conductor configuration)	2100 mm
ii.	Phase to earth	3500 mm	2100 mm
iii)	Sectional clearances	6500 mm	5000 mm
10.	Rated short circuit current for 1 sec. duration	63 kA	50kA
11.	System neutral earthing	Effectively earthed	Effectively earthed

66kV, 52kV, 33kV System

SL No	Description of parameters	66kV System	52 kV System	33 kV System
1.	System operating voltage	66kV	52kV	33kV
2.	Maximum operating voltage of the system(rms)	72.5kV	52kV	36kV
3.	Rated frequency	50Hz	50Hz	50Hz
4.	No. of phase	3	3	3
5.				
i)	Full wave impulse withstand voltage (1.2/50 microsec.)	325 kVp	250 kVp	170 kVp
ii)	One minute power frequency dry and wet withstand voltage (rms)	140kV	95kV	70kV



Substation Package SS01 for (i) 400/220kV AIS Neemuch New S/S including 400kV class Transformer & Bus Reactor, (ii) Extension of 400kV Chittorgarh S/S and (iii) Extension of 400kV Mandsaur S/S associated with Transmission system for evacuation of power from Neemuch REZ through TBCB route.

General Technical Requirements- Section 3

Doc. No. : TB-418-316-000 Rev 00

6.	Max. radio interference voltage for frequency between 0.5 MHz and 2 MHz	-	-	-
7.	Minimum creepage distance	1813 mm (2248mm for coastal area)	1300mm (1612 mm for coastal area)	900 mm (1116m m for coastal area)
8.	Min. Clearance			
i.	Phase to phase	750 mm	530mm	320 mm
ii.	Phase to earth	630 mm	480mm	320 mm
iii.	Sectional clearances	3100 mm	3100mm	2800 mm
9.	Rated short circuit current	25kA for 3 Sec*	25kA for 1 Sec	25 kA for 3 sec
10.	System neutral earthing	Effectively earthed	Effectively earthed	Effectively earthed

Notes:

1. The above parameters are applicable for installations up to an altitude of 1000m above mean sea level. For altitude exceeding 1000m, necessary altitude correction factor shall be applicable as per relevant IEC/IS.
2. The insulation and RIV levels of the equipments shall be as per values given in the Technical Specification of respective equipment.
3. Corona and radio interference voltage test and seismic withstand test procedures for equipments shall be in line with the procedure given at **Annexure-A** and **Annexure-B** respectively.
4. "*" For tertiary loading Equipment's fault level shall be 25kA for 3 Sec.

5.0 ENGINEERING DATA AND DRAWINGS

5.1 Deleted.

5.2 Deleted.



Substation Package SS01 for (i) 400/220kV AIS Neemuch New S/S including 400kV class Transformer & Bus Reactor, (ii) Extension of 400kV Chittorgarh S/S and (iii) Extension of 400kV Mandasaur S/S associated with Transmission system for evacuation of power from Neemuch REZ through TBCB route.

General Technical Requirements- Section 3

Doc. No. : TB-418-316-000 Rev 00

5.3 Drawings

- 5.3.1 All drawings submitted by the Bidder shall be in sufficient detail to indicate the type, size, arrangement, material description, Bill of Materials, weight of each component, break-up for packing and shipment, dimensions, internal & the external connections, fixing arrangement required and any other information specifically requested in the specifications.
- 5.3.2 Drawings submitted by the Bidder shall be clearly marked with the name of the Employer, the unit designation, the specifications title, the specification number and the name of the Project. POWERGRID has standardized a large number of drawings/documents of various make including type test reports which can be used for all projects having similar requirements and in such cases no project specific approval (except for list of applicable drawings alongwith type test reports) is required. However, distribution copies of standard drawings/documents shall be submitted as per provision of the contract. All titles, noting, markings and writings on the drawing shall be in English. All the dimensions should be in SI units.
- 5.3.3 The review of these data by the Employer will cover only general conformance of the data to the specifications and documents, interfaces with the equipment provided under the specifications, external connections and of the dimensions which might affect substation layout. This review by the Employer may not indicate a thorough review of all dimensions, quantities and details of the equipment, materials, any devices or items indicated or the accuracy of the information submitted. This review and/or approval by the Employer shall not be considered by the Contractor, as limiting any of his responsibilities and liabilities for mistakes and deviations from the requirements, specified under these specifications and documents.
- 5.5 All manufacturing and fabrication work in connection with the equipment prior to the approval of the drawings shall be at the Bidder's risk. The Bidder may make any changes in the design which are necessary to make the equipment conform to the provisions and intent of the Contract and such changes will again be subject to approval by the Employer. Approval of Bidder's drawing or work by the Employer shall not relieve the bidder of any of his responsibilities and liabilities under the Contract.
- 5.6 All engineering data submitted by the Bidder after final process including review and approval by the Employer shall form part of the Contract Document and the entire works performed under these specifications shall be performed in strict conformity, unless otherwise expressly requested by the Employer in Writing.



Substation Package SS01 for (i) 400/220kV AIS Neemuch New S/S including 400kV class Transformer & Bus Reactor, (ii) Extension of 400kV Chittorgarh S/S and (iii) Extension of 400kV Mandsaur S/S associated with Transmission system for evacuation of power from Neemuch REZ through TBCB route.

General Technical Requirements- Section 3

Doc. No. : TB-418-316-000 Rev 00

5.7 Approval Procedure

The following schedule shall be followed generally for approval and for providing final documentation.

- | | |
|--|---|
| i) Approval/comments/ by Employer on initial submission | 15 days |
| ii) Resubmission (whenever required) | Within 3 (three) weeks from date of comments |
| iii) Approval or comments | Within 3 (three) weeks of receipt of resubmission |
| iv) Furnishing of distribution copies (2 hard copies to each substation and one scanned copy (pdf format) | Within 3 (three) weeks of receipt of resubmission |
| v) Furnishing of distribution copies of test reports | |
| a) Type test reports
(one scanned softcopy in pdf format to each substation plus one for corporate centre & one hardcopy per substation) | 2 weeks from the date of final approval |
| b) Routine Test Reports
(one copy for each substation) | -do- |
| vi) Furnishing of instruction/ operation manuals (2 copies per substation and one softcopy (pdf format) for corporate centre & per substation) | On completion of Engineering |



Substation Package SS01 for (i) 400/220kV AIS Neemuch New S/S including 400kV class Transformer & Bus Reactor, (ii) Extension of 400kV Chittorgarh S/S and (iii) Extension of 400kV Mandsaur S/S associated with Transmission system for evacuation of power from Neemuch REZ through TCB route.

General Technical Requirements- Section 3

Doc. No. : TB-418-316-000 Rev 00

- | | | |
|------|---|-------------------------------|
| vii) | As built drawings (two sets of hardcopy per substation & one softcopy (pdf format) for corporate centre & per substation) | On completion of entire works |
|------|---|-------------------------------|

NOTE :

- (1) The bidder may please note that all resubmissions must incorporate all comments given in the earlier submission by the Employer or adequate justification for not incorporating the same must be submitted failing which the submission of documents is likely to be returned.
- (2) Deleted.
- (3) The instruction Manuals shall contain full details of drawings of all equipment being supplied under this contract, their exploded diagrams with complete instructions for storage, handling, erection, commissioning, testing, operation, trouble shooting, servicing and overhauling procedures.
- (4) If after the commissioning and initial operation of the substation, the instruction manuals require any modifications/additions/changes, the same shall be incorporated and the updated final instruction manuals shall be submitted by the Contractor to the Employer.
- (5) The Bidder shall furnish to the Employer catalogues of spare parts.
- (6) Deleted.
- 5.8 Deleted.

6.0 MATERIAL/ WORKMANSHIP

6.1 General Requirement

- 6.1.1 Where the specification does not contain references to workmanship, equipment, materials and components of the covered equipment, it is essential that the same must be new, of highest grade of the best quality of their kind, conforming to best engineering practice and suitable for the purpose for which they are intended.
- 6.1.2 In case where the equipment, materials or components are indicated in the specification as "similar" to any special standard, the Employer shall decide upon the question of similarity. When required by the specification or when required by the Employer the Contractor shall submit, for approval, all the information concerning the materials or components to be used in manufacture. Machinery, equipment, materials and components supplied, installed or used without such approval shall run the risk of subsequent rejection, it is to be understood that the cost as well as the time delay associated with the rejection shall be borne by the Bidder.
- 6.1.3 The design of the Works shall be such that installation, future expansions, replacements and general maintenance may be undertaken with a minimum of time and expenses. Each component shall be designed to be consistent with its duty and suitable factors of safety, subject to mutual agreements. All joints and fastenings shall be devised, constructed and documented so that the component parts shall be accurately positioned and restrained to fulfil their required function. In general, screw threads shall be standard metric threads. The use of other thread forms will only be permitted when prior approval has been obtained from the Employer.



Substation Package SS01 for (i) 400/220kV AIS Neemuch New S/S including 400kV class Transformer & Bus Reactor, (ii) Extension of 400kV Chittorgarh S/S and (iii) Extension of 400kV Mandsaur S/S associated with Transmission system for evacuation of power from Neemuch REZ through TBCB route.

General Technical Requirements- Section 3

Doc. No. : TB-418-316-000 Rev 00

- 6.1.4 Whenever possible, all similar part of the Works shall be made to gauge and shall also be made interchangeable with similar parts. All spare parts shall also be interchangeable and shall be made of the same materials and workmanship as the corresponding parts of the Equipment supplied under the Specification. Where feasible, common component units shall be employed in different pieces of equipment in order to minimize spare parts stocking requirements. All equipment of the same type and rating shall be physically and electrically interchangeable.
- 6.1.5 Deleted.
- 6.1.6 The Bidder shall apply oil and grease of the proper specification to suit the machinery, as is necessary for the installation of the equipment. Lubricants used for installation purposes shall be drained out and the system flushed through where necessary for applying the lubricant required for operation. The Bidder shall apply all operational lubricants to the equipment installed by him.
- 6.1.7 All oil, grease and other consumables used in the Works/Equipment shall be purchased in India unless the Bidder has any special requirement for the specific application of a type of oil or grease not available in India. If such is the case, he shall declare source of oil/grease /other consumables in the GTP/Drawings, where such oil or grease is available. He shall help Employer in establishing equivalent Indian make and Indian Contractor. The same shall be applicable to other consumables too.
- 6.2 Provisions For Exposure to Hot and Humid climate**
- Outdoor equipment supplied under the specification shall be suitable for service and storage under tropical conditions of high temperature, high humidity, heavy rainfall and environment favourable to the growth of fungi and mildew. The indoor equipments located in non-air conditioned areas shall also be of same type.
- 6.2.1 Space Heaters**
- 6.2.1.1 The heaters shall be suitable for continuous operation at 240V as supply voltage. Onoff switch and fuse shall be provided.
- 6.2.1.2 One or more adequately rated thermostatically connected heaters shall be supplied to prevent condensation in any compartment. The heaters shall be installed in the compartment and electrical connections shall be made sufficiently away from below the heaters to minimize deterioration of supply wire insulation. The heaters shall be suitable to maintain the compartment temperature to prevent condensation.
- 6.2.2 FUNGI STATIC VARNISH**
- Besides the space heaters, special moisture and fungus resistant varnish shall be applied on parts which may be subjected or predisposed to the formation of fungi due to the presence or deposit of nutrient substances. The varnish shall not be applied to any surface of part where the treatment will interfere with the operation or performance of the equipment. Such surfaces or parts shall be protected against the application of the varnish.
- 6.2.3 Ventilation opening**
- Wherever ventilation is provided, the compartments shall have ventilation openings with fine wire mesh of brass to prevent the entry of insects and to reduce to a minimum the entry of dirt and dust.



Substation Package SS01 for (i) 400/220kV AIS Neemuch New S/S including 400kV class Transformer & Bus Reactor, (ii) Extension of 400kV Chittorgarh S/S and (iii) Extension of 400kV Mandsaur S/S associated with Transmission system for evacuation of power from Neemuch REZ through TBCB route.

General Technical Requirements- Section 3

Doc. No. : TB-418-316-000 Rev 00

6.2.4 Degree of Protection

The enclosures of the Control Cabinets, Junction boxes and Marshalling Boxes, panels etc. to be installed shall comply with following degree of protection as detailed here under:

- a) Installed out door: IP- 55
- b) Installed indoor in air conditioned area: IP-31
- c) Installed in covered area: IP-52
- d) Installed indoor in non-air conditioned area where possibility of entry of water is limited: IP-41.
- e) For LT Switchgear (AC & DC distribution Boards): IP-52

The degree of protection shall be in accordance with IS/IEC60947; IS/IEC/60529 . Type test report for of relevant Degree of Protection test, shall be submitted for approval.

6.3 RATING PLATES, NAME PLATES AND LABELS

6.3.1 Each main and auxiliary item of substation is to have permanently attached to it in a conspicuous position a rating plate of non-corrosive material upon which is to be engraved manufacturer's name, Customer Name, year of manufacture, equipment name, type or serial number together with details of the loading conditions under which the item of substation in question has been designed to operate, and such diagram plates as may be required by the Employer. The rating plate of each equipment shall be according to IS/ IEC requirement.

6.3.2 All such nameplates, instruction plates, rating plates of transformers, reactors, CB, CT, CVT, SA, Isolators, C & R panels and PLCC equipments shall be bilingual with Hindi

inscription first followed by English. Alternatively two separate plates one with Hindi and the other with English inscriptions may be provided.

6.4 FIRST FILL OF CONSUMABLES, OIL AND LUBRICANTS

All the first fill of consumables such as oils, lubricants, filling compounds, touch up paints, soldering/brazing material for all copper piping of circuit breakers and essential chemicals etc. which will be required to put the equipment covered under the scope of the specifications, into operation, shall be furnished by the Bidder unless specifically excluded under the exclusions in these specifications and documents.

7.0 DESIGN IMPROVEMENTS / COORDINATION

7.1 Deleted.

7.2 Deleted.

7.3 The Bidder shall be responsible for the selection and design of appropriate equipments to provide the best co-ordinated performance of the entire system. The basic design requirements are detailed out in this Specification. The design of various components, sub-assemblies and assemblies shall be so done that it facilitates easy field assembly and maintenance.



Substation Package SS01 for (i) 400/220kV AIS Neemuch New S/S including 400kV class Transformer & Bus Reactor, (ii) Extension of 400kV Chittorgarh S/S and (iii) Extension of 400kV Mandsaur S/S associated with Transmission system for evacuation of power from Neemuch REZ through TBCB route.

General Technical Requirements- Section 3

Doc. No. : TB-418-316-000 Rev 00

- 7.4 The Bidder has to coordinate designs and terminations with the agencies (if any) who are Consultants/Bidder for the Employer. The names of agencies shall be intimated to the successful bidders.
- 7.5 The Bidder will be called upon to attend design co-ordination meetings with the Engineer, other Contractor's and the Consultants of the Employer (if any) during the period of Contract. The Bidder shall attend such meetings at his own cost at POWERGRID Corporate Centre, Gurgaon (Haryana) or at mutually agreed venue as and when required and fully cooperate with such persons and agencies involved during those discussions.

8.0 QUALITY ASSURANCE PROGRAMME

- 8.1 To ensure that the equipment and services under the scope of this Contract, whether manufactured or performed within the Bidder's Works or at his Sub-Bidder's premises or at the Employer's site or at any other place of Work as applicable, are in accordance with the specifications, the Contractor shall ensure suitable quality assurance programme to control such activities at all points necessary. A quality assurance programme of the Contractor shall be in line with ISO requirements & shall generally cover the following:
- a) The organisation structure for the management and implementation of the proposed quality assurance programme.
 - b) System for Document and Data Control.
 - c) Qualification and Experience data of Bidder's key personnel.
 - d) The procedure for purchases of materials, parts, components and selection of sub-Bidder's services including vendor analysis, source inspection, incoming raw material inspection, verification of material purchases etc.
 - e) System for shop manufacturing and site erection controls including process controls, fabrication and assembly control.
 - f) System for Control of non-conforming products including deviation dispositioning, if any and system for corrective and preventive actions based on the feedback received from the Customers and also internally documented system for Customer complaints.
 - g) Inspection and test procedure both for manufacture and field activities.
 - h) System for Control of calibration of testing and measuring equipment and the indication of calibration status on the instruments.
 - i) System for indication and appraisal of inspection status.
 - j) System of Internal Quality Audits, Management review and initiation of corrective and Preventive actions based on the above.
 - k) System for authorising release of manufactured product to the Employer.
 - l) System for maintenance of records.
 - m) System for handling, storage and delivery.



Substation Package SS01 for (i) 400/220kV AIS Neemuch New S/S including 400kV class Transformer & Bus Reactor, (ii) Extension of 400kV Chittorgarh S/S and (iii) Extension of 400kV Mandsaur S/S associated with Transmission system for evacuation of power from Neemuch REZ through TBCB route.

General Technical Requirements- Section 3

Doc. No. : TB-418-316-000 Rev 00

- n) A quality plan detailing out the specific quality control measures and procedure adopted for controlling the quality characteristics relevant to each item of equipment furnished and /or service rendered.
- o) System for various field activities i.e. unloading, receipt at site, proper storage, erection, testing and commissioning of various equipment and maintenance of records. In this regard, the Employer has already prepared Standard Field Quality Plan for transmission line/substation equipments as applicable, Civil/erection Works which is required to be followed for associated works.

The Employer or his duly authorised representative reserves the right to carry out quality audit and quality surveillance of the system and procedure of the Bidder/his vendor's quality management and control activities.

8.2 **Quality Assurance Documents**

The Bidder shall ensure availability of the following Quality Assurance Documents:

- i) All Non-Destructive Examination procedures, stress relief and weld repair procedure actually used during fabrication, and reports including radiography interpretation reports.
- ii) Welder and welding operator qualification certificates.
- iii) Welder's identification list, welding operator's qualification procedure and welding identification symbols.
- iv) Raw Material test reports on components as specified by the specification and in the quality plan.
- v) The Manufacturing Quality Plan(MQP) indicating Customer Inspection Points (CIPs) at various stages of manufacturing and methods used to verify that the inspection and testing points in the quality plan were performed satisfactorily.
- vi) Factory test results for testing required as per applicable quality plan/technical specifications/GTP/Drawings etc.
- vii) Stress relief time temperature charts/oil impregnation time temperature charts, wherever applicable.

8.3 **INSPECTION, TESTING & INSPECTION CERTIFICATE**

8.3.1 The responsibility and the basis of inspection for various items & equipment is placed at **Annexure-G** along with the requirement of MQP (Manufacturing Quality Plan), ITP(Inspection & Test Plan), FAT(Factory Acceptance Test) which should be valid & POWERGRID approved and Level of inspection envisaged against each item.

Bidder shall ensure that order for items where MQP/ITP/FAT is required will be placed only on vendors having valid MQP/ITP/FAT and where the supplier's MQP/ITP/FAT is either not valid or has not been approved by POWERGRID, MQP shall be generally submitted as per POWERGRID format before placing order.



Substation Package SS01 for (i) 400/220kV AIS Neemuch New S/S including 400kV class Transformer & Bus Reactor, (ii) Extension of 400kV Chittorgarh S/S and (iii) Extension of 400kV Mandsaur S/S associated with Transmission system for evacuation of power from Neemuch REZ through TBCB route.

General Technical Requirements- Section 3

Doc. No. : TB-418-316-000 Rev 00

Items not covered under MQP/ITP/FAT shall be offered for inspection as per POWERGRID LOA/technical Specifications/POWERGRID approved data sheets/ POWERGRID approved drawings and relevant Indian/International standards.

Inspection Levels: For implementation of projects in a time bound manner and to avoid any delay in deputation of POWERGRID or its authorized representative, involvement of POWERGRID for inspection of various items / equipment will be based on the level below:

Level – I: Bidder to raise all inspection calls and review the report of tests carried out by the manufacturer, on his own, as per applicable standards/ POWERGRID specification, and submit to concerned POWERGRID inspection office/Inspection Engineer. CIP/MICC will be issued by POWERGRID based on review of test reports/certificates of manufacturers.

Level – II: Bidder to raise all inspection calls and carry out the inspection on behalf of POWERGRID on the proposed date of inspection as per applicable standards/specification. However, in case POWERGRID wishes to associate itself during inspection, the same would be intimated to Bidder and CIP/MICC will be issued by POWERGRID. Else, Bidder would submit their test reports/certificates to POWERGRID. CIP/MICC will be issued by POWERGRID based on review of test reports/ certificates.

Level - III: Bidder to raise inspection calls for both, stage (as applicable) & final inspection and carry out the stage inspections (if applicable) on behalf of POWERGRID on the proposed date of inspection as per applicable standards/specification. However, in case POWERGRID wishes to associate itself during stage inspection, the same would be intimated to Bidder and CIP will be issued by POWERGRID. Else, Bidder would submit the test reports / certificates of stage inspection after their own review and CIP will be issued by POWERGRID based on review of test reports / certificates. Final inspection will be carried out by POWERGRID and CIP/MICC will be issued by POWERGRID.

Level – IV: Bidder to raise inspection calls for both, stage (as applicable) & final inspections. POWERGRID will carry out the inspection for both stage & final inspection as per applicable standards/specification and CIP/MICC will be issued by POWERGRID.

8.3.2 Bidder shall ensure that to implement the above inspection levels, particularly for the quality control and inspection at sub-vendor's works, they would depute sufficient qualified & experienced manpower in their Quality Control and Inspection department. Further, to assure quality of construction, Bidder shall have a separate workforce having appropriate qualification & experience and deploy suitable tools and plant for maintaining quality requirement during construction in line with applicable Field Quality Plan (FQP).

8.3.3 The Employer, his duly authorised representative and/or outside inspection agency acting on behalf of the Employer shall have at all reasonable times access to the Bidder's premises or Works and shall have the power at all reasonable times to ensure that proper Quality Management practices / norms are adhered to, inspect and examine the materials & workmanship of the Works, to carry out Quality/Surveillance Audit during manufacture or erection and if part of the Works is being manufactured or assembled at other premises or works. The Bidder shall obtain for the



Substation Package SS01 for (i) 400/220kV AIS Neemuch New S/S including 400kV class Transformer & Bus Reactor, (ii) Extension of 400kV Chittorgarh S/S and (iii) Extension of 400kV Mandasaur S/S associated with Transmission system for evacuation of power from Neemuch REZ through TBCB route.

General Technical Requirements- Section 3

Doc. No. : TB-418-316-000 Rev 00

Employer and for his duly authorised representative permission to inspect as if the works were manufactured or assembled on the Bidder's own premises or works. The item/equipment, if found unsatisfactory with respect to workmanship or material is liable to be rejected. The observations for improvements during product/ process inspection by POWERGRID shall be recorded in Quality Improvement Register (available & maintained at works) for review & timely compliance of observations.

- 8.3.4 Bidder shall submit inspection calls over internet through POWERGRID website. The required vendor code and password to enable raising inspection call will be furnished to the main Contractor within 30 days of award of contract on submission of documents by Contractor. After raising the inspection calls, Contractor shall then proceed as per the message of that particular call which is available on the message board.
- 8.3.5 The Employer reserves the right to witness any or all type, acceptance and routine tests specified for which the Bidder shall give the Employer/Inspector Twenty one (21) days written notice of any material being ready for testing for each stage of testing as identified in the approved quality plan as customer inspection point (CIP) for indigenous inspections. All inspection calls for overseas material shall be given at least forty five (45) days in advance. Such tests shall be to the Bidder's account except for the expenses of the Inspection Engineer. The Employer/inspector, unless witnessing of the tests is waived by Employer, will attend such tests within Twenty one (21) days of the date of which the equipment is notified as being ready for test/inspection, failing which the Bidder may proceed with the test which shall be deemed to have been made in the Inspector's presence and he shall forthwith forward to the Inspector three copies of tests, duly certified. Bidder shall ensure, before giving notice for type test, that all drawings and quality plans have been got approved. The equipment shall be dispatched to site only after approval of Routine and Acceptance test results and Issuance of Dispatch Clearance in writing by the Employer. CIP/Material Inspection clearance certificate (MICC) shall be issued by the Employer after inspection of the equipment or review of test reports as applicable. Employer may waive off the presence of Employer's inspecting engineer. In that case test will be carried out as per approved QP and test certificate will be furnished by the supplier for approval. CIP/MICC will be issued only after review and approval of the test reports.
- 8.3.6 Bidder shall generally offer material for inspection as per supply bar chart approved by POWERGRID and not before 30 days from schedule indicated in the bar chart. In case Bidder offers material(s) for inspection prior to 30 days from the scheduled date with necessary approval of POWERGRID, POWERGRID shall inspect the material and issue CIP only. However, in such an exceptional case, MICC shall be issued only as per provision of original / revised approved supply schedule.
- 8.3.7 Bidder shall minimize the number of inspection calls by offering optimum quantities in each inspection call at the respective manufacturer's works.
- 8.3.8 Bidder shall inspect the material themselves and only after they are fully convinced about the Quality, they shall offer the material for POWERGRID inspection and shall also ensure that relevant portion of LOA/NOA, approved drawing and data sheets along with applicable Quality Plans are available at the works of Contractor or their Sub-vendor before the material is offered for inspection.



Substation Package SS01 for (i) 400/220kV AIS Neemuch New S/S including 400kV class Transformer & Bus Reactor, (ii) Extension of 400kV Chittorgarh S/S and (iii) Extension of 400kV Mandsaur S/S associated with Transmission system for evacuation of power from Neemuch REZ through TCB route.

General Technical Requirements- Section 3

Doc. No. : TB-418-316-000 Rev 00

- 8.3.9 Bidder shall ensure that material which has been cleared for dispatch after inspection will be dispatched within 30 days in case of domestic supplies and within 60 days in case of Off-shore supplies from the date of issuance of CIP. Material which is not dispatched within stipulated time as above will be reoffered for POWERGRID inspection or specific approval of POWERGRID QA&I shall be obtained for delayed dispatch.
- 8.3.10 The Employer or IE shall give notice in writing to the Bidder, of any objection either to conformance to any drawings or to any equipment and workmanship which in his opinion is not in accordance with the Contract. The Bidder shall give due consideration to such objections and shall either make the modifications that may be necessary to meet the said objections or shall confirm in writing to the Employer/Inspection Engineer giving reasons therein, that no modifications are necessary to comply with the Contract.
- 8.3.11 All Test Reports and documents to be submitted in English during final inspection of equipment by POWERGRID or as and when required for submission.
- 8.3.12 When the factory tests have been completed at the Bidder's or Sub-Bidder's works, the Employer/Inspection Engineer(IE) shall issue a certificate to this effect within fifteen (15) days after completion of tests & submission of documents by Bidder/manufacturer but if the tests are not witnessed by the Employer/IE, the certificate shall be issued within fifteen (15) days of receipt of the Bidder's Test certificate by the Employer/IE. Bidder shall, on completion of all tests, submit test reports within Ten (10) days to POWERGRID IE. Failure of the Employer/IE to issue such a certificate shall not prevent the Contractor from proceeding with the Works. The completion of these tests or the issue of the certificate shall not bind the Employer to accept the equipment should, it, on further tests after erection, be found not to comply with the Contract.
- 8.3.13 In all cases, where the Contract provides for tests whether at the premises or works of the Bidder or of any Sub-Bidder, the Bidder, except where otherwise specified, shall provide free of charge such items as labour, materials, electricity, fuel, water, stores, apparatus and instruments as may be reasonably demanded by the Employer/Inspector or his authorised representative to carry out effectively such tests of the equipment in accordance with the Contract and shall give facilities to the Employer/Inspection Engineer or to his authorised representative to accomplish testing.
- 8.3.14 The inspection and acceptance by Employer and issue of Inspection Certificate thereon shall in no way limit the liabilities and responsibilities of the Contractor in respect of the agreed quality assurance programme forming a part of the Contract, or if such equipment is found to be defective at a later stage.
- 8.3.15 The Employer will have the right of having at his own expenses any other test(s) of reasonable nature carried out at Contractor's premises or at site or in any other place in addition of aforesaid type and routine tests, to satisfy that the material comply with the specification.
- 8.3.16 The Employer reserves the right for getting any additional field tests conducted on the completely assembled equipment at site to satisfy that material complies with specifications.
- 8.3.17 Rework/ Re-engineering, if any, on any item/equipment shall be carried out only after mutual discussions and in accordance with mutually agreed procedure. Bidder shall submit Joint Inspection Report of equipments under Re-Work/Re-Engineering alongwith procedure for the



Substation Package SS01 for (i) 400/220kV AIS Neemuch New S/S including 400kV class Transformer & Bus Reactor, (ii) Extension of 400kV Chittorgarh S/S and (iii) Extension of 400kV Mandsaur S/S associated with Transmission system for evacuation of power from Neemuch REZ through TBCB route.

General Technical Requirements- Section 3

Doc. No. : TB-418-316-000 Rev 00

same to POWERGRID for approval, before taking up the Re-Work/Re-Engineering, failing which POWERGRID reserves the right to reject the equipment.

- 8.3.18 Bidder may establish a field test Laboratory to execute Civil Construction testing requirements at site with the condition that all testing equipment shall be calibrated from POWERGRID approved accredited Testing laboratories, with calibration certificates kept available at site and all testing personnel employed in the Field Testing Laboratories to be qualified and experienced Engineers or testing to be carried out at POWERGRID approved Third Party Laboratories.
- 8.3.19 Bidder shall ensure that all possible steps are taken to avoid damages to the equipment during transport, storage and erection.
- 8.3.20 Deleted.
- 8.3.21 Bidder shall ensure commissioning of all CSDs along with Circuit Breakers wherever applicable.

8.3.22 For EHV transformers/reactors:

Insulation oil shall be as per POWERGRID Technical specifications and same grade shall be used for impregnation of the active part & testing at the works of Transformer/Reactor Manufacturer and as well as for filling the Transformer/Reactors at site. Bidder to ensure that windings for Transformer/Reactors are made in air conditioned environment. Core-coil assembly shall be performed in positive pressurized dust controlled environment. Dust measurements shall be monitored regularly at Transformer / Reactor Manufacturer works. Contractor shall ensure that respective civil foundations & Fire walls for Transformer/Reactors units to be commissioned, shall be made ready at concerned sites before receipt of Transformer/Reactors units.

- 8.3.23 The Employer reserves the right to increase or decrease their involvement in inspections at Bidder's Works or at his Sub-Bidder's premises or at the Employer's site or at any other place of Work based on performance of Bidder/sub-bidder.

9.0 TYPE TESTING & CLEARANCE CERTIFICATE

- 9.1 Deleted.
- 9.2 Deleted.
- 9.3 The Employer intends to repeat those type tests which are indicated in the price schedule and the same shall be payable as per provision of contract. The price of conducting type tests shall be included in Bid price and break up of these shall be given in the relevant schedule of Bid Proposal Sheets. These Type test charges would be considered in bid evaluation. In case Bidder does not indicate charges for any of the type tests or does not mention the name of any test in the price schedules, it will be presumed that the particular test has been offered free of charge. Further, in case any Bidder indicates that he shall not carry out a particular test, his offer shall be considered incomplete and shall be liable to be rejected. The Employer reserves the right to waive the repeating of type tests partly or fully and in case of waiver, test charges for the same shall not be payable.
- 9.4 The Employer reserves the right to witness any or all the type tests. The Employer shall bear all expenses for deputation of Employer's representative(s) for witnessing the type tests except in the case of re-deputation if any, necessitated due to no fault of the Employer.



Substation Package SS01 for (i) 400/220kV AIS Neemuch New S/S including 400kV class Transformer & Bus Reactor, (ii) Extension of 400kV Chittorgarh S/S and (iii) Extension of 400kV Mandsaur S/S associated with Transmission system for evacuation of power from Neemuch REZ through TBCB route.

General Technical Requirements- Section 3

Doc. No. : TB-418-316-000 Rev 00

9.5 The list of makes of various items, for which Type test reports are not required to be submitted are specified at Annexure-J.

10.0 Deleted.

11.0 PACKAGING & PROTECTION

11.1 All the equipments shall be suitably protected, coated, covered or boxed and crated to prevent damage or deterioration during transit, handling and storage at Site till the time of erection. On request of the Employer, the Bidder shall also submit packing details/associated drawing for any equipment/material under his scope of supply, to facilitate the Employer to repack any equipment/material at a later date, in case the need arises. While packing all the materials, the limitation from the point of view of availability of Railway wagon sizes in India should be taken into account. The Bidder shall be responsible for any loss or damage during transportation, handling and storage due to improper packing. Any demurrage, wharfage and other such charges claimed by the transporters, railways etc. shall be to the account of the Contractor. Employer/BHEL takes no responsibility of the availability of the wagons.

11.2 All coated surfaces shall be protected against abrasion, impact, discolouration and any other damages. All exposed threaded portions shall be suitably protected with either a metallic or a non-metallic protecting device. All ends of all valves and pipings and conduit equipment connections shall be properly sealed with suitable devices to protect them from damage.

12.0 FINISHING OF METAL SURFACES

12.1 All metal surfaces shall be subjected to treatment for anti-corrosion protection. All ferrous surfaces for external use unless otherwise stated elsewhere in the specification or specifically agreed, shall be hot-dip galvanized after fabrication. All steel conductors including those used for earthing/grounding (above ground level) shall also be galvanized according to IS: 2629.

12.2 HOT DIP GALVANISING

12.2.1 The minimum weight of the zinc coating shall be 610 gm/sq.m and minimum average thickness of coating shall be 86 microns for all items having thickness 6mm and above. For items lower than 6mm thickness requirement of coating thickness shall be as per relevant ASTM. For surface which shall be embedded in concrete, the zinc coating shall be 610 gm/sq.m minimum.

12.2.2 The galvanized surfaces shall consist of a continuous and uniform thick coating of zinc, firmly adhering to the surface of steel. The finished surface shall be clean and smooth and shall be free from defects like discoloured patches, bare spots, unevenness of coating, spelter which is loosely attached to the steel globules, spiky deposits, blistered surface, flaking or peeling off, etc. The presence of any of these defects noticed on visual or microscopic inspection shall render the material liable to rejection.



Substation Package SS01 for (i) 400/220kV AIS Neemuch New S/S including 400kV class Transformer & Bus Reactor, (ii) Extension of 400kV Chittorgarh S/S and (iii) Extension of 400kV Mandsaur S/S associated with Transmission system for evacuation of power from Neemuch REZ through TBCB route.

General Technical Requirements- Section 3

Doc. No. : TB-418-316-000 Rev 00

- 12.2.3 After galvanizing, no drilling or welding shall be performed on the galvanized parts of the equipment excepting that nuts may be threaded after galvanizing. Sodium dichromate or alternate approved treatment shall be provided to avoid formation of white rust after hot dip galvanization.
- 12.2.4 The galvanized steel shall be subjected to four numbers of one minute dips in copper sulphate solution as per IS-2633.
- 12.2.5 Sharp edges with radii less than 2.5 mm shall be able to withstand four immersions of the Standard Preece test. All other coatings shall withstand six immersions. The following galvanizing tests should essentially be performed as per relevant Indian Standards.
- Coating thickness
 - Uniformity of zinc
 - Adhesion test
 - Mass of zinc coating
- 12.2.6 Galvanised material must be transported properly to ensure that galvanised surfaces are not damaged during transit. Application of touch-up zinc rich paint at site shall be allowed with approval of Engineer Incharge.

12.3 PAINTING

- 12.3.1 All sheet steel work shall be degreased, pickled, phosphated in accordance with the IS6005 "Code of practice for phosphating iron and sheet". All surfaces, which will not be easily accessible after shop assembly, shall beforehand be treated and protected for the life of the equipment. The surfaces, which are to be finished painted after installation or require corrosion protection until installation, shall be shop painted with at least two coats of primer. Oil, grease, dirt and swaf shall be thoroughly removed by emulsion cleaning. Rust and scale shall be removed by pickling with dilute acid followed by washing with running water, rinsing with slightly alkaline hot water and drying.
- 12.3.2 Hot Phosphating shall be done for phosphating process under pretreatment of sheets After phosphating, thorough rinsing shall be carried out with clean water followed by final rinsing with dilute dichromate solution and oven drying. The phosphate coating shall be sealed with application of two coats of ready mixed, stoving type zinc chromate primer. The first coat may be "flash dried" while the second coat shall be stoved.
- 12.3.3 After application of the primer, two coats of finishing synthetic enamel paint shall be applied, each coat followed by stoving. The second finishing coat shall be applied after inspection of first coat of painting.
- 12.3.4 The exterior and interior colour of the paint in case of new substations shall preferably be RAL 7032 for all equipment, marshalling boxes, junction boxes, control cabinets, panels etc. unless specifically mentioned under respective sections of the equipments. Glossy white colour inside the equipments /boards /panels/junction boxes is also acceptable. The exterior colour for panels shall be matching with the existing panels in case of extension of a substation. Each coat of primer and finishing paint shall be of slightly different shade to enable inspection of the painting. A small quantity of finishing paint shall be supplied for minor touching up required at site after installation of the equipments.



Substation Package SS01 for (i) 400/220kV AIS Neemuch New S/S including 400kV class Transformer & Bus Reactor, (ii) Extension of 400kV Chittorgarh S/S and (iii) Extension of 400kV Mandsaur S/S associated with Transmission system for evacuation of power from Neemuch REZ through TBCB route.

General Technical Requirements- Section 3

Doc. No. : TB-418-316-000 Rev 00

12.3.5 In case the contractor proposes to follow his own standard surface finish and protection procedures or any other established painting procedures, like electrostatic painting etc., the procedure shall be submitted during detailed engineering for Employer's review & approval.

12.3.6 The colour scheme as given below shall be followed for Fire Protection and Air Conditioning systems

S.No.	PIPE LINE	Base colour	Band colour
<u>Fire Protection System</u>			
1	Hydrant and Emulsifier system pipeline/NIFPS	FIRE RED	-
2	Emulsifier system detection line – water	FIRE RED	Sea Green
3	Emulsifier system detection line –Air	FIRE RED	Sky Blue
4	Pylon support pipes	FIRE RED	
<u>Air Conditioning Plant</u>			
5	Refrigerant gas pipeline – at compressor suction	Canary Yellow	-
6	Refrigerant gas pipeline – at compressor discharge	Canary Yellow	Red
7	Refrigerant liquid pipeline	Dark Admiralty Green	-
8	Chilled water pipeline	Sea Green	-
9	Condenser water pipeline	Sea Green	Dark Blue

The direction of flow shall be marked by → (arrow) in black colour.



Base Colour Direction of flow Band Colour

12.3.7 For aluminium casted surfaces, the surface shall be with smooth finish. Further, in case of aluminium enclosures, the surface shall be coated with powder (coating thickness of 60 microns) after surface preparation for painting. For stainless steel surfaces, no painting is envisaged.

12.3.8 Band colour is required for Emulsifier system detection line only if both water and air detection lines are present at the same substation. Further, band colour shall be applied at an interval of 2 meters approx. along the length and minimum width of band shall be 25mm.

13.0 Deleted.



Substation Package SS01 for (i) 400/220kV AIS Neemuch New S/S including 400kV class Transformer & Bus Reactor, (ii) Extension of 400kV Chittorgarh S/S and (iii) Extension of 400kV Mandsaur S/S associated with Transmission system for evacuation of power from Neemuch REZ through TBCB route.

General Technical Requirements- Section 3

Doc. No. : TB-418-316-000 Rev 00

14.0 TOOLS

14.1 Deleted.

14.2 SPECIAL TOOLS AND TACKLES

The bidder shall supply all special tools and tackles required for Operation and maintenance of equipment. The special tools and tackles shall only cover items which are specifically required for the equipment offered and are proprietary in nature. The list of special tools and tackles, if any, shall be finalized during detail engineering and the same shall be supplied without any additional cost implication to the Employer.

14.3 Deleted.

15.0 AUXILIARY SUPPLY

15.1 The auxiliary power for station supply, including the equipment drive, cooling system of any equipment, air-conditioning, lighting etc shall be designed for the specified Parameters as under. The DC supply for the instrumentation and PLCC system shall also conform the parameters as indicated in the following table:

Normal Voltage	Variation in Voltage	Frequency in HZ	Phase/Wire	Neutral connection
415V	$\pm 10\%$	$50 \pm 5\%$	3/4 Wire	Solidly Earthed.
240V	$\pm 10\%$	$50 \pm 5\%$	1/2 Wire	Solidly Earthed.
220V	190V to 240V	DC	Isolated 2 wire System	-
110V	95V to 120V	DC	Isolated 2 wire System	-
48V	--	DC	2 wire system (+) earthed	-

Combined variation of voltage and frequency shall be limited to $\pm 10\%$.

15.2 Pickup value of binary input modules of Intelligent Electronic Devices, Digital protection couplers, Analog protection couplers shall not be less than 50% of the specified rated station auxiliary DC supply voltage level.



Substation Package SS01 for (i) 400/220kV AIS Neemuch New S/S including 400kV class Transformer & Bus Reactor, (ii) Extension of 400kV Chittorgarh S/S and (iii) Extension of 400kV Mandsaur S/S associated with Transmission system for evacuation of power from Neemuch REZ through TBCB route.

General Technical Requirements- Section 3

Doc. No. : TB-418-316-000 Rev 00

16.0 SUPPORT STRUCTURE (ONLY OF CIRCUIT BREAKER)

- 16.1 The equipment support structures shall be suitable for equipment connections at the first level i.e 14.0 meter, 8.0 meter, 5.9 meter and 4.6 meter from plinth level for 765kV, 400kV, 220kV and 132kV substations respectively. All equipment support structures shall be supplied alongwith brackets, angles, stools etc. for attaching the operating mechanism, control cabinets & marshalling box (wherever applicable) etc.
- 16.2 The minimum vertical distance from the bottom of the lowest porcelain/polymer part of the bushing, porcelain/polymer enclosures or supporting insulators to the bottom of the equipment base, where it rests on the foundation pad shall be 2.55 metres.

17.0 CLAMPS AND CONNECTORS INCLUDING TERMINAL CONNECTORS (For Lightning Arrester & Wave Trap only)

- 17.1 All power clamps and connectors shall conform to IS:5561 or other equivalent international standard and shall be made of materials listed below :

Sl. No.	Description	Materials
a)	For connecting ACSR conductors/AAC conductors/ Aluminium tube	Aluminum alloy casting, conforming to designation 4600 of IS:617 and all test shall conform to IS:617
b)	For connecting equipment terminals mad of copper with ACSR conductors/AAC conductors/ Aluminium tube	Bimetallic connectors made from aluminum alloy casting, conforming to designation 4600 of IS:617 with 2mm thick bimetallic liner/strip and all test shall conform to IS:617
c)	For connecting G.I	Galvanised mild steel shield wire
d)	Bolts, nuts & plain washers	Electro-galvanised for sizes below M12, for others hot dip galvanised.
e)	Spring washers	Electro-galvanised mild steel suitable for atleast service condition-3 as per IS:1573

- 17.2 Necessary clamps and connectors shall be supplied for all equipment and connections. If corona rings are required to meet these requirements they shall be considered as part of that equipment and included in the scope of work.
- 17.3 Where copper to aluminum connections are required, bi-metallic clamps shall be used, which shall be properly designed to ensure that any deterioration of the connection is kept to a minimum and restricted to parts which are not current carrying or subjected to stress.
- 17.4 Low voltage connectors, grounding connectors and accessories for grounding all equipment as specified in each particular case, are also included in the scope of Work.



Substation Package SS01 for (i) 400/220kV AIS Neemuch New S/S including 400kV class Transformer & Bus Reactor, (ii) Extension of 400kV Chittorgarh S/S and (iii) Extension of 400kV Mandasaur S/S associated with Transmission system for evacuation of power from Neemuch REZ through TBCB route.

General Technical Requirements- Section 3

Doc. No. : TB-418-316-000 Rev 00

- 17.5 No current carrying part of any clamp shall be less than 10 mm thick. All ferrous parts shall be hot dip galvanised. Copper alloy liner/strip of minimum 2 mm thickness shall be cast integral with aluminum body or 2 mm thick bi-metallic liner/strips shall be provided for Bi-metallic clamps.
- 17.6 All casting shall be free from blow holes, surface blisters, cracks and cavities. All sharp edges and corners shall be blurred and rounded off.
- 17.7 Flexible connectors, braids or laminated straps made for the terminal clamps for bus posts shall be suitable for both expansion or through (fixed/sliding) type connection of IPS AL tube as required. In both the cases the clamp height (top of the mounting pad to centre line of the tube) should be same.
- 17.8 Current carrying parts (500A and above) of the clamp/connector shall be provided with minimum four numbers of bolts preferably for 132kV and above.
- 17.9 All current carrying parts shall be designed and manufactured to have minimum contact resistance.
- 17.10 Power Clamps and connectors shall be designed to control corona as per requirement.

17.11 Tests

Clamps and connectors should be type tested on minimum three samples as per IS:5561 and shall also be subjected to routine tests as per IS:5561. Following type test reports shall be submitted for approval. Type test once conducted shall hold good. The requirement of test conducted within last ten years, shall not be applicable.

- i) Temperature rise test (maximum temperature rise allowed is 35°C over 50°C ambient)
- ii) Short time current test
- iii) Corona (dry) and RIV (dry) test [for 132kV and above voltage level clamps]
- iv) Resistance test and Pullout strength test
- v) Cantilever Strength test on bus support clamps & connectors

vi)

18.0 CONTROL CABINETS, JUNCTION BOXES, TERMINAL BOXES MARSHALLING BOXES FOR OUTDOOR EQUIPMENT

- 18.1 All types of boxes, cabinets etc. shall generally conform to & be tested in accordance with IS/IEC 61439-0, as applicable, and the clauses given below:
- 18.2 Control cabinets, junction boxes, Marshalling boxes & terminal boxes, Out door ACDB cum DCDB panels shall be made of stainless steel of atleast 1.5 mm thick or aluminum enclosure of atleast 1.6 mm thick and shall be dust, water and vermin proof. Stainless steel used shall be of grade SS304 (SS316 for coastal area) or better. The box shall be properly braced to prevent wobbling. There shall be sufficient reinforcement to provide level surfaces, resistance to vibrations and rigidity during transportation and installation. In case of aluminum enclosed box the thickness of aluminum shall be such that it provides adequate rigidity and long life as comparable with sheet steel of specified thickness.



Substation Package SS01 for (i) 400/220kV AIS Neemuch New S/S including 400kV class Transformer & Bus Reactor, (ii) Extension of 400kV Chittorgarh S/S and (iii) Extension of 400kV Mandsaur S/S associated with Transmission system for evacuation of power from Neemuch REZ through TBCB route.

General Technical Requirements- Section 3

Doc. No. : TB-418-316-000 Rev 00

Control cabinets, junction boxes, marshalling boxes & terminal boxes, out-door ACDB cum DCDB panels shall have adequate space/clearance as per guidelines/technical specifications to access/replace any component. Necessary component labelling to be also done on non-conducting sheet.

For CONTROL CABINETS, JUNCTION BOXES, TERMINAL BOXES MARSHALLING BOXES FOR OUTDOOR EQUIPMENT Junction Box, wire should be as per IS or equivalent IEC with FRLS grade

Machine laid PU Foam gasket may be permitted for use in Control Cabinets etc.

- 18.3 A canopy and sealing arrangements for operating rods shall be provided in marshalling boxes / Control cabinets to prevent ingress of rain water.
- 18.4 Cabinet/boxes with width more than 700 mm shall be provided with double hinged doors with padlocking arrangements. The distance between two hinges shall be adequate to ensure uniform sealing pressure against atmosphere.
- 18.5 All doors, removable covers and plates shall be gasketed all around with suitably profiled EPDM/Neoprene/PU gaskets. The gasket shall be tested in accordance with approved quality plan, IS:11149 and IS:3400. Ventilating Louvers, if provided, shall have screen and filters. The screen shall be fine wire mesh made of brass.
- Further, the gasketing arrangement shall be such that gaskets are pasted in slots (in door fabrication/gasket itself) in order to prevent ingress of dust and moisture inside the panels so that no internal rusting occurs in panels during the operation of the equipment.
- 18.6 All boxes/cabinets shall be designed for the entry of cables by means of weather proof and dust-proof connections. Boxes and cabinets shall be designed with generous clearances to avoid interference between the wiring entering from below and any terminal blocks or accessories mounted within the box or cabinet. Suitable cable gland plate above the base of the marshalling kiosk/box shall be provided for this purpose along with the proper blanking plates. Necessary number of cable glands shall be supplied and fitted on this gland plate. Gland plate shall have provision for some future glands to be provided later, if required. The Nickel plated glands shall be dust proof, screw on & double compression type and made of brass. The gland shall have provision for securing armour of the cable separately and shall be provided with earthing tag. The glands shall conform to BS:6121.
- 18.7 A 240V, single phase, 50 Hz, 15 amp AC plug and socket shall be provided in the cabinet with ON-OFF switch for connection of hand lamps. Plug and socket shall be of industrial grade.
- 18.8 LED based illumination of minimum 9 watts shall be provided. The switching of the fittings shall be controlled by the door switch.
- For junction boxes of smaller sizes such as lighting junction box, manual operated earth switch mechanism box etc., plug socket, heater and illumination is not required to be provided.
- 18.9 All control switches shall be of MCB/rotary switch type and Toggle/piano switches shall not be accepted.



Substation Package SS01 for (i) 400/220kV AIS Neemuch New S/S including 400kV class Transformer & Bus Reactor, (ii) Extension of 400kV Chittorgarh S/S and (iii) Extension of 400kV Mandsaur S/S associated with Transmission system for evacuation of power from Neemuch REZ through TCB route.

General Technical Requirements- Section 3

Doc. No. : TB-418-316-000 Rev 00

- 18.10 Earthing of the cabinet shall be ensured by providing two separate earthing pads. The earth wire shall be terminated on to the earthing pad and secured by the use of self etching washer. Earthing of hinged door shall be done by using a separate earth wire.
- 18.11 The bay marshalling kiosks shall be provided with danger plate and a diagram showing the numbering/connection/feruling by pasting the same on the inside of the door.
- 18.12 The following routine tests alongwith the routine tests as per IS:5039 shall also be conducted:
- i) Check for wiring
 - ii) Visual and dimension check
- 18.13 The enclosure of bay marshalling kiosk, junction box, terminal box and control cabinets shall conform to IP-55 as per IS/IEC60947 including application of 1kV rms for 1 (one) minute, after IP-55 test.
- 19.0 Deleted.**

20.0 TERMINAL BLOCKS AND WIRING

- 20.1 Control and instrument leads from the switchboards or from other equipment will be brought to terminal boxes or control cabinets in conduits. All interphase and external connections to equipment or to control cubicles will be made through terminal blocks.
- 20.2 Terminal blocks shall be 650V grade and have continuous rating to carry the maximum expected current on the terminals and non-breakable type. These shall be of moulded piece, complete with insulated barriers, stud type terminals, washers, nuts and lock nuts. Screw clamp, overall insulated, insertion type, rail mounted terminals can be used in place of stud type terminals. But the terminal blocks shall be non-disconnecting stud type except for the secondary junction boxes of Current Transformer and Voltage Transformer.
- 20.3 Terminal blocks for current transformer and voltage transformer secondary leads shall be provided with test links and isolating facilities. The current transformer secondary leads shall also be provided with short circuiting and earthing facilities.
- 20.4 The terminal shall be such that maximum contact area is achieved when a cable is terminated. The terminal shall have a locking characteristic to prevent cable from escaping from the terminal clamp unless it is done intentionally.
- 20.5 The conducting part in contact with cable shall preferably be tinned or silver plated however Nickel plated copper or zinc plated steel shall also be acceptable.
- 20.6 The terminal blocks shall be of extensible design, multilayer terminal arrangement is not allowed in any junction box (Common MB, Individual MB, JB etc.). There should be sufficient space at both sides of terminals so that ferrule number of wires / TB numbers are clearly visible during wire removal or insertion.
- 20.7 The terminal blocks shall have locking arrangement to prevent its escape from the mounting rails.



Substation Package SS01 for (i) 400/220kV AIS Neemuch New S/S including 400kV class Transformer & Bus Reactor, (ii) Extension of 400kV Chittorgarh S/S and (iii) Extension of 400kV Mandasaur S/S associated with Transmission system for evacuation of power from Neemuch REZ through TBCB route.

General Technical Requirements- Section 3

Doc. No. : TB-418-316-000 Rev 00

- 20.8 The terminal blocks shall be fully enclosed with removable covers of transparent, nondeteriorating type plastic material. Insulating barriers shall be provided between the terminal blocks. These barriers shall not hinder the operator from carrying out the wiring without removing the barriers.
- 20.9 Unless otherwise specified terminal blocks shall be suitable for connecting the following conductors on each side.
- | | |
|---------------------------------------|---|
| a) All circuits except CT/PT circuits | Minimum of two of
2.5 sq mm copper
flexible. |
| b) All CT/PT circuits | Minimum of 4 nos. of
2.5 sq mm copper
flexible. |
- 20.10 The arrangements shall be in such a manner so that it is possible to safely connect or disconnect terminals on live circuits and replace fuse links when the cabinet is live.
- 20.11 Atleast 20 % spare terminals shall be provided on each panel/cubicle/box and these spare terminals shall be uniformly distributed on all terminals rows.
- 20.12 There shall be a minimum clearance of 250 mm between the First/bottom row of terminal block and the associated cable gland plate for outdoor ground mounted marshalling box and the clearance between two rows of terminal blocks shall be a minimum of 150 mm.
- 20.13 The Contractor shall furnish all wire, conduits and terminals for the necessary interphase electrical connections (where applicable) as well as between phases and common terminal boxes or control cabinets

21.0 LAMPS & SOCKETS

21.1 Lamps & Sockets

All lamps shall use a socket base as per IS-1258, except in the case of signal lamps.

All sockets (convenience outlets) shall be suitable to accept both 5 Amp & 15 Amp pin round Standard Indian plugs. They shall be switched sockets with shutters.

21.2 Hand Lamp:

A 240 Volts, single Phase, 50 Hz AC plug point shall be provided in the interior of each cubicle with ON-OFF Switch for connection of hand lamps.

21.3 Switches and Fuses:

- 21.3.1 Each panel shall be provided with necessary arrangements for receiving, distributing, isolating and fusing of DC and AC supplies for various control, signaling, lighting and space heater circuits. The incoming and sub-circuits shall be separately provided with miniature circuit breaker / switch fuse units. Selection of the main and Sub-circuit fuse ratings shall be such as to ensure selective



Substation Package SS01 for (i) 400/220kV AIS Neemuch New S/S including 400kV class Transformer & Bus Reactor, (ii) Extension of 400kV Chittorgarh S/S and (iii) Extension of 400kV Mandsaur S/S associated with Transmission system for evacuation of power from Neemuch REZ through TCB route.

General Technical Requirements- Section 3

Doc. No. : TB-418-316-000 Rev 00

clearance of sub-circuit faults. Potential circuits for relaying and metering shall be protected by HRC fuses.

- 21.3.2 All fuses shall be of HRC cartridge type conforming to relevant IS mounted on plug-in type fuse bases. Miniature circuit breakers with thermal protection and alarm contacts will also be accepted. All accessible live connection to fuse bases shall be adequately shrouded. Fuses shall have operation indicators for indicating blown fuse condition. Fuse carrier base shall have imprints of the fuse rating and voltage.

22.0 BUSHINGS, HOLLOW COLUMN INSULATORS, SUPPORT INSULATORS:

- 22.1 Bushings shall be manufactured and tested in accordance with IS:2099 & IEC-60137 while hollow column insulators shall be manufactured and tested in accordance with IEC-62155/IS:5621. The support insulators shall be manufactured and tested as per IS:2544/IEC-60168 and IEC-60273. The insulators shall also conform to IEC-60815 as applicable.

The bidder may also offer composite hollow insulators, conforming to IEC-61462.

- 22.2 Support insulators, bushings and hollow column insulators shall be manufactured from high quality porcelain. Porcelain used shall be homogeneous, free from laminations, cavities and other flaws or imperfections that might affect the mechanical or dielectric quality and shall be thoroughly vitrified tough and impervious to moisture.

- 22.3 Glazing of the porcelain shall be uniform brown in colour, free from blisters, burrs and similar other defects.

- 22.4 Support insulators/bushings/hollow column insulators shall be designed to have ample insulation, mechanical strength and rigidity for the conditions under which they will be used.

- 22.5 When operating at normal rated voltage there shall be no electric discharge between the conductors and bushing which would cause corrosion or injury to conductors, insulators or supports by the formation of substances produced by chemical action. No radio interference shall be caused by the insulators/bushings when operating at the normal rated voltage.

- 22.6 Bushing porcelain shall be robust and capable of withstanding the internal pressures likely to occur in service. The design and location of clamps and the shape and the strength of the porcelain flange securing the bushing to the tank shall be such that there is no risk of fracture. All portions of the assembled porcelain enclosures and supports other than gaskets, which may in any way be exposed to the atmosphere shall be composed of completely non hygroscopic material such as metal or glazed porcelain.

- 22.7 All iron parts shall be hot dip galvanised and all joints shall be air tight. Surface of joints shall be trued up porcelain parts by grinding and metal parts by machining. Insulator/bushing design shall be such as to ensure a uniform compressive pressure on the joints.

- 22.8 Void

- 22.9 Deleted.



Substation Package SS01 for (i) 400/220kV AIS Neemuch New S/S including 400kV class Transformer & Bus Reactor, (ii) Extension of 400kV Chittorgarh S/S and (iii) Extension of 400kV Mandsaur S/S associated with Transmission system for evacuation of power from Neemuch REZ through TBCB route.

General Technical Requirements- Section 3

Doc. No. : TB-418-316-000 Rev 00

23.0 MOTORS

Motors shall be "Squirrel Cage" three phase induction motors of sufficient size capable of satisfactory operation for the application and duty as required for the driven equipment and shall be subjected to routine tests as per applicable standards. The motors shall be of approved make.

23.1 Enclosures

- a) Motors to be installed outdoor without enclosure shall have hose proof enclosure equivalent to IP-55 as per IS: 4691. For motors to be installed indoor i.e. inside a box, the motor enclosure, shall be dust proof equivalent to IP-44 as per IS: 4691.
- b) Two independent earthing points shall be provided on opposite sides of the motor for bolted connection of earthing conductor.
- c) Motors shall have drain plugs so located that they will drain water resulting from condensation or other causes from all pockets in the motor casing.
- d) Motors weighing more than 25 Kg. shall be provided with eyebolts, lugs or other means to facilitate lifting.

23.2 Operational Features

- a) Continuous motor rating (name plate rating) shall be at least ten (10) percent above the maximum load demand of the driven equipment at design duty point and the motor shall not be over loaded at any operating point of driven equipment that will rise in service.
- b) Motor shall be capable at giving rated output without reduction in the expected life span when operated continuously in the system having the particulars as given in Clause 15.0 of this Section.

23.3 Starting Requirements:

- a) All induction motors shall be suitable for full voltage direct-on-line starting. These shall be capable of starting and accelerating to the rated speed alongwith the driven equipment without exceeding the acceptable winding temperature even when the supply voltage drops down to 80% of the rated voltage.
- b) Motors shall be capable of withstanding the electrodynamic stresses and heating imposed if it is started at a voltage of 110% of the rated value.
- c) The locked rotor current shall not exceed six (6) times the rated full load current for all motors, subject to tolerance as given in IS:325.
- d) Motors when started with the driven equipment imposing full starting torque under the supply voltage conditions specified under Clause 15.0 shall be capable of withstanding atleast two successive starts from cold condition at room temperature and one start from hot condition without injurious heating of winding. The motors shall also be suitable for three equally spread starts per hour under the above referred supply condition.
- e) The locked rotor withstand time under hot condition at 110% of rated voltage shall be more than starting time with the driven equipment of minimum permissible voltage by at least two seconds or 15% of the accelerating time whichever is greater. In case it is not possible to meet the above requirement, the Bidder shall offer centrifugal type speed switch mounted on the motor shaft



Substation Package SS01 for (i) 400/220kV AIS Neemuch New S/S including 400kV class Transformer & Bus Reactor, (ii) Extension of 400kV Chittorgarh S/S and (iii) Extension of 400kV Mandsaur S/S associated with Transmission system for evacuation of power from Neemuch REZ through TBCB route.

General Technical Requirements- Section 3

Doc. No. : TB-418-316-000 Rev 00

which shall remain closed for speed lower than 20% and open for speeds above 20% of the rated speed. The speed switch shall be capable of withstanding 120% of the rated speed in either direction of rotation.

23.4 Running Requirements:

- a) The maximum permissible temperature rise over the ambient temperature of 50 degree C shall be within the limits specified in IS:325 (for 3-phase induction motors) after adjustment due to increased ambient temperature specified.
- b) The double amplitude of motor vibration shall be within the limits specified in IS: 4729. Vibration shall also be within the limits specified by the relevant standard for the driven equipment when measured at the motor bearings.
- c) All the induction motors shall be capable of running at 80% of rated voltage for a period of 5 minutes with rated load commencing from hot condition.

23.5 TESTING AND COMMISSIONING

An indicative list of tests is given below. Contractor shall perform any additional test based on specialities of the items as per the field Q.P./Instructions of the equipment Contractor or Employer without any extra cost to the Employer. The Contractor shall arrange all instruments required for conducting these tests alongwith calibration certificates and shall furnish the list of instruments to the Employer for approval.

- (a) Insulation resistance.
- (b) Phase sequence and proper direction of rotation.
- (c) Any motor operating incorrectly shall be checked to determine the cause and the conditions corrected

CORONA AND RADIO INTERFERENCE VOLTAGE (RIV) TEST

1. General

Unless otherwise stipulated, all equipment together with its associated connectors, where applicable, shall be tested for external corona (for 400kV & above) both by observing the voltage level for the extinction of visible corona under falling power frequency voltage and by measurement of radio interference voltage (RIV) for 132kV and above.

2. Test Levels:

The test voltage levels for measurement of external RIV and for corona extinction voltage are listed under the relevant clauses of the specification.

3. Test Methods for RIV:

3.1 RIV tests shall be made according to measuring circuit as per International Special-Committee on Radio Interference (CISPR) Publication 16-1(1993) Part -1. The measuring circuit shall preferably be tuned to frequency with 10% of 0.5 Mhz but other frequencies in the range of 0.5 MHz to 2 MHz may be used, the measuring frequency being recorded. The results shall be in microvolts.

3.2 Alternatively, RIV tests shall be carried out in accordance with relevant IEC of respective equipment or NEMA standard Publication No. 107-1964.

3.3 In measurement of, RIV, temporary additional external corona shielding may be provided. In measurements of RIV only standard fittings of identical type supplied with the equipment and a simulation of the connections as used in the actual installation will be permitted in the vicinity within 3.5 meters of terminals.

3.4 Ambient noise shall be measured before and after each series of tests to ensure that there is no variation in ambient noise level. If variation is present, the lowest ambient noise level will form basis for the measurements. RIV levels shall be measured at increasing and decreasing voltages of 85%, 100%, and 110% of the specified RIV test voltage for all equipment unless otherwise specified. The specified RIV test voltage for 765kV, 400 kV, 220 KV is listed in the detailed specification together with maximum permissible RIV level in microvolts.

3.5 The metering instruments shall be as per CISPR recommendation or equivalent device so long as it has been used by other testing authorities.

3.6 The RIV measurement may be made with a noise meter. A calibration procedure of the frequency to which noise meter shall be tuned shall establish the ratio of voltage at the high voltage terminal to voltage read by noise meter.

4. Test Methods for Visible Corona

The purpose of this test is to determine the corona extinction voltage of apparatus, connectors etc. The test shall be carried out in the same manner as RIV test described above with the exception that RIV measurements are not required during test and a search technique shall be used near the onset and extinction voltage, when the test voltage is raised and lowered to determine their precise values. The test voltage shall be raised to 110% of specified corona extinction voltage and maintained there for five minutes. In case corona inception does not take place at 110%, test shall be stopped,

SECTION-GENERAL TECHNICAL REQUIREMENTS (GTR)

ANNEXURE-A

otherwise test shall be continued and the voltage will then be decreased slowly until all visible corona disappears. The procedure shall be repeated at least 3 times with corona inception and extinction voltage recorded each time. The corona extinction voltage for purposes of determining compliance with the specification shall be the lowest of the three values at which visible corona (negative or positive polarity) disappears.

The test to determine the visible corona extinction voltage need not be carried out simultaneously with test to determine RIV levels.

However, both test shall be carried out with the same test set up and as little time duration between tests as possible. No modification on treatment of the sample between tests will be allowed. Simultaneous RIV and visible corona extinction voltage testing may be permitted at the discretion of Employer's inspector if, in his opinion, it will not prejudice other test

5. Test Records:

In addition to the information previously mentioned and the requirements specified as per CISPR or NEMA 107-1964 the following data shall be included in test report:

- a) Background noise before and after test.
- b) Detailed procedure of application of test voltage.
- c) Measurements of RIV levels expressed in micro volts at each level.
- d) Results and observations with regard to location and type of interference sources detected at each step.
- e) Test voltage shall be recorded when measured RIV passes through 100 microvolts in each direction.
- f) Onset and extinction of visual corona for each of the four tests required shall be recorded.

SEISMIC WITHSTAND TEST PROCEDURE

The seismic withstanding test on the complete equipment (for 400kV and above) shall be carried out along with supporting structure. Seismic Withstand Test carried out using either lattice or pipe structure is acceptable.” **Seismic Calculations certified by NABL Labs shall also be acceptable**

The Bidder shall arrange to transport the structure from his Contractor’s premises/ POWERGRID sites for the purpose of seismic withstand test only.

The seismic level specified shall be applied at the base of the structure. The accelerometers shall be provided at the Terminal Pad of the equipment and any other point as agreed by the Employer. The seismic test shall be carried out in all possible combinations of the equipment. The seismic test procedure shall be furnished for approval of the Employer.

The frequency range for the earthquake spectra shall be as per IEC-62271-300.

SECTION-GENERAL TECHNICAL REQUIREMENTS (GTR)ANNEXURE-C**LIST OF GENERAL STANDARDS AND CODES**

CODES	TITLE
--	India Electricity Rules
--	Indian Electricity Act
--	Indian Electricity (Supply) Act
--	Indian Factories Act
IS-5	Colors for Ready Mixed Paints and Enamels
IS-335	New Insulating Oils
IS-617	Aluminium and Aluminium Alloy Ingots and Castings for General Engineering Purposes
IS-1448 (P1 to P 145)	Methods of Test for Petroleum and its Products
IS-2071 (P1 to P3)	Methods of High Voltage Testing
IS-12063	Classification of degrees of protection provided by enclosures of electrical equipment
IS-2165 ; P1:1997, P2:1983	Insulation Coordination
IS-3043	Code of Practice for Earthing
IS-6103	Method of Test for Specific Resistance (Resistivity) of Electrical Insulating Liquids
IS-6104	Method of Test for Interfacial Tension of Oil against Water by the Ring Method
IS-6262	Method of test for Power factor & Dielectric Constant of Electrical Insulating Liquids
IS-6792	Method for determination of electric strength of insulating oils
IS-5578	Guide for marking of insulated conductors
IS-11353	Guide for uniform system of marking & identification of conductors & apparatus terminals.
IS-8263	Methods for Radio Interference Test on High voltage Insulators
IS-9224 (Part 1,2&4)	Low Voltage Fuses
IEC-60060 (Part 1 to P4)	High Voltage Test Techniques
IEC 60068	Environmental Test
IEC-60117	Graphical Symbols
IEC-60156	Method for the Determination of the Electrical Strength of Insulation Oils
IEC-60270	Partial Discharge Measurements
IEC-60376	Specification and Acceptance of New Sulphur Hexafluoride
IEC-60437	Radio Interference Test on High Voltage Insulators
IEC-60507	Artificial Pollution Tests on High Voltage Insulators to be used on AC Systems
IEC-62271-1	Common Specification for High Voltage Switchgear & Control gear Standards
IEC-60815	Guide for the Selection of Insulators in respect of Polluted Conditions

SECTION-GENERAL TECHNICAL REQUIREMENTS (GTR)ANNEXURE-C

CODES	TITLE
IEC-60865 (P1 & P2)	Short Circuit Current - Calculation of effects
ANSI-C.1/NFPA.70	National Electrical Code
ANSI-C37.90A	Guide for Surge Withstand Capability (SWC) Tests
ANSI-C63.21, C63.3	Specification for Electromagnetic Noise and Field Strength Instrumentation 10 KHz to 1 GHZ
C36.4ANSI-C68.1	Techniquet for Dielectric Tests
ANSI-C76.1/EEE21	Standard General Requirements and Test Procedure for Outdoor Apparatus Bushings
ANSI-SI-4	Specification for Sound Level Meters
ANSI-Y32-2/C337.2	Drawing Symbols
ANSI-Z55.11	Gray Finishes for Industrial Apparatus and Equipment No. 61 Light Gray
NEMA-107T	Methods of Measurements of RIV of High Voltage Apparatus
NEMA-ICS-II	General Standards for Industrial Control and Systems Part ICSI-109
CISPR-1	Specification for CISPR Radio Interference Measuring Apparatus for the frequency range 0.15 MHz to 30 MHz
CSA-Z299.1-1978h	Quality Assurance Program Requirements
CSA-Z299.2-1979h	Quality Control Program Requirements
CSA-Z299.3-1979h	Quality Verification Program Requirements
CSA-Z299.4-1979h	Inspection Program Requirements
TRANSFORMERS AND REACTORS	
IS:10028 (Part 2 & 3)	Code of practice for selection, installation & maintenance of Transformers (P1:1993), (P2:1991), (P3:1991)
IS-2026 (P1 to P4)	Power Transformers
IS-3347 (part 1 to Part 8)	Dimensions for Porcelain transformer Bushings for use in lightly polluted atmospheres
IS-3639	Fittings and Accessories for Power Transformers
IS-6600	Guide for Loading of oil immersed Transformers
IEC-60076 (Part 1 to 5)	Power Transformers
IEC-60214	On-Load Tap-Changers
IEC-60289	Reactors
IEC- 60354	Loading Guide for Oil - Immersed power transformers
IEC-60076-10	Determination of Transformer and Reactor Sound Levels
ANSI-C571280	General requirements for Distribution, Power and Regulating Transformers
ANSI-C571290	Test Code for Distribution, Power and Regulation Transformers
ANSI-C5716	Terminology & Test Code for Current Limiting Reactors
ANSI-C5721	Requirements, Terminology and Test Code for Shunt Reactors Rated Over 500 KVA
ANSI-C5792	Guide for Loading Oil-Immersed Power Transformers upto and including 100 MVA with 55 deg C or 65 deg C Winding Rise

SECTION-GENERAL TECHNICAL REQUIREMENTS (GTR)ANNEXURE-C

CODES	TITLE
ANSI-CG,1EEE-4	Standard Techniques for High Voltage Testing
IEC 60076	Power transformers
IEC 60076-1	Part 1: General
IEC 60076-2	Part 2: Temperature rise
IEC 60076-3	Part 3: Insulation levels, dielectric tests and external clearances in air
IEC 60076-4	Part 4: Guide to the lightning impulse and switching impulse testing - Power transformers and reactors
IEC 60076-3-1	Part 3-1: Insulation Levels and Dielectric Tests –External Clearances in Air
IEC 60076-5	Part 5: Ability to withstand short circuit
IEC 60076-6	Part 6: Reactors
IEC 60076-7	Part 7: Loading guide for oil-immersed power transformers
IEC 60076-8	Part 8: Application guide
IEC 60076-10	Part 10: Determination of sound levels
IEC 60076-10-1	Part 10-1: Determination of sound levels - Application guide
IEC 60076-11	Part 11: Dry-type transformers
IEC 60076-12	Part 12: Loading guide for dry-type power transformers
IEC 60076-13	Part 13: Self-protected liquid-filled transformers
IEC 60076-14	Part 14: Design and application of liquid-immersed power transformers using high-temperature insulation materials
IEC 60076-15	Part 15: Gas-filled power transformers
IEC 60076-16	Part 16: Transformers for wind turbine applications
IEC 60076-18	Part 18: Measurement of frequency response
IEC 60076-19	Part 19: Rules for the determination of uncertainties in the measurement of losses in power transformers and reactors
IEC 60076-21	Part 21: Standard requirements, terminology, and test code for step-voltage regulators
IEC 60044, BS 3938	Current transformers
IEC 60050	International Electrotechnical Vocabulary
IEC 60050(421)	International Electrotechnical vocabulary- Chapter 421 : Power Transformers and Reactors
IEC 60060	High Voltage test techniques
IEC 60060-1	General definitions and test requirements
IEC 60060-2	Measuring systems
IEC 60071	Insulation co-ordination
IEC 60071-1	Part 1: Definitions, principles and rules
IEC 60071-2	Part 2 : Application guide
IEC 60137	Bushing for alternating voltage above 1000V
IEC 60214	On-Load Tap changers
IEC 255-21-3	Relays vibration

SECTION-GENERAL TECHNICAL REQUIREMENTS (GTR)ANNEXURE-C

CODES	TITLE
IEC 60270	Partial discharge measurements
IEC 60296	Specification for Unused Mineral Oil for Transformers and Switchgear
IEC 60422	Supervision and Maintenance guide for Mineral Insulating Oil in Electrical Equipment
IEC 60475	Method of Sampling Liquid dielectrics
IEC 60529	Classification of Degrees of Protection provided by Enclosures
IEC 60542	Application Guide for On-Load Tap-Changers
IEC 60567	Guide for the Sampling of Gases and of Oil from Oil-filled Electrical Equipment for the Analysis of Free and Dissolved Gases
IEC 60651	Sound Level Meters
IEC 61083	Digital Recorders and Software for High Voltage Impulse testing
IEC 61083-1	Part 1: Requirements for digital recorders in high voltage impulse tests
IEC 61083-2	Part 2: Evaluation of software used for the determination of the parameters of impulse waveforms
CISPR 16	Specification for radio disturbance and immunity measuring apparatus
CISPR 16-1	Radio disturbance and immunity measuring apparatus
CISPR-18	Radio Interference Characteristics of Power Lines and High Voltage Equipment
ISO 9001	Quality system-Model for Quality Assurance in Design /development
Cigre Publication 202	Guidelines for conducting design reviews for transformers 100 MVA and 123 kV and above. August 2002-Cigre Working Group 12.22
WG 12-15	Guide for Customers Specifications for Transformers 100 MVA and 123 kV and above
WG 12 19	Short Circuit Performance of Transformers.
BS-4360	Specification for weldable structural steel
BS-5135	Specification for arc welding of carbon and carbon manganese steels
BS-5500	Specification for unfired fusion welded pressure vessels
IS-3618	Specification for phosphate treatment of iron & steel for protection against corrosion
IS-6005	Code of practice for phosphating of Iron and Steel
ISO-8501	Preparation of steel surface before application of Paints and related product
IEC-60599	Mineral oil impregnated electrical equipment in service – guide to the interpretation of dissolved and free gases analysis
IS-10593	Method of evaluating the analysis of gases in oil filled electrical equipment in service
IS-2099	Bushings for alternating voltages above 1000 volts

SECTION-GENERAL TECHNICAL REQUIREMENTS (GTR)ANNEXURE-C

CODES	TITLE
IS-3347 Part I to 8	Dimension for porcelain transformer bushing
DIN-42530	Bushing up to 1000kV from 250A-5000A for liquid filled Transformer
IS-2026 Part 1 to 5	Power transformer
IS-4691	Degrees of protection provided by enclosure for rotating electrical machinery
IEC-60034-5	Degrees of protection provided by integral design of rotating electrical machines(IP Code) classification
IS:325 / IEC -60034	Performance of cooling fan / oil pump motor
IS-13947 part 1 to 5	Specification for low voltage switchgear and control gear
IS:3400	Methods of test for vulcanised rubber
IS:7016 part 1 to 14	Methods of test for coated and treated fabrics
IS:803	Code of practice for design, fabrication and erection of vertical mild steel cylindrical welded oil storage tanks.
IS:3637	Gas operated Relays
IS:335	New Insulating oils – Specification
IEC-62271-203	Gas insulated metal enclosed switchgear for rated voltage above 52kV
IEC-61639	Direct connection between power transformers and gas-insulated metal enclosed switchgear for rated voltages of 52.5 kV and above.
IS:3400 / BS 903 / IS:7016	Air cell (Flexible Air Separator)
IEC 60529 / IP : 55	Degree of protection for cooler control cabinet , MOLG, Cooling fan , oil pump, Buchholz Relay
IEC 60529 / IP : 56	Degree of protection for Pressure Relief Device
IEC 60529 / IP : 43	Degree of protection for Remote tap Changer cubicle (RTCC)
CIRCUIT BREAKERS	
IEC-62271-100	High-voltage switchgear and control gear - Part 100: Alternating current circuit-breakers
IEC-62271-101	High-voltage switchgear and control gear - Part 101: Synthetic testing
IEC-62155	Hollow pressurized and unpressurized ceramic and glass insulators for use in electrical equipment with rated voltages greater than 1000 V
IEC-62271-110	High-voltage switchgear and control gear - Part 110: Inductive load switching
IEC-62271-109	High-voltage switchgear and control gear - Part 110: Inductive load switching
CURRENT TRANSFORMERS, VOLTAGE TRANSFORMERS AND COUPLING CAPACITOR VOLTAGE TRANSFORMERS	
IS-2705- (P1 to P4)	Current Transformers

SECTION-GENERAL TECHNICAL REQUIREMENTS (GTR)ANNEXURE-C

CODES	TITLE
IS:3156- (P1 to P4)	Voltage Transformers
IS-4379	Identification of the Contents of Industrial Gas Cylinders
IEC-61869 (Part-1)	Instrument transformers - Part 1: General requirements
IEC-61869 (Part-2)	Instrument transformers - Part 2: Additional requirements for current transformers
IEC-61869 (Part-3)	Instrument transformers - Part 3: Additional requirements for inductive voltage transformers
IEC-61869 (Part-4)	Instrument transformers - Part 4: Additional requirements for combined transformers
IEC-61869 (Part-5)	Instrument transformers - Part 5: Additional requirements for capacitor voltage transformers
IEC-61869 (Part-6)	Instrument transformers - Part 6: Additional general requirements for low-power instrument transformers
IEC-61869 (Part-9)	Instrument transformers - Part 9: Digital interface for instrument transformers
IEC-61869 (Part-102)	Instrument transformers - Part 102: Ferroresonance oscillations in substations with inductive voltage transformers
IEC-61869 (Part-103)	Instrument transformers - The use of instrument transformers for power quality measurement
BUSHING	
IS-2099	Bushings for Alternating Voltages above 1000V
IEC-60137	Insulated Bushings for Alternating Voltages above 1000V
SURGE ARRESTERS	
IS-3070 (PART2)	Lightning arresters for alternating current systems : Metal oxide lightning arrestors without gaps
IEC-60099-4	Metal oxide surge arrestors without gaps
IEC-60099-5	Selection and application recommendation
ANSI-C62.1	IEE Standards for S A for AC Power Circuits
NEMA-LA 1	Surge Arresters
CUBICLES AND PANELS & OTHER RELATED EQUIPMENTS	
IS-722, IS-1248	Electrical relays for power system
IS-3231, 3231 (P-3)	Protection
IS:5039	Distributed pillars for Voltages not Exceeding 1000 Volts
IEC-60068.2.2	Basic environmental testing procedures Part 2: Test B: Dry heat
IEC-60529	Degree of Protection provided by enclosures
IEC-60947-4-1	Low voltage switchgear and control gear
IEC-61095	Electromechanical Contactors for household and similar purposes
IEC-60439 (P1 & 2)	Low Voltage Switchgear and control gear assemblies
ANSI-C37.20	Switchgear Assemblies, including metal enclosed bus
ANSI-C37.50	Test Procedures for Low Voltage Alternating Current Power

SECTION-GENERAL TECHNICAL REQUIREMENTS (GTR)

ANNEXURE-C

CODES	TITLE
	Circuit Breakers
ANSI-C39	Electric Measuring instrument
ANSI-C83	Components for Electric Equipment
IS: 8623: (Part I to 3)	Specification for Switchgear & Control Assemblies
NEMA-AB	Moulded Case Circuit and Systems
NEMA-CS	Industrial Controls and Systems
NEMA-PB-1	Panel Boards
NEMA-SG-5	Low voltage Power Circuit breakers
NEMA-SG-3	Power Switchgear Assemblies
NEMA-SG-6	Power switching Equipment
NEMA-5E-3	Motor Control Centers
1248 (P1 to P9)	Direct acting indicating analogue electrical measuring instruments & their accessories
Disconnecting switches	
IEC-62271-102	High-voltage switchgear and control gear - Part 102: Alternating current disconnectors and earthing switches
IEC-60265 (Part 1 & 2)	High Voltage switches
ANSI-C37.32	Schedule of preferred Ratings, Manufacturing Specifications and Application Guide for high voltage Air Switches, Bus supports and switch accessories
ANSI-C37.34	Test Code for high voltage air switches
NEMA-SG6	Power switching equipment
PLCC and line traps	
IS-8792	Line traps for AC power system
IS-8793	Methods of tests for line traps
IS-8997	Coupling devices for PLC systems
IS-8998	Methods of test for coupling devices for PLC systems
IEC-60353	Line traps for A.C. power systems
IEC-60481	Coupling Devices for power line carrier systems
IEC-60495	Single sideboard power line carrier terminals
IEC-60683	Planning of (single Side-Band) power line carrier systems
CIGRE	Teleprotection report by Committee 34 & 35
CIGRE	Guide on power line carrier 1979
CCIR	International Radio Consultative Committee
CCITT	International Telegraph & Telephone Consultative Committee
EIA	Electric Industries Association
Protection and control equipment	
IEC-60051: (P1 to P9)	Recommendations for Direct Acting indicating analogue electrical measuring instruments and their accessories
IEC-60255 (Part 1 to 23)	Electrical relays
IEC-60297 (P1 to P4)	Dimensions of mechanical structures of the 482.6mm (19 inches)

SECTION-GENERAL TECHNICAL REQUIREMENTS (GTR)

ANNEXURE-C

CODES	TITLE
	series
IEC-60359	Expression of the performance of electrical & electronic measuring equipment
IEC-60387	Symbols for Alternating-Current Electricity meters
IEC-60447	Man machine interface (MMI) - Actuating principles
IEC-60521	Class 0.5, 1 and 2 alternating current watt hour metres
IEC-60547	Modular plug-in Unit and standard 19-inch rack mounting unit based on NIM Standard (for electronic nuclear instruments)
ANSI-81	Screw threads
ANSI-B18	Bolts and Nuts
ANSI-C37.1	Relays, Station Controls etc
ANSI-C37.2	Manual and automatic station control, supervisory and associated telemetering equipment
ANSI-C37.2	Relays and relay systems associated with electric power apparatus
ANSI-C39.1	Requirements for electrical analog indicating instruments
MOTORS	
IS-325	Three phase induction motors
IS-4691	Degree of protection provided by enclosure for rotating electrical machinery
IEC-60034 (P1 to P19:)	Rotating electrical machines
IEC-Document 2	Three phase induction motors
(Central Office) NEMA-MGI	Motors and Generators
Electronic equipment and components	
MIL-21B, MIL-833 & MIL-2750	Environmental testing
EC-60068 (P1 to P5)	Printed boards
IEC-60326 (P1 to P2)	Material and workmanship standards
IS-1363 (P1 to P3)	Hexagon head bolts, screws and nuts of product grade C
IS-1364 (P1 to P5)	Hexagon head bolts, screws and nuts of products grades A and B
IS-3138	Hexagonal Bolts and Nuts (M42 to M150)
ISO-898	Fasteners: Bolts, screws and studs
ASTM	Specification and tests for materials
Clamps & connectors	
IS-5561	Electric power connectors
NEMA-CC1	Electric Power connectors for sub station
NEMA-CC 3	Connectors for Use between aluminium or aluminum-Copper Overhead Conductors
Bus hardware and insulators	
IS: 2121	Fittings for Aluminum and steel cored Al conductors for overhead

SECTION-GENERAL TECHNICAL REQUIREMENTS (GTR)ANNEXURE-C

CODES	TITLE
	power lines
IS-731	Porcelain insulators for overhead power lines with a nominal voltage greater than 1000 V
IS-2486 (P1 to P4)	Insulator fittings for overhead power lines with a nominal voltage greater than 1000 V
IEC-60120	Dimensions of Ball and Socket Couplings of string insulator units
IEC-60137	Insulated bushings for alternating voltages above 1000 V
IEC-60168	Tests on indoor and outdoor post insulators of ceramic material or glass for Systems with Nominal Voltages Greater than 1000 V
IEC-62155	Hollow pressurized and unpressurized ceramic and glass insulators for use in electrical equipment with rated voltages greater than 1 000 V
IEC-60273	Characteristics of indoor and outdoor post insulators for systems with nominal voltages greater than 1000V
IEC-61462	Pressurized and un-pressurized insulator for use in electrical equipment with rated voltage greater than 1000V – Definitions, Test methods, acceptance criteria and design recommendations
IEC-60305	Insulators for overhead lines with nominal voltage above 1000V-ceramic or glass insulator units for ac systems Characteristics of String Insulator Units of the cap and pin type
IEC-60372 (1984)	Locking devices for ball and socket couplings of string insulator units : dimensions and tests
IEC-60383 (P1 and P2)	Insulators for overhead lines with a nominal voltage above 1000 V
IEC-60433	Characteristics of string insulator units of the long rod type
IEC-60471	Dimensions of Clevis and tongue couplings of string insulator units
ANSI-C29	Wet process porcelain insulators
ANSI-C29.1	Test methods for electrical power insulators
ANSI-C92.2	For insulators, wet-process porcelain and toughened glass suspension type
ANSI-C29.8	For wet-process porcelain insulators apparatus, post-type
ANSI-G.8	Iron and steel hardware
CISPR-7B	Recommendations of the CISPR, tolerances of form and of Position, Part 1
ASTM A-153	Zinc Coating (Hot-Dip) on iron and steel hardware
Strain and rigid bus-conductor	
IS-2678	Dimensions & tolerances for Wrought Aluminum and Aluminum Alloys drawn round tube
IS-5082	Wrought Aluminum and Aluminum Alloy Bars. Rods, Tubes and Sections for Electrical purposes
ASTM-B 230-82	Aluminum 1350 H19 Wire for electrical purposes

SECTION-GENERAL TECHNICAL REQUIREMENTS (GTR)ANNEXURE-C

CODES	TITLE
ASTM-B 231-81	Concentric - lay - stranded, aluminum 1350 conductors
ASTM-B 221	Aluminum - Alloy extruded bar, rod, wire, shape
ASTM-B 236-83	Aluminum bars for electrical purpose (Bus-bars)
ASTM-B 317-83	Aluminum-Alloy extruded bar, rod, pipe and structural shapes for electrical purposes (Bus Conductors)
Batteries	
IS:1651	Stationary Cells and Batteries, Lead-Acid Type (with Tubular Positive Plates)
IS:1652	Stationary Cells and Batteries, Lead-Acid Type (with Plante Positive Plates)
IS:1146	Rubber and Plastic Containers for Lead-Acid Storage Batteries
IS:6071	Synthetic Separators for Lead-Acid Batteries
IS:266	Specification for Sulphuric Acid
IS:1069	Specification for Water for Storage Batteries
IS:3116	Specification for Sealing Compound for Lead-Acid Batteries
IS:1248	Indicating Instruments
IS:10918	Vented type nickel Cadmium Batteries
IEC:60896-21&22	Lead Acid Batteries Valve Regulated types – Methods of Tests & Requirements
IEC: 60623	Vented type nickel Cadmium Batteries
IEC:60622	Secondary Cells & Batteries – Sealed Ni-Cd rechargeable single cell
IEC:60623	Secondary Cells & Batteries – Vented Ni-Cd rechargeable single cell
IEC:60896-11	Stationary Lead Acid Batteries – Vented Type – General requirements & method of tests
IEEE-485	Recommended practices for sizing of Lead Acid Batteries
IEEE-1115	Sizing of Ni-Cd Batteries
IEEE-1187	Recommended practices for design & installation of VRLA Batteries
IEEE-1188	Recommended practices for design & installation of VRLA Batteries
IEEE-1189	Guide for selection of VRLA Batteries
Battery Charger	
IS:3895	Mono-crystalline Semiconductor Rectifier Cells and Stacks
IS:4540	Mono-crystalline Semiconductor Rectifier Assemblies and Equipment
IS:6619	Safety Code for Semiconductor Rectifier Equipment
IS:2026	Power Transformers

SECTION-GENERAL TECHNICAL REQUIREMENTS (GTR)**ANNEXURE-C**

CODES	TITLE
IS:2959	AC Contactors for Voltages not Exceeding 1000 Volts
IS:1248	Indicating Instruments
IS:2208	HRC Fuses
IS:13947 (Part-3)	Air break switches, air break disconnectors & fuse combination units for voltage not exceeding 1000V AC or 1200V DC
IS:2147	Degree of protection provided by enclosures for low voltage switchgear and control gear
IS:6005	Code of practice for phosphating of Iron and Steel
IS:3231	Electrical relays for power system protection
IS:3842	Electrical relay for AC Systems
IS:5	Colours for ready mix paint
IEEE-484	Recommended Design for installation design and installation of large lead storage batteries for generating stations and substations
IEEE-485	Sizing large lead storage batteries for generating stations and substations
Wires and cables	
ASTMD-2863	Measuring the minimum oxygen concentration to support candle like combustion of plastics (oxygen index)
IS-694	PVC insulated cables for working voltages upto and including 1100 Volts
IS-1255	Code of practice for installation and maintenance of power cables, upto and including 33 kV rating
IS-1554 (P1 and P2)	PVC insulated (heavy duty) electric cables (part 1) for working voltage upto and including 1100 V Part (2) for working voltage from 3.3 kV upto and including 11kV
IS:1753	Aluminium conductor for insulated cables
IS:2982	Copper Conductor in insulated cables
IS-3961 (P1 to P5)	Recommended current ratings for cables
IS-3975	Mild steel wires, formed wires and tapes for armouring of cables
IS-5831	PVC insulating and sheath of electric cables
IS-6380	Elastometric insulating and sheath of electric cables
IS-7098	Cross linked polyethylene insulated PVC sheathed cables for working voltage upto and including 1100 volts
IS-7098	Cross-linked polyethylene insulated PVC sheathed cables for working voltage from 3.3kV upto and including 33 kV
IS-8130	Conductors for insulated electrical cables and flexible cords
IS-1753	Aluminum Conductors for insulated cables
IS-10418	Specification for drums for electric cables
IEC-60096 (part 0 to p4)	Radio Frequency cables
IEC-60183	Guide to the Selection of High Voltage Cables

SECTION-GENERAL TECHNICAL REQUIREMENTS (GTR)ANNEXURE-C

CODES	TITLE
IEC-60189 (P1 to P7)	Low frequency cables and wires with PVC insulation and PVC sheath
IEC-60227 (P1 to P7)	Polyvinyl Chloride insulated cables of rated voltages up to and including 450/750V
IEC-60228	Conductors of insulated cables
IEC-60230	Impulse tests on cables and their accessories
IEC-60287 (P1 to P3)	Calculation of the continuous current rating of cables (100% load factor)
IEC-60304	Standard colours for insulation for low-frequency cables and wires
IEC-60331	Fire resisting characteristics of Electric cables
IEC-60332 (P1 to P3)	Tests on electric cables under fire conditions
IEC-60502	Extruded solid dielectric insulated power cables for rated voltages from 1 kV upto to 30 kV
IEC-754 (P1 and P2)	Tests on gases evolved during combustion of electric cables
AIR conditioning and ventilation	
IS-659	Safety code for air conditioning
IS-660	Safety code for Mechanical Refrigeration
ARI:520	Standard for Positive Displacement Refrigeration Compressor and Condensing Units
IS:4503	Shell and tube type heat exchanger
ASHRAE-24	Method of testing for rating of liquid coolers
ANSI-B-31.5	Refrigeration Piping
IS:2062	Steel for general structural purposes
IS:655	Specification for Metal Air Dust
IS:277	Specification for Galvanised Steel Sheets
IS-737	Specification for Wrought Aluminium and Aluminium Sheet & Strip
IS-1079	Hot rolled cast steel sheet & strip
IS-3588	Specification for Electrical Axial Flow Fans
IS-2312	Propeller Type AC Ventilation Fans
BS-848	Methods of Performance Test for Fans
BS-6540 Part-I	Air Filters used in Air Conditioning and General Ventilation
BS-3928	Sodium Flame Test for Air Filters (Other than for Air Supply to I.C. Engines and Compressors)
US-PED-2098	Method of cold DOP & hot DOP test
MIL-STD-282	DOP smoke penetration method
ASHRAE-52	Air cleaning device used in general ventilation for removing particle matter
IS:3069	Glossary of Terms, Symbols and Units Relating to Thermal Insulation Materials

SECTION-GENERAL TECHNICAL REQUIREMENTS (GTR)

ANNEXURE-C

CODES	TITLE
IS:4671	Expanded Polystyrene for Thermal Insulation Purposes
IS:8183	Bonded Mineral Wool
IS:3346	Evaluation of Thermal Conductivity properties by means of guarded hot plate method
ASTM-C-591-69	Standard specification for rigid preformed cellular urethane thermal insulation
IS:4894	Centrifugal Fans
BS:848	Method of Performance Test for Centrifugal Fans
IS:325	Induction motors, three-phase
IS:4722	Rotating electrical machines
IS:1231	Three phase foot mounted Induction motors, dimensions of
IS:2233	Designations of types of construction and mounting arrangements of rotating electrical machines
IS:2254	Vertical shaft motors for pumps, dimensions of
IS:7816	Guide for testing insulation resistance of rotating machines
IS:4029	Guide for testing three phase induction motors
IS: 4729	Rotating electrical machines, vibration of, Measurement and evaluation of
IS:4691	Degree of protection provided by enclosures for rotating electrical machinery
IS:7572	Guide for testing single-phase ac motors
IS:2148	Flame proof enclosure for electrical apparatus
BS:4999(Part-51)	Noise levels
Galvanizing	
IS-209	Zinc Ingot
IS-2629	Recommended Practice for Hot-Dip galvanizing on iron and steel
IS-2633	Methods for testing uniformity of coating of zinc coated articles
ASTM-A-123	Specification for zinc (Hot Galvanizing) Coatings, on products Fabricated from rolled, pressed and forged steel shapes, plates, bars and strips
ASTM-A-121-77	Zinc-coated (Galvanized) steel barbed wire
Painting	
IS-6005	Code of practice for phosphating of iron and steel
ANSI-Z551	Gray finishes for industrial apparatus and equipment
SSPEC	Steel structure painting council
Fire protection system	
--	Fire protection manual issued by tariff advisory committee (TAC) of India
HORIZONTAL CENTRIFUGAL PUMPS	
IS:1520	Horizontal centrifugal pumps for clear, cold and fresh water
IS:9137	Code for acceptance test for centrifugal & axial pumps

SECTION-GENERAL TECHNICAL REQUIREMENTS (GTR)

ANNEXURE-C

CODES	TITLE
IS:5120	Technical requirement – Rotodynamic special purpose pumps
API-610	Centrifugal pumps for general services Hydraulic Institutes Standards
BS:599	Methods of testing pumps
PTC-8.2	Power Test Codes - Centrifugal pumps
DIESEL ENGINES	
IS:10000	Methods of tests for internal combustion engines
IS:10002	Specification for performance requirements for constant speed compression ignition engines for general purposes (above 20 kW)
BS:5514	The performance of reciprocating compression ignition (Diesel) engines, utilizing liquid fuel only, for general purposes
ISO:3046	Reciprocating internal combustion engines performance
IS:554	Dimensions for pipe threads where pressure tight joints are required on threads
ASME Power Test Code	Internal combustion engine PTC-17
--	Codes of Diesel Engine Manufacturer's Association, USA
PIPING VALVES & SPECIALITIES	
IS:636	Non percolating flexible fire-fighting delivery hose
IS:638	Sheet rubber jointing and rubber inserting jointing
IS:778	Gun metal gate, globe and check valves for general purpose
IS:780	Sluice valves for water works purposes (50 to 300 mm)
IS:901	Couplings, double male and double female instantaneous pattern for fire fighting
IS:902	Suction hose couplings for fire-fighting purposes
IS:903	Fire hose delivery couplings branch pipe nozzles and nozzle spanner
IS:1538	Cast iron fittings for pressure pipes for water, gas and sewage
IS:1903	Ball valve (horizontal plunger type) including floats for water supply purposes
IS:2062	SP for weldable structural steel
IS:2379	Colour Code for the identification of pipelines
IS:2643	Dimensions of pipe threads for fastening purposes
IS:2685	Code of Practice for selection, installation and maintenance of sluice valves
IS:2906	Sluice valves for water-works purposes (350 to 1200 mm size)
IS:3582	Basket strainers for fire-fighting purposes (cylindrical type)
IS:3589	Electrically welded steel pipes for water, gas and sewage (150 to 2000 mm nominal diameter)
IS:4038	Foot valves for water works purposes
IS:4927	Unlined flax canvas hose for fire fighting

SECTION-GENERAL TECHNICAL REQUIREMENTS (GTR)

ANNEXURE-C

CODES	TITLE
IS:5290	Landing valves (internal hydrant)
IS:5312 (Part-I)	Swing check type reflex (non-return) valves
IS:5306	Code of practice for fire extinguishing installations and equipment on premises
Part-I	Hydrant systems, hose reels and foam inlets
Part-II	Sprinkler systems
BS:5150	Specification for cast iron gate valves
MOTORS & ANNUNCIATION PANELS	
IS:325	Three phase induction motors
IS:900	Code of practice for installation and maintenance of induction motors
IS:996	Single phase small AC and universal electric motors
IS:1231	Dimensions of three phase foot mounted induction motors
IS:2148	Flame proof enclosure of electrical apparatus
IS:2223	Dimensions of flange mounted AC induction motors
IS:2253	Designations for types of construction and mounting arrangements of rotating electrical machines
IS:2254	Dimensions of vertical shaft motors for pumps
IS:3202	Code of practice for climate proofing of electrical equipment
IS:4029	Guide for testing three phase induction motors
IS:4691	Degree of protection provided by enclosure for rotating electrical machinery
IS:4722	Rotating electrical machines
IS:4729	Measurement and evaluation of vibration of rotating electrical machines
IS:5572	Classification of hazardous areas for electrical (Part-I) installations (Areas having gases and vapours)
IS:6362	Designation of methods of cooling for rotating electrical machines
IS:6381	Construction and testing of electrical apparatus with type of protection 'e'
IS:7816	Guide for testing insulation for rotating machine
IS:4064	Air break switches
IEC DOCUMENT 2 (Control Office) 432	Three Phase Induction Motor
VDE 0530 Part I/66	Three Phase Induction Motor
IS:9224 (Part-II)	HRC Fuses
IS:6875	Push Button and Control Switches
IS:694	PVC Insulated cables
IS:1248	Indicating instruments
IS:375	Auxiliary wiring & busbar markings

SECTION-GENERAL TECHNICAL REQUIREMENTS (GTR)ANNEXURE-C

CODES	TITLE
IS:2147	Degree of protection
IS:5	Colour Relay and timers
IS:2959	Contactors
PG Test Procedures	
NFPA-13	Standard for the installation of sprinkler system
NFPA-15	Standard for water spray fixed system for the fire protection
NFPA-12A	Standard for Halong 1301 Fire Extinguishing System
NFPA-72E	Standard on Automatic Fire Detectors
--	Fire Protection Manual by TAC (Latest Edition)
NFPA-12	Standard on Carbon dioxide extinguisher systems
IS:3034	Fire of industrial building
--	Electrical generating and distributing stations code of practice
IS:2878	CO2 (Carbon dioxide) Type Extinguisher
IS:2171	DC (Dry Chemical Powder) type
IS:940	Pressurised Water Type
D.G. SET	
IS:10002	Specification for performance requirements for constant speed compression ignition (diesel engine) for general purposes
IS:10000	Method of tests for internal combustion engines
IS:4722	Rotating electrical machines-specification
IS:12063	Degree of protection provided by enclosures
IS:12065	Permissible limit of noise levels for rotating electrical machines
--	Indian Explosive Act 1932
Steel structures	
IS-228 (1992)	Method of Chemical Analysis of pig iron, cast iron and plain carbon and low alloy steels.
IS-802 (P1 to 3)	Code of practice for use of structural steel in overhead transmission line towers
IS-806	Code of practice for use of steel tubes in general building construction
IS-808	Dimensions for hot rolled steel beam, column channel and angle sections
IS-814	Covered electrodes for manual arc welding of carbon of carbon manganese steel
IS-816	Code of Practice for use of metal arc welding for general construction in Mild steel
IS-817	Code of practice for training and testing of metal arc welders. Part 1 : Manual Metal arc welding
IS-875 (P1 to P4)	Code of practice for design loads (other than earthquake) for buildings and structures
IS-1161	Steel tubes for structural purposes

SECTION-GENERAL TECHNICAL REQUIREMENTS (GTR)ANNEXURE-C

CODES	TITLE
IS-1182	Recommended practice for radiographic examination of fusion welded butt joints in steel plates
IS-1363 (P1 to P3)	Hexagonal head bolts, screws & nuts of products grade C
IS-1364	Hexagon head bolts, screws and nuts of product grades A and B
IS-1367 (P1 to P18)	Technical supply condition for threaded steel fasteners
IS-1599	Methods for bend test
IS-1608	Method for tensile testing of steel products
IS-1893	Criteria for earthquake resistant design of structures
IS-1978	Line Pipe
IS-2062	Steel for general structural purposes
IS-2595	Code of practice for Radiographic testing
IS-3063	Single coil rectangular section spring washers for bolts, nuts and screws
IS-3664	Code of practice for ultrasonic pulse echo testing by contact and immersion methods
IS-7205	Safety code for erection of structural steel work
IS-9595	Recommendations for metal arc welding of carbon and carbon manganese steels
ANSI-B18.2.1	Inch series square and Hexagonal bolts and screws
ANSI-B18.2.2	Square and hexagonal nuts
ANSI-G8.14	Round head bolts
ASTM-A6	Specification for General Requirements for rolled steel plates, shapes, sheet piling and bars of structural use
ASTM-A36	Specifications of structural steel
ASTM-A47	Specification for malleable iron castings
ASTM-A143	Practice for safeguarding against embilement of Hot Galvanized structural steel products and procedure for detaching embriement
ASTM-A242	Specification for high strength low alloy structural steel
ASTM-A283	Specification for low and intermediate tensile strength carbon steel plates of structural quality
ASTM-A394	Specification for Galvanized steel transmission tower bolts and nuts
ASTM-441	Specification for High strength low alloy structural manganese vanadium steel
ASTM-A572	Specification for High strength low alloy colombium-Vanadium steel of structural quality
AWS D1-0	Code for welding in building construction welding inspection
AWS D1-1	Structural welding code
AISC	American institute of steel construction
NEMA-CG1	Manufactured graphite electrodes

SECTION-GENERAL TECHNICAL REQUIREMENTS (GTR)ANNEXURE-C

CODES	TITLE
Piping and pressure vessels	
IS-1239 (Part 1 and 2)	Mild steel tubes, tubulars and other wrought steel fittings
IS -3589	Seamless Electrically welded steel pipes for water, gas and sewage
IS-6392	Steel pipe flanges
ASME	Boiler and pressure vessel code
ASTM-A120	Specification for pipe steel, black and hot dipped, zinc-coated (Galvanized) welded and seamless steel pipe for ordinary use
ASTM-A53	Specification for pipe, steel, black, and hot-dipped, zinc coated welded and seamless
ASTM-A106	Seamless carbon steel pipe for high temperature service
ASTM-A284	Low and intermediate tensile strength carbon-silicon steel plates for machine parts and general construction
ASTM-A234	Pipe fittings of wrought carbon steel and alloy steel for moderate and elevated temperatures
ASTM-S181	Specification for forgings, carbon steel for general purpose piping
ASTM-A105	Forgings, carbon steel for piping components
ASTM-A307	Carbon steel externally threaded standard fasteners
ASTM-A193	Alloy steel and stainless steel bolting materials for high temperature service
ASTM-A345	Flat rolled electrical steel for magnetic applications
ASTM-A197	Cupola malleable iron
ANSI-B2.1	Pipe threads (Except dry seal)
ANSI-B16.1	Cast iron pipe flanges and flanged fitting. Class 25, 125, 250 and 800
ANSI-B16.1	Malleable iron threaded fittings, class 150 and 300
ANSI-B16.5	Pipe flanges and flanged fittings, steel nickel alloy and other special alloys
ANSI-B16.9	Factory-made wrought steel butt welding fittings
ANSI-B16.11	Forged steel fittings, socket-welding and threaded
ANSI-B16.14	Ferrous pipe plug, bushings and locknuts with pipe threads
ANSI-B16.25	Butt welding ends
ANSI-B18.1.1	Fire hose couplings screw thread
ANSI-B18.2.1	Inch series square and hexagonal bolts and screws
ANSI-B18.2.2	Square and hexagonal nuts
ANSI-B18.21.1	Lock washers
ANSI-B18.21.2	Plain washers
ANSI-B31.1	Power piping
ANSI-B36.10	Welded and seamless wrought steel pipe
ANSI-B36.9	Stainless steel pipe
Other civil works standards	

SECTION-GENERAL TECHNICAL REQUIREMENTS (GTR)

ANNEXURE-C

CODES	TITLE
IS-269	33 grade ordinary portland cement
IS2721	Galvanized steel chain link fence fabric
IS-278	Galvanized steel barbed wire for fencing
IS-383	Coarse and fine aggregates from natural sources for concrete
IS-432 (P1 and P2)	Mild steel and medium tensile steel bars and hard-dawn steel wire for concrete reinforcement
IS-456	Code of practice for plain and reinforced concrete
IS-516	Method of test for strength of concrete
IS-800	Code of practice for general construction in steel
IS-806	Steel tubes for structural purposes
IS-1172	Basic requirements for water supply, drainage and sanitation
IS-1199	Methods of sampling and analysis of concrete
IS-1566	Hard-dawn steel wire fabric for concrete reinforcement
IS-1742	Code of Practice for Building drainage
IS-1785	Plain hard-drawn steel wire for pre-stressed concrete
IS-1786	High strength deformed Steel Bars and wires for concrete reinforcement
IS-1811	Methods of sampling Foundry sands
IS-1893	Criteria for earthquake resistant design of structures
IS-2062	Steel for general structural purposes
IS-2064	Selection, installation and maintenance of sanitary appliances- code of practices
IS-2065	Code of practice for water supply in buildings
IS-2090	High tension steel bars used in pre-stressed concrete
IS-2140	Standard Galvanized steel wire for fencing
IS-2470 (P1 & P2)	Code of practice for installation of septic tanks
IS-2514	Concrete vibrating tables
IS-2645	Integral cement waterproofing compounds
IS-3025 (Part 1 to Part 48)	Methods of sampling and test (Physical and chemical) for water and waste water
IS-4091	Code of practice for design and construction of foundations for transmission line towers and poles
IS-4111 (Part 1 to P5)	Code of practice for ancillary structures in sewerage system
IS-4990	Plywood for concrete shuttering work
IS-5600	Sewage and drainage pumps
National building code of India 1970	
USBR E12	Earth Manual by United States Department of the interior Bureau of Reclamation
ASTM-A392-81	Zinc/Coated steel chain link fence fabric
ASTM-D1557-80	test for moisture-density relation of soils using 10-lb (4.5 kg)

SECTION-GENERAL TECHNICAL REQUIREMENTS (GTR)**ANNEXURE-C**

CODES	TITLE
	rame land 18-in. (457 mm) Drop
ASTM-D1586(1967)	Penetration Test and Split-Barrel Sampling of Soils
ASTM-D2049-69	Test Method for Relative Density of Cohesionless Soils
ASTM-D2435	Test method for Unconsolidated, (1982) Undrained Strengths of Cohesive Soils in Triaxial Compression
BS-5075	Specification for accelerating Part I Admixtures, Retarding Admixtures and Water Reducing Admixtures
CPWD	Latest CPWD specifications
ACSR MOOSE CONDUCTOR	
IS:6745 BS:443-1969	Methods for Determination of Mass of zinc coating on zinc coated Iron and Steel Articles
IS:8263	Methods for Radio Interference
IEC:437-1973 NEMA:107-1964 CISPR	Test on High Voltage Insulators
IS:209, BS:3436-1961	Zinc Ingot
IS:398 Part - V IEC:209-1966	Aluminum Conductors for Overhead Transmission Purposes
BS:215(Part-II), IEC:209-1966	Aluminium Conductors galvanized steel reinforced extra high voltage (400 kV and above)
IS:1778, BS:1559-1949	Reels and Drums for Bare Conductors
IS:1521, ISO/R89-1959	Method for Tensile Testing of steel wire
IS:2629	Recommended practice for Hot dip Galvanising on Iron and Steel
IS:2633	Method for Testing Uniformity of coating of zinc Coated Articles
IS:4826/ ASTMA-472-729	Hot dip galvanised coatings on round steel wires
GALVANISED STEEL EARTHWIRE	
IS:1521, ISO/R:89-1959	Method for Tensile Testing of Steel Wire
IS:1778	Reels and Drums for Bare Conductors
IS:2629	Recommended practice for Hot Dip Galvanising on Iron and Steel
IS:2633	Methods for testing Uniformity of Coating of Zinc Coated Articles
IS:4826/ ASTM: A 475-72a BS:443-1969	Hot dip Galvanised Coatings on Round Steel Wires
IS:6745/ BS:443-1969	Method for Determination of mass of Zinc Coating on Zinc coated Iron and Steel Articles.
IS:209/ BS:3463-1961	Zinc ingot
IS:398 (Pt. I to P5:1992)/ BS:215 (Part-II	Aluminum Conductors for overhead transmission purposes

SECTION-GENERAL TECHNICAL REQUIREMENTS (GTR)**ANNEXURE-C**

CODES	TITLE
Lighting Fixtures and Accessories	
IS:1913	General and safety requirements for electric lighting fittings
IS:3528	Water proof electric lighting fittings
IS:4012	Dust proof electric lighting fittings
IS:4013	Dust tight proof electric lighting fittings
IS:10322	Industrial lighting fittings with metal reflectors
IS:10322	Industrial lighting fittings with plastic reflectors
IS:2206	Well glass lighting fittings for use under ground in mines (non-flameproof type)
IS:10322	Specification for flood light
IS:10322	Specification for decorative lighting outfits
IS:10322	Luminaries for street lighting
IS:2418	Tubular fluorescent lamps
IS:9900	High pressure mercury vapour lamps
IS:1258	Specification for Bayonet lamp fluorescent lamp
IS:3323	Bi-pin lamp holder tubular fluorescent lamps
IS:1534	Ballasts for use in fluorescent lighting fittings. (Part-I)
IS:1569	Capacitors for use in fluorescent lighting fittings
IS:2215	Starters for fluorescent lamps
IS:3324	Holders for starters for tubular fluorescent lamps
IS:418	GLS lamps
IS:3553	Water tight electric fittings
IS:2713	Tubular steel poles
IS:280	MS wire for general engg. Purposes
Conduits, Accessories and Junction Boxes	
IS:9537	Rigid steel conduits for electrical wiring
IS:3480	Flexible steel conduits for electrical wiring
IS:2667	Fittings for rigid steel conduits for electrical wiring
IS:3837	Accessories for rigid steel conduits for electrical wiring
IS:4649	Adaptors for flexible steel conduits
IS:5133	Steel and Cast Iron Boxes
IS:2629	Hot dip galvanising of Iron & Steel
Lighting Panels	
IS:13947	LV Switchgear and Control gear(Part 1 to 5)
IS:8828	Circuit breakers for over current protection for house hold and similar installations
IS:5	Ready mix paints
IS:2551	Danger notice plates
IS:2705	Current transformers

SECTION-GENERAL TECHNICAL REQUIREMENTS (GTR)ANNEXURE-C

CODES	TITLE
IS:9224	HRC Cartridge fuse links for voltage above 650V(Part-2)
IS:5082	Wrought aluminium and Al. alloys, bars, rods, tubes and sections for electrical purposes
IS:8623	Factory built Assemblies of Switchgear and Control Gear for voltages upto and including 1000V AC and 1200V DC
IS:1248	Direct Acting electrical indicating instruments
Electrical Installation	
IS:1293	3 pin plug
IS:371	Two to three ceiling roses
IS:3854	Switches for domestic and similar purposes
IS:5216	Guide for safety procedures and practices in electrical work
IS:732	Code of practice for electrical wiring installation (system voltage not exceeding 650 Volts.)
IS:3043	Code of practice for earthing
IS:3646	Code of practice of interior illumination part II & III
IS:1944	Code of practice for lighting of public through fares
IS:5571	Guide for selection of electrical equipment for hazardous areas
IS:800	Code of practice for use of structural steel in general building construction
IS:2633	Methods of Testing uniformity of coating on zinc coated articles
IS:6005	Code of practice for phosphating iron and steel
	INDIAN ELECTRICITY ACT
	INDIAN ELECTRICITY RULES
LT SWITCHGEAR	
IS:8623 (Part-I)	Specification for low voltage switchgear and control gear assemblies
IS:13947 (Part-I)	Specification for low voltage switchgear and control gear, Part 1 General Rules
IS:13947 (part-2)	Specification for low voltage switchgear and control gear, Part 2 circuit breakers
IS:13947 (part-3)	Specification for low voltage switchgear and control gear. Part 3 Switches, Disconnectors, Switch-disconnectors and fuse combination units
IS:13947 (part-4)	Specification for low voltage switchgear and control gear. Part 4 Contactors and motors starters
IS:13947 (part-5)	Specification for low voltage switchgear and control gear. Part 5 Control-circuit devices and switching elements
IS:13947 (part-6)	Specification for low voltage switchgear and control gear. Part 6 Multiple function switching devices
IS:13947 (part-7)	Specification for low voltage switchgear and control gear. Part 7 Ancillary equipments
IS:12063	Degree of protection provided by enclosures

SECTION-GENERAL TECHNICAL REQUIREMENTS (GTR)

ANNEXURE-C

CODES	TITLE
IS:2705	Current Transformers
IS:3156	Voltage Transformers
IS:3231	Electrical relays for power system protection
IS:1248	Electrical indicating instruments
IS:722	AC Electricity meters
IS:5578	Guide for Marking of insulated conductors of apparatus terminals
IS:13703 (part 1)	Low voltage fuses for voltage not exceeding 1000V AC or 1500V DC Part 1 General Requirements
IS:13703 (part 2)	Low voltage fuses for voltage not exceeding 1000V AC or 1500V DC Part 2 Fuses for use of authorized persons
IS:6005	Code of practice of phosphating iron and steel
IS:5082	Wrought Aluminum and Aluminum alloys for electrical purposes
IS:2633	Hot dip galvanising

Note: If any standard is expired or does not exist anymore than other standard which has substituted it, shall be applicable.

SECTION-GENERAL TECHNICAL REQUIREMENTS (GTR)**Annexure-G****MQP & INSPECTION LEVEL REQUIREMENT**

Sl. No	Item / Equipment	Reference document for inspection	Inspection Level
A.01	LT Transformer /Power Transformer/ Reactor/ Converter Transformer/ Filter Reactor	MQP/ITP	IV
A.02	Bushing	MQP	IV
A.03	Insulating Oil	POWERGRID TS	III
A.04	Oil storage tank for transformers	MQP	III
A.05	Nitrogen injection based explosion prevention system	FAT/ITP	III
A.06	On Line oil drying system for transformers	POWERGRID TS	II**
A.07	On Line DGA and moisture monitoring system	POWERGRID TS	II**
A.08	Flow sensitive conservator isolation valve	POWERGRID TS	II**
A.09	Oil Filtration Machine	MQP	III
B.01	Circuit Breakers	MQP	IV
B.02	Current Transformers	MQP/ITP	IV
B.03	CVT/PT/IVT	MQP	IV
B.04	Isolators	MQP/ITP	IV
B.05	Surge Arrestors	MQP/ITP	III
B.06	Line Trap & Air Core Reactor	MQP/ITP	III
B.07	Point On switching device (CSD) for Circuit Breaker (wherever required)	FAT/ITP	IV
C.01	STATCOM including Valve, valve base electronics, DC capacitor, series reactor and all accessories	ITP	IV
C.02	Mechanically switched Reactor bank (3-ph) including all accessories (MSR Branches)	ITP	IV
C.03	Mechanically switched Capacitor bank (3-ph) including all accessories (MSC Branches)	ITP	IV
C.04	Harmonic Pass filters	ITP	IV
C.05	HT Capacitor	MQP	IV
D.01	Thyristor Valve	FAT/ITP	III
D.02	PLC Capacitors for HVDC	FAT/ITP	III
D.03	Valve Cooling system for	FAT/ITP	III

SECTION-GENERAL TECHNICAL REQUIREMENTS (GTR)

Annexure-G

Sl. No	Item / Equipment	Reference document for inspection	Inspection Level
	HVDC		
D.04	AC/DC Filter Resistors	ITP	III
D.05	DC Current and Voltage measuring device for HVDC	FAT/ITP	III
D.06	Maintenance platform for valve hall	POWERGRID TS	II
D.07	Optical signal column for FSC	FAT/ITP	II
E.01	GIS including spares	MQP/ITP	IV
E.02	Dew Point Meter for GIS	POWERGRID TS	I*
E.03	Portable Partial Discharge monitoring system for GIS	POWERGRID TS	I*
E.04	Partial Discharge Monitoring System (Online) for GIS	ITP	III
E.05	PEB Structure and Puf Panels	MQP	III
F.01	Substation Automation system	FAT/MQP	III
F.02	Event Logger	POWERGRID TS	III
F.03	PLCC equipment Viz PLCC Terminal ,Carrier equipment, Protection Coupler , Coupling Device but excluding EPAX / HF Cable	MQP	III
F.04	Control & Relay Panels	MQP	III
G.01	EHV Cables	MQP/ITP	III
G.02	Power Cables & Control Cables	MQP	III
G.03	Cable Joints (11 kV and above)	POWERGRID TS	II
G.04	Cable Lugs & Glands / Clamps/Terminations	POWERGRID TS	I
H.01	LT Switchgear & ACDB/DCDB/MLDB/ELDB	MQP	III
H.02	Battery	POWERGRID TS	II
H.03	Battery Charger	MQP	III
H.04	UPS & Voltage Stabilizer	MQP/FAT	III
H.05	D. G. Set	FAT/ITP	III
H.06	Lighting Panel	POWERGRID TS	II
H.07	Lighting Poles	POWERGRID TS	II
H.08.1	Lighting Fixtures, Lighting Earthwire, Switches / sockets, Conduits, Lamps & fans including exhaust fans	POWERGRID TS	I
H.8.2	Solar based LEDs System including street light/pole solar panel, Inverter controller/LED fixture	FAT	III
H.09	MS/GI /PVC Pipes for cable	POWERGRID TS	I

SECTION-GENERAL TECHNICAL REQUIREMENTS (GTR)**Annexure-G**

Sl. No	Item / Equipment	Reference document for inspection	Inspection Level
	trenches and lighting		
H.10	Outdoor Receptacle	POWERGRID TS	I
H.11	Split A.C/window A.C./ precision AC/ Kiosk AC/ Cascade AC/ Tower AC	POWERGRID TS	I
H.12	Occupancy sensors for control of lighting	POWERGRID TS	I
H.13	Solar based street lighting pole including Solar Panel, Inverter, Controller, etc.	POWERGRID TS	III
H.14	Junction Box / Lighting Switch Boards / Bay MB / Portable Flood Light Panel	POWERGRID TS	II
H.15	Lighting transformer	POWERGRID TS	II
I.01	SF6 gas processing unit, SF6 gas Leakage detector, SF6 gas Analyzer	POWERGRID TS	I*
I.02	SF6 Gas	POWERGRID TS	I
I.03	Spark Gap	FAT/ITP	III
I.04	Time synchronizing Equipment (GPS Clock)	POWERGRID TS	I
I.05	Galvanized Cable trays	POWERGRID TS	II
I.06	Video Monitoring System	FAT/ITP	I
I.07	Public Address System (All Components)	POWERGRID TS	I
I.08	Building Management System (All components)	POWERGRID TS	I
I.09	Access Control System (All Components)	POWERGRID TS	I
I.10	Video Display system/ Video Projection system	POWERGRID TS	I
I.11	VESDA (smoke detector)	POWERGRID TS	I
I.12	High Mast Pole	MQP	III
J.01	Aluminium ladder	POWERGRID TS	I
J.02	Hume Pipes	POWERGRID TS	I
J.03	Castle Key	POWERGRID TS	I
J.04	Water Treatment plant (All components).	POWERGRID TS	I
J.05	Furniture	POWERGRID TS	I
J.06	DOL Starter	POWERGRID TS	I
J.07	Oil Sample Bottles and Syringe	POWERGRID TS	I
J.08	Test & Measuring Equipment, T&P	POWERGRID TS	I*
K.01	EOT Crane	POWERGRID TS	II

SECTION-GENERAL TECHNICAL REQUIREMENTS (GTR)**Annexure-G**

Sl. No	Item / Equipment	Reference document for inspection	Inspection Level
K.02	Boom Crane/Golf Cart/Platform Truck/Man Lift/ Fork Lift/ Lifts	POWERGRID TS	II
L.00	Fire Protection System		
L.001	Panels, Hydro pneumatic tank for fire protection system.	POWERGRID TS	III
L.002	Deluge valve, Strainers, MS/GI pipes, Pumps, motors, air compressor, and other valves, Diesel Engines	POWERGRID TS	II
L.003	Others	POWERGRID TS	I
M.00	HVAC SYSTEM		
M.001	Air Cooled Chiller	POWERGRID TS	III
M.002	Pump	POWERGRID TS	II
M.003	Air Handling Unit	POWERGRID TS	II
M.004	Fan Filter Unit With Centrifugal Blower	POWERGRID TS	II
M.005	Axial Flow Fan	POWERGRID TS	II
M.006	Main Climate Control Unit (Dehumidifier)	POWERGRID TS	I
M.007	Dampers	POWERGRID TS	II
M.008	Fire Dampers	POWERGRID TS	II
M.009	Pressure Gauge, Thermometers, Other Instruments / Sensors	POWERGRID TS	I
M.010	Grill, Diffuser, Jet Nozzle, Louvers etc	POWERGRID TS	I
M.011	Ducting	POWERGRID TS	III
M.012	M S Pipe	POWERGRID TS	II
M.013	Pipe Insulation Material	POWERGRID TS	I
M.014	Duct Insulation Material	POWERGRID TS	I
M.015	Underdeck Insulation Material	POWERGRID TS	I
M.016	Gate Valve & Non Return valve	POWERGRID TS	I
M.017	Y Strainer	POWERGRID TS	II
M.018	Ball Valve/ Motorised Butterfly Valve/ Balancing Valve	POWERGRID TS	I
M.019	Closed Expansion Tank	POWERGRID TS	II
M.020	Air Separator	POWERGRID TS	I
M.021	MCC /PLC /Electrical Panels	POWERGRID TS	III
M.022	Propeller Fan/ Conduit	POWERGRID TS	II
M.023	Air Filter/ Mixing Valve with Thermostat	POWERGRID TS	I

SECTION-GENERAL TECHNICAL REQUIREMENTS (GTR)**Annexure-G**

Sl. No	Item / Equipment	Reference document for inspection	Inspection Level
N.01	SDH Equipment	FAT/ITP	IV
N.02	Termination Equipment Primary/ DI Multiplexer	FAT/ITP	IV
N.03	DACS	FAT/ITP	IV
N.04	Optical Amplifier	FAT/ITP	IV
N.05	FODP including pigtail, Joint Box, FDMS	FAT/ITP	II
N.06	IMPS	FAT/ITP	IV
N.07	Optical bypass switch	FAT/ITP	IV
N.08	Air Purifier	FAT/ITP	I
N.09	Patch cord & connector	FAT/ITP	I
N.10	NMS	FAT/ITP	IV
N.11	OPGW Cable	MQP/ITP/FAT	III
N.12	Hardware Fittings for OPGW cable	MQP/ITP	III
N.13	DCPS	FAT/ITP	III
N.14	Radio Links	FAT/ITP	III
N.15	SMPS based DC Power Supply (DCPS) system	FAT/ITP	III
N.16	WAMS (PMU & Accessories)	FAT/ITP	III
N.17	PUF Shelter	FAT/ITP	III
N.18	Aerial OFC/UGOFC/ADSS/FO Cable	FAT/ITP	III
N.19	DWDM	FAT/ITP	III
N.20	OTN	FAT/ITP	III
N.21	MPLS-TP Equipment	FAT/ITP	III
N.22	L2 Switch	FAT/ITP	III
N.23	IP-MPLS Router	FAT/ITP	III
N.24	HDPE Pipes	POWERGRID TS	II
N.25	Equipment Cabinets	POWERGRID TS	II
N.26	Main Distribution Frame	POWERGRID TS	I
N.27	Telephone system, EPAX, Telephone wires, Telephone sockets	POWERGRID TS	I
N.28	Fibre Optic Cable	MQP	III
N.29	Hardware Fittings for Fibre Optic cable	MQP	III
O.01	Re-rollers of MS/HT Angle Section and galvanized tower parts.	MQP	IV
O.02	Conductor	MQP	IV
O.03	Hardware fittings and Conductor & Earthwire Accessories	MQP	IV
O.04	Earth wire	MQP	IV

SECTION-GENERAL TECHNICAL REQUIREMENTS (GTR)

Annexure-G

Sl. No	Item / Equipment	Reference document for inspection	Inspection Level
O.05	Insulator	MQP	IV
O.06	Bolts & Nuts of Gr 8.8 / 8	MQP	IV
O.07	Mono Pole	MQP	IV
O.08	Foundation Bolts & Anchor Bolts	POWERGRID TS	III
O.09	D-shackle/ Hanger / Links and associated Special bolt/nuts	MQP	III
O.10	Span Marker, Obstruction lights and Wind Measuring Equipment	POWERGRID TS	III
O.11	MS ROD rolled by Approved Re-roller of POWERGRID	MQP	III
O.12	MS ROD rolled by Approved steel producers of POWERGRID	POWERGRID TS	I
O.13	Spring Washers & Pack washers	POWERGRID TS	II
O.14	Bolts & Nuts Gr up to 5.6/5	POWERGRID TS	II
O.15	ACD & Barbed wire for ACD/Bird guard	POWERGRID TS	II
O.16	Danger Plate /Phase Plate / Number Plate / Circuit plate	POWERGRID TS	I
O.17	Sub Station Structure (lattice/pipe type)	MQP	III
O.18	Clamps & Connecters (including equipment connectors)	MQP	III
O.19	MS/ GI Flat, rod type, pipe type and other earthing material.	POWERGRID TS	II
O.20	Aluminium Tube & Busbar materials	POWERGRID TS	II
O.21	Pipe Type & Counter Poise Earthing	POWERGRID TS	II
O.22	DTS System	POWERGRID TS	II

For Equipment where requirement of MQP is envisaged, ITP/FAT will be followed If sourced from off shore. For items required in S/S or T/L or TELECOM/LD&C , same inspection level as specified shall be followed for all the cases.

* MICC for test and measuring equipment (inspection level I or II) shall be issued only after actual verification/ demonstration of satisfactory performance at site.

** Though level-2 items, CIP/MICC can be issued also on review of TCs and visual inspection of these item.

Sl. No.	Power System Equipment	Minimum Local Content (%)
1	Power Transformers (up to 765 kV, including Generator Transformers)	60
2	Instrument Transformer (up to 765 kV)	60
3	Transformer Oil Dry Out System (TODOS)	60
4	Reactors up to 765 kV	60
5	Oil Impregnated Bushing (Up to 400kV)	60
6	Resin Insulated Paper (RIP) bushings (up to 145 kV)	50
7	Circuit Breakers (up to 765kV AC-Alternating Current)	60
8	Disconnectors/ Isolators (up to 765kV AC)	60
9	Wave Trap (up to 765kV AC)	60
10	Oil Filled Distribution Transformers up to & including 33kV [Cold Rolled Grain Oriented (CRGO)/Amorphous, Aluminium/Copper wound]	60
11	Dry type Distribution Transformers up to & including 33kV (CRGO/Amorphous, Aluminium/Copper wound)	60
12	Conventional conductor	60
13	Accessories for conventional conductors	60
14	High Temperature/High Temperature Low Sag (HTLS) conductors (such as Composite core, GAP, ACSS, INVAR, AL59) and accessories	60
15	Optical ground wire (OPGW)- all designs	60
16	Fiber Optic Terminal Equipment (FOTE) for OPGW	50
17	OPGW related Hardware and accessories	60
18	Remote Terminal Unit (RTU)	50
19	Power Cables and accessories up to 33kV	60
20	Control cables including accessories	60
21	XLPE cables up to 220kV	60
22	Substation Structures	60
23	Transmission Line Towers	60
24	Porcelain (Disc/Long Rod) Insulators	60
25	Bus Post Insulators (Porcelain)	60
26	Porcelain Disc Insulators with Room Temperature Vulcanisation (RTV) coating	50
27	Porcelain Long Rod Insulators with Room temperature Vulcanisation (RTV) coating	50
28	Hardware Fittings for porcelain Insulators	60
29	Composite/Polymeric Long Rod Insulators	60
30	Hardware Fittings for Polymer Insulators	60
31	Bird Flight Diverter (BFD)	60
32	Power Line Carrier Communication (PLCC) system (up to 800kV)	60
33	Gas Insulated Switchgear (up to 400kV AC)	60
34	Gas Insulated Switchgear (above 400kV AC)	50
35	Surge/Lightning Arrester (up to 765kV AC)	60
36	Power Capacitors	60
37	Packaged Sub-station (6.6kV to 33kV)	60
38	Ring Main Unit (RMU) (up to 33kV)	60

SECTION-GENERAL TECHNICAL REQUIREMENTS (GTR) Annexure K (Rev 01)

39	Medium Voltage (MV) GIS panels (up to 33kV)	60
40	Automation and Control system/Supervisory Control and Data Acquisition (SCADA) system in Power system	50
41	Control and Relay panel (including Digital/Numerical relays)	50
42	Electrical motors 0.37kW to 1MW	60
43	Energy meters excluding smart meters	50
44	Control and Power cables and accessories (up to 1.1kV)	60
45	Diesel Generating (DG) set	60
46	DC system (DC Battery & Battery Charger)	60
47	AC and DC Distribution board	60
48	Indoor Air Insulated Switchgear (AIS) up to 33kV	60
49	Poles (PCC, PSCC, Rolled Steel Joist, Rail Pole, Spun, Steel Tubular)	60
50	Material for Grounding/earthing system	60
51	Illumination system	60
52	Overhead Fault Sensing Indicator (FSI)	50
53	Power Quality Meters	50
54	Auxiliary Relays	50
55	Load Break Switch	50
56	Cranes, EOT cranes, gantry crane & chain pulley blocks, etc	60
57	Elevator	60
Fire Protection and Detection system		
58	Motor driven fire water pumps	60
59	Diesel engine driven fire water pumps	60
60	Hydrant system	60
61	High velocity water spray system	60
62	Medium velocity water spray system	60
63	Foam Protection system	60
64	Inert gas flooding system	60
65	Fire tenders	60
66	Portable fire-extinguishers	60



Project:	NEEMUCH 400/220 kV Substation
Customer:	POWER GRID CORPORATION OF INDIA LIMITED
Contractor:	Bharat Heavy Electricals Limited
Document No.	TB-418-302-002, Rev.00
Technical Specification:	220V & 48V Battery Charger

SECTION – 4

GUARANTEED TECHNICAL PARTICULARS FOR BATTERY CHARGER

S.No.	DESCRIPTION	220 V Battery Charger (120A)	48 V Battery Charger (120A)
1.	Manufacturer's Name		
2.	Charger dimensions		
	(i) Height (mm)		
	(ii) Depth (mm)		
	(iii) Width (mm)		
	(iv) Sheet thickness (mm)		
3.	Charger weight (kg)		
4.	Charger rated output current		
	(i) Float charging mode		
	(ii) Boost charging mode		
5.	Load limiter current setting range (Trickle mode)		
6.	Automatic voltage regulator (Float mode):		
	(i) Type		
	(ii) Percentage stabilisation of the output DC voltage		
	(iii) Voltage setting range		
	(iv) Response time of automatic Voltage regulator		
7.	Manual voltage regulator (Float mode)		
	(i) Type		
	(ii) Voltage setting range		
8.	Boost charging current Setting range		
9.	Boost charging limit Setting range		



Project:	NEEMUCH 400/220 kV Substation
Customer:	POWER GRID CORPORATION OF INDIA LIMITED
Contractor:	Bharat Heavy Electricals Limited
Document No.	TB-418-302-002, Rev.00
Technical Specification:	220V & 48V Battery Charger

10.	Rectifier assembly:		
	(i) Type of semiconductor material		
	(ii) Rated direct current per cell		
	(iii) Rated D.C voltage		
	(iv) Rated input voltage		
	(v) Type of connections of rectifier elements		
	(vi) Standard applicable		
11.	Rectifier transformer		
	(i) Type		
	(ii) Rated KVA & % impedance		
	(iii) Input line winding connection in vector representation		
	(iv) Cell winding connection in vector representation		
	(v) One minute power frequency withstand voltage (KV)		
	(vi) Standard applicable		
12.	Instruments:		
	(i) Type		
	(ii) DC voltmeter range		
	(iii) DC Ammeter range		
	(iv) Dial Size		
	(v) Accuracy class		
13.	Connector:		
	(i) Type		
	(ii) Rated voltage		
	(iii) Rated current		



Project:	NEEMUCH 400/220 kV Substation
Customer:	POWER GRID CORPORATION OF INDIA LIMITED
Contractor:	Bharat Heavy Electricals Limited
Document No.	TB-418-302-002, Rev.00
Technical Specification:	220V & 48V Battery Charger

	(iv) No of power contacts		
	(v) No., type and rating of aux. contacts		
	(vi) Operating coil voltage		
	(vii) Drop out voltage		
14.	Thermal overload relay		
	(i) Tripping current range		
	(ii) Whether single phasing Protection provided		
	(iii) Standard applicable		
15.	Air break switches		
	(i) Type		
	(ii) Rated voltage		
	(iii) Rated current		
	(iv) Type and material of contacts		
	(v) Standard applicable		
16.	Fuses:		
	(i) Type		
	(ii) Rupturing capacity		
	(iii) Standard applicable		



Project:	NEEMUCH 400/220 kV Substation
Customer:	POWER GRID CORPORATION OF INDIA LIMITED
Contractor:	Bharat Heavy Electricals Limited
Document No.	TB-418-302-002, Rev.00
Technical Specification:	220V & 48V Battery Charger

SECTION 5

CHECK LIST FOR INFORMATION TO BE FURNISHED WITH OFFER RETURN THIS CHECKLIST AS PART OF THE OFFER DULY SIGNED

PLEASE NOTE:

- a) The offer may not be considered if the following information and this Checklist are not enclosed with the Offer.
- b) The evaluation of bidder against qualifying criteria specified under clause 1.4 of Section –I of technical specification shall be based on the documentary proof submitted by bidder along with the offer.

Hence bidder shall ensure the completeness of their offer in this regard.

BHEL ENQUIRY. NO:

BIDDER: OFFER REFERENCE:

EQUIPMENT: BATTERY CHARGER

S.No.	Qualifying criteria (clause 1.4 Section-1)	Documentary proof required	Yes/No
1	The manufacturer, whose Battery Chargers are offered, should have designed, manufactured and supplied Battery Chargers generally of the type offered, with static automatic voltage regulators and having a continuous output of at least ten (10) kW and these should be in successful as on the date of NOA (i.e., 23.09.2022).	Documentary proof attached	

S. No.	Parameters	Data	Yes	Remarks
1.	Type of Battery Charger	a) Static Type with automatic regulators. b) Compatible with VRLA Batteries	Yes	
3	Float charging	Offered battery chargers are capable of continuous operation at respective rated load at 2.13 to 2.27 Volts per cell while supplying the DC Load	Yes	
4	Boost Charging	Offered Battery chargers are capable of boost charging associated DC battery at	Yes	



Project:	NEEMUCH 400/220 kV Substation
Customer:	POWER GRID CORPORATION OF INDIA LIMITED
Contractor:	Bharat Heavy Electricals Limited
Document No.	TB-418-302-002, Rev.00
Technical Specification:	220V & 48V Battery Charger

		2.28 to 2.32 Volts per cell at the desired rate		
5	Feedback control for Temperature sensors	The offered battery chargers have provision for wiring temperature sensors which are located on it respective battery banks for feedback control	Yes	
6	Demonstration of Feedback control	The manufacturer shall demonstrate the feedback control feature during testing of each charger	Yes	
7	Voltage and Current control	a) All offered battery chargers shall be provided with facility for both automatic and manual control of the output voltage and current. b) Charger output voltage variation shall be within +/- 1%	Yes	
8	Step less adjustment of Load limiter setting	80% to 100% of rated output current for charging mode	Yes	
9	Ripple content in output voltage	Suitable filter circuits shall be provided in all chargers to limit the ripple (Peak to peak) content in output voltage to 1% irrespective of DC Load level when not connected to battery	Yes	
10	Rectifier Transformer	Dry air cooled (A.N), Class F insulation type and shall have 10% overload capacity	Yes	
11	Remote Indication	(I) Provision of Potential free NO contacts for following abnormalities. a) AC Power Failure b) Rectifier /chargers fuse blown c) Over voltage across the battery when boost charging d) Abnormal Voltage (High/Low) e) Any other annunciation (as recommended by manufacturer) (II) Potential free contact for Float / boost modes provided	Yes	
12	Charger construction	In line with clause 1.3.18 (Section-2)	Yes	
13.	Tests	Shall be in line with clause 1.3.20 (Section-2)	Yes	
14.	Powergrid standard	Available	Yes	

	Project:	NEEMUCH 400/220 kV Substation
	Customer:	POWER GRID CORPORATION OF INDIA LIMITED
	Contractor:	Bharat Heavy Electricals Limited
	Document No.	TB-418-302-002, Rev.00
	Technical Specification:	220V & 48V Battery Charger

	/previously approved document as per Powergrid Battery Charger specification Rev06	Powergrid approval Letter of drgs & Type test reports attached along with offer.	Yes	
15	Type test reports	If the submitted type test reports submitted are not acceptable to Powergrid / customer / BHEL then the tests shall be repeated without additional time and cost implication to BHEL.	Yes	

**Signature of the authorized representative
of Bidder with Company Seal:**

Date:

Place:

Phone:

Fax:

E-mail:

Mobile:

Website:

	Project:	NEEMUCH 400/220 kV Substation
	Customer:	POWER GRID CORPORATION OF INDIA LIMITED
	Contractor:	Bharat Heavy Electricals Limited
	Document No.	TB-418-302-002, Rev.00
	Technical Specification:	220V & 48V Battery Charger

ANNEXURE - A

SCHEDULE OF TECHNICAL DEVIATIONS

Bidder shall list below all technical deviation clause wise w.r.t. tender specifications:

S.No.	Page No.	Clause No.	Deviation	Reason / Justification
-------	----------	------------	-----------	------------------------

Any deviation not specifically brought out in this section shall not be admissible for any commercial implication at later stage. Except to the technical deviations listed in this schedule, bidder's offer shall be considered in full compliance to the tender specifications irrespective of any such deviation indicated / taken elsewhere in the submitted offer.

Date:

Tenderer's Stamp & Signature