

NTPC LIMITED

NSPCL BHILAI EXPANSION POWER PROJECT NSPCL BHILAI (2x250MW)

TECHNICAL SPECIFICATION

FOR

GYPSUM DEWATERING EQUIPMENT

SPECIFICATION NO.: PE-TS-468-571-A901, Rev 00



**BHARAT HEAVY ELECTRICALS LIMITED
POWER SECTOR
PROJECT ENGINEERING MANAGEMENT
PROJECT ENGINEERING INSTITUTE BUILDING
SECTOR-16A, PLOT NO. 25, NOIDA, INDIA**

	NSPCL BHILAI (2X250MW)	SPECIFICATION No: PE-TS-468-571-A901	
	GYPSUM DEWATERING EQUIPMENT	SECTION	
	TECHNICAL SPECIFICATION	REV. 00	
		SHEET : 1 OF 2	

CONTENTS

SECTION - I

SUB-SECTIONS	TITLE	Page No.
Sub-Section-A	INTENT OF SPECIFICATION	5-7
Sub-Section-B	PROJECT INFORMATION	8-36
Sub-Section-C	TECHNICAL SPECIFICATIONS	37
Sub Section-C1	SPECIFIC TECHNICAL REQUIREMENT	38-56
Sub Section-C2	CUSTOMER SPECIFICATION	57-181
	C2 - A PROJECT SPECIFIC GENERAL REQUIREMENTS INCLUDING:	
	FUNCTIONAL GUARANTEES & LIQUIDATED DAMAGES	
	GENERAL TECHNICAL REQUIREMENT	
	QUALITY ASSURANCE	
	DRAWINGS / DOCUMENTS SUBMISSION PROCEDURE	
Sub Section-C3	TECHNICAL SPECIFICATION (ELECTRICAL PORTION)	182-221
Sub Section-C4	TECHNICAL SPECIFICATION (C&I PORTION)	222-399
Sub Section-D	LIST OF ANNEXURES ENCLOSED	400
	ANNEXURE-I LIST OF MAKES OF SUB-VENDOR ITEMS	401
	ANNEXURE-II MANDATORY SPARE LIST	402-407
	ANNEXURE-III INSPECTION AND TESTING, QUALITY PLAN	408-428
	ANNEXURE-IV INPUT DRAWINGS (PID/ MECHANICAL LAYOUT DRAWINGS SHOWING LOCATION OF EQUIPMENT/ PLOT PLAN)	429-447
	ANNEXURE-V MASTER DRAWING LIST WITH SCHEDULE OF SUBMISSION	448-453
	ANNEXURE-VI PACKING PROCEDURE	454-457
	ANNEXURE-VII SEA-WORTHY PACKING PROCEDURE	458-510
	ANNEXURE-VIII PIPE & VALVE MATERIAL SPECIFICATION	511-516

SECTION - II

SUB SECTIONS	TITLE	Page No.
Sub Section-1	STANDARD TECHNICAL REQUIREMENTS	517-521

THIS IS PART OF TECHNICAL SPECIFICATION PE-TS-468-571-A901 REV 00.

	NSPCL BHILAI (2X250MW)	SPECIFICATION No: PE-TS-468-571-A901	
	GYPSUM DEWATERING EQUIPMENT	SECTION	
	TECHNICAL SPECIFICATION	REV. 00	
		SHEET : 2 OF 2	

SECTION - III

SUB SECTIONS	TITLE	Page No.
Annexure-1	LIST OF DOCUMENTS TO BE SUBMITTED WITH BID	522
Annexure-2	COMPLIANCE CUM CONFIRMATION CERTIFICATE	523-524
Annexure-3	PRE BID CLARIFICATION SCHEDULE	525
Annexure-4	DEVIATION SHEET (COST OF WITHDRAWAL)	526
Annexure-5	SCHEDULE OF GUARANTEES	527-528
Annexure-6	LIST OF MAKES OF SUB VENDOR ITEMS	529
Annexure-7	LIST OF TOOLS & TACKLES	530
Annexure-8	EQUIPMENT DATA SHEET/ SCHEDULE (TO BE FILLED BY BIDDER)	531-538
Annexure-9	LIST OF COMMISSIONING SPARES	539

THIS IS PART OF TECHNICAL SPECIFICATION PE-TS-468-571-A901 REV. 00.



NSPCL BHILAI (2X250 MW)
GYPSUM DEWATERING EQUIPMENT
TECHNICAL SPECIFICATION

SPECIFICATION No: PE-TS-468-571-A901

SECTION: I

REV. 00

SECTION - I

THIS IS PART OF TECHNICAL SPECIFICATION PE-TS-468-571-A901 REV 00.



NSPCL BHILAI (2X250 MW)
GYPSUM DEWATERING EQUIPMENT
TECHNICAL SPECIFICATION
INTENT OF SPECIFICATION

SPECIFICATION No: PE-TS-468-571-A901

SECTION : I

Sub Section: A

REV. 00

SHEET 1 OF 3

SECTION-I
SUB-SECTION-A
INTENT OF SPECIFICATION

THIS IS PART OF TECHNICAL SPECIFICATION PE-TS-468-571-A901 REV 00.

	NSPCL BHILAI (2X250 MW)	SPECIFICATION No: PE-TS-468-571-A901	
	GYPHUM DEWATERING EQUIPMENT	SECTION : I	
	TECHNICAL SPECIFICATION	Sub Section: A	
	INTENT OF SPECIFICATION	REV. 00	
		SHEET 2 OF 3	

1.0 INTENT OF SPECIFICATION

- 1.1 This specification covers Supply part, Services part and Mandatory Spares; comprising of design (i.e. Preparation and submission of drawing /documents including "As Built" drawings and O&M manuals), engineering, manufacture, fabrication, assembly, inspection / testing at vendor's & sub-vendor's works, painting, maintenance tools & tackles, first fill and top-up of lubricants & consumables, mandatory spares along with spares for erection, start-up and commissioning, forwarding, proper packing, shipment and delivery at site, assembly AND Services part covers supervision services for erection & commissioning, trial run at site and carrying out Performance Guarantee tests at site, training of customer's personnel at manufacturer's works covering design familiarization, training on product design features etc. (6 man-days including lodging and boarding), training of customer's O&M staff covering all aspects of the GDS-Operation & Maintenance, Troubleshooting etc. (6 days) at Site & handover of the package in flawless condition to the customer complete with all accessories for the total scope defined as per BHEL NIT & tender technical specification, amendment & agreements till placement of order of **Gypsum Dewatering Equipment**, a sub-assembly of the Flue Gas Desulphurization (FGD) package of **2x250MW Bhilai, Chhattisgarh of M/s NSPCL Limited (a JV of NTPC & SAIL)**.
- 1.2 Two (02) Sets of Gypsum Dewatering Equipment (1 working + 1 standby) common for both the units shall be provided.
- 1.3 The contractor shall be responsible for providing all material, equipment & services, which are required to fulfil the intent of ensuring operability, maintainability, reliability and complete safety of the complete work covered under this specification, irrespective of whether it has been specifically listed herein or not. Omission of specific reference to any component / accessory necessary for proper performance of the equipment shall not relieve the contractor of the responsibility of providing such facilities to complete the supply, erection and commissioning, performance and guarantee/demonstration testing of **GYPHUM DEWATERING EQUIPMENT**.
- 1.4 The Bidder shall offer only proven design, which meets the Provenness criteria indicated in the NIT. Necessary documentary evidences shall be submitted along with the bid. If bidder doesn't meet the specified provenness criteria, their bid may not be considered for further evaluation.
- 1.5 It is not the intent to specify herein all the details of design and manufacture. However, the equipment shall conform in all respects to the highest standards of design, engineering and workmanship and shall be capable of performing the required duties in a manner acceptable to the purchaser who will interpret the meaning of drawings and specifications and shall be entitled to reject any work or material which in his judgement is not in full accordance.
- 1.6 The extent of supply under the contract includes all items shown in the drawings, notwithstanding the fact that such items may have been omitted from the specification or schedules. Similarly, the extent of supply also includes all items mentioned in the specification and /or schedules, notwithstanding the fact that such items may have been omitted in the drawing. Similarly, the extent of supply also includes all items required for completion of the equipment/ system for its safe, efficient, reliable and trouble free operation and maintenance shall also be in supplier's scope unless specifically excluded and notwithstanding that they may have been omitted in drawings / specifications or schedules.

THIS IS PART OF TECHNICAL SPECIFICATION PE-TS-468-571-A901 REV 00.

	NSPCL BHILAI (2X250 MW)	SPECIFICATION No: PE-TS-468-571-A901	
	GYPSUM DEWATERING EQUIPMENT TECHNICAL SPECIFICATION	SECTION : I	
		Sub Section: A	
		REV. 00	
	INTENT OF SPECIFICATION	SHEET 3 OF 3	
<p>1.7 The general term and conditions, instructions to tenderers and other attachment(s) referred to elsewhere are made part of the tender specification. The equipment materials and works covered by this specification is subject to the compliance to all attachments referred to in the specification. The bidder shall be responsible for and governed by all requirements stipulated herein.</p> <p>1.8 While all efforts have been made to make the specification requirement complete & unambiguous, it shall be bidders' responsibility to ask for missing information, ensure completeness of specification, to bring out any contradictory / conflicting requirement in different sections of the specification and within a section itself to the notice of BHEL and to seek any clarification on specification requirement in the format enclosed under Section-III of the specification within 10 days of receipt of tender documents. In absence of any such clarification(s), in case of any contradictory requirement, the more stringent requirement as per interpretation of Purchaser / Customer shall prevail and shall be complied by the bidder without any commercial implication on account of the same. Further, in case of any missing information in the specification not brought out by the prospective bidders as part of pre-bid clarification, the same shall be furnished by Purchaser/ Customer as and when brought to their notice either by the bidder or by purchaser/ customer themselves. However, such requirements shall be binding on the successful bidder without any commercial & delivery implication.</p> <p>1.9 The bidder's offer shall not carry any section like clarification, interpretations and /or assumptions.</p> <p>1.10 Deviations, if any, should be very clearly brought out clause by clause along with cost of withdrawal in the enclosed schedule (in Section -III); otherwise, it will be presumed that the vendor's offer is strictly in line with NIT specification. If no cost of withdrawal is given against the deviation, it will be presumed that deviation can be withdrawn without any cost to BHEL/it's customer.</p> <p>1.11 In the event of any conflict between the requirements of two clauses of this specification & requirements of different codes/standards and between respective clauses of sub-section C & sub-section D, more stringent clause as per the interpretation of the owner shall apply.</p> <p>1.12 In case, all the above requirements are not complied with, the offer may be considered as incomplete and would become liable for rejection.</p> <p>1.13 For definition of words like Contractor, bidder, supplier, vendor, Customer/ Purchaser / Employer, consultant, please refer relevant clause of General Conditions of Contract (GCC).</p>			



NSPCL BHILAI (2X250MW)
GYPSUM DEWATERING EQUIPMENT
PROJECT INFORMATION

SPECIFICATION No: PE-TS-468-571-A901

SECTION : I

Sub Section : B

REV. 00

SECTION: I
SUB-SECTION: B
PROJECT INFORMATION

THIS IS PART OF TECHNICAL SPECIFICATION PE-TS-468-571-A901 REV 00.

CLAUSE NO.	PROJECT INFORMATION 		
1.00.00	<p>BACKGROUND</p> <p>NSPCL has setup coal based thermal power plant of 2X250 MW capacity at BHILAI in Chhattisgarh primarily to meet captive power requirement of SAIL, NSPCL is supplying balance power to the beneficiaries in the western region. Both the units have been commissioned during 2008-09 and commercialized during 2009-10.</p>		
1.01.0	<p>LOCATION AND APPROACH</p> <p>The NSPCL site is located at District Durg, Bhilai (East) having latitude and longitude of 21° 11' 25" N and 81°26'05" E, respectively. The nearest railhead on the Raipur- Nagpur section of South Eastern Central Railway is Bhilai which is approx. 4 km from site. The site is approachable from National Highway -6 which connects the site with both Durg and Raipur. The nearest- airport is at Raipur, about 35kms away from the site. The nearest town is Bhilai, approx. 10 km from the project site.</p> <p>Vicinity plan of the proposed project is placed at Annexure-I.</p>		
1.02.00	<p>LAND</p> <p>Total land area for plant & dyke is 659 acres. Ash Dyke is constructed in 221 Acre land.</p>		
1.03.00	<p>WATER</p> <p>The make- up water requirement for the plant has been met from the existing system of Bhilai CPP-1, CPP-2 and BSP i: e Maroda Tank-II, which is fed by Tandula Main Canal.</p>		
1.04.00	<p>Coal Quality Parameters / Fuel Oil Characteristics & Plant Water details:</p> <ul style="list-style-type: none"> (i) The coal quality parameters and Fuel oil Characteristics are indicated in Table-1 & Table-2 respectively below. (ii) Process water: Process water quality based on COC given in Table-4. (iii) Clarified water: Clarified water quality is indicated in Table-4. (iv) DM water for Equipment cooling water system. DM water quality is indicated in Table-5. 		
1.05.00	<p>STEAM GENERATOR AND ESP DATA: Refer Table-6</p>		
1.06.00	<p>Drawings are enclosed as per Table-7 for initial overview to the Bidder.</p>		
2.00.00	<p>NOT USED</p>		
3.00.00	<p>Capacity</p>		
	<p>Present proposal : 2 X 250 MW</p>		
4.00.00	<p>Metrological Data</p> <p>The metrological data from nearest observatory is placed at Annexure-II.</p>		
<p>LOT-2 PROJECTS FLUE GAS DESULPHURISATION (FGD) SYSTEM PACKAGE</p>	<p>TECHNICAL SPECIFICATION SECTION – VI, PART-A BID DOC. NO.:CS-0011-109(2)-9</p>	<p>SUB-SECTION-II-A5 PROJECT INFORMATION (BHILAI 2X250 MW)</p>	<p>PAGE 1 OF 30</p>

CLAUSE NO.	PROJECT INFORMATION														
5.00.00	<div style="text-align: right; margin-bottom: 10px;">  </div> <p>CRITERIA FOR EARTHQUAKE RESISTANT DESIGN OF STRUCTURES AND</p> <table border="0" style="width: 100%;"> <tr> <td style="width: 60%;">a) Steel structures</td> <td style="width: 10%; text-align: center;">:</td> <td style="width: 30%; text-align: right;">2%</td> </tr> <tr> <td>b) Reinforced Concrete structures</td> <td style="text-align: center;">:</td> <td style="text-align: right;">5%</td> </tr> <tr> <td>c) Reinforced Concrete Stacks</td> <td style="text-align: center;">:</td> <td style="text-align: right;">3%</td> </tr> <tr> <td>d) Steel stacks</td> <td style="text-align: center;">:</td> <td style="text-align: right;">2%</td> </tr> </table> <p>EQUIPMENT</p> <p>All structures and equipment shall be designed for seismic forces adopting the site specific seismic information provided in this document and using the other provisions in accordance with IS:1893 (Part 1 to Part 4). Pending finalization of Part 5 of IS:1893, provisions of part 1 shall be read along with the relevant clauses of IS:1893:1984, for embankments.</p> <p>A site specific seismic study has been conducted for the project site. The peak ground horizontal acceleration for the project site, the site specific acceleration spectral coefficients (in units of gravity acceleration 'g') in the horizontal direction for the various damping values and the multiplying factor (to be used over the spectral coefficients) for evaluating the design acceleration spectra are as given at Appendix-I.</p> <p>Vertical acceleration spectral values shall be taken as 2/3rd of the corresponding horizontal values.</p> <p>The site specific design acceleration spectra shall be used in place of the response acceleration spectra, given at figure-2 in IS:1893 (Part 1) and Annex B of IS:1893 (Part 4). The site specific acceleration spectra along with multiplying factors specified in Appendix-I includes the effect of the seismic environment of the site, the importance factor related to the structures and the response reduction factor. Hence, the design spectra do not require any further consideration of the zone factor (Z), the importance factor (I) and response reduction factor (R) as used in the IS:1893 (Part 1 to Part 4).</p> <p>Damping in Structures</p> <p>The damping factor (as a percentage of critical damping) to be adopted shall not be more than as indicated below for:</p>			a) Steel structures	:	2%	b) Reinforced Concrete structures	:	5%	c) Reinforced Concrete Stacks	:	3%	d) Steel stacks	:	2%
a) Steel structures	:	2%													
b) Reinforced Concrete structures	:	5%													
c) Reinforced Concrete Stacks	:	3%													
d) Steel stacks	:	2%													
<p style="text-align: center;">LOT-2 PROJECTS FLUE GAS DESULPHURISATION (FGD) SYSTEM PACKAGE</p>	<p style="text-align: center;">TECHNICAL SPECIFICATION SECTION – VI, PART-A BID DOC. NO.:CS-0011-109(2)-9</p>	<p style="text-align: center;">SUB-SECTION-II-A5 PROJECT INFORMATION (BHILAI 2X250 MW)</p>	<p style="text-align: center;">PAGE 2 OF 30</p>												

CLAUSE NO.	PROJECT INFORMATION 		
	<p>Method of Analysis</p> <p>Since most structures in a power plant are irregular in shape and have irregular distribution of mass and stiffness, dynamic analysis for obtaining the design seismic forces shall be carried out using the response spectrum method. The number of vibration modes used in the analysis should be such that the sum total of modal masses of all modes considered is at least 90 percent of the total seismic mass and shall also meet requirements of IS:1893 (Part 1). Modal combination of the peak response quantities shall be performed as per Complete Quadratic Combination (CQC) method or by an acceptable alternative as per IS:1893 (Part 1).</p> <p>In general, seismic analysis shall be performed for the three orthogonal (two principal horizontal and one vertical) components of earthquake motion. The seismic response from the three components shall be combined as specified in IS:1893 (Part 1).</p> <p>The spectral acceleration coefficient shall get restricted to the peak spectral value if the fundamental natural period of the structure falls to the left of the peak in the spectral acceleration curve.</p> <p>For buildings, if the design base shear (V_B) obtained from modal combination is less than the base shear (\bar{V}_B) computed using the approximate fundamental period (T_a) given in IS:1893:Part 1 and using site specific acceleration spectra with appropriate multiplying factor, the response quantities (e.g. member forces, displacements, storey forces, storey shears and base reactions) shall be enhanced in the ratio of \bar{V}_B / V_B. However, no reduction is permitted if \bar{V}_B is less than V_B.</p> <p>Design/Detailing for Ductility for Structures</p> <p>The site specific design acceleration spectra is a reduced spectra and has an in-built allowance for ductility. Structures shall be engineered and detailed in accordance with relevant Indian/International standards to achieve ductility.</p>		
<p>LOT-2 PROJECTS FLUE GAS DESULPHURISATION (FGD) SYSTEM PACKAGE</p>	<p>TECHNICAL SPECIFICATION SECTION – VI, PART-A BID DOC. NO.:CS-0011-109(2)-9</p>	<p>SUB-SECTION-II-A5 PROJECT INFORMATION (BHILAI 2X250 MW)</p>	<p>PAGE 3 OF 30</p>

CLAUSE NO.	PROJECT INFORMATION		
	<div style="text-align: right;">  </div> <p style="text-align: right;">APPENDIX – I</p> <p><u>SITE SPECIFIC SEISMIC PARAMETERS FOR DESIGN OF STRUCTURES AND EQUIPMENT</u></p> <p>The various site specific seismic parameters for the project site shall be as follows:</p> <ol style="list-style-type: none"> 1) Peak ground horizontal acceleration : 0.10g 2) Multiplying factor to be applied to the site specific horizontal acceleration spectral coefficients (in units of gravity acceleration 'g') to obtain the design acceleration spectra <ol style="list-style-type: none"> a) for special moment resisting steel frames designed and detailed as per IS:800 : 0.025 b) For special concentrically braced steel frames designed and detailed as per IS:800 : 0.019 c) For special moment resisting RC frames designed and detailed as per IS:456 and IS:13920 : 0.015 d) for RCC chimney, RCC Natural Draft Cooling Tower : 0.05 e) for liquid retaining tanks : 0.03 f) for steel chimney, Absorber tower, Vessels : 0.038 g) for design of structures not covered under 2 (a) to 2 (f) above and under 3 below, in general (excluding special structure/ configuration/materials) : 0.025 3) Multiplying factor to be applied to the site specific horizontal acceleration spectral coefficients (in units of gravity acceleration 'g') for design of equipment and structures where inelastic action is not relevant or not permitted : 0.05 <p>Note: g = Acceleration due to gravity</p> <p>The horizontal seismic acceleration spectral coefficients are furnished in Annexure-A.</p>		
<p style="text-align: center;">LOT-2 PROJECTS FLUE GAS DESULPHURISATION (FGD) SYSTEM PACKAGE</p>	<p style="text-align: center;">TECHNICAL SPECIFICATION SECTION – VI, PART-A BID DOC. NO.:CS-0011-109(2)-9</p>	<p style="text-align: center;">SUB-SECTION-II-A5 PROJECT INFORMATION (BHILAI 2X250 MW)</p>	<p style="text-align: center;">PAGE 4 OF 30</p>

CLAUSE NO.

PROJECT INFORMATION





Annexure-A

HORIZONTAL SEISMIC ACCELERATION SPECTRAL COEFFICIENTS
(In units of 'g')

Time Period (Sec)	Damping Factor (as a percentage of critical damping)		
	2%	3%	5%
0.000	1.000	1.000	1.000
0.030	1.000	1.000	1.000
0.050	1.810	1.679	1.509
0.098	3.935	3.325	2.596
0.101	3.935	3.438	2.660
0.107	3.935	3.438	2.789
0.150	3.935	3.438	2.789
0.200	3.935	3.438	2.789
0.250	3.935	3.438	2.789
0.300	3.935	3.438	2.789
0.350	3.935	3.438	2.789
0.400	3.935	3.438	2.789
0.450	3.935	3.438	2.789
0.485	3.935	3.438	2.789
0.503	3.791	3.438	2.789
0.531	3.591	3.254	2.789
0.600	3.178	2.880	2.467
0.650	2.934	2.658	2.277
0.670	2.846	2.579	2.209
0.700	2.724	2.469	2.114
0.750	2.543	2.304	1.973
0.800	2.384	2.160	1.850
0.850	2.244	2.033	1.741
0.900	2.119	1.920	1.644
0.950	2.007	1.819	1.558
1.000	1.907	1.728	1.480
1.050	1.816	1.646	1.410
1.100	1.734	1.571	1.345
1.150	1.658	1.503	1.287
1.200	1.589	1.440	1.233
1.250	1.526	1.382	1.184
1.300	1.467	1.329	1.138
1.350	1.413	1.280	1.096
1.400	1.362	1.234	1.057

CLAUSE NO.	PROJECT INFORMATION																																																																																																																																																		
	Annexure-A																																																																																																																																																		
	<u>HORIZONTAL SEISMIC ACCELERATION SPECTRAL COEFFICIENTS</u> <u>(In units of 'g')</u>																																																																																																																																																		
	<table border="1" style="width: 100%; border-collapse: collapse;"> <thead> <tr> <th data-bbox="412 449 597 512" rowspan="2">Time Period (Sec)</th> <th colspan="3" data-bbox="604 449 1403 512">Damping Factor (as a percentage of critical damping)</th> </tr> <tr> <th data-bbox="604 520 818 554">2%</th> <th data-bbox="824 520 1104 554">3%</th> <th data-bbox="1110 520 1403 554">5%</th> </tr> </thead> <tbody> <tr><td>1.450</td><td>1.315</td><td>1.192</td><td>1.021</td></tr> <tr><td>1.500</td><td>1.271</td><td>1.152</td><td>0.987</td></tr> <tr><td>1.550</td><td>1.230</td><td>1.115</td><td>0.955</td></tr> <tr><td>1.600</td><td>1.192</td><td>1.080</td><td>0.925</td></tr> <tr><td>1.650</td><td>1.156</td><td>1.047</td><td>0.897</td></tr> <tr><td>1.700</td><td>1.122</td><td>1.016</td><td>0.871</td></tr> <tr><td>1.750</td><td>1.090</td><td>0.987</td><td>0.846</td></tr> <tr><td>1.800</td><td>1.059</td><td>0.960</td><td>0.822</td></tr> <tr><td>1.850</td><td>1.031</td><td>0.934</td><td>0.800</td></tr> <tr><td>1.900</td><td>1.004</td><td>0.909</td><td>0.779</td></tr> <tr><td>1.950</td><td>0.978</td><td>0.886</td><td>0.759</td></tr> <tr><td>2.000</td><td>0.954</td><td>0.864</td><td>0.740</td></tr> <tr><td>2.050</td><td>0.930</td><td>0.843</td><td>0.722</td></tr> <tr><td>2.100</td><td>0.908</td><td>0.823</td><td>0.705</td></tr> <tr><td>2.150</td><td>0.887</td><td>0.804</td><td>0.688</td></tr> <tr><td>2.200</td><td>0.867</td><td>0.785</td><td>0.673</td></tr> <tr><td>2.250</td><td>0.848</td><td>0.768</td><td>0.658</td></tr> <tr><td>2.300</td><td>0.829</td><td>0.751</td><td>0.643</td></tr> <tr><td>2.350</td><td>0.811</td><td>0.735</td><td>0.630</td></tr> <tr><td>2.400</td><td>0.795</td><td>0.720</td><td>0.617</td></tr> <tr><td>2.450</td><td>0.778</td><td>0.705</td><td>0.604</td></tr> <tr><td>2.500</td><td>0.763</td><td>0.691</td><td>0.592</td></tr> <tr><td>2.550</td><td>0.748</td><td>0.678</td><td>0.580</td></tr> <tr><td>2.600</td><td>0.733</td><td>0.665</td><td>0.569</td></tr> <tr><td>2.650</td><td>0.720</td><td>0.652</td><td>0.558</td></tr> <tr><td>2.700</td><td>0.706</td><td>0.640</td><td>0.548</td></tr> <tr><td>2.750</td><td>0.693</td><td>0.628</td><td>0.538</td></tr> <tr><td>2.800</td><td>0.681</td><td>0.617</td><td>0.529</td></tr> <tr><td>2.850</td><td>0.669</td><td>0.606</td><td>0.519</td></tr> <tr><td>2.900</td><td>0.658</td><td>0.596</td><td>0.510</td></tr> <tr><td>2.950</td><td>0.646</td><td>0.586</td><td>0.502</td></tr> <tr><td>3.000</td><td>0.636</td><td>0.576</td><td>0.493</td></tr> <tr><td>3.050</td><td>0.625</td><td>0.567</td><td>0.485</td></tr> <tr><td>3.100</td><td>0.615</td><td>0.557</td><td>0.477</td></tr> </tbody> </table>			Time Period (Sec)	Damping Factor (as a percentage of critical damping)			2%	3%	5%	1.450	1.315	1.192	1.021	1.500	1.271	1.152	0.987	1.550	1.230	1.115	0.955	1.600	1.192	1.080	0.925	1.650	1.156	1.047	0.897	1.700	1.122	1.016	0.871	1.750	1.090	0.987	0.846	1.800	1.059	0.960	0.822	1.850	1.031	0.934	0.800	1.900	1.004	0.909	0.779	1.950	0.978	0.886	0.759	2.000	0.954	0.864	0.740	2.050	0.930	0.843	0.722	2.100	0.908	0.823	0.705	2.150	0.887	0.804	0.688	2.200	0.867	0.785	0.673	2.250	0.848	0.768	0.658	2.300	0.829	0.751	0.643	2.350	0.811	0.735	0.630	2.400	0.795	0.720	0.617	2.450	0.778	0.705	0.604	2.500	0.763	0.691	0.592	2.550	0.748	0.678	0.580	2.600	0.733	0.665	0.569	2.650	0.720	0.652	0.558	2.700	0.706	0.640	0.548	2.750	0.693	0.628	0.538	2.800	0.681	0.617	0.529	2.850	0.669	0.606	0.519	2.900	0.658	0.596	0.510	2.950	0.646	0.586	0.502	3.000	0.636	0.576	0.493	3.050	0.625	0.567	0.485	3.100	0.615	0.557	0.477	
Time Period (Sec)	Damping Factor (as a percentage of critical damping)																																																																																																																																																		
	2%	3%	5%																																																																																																																																																
1.450	1.315	1.192	1.021																																																																																																																																																
1.500	1.271	1.152	0.987																																																																																																																																																
1.550	1.230	1.115	0.955																																																																																																																																																
1.600	1.192	1.080	0.925																																																																																																																																																
1.650	1.156	1.047	0.897																																																																																																																																																
1.700	1.122	1.016	0.871																																																																																																																																																
1.750	1.090	0.987	0.846																																																																																																																																																
1.800	1.059	0.960	0.822																																																																																																																																																
1.850	1.031	0.934	0.800																																																																																																																																																
1.900	1.004	0.909	0.779																																																																																																																																																
1.950	0.978	0.886	0.759																																																																																																																																																
2.000	0.954	0.864	0.740																																																																																																																																																
2.050	0.930	0.843	0.722																																																																																																																																																
2.100	0.908	0.823	0.705																																																																																																																																																
2.150	0.887	0.804	0.688																																																																																																																																																
2.200	0.867	0.785	0.673																																																																																																																																																
2.250	0.848	0.768	0.658																																																																																																																																																
2.300	0.829	0.751	0.643																																																																																																																																																
2.350	0.811	0.735	0.630																																																																																																																																																
2.400	0.795	0.720	0.617																																																																																																																																																
2.450	0.778	0.705	0.604																																																																																																																																																
2.500	0.763	0.691	0.592																																																																																																																																																
2.550	0.748	0.678	0.580																																																																																																																																																
2.600	0.733	0.665	0.569																																																																																																																																																
2.650	0.720	0.652	0.558																																																																																																																																																
2.700	0.706	0.640	0.548																																																																																																																																																
2.750	0.693	0.628	0.538																																																																																																																																																
2.800	0.681	0.617	0.529																																																																																																																																																
2.850	0.669	0.606	0.519																																																																																																																																																
2.900	0.658	0.596	0.510																																																																																																																																																
2.950	0.646	0.586	0.502																																																																																																																																																
3.000	0.636	0.576	0.493																																																																																																																																																
3.050	0.625	0.567	0.485																																																																																																																																																
3.100	0.615	0.557	0.477																																																																																																																																																
LOT-2 PROJECTS FLUE GAS DESULPHURISATION (FGD) SYSTEM PACKAGE	TECHNICAL SPECIFICATION SECTION – VI, PART-A BID DOC. NO.:CS-0011-109(2)-9	SUB-SECTION-II-A5 PROJECT INFORMATION (BHILAI 2X250 MW)	PAGE 6 OF 30																																																																																																																																																

CLAUSE NO.	PROJECT INFORMATION																																																																																						
	<p style="text-align: right;">Annexure-A</p> <p style="text-align: center;"><u>HORIZONTAL SEISMIC ACCELERATION SPECTRAL COEFFICIENTS</u> <u>(In units of 'g')</u></p> <table border="1" data-bbox="412 449 1403 1241"> <thead> <tr> <th data-bbox="412 449 602 552" rowspan="2">Time Period (Sec)</th> <th colspan="3" data-bbox="607 449 1403 506">Damping Factor (as a percentage of critical damping)</th> </tr> <tr> <th data-bbox="607 512 818 552">2%</th> <th data-bbox="823 512 1101 552">3%</th> <th data-bbox="1105 512 1403 552">5%</th> </tr> </thead> <tbody> <tr><td>3.150</td><td>0.605</td><td>0.549</td><td>0.470</td></tr> <tr><td>3.200</td><td>0.596</td><td>0.540</td><td>0.463</td></tr> <tr><td>3.250</td><td>0.587</td><td>0.532</td><td>0.455</td></tr> <tr><td>3.300</td><td>0.578</td><td>0.524</td><td>0.448</td></tr> <tr><td>3.350</td><td>0.569</td><td>0.516</td><td>0.442</td></tr> <tr><td>3.400</td><td>0.561</td><td>0.508</td><td>0.435</td></tr> <tr><td>3.450</td><td>0.553</td><td>0.501</td><td>0.429</td></tr> <tr><td>3.500</td><td>0.545</td><td>0.494</td><td>0.423</td></tr> <tr><td>3.550</td><td>0.537</td><td>0.487</td><td>0.417</td></tr> <tr><td>3.600</td><td>0.530</td><td>0.480</td><td>0.411</td></tr> <tr><td>3.650</td><td>0.522</td><td>0.473</td><td>0.405</td></tr> <tr><td>3.700</td><td>0.515</td><td>0.467</td><td>0.400</td></tr> <tr><td>3.750</td><td>0.509</td><td>0.461</td><td>0.395</td></tr> <tr><td>3.800</td><td>0.502</td><td>0.455</td><td>0.389</td></tr> <tr><td>3.825</td><td>0.496</td><td>0.452</td><td>0.387</td></tr> <tr><td>3.850</td><td>0.490</td><td>0.449</td><td>0.384</td></tr> <tr><td>3.900</td><td>0.477</td><td>0.443</td><td>0.379</td></tr> <tr><td>3.950</td><td>0.465</td><td>0.437</td><td>0.375</td></tr> <tr><td>4.000</td><td>0.454</td><td>0.432</td><td>0.370</td></tr> </tbody> </table>			Time Period (Sec)	Damping Factor (as a percentage of critical damping)			2%	3%	5%	3.150	0.605	0.549	0.470	3.200	0.596	0.540	0.463	3.250	0.587	0.532	0.455	3.300	0.578	0.524	0.448	3.350	0.569	0.516	0.442	3.400	0.561	0.508	0.435	3.450	0.553	0.501	0.429	3.500	0.545	0.494	0.423	3.550	0.537	0.487	0.417	3.600	0.530	0.480	0.411	3.650	0.522	0.473	0.405	3.700	0.515	0.467	0.400	3.750	0.509	0.461	0.395	3.800	0.502	0.455	0.389	3.825	0.496	0.452	0.387	3.850	0.490	0.449	0.384	3.900	0.477	0.443	0.379	3.950	0.465	0.437	0.375	4.000	0.454	0.432	0.370	
Time Period (Sec)	Damping Factor (as a percentage of critical damping)																																																																																						
	2%	3%	5%																																																																																				
3.150	0.605	0.549	0.470																																																																																				
3.200	0.596	0.540	0.463																																																																																				
3.250	0.587	0.532	0.455																																																																																				
3.300	0.578	0.524	0.448																																																																																				
3.350	0.569	0.516	0.442																																																																																				
3.400	0.561	0.508	0.435																																																																																				
3.450	0.553	0.501	0.429																																																																																				
3.500	0.545	0.494	0.423																																																																																				
3.550	0.537	0.487	0.417																																																																																				
3.600	0.530	0.480	0.411																																																																																				
3.650	0.522	0.473	0.405																																																																																				
3.700	0.515	0.467	0.400																																																																																				
3.750	0.509	0.461	0.395																																																																																				
3.800	0.502	0.455	0.389																																																																																				
3.825	0.496	0.452	0.387																																																																																				
3.850	0.490	0.449	0.384																																																																																				
3.900	0.477	0.443	0.379																																																																																				
3.950	0.465	0.437	0.375																																																																																				
4.000	0.454	0.432	0.370																																																																																				
<p style="text-align: center;">LOT-2 PROJECTS FLUE GAS DESULPHURISATION (FGD) SYSTEM PACKAGE</p>	<p style="text-align: center;">TECHNICAL SPECIFICATION SECTION – VI, PART-A BID DOC. NO.:CS-0011-109(2)-9</p>	<p style="text-align: center;">SUB-SECTION-II-A5 PROJECT INFORMATION (BHILAI 2X250 MW)</p>	<p style="text-align: center;">PAGE 7 OF 30</p>																																																																																				

CLAUSE NO.	PROJECT INFORMATION 								
6.00.00	<p>CRITERIA FOR WIND RESISTANT DESIGN OF STRUCTURES AND EQUIPMENT</p> <p>All structures shall be designed for wind forces in accordance with IS:875 (Part-3) and as specified in this document. See Annexure – B for site specific information.</p> <p>Along wind forces shall generally be computed by the Peak (i.e. 3 second gust) Wind Speed method as defined in the standard.</p> <p>Along wind forces on slender and wind sensitive structures and structural elements shall also be computed, for dynamic effects, using the Gust Factor or Gust Effectiveness Factor Method as defined in the standard. The structures shall be designed for the higher of the forces obtained from Gust Factor method and the Peak Wind Speed method.</p> <p>Analysis for dynamic effects of wind must be undertaken for any structure which has a height to minimum lateral dimension ratio greater than “5” and/or if the fundamental frequency of the structure is less than 1 Hz.</p> <p>Susceptibility of structures to across-wind forces, galloping, flutter, ovaling etc. should be examined and designed/detailed accordingly following the recommendations of IS:875(Part-3) and other relevant Indian standards.</p> <p>It should be estimated if size and relative position of other structures are likely to enhance the wind loading on the structure under consideration. Enhancement factor, if necessary, shall suitably be estimated and applied to the wind loading to account for the interference effects.</p> <p>Damping in Structures</p> <p>The damping factor (as a percentage of critical damping) to be adopted shall not be more than as indicated below for:</p> <table border="0" data-bbox="402 1381 1166 1556"> <tr> <td>a) Welded steel structures</td> <td>: 1.0%</td> </tr> <tr> <td>b) Bolted steel structures</td> <td>: 2.0%</td> </tr> <tr> <td>c) Reinforced concrete structures</td> <td>: 1.6%</td> </tr> </table> <p>: As per IS:6533 & CICIND Model Code whichever is more critical.</p>			a) Welded steel structures	: 1.0%	b) Bolted steel structures	: 2.0%	c) Reinforced concrete structures	: 1.6%
a) Welded steel structures	: 1.0%								
b) Bolted steel structures	: 2.0%								
c) Reinforced concrete structures	: 1.6%								
<p align="center">LOT-2 PROJECTS FLUE GAS DESULPHURISATION (FGD) SYSTEM PACKAGE</p>	<p align="center">TECHNICAL SPECIFICATION SECTION – VI, PART-A BID DOC. NO.:CS-0011-109(2)-9</p>	<p align="center">SUB-SECTION-II-A5 PROJECT INFORMATION (BHILAI 2X250 MW)</p>	<p align="center">PAGE 8 OF 30</p>						

CLAUSE NO.	PROJECT INFORMATION		
	<div style="text-align: right;"></div> <p style="text-align: right;">ANNEXURE-B</p> <p>SITE SPECIFIC DESIGN PARAMETERS</p> <p>The various design parameters, as defined in IS: 875 (Part-3), to be adopted for the project site shall be as follows:</p> <p>a) The basic wind speed “V_b” at ten metres above the mean ground level : 44 metres/second</p> <p>b) The risk coefficient “K_1” : 1.06</p> <p>c) Category of terrain : Category-2</p> <p>FOUNDATION SYSTEM AND GEOTECHNICAL DATA</p> <p>7.00.00</p> <p>7.00.01 Geotechnical data and foundation system for the respective project are enclosed at Annexure-III. The corresponding bore logs are enclosed at Annexure-IV.</p> <p>7.00.02 The available soil data is of vicinity of proposed structures, therefore, bidder shall carryout his own detailed soil investigation for facilities under this package and shall be as per the scheme approved by owner. The scheme for geotechnical investigation shall be as given at Clause 7.07.00 and shall be approved by owner before execution. Geotechnical investigation work shall got executed by the Contractor through the agencies as mentioned in Clause No. 7.07.03. However, no time extension shall be given on account of soil investigation carried out by the Bidder. The geotechnical investigation report shall be prepared with detailed recommendations regarding type of foundation and allowable bearing pressure for various structures/ facilities and other soil parameters. The report shall be submitted for Owner’s approval prior to commencement of design of foundation.</p> <p>7.00.03 The Bidder should note that nothing extra whatsoever on account of variation between soil data collected by Owner and that found by the Bidder during geotechnical investigation by him or during execution of works, shall be payable.</p> <p>7.00.04 Tank Foundations</p> <p>a) The tanks shall rest on flexible tank pad foundation, resting on sand with concrete ring wall to retain sand. Base of the concrete ring wall shall not rest on the expansive soil, if any.</p> <p>b) Entire loose/ soft soil inside the concrete ring wall shall be removed and shall be filled with sand. Sand for filling shall be clean and well graded conforming to IS 383 with grading Zone I to III.</p> <p>c) Sand shall be spread in layers not exceeding 30cm compacted thickness over the area. Each layer shall be uniformly compacted by mechanical means like plate vibrators, small vibratory rollers, etc to achieve a relative density of not less than 80%.</p> <p>d) Other requirements of tank foundations shall be as per IS 803 and as specified elsewhere in the specifications.</p>		
<p style="text-align: center;">LOT-2 PROJECTS FLUE GAS DESULPHURISATION (FGD) SYSTEM PACKAGE</p>	<p style="text-align: center;">TECHNICAL SPECIFICATION SECTION – VI, PART-A BID DOC. NO.:CS-0011-109(2)-9</p>	<p style="text-align: center;">SUB-SECTION-II-A5 PROJECT INFORMATION (BHILAI 2X250 MW)</p>	<p style="text-align: center;">PAGE 9 OF 30</p>

CLAUSE NO.	PROJECT INFORMATION 		
7.02.00	<p>Foundation System</p> <p>The requirements for the foundation system to be adopted are as given in subsequent clauses. Depending upon the depth of competent strata/stratum, type of structures, functional requirement of facility, extent of cutting / filling, suitable foundation, open or pile shall be adopted with approval of owner.</p>		
7.02.01	<p>General Requirements</p> <ul style="list-style-type: none"> a) All structures/equipment shall be supported either on suitable open foundations (isolated, combined, raft) or pile foundations depending on type of structures/facilities, sub-strata, topography etc. b) The roads, ground floor slabs, trenches, pipe pedestals, channels/drains and staircase foundation with foundation loading intensity less than 4 T / M2 may be supported on open / shallow foundations resting on virgin / controlled compacted filled up soil. c) No other foundation (other than as mentioned in (b) above) shall rest on the filled up ground / soil. d) No foundation shall rest on the black cotton soil. e) Before execution of work the bidder shall ensure that there is no obstruction to underground/overground facilities like sewer lines, pipe lines etc. Any such damage and remedial/ rectification measures shall be at the contractors cost. f) Bidder shall also ensure that there is no damage to existing nearby foundations and the foundations pertaining to this package are not placed at shallower depth than the nearby foundations. If required depth of foundation is deeper than the existing foundations, proper protection shall be provided to existing foundations. g) All foundations shall be designed in accordance with relevant parts of the latest revisions of Indian Standards. h) The water table for design purpose shall be considered at Finished Ground Level. i) A combination of open and pile foundations shall not be permitted under the same equipment / structure / building. j) Foundation for equipments on ground floor <p>For equipments of static weight upto 1.5 T, the equipment may be supported on the ground floor slab by locally thickening the slab. Thickening of the ground floor slab shall be done upto an extent of about 0.6 m beyond the plan area of the equipment on all the sides. Further, the load intensity below the equipment shall be limited to 4T/m2. Other requirements of floor slab and compaction below the floor slab shall be adhered, as specified elsewhere in the specifications.</p> <p>For equipment's of static weight between 1.5 T and 20 T, the equipment may be supported on compacted sand filling with the load intensity below the equipment limited to 4T/m2. The minimum depth of foundation is 1.0m below FFL. Other requirements of sand compaction below the foundation shall be adhered, as specified elsewhere in the specifications.</p>		
LOT-2 PROJECTS FLUE GAS DESULPHURISATION (FGD) SYSTEM PACKAGE	TECHNICAL SPECIFICATION SECTION – VI, PART-A BID DOC. NO.:CS-0011-109(2)-9	SUB-SECTION-II-A5 PROJECT INFORMATION (BHILAI 2X250 MW)	PAGE 10 OF 30

CLAUSE NO.	PROJECT INFORMATION 		
7.02.02	<p>For equipment of static weight more than 20 T, the equipment foundation shall be taken to the founding level or shall be built up with PCC from the level as mentioned in the Table 2. The pedestal of equipment foundation or the foundation Block shall be isolated from the adjoining floor slab by providing bitumen impregnated fiber board of minimum 50 mm thick, conforming to IS: 1838 all around the equipment pedestal for the full depth of the floor slab.</p> <p>Open Foundations</p> <p>In case open foundations are adopted, following shall be adhered to.</p> <ol style="list-style-type: none"> The minimum width of foundation shall be 1.0 m. Minimum depth of foundation shall be 1.0m below Ground Level. It shall be ensured that all foundations of a particular structure/ buildings/ facility shall rest on one bearing stratum. Wherever the intended bearing sub-strata is virgin soil stratum but the actual stratum encountered during foundation excavation consists of filled up soil at founding level, under such cases either the foundation shall be lowered completely into the virgin stratum or the filled up soil upto the virgin layers shall be removed and built up through PCC (1:4:8) up to designed foundation level. 		
7.02.03	<p>Pile Foundations –</p> <p>(a.) In case piles are adopted, following shall be adhered to :</p> <ol style="list-style-type: none"> The pile foundation shall be of RCC, Cast-in-situ bored piles as per IS:2911. Pile boring shall be done using Rotary Hydraulic Rigs. However, conventional tripod rig may be allowed in inaccessible areas subject to site specific conditions. Two stage flushing of pile bore shall be ensured by airlift technique duly approved by the Employer. If required, temporary or permanent MS liner may be provided for piling. The minimum diameter of pile shall be 600 mm. The allowable load capacity of the pile in different modes (vertical compression, lateral and pullout) shall be as per approved geotechnical report & as enclosed in relevant annexure: Only straight shaft piles shall be used. Minimum cast length of pile above cutoff level shall be 1.0 m. The contractor shall furnish design of piles (in terms of rated capacity, length, diameter, termination criteria to locate the founding level for construction of pile in terms of measurable parameter, reinforcement for job as well as test piles, pile load test arrangement, locations of initial test piles etc.) for Engineer's approval. The piling work shall be carried out in accordance with IS:2911 (Relevant part) and accepted construction methodology. The construction methodology shall be submitted by the Contractor for Engineer's approval. Number of initial load tests to be performed for each diameter and rated capacity of pile shall be subject to minimum as under. 		
LOT-2 PROJECTS FLUE GAS DESULPHURISATION (FGD) SYSTEM PACKAGE	TECHNICAL SPECIFICATION SECTION – VI, PART-A BID DOC. NO.:CS-0011-109(2)-9	SUB-SECTION-II-A5 PROJECT INFORMATION (BHILAI 2X250 MW)	PAGE 11 OF 30

CLAUSE NO.	PROJECT INFORMATION 		
	<p>Vertical</p> <p>Lateral Minimum of 2 Nos. in each mode.</p> <p>Uplift</p> <p>vii) The initial pile load test shall be conducted with test load upto three times the pile capacity. In case of vertical compression test (initial test) the method of loading shall be cyclic as per IS:2911 (relevant part).</p> <p>viii) Load test shall be conducted at pile Cut-off Level (COL). If the water table is above the COL the test pit shall be kept dry throughout the test period by suitable de-watering methods. Alternatively the vertical load test may be conducted at a level higher than COL. In such a case, an annular space shall be created to remove the effect of skin friction above COL by providing an outer casing of suitable diameter larger than the pile diameter.</p> <p>ix) Number of routine pile load tests to be performed for each diameter/allowable capacity of pile shall be as under :</p> <p>i) Vertical : 0.5% of the total number of piles provided.</p> <p>ii) Lateral : 0.5% of the total number of piles provided.</p> <p>x) The routine tests on piles shall be conducted upto test load of one and half times the allowable pile capacity. Piles for routine load tests shall be approved by the Employer.</p> <p>xi) In case, routine pile load test shows that the pile has not achieved the desired capacity or pile(s) have been rejected due to any other reason, then the Contractor shall install additional pile(s) as required and the pile cap design shall accordingly be reviewed and modified, if required.</p> <p>xii) Testing of piles and interpretation of pile load test results shall be carried out as per IS:2911 (Part-4). Contractor shall ensure that all the measuring equipment and instruments are properly calibrated at a reputed laboratory / institute prior to their use. Settlement / movement of the pile top shall be made by Linear Variable Differential Transducers (LVDT) having a least count of 0.01mm.</p> <p>xiii) The test load on initial test piles shall be applied by means of reaction from anchor piles / rock anchors alone or combination of anchor piles / rock anchors and kentledge with concrete blocks.</p>		
<p align="center">LOT-2 PROJECTS FLUE GAS DESULPHURISATION (FGD) SYSTEM PACKAGE</p>	<p align="center">TECHNICAL SPECIFICATION SECTION – VI, PART-A BID DOC. NO.:CS-0011-109(2)-9</p>	<p align="center">SUB-SECTION-II-A5 PROJECT INFORMATION (BHILAI 2X250 MW)</p>	<p align="center">PAGE 12 OF 30</p>

CLAUSE NO.	PROJECT INFORMATION 		
<p>7.03.00</p> <p>7.03.01</p>	<p>xiv) Low Strain Pile Integrity test shall be conducted on all test piles and job piles. This test shall be used to identify the routine load test and not intended to replace the use of static load test. This test is limited to assess the imperfection of the pile shaft and shall be undertaken by an independent specialist agency to be approved by Engineering department of Owner. The test equipment shall be of TNO or PDI make or equivalent. The process shall conform to ASTM.</p> <p>xv) High Strain Dynamic Load Test may be carried out for routine load testing of working piles. However, at least two numbers of static routine vertical load tests shall be carried out on pile on which high strain dynamic load test has already been carried out for establishing the correlation between the two tests. In case of discrepancy if any between dynamic and static vertical load tests, then additional static routine vertical load tests shall be conducted as decided by the Engineer and the results of static routine vertical load shall prevail. Number of routine vertical pile load tests as per clause 7.02.03 (ix) shall be total of static routine vertical load test and high strain dynamic load tests.</p> <p>The procedure to carry out the test shall be submitted to the Engineer. The test and equipment shall conform to ASTM D4945-00. The test shall be conducted by an experienced independent test agency approved by the owner. Field data shall be submitted to the site engineer and shall include force velocity curves, pile capacity, simulated static load test curve, net and total pile displacement, pile integrity. A (Case pile wave analysis) CAPWAP or equivalent software analysis shall be conducted on the field data for correct capacity estimation and to evaluate end bearing and skin friction components of the pile.</p> <p>xvi) From load considerations, single pile may be used under a column/tower. In that case, pile shall be connected with tie beams at pile cut off level in both directions.</p> <p>xvii) Contribution of frictional resistance of filled up soil if any, shall not be considered for computation of frictional resistance of piles.</p> <p>xviii) Reinforcement for job piles shall be designed as following:</p> <p>(a) Compression + bending piles: For these piles, the allowable safe pile capacities in compression and bending shall be considered.</p> <p>(b) Tension + bending piles: For these piles, the actual pile forces to be considered. However, maximum 3 types of combinations for varying percentage of tension capacity + bending case may be designed & adopted by contractor for the entire scope of work under this package.</p> <p>Special Requirements</p> <p>Details of treatment for foundations / underground structures required to counteract soil / water chemical environment shall be as per detailed geotechnical investigation to be carried out by</p>		
<p>LOT-2 PROJECTS FLUE GAS DESULPHURISATION (FGD) SYSTEM PACKAGE</p>	<p>TECHNICAL SPECIFICATION SECTION – VI, PART-A BID DOC. NO.:CS-0011-109(2)-9</p>	<p>SUB-SECTION-II-A5 PROJECT INFORMATION (BHILAI 2X250 MW)</p>	<p>PAGE 13 OF 30</p>

CLAUSE NO.	PROJECT INFORMATION				
<p>7.04.00</p> <p>7.04.01</p> <p>7.04.02</p> <p>7.04.03</p> <p>7.04.04</p> <p>7.04.05</p> <p>7.04.06</p> <p>7.05.00</p> <p>7.05.01</p> <p>7.05.02</p>	<div data-bbox="1273 121 1414 199" style="text-align: right;">  </div> <p>contractor. Contractor shall carry out chemical analysis during detailed geotechnical investigation and required treatment shall be provided accordingly.</p> <p>Excavation, Filling and Dewatering</p> <p>For excavation works, comprehensive dewatering with well point or deep wells arrangement, if required, shall be adopted. Scheme for dewatering and design with all computations and back up data for dewatering shall be submitted for the owner's information. The water table shall be maintained at 0.5m below the founding depth.</p> <p>Excavation for shallow foundations shall be covered with PCC immediately after reaching the founding level. In case of any local loosening of soil or any loose pockets are encountered at founding level during excavation the same shall be removed and compensated by PCC M7.5. The final layer of about 300 mm thickness above the founding level shall be excavated by suitable means, so as to avoid disturbance to founding stratum.</p> <p>Backfilling around foundations, pipes, trenches, sumps, pits, plinths, etc. shall be carried out with approved material in layers not exceeding 300 mm compacted thickness (higher thickness of layers upto 500mm with heavy mechanical compacting equipment) and each layer shall be compacted to 90% of standard proctor density for cohesive soils and to 80% of relative density for non-cohesive soils</p> <p>Rock pieces having size less than 150 mm and interstices filled with soil may be used for backfilling around foundation, plinths etc. and shall be compacted to minimum of 85% of original stack of material after filling the interstices.</p> <p>Founding level for trenches/channels shall be decided as per functional requirement. The bottom of excavation shall be properly compacted prior to casting of bottom slab of trenches / channels.</p> <p>CBR tests for pavement/road design shall be carried out by the Contractor after earth filling (if applicable) has been completed upto the formation level.</p> <p>The contractor shall take all necessary measures during excavation to prevent the hazards of falling or sliding of material or article from any bank or side of such excavation which is more than one and a half meter above the footing by providing adequate piling, shoring, bracing etc. against such bank or sides.</p> <p>Adequate and suitable warning signs shall be put up at conspicuous places at the excavation work to prevent any persons or vehicles falling into the excavation trench. No worker should be allowed to work where he may be stuck or endangered by excavation machinery or collapse of excavations or trenches.</p> <p>EXCAVATION IN ROCK</p> <p>Excavation in rock shall be carried out by mechanical means and if blasting is required for founding of some of the structures under this package, control blasting only shall be carried out.</p> <p>Controlled blasting shall be done by a specialised agency duly approved by Engineer. All controlled blasting shall be done by using time delay detonators (i.e. excel type).</p> <p>a) Contractor shall engage an agency expert in blasting such as, NIRM (National Institute of Rock Mechanics), CMPDIL, Central Institute of Mining and Fuel Research Dhanbad, Dept. of Mining of Govt. Institutions etc. to design detailed blasting scheme and get the same approved from Engineer before carrying out the blasting operation. All blasting shall be done</p>	<p>LOT-2 PROJECTS FLUE GAS DESULPHURISATION (FGD) SYSTEM PACKAGE</p>	<p>TECHNICAL SPECIFICATION SECTION – VI, PART-A BID DOC. NO.:CS-0011-109(2)-9</p>	<p>SUB-SECTION-II-A5 PROJECT INFORMATION (BHILAI 2X250 MW)</p>	<p>PAGE 14 OF 30</p>

CLAUSE NO.	PROJECT INFORMATION 		
	<p>as per the approved blasting scheme & initial blasting operations shall be done under the supervision & guidance of the representative of the blasting expert.</p> <p>b) All the statutory laws, (Explosives Act etc.) rules, regulations, Indian Standards, etc. pertaining to the acquisition, transport, storage, handling and use of explosives, etc. shall be strictly followed.</p> <p>c) The Contractor shall obtain Licenses from Competent Authorities for undertaking blasting work as well as for procuring, transporting to site and storing the explosives as per explosives act. The Contractor shall be responsible for the safe transport, use, custody and proper accounting of the explosive Materials.</p> <p>d) The Contractor shall be responsible and liable for any accident and injury / damage which may occur to any person or property of the project or public on account of any operations connected with the storage, transportation, handling or use of explosive and blasting operations.</p> <p>7.06.00 Sheeting & Shoring</p> <p>The contractor shall ascertain for himself the nature of materials to be excavated and difficulties, if any, likely to be encountered in excavation while executing the work. Sheet piling, sheeting and shoring, bracing and maintaining suitable slopes, drainage, etc. shall be provided and installed by the Contractor, to the satisfaction of the Engineer.</p> <p>7.07.00 Geotechnical Investigation</p> <p>The Contractor shall carry out detailed geotechnical investigation in the areas under his scope for establishing the sub-surface conditions and to decide type of foundations for the structures envisaged, construction methods, any special requirements/treatment called for remedial measures for sub-soil/ foundations etc. in view of soft sub-soils, aggressive sub-soils and water, expansive/swelling soils etc. prior to commencement of detailed design/drawings. The Contractor shall obtain the approval for the field testing scheme proposed by him from the Owner before undertaking the geotechnical investigation work.</p> <p>7.07.01.00 Scheme of geotechnical Investigation</p> <p>7.07.02.01 Field test shall include but not be limited to the following: Boreholes, Standard Penetration Test (SPT), Dynamic Cone Penetration Test (DCPT), collection of disturbed samples (DS) and undisturbed soil samples (UDS), Trial Pits (TP), Plate Load Tests (PLT), Electrical Resistivity Test (ERT), In situ field permeability tests, collection of water samples, etc.</p> <p>7.07.02.02 The diameter of borehole shall be minimum 150 mm in soil and 76 mm in rock. The diameter of UDS sampler shall be 100 mm minimum. Core drilling in rock shall be done by using hydraulically feed rotary drill & double tube core barrel with diamond bit.</p> <p>7.07.02.03 The minimum tests are indicated in Clause No. 7.08.00. Adequate number of tests shall be conducted up to sufficient depth for complete determination of subsoil conditions. The depth of boreholes shall be as specified in Appendix A. SPT shall be carried out in all types of soil deposits and in all rock formations with core recovery up to 20%, met within a borehole. This test shall be conducted at every 3.0 m interval or at change of strata, up to the final depth. SPT 'N' of 100 and above shall be referred as refusal. UDS shall be collected at every 3.0 m interval or at change of strata up to depth of borehole. UDS may be replaced by additional SPT, if SPT'N' value in the strata is above 50.</p>		
<p align="center">LOT-2 PROJECTS FLUE GAS DESULPHURISATION (FGD) SYSTEM PACKAGE</p>	<p align="center">TECHNICAL SPECIFICATION SECTION – VI, PART-A BID DOC. NO.:CS-0011-109(2)-9</p>	<p align="center">SUB-SECTION-II-A5 PROJECT INFORMATION (BHILAI 2X250 MW)</p>	<p align="center">PAGE 15 OF 30</p>

CLAUSE NO.	PROJECT INFORMATION													
7.07.02.04	<p>Laboratory tests shall be done as per relevant IS codes. The laboratory tests, not be limited to the following shall be conducted on disturbed and undisturbed soil samples, rock samples & water samples collected during field investigations in sufficient numbers.</p> <p>Laboratory Tests on Soil Samples</p> <p>Laboratory tests shall be carried out on disturbed and undisturbed soil samples for Grain Size Analysis, Hydrometer Analysis, Atterberg Limits, Triaxial Shear Tests (UU), Natural Moisture Content, Specific Gravity and Bulk Unit Weight, Consolidation Tests, Unconfined Compression Test, Free swell Index, Shrinkage Limit, Swell Pressure Test, Chemical Analysis test on soil and water samples to determine the carbonates, sulphates, chlorides, nitrates, pH, organic matter and any other chemicals harmful to concrete and reinforcement/ steel.</p> <p>Laboratory Tests on Rock Samples</p> <p>Moisture content, porosity & density, Specific Gravity, Hardness, Soundness, Slake durability index, Unconfined compression test (Both at saturated and in-situ water content), Point load strength index and deformability test (Both at saturated and in-situ water content) shall be carried out on rock samples.</p>													
7.07.02.05	<p>Geotechnical investigation (field & laboratory) shall be carried out in accordance with the provisions of relevant Indian Standards.</p> <p>On completion of all field & laboratory work, geotechnical investigation report shall be submitted for Owner's review/approval. The Geotechnical investigation report shall contain geological information of the region, procedure adopted for investigation, field & laboratory observations/ data/ records, analysis of results & recommendations on type of foundation for different type of structures envisaged for all areas of work with supporting calculations. Recommendations on treatment for soil, foundation, based on subsoil characteristics, soft soils, aggressive chemicals, expansive soils, etc.</p> <p>Recommendations on foundation system and the net allowable bearing pressures and pile capacity shall be based on the conservative values of geotechnical investigation data.</p>													
7.07.03.00	<p>Geotechnical investigation work shall be got executed by the Contractor through the following agencies.</p> <ol style="list-style-type: none"> 1. C.E.TESTING COMPANY Pvt. Ltd, Kolkata 2. Cengrs Geotechnica Pvt. Ltd, New Delhi 3. KCT Consultancy Services, Ahemdabad 4. M.K. Soil Testing Laboratory, Ahemdabad 													
7.08.00	<p>Geotechnical Investigation Scheme</p> <p>a) Boreholes (Minimum)</p> <table border="1" data-bbox="418 1539 1419 1780"> <thead> <tr> <th>S.No</th> <th>Structure</th> <th>Spacing/Number of borehole</th> <th>Depth of borehole</th> <th>Remarks</th> </tr> </thead> <tbody> <tr> <td>1</td> <td>FGD</td> <td>Minimum 14 Nos.</td> <td>Depth of boreholes shall be 25m to 35m.</td> <td>Depth of boreholes</td> </tr> </tbody> </table>			S.No	Structure	Spacing/Number of borehole	Depth of borehole	Remarks	1	FGD	Minimum 14 Nos.	Depth of boreholes shall be 25m to 35m.	Depth of boreholes	
S.No	Structure	Spacing/Number of borehole	Depth of borehole	Remarks										
1	FGD	Minimum 14 Nos.	Depth of boreholes shall be 25m to 35m.	Depth of boreholes										
<p>LOT-2 PROJECTS FLUE GAS DESULPHURISATION (FGD) SYSTEM PACKAGE</p>		<p>TECHNICAL SPECIFICATION SECTION – VI, PART-A BID DOC. NO.:CS-0011-109(2)-9</p>	<p>SUB-SECTION-II-A5 PROJECT INFORMATION (BHILAI 2X250 MW)</p>	<p>PAGE 16 OF 30</p>										

CLAUSE NO.	PROJECT INFORMATION				
	2	Crusher House	Minimum 2 Nos.	Depth of boreholes shall be 25m to 35m.	shall be as mentioned in column "Depth of Borehole" or 5m continuous in rock with RQD > 25% whichever is earlier.
	3	Gypsum and Lime storage area	Minimum 10 Nos.	Depth of boreholes shall be 15m to 25m	
	4	Other Structure/Facility	Minimum 2 Nos. boreholes under each area / facility	15 to 20 m	
	5	Chimney	Minimum 2 Nos.	30 to 35m	
	b) <u>Other Field Tests (Minimum)</u>				
	1	Cyclic Plate Load Test (CPLT)	3 nos	Test Depth from 2 to 4 m	
	2	TRIAL PIT (TP)	5 Nos.	Depth - 3 m	
	3	IN SITU PERMEABILITY TEST IN BOREHOLES	In minimum 3 Nos. of boreholes	Tests shall be conducted at depths of 1.0m, 3.0m, 5.0m, 8.0m and 12.0m.	
	4	ERT	Minimum 10 Nos.		
	<ul style="list-style-type: none"> • Depth and location of Boreholes and other field tests (PLT, ERT, field permeability tests etc.) shall be approved by Owner before execution of geotechnical investigation work. • Investigation in any other building / structure / facilities / trestles which are not mentioned above shall also be carried out, if required, by the bidder for the facilities under his scope. 				
<p align="center">LOT-2 PROJECTS FLUE GAS DESULPHURISATION (FGD) SYSTEM PACKAGE</p>	<p align="center">TECHNICAL SPECIFICATION SECTION – VI, PART-A BID DOC. NO.:CS-0011-109(2)-9</p>		<p align="center">SUB-SECTION-II-A5 PROJECT INFORMATION (BHILAI 2X250 MW)</p>	<p align="center">PAGE 17 OF 30</p>	

<p>CLAUSE NO.</p>	<p style="text-align: center;">PROJECT INFORMATION</p> <div style="text-align: right;">  </div> <p style="text-align: center;">ANNEXURE-I</p> <div style="text-align: center;"> </div>		
<p style="text-align: center;">LOT-2 PROJECTS FLUE GAS DESULPHURISATION (FGD) SYSTEM PACKAGE</p>	<p style="text-align: center;">TECHNICAL SPECIFICATION SECTION – VI, PART-A BID DOC. NO.:CS-0011-109(2)-9</p>	<p style="text-align: center;">SUB-SECTION-II-A5 PROJECT INFORMATION (BHILAI 2X250 MW)</p>	<p style="text-align: center;">PAGE 18 OF 30</p>

THIS IS PART OF TECHNICAL SPECIFICATION PE-TS-468-571-A901 REV 00.

CLAUSE NO.

PROJECT INFORMATION



ANNEXURE-II

STATION : Raipur
 LAT 21°14' N LONG 81°38' E
 298 METRES
 1951 से 1980 तक के वर्षों के आधार पर आधारित
 BASED ON OBSERVATIONS FROM

MONTH	DRY BULB		WET BULB		DAILY MEAN		HIGHEST		LOWEST		EXTREMES		RELATIVE HUMIDITY		CLOUD AMOUNT		TOTAL IN WETTEST MONTH WITH RAIN		TOTAL IN DRIEST MONTH WITH RAIN		DATE OF HEAVIEST FALL IN YEAR					
	°C	°F	°C	°F	°C	°F	°C	°F	°C	°F	°C	°F	%	ALL CLOUDS	LOW CLOUDS	mm	INCHES	mm	INCHES	mm	INCHES	DATE				
JAN	17.6	63.7	13.5	56.3	27.5	81.5	30.9	87.6	9.2	48.2	35.0	95.0	22	1955	5.0	41.0	60	2.4	13.2	0.5	6.7	0.8	134.4	5.4	22	
FEB	18.0	64.4	15.1	59.2	31.1	88.0	35.2	95.4	11.7	53.1	37.8	100	35	1893	5.0	41.0	51	2.0	12.5	0.5	12.3	1.0	118.9	4.7	04	
MAR	21.0	69.8	18.2	64.8	35.5	95.9	39.6	103.3	16.1	61.0	43.3	108	28	1898	8.3	46.9	41	1.6	13.3	0.5	24.6	1.7	106.2	4.2	17	
APR	21.0	69.8	18.2	64.8	35.5	95.9	39.6	103.3	16.1	61.0	43.3	108	28	1898	8.3	46.9	39	1.5	13.3	0.5	15.7	1.6	131.1	5.2	18	
MAY	23.9	75.0	20.8	79.4	42.0	107.6	45.2	113.4	23.8	74.8	47.7	118	10	1942	14.4	57.9	23	0.9	14.4	0.6	18.8	1.9	147.1	5.8	27	
JUN	24.4	75.9	21.0	79.8	37.4	99.3	43.8	110.8	21.9	81.4	47.2	11	16.1	1931	16.1	61.0	64	2.5	15.0	0.6	18.8	1.9	147.1	5.8	27	
JUL	28.4	83.1	24.5	76.1	30.8	87.4	35.4	95.7	21.7	81.1	38.9	01	20.0	1891	20.0	68.0	85	3.8	23.2	0.9	18.8	1.9	147.1	5.8	27	
AUG	28.5	83.3	25.1	77.2	30.2	86.4	33.4	92.1	21.9	81.4	37.5	03	20.0	1972	20.0	68.0	76	3.0	23.2	0.9	30.1	1.2	98.8	3.9	02	
SEP	28.1	82.6	25.0	77.0	31.3	88.3	34.0	93.2	21.7	81.1	37.2	19	18.3	1899	18.3	69.0	87	4.0	23.2	0.9	34.4	1.4	108.4	4.3	04	
OCT	25.8	78.4	22.1	71.8	31.8	89.2	34.1	93.4	17.8	64.0	37.8	11	13.9	1899	13.9	57.0	81	3.2	23.2	0.9	23.0	0.9	78.5	3.1	04	
NOV	21.6	80.9	17.2	63.0	29.6	85.3	32.0	90.0	13.0	55.4	35.6	02	8.3	1935	8.3	46.9	56	2.5	22.0	0.9	53.9	2.1	168.6	6.7	08	
DEC	18.1	64.6	14.0	57.2	27.3	81.1	30.2	86.4	9.7	49.5	32.3	27	3.9	1976	3.9	31.1	45	1.7	12.7	0.5	7.4	0.3	130.2	5.1	02	
ANNUAL MEAN	25.4	77.7	20.1	68.2	32.8	91.0	45.5	114.0	8.8	47.8	47.7	3.9	100	100	100	62	20.0	3.5	1.4	1268.8	62.3	2181.4	86.9	370.3	6.9	
TOTAL OR MEAN	30.4	86.7	21.5	80.7	30.0	86.0	30.0	86.0	30.0	86.0	30.0	100	30	30	30	47	19.0	4.0	2.1	1884	62.9	1884	62.9	100	100	
NUMBER OF YEARS	30	30	30	30	30	30	30	30	30	30	30	100	30	30	30	30	30	30	30	30	30	30	30	30	30	30

LOT-2 PROJECTS
 FLUE GAS DESULPHURISATION (FGD)
 SYSTEM PACKAGE

TECHNICAL SPECIFICATION
 SECTION - VI, PART-A
 BID DOC. NO.:CS-0011-109(2)-9

SUB-SECTION-II-A5
 PROJECT INFORMATION
 (BHILAI 2X250 MW)

PAGE 19 OF 30

THIS IS PART OF TECHNICAL SPECIFICATION PE-TS-468-571-A901 REV 00.

CLAUSE NO.	PROJECT INFORMATION 																						
	<p style="text-align: right;">Annexure-III</p> <p style="text-align: center;">SOIL DATA AND FOUNDATION SYSTEM</p> <p>Employer has carried out geotechnical investigation in vicinity to the proposed area. Logs of available boreholes for bidder's solely information in the vicinity of proposed area are enclosed with this Annexure.</p> <p>The bidder is required to carry out geotechnical investigation as per Clause No 7.08.00 and ascertain the bearing capacity. The onus of correct assessment / interpretation and understanding of the existing subsoil condition / data is on the Bidder. The existing ground level (EGL) is varying as per enclosed contour/spot level drawing.</p> <p>a) The foundation system to be adopted for different structures shall be as given in Table – 1 below</p> <p style="text-align: center;">Table – 1: Net Allowable Bearing Pressure</p> <table border="1" data-bbox="415 856 1383 1010"> <thead> <tr> <th data-bbox="415 856 1089 951">STRUCTURE</th> <th data-bbox="1089 856 1383 951">TYPE OF FOUNDATION TO BE ADOPTED</th> </tr> </thead> <tbody> <tr> <td data-bbox="415 951 1089 1010">FGD and related structures</td> <td data-bbox="1089 951 1383 1010">Open</td> </tr> </tbody> </table> <p>b) Bidder is required to carry out geotechnical investigation in this area. The allowable bearing pressure shall be adopted after approval of geotechnical investigation report by owner. However, the maximum allowable bearing pressure shall be as per the approved geotechnical report and shall be limited to the values as furnished in Table-2.</p> <p style="text-align: center;">Table – 2: Net Allowable Bearing Pressure</p> <table border="1" data-bbox="456 1266 1383 1793"> <thead> <tr> <th data-bbox="456 1266 833 1738" rowspan="2">Founding Depth/ Stratum</th> <th colspan="3" data-bbox="833 1266 1383 1335">Net Allowable Bearing PressureT/m2</th> </tr> </thead> <tbody> <tr> <td data-bbox="833 1335 1000 1682">Isolated and combined footings including raft for 25mm permissible settlement in case of soil and 12mm in case of rocky strata</td> <td data-bbox="1000 1335 1157 1682">Isolated and combined footings for 40mm permissible settlement in case of soil and 12mm in case of rocky strata</td> <td colspan="2" data-bbox="1157 1335 1383 1539">Rafts (width > 6m) for 75mm permissible settlement in case of soil and 12mm in case of rocky strata</td> </tr> <tr> <td colspan="2" data-bbox="833 1682 1157 1738" style="text-align: center;">Width upto 6.0m</td> <td colspan="2" data-bbox="1157 1682 1383 1738"></td> </tr> <tr> <td colspan="4" data-bbox="456 1738 1383 1793" style="text-align: center;">In case of Soil</td> </tr> </tbody> </table>			STRUCTURE	TYPE OF FOUNDATION TO BE ADOPTED	FGD and related structures	Open	Founding Depth/ Stratum	Net Allowable Bearing PressureT/m2			Isolated and combined footings including raft for 25mm permissible settlement in case of soil and 12mm in case of rocky strata	Isolated and combined footings for 40mm permissible settlement in case of soil and 12mm in case of rocky strata	Rafts (width > 6m) for 75mm permissible settlement in case of soil and 12mm in case of rocky strata		Width upto 6.0m				In case of Soil			
STRUCTURE	TYPE OF FOUNDATION TO BE ADOPTED																						
FGD and related structures	Open																						
Founding Depth/ Stratum	Net Allowable Bearing PressureT/m2																						
	Isolated and combined footings including raft for 25mm permissible settlement in case of soil and 12mm in case of rocky strata	Isolated and combined footings for 40mm permissible settlement in case of soil and 12mm in case of rocky strata	Rafts (width > 6m) for 75mm permissible settlement in case of soil and 12mm in case of rocky strata																				
Width upto 6.0m																							
In case of Soil																							
LOT-2 PROJECTS FLUE GAS DESULPHURISATION (FGD) SYSTEM PACKAGE	TECHNICAL SPECIFICATION SECTION – VI, PART-A BID DOC. NO.:CS-0011-109(2)-9	SUB-SECTION-II-A5 PROJECT INFORMATION (BHILAI 2X250 MW)	PAGE 20 OF 30																				

CLAUSE NO.	PROJECT INFORMATION																															
	<table border="1" data-bbox="456 228 1382 512"> <tr> <td>2.0m below NGL</td> <td>12</td> <td>14</td> <td>20</td> </tr> <tr> <td>3.0m below NGL</td> <td>15</td> <td>20</td> <td>25</td> </tr> <tr> <td colspan="4">In case of rocky strata</td> </tr> <tr> <td>0.5m embedment into rock</td> <td>30</td> <td>30</td> <td>30</td> </tr> <tr> <td>1.0m embedment into rock</td> <td>35</td> <td>35</td> <td>35</td> </tr> </table> <p data-bbox="391 516 1425 575">- For NGL, topographical survey drawing along with borehole details carried out by bidder shall be referred.</p> <p data-bbox="391 611 1425 743">The net allowable bearing pressure higher than above mentioned values shall not be permitted. At intermediate levels the bearing capacity shall be same as the net allowable bearing pressure corresponding to the immediate shallower level mentioned above.</p> <p data-bbox="326 800 915 831">c) Permissible Settlement of Foundations:</p> <p data-bbox="391 842 1425 974">For open foundations, the total permissible settlement and differential settlement shall be governed by IS: 1904 and from functional requirements whichever is more stringent. However, total settlement shall be restricted to the following:</p> <table border="1" data-bbox="407 989 1235 1268"> <tr> <td>Isolated, Strip & Raft (Mill foundations/machine foundation)</td> <td>25 mm</td> </tr> <tr> <td>Isolated & Strip (Other than Mill foundations/machine foundation)</td> <td>40 mm</td> </tr> <tr> <td>Raft (widths greater than 6 m) (Other than Mill foundations/machine foundation)</td> <td>75 mm</td> </tr> <tr> <td>Foundations in rock</td> <td>12 mm</td> </tr> </table> <p data-bbox="391 1272 1425 1373">In case the total permissible settlement is to be restricted to less than as above specified from functional requirements, then the net allowable bearing pressure shall be reduced after review in consultation with Engineer.</p>			2.0m below NGL	12	14	20	3.0m below NGL	15	20	25	In case of rocky strata				0.5m embedment into rock	30	30	30	1.0m embedment into rock	35	35	35	Isolated, Strip & Raft (Mill foundations/machine foundation)	25 mm	Isolated & Strip (Other than Mill foundations/machine foundation)	40 mm	Raft (widths greater than 6 m) (Other than Mill foundations/machine foundation)	75 mm	Foundations in rock	12 mm	
2.0m below NGL	12	14	20																													
3.0m below NGL	15	20	25																													
In case of rocky strata																																
0.5m embedment into rock	30	30	30																													
1.0m embedment into rock	35	35	35																													
Isolated, Strip & Raft (Mill foundations/machine foundation)	25 mm																															
Isolated & Strip (Other than Mill foundations/machine foundation)	40 mm																															
Raft (widths greater than 6 m) (Other than Mill foundations/machine foundation)	75 mm																															
Foundations in rock	12 mm																															
<p align="center">LOT-2 PROJECTS FLUE GAS DESULPHURISATION (FGD) SYSTEM PACKAGE</p>	<p align="center">TECHNICAL SPECIFICATION SECTION – VI, PART-A BID DOC. NO.:CS-0011-109(2)-9</p>	<p align="center">SUB-SECTION-II-A5 PROJECT INFORMATION (BHILAI 2X250 MW)</p>	<p align="center">PAGE 21 OF 30</p>																													



CLAUSE NO.

PROJECT INFORMATION

Annexure-IV

M.K.SOIL TESTING LABORATORY - CAMP : BHILAI																			
PROFORMA FOR PRESENTING DRILLING INFORMATION																			
PROJECT : GEOTECHNICAL INVESTIGATION OF PP2				GEOLOGICAL LOG OF DRILL HOLE				FEATURE											
HOLE NO : BH 37				LOCATION : MAIN PLANT AREA PP 2				TOTAL DEPTH : 30 METR.											
BEARING OF HOLE : -				CD COORDINATES : X 2200 Y 9100				GROUND WATER TABLE : 130 METR. (EPAGE WATER)											
COLLAR ELEVATION : -				ANGLE WITH HORIZONTAL : VERTICAL				TYPE OF CORE BARREL USED : DOUBLE TUBE											
TYPE OF USED (WITH DEPTH) : DIAMOND				GROUND RL : 296.815m.				DATE OF COMPLETION : 17.08.2003											
STARTED : 08.08.2003																			
DEPTH IN METRE	S	TO	DATE	LITHOLOGY	LOG	PIECES WITH SIZES				STRUCTURAL	SAMPLING-TEST RUN	RECOVERY				WATER LOSS	NO. OF	WASH	SPECIAL
						< 10mm	10 to 25mm	25 to 75mm	75 to 150mm			LOG DESCRIPTION	20	40	60				
0.00	0.50	0.8.03		Reddish brown clay with organic materials and lankers							DS								
0.50	1.50	0.8.03		Reddish brown clay with lankers and gravels							UCS								
1.50	2.25	0.8.03		Reddish brown clay with lankers and gravels							SPT 4.5, 10 N = 16								
2.25	3.00	0.8.03		Reddish brown clay with lankers and gravels							DS								
3.00	3.75	0.8.03		Reddish brown clay with lankers and gravels							UDSGS								
3.75	4.50	0.8.03		Yellowish brown clay with lankers and gravels							DS								
4.50	5.25	0.8.03		Vergated claylastic clay							SPT 40.40.45 N = 85								
5.25	6.00	0.8.03		Vergated claylastic clay							DS								
6.00	6.75	0.8.03		Vergated claylastic clay							UCS								
6.75	7.50	0.8.03		Vergated claylastic clay							DS								
7.50	8.25	10.8.03		Vergated claylastic clay							SPT 45, N x 100 10cm penet								
8.25	9.00	10.8.03		Vergated claylastic clay							DS								
9.00	9.75	10.8.03		Vergated claylastic clay							UDSGS								
9.75	10.50	10.8.03		Vergated claylastic clay							DS								
10.50	11.25	10.8.03		Vergated claylastic clay							SPT 50, N x 100 8 cm penet								
11.25	12.00	11.8.03		Reddish brown clay (stateric) clay with lankers							DS								
12.00	12.75	11.8.03		Reddish brown clay (stateric) clay with lankers							UCS								
12.75	13.50	11.8.03		Reddish brown clay (stateric) clay with lankers							DS								
13.50	14.25	12.8.03		Weathered silty shale of redish yellow colour							SPT N > 100								
14.25	15.00	13.8.03		Dark brown coloured lime stone with stromatolitic fossilie							DS								
15.00	15.75	13.8.03		Dark brown coloured lime stone with stromatolitic fossilie		2					CS CR - 21% RGD 20%			20	220				
15.75	16.50	14.8.03		Dark brown coloured lime stone with stromatolitic fossilie		1	2				CS CR - 26% RGD 17%			17	220				
16.50	17.25	14.8.03		Dark brown coloured lime stone with stromatolitic fossilie				1			CS CR - 25% RGD 13%			13	220				
17.25	18.00	14.8.03		Dark brown coloured lime stone with stromatolitic fossilie		1	-	1			CS CR - 26% RGD 17%			17	230				
18.00	18.75	15.8.03		Dark brown coloured lime stone with stromatolitic fossilie		1	-	1			CS CR - 30% RGD NIL			-	250				
18.75	19.50	15.8.03		Dark brown coloured lime stone with stromatolitic fossilie		2	2				CS CR - 32% RGD NIL			-	250				
19.50	20.25	15.8.03		Dark brown coloured lime stone with silty shale having carbonate veins		1	-	1			CS CR - 40% RGD NIL			-	250				
20.25	21.00	15.8.03		Yellowish silty shale with carbonate veins		3	1				CS CR - 35% RGD NIL			-	250				
21.00	21.75	16.8.03		Yellowish silty shale with carbonate veins		3					CS CR - 36% RGD NIL			-	250				
21.75	22.50	16.8.03		Yellowish silty shale with carbonate veins		1					CS CR - 38% RGD NIL			-	230				
22.50	23.25	16.8.03		Yellowish silty shale with carbonate veins		1					CS CR - 40% RGD NIL			-	240				
23.25	24.00	16.8.03		Yellowish silty shale with carbonate veins		2	3				CS CR - 34% RGD NIL			-	230				
24.00	24.75	16.8.03		Yellowish silty shale with carbonate veins		1	2				CS CR - 36% RGD NIL			-	235				
24.75	25.50	16.8.03		Yellowish silty shale with carbonate veins		1	-	2			CS CR - 38% RGD NIL			-	230				
25.50	26.25	16.8.03		Yellowish silty shale with carbonate veins		1	1	1			CS CR - 40% RGD NIL			-	230				
26.25	27.00	16.8.03		Dark brown colour lime stone with stromatolitic fossilie		2	-	4			CS CR - 37% RGD 18%			16	225				
27.00	27.75	16.8.03		Dark brown colour lime stone with stromatolitic fossilie		2	2				CS CR - 38% RGD 18%			18	230				
27.75	28.50	17.8.03		Dark brown colour lime stone with stromatolitic fossilie		3	-	2			CS CR - 42% RGD 22%			22	235				
28.50	29.25	17.8.03		Dark brown colour lime stone with stromatolitic fossilie		2	3	1			CS CR - 44% RGD 34%			24	225				
29.25	30.00	17.8.03		Dark brown colour lime stone with stromatolitic fossilie		1	2				CS CR - 50% RGD 16%			16	190				

THE ROCK IS (SPPRIMAT)ADY, SOFT, WEATHERED. ALSO CORE SAMPLE BREAKS FROM THE CARBONATE VEIN PART OF A SAMPLE. THERE IS ALTERNATE LAYER OF LIME STONE AND SHALE. WATER LOSS IS ENCOUNTERED AT 28 METR. TILL END.

THIS IS PART OF TECHNICAL SPECIFICATION PE-TS-468-571-A901 REV 00.



CLAUSE NO.

PROJECT INFORMATION

M.K.SOIL TESTING LABORATORY - CAMP : BHILAI																			
PROFORMA FOR PRESENTING DRILLING INFORMATION																			
PROJECT GEOTECHNICAL INVESTIGATION OF PP2										GEOLOGICAL LOG OF DRILL HOLE					FEATURE				
HOLE NO BH 30										LOCATION MAIN PLANT AREA PP 2					TOTAL DEPTH : 30 MTR.				
BEARING OF HOLE -										CD COORDINATES X 1700 Y 9400					GROUND WATER TABLE: 1MTR.BELOW WATER				
COLLAR ELEVATION -										ANGLE WITH HORIZONTAL VERTICAL					TYPE OF CORE BARREL USED : DOUBLE TUBE				
TYPE OF USED (WITH DEPTH) DIAMOND										GROUND RL : 289.744					DATE OF COMPLETION 09.09.20				
STARTED 02.09.2002																			
MT		LITHOLOGY			PIECES WITH SIZES			STRUCTURAL		SAMPLING		RECOVERY			WATER LOSS		SPECIAL		
FROM	TO	DATE	DESCRIPTION	LOG	NO	SIZE	LOG	DESCRIPTION	ST. RUN	20	40	60	80	100	ROD (%)	RATE OF CHANGING	NO PARTIAL	OF WASH	OBSERVATION AND
0.00	0.00	3.9.03	Reddish brown clay with organic material with lankers and gravels (Red colour)						DS										
0.00	0.50	3.9.03	Reddish brown clay with lankers and gravels						UGS/DS										
0.50	1.50	3.9.03	Reddish brown clay with lankers and gravels						SPT 7,12,19 N-31										
1.50	2.25	3.9.03	Reddish brown clay with lankers and gravels						DS										
2.25	3.00	4.9.03	Reddish brown clay with lankers and gravels						UGS										
3.00	3.75	4.9.03	Reddish brown clay with lankers and gravels						DS										
3.75	4.50	4.9.03	Reddish brown clay with lankers and gravels						SPT 12,18,23 N-41										
4.50	5.25	4.9.03	Reddish brown clay with lankers and gravels						DS										
5.25	6.00	4.9.03	Yellowish green staly shale with fossile impression and carbonate veins						DS										
6.00	6.75	4.9.03	Yellowish green staly shale with fossile impression and carbonate veins						DS										
6.75	7.50	4.9.03	Yellowish green staly shale with fossile impression and carbonate veins						DS										
7.50	9.00	5.9.03	Yellowish green staly shale with fossile impression and carbonate veins						CS CR - 40 RQD NIL						190				
9.00	10.50	5.9.03	Yellowish green staly shale with fossile impression and carbonate veins						CS CR - 37 RQD NIL						190				
10.50	12.00	6.9.03	Yellowish green staly shale with fossile impression and carbonate veins						CS CR - 36 RQD NIL						190				
12.00	13.50	6.9.03	Yellowish green staly shale with fossile impression and carbonate veins						CS CR - 42 RQD NIL						180				
13.50	15.00	6.9.03	Yellowish green staly shale with fossile impression and carbonate veins						CS CR - 60 RQD NIL						200				
15.00	16.50	6.9.03	Dark brown colour lime stone with stromatolitic fossile impression alongwith grayish staly shale having carbonate veins						CS CR - 60 RQD 26%						28	200			
16.50	18.00	6.9.03	Grayish staly shale with carbonate veins						CS CR - 90 RQD 15%						15	190			
18.00	19.50	7.9.03	Grayish staly shale with carbonate veins						CS CR - 91 RQD 28%						28	190			
19.50	21.00	7.9.03	Grayish staly shale with carbonate veins						CS CR - 78 RQD 14%						14	180			
21.00	22.50	7.9.03	Grayish staly shale with carbonate veins						CS CR - 92 RQD 34%						34	200			
22.50	24.00	9.9.03	Grayish staly shale with carbonate veins						CS CR - 93 RQD 45%						45	210			
24.00	25.50	8.9.03	Grayish staly shale with carbonate veins						CS CR - 90 RQD 56%						56	220			
25.50	27.00	8.9.03	Grayish staly shale with carbonate veins						CS CR - 98 RQD 62%						62	230			
27.00	28.50	9.9.03	Grayish staly shale with carbonate veins alongwith Dark brown colour lime stone with 55 cm. Legth.						CS CR - 88 RQD 36%						36	220			
28.50	30.00	9.9.03	Grayish staly shale with carbonate veins						CS CR - 90 RQD 34%						34	200			

THE ROCK IS SEDIMENTARY SOFT AND WEATHERED YELLOWISH GREEN SLATY SHALE IS FOUND IN THIS BORE WITH FOSSILE IMPRESSIONS AND CARBONATE VEINS. LIME STONE PATCH OF 55 CM. HAS BEEN ENCOUNTERED AT A DEPTH OF 16MTRS. WHICH IS A PECULIAR FEATURE OF THIS BORE HOLE. IN THIS BORE HOLE ROCK HAS BEEN ENCOURED AT A DEPTH OF 7.50 MTRS.

THIS IS PART OF TECHNICAL SPECIFICATION PE-TS-468-571-A901 REV 00.



CLAUSE NO.

PROJECT INFORMATION

M.K.SOIL TESTING LABORATORY - CAMP : BHILAI																	
PROFORMA FOR PRESENTING DRILLING INFORMATION																	
PROJECT GEOTECHNICAL INVESTIGATION OF PP2										GEOLOGICAL LOG OF DRILL HOLE				FEATURE			
HOLE NO BH 30										LOCATION MAIN PLANT AREA PP 2				TOTAL DEPTH : 30 MTR.			
BEARING OF HOLE -										COORDINATES X 7500 Y 9400				GROUND WATER TABLE : 1 MTR BELOW WATER			
COLLAR ELEVATION -										ANGLE WITH HORIZONTAL VERTICAL				TYPE OF CORE BARREL USED : DOUBLE TUBE			
TYPE OF USED (WITH DEPTH) DIAMOND										GROUND RL : 289.744				DATE OF COMPLETION 09.09.03			
STARTED 03.09.2003																	
FROM	TO	DEPTH	LITHOLOGY	LOG	PIECES WITH SIZES			STRUCTURAL	SAMPLING/TEST RUN	RECOVERY				ROD (%)	RATE OF PENETRATION	WATER LOSS	SPECIAL OBSERVATION AND
					LOG	DESCRIPTION	LOG			DESCRIPTION	NO PARTIAL	NO PARTIAL	NO PARTIAL				
					LOG	DESCRIPTION	LOG	DESCRIPTION	20	40	60	80	100				
0.00	0.00	3.9.03	Reddish brown clay with organic materials with lankers and gravels (Red colour)						DS								
0.00	0.50	3.9.03	Reddish brown clay with lankers and gravels						UDS/DS								
0.50	1.50	3.9.03	Reddish brown clay with lankers and gravels						SPT 7,12,19								
1.50	2.25	3.9.03	Reddish brown clay with lankers and gravels						DS								
2.25	3.00	4.9.03	Reddish brown clay with lankers and gravels						UDS								
3.00	3.75	4.9.03	Reddish brown clay with lankers and gravels						DS								
3.75	4.50	4.9.03	Reddish brown clay with lankers and gravels						SPT 12,18,23								
4.50	5.25	4.9.03	Reddish brown clay with lankers and gravels						DS								
5.25	6.00	4.9.03	Yellowish green staly shale with fossile impression and carbonate veins.						DS								
6.00	6.75	4.9.03	Yellowish green staly shale with fossile impression and carbonate veins.						DS								
6.75	7.50	4.9.03	Yellowish green staly shale with fossile impression and carbonate veins.						DS								
7.50	9.00	5.9.03	Yellowish green staly shale with fossile impression and carbonate veins.						CS CR - 40 ROD NIL								
9.00	10.50	5.9.03	Yellowish green staly shale with fossile impression and carbonate veins.						CS CR - 37 ROD NIL								
10.50	12.00	6.9.03	Yellowish green staly shale with fossile impression and carbonate veins.						CS CR - 36 ROD NIL								
12.00	13.50	6.9.03	Yellowish green staly shale with fossile impression and carbonate veins.						CS CR - 42 ROD NIL								
13.50	15.00	6.9.03	Yellowish green staly shale with fossile impression and carbonate veins.						CS CR - 60 ROD NIL								
15.00	16.50	6.9.03	Dark brown colour lime stone with stromatolitic fossile impression alongwith grayish staly shale having carbonate veins.		3	1	-	-									
16.50	18.00	6.9.03	Grayish staly shale with carbonate veins.		5	8	2	-		CS CR - 80 ROD 26%							
18.00	19.50	7.9.03	Grayish staly shale with carbonate veins.		6	6	3	-		CS CR - 90 ROD 15%							
19.50	21.00	7.9.03	Grayish staly shale with carbonate veins.		5	4	3	-		CS CR - 91 ROD 28%							
21.00	22.50	7.9.03	Grayish staly shale with carbonate veins.		4	3	1	-		CS CR - 76 ROD 14%							
22.50	24.00	8.9.03	Grayish staly shale with carbonate veins.		3	1	6	1		CS CR - 92 ROD 34%							
24.00	25.50	8.9.03	Grayish staly shale with carbonate veins.		3	-	5	2		CS CR - 93 ROD 45%							
25.50	27.00	8.9.03	Grayish staly shale with carbonate veins.		2	2	7	2		CS CR - 90 ROD 56%							
27.00	28.50	9.9.03	Grayish staly shale with carbonate veins alongwith Dark brown colour lime stone with 55 gm. Lignite		2	2	-	2		CS CR - 96 ROD 62%							
28.50	30.00	9.9.03	Grayish staly shale with carbonate veins.		2	3	-	1		CS CR - 88 ROD 36%							
					5	4	1	-		CS CR - 90 ROD 34%							

THE ROCK IS SEDIMENTARY SOFT AND WEATHERED YELLOWISH GREEN SLATY SHALE IS FOUND IN THIS BORE WITH FOSSILE IMPRESSIONS AND CARBONATE VEINS. LIME STONE PATCH OF 55 CM. HAS BEEN ENCOUNTERED AT A DEPTH OF 16 METRS WHICH IS A REGULAR FEATURE OF THIS BORE HOLE. IN THIS BORE HOLE ROCK HAS BEEN ENCOUNTERED AT A DEPTH OF 7.50 METRS.

THIS IS PART OF TECHNICAL SPECIFICATION PE-TS-468-571-A901 REV 00.

CLAUSE NO.	PROJECT INFORMATION										
Table-1 COAL AND ASH CHARACTERISTICS											
<table border="1" style="width: 100%; border-collapse: collapse;"> <thead> <tr> <th style="width: 5%;">S.N.</th> <th style="width: 35%;">Description</th> <th style="width: 10%;">Symbol</th> <th style="width: 10%;">Design Coal</th> <th style="width: 10%;">Worst Coal</th> <th style="width: 10%;">Best Coal</th> </tr> </thead> </table>						S.N.	Description	Symbol	Design Coal	Worst Coal	Best Coal
S.N.	Description	Symbol	Design Coal	Worst Coal	Best Coal						
A: PROXIMATE ANALYSIS (As received basis)											
1	Total Moisture	%	13	16	12						
2	Ash	%	42	46	38						
3	Volatile matter	%	21	18	24						
4	Fixed carbon	%	24	20	27						
B: ULTIMATE ANALYSIS (As received basis)											
1	Carbon	C%	32.92	27.97	39.08						
2	Hydrogen	H ₂ %	3.2	2.45	3.4						
3	Nitrogen	N ₂ %	1.28	1.08	1.19						
4	Oxygen (By difference)	O ₂ %	7.2	6.00	6.97						
5	Sulphur	S%	0.4	0.50	0.36						
6	Total Moisture	H ₂ O%	13.00	16.00	11.00						
7	Ash	%	42.00	46.00	38.00						
8	Gross Calorific Value	KCal/Kg	3400	2800	4000						
9	Hard grove index		55	50	60						
C: ASH ANALYSIS											
1	Silica	(SiO ₂)%	58.78	61.30	55.70						
2	Alumina	(Al ₂ O ₃)%	28.20	28.35	27.20						
3	Iron Oxide	(Fe ₂ O ₃)%	7.5	6.00	10.00						
4	Titania	(TiO ₂)%	1.50	1.00	2.00						
5	Lime	(CaO)%	1.23	1.05	1.50						
6	Magnesia	(MgO)%	1.55	1.35	2.05						
7	Sodium Oxide(Na ₂ O) & Potassium Oxide (K ₂ O)	% By Difference	1.09	0.80	1.40						
8	Phosphoric Anhydride	(P ₂ O ₅)%	0.05	0.05	0.05						
10	Sulphuric Anhydride	(SO ₃)%	0.10	0.10	0.10						
D: ASH FUSION RANGE (Under reducing atmosphere)											
a)	Initial Deformation Temperature (IDT)	°C	1150	1200	1100						
b)	Hemispherical temperature	°C	1350	1400	1300						
c)	Flow temperature	°C	1400	1400	1400						
LOT-2 PROJECTS FLUE GAS DESULPHURISATION (FGD) SYSTEM PACKAGE	TECHNICAL SPECIFICATION SECTION – VI, PART-A BID DOC. NO.:CS-0011-109(2)-9	SUB-SECTION-II-A5 PROJECT INFORMATION (BHILAI 2X250 MW)	PAGE 25 OF 30								

CLAUSE NO.	PROJECT INFORMATION																																						
	<p style="text-align: center;">TABLE - 2 LIGHT DIESEL OIL CHARACTERISTICS AS PER IS 1460-2000</p> <table border="1" data-bbox="407 323 1398 1129"> <thead> <tr> <th colspan="2" data-bbox="412 329 1027 386">Characteristics</th> <th data-bbox="1031 329 1393 386">LDO</th> </tr> </thead> <tbody> <tr> <td data-bbox="412 390 496 474">1.</td> <td data-bbox="500 390 1027 474">Pour Point (max)</td> <td data-bbox="1031 390 1393 474">21°C & 12°C for Summer and Winter respectively</td> </tr> <tr> <td data-bbox="412 478 496 562">2.</td> <td data-bbox="500 478 1027 562">Kinematic viscosity in centistokes at 40 deg.C</td> <td data-bbox="1031 478 1393 562">2.5 to 15.7</td> </tr> <tr> <td data-bbox="412 567 496 623">3.</td> <td data-bbox="500 567 1027 623">Sediment percent by mass (max)</td> <td data-bbox="1031 567 1393 623">0.10</td> </tr> <tr> <td data-bbox="412 627 496 684">4.</td> <td data-bbox="500 627 1027 684">Total sulphur percent by mass (max)</td> <td data-bbox="1031 627 1393 684">1.8</td> </tr> <tr> <td data-bbox="412 688 496 745">5.</td> <td data-bbox="500 688 1027 745">Ash percentage by mass (max)</td> <td data-bbox="1031 688 1393 745">0.02</td> </tr> <tr> <td data-bbox="412 749 496 833">6.</td> <td data-bbox="500 749 1027 833">Carbon residue (Rans bottom) percent by pass (max.)</td> <td data-bbox="1031 749 1393 833">1.50</td> </tr> <tr> <td data-bbox="412 837 496 894">7.</td> <td data-bbox="500 837 1027 894">Acidity in organic</td> <td data-bbox="1031 837 1393 894">Nil</td> </tr> <tr> <td data-bbox="412 898 496 955">8.</td> <td data-bbox="500 898 1027 955">Flash point(Min.) - Pensky Martens</td> <td data-bbox="1031 898 1393 955">66 deg.C</td> </tr> <tr> <td data-bbox="412 959 496 1016">9.</td> <td data-bbox="500 959 1027 1016">Copper strip corrosion for 3 hours at 100°C</td> <td data-bbox="1031 959 1393 1016">Not worse than No. 2</td> </tr> <tr> <td data-bbox="412 1020 496 1077">10.</td> <td data-bbox="500 1020 1027 1077">Water content, % by volume(max)</td> <td data-bbox="1031 1020 1393 1077">0.25</td> </tr> <tr> <td data-bbox="412 1081 496 1129">11.</td> <td data-bbox="500 1081 1027 1129">GCV (Kcal/kg)</td> <td data-bbox="1031 1081 1393 1129">10,000</td> </tr> </tbody> </table>			Characteristics		LDO	1.	Pour Point (max)	21°C & 12°C for Summer and Winter respectively	2.	Kinematic viscosity in centistokes at 40 deg.C	2.5 to 15.7	3.	Sediment percent by mass (max)	0.10	4.	Total sulphur percent by mass (max)	1.8	5.	Ash percentage by mass (max)	0.02	6.	Carbon residue (Rans bottom) percent by pass (max.)	1.50	7.	Acidity in organic	Nil	8.	Flash point(Min.) - Pensky Martens	66 deg.C	9.	Copper strip corrosion for 3 hours at 100°C	Not worse than No. 2	10.	Water content, % by volume(max)	0.25	11.	GCV (Kcal/kg)	10,000
Characteristics		LDO																																					
1.	Pour Point (max)	21°C & 12°C for Summer and Winter respectively																																					
2.	Kinematic viscosity in centistokes at 40 deg.C	2.5 to 15.7																																					
3.	Sediment percent by mass (max)	0.10																																					
4.	Total sulphur percent by mass (max)	1.8																																					
5.	Ash percentage by mass (max)	0.02																																					
6.	Carbon residue (Rans bottom) percent by pass (max.)	1.50																																					
7.	Acidity in organic	Nil																																					
8.	Flash point(Min.) - Pensky Martens	66 deg.C																																					
9.	Copper strip corrosion for 3 hours at 100°C	Not worse than No. 2																																					
10.	Water content, % by volume(max)	0.25																																					
11.	GCV (Kcal/kg)	10,000																																					
<p style="text-align: center;">LOT-2 PROJECTS FLUE GAS DESULPHURISATION (FGD) SYSTEM PACKAGE</p>	<p style="text-align: center;">TECHNICAL SPECIFICATION SECTION – VI, PART-A BID DOC. NO.:CS-0011-109(2)-9</p>	<p style="text-align: center;">SUB-SECTION-II-A5 PROJECT INFORMATION (BHILAI 2X250 MW)</p>	<p style="text-align: center;">PAGE 26 OF 30</p>																																				

CLAUSE NO.	PROJECT INFORMATION			
				
TABLE - 2 FUEL OIL CHARACTERISTICS				
Sl. No.	Characteristics	Heavy Furnace oil IS 1953-1971 Grade HV	Low Sulphur Heavy Stock (LSHS)	Heavy Petroleum Stock (HPS)
1.	Total Sulphur Content	4.5% Max	1.0% Max	4.5% Max
2.	Gross Calorific Value (Kcal/kg)	Of the order of 11,000	Of the order of 11,000	9,500 (min)
3.	Flash point (Min)	66deg C	75 deg C	75deg C
4.	Water content by volume (Max)	1.0%	1.0%	1.0%
5.	Sediment by weight (Max)	0.25%	0.25%	0.25%
6.	Asphaltene content by weight (Max)	2.5%	2.5%	2.5%
7.	Kinematic viscosity in centistokes at 50 deg C (Max)	370	180	500
8.	Ash content by weight (Max)	0.1%	0.05%	0.1%
9.	Addity (Inorganic)	Nil	Nil	Nil
10.	Pour Point (Max)	-	57Deg C	72 Deg C
11.	Sodium Content	-	-	100 ppm
12.	Vanadium content	25 ppm	25 ppm	25 ppm
13.	Specific heat below pour point (Kcal/KG0C)	-	0.65	-
Table-3 NOT USED				
LOT-2 PROJECTS FLUE GAS DESULPHURISATION (FGD) SYSTEM PACKAGE	TECHNICAL SPECIFICATION SECTION – VI, PART-A BID DOC. NO.:CS-0011-109(2)-9	SUB-SECTION-II-A5 PROJECT INFORMATION (BHILAI 2X250 MW)	PAGE 27 OF 30	

CLAUSE NO.	PROJECT INFORMATION																																																													
	<p style="text-align: center;">Table-4 DESIGN CLARIFIED WATER ANALYSIS</p> <table border="1" data-bbox="430 323 1417 810"> <thead> <tr> <th>S.No</th> <th>Constituent</th> <th>As</th> <th>mg/l (except pH & turbidity)</th> </tr> </thead> <tbody> <tr> <td>1.</td> <td>Calcium</td> <td>CaCO₃</td> <td>38</td> </tr> <tr> <td>2.</td> <td>Magnesium</td> <td>CaCO₃</td> <td>22</td> </tr> <tr> <td>3.</td> <td>Chloride</td> <td>CaCO₃</td> <td>20</td> </tr> <tr> <td>4.</td> <td>Sulphate</td> <td>CaCO₃</td> <td>17</td> </tr> <tr> <td>5.</td> <td>Alkalinity</td> <td>CaCO₃</td> <td>54</td> </tr> <tr> <td>6.</td> <td>Iron(total)</td> <td>Fe</td> <td>0.1</td> </tr> <tr> <td>7.</td> <td>Total Silica</td> <td>SiO₂</td> <td>07</td> </tr> <tr> <td>8.</td> <td>pH value</td> <td>---</td> <td>7.5</td> </tr> <tr> <td>9.</td> <td>Turbidity</td> <td>NTU</td> <td>02</td> </tr> </tbody> </table> <p>Note: Clarified water is used for CW system as make up & the CW system is expected to operate at about 5.0 – 5.5 Cycles of Concentration (COC) with suitable chemical treatment program using acid, scale & corrosion inhibitor dosing. As CW blow down water is tapped from CW system, the water quality of CW blow down shall accordingly be arrived by the bidder. Clarified water shall be at Ambient temperature.</p> <p style="text-align: center;">Table-5 ANALYSIS OF DM WATER</p> <table border="1" data-bbox="407 1192 1408 1570"> <thead> <tr> <th>S.N.</th> <th>Characteristics</th> <th>Value</th> </tr> </thead> <tbody> <tr> <td>1.</td> <td>Silica (Max.)</td> <td>0.02 ppm as SiO₂</td> </tr> <tr> <td>2.</td> <td>Iron (Fe)</td> <td>Nil</td> </tr> <tr> <td>3.</td> <td>Total hardness</td> <td>Nil</td> </tr> <tr> <td>4.</td> <td>pH value</td> <td>6.8 to 7.2</td> </tr> <tr> <td>5.</td> <td>Conductivity</td> <td>Not more than 0.1 µs/cm</td> </tr> </tbody> </table>				S.No	Constituent	As	mg/l (except pH & turbidity)	1.	Calcium	CaCO ₃	38	2.	Magnesium	CaCO ₃	22	3.	Chloride	CaCO ₃	20	4.	Sulphate	CaCO ₃	17	5.	Alkalinity	CaCO ₃	54	6.	Iron(total)	Fe	0.1	7.	Total Silica	SiO ₂	07	8.	pH value	---	7.5	9.	Turbidity	NTU	02	S.N.	Characteristics	Value	1.	Silica (Max.)	0.02 ppm as SiO ₂	2.	Iron (Fe)	Nil	3.	Total hardness	Nil	4.	pH value	6.8 to 7.2	5.	Conductivity	Not more than 0.1 µs/cm
S.No	Constituent	As	mg/l (except pH & turbidity)																																																											
1.	Calcium	CaCO ₃	38																																																											
2.	Magnesium	CaCO ₃	22																																																											
3.	Chloride	CaCO ₃	20																																																											
4.	Sulphate	CaCO ₃	17																																																											
5.	Alkalinity	CaCO ₃	54																																																											
6.	Iron(total)	Fe	0.1																																																											
7.	Total Silica	SiO ₂	07																																																											
8.	pH value	---	7.5																																																											
9.	Turbidity	NTU	02																																																											
S.N.	Characteristics	Value																																																												
1.	Silica (Max.)	0.02 ppm as SiO ₂																																																												
2.	Iron (Fe)	Nil																																																												
3.	Total hardness	Nil																																																												
4.	pH value	6.8 to 7.2																																																												
5.	Conductivity	Not more than 0.1 µs/cm																																																												
<p style="text-align: center;">LOT-2 PROJECTS FLUE GAS DESULPHURISATION (FGD) SYSTEM PACKAGE</p>	<p style="text-align: center;">TECHNICAL SPECIFICATION SECTION – VI, PART-A BID DOC. NO.:CS-0011-109(2)-9</p>	<p style="text-align: center;">SUB-SECTION-II-A5 PROJECT INFORMATION (BHILAI 2X250 MW)</p>	<p style="text-align: center;">PAGE 28 OF 30</p>																																																											

	NSPCL BHILAI (2X250MW) GYPSUM DEWATERING EQUIPMENT TECHNICAL SPECIFICATION	SPECIFICATION No: PE-TS-468-571-A901	
		SECTION : I	
		Sub Section : C	
		REV. 00	

SECTION: I
SUB SECTION: C
TECHNICAL SPECIFICATION

THIS IS PART OF TECHNICAL SPECIFICATION PE-TS-468-571-A901 REV 00.

	NSPCL BHILAI (2X250MW) GYP SUM DEWATERING EQUIPMENT TECHNICAL SPECIFICATION SPECIFIC TECHNICAL REQUIREMENT	SPECIFICATION No: PE-TS-468-571-A901	
		SECTION : I	
		SUB-SECTION : C1	
		REV. 00	
		SHEET 1 OF 19	

SECTION: I

SUB-SECTION: C 1

SPECIFIC TECHNICAL REQUIREMENT

THIS IS PART OF TECHNICAL SPECIFICATION PE-TS-468-571-A901 REV 00.

	NSPCL BHILAI (2X250MW)	SPECIFICATION No: PE-TS-468-571-A901	
	GYPSUM DEWATERING EQUIPMENT	SECTION : I	
	TECHNICAL SPECIFICATION	SUB-SECTION : C1	
	SPECIFIC TECHNICAL REQUIREMENT	REV. 00	
		SHEET 2 OF 19	

1.1	FUNCTION
------------	-----------------

The purpose of the specification is to provide details of the complete Gypsum Dewatering Equipment (GDWE) for NSPCL BHILAI (2X250 MW), under the scope of this tender.

1.2	TECHNICAL INFORMATION	
1.2.1	Quantity of Gypsum De-Watering Equipment (GDWE)	Two (2) Set (one working + one standby)
1.2.2	Capacity of the Vacuum Belt Filter (VBF) in GDWE	17 Tones per hour (wet cake) minimum at outlet of Vacuum Belt Filter for each Belt Filter
1.2.3	Moisture content	10% (max)
1.2.4	Chloride content	100 ppm (max)
1.2.5	Gypsum purity	≥ 90% [by BHEL]

2.1	SCOPE OF SUPPLY & SERVICES
------------	---------------------------------------

The specification covers Supply part, Services part and Mandatory spares comprising of design (i.e. Preparation and submission of drawing /documents including “As Built” drawings and O&M manuals), engineering, manufacture, fabrication, assembly, inspection / testing at vendor's & sub-vendor's works, painting, maintenance tools & tackles, first fill and top-up of lubricants & consumables, mandatory spares along with spares for erection, start-up and commissioning, forwarding, proper packing, shipment and delivery at site AND services part covers supervision services for erection & commissioning, trial run at site and carrying out Performance guarantee tests at site, training of Customer's Engineering Personnel at manufacturer's works covering design familiarization, training on product design features etc. (6 man-days including lodging and boarding) , training of Customer's O&M staff covering all aspects of Operation & Maintenance, Troubleshooting etc. (6 days) at Site & handover in flawless condition of the package to the customer complete with all accessories.

Design: Broadly includes basic engineering, detail engineering, preparation and submission of engineering drawings/ calculations/ datasheets/ quality assurance documents/ field quality plans, storage instructions, commissioning procedures, Erection & assembly Drawings, operation & maintenance manuals, performance guarantee test procedures and assisting BHEL in obtaining time bound approval from customer.

Supply: Broadly includes manufacturing/fabrication, shop floor testing, stage inspections, final inspections, painting, packing & forwarding.

Services: Broadly includes supervision services for erection & commissioning, trial run at site and carrying out Performance Guarantee tests at site, training of Customer's Engineering Personnel at manufacturer's works covering design familiarization, training on product design features etc. (6 man-days including lodging and boarding), training of Customer's O&M staff covering all aspects of Operation & Maintenance, Troubleshooting etc. (6 days) at Site & handover in flawless condition of the package to the customer.

2.1.1 The scope of supply for Gypsum Dewatering Equipment shall include but not limited to the following: (Wherever (*) is marked, one (1) set means complete requirement for both the Gypsum Dewatering Equipment)

	NSPCL BHILAI (2X250MW)	SPECIFICATION No: PE-TS-468-571-A901	
	GYPSUM DEWATERING EQUIPMENT	SECTION : I	
	TECHNICAL SPECIFICATION	SUB-SECTION : C1	
	SPECIFIC TECHNICAL REQUIREMENT	REV. 00	
		SHEET 3 OF 19	

- 2.1.1.1 Primary hydro cyclone: Two (2) sets
- i. Hydrocyclone clusters
 - ii. Anchor bolts, nuts and washers
 - iii. Flanges for inlet and overflow
 - iv. A variety size of vortex finders for the entire hydro cyclone
 - v. Accessory piping within the skid
 - vi. Piping, valves, instruments as per the terminal points defined elsewhere in the specification

- 2.1.1.2 Secondary hydro cyclone: Two (2) sets
- i. Hydrocyclone clusters
 - ii. Anchor bolts, nuts and washers
 - iii. Flanges for inlet and overflow
 - iv. A variety size of vortex finders for the entire hydro cyclone
 - v. Accessory piping within the skid
 - vi. Piping, valves, instruments as per the terminal points defined elsewhere in the specification

- 2.1.1.3 Vacuum belt filters complete with Accessories including discharge chute up to the gypsum conveyor skirt board, driving motors (IE3) inverter duty with VFD and inverter panel: Two (2) numbers. The width of Gypsum conveyor belt is 800mm and that of the skirt board is 533mm.

- 2.1.1.4 Vacuum receivers with Anchor bolts, nuts and washers: Two (2) numbers

Filtrate extraction pumps (2 nos., 1 nos./receiver tank: 1 working + 1 stand by) shall be provided. Refer Scheme No. PE-FEP-00 for the typical Scheme of the arrangement The extraction system of the filtrate complete with pumps, piping, valves, instruments and accessories along with associated supports, fasteners, gaskets etc. with drive (IE3 motor). Also, bidder to include all connection bolts/nuts/washers for installation. Required instruments and any safety device shall be supplied.

Bidder to include the same in the P&ID scheme and submit the same for the approval of BHEL/NSPCL.

- 2.1.1.5 Vacuum pumps with drive (IE3 motor), all connection bolts/nuts/washers for installation, required instruments and any safety device: Two (2) numbers

- 2.1.1.6 Vent fan including enclosure and its arrangement: Two (2) numbers

- 2.1.1.7 Complete arrangement for cloth and cake washing (excluding tanks & their Instruments), pumps with motors (IE3), associated piping, valves, spray nozzles & accessories: One (1) set*

Two (2) nos. of belt filter wash tanks and Two (2) nos. cake washing tanks are envisaged for both the belt filters as per drawing no. 9993-109-PVM-F-044 (Sheet 7-10 of 10). Each tank shall be provided with 2 nos. (1 working + 1 standby) of wash pumps. Suitable arrangement for the washing of belt filter cloth and gypsum cake including piping/ valves/ instruments etc. shall be provided by the bidder.

The tank(s) supply with inlet/outlet nozzle is in BHEL scope. Instrumentation on tank(s) is excluded from the bidder scope. Inlet piping along with associated instruments/ valves from

	NSPCL BHILAI (2X250MW)	SPECIFICATION No: PE-TS-468-571-A901	
	GYPSUM DEWATERING EQUIPMENT TECHNICAL SPECIFICATION SPECIFIC TECHNICAL REQUIREMENT	SECTION : I	
		SUB-SECTION : C1	
		REV. 00	
		SHEET 4 OF 19	

process water and clarified water Terminal points (TP) to the tanks inlet nozzles, Process water and clarified water Outlet piping from the tanks outlet nozzles for cake wash and belt wash comprising of the wash pumps, their motors (IE3) along with associated instruments/ valves etc. shall be in the bidder scope.

However, bidder scope shall be limited to the Engineering as per clause 2.1.1.9 (ii) (g) of this sub-section for the overflow and drain of the tanks.

2.1.1.8 Coupling with guards, wherever applicable: One (1) set*

2.1.1.9 Piping, Valves and accessories

(i) Complete engineering and supply of interconnected piping (slurry, air and water pipes) along with valves, rubber lining (wherever applicable, shall be supplied in erectable condition i.e., no rubber lining to be done at Site), instruments, valves, supports, gaskets, fasteners and accessories which is integral to Gypsum Dewatering Equipment – One (1) set* which is broadly defined below:

- a. Slurry piping from Primary hydro cyclones underflow to Vacuum Belt Filters
- b. Filtrate piping from Vacuum belt filters to Vacuum receivers and further up to the extraction pumps discharge.
- c. Air piping from vacuum receivers to vacuum pumps to atmosphere
- d. RESERVE
- e. Process water and clarified water piping from TP outside building to wash tanks.
- f. Instrument air piping from TP outside building up to equipment related to the system

(ii) Scope of below-mentioned interconnected piping (slurry, air and water pipes) along with valves, rubber lining (wherever applicable), instruments, valves, supports, gaskets, fasteners and accessories which is non-integral to Gypsum dewatering equipment is **limited to engineering only** and supply shall be made by BHEL. Engineering in bidder's scope includes layout & routing of pipes, preparation of isometric drawing and BOQ:

- a. Primary hydro cyclone feed tank outlet to the inlet flange of Primary hydro cyclones along with recirculation piping to feed tank
- b. Primary hydro cyclones over flow to Inlet of secondary hydro cyclone feed tank
- c. Secondary hydro cyclone feed tank outlet to inlet flange of secondary hydro cyclones along with recirculation piping to feed tank
- d. Secondary hydro cyclones underflow to filtrate tank
- e. Secondary hydro cyclones overflow to inlet flange of wastewater tank
- f. Vacuum receiver drain through filtrate extraction pumps (bidder scope) to Filtrate tank and other associated drain of vacuum belt filters to filtrate tank
- g. overflow and drain piping of cake wash tanks and cloth wash tanks.

THIS IS PART OF TECHNICAL SPECIFICATION PE-TS-468-571-A901 REV 00.

	NSPCL BHILAI (2X250MW)	SPECIFICATION No: PE-TS-468-571-A901	
	GYPSUM DEWATERING EQUIPMENT	SECTION : I	
	TECHNICAL SPECIFICATION	SUB-SECTION : C1	
	SPECIFIC TECHNICAL REQUIREMENT	REV. 00	
		SHEET 5 OF 19	

2.1.1.10 Instruments/Valves for the entire gypsum dewatering equipment including integral piping as defined at 2.1.1.9 above (minimum requirement for each gypsum dewatering equipment is given in the P&ID): One (1) set*

2.1.1.11 Electrical part includes but not limited to

- i. Local control panel, if required
- ii. LV, HT Motors (as applicable)
- iii. Junction Box
- iv. Instruments
- v. Push buttons

2.1.1.12 Expansion Joints at suction and discharge of each pump/other equipment, as applicable: One (1) Set*

2.1.1.13 All motors shall be provided with suitable double compression cable gland.

Sizes of cables shall be informed by BHEL during detail engineering. Bidder to provide suitable gland with respect to sizes of cables.

Bidder shall provide cable glands and lugs for all equipment in his scope. Cables shall be terminated using double compression type cable glands and solder less crimping type tinned copper cable lugs.

Bidder shall provide junction box. The Junction box shall have provision for installing glands of suitable size on the bottom of the box.

2.1.1.14 Control System: Control system shall be DDCMIS/ DCS, which shall be BHEL scope. Each equipment shall be furnished with required instrumentation and electrical accessory devices mounted and connected to a junction box.

2.1.1.15 **SIGNALS [Refer Electrical/C&I portion/ P&IDs of this specification, as well]**

Bearing Temperature Transmitter for initiating alarm during when "Bearing temperature high" shall be supplied by Bidder. Bearing temperature transmitter shall be provided with local display also. Bearing temperature transmitter (with 2V3 logic) shall be provided for HT motors (> 200 KW) at both the driving and non-Driving ends. Similarly, Vibration transmitters (with 2V3 logic) for measuring vibration in X & Y axis have to be provided for at the driving and Non-driving end for HT Motors (if applicable).

Interlock signal:

- a) Belt filter wash tank level low.
- b) Cake wash tank level low.

These details shall be confirmed with BHEL during detail engineering.

2.1.1.16 Lubricants & Consumables: All the first fill and one year's toppings requirements of consumables such as grease, oil, lubricants, servo fluids etc. which will be required to put the equipment covered under the scope of specifications into successful commissioning/initial

	NSPCL BHILAI (2X250MW)	SPECIFICATION No: PE-TS-468-571-A901	
	GYPSUM DEWATERING EQUIPMENT	SECTION : I	
	TECHNICAL SPECIFICATION	SUB-SECTION : C1	
	SPECIFIC TECHNICAL REQUIREMENT	REV. 00	
		SHEET 6 OF 19	

operation and to establish completion to facilities should be provided by contractor/supplier. Refer Clause 7.0 of this sub-section for details.

- 2.1.1.17 Painting and rust prevention during shipment and construction.
- 2.1.1.18 Seaworthy packing & forwarding to project site. Refer project information specified elsewhere in the specification. This is applicable where the equipment is coming through sea route. Otherwise, packing specification of equipment of Indian origin will be followed.
- 2.1.2 Services to be provided by the bidder:
- (i) Detailed Erection and commissioning procedure shall be submitted by successful bidder for carrying out the erection and commissioning at site by BHEL.
- (ii) Supervision for Erection & Commissioning, trial run at site
- (iii) Performance guarantee tests at site & handover in flawless condition of the package to the customer
- (iv) training of customer/ client O&M staff covering all aspects of the GDWE- Operation & Maintenance (6 days) at Site
- (v) Training of customer at manufacturer's works (6 man-days) including lodging and boarding
- (vi) Visits shall be planned by BHEL site team and prior intimation shall be sent to supplier for visit to site for supervision services. Bidder shall be informed at least 10 days in advance for the requirement of visit at site. Visiting team shall consist of one or two expert of bidder as deemed necessary by them.
- 2.1.3 Mandatory spares as defined as Annexure-II, Sub Section-D of Section I.
- 2.1.4 Recommended spare parts list to be furnished (is not part of scope of supply)
- 2.1.5 Any other items required not covered above but required for the completeness of the equipment/system; it shall be included in the offer and shall be supplied by the Bidder/supplier. Bidder shall refer to the P&ID enclosed in Annexure-IV, Sub-Section-D of Section-I for the items under the bidder's scope. All the items indicated in the P&ID are minimal requirements.

2.2	PROCESS DESCRIPTION
1.	Common gypsum dewatering equipment is envisaged for all two units. The dewatering equipment shall receive the gypsum slurry from Primary Hydro cyclone feed pumps (BHEL Scope). Gypsum dewatering equipment shall be suitable for handling slurry from all two FGD units. Two sets of primary hydrocyclone (1W+1S) with accessories shall be in vendor scope. Primary hydrocyclone underflow shall be taken to Vacuum Belt Filter (VBF) inlet.
2.	The overflow from the primary sets of hydro-cyclone shall be taken to a secondary hydro-cyclone feed tank (BHEL Scope). Secondary Hydro cyclone feed pumps (BHEL Scope) shall transfer the slurry from tanks to secondary hydro cyclone. Two sets of Secondary hydro cyclones (1 working+1 stand by) and its accessories shall be in vendor scope.

	NSPCL BHILAI (2X250MW)	SPECIFICATION No: PE-TS-468-571-A901	
	GYPSUM DEWATERING EQUIPMENT	SECTION : I	
	TECHNICAL SPECIFICATION	SUB-SECTION : C1	
	SPECIFIC TECHNICAL REQUIREMENT	REV. 00	
		SHEET 7 OF 19	

3.	The underflow from the secondary hydro-cyclone shall be taken to the filtrate water tank. The over flow from the secondary hydro-cyclone shall be taken to a waste water storage tank.
4.	Two nos. of belt filter wash tanks & Two nos. of cake wash tanks along with rubber lining (BHEL Scope) are envisaged for both the belt filters. Each tank shall be provided with 2 nos. of pumps of suitable requirement.

2.3 TERMINAL POINTS	
1.	Primary hydro cyclone feed slurry will be provided by BHEL at the inlet flange of the primary hydro cyclone.
2.	Primary hydro cyclone overflow launder outlet flange. Further piping by BHEL to secondary hydrocyclone feed tank.
3.	Secondary hydro cyclone feed slurry will be provided by BHEL at the inlet flange of secondary hydro cyclone.
4.	Secondary hydro cyclone underflow launder outlet flange and overflow launder outlet flange. Further piping by BHEL to waste water and filtrate tank.
5.	Outlet at filtrate extraction pumps discharge expansion joints and TP near VBF for other drain of such as cloth wash, dyke drain etc.
6.	Process water, Clarified water & instrument air will be provided at one location, located at 5 m from building boundary. Further piping from terminal point to GDW equipment utilities are in bidder's scope.
7.	Discharge of Gypsum through discharge chute onto the gypsum belt conveyor is in bidder's scope. Please refer enclosed P&IDs, typical layout & preliminary elevation drawing of GDW building for the details in the scope.

2.4 For Electrical scope, refer Electrical specification (Sub-section- C3 of Section-I).

2.5 For Control & Instrumentation (C&I) scope, refer C&I specification (Sub-section- C4 of Section-I).

3.0 CODES & STANDARDS AND OTHER REQUIREMENTS

3.1 The design and manufacturing of vacuum belt filter shall follow the latest applicable Indian / International (ASME / EN /Japanese) Standards.

3.2 The performance tests shall be carried out in accordance with ASME PTC 40 (2017) code.

3.3 In addition to the codes and standards specifically mentioned in the relevant technical specifications for the equipment / plant / system, all equipment parts, systems and works covered under this specification shall comply with all currently applicable statutory regulations and safety codes of the Republic of India as well as of the locality where they will be installed, including the following:

- a) Indian Electricity Act
- b) Indian Electricity Rules
- c) Indian Explosives Act
- d) Indian Factories Act and State Factories Act
- e) Indian Boiler Regulations (IBR)
- f) Regulations of the Central Pollution Control Board, India
- g) Regulations of the Ministry of Environment & Forest (MoEF), Government of India
- h) Pollution Control Regulations of Department of Environment, Government of India
- i) State Pollution Control Board.

	NSPCL BHILAI (2X250MW)	SPECIFICATION No: PE-TS-468-571-A901	
	GYPNUM DEWATERING EQUIPMENT	SECTION : I	
	TECHNICAL SPECIFICATION	SUB-SECTION : C1	
	SPECIFIC TECHNICAL REQUIREMENT	REV. 00	
		SHEET 8 OF 19	

- (j.) Rules for Electrical installation by Tariff Advisory Committee (TAC).
- (k.) Building and other construction workers (Regulation of Employment and Conditions of services) Act, 1996
- (l.) Building and other construction workers (Regulation of Employment and Conditions of services) Central Rules, 1998
- (m.) Explosive Rules, 1983
- (n.) Petroleum Act, 1984
- (o.) Petroleum Rules, 1976,
- (p.) Gas Cylinder Rules, 1981
- (q.) Static and Mobile Pressure Vessels (Unified) Rules, 1981
- (r.) Workmen's Compensation Act, 1923
- (s.) Workmen's Compensation Rules, 1924
- (t.) Safety Rules for Construction and Erection
- (u.) Safety Policy
- (v.) Any other statutory codes / standards / regulations, as may be applicable.

3.4 Unless covered otherwise in the specifications, the latest editions (as applicable as on date of bid opening), of the codes and standards given below shall also apply:

- a) Bureau of Indian standards (BIS)
- b) Japanese Industrial Standards (JIS)
- c) American National Standards Institute (ANSI)
- d) American Society of Testing and Materials (ASTM)
- e) American Society of Mechanical Engineers (ASME)
- f) American Petroleum Institute (API)
- g) Standards of the Hydraulic Institute, U.S.A.
- h) International Organization for Standardization (ISO)
- i) Tubular Exchanger Manufacturer's Association (TEMA)
- j) American Welding Society (AWS)
- k) National Electrical Manufacturers Association (NEMA)
- l) National Fire Protection Association (NFPA)
- m) International Electro-Technical Commission (IEC)
- n) Expansion Joint Manufacturers Association (EJMA)
- o) Heat Exchange Institute (HEI)
- p) IEEE standard
- q) JEC standard

3.5 Other International/ National standards such as DIN, VDI, BS, GOST etc. shall also be accepted for only material codes and manufacturing standards, subject to the BHEL Customer's approval, for which the bidder shall furnish, adequate information to justify that these standards are equivalent or superior to the standards mentioned above. In all such cases, the bidder shall furnish specifically the variations and deviations from the standards mentioned elsewhere in the specification together with the complete word-to-word translation of the standard that is normally not published in English.

3.6 Two (2) English language copies of all national and international codes and/or standards used in the design of the plant and equipment shall be provided by the Contractor to the Employer within two calendar months from the date of the Notification of Award.

	NSPCL BHILAI (2X250MW)	SPECIFICATION No: PE-TS-468-571-A901	
	GYPSUM DEWATERING EQUIPMENT	SECTION : I	
	TECHNICAL SPECIFICATION	SUB-SECTION : C1	
	SPECIFIC TECHNICAL REQUIREMENT	REV. 00	
		SHEET 9 OF 19	

- 3.7 In case of any change in codes, standards & regulations between the date of bid opening and the date when vendors proceed with fabrication, the BHEL shall have the option to incorporate the changed requirements or to retain the original standard. It shall be the responsibility of the Contractor to bring to the notice of BHEL such changes and advise BHEL of the resulting effect.

4.0	DETAILED TECHNICAL SPECIFICATION
4.1	DETAILED SPECIFICATION
4.1.1	Bidder shall supply two stage Gypsum Dewatering Equipment (GDWE) consisting of primary hydro cyclones, vacuum belt filters (VBF) and secondary hydro cyclones for dewatering of gypsum from absorber to less than 10% moisture at the design capacity specified elsewhere in the specification.
4.1.2	Bidder shall supply 2x100% Gypsum Dewatering Equipment with each stream sized to dewater 17 TPH (Wet cake) at outlet of VBF produced by the all two FGD units operating at design point. All other stipulations with respect to sizing and design of the dewatering equipment, auxiliaries and other systems shall be in line with this specification.
4.2	Hydro-cyclones
4.2.1	Two (2) sets of primary hydro cyclones are envisaged, each set shall be sized to dewater the gypsum slurry produced by the unit operating at design point.
4.2.2	Each set of primary hydro-cyclone shall be provided with 10% spare hydro-cyclones. The capacity defined in the previous clause shall be met with spare hydro-cyclones out of service.
4.2.3	The primary hydro-cyclone shall be installed directly above the belt filters. The overflow of the primary hydro-cyclones shall be taken to secondary hydro-cyclone feed.
4.2.4	Two (2) sets of secondary hydro cyclones are to be installed, each set shall be sized to dewater the gypsum slurry produced by all two FGD units operating at design point.
4.2.5	Both primary and secondary hydro-cyclones shall be of modular construction. It shall be possible to remove and replace individual hydro-cyclone with the set in service. Individual isolation valve shall be provided for each hydro-cyclone for this purpose.
4.2.6	The hydro-cyclone shall be of proven design and shall be provided with replaceable rubber lining. The feed chamber, overflow and underflow chamber shall be made of carbon steel of adequate thickness with a rubber lining of minimum 12 mm thickness. Liners shall have a minimum wear life of not less than 7000 hours .
4.2.7	All Hydro Cyclones clusters shall be made of polyurethane or urethane material only.
4.3	Vacuum Belt Filters
4.3.1	Two (2) numbers of vacuum belt filters each of capacity 17 TPH (Wet cake) at the outlet of each VBF are envisaged. Each vacuum belt filter shall be sized to meet the following requirements, all occurring together, with an inlet solid concentration of not more than 45% or outlet of hydro-cyclones whichever is minimum: <ul style="list-style-type: none"> ▪ Outlet Moisture: 10% (maximum) ▪ Chloride content: 100 ppm (max) ▪ Gypsum Purity: 90% (minimum) – by BHEL
4.3.2	The Vacuum Belt Filters shall have the following characteristics: <ol style="list-style-type: none"> a) Very rigid frame and rolls, no deformation whatsoever may occur. b) All rolls shall be installed perfectly horizontally c) There shall be no vacuum under the slurry deposition zone. d) Deposit thickness control and directional stability control

THIS IS PART OF TECHNICAL SPECIFICATION PE-TS-468-571-A901 REV 00.

	NSPCL BHILAI (2X250MW)	SPECIFICATION No: PE-TS-468-571-A901	
	GYPSUM DEWATERING EQUIPMENT	SECTION : I	
	TECHNICAL SPECIFICATION	SUB-SECTION : C1	
	SPECIFIC TECHNICAL REQUIREMENT	REV. 00	
		SHEET 10 OF 19	

	<p>e) The slurry shall be put on the belt in counter current relative to the rotation of band.</p> <p>f) The vacuum chambers shall be easily opened for inspection and cleaning.</p>
4.3.3	<p>The vacuum belt filter shall be proven design in operation for similar capacities. The filter cloth shall be polyester or polypropylene as per the proven design of the supplier and shall be guaranteed for a minimum life of not less than 7000 hours.</p> <p>Specification requirement for filter cloth is of minimum life of 7000 hours. In case the bidder does not stand guarantee for specified life, they shall supply additional sets of filter cloth(s) to meet the cumulative life of 7000 hours. The same is applicable for main as well as mandatory spares and shall be supplied along with main supplies and mandatory spares.</p>
4.3.4	<p>The complete frame of the filter and all parts in contact with gypsum shall be made of corrosion resistant material or shall be provided with corrosion resistant liners of proven design.</p> <p>The complete frame of the filter and all parts in contact with gypsum shall be made of corrosion resistant material or shall be provided with corrosion resistant liners of proven design. Accordingly, bidder may consider 'Corten / Weathering Steel' or 'SS 304' or any other suitable corrosion resistant material conforming to ASTM A606-4, A588, A847 etc. as applicable. The material so selected, should be meeting the strength requirement of the belt filter.</p>
4.3.5	<p>In case, the contractor offers a design with an underlying belt for carrying the filter cloth, the same shall be endless, factory vulcanized rubber belts. The belt shrouds and the sealing belts shall provide a leak tight arrangement to prevent overflow of gypsum slurry. The sealing belt shall have minimum life of not less than 7000 hours.</p> <p>Specification requirement for wear belt is of minimum life of 7000 hours. In case the bidder does not stand guarantee for specified life, they shall supply additional sets of wear belt(s) to meet the cumulative life of 7000 hours. The same is applicable for main as well as mandatory spares and shall be supplied along with main supplies and mandatory spares.</p>
4.3.6	<p>The vacuum box shall ensure tight sealing with the belt/cloth and shall be of proven design.</p>
4.3.7	<p>The belt filter shall have an automatic cloth tracking mechanism and shall be provided with all required instrumentation as per the bidder's proven practice. The belt filter shall have an automatic cloth tensioning mechanism. Pull chord switches shall be provided for each vacuum belt filter. Four (04) no.'s of Belt sway switches shall be provided for each vacuum belt filter. Cake thickness sensors with double redundancy shall be provided for each vacuum belt filter which shall control the speed of the vacuum belt filter in turn.</p>
4.3.8	<p>Differential Pressure indicator shall be provided at the discharge line of Belt filter wash Pump for each vacuum Belt filter. Flow indicator shall be provided for cloth washing line of each vacuum belt filter. Flow indicator shall be provided for cake washing line of each vacuum belt filter as per P&ID enclosed.</p>
4.3.9	<p>The filter shall be provided with minimum 2 stages of cake washing for removing impurities in the gypsum. One stage of cloth washing arrangement shall also be provided.</p>
4.3.10	<p>The filtrate from gypsum slurry and from cake washing shall be taken to a separate vacuum receiver tank(s) as per the proven practice of the supplier. Each belt filter shall have an independent vacuum pump.</p>
4.3.11	<p>Gypsum cake from each belt filter shall be discharged through a hopper onto belt conveyor being provided by the Employer. Hopper means discharge chute only, Gypsum cake from each belt filter shall be discharged through a chute arrangement onto belt conveyor indicated in GA drawing.</p>
4.3.12	<p>A 2 m (min.) wide platform shall be provided around each belt filter for easy approach & maintenance or it may provide a common platform of 3.3m (approx.) width. In case,</p>

THIS IS PART OF TECHNICAL SPECIFICATION PE-TS-468-571-A901 REV 00.

	NSPCL BHILAI (2X250MW)	SPECIFICATION No: PE-TS-468-571-A901	
	GYP SUM DEWATERING EQUIPMENT	SECTION : I	
	TECHNICAL SPECIFICATION	SUB-SECTION : C1	
	SPECIFIC TECHNICAL REQUIREMENT	REV. 00	
		SHEET 11 OF 19	

	common platform for HBF is provided as mentioned above, a movable platform along with access ladder shall be provided for approaching equipment/item on other side of HBF. The elevation of discharge point of vacuum belt filter shall be as per the Gypsum Dewatering Building Drawing provided in the Annexure-IV Sub Section-D of Section-I. Any changes for optimization of the layout shall be suggested by Bidder accordingly.
4.3.13	The service factor of the gear unit (if any) shall be minimum 1.5.
4.3.14	Piping and wiring within the skid should be in the vendor's scope.
4.3.15	All client end connection flanges shall be ANSI B 16.5/AWWA.
4.4	Vacuum System
4.4.1	The filtrate from each belt filter, cake washing & cloth washing shall be taken to separate receiver tank(s) as per the supplier's proven practice. Each belt filter shall be provided with an independent vacuum pump sized to meet the requirements of the belt filter operating at its maximum capacity. An additional 10% margin over the above shall be provided in each vacuum pump.
4.4.2	Each Vacuum pump shall have its own piping system, which connects the pump with the associated vacuum belt filter. Bidder to provide Equipment layout & General Arrangement (GA) of the Components in Gypsum dewatering building along with the offer.
4.4.3	The vacuum pump shall be of low speed liquid ring type of proven design. The design of the vacuum pumps shall avoid cavitation under all operating conditions.
4.4.4	The seals shall be of proven design.
4.4.5	Silencers shall be provided, if required, to limit the noise level to values stipulated elsewhere in this specification.
4.4.6	The vacuum receiver and pump internals shall be suitably lined to protect against the corrosive environment. The material selected for vacuum pumps & vacuum receivers shall be proven for similar application and shall be subject to approval of BHEL/NSPCL.
4.4.7	Each vacuum receiver tank(s) shall be provided with slide plate type pneumatic vacuum breaker. The plate shall be stainless steel with a min. thickness of 3 mm.
4.4.8	The filtrate extraction pump shall be capable of pumping filtrate water with solid concentration of not less than 10% and particle lumps of 6-7 mm. A 10% margin shall be provided in each of the pump.
4.5	COMMON REQUIREMENTS FOR PUMPS (VACUUM PUMP, FILTRATE BELT FILTER, CAKE WASH)
4.5.1	All the pump wear parts in contact with the slurry shall be provided with replaceable rubber/elastomer liners suitable for the fluid handled. The Bidder can also offer a hi-chrome alloy line pump if the Bidder has previous experience of the same for similar applications. The material used by the contractor shall be proven in previous installations.
4.5.2	All the slurry pumps shall be provided with motorized suction and discharge valves. As per bidder's proven practice, pneumatic can be provided. In addition, flushing water lines with motorized/ pneumatic valves shall be provided for each pump for automatic flushing of the pump after each shut down. The flushing water for the pumps shall be taken from the process water supply. The process water lines shall be provided with pneumatic/motorized valves as per the proven practice of the Bidder.
4.5.3	The pump shall be provided with seals of proven type and shall be designed for minimization of seal water consumption. The shaft shall be supported on heavy-duty ball/roller bearings.
4.5.4	All pumps shall be designed to withstand a test pressure of 1.5 times the maximum possible pump shut off pressure under maximum suction pressure conditions.

THIS IS PART OF TECHNICAL SPECIFICATION PE-TS-468-571-A901 REV 00.

	NSPCL BHILAI (2X250MW)	SPECIFICATION No: PE-TS-468-571-A901	
	GYP SUM DEWATERING EQUIPMENT	SECTION : I	
	TECHNICAL SPECIFICATION	SUB-SECTION : C1	
	SPECIFIC TECHNICAL REQUIREMENT	REV. 00	
		SHEET 12 OF 19	

4.5.5	Product water flushing lines and drains are to be supplied for each pump handling the prevailing water to avoid corrosion if the pump is out of operation for extended periods.
4.5.6	Pumps must be carefully set to ensure that the net positive suction head available under all operating conditions will be adequate. The NPSH Values are to be referred to the least favorable operating conditions- lowest atmospheric pressure, lowest level of water on the suction side of the pump and highest temperature of the pumped fluid. An adequate safety margin of normally greater than 1 m to the max NPSH required shall be provided.
4.5.7	All pumps shall be fitted with suction and discharge pressure gauges. Pressure gauges shall be with diaphragm seal for slurry application. Pressure gauges for other medium shall be with gate valves. All the wetted parts shall be SS 316 or equivalent.
4.5.8	Venting valve shall be fitted to all pumps at suitable points on the pump casing unless the pump is self-venting due to the arrangement of the suction and discharge nozzles. Drainage facilities shall be provided on the pump casing or adjacent pipe work to facilitate the dismantling of pumps.
4.5.9	Design pumps not to be damaged during reverse rotation at up to 150% of design RPM, at full discharge head in the event that a pump trips while the other operating pump remain on line.
4.5.10	Pumps shall have stable head-capacity characteristics curve from run-off to shut-off. Shut-off head should be 115% of Best Efficiency Point (BEP).
4.5.11	Selection of Duty point should preferably be at BEP (Best Efficiency Point) or slightly at the left of BEP. Selection of Duty point beyond 115% of BEP will not be acceptable. It should be noted that head variation is due to level variation in tank. Pump has to run in the system without compromising its NPSH requirement at lowest water level in tank. Hence, when tanks are filled-up and are at normal water level, pump will operate at the right of BEP, pump's operating zone should be considered accordingly.
4.5.12	External flushing is required to remove the accumulated particles and all related information should be mentioned in datasheet.
4.5.13	Pump should have adjustment provision of axial clearance between casing and impeller for maintenance of performance at best efficiency when there is wear in between impeller and casing.
4.5.14	In case rubber or nonmetallic linings are used, these will be two piece molded under pressure and adjusted to the screwed metallic clamping which have been welded to the casting.
4.5.15	Each pump will have a coupling of adequate size, designed for full load and capable of supporting start –up on overload moments. Each half of the coupling will be factory mounted and locked to its shaft. The coupling must be able to accept the adjustment of the impeller.
4.5.16	The pumps shall have mechanical seals of cartridge type with self-lubrication sliding ring cartridges. The static part will be mounted on the seal plate with circumferential ring (O-ring) or another flexible sealing ring. Built in seal design will not be accepted.
4.5.17	The sealing areas shall be designed in such a way so that solids do not precipitate in them or affect the cooling or affect the adjustment and mechanical functioning of the seals. Seals which do not need jet cleaning are preferred.
4.5.18	Pump induced vibration due to flow pulsations shall be avoided through suitable design.
4.5.19	Each rotating equipment shall be first statically balanced and then dynamically balanced according to ISO 1940 (in the case of impellers this shall be done before and after mounting of the service rotor shaft).

THIS IS PART OF TECHNICAL SPECIFICATION PE-TS-468-571-A901 REV 00.

	NSPCL BHILAI (2X250MW)	SPECIFICATION No: PE-TS-468-571-A901	
	GYPSUM DEWATERING EQUIPMENT	SECTION : I	
	TECHNICAL SPECIFICATION	SUB-SECTION : C1	
	SPECIFIC TECHNICAL REQUIREMENT	REV. 00	
		SHEET 13 OF 19	

4.5.20	The material and thickness of the liners of slurry pumps (Filtrate Extraction pumps) shall ensure a minimum service life of 2 years before replacement. All the wear parts of the pump shall be guaranteed for a minimum wear life of not less than 14000 hours.
4.5.21	Coupling halves shall be machine matched to ensure accurate alignment. Couplings must have a rated capacity of at least 120% of the maximum potential power transmission requirement.
4.5.22	All rotating parts such as coupling shall be covered with suitable protective guards. Guards shall be easily removable type. Coupling shall be of flexible type made of cast steel. The bidder shall furnish both halves of the coupling. Both the Coupling halves shall be bored and keyed to fit shafts of the pump and the motor by bidder. The coupling between shafts shall be so designed that they become tight during pump operation.
4.5.23	A common base plate shall be provided for pump assembly & Motor and the same shall be rigidly constructed, adequately braced and provided with finish pads for mounting pump.
4.5.24	Pump manufacturer is to supply base plate along with Foundation bolt & Nut, "Taper wedge" and the necessary fastener for Pump and Motor with Base plate.
4.5.25	Nameplate: All equipment shall be provided with name plates indicating the item number and service name. Nameplates shall be of 304 Stainless steel plate and placed at a readily visible location. Nameplate of main equipment shall have enough information, which will be confirmed during engineering phase. Stainless steel nameplates for all instruments and valves shall be provided.
4.5.26	Rotation arrows shall be cast in or attached with stainless steel plate on each item of rotation equipment at a readily visible location.
4.5.27	Unless otherwise specified, all equipment items where the weight exceeds 15 kg shall be provided with suitable lifting lugs, ears or ring bolts or tapped holes for lifting rings. Minimum shock factor for lifting lugs shall be 2.0. The position of lifting lugs and reference dimension shall be shown on GA and/or outline drawings. NDT shall be conducted for lifting lugs. When any spreader bars are required for lifting and laydown, the bidder shall provide spreader bar with equipment.
4.5.28	Skid Mount/Transportation: Equipment shall be fabricated as skid mount design as much as practical to minimize erection at the site.
4.5.29	Two pieces of stainless-steel earth lugs shall be provided with equipment diagonally. The position of earth lugs shall be shown on each GA and/or outline drawing.
4.5.30	Provide double nuts for anchor bolts.
4.5.31	Bidder shall provide allowable vibration level on foundation in foundation drawings and/or general arrangement drawings.
4.5.32	If the driver/driven equipment train is in the resonance condition or any vibration problems occur, the bidder shall solve the problems in a timely manner.
4.5.33	Bidder shall provide the mating flanges with the necessary gaskets.
4.5.34	All the surfaces of the carbon steel should be rust prevented before shipment for the period of at least 12 months for storage and construction.
4.5.35	Bidder to provide capacity of crane or hoist required for safe material handling and the details of heaviest component to be handled.
4.5.36	Bidder to provide Pipe & Valve Material as per the Annexure VIII, Sub-Section-D, Section-I of the Specification.
4.5.37	A 1000 mm wide platform with suitable approach shall be provided by the bidder for each hydro cyclone.
4.5.38	A 1500 mm space around all the pumps shall be provided by the bidder.

THIS IS PART OF TECHNICAL SPECIFICATION PE-TS-468-571-A901 REV 00.

	NSPCL BHILAI (2X250MW)	SPECIFICATION No: PE-TS-468-571-A901	
	GYPSUM DEWATERING EQUIPMENT	SECTION : I	
	TECHNICAL SPECIFICATION	SUB-SECTION : C1	
	SPECIFIC TECHNICAL REQUIREMENT	REV. 00	
		SHEET 14 OF 19	

4.5.39	Equipments requiring monitoring during regular operation shall be approachable from the ground floor through staircase. Staircase with minimum width of 1200 mm shall be provided for approach to elevated structures at 5 m height from the nearest platform. Below this height, a vertical ladder with minimum clear width of 600 mm may also be acceptable.
4.5.40	The list of all Bought out items with makes and country of origin and contact details of the manufacturers to be mentioned along with offer to be submitted. Acceptance of makes shall be subject to BHEL's Customer's acceptance during the detailed engineering without cost and delivery implication to BHEL.

5.0	PIPING & INSTRUMENTATION DIAGRAMs (P&IDs)
------------	--

The Piping & Instrumentation Diagram are enclosed in in Annexure-IV, Sub-Section-D of Section-I.

5.1 PROCESS PARAMETERS FOR PRIMARY HYDROCYCLONE - OPERATION POINT					
Sl. No.	Parameters	Primary Cyclone Slurry	Hydro Feed	Primary Hydro Cyclone Over Flow	Primary Hydro Cyclone Under Flow
a.	Total Flow (m ³ /hr.)	54.2		31.32 (*1)	23 (*1)
b.	Total Flow (t/hr.)	65.8		34.8 (*1)	31.1 (*1)
c.	Operating Temp (C)	62		62	6
d.	Design Temp (C)	70		70	70
e.	Solid (wt. %)	30		16.6 (*1)	> 45 (*2)
f.	Density (Kg/m ³)	1213		1109 (*1)	1355 (*1)
g.	pH	4-7		4-7	4-7
h.	Cl (mg/l)	<19000		<19000	<19000
5.2 PROCESS PARAMETERS FOR SECONDARY HYDROCYCLONE - OPERATION POINT					
Sl. No.	Parameters	Secondary Hydro cyclone – Feed Slurry	Secondary Hydro cyclone– Overflow	Secondary Hydro cyclone – Under flow	
a.	Total flow (m ³ /hr)	31.32 (*1)	19.6 (*1)	11.8 (*1)	
b.	Total flow (t/hr)	34.8 (*1)	20 (*1)	14.8 (*1)	
c.	Operating Temp (°C)	62	62	62	
d.	Design Temp (°C)	70	70	70	
e.	Solid (% wt.)	16.6 (*1)	3 (*2)	35 (*1)	
f.	Density (kg/m ³)	1109 (*1)	1020	1257	
g.	pH	4-7	4-7	4-7	
h.	Cl (mg/l)	<19000	<19000	<19000	
5.3 DATA SHEET OF BELT FILTER - OPERATION POINT					
Sl. No.	Parameters	Belt Filter Feed Slurry	Product Gypsum	Filtrate	Washing Water **
a.	Total Flow (m ³ /hr)	23 (*1)			
b.	Total Flow (t/hr)-Wet	31.1 (*1)	15.43		
c.	Design Temp (°C)	70.0			
d.	Solid (% wt.)	>45 (*2)	>90 (*2)	<0.2	
e.	Density kg/m ³	1355 (*1)			

THIS IS PART OF TECHNICAL SPECIFICATION PE-TS-468-571-A901 REV 00.



NSPCL BHILAI (2X250MW)
GYPSUM DEWATERING EQUIPMENT
TECHNICAL SPECIFICATION
SPECIFIC TECHNICAL REQUIREMENT

SPECIFICATION No: PE-TS-468-571-A901	
SECTION : I	
SUB-SECTION : C1	
REV. 00	
SHEET 15 OF 19	

f.	pH	4~7	5~8		
g.	Cl	<19000	<100 ppm (*2)		
h.	Belt filter and the peripherals shall be designed at 17 TPH (wet cake) discharge of product gypsum a. **Quantity of water shall be finalized by the vendor. Property of process water & Clarified water is given below.				
i.	(*1) shall be finalized by vendor. (*2) Shall be guaranteed by vendor.				

5.4 GYPSUM PARTICLE SIZE AT HYDRO CYCLONE FEED SLURRY IS SHOWN BELOW:

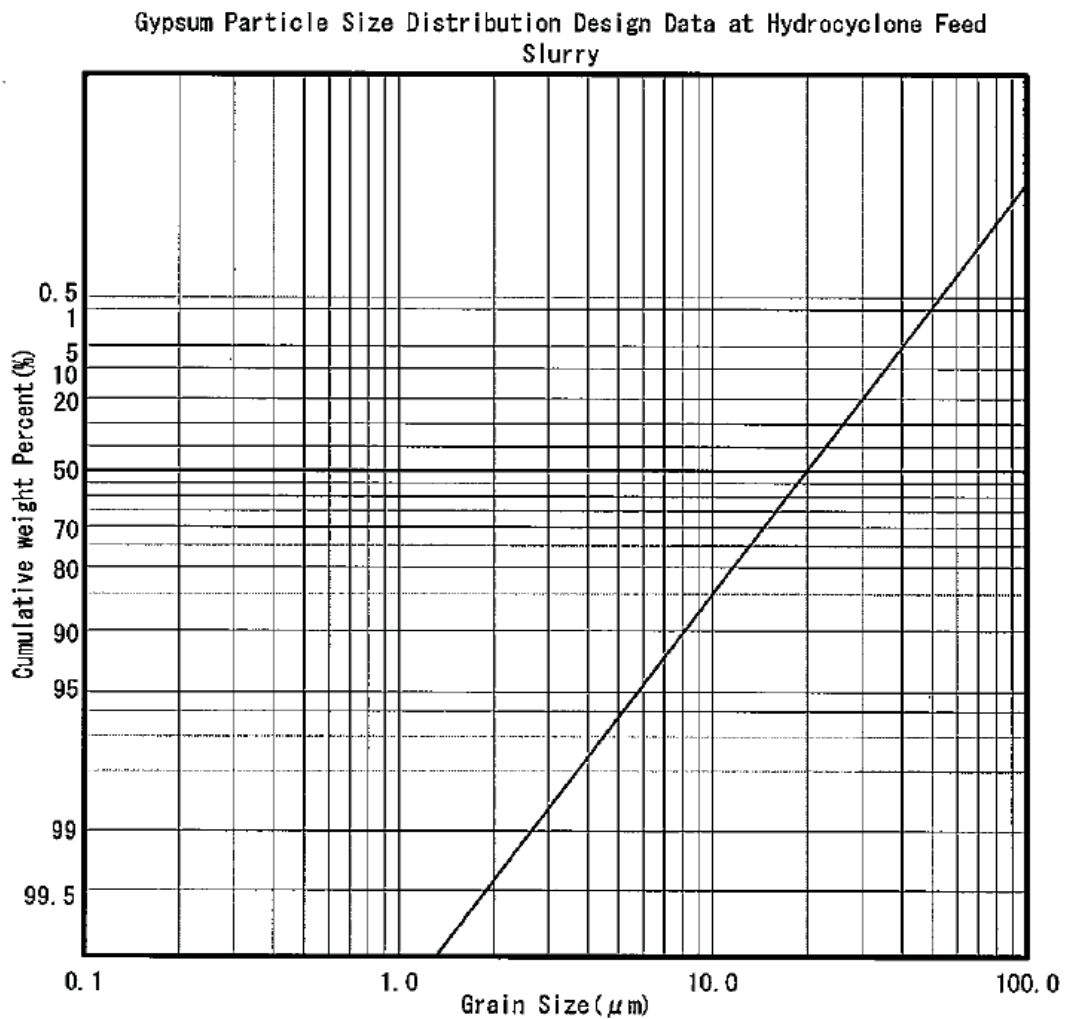

Note:

1. Vendor to submit the PSD based on their design for PHC & SHC underflow and overflow
2. Hydro cyclone backpressure shall not exceed 20m H
3. Gypsum particle size distribution (PSD) to be used for designing Hydrocyclones and Vacuum Belt Filter shall be as per the PSD curve provided in the tender specification. All guarantees of Gypsum dewatering equipment performance shall be met by bidder as per the provided PSD only. The PSD curve provided in the technical specification is a standard curve and the Vacuum Belt Filter based on the same are running successfully.

THIS IS PART OF TECHNICAL SPECIFICATION PE-TS-468-571-A901 REV 00.



NSPCL BHILAI (2X250MW)
GYPSUM DEWATERING EQUIPMENT
TECHNICAL SPECIFICATION
SPECIFIC TECHNICAL REQUIREMENT

SPECIFICATION No: PE-TS-468-571-A901

SECTION : I

SUB-SECTION : C1

REV. 00

SHEET 16 OF 19

5.5	GYPSUM PARTICLE SIZE AT BELT FILTER FEED SLURRY:		
	Vendor to submit PSD graph design data at VBF inlet / PHC outlet.		
5.6	DESIGN CONDITIONS OF PRIMARY & SECONDARY HYDRO CYCLONES:		
1	Primary Hydrocyclone quantity	:	2 sets (1W+1SB)
2	Secondary Hydrocyclone quantity	:	2 sets (1W+1SB)
3	Primary Hydrocyclone capacity	:	60 m ³ /hr each
4	Secondary Hydrocyclone capacity	:	32 m ³ /hr each
5	Type of Hydrocyclone	:	Vertical
6	Material (MOC) of Cyclone Clusters	:	Polyurethane/Urethane
7	MOC of Feed Chamber	:	CS+12 mm rubber lining
8	MOC of Overflow Chamber	:	CS+12mm rubber lining
9	MOC of Underflow Chamber	:	CS+12mm rubber lining
5.7	PROCESS WATER (USED FOR BELT WASHING) CHARACTERISTICS		
S.No.	Constituents	Unit	Water quality
1.	Calcium as CaCO ₃	ppm	190
2.	Magnesium as CaCO ₃	ppm	121
3.	Chlorides as CaCO ₃	ppm	110
4.	Sulphate as CaCO ₃	ppm	93.5
5.	Total alkalinity as CaCO ₃	ppm	297
6.	Iron as Fe	ppm	0.55
7.	Total Silica SiO ₂		38.5
8.	pH	NTU	7.5
9.	Turbidity	ppm	11
5.8	CLARIFIED WATER (USED FOR CAKE WASHING) CHARACTERISTICS		
S.No.	Constituents	Unit	Water quality
1.	Calcium as CaCO ₃	ppm	38
2.	Magnesium as CaCO ₃	ppm	22
3.	Chlorides as CaCO ₃	ppm	20*
4.	Sulphate as CaCO ₃	ppm	17
5.	Total alkalinity as CaCO ₃	ppm	54
6.	Iron as Fe	ppm	0.1
7.	Total Silica SiO ₂		07
8.	pH	NTU	7.5
9.	Turbidity	ppm	02

*As per the calculation using chemical formula, the chloride content is 14.18 ppm in the cake wash water. Bidder to confirm that Chloride (Cl) content shall be <100 PPM in final output gypsum.

THIS IS PART OF TECHNICAL SPECIFICATION PE-TS-468-571-A901 REV 00.

	NSPCL BHILAI (2X250MW)	SPECIFICATION No: PE-TS-468-571-A901	
	GYPSUM DEWATERING EQUIPMENT	SECTION : I	
	TECHNICAL SPECIFICATION	SUB-SECTION : C1	
	SPECIFIC TECHNICAL REQUIREMENT	REV. 00	
		SHEET 17 OF 19	

6.0	SPARES, TOOLS & TACKLES
6.1	START UP & COMMISSIONING SPARES
	<p>Start-up & Commissioning Spares shall be part of the main supply of the GDWE. Start-up & commissioning spares are those spares which may be required during the start-up and commissioning of the equipment/system. All spares required for successful operation till commissioning of GDWE shall come under this category. Bidder shall provide an adequate stock of such start-up and commissioning spares to be brought by him to the site for the equipment erection and commissioning. The spares must be available at Site before the equipment's are energized. List shall be furnished by bidder along with bid as indicated at Section-III.</p>
6.2	MANDATORY SPARES
	<p>a) The list of mandatory spares considered essential by the BHEL's Customer/Employer is indicated in Annexure-II of Sub Section-D of Section-I in the specification. The bidder shall indicate the prices for each and every item (except for items not applicable to the bidder's design) in the 'Schedule of Mandatory Spares' whether or not he considers it necessary for the Employer to have such spares. If the bidder fails to comply with the above or fails to quote the price of any spare item, the cost of such spares shall be deemed to be included in the contract price. The bidder shall furnish the population per unit of each item in their Bid. Whenever the quantity is mentioned in "sets", the bidder has to give the item details and prices of each item.</p> <p>b) Whenever the quantity is indicated as a percentage, it shall mean percentage of total population of that item in the station (project), unless specified otherwise, and the fraction will be rounded off to the next higher whole number. One set for the particular equipment. e.g. 'set' of bearings for a pump would include the total number of bearings in a pump. Also the 'set' would include all components required to replace the item; for example, a set of bearings shall include all hardware normally required while replacing the bearings.</p> <p>c) The assembly / sub assembly which have different orientation (like left hand, right hand, top or bottom), different direction of rotation or mirror image positioning or any other regions which result in maintaining two different sets of spares to be used for subject assembly / sub-assembly shall be considered as different type of assembly/sub-assembly.</p> <p>d) The prices of mandatory spares indicated by the Bidder in the Bid Proposal sheets shall be used for bid evaluation purposes.</p> <p>e) The Employer reserves the right to buy any or all the mandatory spare parts.</p> <p>f) Wherever quantity is specified both as a percentage and a value, the Bidder has to supply the higher quantity until & unless specified otherwise.</p> <p>Bidder to provide the split up price for mandatory spares during placement of order as per price format.</p>

THIS IS PART OF TECHNICAL SPECIFICATION PE-TS-468-571-A901 REV 00.

	NSPCL BHILAI (2X250MW)	SPECIFICATION No: PE-TS-468-571-A901	
	GYPSUM DEWATERING EQUIPMENT	SECTION : I	
	TECHNICAL SPECIFICATION	SUB-SECTION : C1	
	SPECIFIC TECHNICAL REQUIREMENT	REV. 00	
		SHEET 18 OF 19	

6.3	RECOMMENDED SPARES:
	In addition to the spare parts mentioned above, the bidder shall also provide a list of recommended spares for 3 years of normal operation of the plant and indicate the list. This list shall take into consideration the mandatory spares specified in this Sub-Section and should be independent of the list of the mandatory spares.
6.4	SPECIAL TOOLS & TACKLES:
	Any special tools & tackles required for the entire equipment to disassemble, assemble or maintain the units, they shall be included in the quotation and furnished as part of the initial supply of the machine. List of special tools & tackles shall be decided by bidder as per his proven practice. When special tools are provided, they shall be packaged in separate, boxes with lugs and marked as "Special Tools for (tag / item number)." Each tool shall be stamped or tagged to indicate its intended usage. Levers and eye bolts for the removal of parts to be serviced shall be submitted with special tools. List shall be furnished by bidder along with bid as indicated at Section-III.

7.0	FIRST FILL OF CONSUMABLES
------------	----------------------------------

7.1	Bidder's scope shall include supply and filling of all chemicals, lubricants, grease, filters and consumable items for operation up to commissioning including top up requirements. All lubricants proposed for the plant operation shall be suitable for all operating and environmental conditions that will be met on site consistent with good maintenance procedures as instructed in the maintenance manuals.
7.2	Bidder shall also supply a quantity not less than 10% of the full charge or One (1) year of top-up requirement (whichever is higher) of each variety of lubricants, servo fluids, gases, chemicals etc. (as applicable) used which is expected to be utilized during the first year of operation. This additional quantity shall be supplied in separate containers.
7.3	Detailed specifications for the lubricating oil, grease, gases, servo fluids, control fluids, chemicals including items qualities and quantities required per month of the plant operation for the Customer/BHEL's approval herein shall be furnished within 2 months of placement of Order. On completion of erection, complete list of bearings/equipment giving their location and identification marks shall be furnished to BHEL along with lubrication requirements. All types of chemicals, consumables, lubricants and grease shall be readily obtainable locally and the number of different types shall be kept to a minimum. For each type and grade of lubricant recommended, bidder shall list at least three equivalent lubricants manufactured by alternative companies.

8.0	LIST OF REFERENCE DRAWINGS BY BHEL
------------	---

The drawings specified in in Annexure-IV, Sub-Section-D of Section-I are being provided along with the tender specification for estimation and calculation purpose of the bidder.

9.0	PAINTS /PAINTING
------------	-------------------------

Bidder shall follow BHEL/ Customer painting philosophy specified in Sub-Section- C2-A (project specific general requirements) Section-I in the specification. Customer approved Painting Schedule (Drawing No. 9993-109-PVM-H-001) of FGD system package is provided. However, for components where no specific requirement is stipulated, the bidder shall follow its standard practice suitable for operating condition subject to customer approval during detail engineering.

THIS IS PART OF TECHNICAL SPECIFICATION PE-TS-468-571-A901 REV 00.

	NSPCL BHILAI (2X250MW) GYPSUM DEWATERING EQUIPMENT TECHNICAL SPECIFICATION SPECIFIC TECHNICAL REQUIREMENT	SPECIFICATION No: PE-TS-468-571-A901	
		SECTION : I	
		SUB-SECTION : C1	
		REV. 00	
		SHEET 19 OF 19	

10.0	EXCLUSIONS
-------------	-------------------

Below are excluded from scope of the GDWE Supplier:

- a) All utilities such as instrument air and process water up to terminal point
- b) Control System (excluding Junction box)
- c) Lifting equipments for Material handling
- d) 3D Modeling
- e) Gypsum Conveyor from the discharge of chute.
- f) Tanks and their instruments & Slurry Pumps (except Filtrate Extraction)
- g) Vibration Monitoring System for HT motors.
- h) Civil work

11.0	BID EVALUATION CRITERIA FOR POWER CONSUMPTION
-------------	--

Bidder is required to quote Guaranteed Power Consumption (GPC) in the price schedule issued along with tender. In case of non-submission of filled up format, the bid shall be liable for rejection. Value for power consumption quoted by the bidder in the specified format, shall be considered as final and any request by bidder for any change in quoted power consumption at a later date, shall not be considered by BHEL.

	NSPCL BHILAI (2X250 MW)	SPECIFICATION No: PE-TS-468-571-A901	
	GYPSUM DEWATERING EQUIPMENT TECHNICAL SPECIFICATION SPECIFIC TECHNICAL REQUIREMENT	SECTION : I	
		SUB-SECTION : C 2	
		REV. 00	

SECTION: I
SUB-SECTION: C 2
CUSTOMER SPECIFICATION

THIS IS PART OF TECHNICAL SPECIFICATION PE-TS-468-571-A901 REV 00.

	NSPCL BHILAI (2X250 MW)	SPECIFICATION No: PE-TS-468-571-A901	
	GYPSUM DEWATERING EQUIPMENT	SECTION : I	
	TECHNICAL SPECIFICATION PROJECT SPECIFIC TECHNICAL REQUIREMENT	SUB-SECTION : C 2A	
		REV. 00	

SECTION: I

SUB-SECTION: C 2A

CUSTOMER SPECIFICATION

PROJECT SPECIFIC GENERAL REQUIREMENTS

THIS IS PART OF TECHNICAL SPECIFICATION PE-TS-468-571-A901 REV 00.



SUB-SECTION-VI

FUNCTIONAL GUARANTEES & LIQUIDATED DAMAGES

**LOT-2 PROJECTS
FLUE GAS DESULPHURISATION (FGD) SYSTEM PACKAGE**

**TECHNICAL SPECIFICATION
SECTION-VI
BID DOCUMENT NO.: CS-0011-109(2)-9**

THIS IS PART OF TECHNICAL SPECIFICATION PE-TS-468-571-A901 REV 00.

CLAUSE NO.	FUNCTIONAL GUARANTEES AND LIQUIDATED DAMAGES			
1.00.00	<p>FUNCTIONAL GUARANTEES, LIQUIDATED DAMAGES FOR SHORTFALL IN PERFORMANCE AND PERFORMANCE GUARANTEE TESTS</p> <p>GENERAL</p> <p>The term “Performance Guarantees” wherever appears in the Technical Specifications shall have the same meaning and shall be synonymous to “Functional Guarantees”. Similarly the term “Performance Tests” wherever appears in the Technical Specifications shall have the same meaning and shall be synonymous to “Guarantee Test(s)”.</p>			
2.00.00	<p>PERFORMANCE GUARANTEES / PERFORMANCE TESTS</p>			
2.01.00	<p>General Requirements</p>			
2.01.01	<p>The Contractor shall guarantee that the equipment offered shall meet the ratings and performance requirements stipulated for various equipment covered in these specifications.</p>			
2.01.02	<p>The guaranteed performance parameters furnished by the Bidder in his offer, shall be without any tolerance values whatsoever. All margins required for instrument inaccuracies and other uncertainties shall be deemed to have been included in the guaranteed figures. No tolerance or allowance on the test result will be permitted for instrument errors or inaccuracy, the method of testing or any other causes.</p>			
2.01.03	<p>The Contractor shall conduct performance test and demonstrate all the guarantees covered herein. The various tests which are to be carried out during performance guarantee tests are listed in this Sub-section. The guarantee tests shall be conducted by the Contractor at site in presence of Employer on each unit individually.</p>			
2.01.04	<p>All costs associated with the tests including cost associated with the supply, calibration, installation and removal of the test instrumentation shall be included in the contract price.</p>			
2.01.05	<p>The performance tests shall be performed using only the normal number of Employer supplied operating staff. Contractor, vendor or other subcontractor personnel shall be used only for instructional purposes or data collection. At all times during the Performance Tests the emissions and effluents from the Plant shall not exceed the Guaranteed Emission and Effluent Limits.</p>			
2.01.06	<p>It shall be responsibility of the Contractor to make the plant ready for the performance guarantee tests.</p>			
<p>LOT-2 PROJECTS FLUE GAS DESULPHURISATION (FGD) SYSTEM PACKAGE</p>	<p>TECHNICAL SPECIFICATION SECTION – VI, PART-A BID DOC. NO.: CS-0011-109(2)-9</p>	<p>SUB-SECTION-VI FUNCTIONAL GUARANTEES & LIQUIDATED DAMAGES</p>	<p>PAGE 1 OF 27</p>	

CLAUSE NO.	FUNCTIONAL GUARANTEES AND LIQUIDATED DAMAGES			
2.02.00	Test Instrumentation, Flow Measurement and their Calibration			
2.02.01	<p>All instruments required for performance testing shall be of the type and accuracy required by the code and prior to the test, the Contractor shall get these instruments calibrated in an independent test Institute approved by the Employer and submit the same to Employer prior to commencement of test. All test instrumentation required for performance tests shall be supplied by the Contractor and shall be retained by him upon satisfactory completion of all such tests at site. All calibration procedures and standards shall be subject to the approval of the Employer prior to commencement of test. The protecting tubes, pressure connections and other test connections required for conducting guarantee test shall conform to the relevant codes.</p> <p>Tools and tackles, thermowells (both screwed and welded) instruments/devices including flow devices, matching flanges, impulse piping & valves etc. and any special equipment, required for the successful completion of the tests, shall be provided by the Contractor free of cost.</p> <p>The Performance test shall be carried out as per the agreed procedure. The detailed PG test procedure shall be submitted within 90 days of the date of Notification of Award and finalization of the PG test procedure shall be done within 180 days from the date of Notification of Award.</p>			
2.02.02	<p>The P&G test procedures shall be submitted for equipments/system & subsystem under Contractor's scope for all Guarantees as mentioned below, as per latest International codes / standard including correction curves, meeting the specification requirements along with sample calculations & detailed activity plan of preparation (including test instrumentation), conductance and evaluation of Guarantees.</p>			
2.02.03	<p>The Contractor shall submit for Employer's approval the detailed Performance Test procedure containing the following:</p> <ul style="list-style-type: none"> (a) Object of the test. (b) Various guaranteed parameters & tests as per contract. (c) Method of conductance of test and test code. (d) Duration of test, frequency of readings & number of test runs. (e) Method of calculation. (f) Correction calculations & curves. (g) Instrument list consisting of range, accuracy, least count, and location of instruments. 			
<p align="center">LOT-2 PROJECTS FLUE GAS DESULPHURISATION (FGD) SYSTEM PACKAGE</p>		<p align="center">TECHNICAL SPECIFICATION SECTION – VI, PART-A BID DOC. NO.: CS-0011-109(2)-9</p>	<p align="center">SUB-SECTION-VI FUNCTIONAL GUARANTEES & LIQUIDATED DAMAGES</p>	<p align="center">PAGE 2 OF 27</p>

CLAUSE NO.	FUNCTIONAL GUARANTEES AND LIQUIDATED DAMAGES 
2.03.00	<p>(h) Scheme showing measurement points.</p> <p>(i) Sample calculation.</p> <p>(j) Acceptance criteria.</p> <p>(k) Any other information required for conducting the test.</p> <p>Test Reports</p> <p>After the conductance of Performance test, the Contractor shall submit the test evaluation report of Performance test results to Employer promptly but not later than one month from the date of conductance of Performance test. Preliminary test reports shall be submitted to the Employer after completing each test run. Four (4) hard copies and two (2) soft copies on CD-ROM of each test report of final</p>

VOID

THIS IS PART OF TECHNICAL SPECIFICATION PE-TS-468-571-A901 REV 00.

<p style="text-align: center;">LOT-2 PROJECTS FLUE GAS DESULPHURISATION (FGD) SYSTEM PACKAGE</p>	<p style="text-align: center;">TECHNICAL SPECIFICATION SECTION – VI, PART-A BID DOC. NO.: CS-0011-109(2)-9</p>	<p style="text-align: center;">SUB-SECTION-VI FUNCTIONAL GUARANTEES & LIQUIDATED DAMAGES</p>	<p style="text-align: center;">PAGE 3 OF 27</p>	

CLAUSE NO.	FUNCTIONAL GUARANTEES AND LIQUIDATED DAMAGES			
3.00.00	VOID			
	<p>(ii) For Category-II Guarantees</p> <p>In case during performance guarantee test(s) it is found that the equipment/system has failed to meet the guarantees, the Contractor shall carry out all necessary modifications and/or replacements to make the equipment/system comply with the guaranteed requirements at no extra cost to the Employer and re-conduct the performance guarantee test(s) with Employer's consent. In case the specified performance guarantee(s) are still not met even after the above modifications/replacements within ninety (90) days or a reasonable period allowed by the Employer, after the tests have been completed, the Employer will have the right to either of the following:</p> <p>Reject the equipment /system / plant and recover from the Contractor the payments already made.</p> <p style="text-align: center;">OR</p> <p>Accept the equipment/system after assessing the deficiency in respect of the various ratings, performance parameters and capabilities and recover from the contract price an amount equivalent to the damages as determined by the Employer. Such damages shall, however be limited to the cost of replacement of the equipment(s)/system(s), replacement of which shall remove the deficiency so as to achieve the guaranteed performance. These parameters/capacities shall be termed as "Category-II" Guarantees.</p>			
	VOID			
<p style="text-align: center;">LOT-2 PROJECTS FLUE GAS DESULPHURISATION (FGD) SYSTEM PACKAGE</p>	<p style="text-align: center;">TECHNICAL SPECIFICATION SECTION – VI, PART-A BID DOC. NO.:CS-0011-109(2)-9</p>	<p style="text-align: center;">SUB-SECTION-VI FUNCTIONAL GUARANTEES & LIQUIDATED DAMAGES</p>	<p style="text-align: center;">PAGE 4 OF 27</p>	

CLAUSE NO.

FUNCTIONAL GUARANTEES AND LIQUIDATED DAMAGES



VOID

THIS IS PART OF TECHNICAL SPECIFICATION PE-TS-468-571-A901 REV 00.

LOT-2 PROJECTS
FLUE GAS DESULPHURISATION (FGD) SYSTEM
PACKAGE

TECHNICAL SPECIFICATION
SECTION – VI, PART-A
BID DOC. NO.: CS-0011-109(2)-9

SUB-SECTION-VI
FUNCTIONAL
GUARANTEES &
LIQUIDATED DAMAGES

PAGE 9 OF 27

CLAUSE NO.	FUNCTIONAL GUARANTEES AND LIQUIDATED DAMAGES			
	<h1>VOID</h1>			
4.00.00	GUARANTEES PARAMETERS			
4.01.00	<p>Guarantees Under Category-I</p> <p>The Performance Guarantees which attract Liquidated Damages (LD) are as follows:</p> <p>The following shall be guaranteed by the Bidder under guarantee point condition of Sub- Section-V, Part-A of section- VI:</p> <p>(i) SO₂ removal Efficiency</p> <p>The Contractor shall guarantee that SO₂ removal efficiency shall not be less than the value specified under guarantee point conditions (as specified in Clause 1.00.00/2.00.00/3.00.00 Sub-section-V, Part-A of Section-VI applicable for respective project). (To be conducted as per the stipulation of Cl. no. 6.00.00 of this sub-section.)</p> <p>(ii) Limestone Consumption</p> <p>The Contractor shall guarantee that limestone consumption of FGD system in kg/hr shall not be more than the value specified under guarantee point conditions (as specified in Clause 1.00.00/2.00.00/3.00.00 Sub-section-V, Part-A of Section-VI applicable for respective project).</p> <p>(iii) Auxiliary Power Consumption</p> <p>The Contractor shall guarantee that total auxiliary power consumption for the unit in normal operation shall not be more than the value specified under guarantee point conditions (as specified in Clause 1.00.00/2.00.00/3.00.00 Sub-section-V, Part-A of Section-VI applicable for complete scope of work for the respective project), inline with the requirements stipulated in clause 5.00.00 of this Sub-Section.</p>			
<p style="text-align: center;">LOT-2 PROJECTS FLUE GAS DESULPHURISATION (FGD) SYSTEM PACKAGE</p>	<p style="text-align: center;">TECHNICAL SPECIFICATION SECTION – VI, PART-A BID DOC. NO.: CS-0011-109(2)-9</p>	<p style="text-align: center;">SUB-SECTION-VI FUNCTIONAL GUARANTEES & LIQUIDATED DAMAGES</p>	<p style="text-align: center;">PAGE 12 OF 27</p>	

CLAUSE NO.	FUNCTIONAL GUARANTEES AND LIQUIDATED DAMAGES		
4.02.00	<p>Guarantees Under Category-II</p> <p>The parameters/capabilities shall be demonstrated for various systems/equipments shall include but not limited to the following:-</p> <p>(i) Wet ball Mill capacity at rated fineness</p> <p>The contractor shall demonstrate the guaranteed capacity of each limestone pulverizer under the following conditions:</p> <p>i) Limestone Output fineness : 90% or higher (as per the requirement of the absorber) through 325 mesh (for spray tower process) (OR) 90% or higher (as per the requirement of the absorber) through 200 mesh (for bubbling process)</p> <p>ii) Limestone Quality : All available quality from the specified range.</p> <p>(ii) Wet ball Mill wear parts guarantee</p> <p>Contractor shall demonstrate the life of wet ball Mill wear parts in line with requirements stipulated in Part B of the Technical Specification. The establishment of the above guarantee shall be based on the operating records available at the Power station and will be computed for each pulverizer based on actual total hours of operation.</p> <p>(iii) Wet ball Mill ball consumption</p> <p>Contractor shall guarantee ball consumption per ton of limestone throughput in line with requirements stipulated in Part B of the Technical Specification. Contractor shall furnish the minimum ball diameter below which the balls shall be replaced.</p> <p>(iv) Vacuum Belt Filter Capacity</p> <p>Contractor shall demonstrate the Designed Capacity of the Vacuum Belt Filters to dewater the quantity of gypsum with the specified purity and moisture content as specified in Part B of the Technical Specification.</p> <p>(v) Gypsum Purity</p> <p>The contractor shall demonstrate that the purity of the gypsum produced shall not be less than 90%, chloride content shall not be more than 100ppm</p>		
<p align="center">LOT-2 PROJECTS FLUE GAS DESULPHURISATION (FGD) SYSTEM PACKAGE</p>	<p align="center">TECHNICAL SPECIFICATION SECTION – VI, PART-A BID DOC. NO.: CS-0011-109(2)-9</p>	<p align="center">SUB-SECTION-VI FUNCTIONAL GUARANTEES & LIQUIDATED DAMAGES</p>	<p align="center">PAGE 13 OF 27</p>

CLAUSE NO.	FUNCTIONAL GUARANTEES AND LIQUIDATED DAMAGES		
	<p>and the moisture content shall not be more than 10% for guarantee point condition.</p> <p>(vi) NOT USED</p> <p>(vii) Performance characteristics of fans (capacity, head developed, etc.).</p> <p>(viii) Margins on fans in case Booster Fan is provided by the Contractor.</p> <p style="text-align: center;">Booster Fans - As specified in Part B of Technical Specifications</p> <p>(ix) Passenger cum Goods Elevator for FGD absorber & Limestone Grinding Building: Over load tests, travel and hoist speed checks</p> <p>(x) Noise</p> <p>All the plant, equipment and systems covered under this specification shall perform continuously without exceeding the noise level over the entire range of output and operating frequency specified in Part-C of Section-VI of the technical specifications.</p> <p>Noise level measurement shall be carried out using applicable and internationally acceptable standards. The measurement shall be carried out with a calibrated integrating sound level meter meeting the requirement of IEC 651 or BS 5969 or is 9779.</p> <p>Sound pressure shall be measured all around the equipment at a distance of 1.0 m horizontally from the nearest surface of any equipment/ machine and at a height of 1.5 m above the floor level in elevation.</p> <p>A minimum of 6 points around each equipment shall be covered for measurement. additional measurement points shall be considered based on the applicable standards and the size of the equipment. the measurement shall be done with slow response on the a - weighting scale. the average of a-weighted sound pressure level measurements expressed in decibels to a reference of 0.0002 micro bar shall not exceed the guaranteed value. corrections for background noise shall be considered in line with the applicable standards. all the necessary data for determining these corrections, in line with the applicable standards, shall be collected during the tests.</p> <p>(xi) Mist Outlet Droplet Content</p> <p>The mist eliminator outlet droplet content shall be guaranteed to be ≤ 20</p>		
<p style="text-align: center;">LOT-2 PROJECTS FLUE GAS DESULPHURISATION (FGD) SYSTEM PACKAGE</p>	<p style="text-align: center;">TECHNICAL SPECIFICATION SECTION – VI, PART-A BID DOC. NO.:CS-0011-109(2)-9</p>	<p style="text-align: center;">SUB-SECTION-VI FUNCTIONAL GUARANTEES & LIQUIDATED DAMAGES</p>	<p style="text-align: center;">PAGE 14 OF 27</p>

CLAUSE NO.	FUNCTIONAL GUARANTEES AND LIQUIDATED DAMAGES		
5.00.00	<p>ix) The pumps shall be guaranteed to operate satisfactorily without cavitation, pitting, excessive vibration or noise in single pump operation (one pump running) and/or in parallel operation with other pumps or and when starting or shutting down a pump while other pump(s) is/are in operation.</p> <p>x) Current, Voltage, Motor input Power, Frequency, Speed, Bearing / Motor winding Temperature, Vibration and noise level of pumps, blowers and their drives and parallel operation of pumps & blowers shall be demonstrated at site as a part of Performance & Guarantee test.</p> <p>Please also refer the attached Annexure –I to this sub-section for performance guarantee test</p> <p>(xix) Limestone Handling System and Gypsum Handling System</p> <p>a) Limestone Handling Plant</p> <p>(i) The Bidder shall demonstrate the unloading at truck tippler, crushing and conveying to storage shed/silo and then reclaim from storage shed/silos and conveying to mill bunker at the guaranteed capacity including all intermediate equipment & conveyors.</p> <p>(ii) Bidder shall also demonstrate the guaranteed tipping rate of truck tipplers.</p> <p>b) Gypsum Handling Plant</p> <p>The Bidder shall demonstrate the guaranteed conveying from belt filter to storage shed/silo including all intermediate equipment & conveyors.</p> <p>AUXILIARY POWER CONSUMPTION (PA) FOR EACH PROJECT</p> <p>The unit auxiliary power consumption shall be calculated using the following relationship.</p> $P_a = (P_{a1} + P_{a2} + \dots + P_{an})/n$ $P_{an} = P_{un} + T_{Ln}$ <p>P_a = Guaranteed Auxiliary Power Consumption</p> <p>P_{an} = Auxiliary Power Consumption for unit # n</p> <p>(Where “n” is the unit number e.g. 1, 2,)</p> <p>P_{un} = Power consumed by the auxiliaries of the unit under test</p>		
<p align="center">LOT-2 PROJECTS FLUE GAS DESULPHURISATION (FGD) SYSTEM PACKAGE</p>	<p align="center">TECHNICAL SPECIFICATION SECTION – VI, PART-A BID DOC. NO.:CS-0011-109(2)-9</p>	<p align="center">SUB-SECTION-VI FUNCTIONAL GUARANTEES & LIQUIDATED DAMAGES</p>	<p align="center">PAGE 19 OF 27</p>

CLAUSE NO.	FUNCTIONAL GUARANTEES AND LIQUIDATED DAMAGES	
	<p>T_{Ln} = Losses of the transformers supplied by bidder based on works test reports</p> <p>While guaranteeing the auxiliary power consumption of each project the bidder shall necessarily include all continuously operating auxiliaries under this package. The auxiliaries to be considered shall include but not be limited to the following:</p> <ul style="list-style-type: none"> i. Absorber Recirculation Pump(s)/Gas Cooling Pumps ii. Absorber Oxidation Air Blower(s) iii. Absorber Oxidation Tank Agitators iv. Gypsum Bleed Pumps v. Limestone Gravimetric feeder, Wet ball mill and their integral Auxiliaries divided by the number of units in the project vi. Limestone Slurry Pump(s) → vii. Vacuum Belt Filter, Vacuum Pump and its integral auxiliaries divided by the number of units in the project Including Filtrate Extraction Pump After Vacuum Receiver, Vent Fan & Sump Pump etc. viii. Power consumption of all working Booster water pumps (if provided) to ACW pumps after PHE divided by the number of units in the project ix. Power consumption of Clarified water pumps (if provided) and Clarified booster water pumps (if provided) divided by the number of units in the project x. Power consumption of Process water pump(s) divided by the number of units in the project xi. Mist Eliminator Wash Water pump(s) → xii. Power consumption of Belt Filter Wash Water Pump divided by the number of units in the project xiii. Power consumption of total number of DM Cooling (working) Water pump to supply cooling water on the primary (DM) side of the plate type heat exchangers in the closed loop Equipment cooling water system divided by the number of units (working) in the project xiv. Power consumption of total number of Auxiliary Cooling (working) water pump/Permeate water pump to supply cooling water on the secondary side of the plate type heat exchangers in the closed loop Equipment cooling (unit auxiliary) water system divided by the number of units (working) in the project 	
<p align="center">LOT-2 PROJECTS FLUE GAS DESULPHURISATION (FGD) SYSTEM PACKAGE</p>	<p align="center">TECHNICAL SPECIFICATION SECTION – VI, PART-A BID DOC. NO.: CS-0011-109(2)-9</p>	<p align="center">SUB-SECTION-VI FUNCTIONAL GUARANTEES & LIQUIDATED DAMAGES</p> <p align="right">PAGE 20 OF 27</p>

CLAUSE NO.	FUNCTIONAL GUARANTEES AND LIQUIDATED DAMAGES		
	<p>xv. Booster Fans</p> <p>xvi. Power consumption of Limestone Slurry Tank Agitator(s) divided by the number of units in the project</p> <p>xvii. Power consumption of Filtrate Pump(s) divided by the number of units in the project</p> <p>xviii. Power consumption of Cloth Wash Water Pump divided by the number of units in the project</p> <p>xix. Power consumption of Hydro-cyclone and Waste Water Pump divided by the number of units in the project</p> <p>xx. Power consumption of all other continuous running Agitators divided by the number of units in the project</p> <p>xxi. Air Conditioning System (*)</p> <p>Total Power consumption at motor input terminals of working units (i.e. excluding stand-by) at its rated duty point of compressor and condenser fans of air cooled condensing unit, Air handling unit (AHU) fans for the Air conditioning system of FGD Control Room Building divided by total nos. of units in respective project</p> <p>xxii Total power consumption at motor input terminal at rated duty of fan of UAF divided by total nos. of units in respective project. (*)</p> <p>((*) Above guaranteed power consumption values shall be at 20 deg C for centrifugal fans of AHUs and at 30 deg C for centrifugal fans of UAF units and at an elevation of RL (referring to GLP of respective projects) for both AHUs and UAF centrifugal fans.)</p> <p>xxiii Total power consumption at motor input terminal at rated duty of Air compressor, Air drying plant (Heater and blower, as applicable) divided by total nos. of units in respective project.</p> <p>xxiv “Total power consumption at motor input terminal at rated capacity of all working High Pressure Feed Pumps (SWRO)(1st Stage) (with its Energy Recovery Unit) to achieve the rated output of the SWRO plant”, divided by the number of units in the project for Vallur TPP.</p> <p>xxv “Total power consumption at motor input terminal at rated capacity of all working PX Booster Pumps (if applicable) to achieve the rated output of the SWRO(1st Stage) plant ” divided by the number of units in the project for Vallur TPP.</p> <p>xxvi. “Total power consumption at motor input terminal at rated capacity of all working High Pressure Feed Pumps RO (2st Stage) (with its Energy Recovery Unit) to achieve the rated output of the RO plant”, divided by the</p>		
<p align="center">LOT-2 PROJECTS FLUE GAS DESULPHURISATION (FGD) SYSTEM PACKAGE</p>	<p align="center">TECHNICAL SPECIFICATION SECTION – VI, PART-A BID DOC. NO.:CS-0011-109(2)-9</p>	<p align="center">SUB-SECTION-VI FUNCTIONAL GUARANTEES & LIQUIDATED DAMAGES</p>	<p align="center">PAGE 21 OF 27</p>



BHEL, Ranipet - 632 406, India. Quality Assurance Department. Painting Scheme		BHEL DOC No: PS:BHIL:FGD:G211 Rev: 04 Dt: 10/12/2020 NTPC Contract No: CC/CC&M-C-568-FC-NOA/141 Dt: 26/08/2019 NTPC Doc No: 9993-109-PVM-H-001 Rev: 04 Dt: 10/12/2020			
Project FGD Package for NSPCL - BHILAI Expansion Power Project (2x250 MW) - BHEL Cust Nos: G211-G212		Surface Location PGMA		Surface Preparation	
Sl No	Primer & Intermediate Coats		Finish Coat		Total DFT (µm min)
	Paint	DFT (µm min)	Paint	DFT (µm min)	

FGD Package for NSPCL - BHILAI Expansion Power Project (2x250 MW)
Painting Scheme for FGD System, Booster Fans, Gates & Dampers

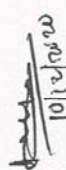
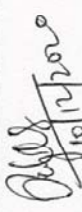
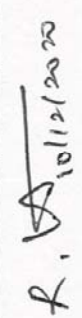
Prepared By  10/12/2020 Abdul Ghani, Senior Engineer / QA	Reviewed By  10/12/2020 Renjith K, Manager / QA	Approved By  10/12/2020 Arunachalam R, DGM / QA(Mech) & OLI
---	--	---

		BHEL, Ranipet - 632 406, India. Quality Assurance Department. Painting Scheme		BHEL DOC No: PS:BHIL:FGD:G211 Rev: 04 Dt: 10/12/2020 NTPC Contract No: CC/CC&M-C-568-FC-NOA/141 Dt: 26/08/2019 NTPC Doc No: 9993-109-PVM-H-001 Rev: 04 Dt: 10/12/2020	
Project		FGD Package for NSPCL - BHILAI Expansion Power Project (2x250 MW) - BHEL Cust Nos: G211-G212			
SI No	Surface Location	PGMA	Surface Preparation	Primer & Intermediate Coats	
				Paint	DFT (µm min)
				Paint	DFT (µm min)
				Paint	Total DFT (µm min)

Record of Revisions

Rev No	Date	Details of Revision
00	02/07/2020	First Submission
01	10/09/2020	<p>Revised in line customer comments.</p> <p>1)Page 2,SI no 1 of Fans. NTPC Comment:What is the basis of providing Shade? BHEL Reply: SL no 18(Fans) of Appendix of NTPC color and coding scheme.</p> <p>2)Page 4, SI no 1 of FGD, NTPC Comment:Why this clause is used and not clause 1.04.00 as done in Maouda-I BHEL Reply: The clause 1.04.00 is for components where no specific requirement is stipulated. Slurry recirculation pumps were indoor and kept in a building. This surface was only available under clause 7.5.00. Since the requirements of painting of this PGMA is clearly stipulated in Clause 7.05.00, we have used that clause. Also we would like to submit that we have envisaged the same painting for Barh-I, Barh-II, North Karnapura and Dadri projects also which is approved by M/s NTPC.</p> <p>3) Page 5, SI no 4 of FGD, NTPC Comment:Should be with glass BHEL Reply:Painting will be done on port without glass usually.</p> <p>4) Page 8, SI no 14 of FGD, Comment:Please mention Painting system for all the equipment covered in ECW system like tank, pipeline, valves , pumps ,PHE etc in separate head - as ECW system equipment. DFT change indicated. BHEL Reply:we have made this painting scheme for Ranipet scope of supply for which PGMA's are released by Ranipet Engg. DFT modified as per NTPC comment.</p> <p>5) Page 8, SI no 17 of FGD, Comment:BHEL to include outside surfaces also. SS shall be applicable for the entire silo coming in contact with Limestone. BHEL Reply:Lime stone Silo-outside surfaces covered in sl no 13 of FGD of this painting scheme. SS lining requirements will be decided by Engineering on contract basis.</p> <p>6) Page 10, SI no 21 of FGD, Comment In some areas the thickness selected is different even for the same specification clause used..Please clarify BHEL Reply:Modified in line with NTPC Comment.</p> <p>7)Page 11, SI no 25 and 26 of FGD, Comment: BHEL to refer to the Clause No. 2.17.00 mentioned for External Piping Surfaces as given in 2.17.00 of Sub Section-I-M7 of Part B of Section VI for Low Pressure Piping applications. Accordingly revise for all relevant Piping BHEL Reply:Revised the painting scheme as per customer requirement.</p>

 BHEL, Ranipet - 632 406, India. Quality Assurance Department. Painting Scheme		BHEL DOC No: PS:BHIL:FGD:G211 Rev: 04 Dt: 10/12/2020 NTPC Contract No: CC/CC&M-C-568-FC-NOA/141 Dt: 26/08/2019 NTPC Doc No: 9993-109-PVM-H-001 Rev: 04 Dt: 10/12/2020				
Project		FGD Package for NSPCL - BHILAI Expansion Power Project (2x250 MW) - BHEL Cust Nos: G211-G212				
Sl No	Surface Location	PGMA	Surface Preparation	Primer & Intermediate Coats		Total DFT (µm min)
				Paint	DFT (µm min)	

02	08/10/2020	<p>8) Page 13, Gate and Dampers, NTPC Comment: all electrical items are to be listed. Paint shade shall be as per specifications. Shade of motors shall be RAL 5012.</p> <p>BHEL Reply: Electrical items are bought out items and therefore the painting specification will be given by respective Engg group as per the tender specification in the drawing itself which will be submitted to NTPC for approval. Therefore, the painting of electrical items is not covered under this painting scheme. This is the practice which is being followed for Auxiliaries as well.</p> <p>9) Page 14, NTPC Comment C&I related LIE, LIR, panels and JB's to be included here as well. BHEL is requested to include painting details for A/C & Ventilation, FDPS and Compressed Air System (within compressor house) & air receivers as per specification.</p> <p>BHEL Reply: we have made this painting scheme for Ranipet scope of supply for which PGMA's are released by Ranipet Engg. Electrical items (C&I related LIE, LIR, panels and JB's) are bought out items and therefore the painting specification will be given by respective Engg group as per the tender specification in the drawing itself which will be submitted to NTPC for approval.</p> <p>10) Page 19, NTPC Comment: Equipment of Material Handling (idlers, pulleys, gearbox, fluid coupling, conveyor structure, platforms, deck plates, technological structures etc) not included (Please include Painting specification for Material Handling portion/equipment)</p> <p>BHEL Reply: Painting specification for Material Handling portion/equipment will be same as main equipment.</p> <p>Revised in line customer comments.</p> <p>1) Page 1, NTPC Comment: BHEL to please stop this practice of changing values without marking rev no.</p> <p>BHEL Reply: Rev: 01 indicated by triangle Δ. Rev: 02 indicated by circle O</p> <p>2) Page 2, Record of revision, Sl no 1 of Fans. NTPC Comment: Page 1 Sl no 1 not replied which is queried again (What is the basis of providing Shade?)</p> <p>BHEL Reply: Already replied in page 1 of 20 in rev 1 of painting scheme. Sl no 18 (Fans) of Appendix of NTPC color and coding scheme.</p> <p>3) Page 2 Record of revision, Sl no 14 of FGD, Comment: Scope of supply is BHEL internal distribution. Please mention equipment covered in ECW system painting as previous commented or submit the separate document. (Please mention Painting system for all the equipment covered in ECW system like tank, pipeline, valves, pumps, PHE etc in separate head - as ECW system equipment. DFT change indicated)</p> <p>BHEL Reply: Separate painting scheme will be submitted for ECW system equipment, by respective BHEL unit as we have made this painting scheme for Ranipet scope of supply for which PGMA's are released by Ranipet Engg.</p> <p>4) Page 2, Record of revision, Page 19, NTPC Comment: Equipment of Material Handling (idlers, pulleys, gearbox, fluid coupling, conveyor structure, platforms, deck plates, technological structures etc) not included (Equipment of Material Handling (idlers, pulleys, gearbox, fluid coupling, conveyor structure, platforms, deck plates, technological structures etc) not included (Please include Painting specification for Material Handling portion/equipment)</p>
----	------------	---

		BHEL, Ranipet - 632 406, India. Quality Assurance Department. Painting Scheme		BHEL DOC No: PS:BHIL:FGD:G211 Rev: 04 Dt: 10/12/2020 NTPC Contract No: CC/CC&M-C-568-FC-NOA/141 Dt: 26/08/2019 NTPC Doc No: 9993-109-PVM-H-001 Rev: 04 Dt: 10/12/2020			
Project		FGD Package for NSPCL - BHILAI Expansion Power Project (2x250 MW) - BHEL Cust Nos: G211-G212					
SI No	Surface Location	PGMA	Surface Preparation	Primer & Intermediate Coats		Finish Coat	
				Paint	DFT (µm min)	Paint	DFT (µm min)

BHEL Reply: Painting for platform specified in sl no 19 and 20 of FGD & sl no 4 and 5 of Gate and Dampers. Equipment of Material Handling (idlers, pulleys,gearbox, fluid coupling, conveyor structure, platforms, deck plates, technological structures etc) are sub assembly of some main equipment, Painting specification for Material Handling port/on/equipment will be same as main equipment if not specified separately in this document.							
5)Page 3,SI no 1 of Fans. NTPC Comment: Page 1 SI no 1 not replied which is queried again(What is the basis of providing Shade?) BHEL Reply: SL no 18(Fans) of Appendix of NTPC color and coding scheme.							
6)Page 5, SI no 1 of FGD, NTPC Comment:Why this clause is used and not clause 1.04.00 as done in Maouda-1 BHEL Reply: Already replied in page 1 of 20 in rev 1 of painting scheme. The clause 1.04.00 is for components where no specific requirement is stipulated. Slurry recirculation pumps were indoor and kept in a building. This surface was only available under clause 7.5.00. Since the requirements of painting of this PGMA is clearly stipulated in Clause 7.05.00, we have used that clause. Also we would like to submit that we have envisaged the same painting for Barh-I, Barh-II, North Kamapura and Dadri projects also which is approved by M/s NTPC.							
Page 8,SI no 11 of FGD. NTPC Comment: Why is it changed from 60 to 40..Pls maintain 50. BHEL Reply: Change made for uniformity of per coat DFT. Maintained 60 as per NTPC comment.							
Page 9,SI no 14 of FGD. NTPC Comment: DFT change indicated. BHEL Reply: Incorporated.							
Page 9,SI no 15 of FGD. NTPC Comment: Two coats will be 140. Why is it changed from 60 to 40..DFT change indicated. BHEL Reply: DFT for idler roller(if applicable) is 70 Microns per coat. Balance items it will be 30 microns per coat. Two coats will be 60Microns only. Change from 60 to 40 made for uniformity of per coat DFT. Maintained 60 as per NTPC comment.							
Page 9,SI no 16 and 17 of FGD. NTPC Comment: Both inside only, why? BHEL Reply: Painting for outside surface covered in SL no 13 of FGD of this painting scheme.							
Page 13,SI no 27 of FGD. NTPC Comment: DFT change indicated. BHEL Reply: Incorporated.							
Page 14,SI no 2 of Gate and Dampers. NTPC Comment: Why is it changed from 60 to 40.DFT change indicated. BHEL Reply: Change from 60 to 40 made for uniformity of per coat DFT. Maintained 60 as per NTPC comment.							

		BHEL, Ranipet - 632 406, India. Quality Assurance Department. Painting Scheme		BHEL DOC No: PS:BHIL:FGD:G211 Rev: 04 Dt: 10/12/2020 NTPC Contract No: CC/CC&M-C-568-FC-NOA/141 Dt: 26/08/2019 NTPC Doc No: 9993-109-PVM-H-001 Rev: 04 Dt: 10/12/2020				
Project		FGD Package for NSPCL - BHILAI Expansion Power Project (2x250 MW) - BHEL Cust Nos: G211-G212						
Sl No	Surface Location	PGMA	Surface Preparation	Primer & Intermediate Coats		Finish Coat		Total DFT (µm min)
				Paint	DFT (µm min)	Paint	DFT (µm min)	
03	29/10/2020	Revised in line customer comments. 1) Transmittal(Reference: null109:297 dtd 28-10-20), NTPC Comment: BHEL is requested to kindly include Material Handling area's painting schedule. BHEL Reply: Material handling equipments are included under PGMA:FW249;FW310;FW710;FW714;FW713. Painting specification for Material Handling portion/equipment will be same as main equipment specified separately in this document.						
04	10/12/2020	Revised in line customer comments(Transmittal Reference: null109:324 dated 13-11-2020 and mail dated 17 Nov 2020. 1) NTPC Comment: Painting schedule od Water system portion was not included and the same comment was made in previous revision as well. BHEL Reply:Water system is not in the scope of BHEL Ranipet. Respective unit will submit the Painting scheme for Water system portion. 2) NTPC Comment: Comment from MH (made by self on behalf of MH) is regarding painting schedule of pulleys,structure and rollers etc .The same comment was there in previous revision as well. BHEL Reply: Only PGMA listed in previous comment reply are only part of BHEL Ranipet. Other material handling like Pulleys,structure and rollers etc is not in the scope of BHEL Ranipet. Respective unit will submit the Painting scheme for painting schedule of pulleys,structure and rollers etc. New scheme introduced at the end of this document.						

		BHEL, Ranipet - 632 406, India. Quality Assurance Department. Painting Scheme		BHEL DOC No: PS:BHIL:FGD:G211 Rev: 04 Dt: 10/12/2020 NTPC Contract No: CC/CC&M-C-568-FC-NOA/141 Dt: 26/08/2019 NTPC Doc No: 9993-109-PVM-H-001 Rev: 04 Dt: 10/12/2020			
Project		FGD Package for NSPCL - BHILAI Expansion Power Project (2x250 MW) - BHEL Cust Nos: G211-G212					
Sl No	Surface Location	PGMA	Surface Preparation	Primer & Intermediate Coats		Finish Coat	Total DFT (µm min)
				Paint	DFT (µm min)		

1. Fans

1	Axial Fan tool & fixtures (Clause 20.03.00 of Part-C Section VI)	55000	Power Tool Cleaning to st3 (SSPC-SP3)	Red Oxide Zinc Phosphate Primer to IS: 12744 (Two coats)	60	Synthetic Enamel to IS 2932 Shade: Grey white RAL 9002 (Two coats)	40	100
2	Booster Fan foundation material (Clause 20.04.00 of Part- C Section VI)	55081	All Threaded and other surfaces of foundation bolt and its materials shall be coated with temporary rust preventive fluid. During execution of civil works the dried film of coating will be removed using Organic solvents.	Temporary rust preventive fluid application as per PRQA 523 DFT- 20µ;				
3	Booster Fan Handrails & Insert (Clause 31.06.00 of Sec.VI, Part-B, Subsection- IV-D)	55082	Blast cleaning to Sa 2½/ Acid pickling	Hand rails, Gratings- Hot dip galvanizing to 610gms/sq.m (minimum) as per IS: 4736 and to a coating thickness of 87µm (min).				
4	Booster Fan Handrails & Insert- Structural items other than the above (Clause 31.03.00 of Sec.VI, Part-B, Subsection- IV-D)	55082	Blast cleaning to Sa 2½ (Near white metal) with surface profile 40-60µm conforming to ISO 8501-1	Primer: One coat of Two component moisture curing zinc (ethyl) silicate primer coat (Min 80% metallic zinc content in dry film, solid by volume minimum 60% ±2). Zinc dust composition and properties shall be as per Type II as per ASTM D520-00 DFT- 70µ Intermediate: One coat of Two component polyamide cured epoxy with MIO content (containing lamellar MIO Min 30% on pigment, solid by volume min. 80%±2) DFT- 100µ	70	Finish: Two coats of two pack aliphatic isocyanate cured acrylic polyurethane paint to IS 13213 solid by volume min.55%±2) DFT- 35µ/ coat Shade: Grey white, RAL 9002 With gloss retention (SSPC paint spec no.36, ASTM D4587, D2244, D523 of level 2 after min. 1000 hrs exposure, gloss less than 30 and colour change less than 2.0Δ E)	70	240

Project		BHEL, Ranipet - 632 406, India. Quality Assurance Department. Painting Scheme		BHEL DOC No: PS:BHIL:FGD:G211 Rev: 04 Dt: 10/12/2020 NTPC Contract No: CC/CC&M-C-568-FC-NOA/141 Dt: 26/08/2019 NTPC Doc No: 9993-109-PVM-H-001 Rev: 04 Dt: 10/12/2020				
		FGD Package for NSPCL - BHILAI Expansion Power Project (2x250 MW) - BHEL Cust Nos: G211-G212						
Sl No	Surface Location	PGMA	Surface Preparation	Primer & Intermediate Coats		Finish Coat		Total DFT (µm min)
				Paint	DFT (µm min)	Paint	DFT (µm min)	
5	Axial booster cooling/ seal fan, Booster fan canopy for motor, Axial booster fan coupling, Booster fan LOS with lubricant, Booster fan actuator (Clause 1.04.00 of Part- A Section VI)	55084, 55089, 55880, 55980, 55983	Blast cleaning to Sa 2 1/2	Primer: Two coats of Epoxy resin based Epoxy Zinc phosphate primer to IS 13238 DFT- 50µ/coat Intermediate: One coat of Two component epoxy based intermediate paint pigmented with TiO2 DFT- 100µ	100	Finish: One coat of Epoxy based finish paint with glossy finish to IS 14209; DFT- 75µ Finish: One coat of acrylic aliphatic polyurethane paint to IS 13213 DFT-25µ Shade: Grey White, RAL9002	75	300
6	Axial booster fan rotor (Clause 20.03.00 of Part-C Section VI)	55286	Power Tool Cleaning to S&3 (SSPC-SP3)	Two coats of Epoxy based Zinc phosphate primer (Two pack system) to IS 13238; DFT- 30µ/coat	60	NIL	--	60
7	Axial booster fan stator (Clause 20.03.00 of Part-C Section VI)	55586 55786 55886	Power Tool Cleaning to S&3 (SSPC-SP3)	Red Oxide Zinc Phosphate Primer to IS: 12744 (Two coats)	60	Synthetic Enamel to IS 2932 Shade: Grey white RAL 9002 (Two coats)	40	100

		BHEL, Ranipet - 632 406, India. Quality Assurance Department. Painting Scheme		BHEL DOC No: PS:BHIL:FGD:G211 Rev: 04 Dt: 10/12/2020 NTPC Contract No: CC/CC&M-C-568-FC-NOA/141 Dt: 26/08/2019 NTPC Doc No: 9993-109-PVM-H-001 Rev: 04 Dt: 10/12/2020			
Project		FGD Package for NSPCL - BHILAI Expansion Power Project (2x250 MW) - BHEL Cust Nos: G211-G212					
Sl No	Surface Location	PGMA	Surface Preparation		Finish Coat		Total DFT (µm min)
			Paint	DFT (µm min)	Paint	DFT (µm min)	

2. FGD System

1	Slurry recirculation pump System (Clause 7.05.00 of Section-VI, Part-B, Sub-Section-IM5)	FW212	Power Tool Cleaning to St3 (SSPC-SP3)	Primer: Red Oxide Zinc Phosphate Primer to IS: 12744 (Two coats): DFT- 30µ / Coat Intermediate: One coat of Synthetic Enamel intermediate coat to IS 2932; DFT- 50µ	60	Two coats of Synthetic Enamel to IS 2932, DFT- 50µ/ coat Shade: Light blue RAL 5012	100	210
2	Absorber System Internals – Structural items; Mist eliminator and accessories, Absorber baffle grating support, Mist eliminator support& Absorber Spray pipe support - Structural items (Clause 1.04.00 of Part-A Section VI)	FW213; FW215, FW216, FW217, FW218	Blast cleaning to Sa 2½	Primer: Two coats of Epoxy resin based Epoxy Zinc phosphate primer to IS 13238 DFT- 50µ/coat Intermediate: One coat of Two component epoxy based intermediate paint pigmented with TiO2, DFT- 100µ	100	Finish: One coat of Epoxy based finish paint with glossy finish to IS 14209; DFT- 75µ Finish: One coat of acrylic aliphatic polyurethane paint to IS 13213, DFT-25µ Shade: Grey White, RAL9002	75	300
3	Absorber System- Base; Absorber system structures, Absorber shear plate, Duct supports, Structures for RC pump house& Hook up duct structure; Absorber system casing bottom#- Outside surfaces Absorber system casing top#- Outside surfaces. Emergency Quench water tank- Outside surfaces	FW219; FW220, FW231, FW232, FW233, FW234, FW236, FW238; FW221; FW222; FW226; FW301; FW302;	Blast cleaning to Sa 2½ (Near white metal) with surface profile 40-60µm conforming to ISO 8501-1	Primer: One coat of Two component moisture curing zinc (ethyl) silicate primer coat (Min 80% metallic zinc content in dry film, solid by volume minimum 60% ±2). Zinc dust composition and properties shall be as per Type II as per ASTM D520-00 DFT- 70µ Intermediate: One coat of Two component polyamide cured epoxy with MIO content (containing	70	Finish: Two coats of two pack aliphatic isocyanate cured acrylic polyurethane paint to IS 13213 solid by volume min.55%±2) Shade: Grey white, RAL 9002 With gloss retention (SSPC paint spec no.36, ASTM D4587, D2244, D523 of level 2 after min. 1000 hrs exposure, gloss less than 30	70	240

 BHEL, Ranipet - 632 406, India. Quality Assurance Department. Painting Scheme		BHEL DOC No: PS:BHIL:FGD:G211 Rev: 04 Dt: 10/12/2020 NTPC Contract No: CC/CC&M-C-568-FC-NOA/141 Dt: 26/08/2019 NTPC Doc No: 9993-109-PVM-H-001 Rev: 04 Dt: 10/12/2020				
Project FGD Package for NSPCL - BHILAI Expansion Power Project (2x250 MW) - BHEL Cust Nos: G211-G212		Primer & Intermediate Coats		Finish Coat		
SI No	Surface Location	PGMA	Surface Preparation	Paint	DFT (µm min)	Total DFT (µm min)
	(# Inside surfaces are of C276 clad sheets. Hence, no paint is envisaged). (Clause 31.03.00 of Sec. VI, Part-B, Subsection- IV-D)	FW303		lamellar MIO Min 30% on pigment, solid by volume min. 80%±2) DFT- 100µ	and colour change less than 2.0Δ E)	
4 Δ	Absorber system accessories; Air oxidation system, Viewing ports (Without glass) (Clause 20.03.00 of Part-C Section VI)	FW223; FW230, FW239	Power Tool Cleaning to St3 (SSPC-SP3)	Red Oxide Zinc Phosphate Primer to IS: 12744 (Two coats)	Synthetic Enamel to IS 2932 Shade: Grey white RAL 9002 (Two coats)	40 100
5	Emergency Quench water tank- Inside surfaces (For temporary protection, until erection only)	FW226	Blast cleaning to Sa 2½ (Near white metal) with surface profile 35-50µm	Primer: Two coats of Red Oxide Zinc phosphate primer, DFT-30µ/coat; Total-60µ (Primer is only envisaged as lining is given in inside surfaces of the tank)		
6	Emergency quench system, Handling Equipment - RC Pump (Clause 20.03.00 of Part-C Section VI)	FW227, FW249	Power Tool Cleaning to St3 (SSPC-SP3)	Red Oxide Zinc Phosphate Primer to IS: 12744 (Two coats)	Synthetic Enamel to IS 2932 Shade: Grey white RAL 9002 (Two coats)	40 120
7	Absorber W/D interface, W/D wash system, Slurry distribution system, Oxidation Air distribution system (Clause 1.04.00 of Part-A Section VI)	FW228, FW229, FW243, FW244	Blast cleaning to Sa 2½	Primer: Two coats of Epoxy resin based Epoxy Zinc phosphate primer to IS 13238 DFT- 50µ/coat Intermediate: One coat of Two component epoxy based intermediate paint pigmented with TiO2 DFT- 100µ	Finish: One coat of Epoxy based finish paint with glossy finish to IS 14209; DFT- 75µ Finish: One coat of acrylic aliphatic polyurethane paint to IS 13213 DFT-25µ Shade: Grey White, RAL9002	75 300 25

		BHEL, Ranipet - 632 406, India. Quality Assurance Department. Painting Scheme			BHEL DOC No: PS:BHIL:FGD:G211 Rev: 04 Dt: 10/12/2020 NTPC Contract No: CC/CC&M-C-568-FC-NOA/141 Dt: 26/08/2019 NTPC Doc No: 9993-109-PVM-H-001 Rev: 04 Dt: 10/12/2020			
Project		FGD Package for NSPCL - BHILAI Expansion Power Project (2x250 MW) - BHEL Cust Nos: G211-G212						
Sl No	Surface Location	PGMA	Surface Preparation	Primer & Intermediate Coats		Finish Coat		Total DFT (µm min)
				Paint	DFT (µm min)	Paint	DFT (µm min)	
8	Expansion joint between bypass; Expansion joint; Hook-up Ducts, Ducts between bypass duct inlet & booster fan; Ducts between Booster fan & Absorber; Ducts between Absorber & Stack (Clause 20.03.00 of Part- C Section VI)	FW251; FW252;	Power Tool Cleaning to S13 (SSPC-SP3)	Red Oxide Zinc Phosphate Primer to IS: 12744 (two coats)	60	--	--	60
		FW238, FW255; FW256; FW257	Power Tool Cleaning to S13 (SSPC-SP3)	HR Aluminum paint to IS 13183 Gr.II (upto 400 deg C)	40	NIL	40	--
9	Duct structure between bypass duct & Booster fan; Duct structure between Booster fan & Absorber Duct structure between Absorber & Stack; Structures for Emergency Quench water tank, Structures for Elevator; Structures for booster fan handling (Clause 31.03.00 of Sec. VI, Part-B, Sub-section IV-D)	FW260; FW261; FW262; FW285, FW292; FW310	Blast cleaning to Sa 2½ (Near white metal) with surface profile 40-60µm conforming to ISO 8501-1	Primer: One coat of Two component moisture curing zinc (ethyl) silicate primer coat (Min 80% metallic zinc content in dry film, solid by volume minimum 60% ±2). Zinc dust composition and properties shall be as per Type II as per ASTM D520-00 DFT- 70µ Intermediate: One coat of Two component polyamide cured epoxy with MIO content (containing lamellar MIO Min 30% on pigment, solid by volume min. 80%±2) DFT- 100µ	70	70	Finish: Two coats of two pack aliphatic isocyanate cured acrylic polyurethane paint to IS 13213 solid by volume min.55%±2 Shade: Grey white, RAL 9002 With gloss retention (SSPC paint spec no.36, ASTM D4587, D2244, D523 of level 2 after min. 1000 hrs exposure, gloss less than 30 and colour change less than 2.0Δ E)	240

Project		BHEL, Ranipet - 632 406, India. Quality Assurance Department. Painting Scheme		BHEL DOC No: PS:BHIL:FGD:G211 Rev: 04 Dt: 10/12/2020 NTPC Contract No: CC/CC&M-C-568-FC-NOA/141 Dt: 26/08/2019 NTPC Doc No: 9993-109-PVM-H-001 Rev: 04 Dt: 10/12/2020		
		FGD Package for NSPCL - BHILAI Expansion Power Project (2x250 MW) - BHEL Cust Nos: G211-G212		Primer & Intermediate Coats	Finish Coat	
SI No	Surface Location	PGMA	Surface Preparation	Paint	DFT (µm min)	Total DFT (µm min)
10	Foundation material for duct structures, Absorber, Elevator, RC pump shed, tanks, Silo Structure, pipe racks (Clause 20.04.00 of Part-C Section VI)	FW280, FW281, FW282, FW283, FW740, FW760, FW762, FW763	Temporary rust preventive fluid application as per PRQA 523 DFT- 20µ All Threaded and other surfaces of foundation bolt and its materials shall be coated with temporary rust preventive fluid. During execution of civil works the dried film of coating will be removed using Organic Solvents.	Synthetic Enamel to IS 2932 Shade: Grey white RAL 9002 (Two coats)	60	120
11	Elevator and accessories (Clause 20.03.00 of Part-C Section VI)	FW293, FW716	Power Tool Cleaning to st3 (SSPC-SP3)	Red Oxide Zinc Phosphate Primer to IS: 12744 (Two coats)	60	
12	Galleries and railings for Stairs, Absorber, Dampers, Ducts, Tanks (Clause 31.06.00 of Sec.VI, Part-B, Subsection-IV-D)	FW214, FW237, FW250, FW610, FW612, FW613, FW712, FW722	Blast cleaning to Sa 2½/ Acid pickling	Hand rails, Gratings- Hot dip galvanizing to 610gms/sq.m (minimum) as per IS: 4736 and to a coating thickness of 87µm (min).		
13	Galleries and railings for Stairs, Absorber, Dampers, Ducts, Tanks - Structures other than the above; Monorail for hoist & cranes; Agitator support; Limestone silo structures; Limestone Silo- Outside surfaces;	FW237, FW610, FW612, FW613, FW722; FW710; FW721; FW730; FW731	Blast cleaning to Sa 2½ (Near white metal) with surface profile 40-60µm conforming to ISO 8501-1	Primer: One coat of Two component moisture curing zinc (ethyl) silicate primer coat (Min 80% metallic zinc content in dry film, solid by volume minimum 60% ±2). Zinc dust composition and properties shall be as per Type II as per ASTM D520-00 DFT- 70µ Finish: Two coats of two pack aliphatic isocyanate cured acrylic polyurethane paint to IS 13213 solid by volume min.55%±2 Shade: Grey white, RAL 9002 With gloss retention (SSPC paint spec no.36, ASTM D4587, D2244, D523 of level	70	240

		BHEL, Ranipet - 632 406, India. Quality Assurance Department. Painting Scheme		BHEL DOC No: PS:BHL:FGD:G211 Rev: 04 Dt: 10/12/2020 NTPC Contract No: CC/CC&M-C-568-FC-NOA/141 Dt: 26/08/2019 NTPC Doc No: 9993-109-PVM-H-001 Rev: 04 Dt: 10/12/2020		
Project						
FGD Package for NSPCL - BHILAI Expansion Power Project (2x250 MW) - BHEL Cust Nos: G211-G212						
SI No	Surface Location	PGMA	Surface Preparation	Primer & Intermediate Coats		Total DFT (µm min)
				Paint	DFT (µm min)	
	(Clause 31.03.00 of Sec.VI, Part-B, Subsection- IV-D)				100	
14	Slurry pumps & accessories, Water pumps (Clause 7.05.00 of Section-VI, Part-B, Sub-Section-I-M5)	FW701, FW702	Power Tool Cleaning to S13 (SSPC-SP3)	Intermediate: One coat of Two component polyamide cured epoxy with MIO content (containing lamellar MIO Min 30% on pigment, solid by volume min. 80%±2) DFT- 100µj Primer: Red Oxide Zinc Phosphate Primer to IS: 12744 (Two coats) DFT- 30µ / Coat; Intermediate: One coat of Synthetic Enamel intermediate coat to IS 2932; DFT- 50µj	100	2 after min. 1000 hrs exposure, gloss less than 30 and colour change less than 2.0Δ E)
15	Handling Equipment- Hoists& Man hole door (Clause 20.03.00 of Part- C Section VI)	FW713, FW714, FW717	Power Tool Cleaning to st3 (SSPC-SP3)	Red Oxide Zinc Phosphate Primer to IS: 12744 (Two coats);DFT per coat-30micron) Idler roller shall be applied with two coats of 70 microns at shop	60	Synthetic Enamel to IS 2932 Shade: Grey white RAL 9002 (Two coats)
16	Limestone Silo- Inside surfaces (Conical portion) (For temporary protection, until erection only)	FW731	Blast cleaning to Sa 2½ (Near white metal) with surface profile 35-50µm conforming to ISO 8501-1	Primer: Two coats of Red Oxide Zinc phosphate primer to IS: 12744 (SS lining is inside the Limestone silo conical portion, hence primer is only envisaged; SS lining will be done at shops itself)	60	NIL
17	Limestone Silo- Inside surfaces (Cylindrical portion) (For temporary protection, until erection only)	FW731	Blast cleaning to Sa 2½ (Near white metal) with surface profile 40-60µm conforming to ISO 8501-1	Primer Coat: One coat of two component moisture curing Inorganic Ethyl Zinc Silicate Primer to IS 14946, (Solid by volume- 60% (mir)), (Metallic zinc content 80% (min)) DFT = 70 µm per coat (min.) Zinc dust composition shall be Type-II as per ASTM D520-00	70	--

Project		BHEL, Ranipet - 632 406, India. Quality Assurance Department. Painting Scheme		BHEL DOC No: PS:BHIL:FGD:G211 Rev: 04 Dt: 10/12/2020 NTPC Contract No: CC/CC&M-C-568-FC-NOA/141 Dt: 26/08/2019 NTPC Doc No: 9993-109-PVM-H-001 Rev: 04 Dt: 10/12/2020				
		FGD Package for NSPCL - BHILAI Expansion Power Project (2x250 MW) - BHEL Cust Nos: G211-G212		Primer & Intermediate Coats	Finish Coat			
SI No	Surface Location	PGMA	Surface Preparation	Paint	DFT(µm min)	Total DFT (µm min)		
18	Air cannon silo, Bag filter & Fan assy, Nozzles& Flanges (Clause 20.03.00 of Part-C Section VI)	FW723, FW724, FW725	Power Tool Cleaning to St3 (SSPC-SP3)	Red Oxide Zinc Phosphate Primer to IS: 12744 (Two coats)	60	40	Synthetic Enamel to IS 2932 Shade: Grey white RAL 9002 (Two coats)	100
19	Limestone silo approach platform, Platform for Pipe racks & Sub pipe racks (Clause 31.06.00 of Sec.VI, Part-B, Subsection- IV-D)	FW733, FW766, FW767	Blast cleaning to Sa 2½/ Acid pickling	Hand rails, Gratings- Hot dip galvanizing to 610gms/sq.m (minimum) as per IS: 4736 and to a coating thickness of 87µm (min).				
20	Limestone silo approach platform, Pipe racks, Sub pipe racks platform- Structures other than the above (Clause 31.03.00 of Sec.VI, Part-B, Subsection- IV-D)	FW733, FW766, FW767	Blast cleaning to Sa 2½ (Near white metal) with surface profile 40-60µm conforming to ISO 8501-1	<p>Primer: One coat of Two component moisture curing zinc (ethyl) silicate primer coat (Min 80% metallic zinc content in dry film, solid by volume minimum 60% ±2). Zinc dust composition and properties shall be as per Type II as per ASTM D520-00 DFT- 70µ</p> <p>Intermediates: One coat of Two component polyamide cured epoxy with MIO content (containing lamellar MIO Min 30% on pigment, solid by volume min. 80%±2) DFT- 100µ</p>	70	70	<p>Finish: Two coats of two pack aliphatic isocyanate cured acrylic polyurethane paint to IS 13213 solid by volume min.55%±2 DFT- 35µ/ coat Shade: Grey white, RAL 9002</p> <p>With gloss retention (SSPC paint spec no.36, ASTM D4587, D2244, D523 of level 2 after min. 1000 hrs exposure, gloss less than 30 and colour change less than 2.0Δ E)</p>	240

		BHEL, Ranipet - 632 406, India. Quality Assurance Department. Painting Scheme		BHEL DOC No: PS:BHIL:FGD:G211 Rev: 04 Dt: 10/12/2020 NTPC Contract No: CC/CC&M-C-568-FC-NOA/141 Dt: 26/08/2019 NTPC Doc No: 9993-109-PVM-H-001 Rev: 04 Dt: 10/12/2020		
Project						
FGD Package for NSPCL - BHILAI Expansion Power Project (2x250 MW) - BHEL Cust Nos: G211-G212						
Sl No	Surface Location	PGMA	Surface Preparation	Primer & Intermediate Coats		Total DFT (µm min)
				Paint	DFT (µm min)	

21	Limestone Mill – Outside surfaces; Gypsum belt filter and accessories Structural items (Clause 1.04.00 of Part-A Section VI)	FW735; FW738	Blast cleaning to Sa 2½	Primer: Two coats of Epoxy resin based Epoxy Zinc phosphate primer to IS 13238 DFT- 50µj/coat Intermediate: One coat of Two component epoxy based intermediate paint pigmented with TiO2 DFT- 100µj	100	Finish: One coat of Epoxy based finish paint with glossy finish to IS 14209; DFT- 75µ Finish: One coat of acrylic aliphatic polyurethane paint to IS 13213 DFT-25µj Shade: Grey White, RAL9002	75 25	300
21 Δ	Limestone mill- Inside surfaces (For temporary protection, until erection only)	FW735	Blast cleaning to Sa 2½ (Near white metal) with surface profile 40-60µm conforming to ISO 8501-1	Primer Coat: One coat of two component moisture curing Inorganic Ethyl Zinc Silicate Primer to IS 14946, (Solid by volume- 60% (min)), (Metallic zinc content 80% (min)) DFT = 70 µm per coat (min.) Zinc dust composition shall be Type-II as per ASTM D520-00	70	--	--	70
23	Limestone slurry storage tank, Auxiliary absorber tank, Filtrate tank, Wastage water tank, Hydro cyclone waste water tank, Neutralization tank, Process Water tank, Belt filter washing tank, Primary hydro cyclone feed tank, Clarified water tank - Outside surfaces (Clause 31.03.00 of Sec.VI, Part-B, Subsection- IV-D)	FW742, FW743, FW744, FW745, FW747, FW748, FW785, FW786, FW800, FW802	Blast cleaning to Sa 2½ (Near white metal) with surface profile 40-60µm conforming to ISO 8501-1	Primer: One coat of Two component moisture curing zinc (ethyl) silicate primer coat (Min 80% metallic zinc content in dry film, solid by volume minimum 60% ±2). Zinc dust composition and properties shall be as per Type II as per ASTM D520-00 DFT- 70µj Intermediate: One coat of Two component polyamide cured epoxy with MIO content (containing	70	Finish: Two coats of two pack aliphatic isocyanate cured acrylic polyurethane paint to IS 13213 solid by volume min.55%±2 DFT- 35µj/ coat Shade: Grey white, RAL 9002 With gloss retention (SSPC paint spec no.36, ASTM D4587, D2244, D523 of level 2 after min. 1000 hrs exposure, gloss less than 30 and colour change less than 2.0Δ E)	70	240

Project		BHEL, Ranipet - 632 406, India. Quality Assurance Department. Painting Scheme		BHEL DOC No: PS:BHIL:FGD:G211 Rev: 04 Dt: 10/12/2020 NTPC Contract No: CC/CC&M-C-568-FC-NOA/141 Dt: 26/08/2019 NTPC Doc No: 9993-109-PVM-H-001 Rev: 04 Dt: 10/12/2020				
		FGD Package for NSPCL - BHILAI Expansion Power Project (2x250 MW) - BHEL Cust Nos: G211-G212						
Sl No	Surface Location	PGMA	Surface Preparation	Primer & Intermediate Coats		Finish Coat		Total DFT (µm min)
				Paint	DFT (µm min)	Paint	DFT (µm min)	
24	Limestone slurry storage tank, Auxiliary absorber tank, Filtrate tank, Wastage water tank, Hydrocyclone waste water tank, Neutralization tank, Process Water tank, Belt filter washing tank, Primary Hydrocyclone feed tank, Clarified water tank, Tank internal structure - Inside surfaces - (For temporary protection, until erection only)	FW742, FW743, FW744, FW745, FW747, FW748, FW749, FW800, FW802	Blast cleaning to Sa 2½ (Near white metal) with surface profile 35-50µm	lamellar MIO Min 30% on pigment, solid by volume min. 80%±2) DFT- 100µ	60	NIL	--	60
25 Δ	Process water pipe accessories, Cooling pipe accessories; Slurry pipe accessories (Cl 2.17.00 of Sub Section-I M7 of Part B of Section VI)	FW751, FW752; FW753	Power Tool Cleaning to S13 (SSPC-SP3)	Primer: Red Oxide Zinc Phosphate Primer to IS: 12744 (Two coats) DFT- 30µ / Coat; Intermediate: One coat of Synthetic Enamel intermediate coat to IS 2932; DFT- 30µ	60	Finish: Two coats of Synthetic Enamel to IS 2932, DFT- 35µ/ coat Shade: Grey white RAL 9002 Identification Tag: Sea Green Shade no: 217 as per IS 5	70	160
26 Δ	Service Air pipe accessories; Instrument air pipe accessories	FW754; FW755	Power Tool Cleaning to S13 (SSPC-SP3)	Red Oxide Zinc Phosphate Primer to IS: 12744 (Two coat); DFT- 30µ / Coat	60	Synthetic Enamel to IS 2932 Shade: Grey white RAL 9002 (Two coats)- 35µ/ coat	70	160

Project		BHEL, Ranipet - 632 406, India. Quality Assurance Department. Painting Scheme		BHEL DOC No: PS:BHIL:FGD:G211 Rev: 04 Dt: 10/12/2020 NTPC Contract No: CC/CC&M-C-568-FC-NOA/141 Dt: 26/08/2019 NTPC Doc No: 9993-109-PVM-H-001 Rev: 04 Dt: 10/12/2020				
		FGD Package for NSPCL - BHILAI Expansion Power Project (2x250 MW) - BHEL Cust Nos: G211-G212						
Sl No	Surface Location	PGMA	Surface Preparation	Primer & Intermediate Coats		Finish Coat		Total DFT (µm min)
				Paint	DFT (µm min)	Paint	DFT (µm min)	
	(Cl 2.17.00 of Sub Section-I-M7 of Part B of Section VI)			Intermediate: One coat of Synthetic Enamel intermediate coat to IS 2932; DFT- 30µ	30	Identification Tag: Sky Blue Shade no: 101 as per IS 5		
27	All valves (Temp <95°C) (Clause 20.03.00 of Part- C Section VI)	FW815 to FW851	Power Tool Cleaning to St3 (SSPC-SP3)	Red Oxide Zinc Phosphate Primer to IS: 12744 (Two coats)	60	Synthetic Enamel to IS 2932 Shade: Grey white RAL 9002 (Two coats)- 30µ/coat	60	120
28	Structure for Pipe racks, Trestle for pipe racks, Structures inside Gypsum dewatering building & Ball mill building (Clause 31.03.00 of Sec.VI, Part-B, Subsection- IV-D)	FW761, FW768, FW769, FW787	Blast cleaning to Sa 2½ (Near white metal) with surface profile 40-60µm conforming to ISO 8501-1	Primer: One coat of Two component moisture curing zinc (ethyl) silicate primer coat (Min 80% metallic zinc content in dry film, solid by volume minimum 60% ±2). Zinc dust composition and properties shall be as per Type II as per ASTM D520-00 Intermediate: One coat of Two component polyamide cured epoxy with MIO content (containing lamellar MIO Min 30% on pigment, solid by volume min. 80%±2) DFT- 70µ	70	Finish: Two coats of two pack aliphatic isocyanate cured acrylic polyurethane paint to IS 13213 solid by volume min.-55%±2) DFT- 35µ/ coat Shade: Grey white, RAL 9002 With gloss retention (SSPC paint spec no.36, ASTM D4587, D2244, D523 of level 2 after min. 1000 hrs exposure, gloss less than 30 and colour change less than 2.0Δ E)	70	240
29	Supports for cable trays, Air receivers, commissioning & Mandatory spares, Tools & tackles (Clause 20.03.00 of Part- C Section VI)	FW779, FW798, FW988, FW996	Power Tool Cleaning to St3 (SSPC-SP3)	Red Oxide Zinc Phosphate Primer to IS: 12744 (Two coats) DFT- 100µ	60	Synthetic Enamel to IS 2932 Shade: Grey white RAL 9002 (Two coats)	40	100

		BHEL, Ranipet - 632 406, India. Quality Assurance Department. Painting Scheme		BHEL DOC No: PS:BHIL:FGD:G211 Rev: 04 Dt: 10/12/2020 NTPC Contract No: CC/CC&M-C-568-FC-NOA/141 Dt: 26/08/2019 NTPC Doc No: 9993-109-PVM-H-001 Rev: 04 Dt: 10/12/2020				
Project		FGD Package for NSPCL - BHILAI Expansion Power Project (2x250 MW) - BHEL Cust Nos: G211-G212						
Sl No	Surface Location	PGMA	Surface Preparation	Primer & Intermediate Coats		Finish Coat		Total DFT (µm min)
				Paint	DFT (µm min)	Paint	DFT (µm min)	

3. Gates & Dampers

01	Gates & Dampers > 95° C Insulated Surfaces & Uninsulated surfaces	57540, 57550, 57583	Power Tool Cleaning to ST3 (SSPC-SP3)	HR Aluminium paint to IS 13183 Gr.II (upto 400 deg C)	40	--	--	40
02	Seal air piping (Cl 10.00.00 of Section-VI, Part-B, Sub-section: I-M3)	57141	Power Tool Cleaning to ST3 (SSPC-SP3)	Red Oxide Zinc Phosphate Primer to IS: 12744 (Two coat)	60	60	Synthetic Enamel to IS 2932 Shade: Grey white RAL 9002 (Two coats)-30µ/ coat Identification Tag: Sky Blue Shade no: 101 (IS 5)	120
03	Blower with Motor, Knife Gate valve, Mandatory spares (Cl 10.00.00 of Section-VI, Part-B, Sub-section: I-M3)	57491, 57497	Power Tool Cleaning to ST3 (SSPC-SP3)	Red Oxide Zinc Phosphate Primer to IS: 12744 (Two coats)	60	40	Synthetic Enamel to IS 2932 Shade: Grey white RAL 9002 (Two coats)	100
04	Ladder, Cage for Ladder Toe Guard, Plate Floor Grill, Hand Rails, Hand Rail Post (Clause 31.06.00 of Sec.VI, Part-B, Subsection- IV-D)	57566	Blast cleaning to Sa 2½/ Acid Pickling	Hand rails, Gratings- Hot dip galvanizing to 610gms/sq.m (minimum) as per IS: 4736 and to a coating thickness of 87µm (min).				
05	Other Structural Items- Other than sl.no. 3 of above (Clause 31.03.00 of Sec.VI, Part-B, Subsection- IV-D)	57566	Blast cleaning to Sa 2½ (Near white metal) with surface profile 40-60µm conforming to ISO 8501-1	Primer: One coat of Two component moisture curing zinc (ethyl) silicate primer coat (Min 80% metallic zinc content in dry film, solid by volume minimum 60% ±2). Zinc dust composition and properties shall be as per Type II as per ASTM D520-00 DFT- 70µ	70	70	Finish: Two coats of two pack aliphatic isocyanate cured acrylic polyurethane paint to IS 13213 solid by volume min.,55%±2) DFT- 35µ/ coat Shade: Grey white, RAL 9002 With gloss retention (SSPC paint spec no.36, ASTM	240

Page: 17 of 23

		BHEL, Ranipet - 632 406, India. Quality Assurance Department. Painting Scheme		BHEL DOC No: PS:BHIL:FGD:G211 Rev: 04 Dt: 10/12/2020 NTPC Contract No: C/CC&M-C-568-FC-NOA/141 Dt: 26/08/2019 NTPC Doc No: 9993-109-PVM-H-001 Rev: 04 Dt: 10/12/2020			
Project		FGD Package for NSPCL - BHILAI Expansion Power Project (2x250 MW) - BHEL Cust Nos: G211-G212					
Sl No	Surface Location	PGMA	Surface Preparation	Primer & Intermediate Coats		Finish Coat	Total DFT (µm min)
				Paint	DFT (µm min)		

				Intermediate: One coat of Two component polyamide cured epoxy with MIO content (containing lamellar MIO Min 30% on pigment, solid by volume min. 80%±2) DFT- 100µ	100	D4587, D2244, D523 of level 2 after min. 1000 hrs exposure, gloss less than 30 and colour change less than 2.0Δ E	
--	--	--	--	--	-----	---	--

Painting specification for Material Handling portion/equipment			Surface Preparation		Primer, Intermediate & Finish	
Sl No	Surface Location	PGMA:	Surface Preparation		Primer, Intermediate & Finish	
1	Painting specification for Material Handling portion/equipment will be	FW249;FW310;FW710;FW714;FW713.	same as main equipment specified separately in this document.		same as main equipment specified separately in this document.	

4. Painting of Damaged Areas

For areas where paint has deteriorated badly by erosion and areas where the paint film has lost its adhesion property and where the steel has got rusted appreciably: These areas are to be repainted as per the following procedure:

Sl No	Surface Location	Surface Preparation	Primer, Intermediate & Finish
1	Paint damaged Components falling under SI Nos: 04,05 of Fans; SI Nos: 02, 03, 07, 09, 13, 20, 21, 23, 28 of FGD and SI no: 5 of GAD.	Hand/ Power Tool cleaning to Bare metal to minimum 6 inches peripheral area adjoining to damaged area	Primer: Zinc rich epoxy to IS 14589 or suitable primer with existing paint scheme, DFT-70µ (If Metal surface exposed) followed by intermediate & finish coat as per respective schemes. If primer is intact- Intermediate & finish as per respective schemes.
2	Paint damaged components failing under other SI Nos of Fans, FGD & GAD	Power Tool Cleaning to Bare metal	Primer and Finish: As given in respective scheme

		BHEL, Ranipet - 632 406, India. Quality Assurance Department. Painting Scheme		BHEL DOC No: PS:BHIL:FGD:G211 Rev: 04 Dt: 10/12/2020 NTPC Contract No: CC/CC&M-C-568-FC-NOA/141 Dt: 26/08/2019 NTPC Doc No: 9993-109-PVM-H-001 Rev: 04 Dt: 10/12/2020			
		Project FGD Package for NSPCL - BHILAI Expansion Power Project (2x250 MW) - BHEL Cust Nos: G211-G212					
SI No	Surface Location	PGMA	Surface Preparation	Primer & Intermediate Coats	Finish Coat	Total DFT (µm min)	
				Paint	Paint	DFT(µm min)	

General Notes:

- No painting is required for Galvanized, non-ferrous & stainless steel items, except as indicated above.
- Machined items are to be applied with coat of temporary rust preventive oil.
- PGMAs covered in sub-supplier (ie., Purchased) items viz., Agitator / slide bearing and other sub-delivery components etc., are not indicated in the above list. However, the Painting Schedule for all items supplied by all sub-suppliers and BOI under the scope of BHEL shall be same as for main equipment covered in this document.
- In sub-assy, wherever plates / sheets of thickness less than or equal to 5mm and rods are used, very minor items like clamps, small items etc. - Power Tool or Hand Tool Cleaning to SSPC - SP 3 / SP 2 shall be followed and painting under SI no:01 of Fans shall be followed.
- Ground shade/colour of finish paints and identification tag/band for equipment, fans, piping, pipe services, supporting structures and other components is followed as per NTPC doc no: QS-01-DIV-W-4 at site.
- All components covered under different PGMAs are to be painted. In case any component is left out, the same shall deemed to be included under the relevant section.
- All threaded and other surfaces of foundation bolts and its materials, insulation pins, Anchor channels, Sleeves shall be coated with temporary rust preventive fluid and during execution of civil works; the dried film of coating shall be removed using organic solvents.
- Painting requirement for all electrical equipment shall be as per the details identified in specification for the respective equipment.
- All steel structures shall be provided with painting as given in the specification. Further, painting system shall also meet the requirements of corrosivity category C3 (durability high) as per ISO 12944.
- Finish coat to be applied after an interval of min 10 hrs and within 6 months (after completion of intermediate coat).
- Primer coat on steel shall be applied in shop immediately after blast cleaning by airless spray technique.
- For the portion of steel surfaces embedded in concrete, the surface shall be prepared by Manual cleaning and provided with Primer coat of Chlorinated Rubber based Zinc Phosphate Primer of Minimum 50 Micron DFT.

	BHEL, Ranipet - 632 406, India.		BHEL DOC No: PS:BHIL:FGD:G211 Rev: 04 Dt: 10/12/2020			
	Quality Assurance Department.		NTPC Contract No: C/CC&M-C-568-FC-NOA/141 Dt: 26/08/2019			
Painting Scheme		NTPC Doc No: 9993-109-PVM-H-001 Rev: 04 Dt: 10/12/2020				
Project	FGD Package for NSPCL - BHILAI Expansion Power Project (2x250 MW) - BHEL Cust Nos: G211-G212					
Sl No	Surface Location	PGMA	Surface Preparation	Primer & Intermediate Coats	Finish Coat	Total DFT (µm min)
				Paint	Paint	

Painting Scheme - Details of Procurement & Application Processes

Sl No	Type of Paint	Specification of Paint	No of Packs	Volume of Solids (% Min)	Mode of Application	Min. Over Coating Interval (Hours)	Shade
01	Epoxy Zinc phosphate primer	IS 13238	2	40	Spray	24	Grey
02	Zinc Ethyl silicate primer (% Zn on dry film= 80 (min))	IS 14946	2	60	Airless Spray only At Shop	24	Grey
03	Epoxy High solid-Polyamide cured Epoxy based MIO pigmented intermediate coat	--	2	80	Airless Spray only At Shop	16	Brown
04	Aliphatic isocyanate acrylic polyurethane paint	IS 13213	2	55	Spray At Shop	16	Windows Grey RAL 7040
05	Heat resistant aluminum paint	IS 13183 Grade II	1	--	Brush/ Spray	24	--
06	Long oil alkyd Synthetic enamel finish paint	IS 2932	1	35	Brush/ Spray	12	Corresponding shade no
07	Synthetic Enamel Intermediate coat	IS 2932	1	40	Brush/ Spray	12	--
08	Red oxide Zinc phosphate primer	IS 12744	1	--	Brush/ spray	12	--

	BHEL, Ranipet - 632 406, India. Quality Assurance Department. Painting Scheme				BHEL DOC No: PS:BHIL:FGD:G211 Rev: 04 Dt: 10/12/2020 NTPC Contract No: CC/CC&M-C-568-FC-NOA/141 Dt: 26/08/2019 NTPC Doc No: 9993-109-PVM-H-001 Rev: 04 Dt: 10/12/2020			
	Project		FGD Package for NSPCL - BHILAI Expansion Power Project (2x250 MW) - BHEL Cust Nos: G211-G212					
SI No	Surface Location	PGMA	Surface Preparation	Primer & Intermediate Coats		Finish Coat		Total DFT (µm min)
				Paint	DFT (µm min)	Paint	DFT (µm min)	

PGMA Description & Product Details

SI No	PGMA	PGMA Description	Product /Items Details
01	FW212	Slurry recirculation pump system	RC Pumps incl Shaft seal, Common Base Plate, Coupling and Guard, Gear Box, Expansion Bellow, Anchor Bolts & Fasteners, Special Tools
02	FW219	Absorber system base	Absorber tank bottom plate
03	FW220	Absorber system structures	Absorber tank structure, Absorber tower structure, Spray headers structure
04	FW221	Absorber system casing bottom	Absorber tank wall casing- bottom
05	FW222	Absorber system casing top	Absorber Tank wall casing -Top, Mist Eliminator supports, Spray pipe supports, Internal Beam, Shim plates in Absorber area, Internal Struts
06	FW223	Absorber system accessories	Nozzles and flanges, Inspection doors & Man holes, Viewing ports, Antifoam dosing equipment, Suction strainers- FRP
07	FW226	Emergency Quench water tank	Base Plate & its supports, Roof, Shell
08	FW227	Emergency Quench System	Emergency Quenching Spray Pipe, Nozzle for Emergency Pipe, Fasteners, Gaskets
09	FW230	Air oxidation System	Oxidation Blowers, Common Base Plate, Coupling and Guard, Anchor Bolts & Fasteners, Expansion Bellow, Special Tools, Suction & Discharge Silencers, Acoustic Enclosure, Water Injection cooling system, Pipe, Valves & Instruments
10	FW239	Viewing Ports	Viewing Ports
11	FW244	Oxidation air distribution System	Pipe & Fittings, Flanges, Pipe Hanger, Bottom Elbow, Bottom sliding supports
12	FW249	Handling Equip- RC Pump	Handling Equip- RC Pump
13	FW251	Expansion joint between bypass	Expansion Joints, Seal Plates & Fasteners
14	FW252	Expansion joint between scrubbers	Fabric & its fixing fasteners, Sleeves & Flanges, Gaskets
15	FW255	Ducts between bypass duct inlet & booster fan	Plates & Stiffeners, Guide Vanes
16	FW256	Ducts between Booster fan & Absorber	Plates & Stiffeners, Guide Vanes
17	FW257	Ducts between Absorber & stack	Plates & Stiffeners, Guide Vanes
18	FW260	Duct structure between bypass duct& Booster fan	Duct Supports, Gusset Plate, Divider plate, Internal Struts, Support bearings
19	FW261	Duct structure between booster fan& absorber	Duct Supports, Gusset Plate, Divider plate, Internal Struts, Support bearings
20	FW262	Structures for Elevator	Columns, Seal Plate, Bracings, Enclosure (Purlin& sheeting)

	BHEL, Ranipet - 632 406, India. Quality Assurance Department. Painting Scheme		BHEL DOC No: PS:BHIL:FGD:G211 Rev: 04 Dt: 10/12/2020 NTPC Contract No: CC/CC&M-C-568-FC-NOA/141 Dt: 26/08/2019 NTPC Doc No: 9993-109-PVM-H-001 Rev: 04 Dt: 10/12/2020				
	Project	FGD Package for NSPCL - BHILAI Expansion Power Project (2x250 MW) - BHEL Cust Nos: G211-G212					
SI No	Surface Location	PGMA	Surface Preparation	Primer & Intermediate Coats		Finish Coat	Total DFT (µm min)
				Paint	DFT (µm min)	Paint	DFT (µm min)

SI No	PGMA	PGMA Description	Product /Items Details
21	FW293	Elevator and accessories	Base Frame, Buffer Spring, Mast Section, Cage, Control Panel & AC, Mandatory Spares
22	FW310	Structures for booster fan handling	Columns, Beams, Bracings, Seal plate
23	FW610 FW722	Galleries & railings for Scrubbers, Tank	Stairs, Handrail, Step treads, Floor grills, Ladders, Foundation bolts, Fasteners
24	FW701	Slurry pumps & accessories	Slurry Pumps incl Shaft seal, Common Base Plate, Coupling and Guard, Belt & Pulley, Expansion Bellow, Anchor Bolts & Fasteners, Motor & accessories, Sump Pumps incl Shaft seal, Common Base Plate, Coupling and Guard, Belt & Pulley, Anchor Bolts & Fasteners, Motor & accessories
25	FW710	Monorail for hoist& cranes	Insert Plate, Stiffener plate, Monorail beam
26	FW721	Agitator support	Channels & Beams
27	FW730	Limestone silo structures	Columns, Beams, Bracings, Seal plate, Angles, channels
28	FW731	Limestone silo	Base plate & its supports, Shell, Roof
29	FW723 FW724 FW725	Air cannon Bag filter Nozzles & flanges	Bag filter, Air cannon bin activator, Nozzles & Flanges
30	FW733	Limestone silo approach platforms	Stairs, Handrail, Step treads, Floor grills, Ladders, Foundation bolts, Fasteners
31	FW734	Limestone mill	Wet ball mill, Hydro cyclone- Mill area, Mill circuit pump, Mill separator tank with Agitator
32	FW742	Lime stone slurry storage tank	Base plate & its supports, Shell, Roof
33	FW743	Auxiliary Absorber tank	Base plate & its supports, Shell, Roof
34	FW744	Filtrate tank	Base plate & its supports, Shell, Roof
35	FW745	Wastage water tank	Base plate & its supports, Shell, Roof
36	FW747	Hydro cyclone waste water tank	Base plate & its supports, Shell, Roof
37	FW748 FW785 FW786	Process Water tank Belt filter washing tank Primary Hydro cyclone feed tank	Base plate & its supports, Shell, Roof
38	FW751	Process water pipe accessories	CS/FRP Pipes & Fittings, Sight Glass, R Orifice, Gaskets & Fasteners
39	FW752 FW753	Cooling water pipe accessories Slurry pipe accessories	CSRL/FRP Pipes & Fittings, Strainer (Cone), Expansion Joint-Rubber, R Orifice, Gaskets & Fasteners

	BHEL, Ranipet - 632 406, India. Quality Assurance Department. Painting Scheme		BHEL DOC No: PS:BHIL:FGD:G211 Rev: 04 Dt: 10/12/2020 NTPC Contract No: CC/CC&M-C-568-FC-NOA/141 Dt: 26/08/2019 NTPC Doc No: 9993-109-PVM-H-001 Rev: 04 Dt: 10/12/2020			
	Project		FGD Package for NSPCL - BHILAI Expansion Power Project (2x250 MW) - BHEL Cust Nos: G211-G212			
Sl No	Surface Location	PGMA	Surface Preparation	Primer & Intermediate Coats		Total DFT (µm min)
				Paint	DFT (µm min)	

SI No	PGMA	PGMA Description	Product /Items Details
40	FW754	Service air pipe accessories	GI Pipes & Fittings, Flexible Hose, Expansion Joint (Metallic), Hose connector, R Orifice, Gaskets & Fasteners
41	FW755	Instrument air pipe accessories	SS Pipes & Fittings, Strainer(Y Type), Gaskets & Fasteners
42	FW815 to FW851	Valves and fittings	Globe valves, Ball Valves, Butterfly Valves, Diaphragm Valves, Gate Valves, Check Valves, Pinch Valves, Knife Gate Valves, Control Valves, Relief Valves
43	FW761	Structures for Pipe racks	Bracings, Columns
44	FW280 FW281 FW282 FW283 FW740 FW760 FW763	Foundation material for duct structure Foundation material for absorber Foundation material for Tanks Foundation material for Pipe racks Foundation material for Elevator Foundation material for RC pump shed	Foundation bolts Template
45	FW766 FW767	Platforms for Pipe rack Platforms for Sub-Pipe rack	Stairs, Handrail, Step treads, Floor grills, Ladders, Foundation bolts, Fasteners
46	FW768 FW769	Trestle for Main & sub Pipe racks	Truss, Beams, Supports for all Pipes
47	FW779	Supports for cable tray	
48	FW996	Tools	Double Sup Channel & Base plates, Single Sup Channel & Base plates Cantilever Arm, Fasteners & clamps, Brackets
49	FW798	Air receivers	Erection, commissioning, special tools
50	FW800	Clarified water tank	Instrument Air receivers, Any Instruments/Valves
51	FW802	Neutralization tank & accessories	Base plate & its supports, Shell, Roof
52	FW988 FW997 FW999	Commissioning spares & Mandatory spares	Base plate & its supports, Shell, Roof Startup & commissioning spares, Mandatory spares

NTPC Limited

(A Government of India Enterprise)



LOT-2 PROJECTS

PART - C

GENERAL TECHNICAL REQUIREMENTS

SECTION – VI

FOR

**FLUE GAS DESULPHURISATION (FGD)
SYSTEM PACKAGE**

BIDDING DOCUMENT NO.: CS-0011-109(2)-9

THIS IS PART OF TECHNICAL SPECIFICATION PE-TS-468-571-A901 REV 00.



PART - C

GENERAL TECHNICAL REQUIREMENTS

THIS IS PART OF TECHNICAL SPECIFICATION PE-TS-468-571-A901 REV 00.

**LOT-2 PROJECTS
FLUE GAS DESULPHURISATION (FGD) SYSTEM PACKAGE**

**TECHNICAL SPECIFICATION
SECTION-VI, PART-C
BID DOC NO: CS-0011-109(2)-9**



GENERAL TECHNICAL REQUIREMENTS

PART - C

CONTENTS

Clause No.	Description	Page No.
1.00.00	Introduction	1
2.00.00	Brand Name	1
3.00.00	Base Offer & Alternate Proposals	1
4.00.00	Completeness of Facilities	1
5.00.00	Codes & Standards	2
6.00.00	Equipment Functional Guarantee	4
7.00.00	Design of Facilities/ Maintenance & Availability Considerations	5
8.00.00	Documents, Data and Drawings to be furnished by Contractor	5
9.00.00	Technical Co-ordination Meeting	21
10.00.00	Design Improvements	22
11.00.00	Equipment Bases	22
12.00.00	Protective Guards	22
13.00.00	Lubricants, Servo fluids and Chemicals	22
14.00.00	Lubrication	23
15.00.00	Material of Construction	23
16.00.00	Rating Plates, Name Plates & Labels	23
17.00.00	Tools and Tackles	24
18.00.00	Welding	25



Clause No.	Description	Page No.
19.00.00	Colour Code for All equipments/Pipings/PlpeServices	25
20.00.00	Protection and Preserveative shop Coating	25
21.00.00	Quality Assurance Programme	26
22.00.00	General Requirements - Quality Assurance	27
23.00.00	Quality Assurance Documents	32
24.00.00	Project Manager's Supervision	34
25.00.00	Inspection, Testing and Inspection Certificates	35
26.00.00	Pre-commissioning and Commissioning Facilities	38
27.00.00	Taking over	41
28.00.00	Training of Employer's Personnel	41
29.00.00	Safety Aspects during Construction and Erection	42
30.00.00	Noise Level	42
31.00.00	Packaging and Transportation	42
32.00.00	Electrical Equipments/Enclosures	43
33.00.00	Instrumentation and Control	43
34.00.00	Electrical Noise Control	44
35.00.00	Surge protection for solid state equipment	44
36.00.00	Instrument Air System	44
37.00.00	Tapping Points for Measurements	45
38.00.00	System Documentation	45
39.00.00	Maintenance Manuals of Electronic Modules	45

LOT-2 PROJECTS
FLUE GAS DESULPHURISATION (FGD) SYSTEM PACKAGE

TECHNICAL SPECIFICATION
SECTION-VI, PART-C
BID DOC NO: CS-0011-109(2)-9

THIS IS PART OF TECHNICAL SPECIFICATION PE-TS-468-571-A901 REV 00.



Clause No.	Description	Page No.
Annexure - I		76
Annexure - II		77
Annexure - III		78
Annexure - IV		79
Annexure - V		80
Annexure - VI		81
Annexure - VII		83

THIS IS PART OF TECHNICAL SPECIFICATION PE-TS-468-571-A901 REV 00.

CLAUSE NO.	GENERAL TECHNICAL REQUIREMENTS			
1.00.00	<p>INTRODUCTION</p> <p>This part covers technical requirements which will form an integral part of the Contract. The following provisions shall supplement all the detailed technical specifications and requirements brought out in Section-VI, the Technical Specification and the Technical Data Sheets.</p>			
2.00.00	<p>BRAND NAME</p> <p>Whenever a material or article is specified or described by the name of a particular brand, manufacturer or vendor, the specific item mentioned shall be understood to be indicative of the function and quality desired, and not restrictive; other manufacturer's products may be considered provided sufficient information is furnished to enable the Employer to determine that the products proposed are equivalent to those named.</p>			
3.00.00	<p>BASE OFFER & ALTERNATE PROPOSALS</p> <p>The Bidder's proposal shall be based upon the use of equipment and material complying fully with the requirements specified herein. It is recognised that the Contractor may have standardized on the use of certain components, materials, processes or procedures different than those specified herein. Alternate proposals offering similar equipment based on the manufacturer's standard practice will also be considered, provided the base offer is in line with technical specifications and such proposals meet the specified design standards and performance requirement and are acceptable to the Employer. Sufficient amount of information for justifying such proposals shall be furnished to Employer alongwith the bid to enable the Employer to determine the acceptability of these proposals.</p>			
4.00.00	<p>COMPLETENESS OF FACILITIES</p>			
4.01.00	<p>Bidders may note that this is a contract inclusive of the scope as indicated elsewhere in the specification. Each of the plant shall be engineered and designed in accordance with the specification requirement. All engineering and associated services are required to ensure a completely engineered plant shall be provided.</p>			
4.02.00	<p>All equipments furnished by the Contractor shall be complete in every respect, with all mountings, fittings, fixtures and standard accessories normally provided with such equipment and/or those needed for erection, completion and safe operation of the equipment and for the safety of the operating personnel, as required by applicable codes, though they may not have been specifically detailed in the respective specifications, unless included in the list of exclusions.</p> <p>All same standard components/ parts of same equipment provided, shall be interchangeable with one another.</p>			
<p align="center">LOT-2 PROJECTS FLUE GAS DESULPHURISATION (FGD) SYSTEM PACKAGE</p>	<p align="center">TECHNICAL SPECIFICATION SECTION – VI BID DOC. NO.:CS-0011-109(2)-9</p>	<p align="center">PART-C GENERAL TECHNICAL REQUIREMENTS</p>	<p align="center">PAGE 1 OF 83</p>	

CLAUSE NO.	GENERAL TECHNICAL REQUIREMENTS		
4.03.00	For the C&I systems, the Contractor shall be required to provide regular information about future upgrades and migration paths to the Employer.		
5.00.00	RULES, REGULATIONS, CODES & STANDARDS		
5.01.00	<p>In addition to the codes and standards specifically mentioned in the relevant technical specifications for the equipment / plant / system, all equipment parts, systems and works covered under this specification shall comply with all currently applicable statutory regulations and safety codes of the Republic of India, NTPC rules/codes of practices as well as of the locality where they will be installed, including the following:</p> <ul style="list-style-type: none"> a) Indian Electricity Act b) Indian Electricity Rules c) Indian Explosives Act d) Indian Factories Act and State Factories Act e) Indian Boiler Regulations (IBR) f) Regulations of the Central Pollution Control Board, India g) Regulations of the Ministry of Environment & Forest (MoEF), Government of India h) Pollution Control Regulations of Department of Environment, Government of India i) State Pollution Control Board. (j.) Rules for Electrical installation by Tariff Advisory Committee (TAC). (k.) Building and other construction workers (Regulation of Employment and Conditions of services) Act, 1996 (l.) Building and other construction workers (Regulation of Employment and Conditions of services) Central Rules, 1998 (m.) Explosive Rules, 1983 (n.) Petroleum Act, 1984 (o.) Petroleum Rules, 1976, 		
<p align="center">LOT-2 PROJECTS FLUE GAS DESULPHURISATION (FGD) SYSTEM PACKAGE</p>	<p align="center">TECHNICAL SPECIFICATION SECTION – VI BID DOC. NO.:CS-0011-109(2)-9</p>	<p align="center">PART-C GENERAL TECHNICAL REQUIREMENTS</p>	<p align="center">PAGE 2 OF 83</p>





CLAUSE NO.	GENERAL TECHNICAL REQUIREMENTS			
5.02.00	<p>(p.) Gas Cylinder Rules, 1981</p> <p>(q.) Static and Mobile Pressure Vessels (Unified) Rules, 1981</p> <p>(r.) Workmen's Compensation Act, 1923</p> <p>(s.) Workmen's Compensation Rules, 1924</p> <p>(t.) NTPC Safety Rules for Construction and Erection</p> <p>(u.) NTPC Safety Policy</p> <p>(v.) Any other statutory codes / standards / regulations, as may be applicable.</p> <p>Unless covered otherwise in the specifications, the latest editions (as applicable as on date of bid opening), of the codes and standards given below shall also apply:</p> <p>a) Bureau of Indian standards (BIS)</p> <p>b) Japanese Industrial Standards (JIS)</p> <p>c) American National Standards Institute (ANSI)</p> <p>d) American Society of Testing and Materials (ASTM)</p> <p>e) American Society of Mechanical Engineers (ASME)</p> <p>f) American Petroleum Institute (API)</p> <p>g) Standards of the Hydraulic Institute, U.S.A.</p> <p>h) International Organisation for Standardisation (ISO)</p> <p>i) Tubular Exchanger Manufacturer's Association (TEMA)</p> <p>j) American Welding Society (AWS)</p> <p>k) National Electrical Manufacturers Association (NEMA)</p> <p>l) National Fire Protection Association (NFPA)</p> <p>m) International Electro-Technical Commission (IEC)/European Norm (EN)</p> <p>n) Expansion Joint Manufacturers Association (EJMA)</p> <p>o) Heat Exchange Institute (HEI)</p>			
<p align="center">LOT-2 PROJECTS FLUE GAS DESULPHURISATION (FGD) SYSTEM PACKAGE</p>	<p align="center">TECHNICAL SPECIFICATION SECTION – VI BID DOC. NO.:CS-0011-109(2)-9</p>	<p align="center">PART-C GENERAL TECHNICAL REQUIREMENTS</p>	<p align="center">PAGE 3 OF 83</p>	

CLAUSE NO.	GENERAL TECHNICAL REQUIREMENTS			
5.03.00	p) IEEE standard			
	q) JEC standard			
5.04.00	Other International/ National standards such as DIN, JIS, VDI, EN, BS, GOST etc. shall also be accepted for only material codes and manufacturing standards, subject to the Employer's approval, for which the Bidder shall furnish, adequate information to justify that these standards are equivalent or superior to the standards mentioned above. In all such cases the Bidder shall furnish specifically the variations and deviations from the standards mentioned elsewhere in the specification together with the complete word to word translation of the standard that is normally not published in English.			
5.05.00	Not used.			
5.06.00	In the event of any conflict between the codes and standards referred to in the above clauses and the requirement of this specification, the requirement of Technical Specification shall govern.			
5.07.00	Two (2) English language copies of all national and international codes and/or standards used in the design of the plant, equipment, civil, structural and architectural works shall be provided by the Contractor to the Employer within two calendar months from the date of the Notification of Award.			
5.08.00	In case of any change in codes, standards & regulations between the date of bid opening and the date when vendors proceed with fabrication, the Employer shall have the option to incorporate the changed requirements or to retain the original standard. It shall be the responsibility of the Contractor to bring to the notice of the Employer such changes and advise Employer of the resulting effect.			
6.00.00	A detailed list of standards apart from those mentioned in the respective detailed specifications in other parts of Section-VI to which all equipment/systems/civil works should conform as indicated in this Part C and elsewhere in the specification.			
6.01.00	EQUIPMENT FUNCTIONAL GUARANTEE			
6.02.00	The functional guarantees of the equipment under the scope of the Contract is given in Section-VI Part - A of Technical Specifications. These guarantees shall supplement the general functional guarantee provisions covered under Defect liabilities Section-IV, General Conditions of Contract.			
	Liquidated damages for shortfall in meeting functional guarantee(s) during the performance and guarantee tests shall be assessed and recovered from the Contractor as specified elsewhere in this specification.			
LOT-2 PROJECTS FLUE GAS DESULPHURISATION (FGD) SYSTEM PACKAGE	TECHNICAL SPECIFICATION SECTION – VI BID DOC. NO.:CS-0011-109(2)-9	PART-C GENERAL TECHNICAL REQUIREMENTS	PAGE 4 OF 83	

CLAUSE NO.	GENERAL TECHNICAL REQUIREMENTS			
7.00.00	DESIGN OF FACILITIES/ MAINTENANCE & AVAILABILITY CONSIDERATIONS			
7.01.00	DESIGN OF FACILITIES			
	<p>All the design procedures, systems and components proposed shall have already been adequately developed and shall have demonstrated good reliability under similar conditions elsewhere.</p>			
	<p>The Contractor shall be responsible for the selection and design of appropriate equipments to provide the best co-ordinated performance of the entire system. The basic requirements are detailed out in various clauses of the Technical Specifications. The design of various components, assemblies and subassemblies shall be done so that it facilitates easy field assembly and dismantling. All the rotating components shall be so selected that the natural frequency of the complete unit is not critical or close to the operating range of the unit.</p>			
7.02.00	MAINTENANCE AND AVILABILITY CONSIDERATIONS			
	<p>Equipment/works offered shall be designed for high availability, low maintenance and ease of maintenance. The Bidder shall specifically state the design features incorporated to achieve high degree of reliability/ availability and ease of maintenance. The Bidder shall also furnish details of availability records in the reference plants stated in his experience list.</p>			
	<p>Bidder shall state in his offer the various maintenance intervals, spare parts and man-hour requirement during such operation. The intervals for each type of maintenance namely inspection of the furnace, inspection of the entire hot gas path and the minor and major overhauls shall be specified in terms of fired hours , clearly defining the spare parts and man-hour requirement for each stage.</p>			
	<p>Lifting devices i.e. hoists and chain pulley jacks ,etc. shall be provided by the contractor for handling of any equipment or any of its part having weight in excess of 500 Kgs during erection and maintenance activities.</p>			
	<p>Lifting devices like lifting tackles, slings, etc. to be connected to hook of the hoist / crane shall be provided by the contractor for lifting the equipment and accessories covered under the specification.</p>			
8.00.00	DOCUMENTS, DATA AND DRAWINGS TO BE FURNISHED BY CONTRACTOR			
8.01.00	<p>Bidders may note that this is a contract inclusive of the scope as indicated elsewhere in the specification. Each of the plant and equipment shall be fully integrated, engineered and designed to perform in accordance with the technical specification. All engineering and technical services required to ensure a completely</p>			
LOT-2 PROJECTS FLUE GAS DESULPHURISATION (FGD) SYSTEM PACKAGE		TECHNICAL SPECIFICATION SECTION – VI BID DOC. NO.:CS-0011-109(2)-9	PART-C GENERAL TECHNICAL REQUIREMENTS	PAGE 5 OF 83

CLAUSE NO.	GENERAL TECHNICAL REQUIREMENTS			
8.02.00	<p>engineered plant shall be provided in respect of mechanical, electrical, control & instrumentation, civil & structural works as per the scope.</p> <p>Each main and auxiliary equipment/item of the plant including instruments shall be assigned a unique tag number. The assignment of tag numbers shall be in accordance with KKS system. In all drawings/documents/data sheet etc. KKS tag number of the equipment/item/instrument etc. shall be indicated.</p> <p>The Contractor shall furnish engineering data /drawings in accordance with the schedule of information as specified in Technical Data Sheets and Technical Specification.</p> <p>A comprehensive engg and quality coordination procedure shall be finalized with the successful bidder covering salient features as described in this section of specifications.</p> <p>The number of copies/prints/CD-ROMs/manuals to be furnished for various types of document is given in Annexure-VI to this Part-C, Section-VI of the Technical Specification.</p>			
8.03.00	<p>The documentation that shall be provided by the Contractor is indicated in the various sections of specification. This documentation shall include but not be limited to the following:</p>			
8.03.01	<p>A) BASIC ENGINEERING DOCUMENTATION</p> <p>Prior to commencement of the detailed engineering work, the Contractor shall furnish a Plant Definition Manual within 12 weeks from the date of the Notification of Award. This manual shall contain the following as a minimum:</p> <ul style="list-style-type: none"> i) System description of all the mechanical, electrical, control & instrumentation & civil systems. ii) Technology scan for each system / sub-system & equipment. iii) Selection of appropriate technology / schemes for various systems/ subsystems including techno-economic studies between various options. iv) Optimisation studies including thermal cycle optimisation. v) Sizing criteria of all the systems, sub-systems/ equipments/ structures/ equipment foundations alongwith all calculations justifying and identifying the sizing and the design margins. vi) Schemes and Process & Instrumentation diagrams for the various systems/ sub-system with functional write-ups. 			
<p align="center">LOT-2 PROJECTS FLUE GAS DESULPHURISATION (FGD) SYSTEM PACKAGE</p>	<p align="center">TECHNICAL SPECIFICATION SECTION – VI BID DOC. NO.:CS-0011-109(2)-9</p>	<p align="center">PART-C GENERAL TECHNICAL REQUIREMENTS</p>	<p align="center">PAGE 6 OF 83</p>	

CLAUSE NO.	GENERAL TECHNICAL REQUIREMENTS 		
	<p>vii) Operation Philosophy and the control philosophy of the equipments/system covered under the scope.</p> <p>ix) General Layout plan of the FGD System incorporating all facilities in Bidder's as well as those in the Employer's scope. This drawing shall also be furnished in the form of CD-ROMs to the Employer for engineering of areas not included in bidder's scope.</p> <p>x) Basic layouts and cross sections of the main plant building (various floor elevations), boiler, fuel oil area and other areas included in the scope of the bidder.</p> <p>xi) Documentation in respect of Quality Assurance System as listed out elsewhere in this specification.</p> <p>The successful bidder shall furnish within three (3) weeks from the date of Notification of Award, a list of contents of the Plant Definition Manual (PDMs) including techno-economic studies, which shall then be mutually discussed & finalised with the Employer.</p> <p>B) DETAILED ENGINEERING DOCUMENTS</p> <p>i) General layout plan of the FGD System.</p> <p>ii) Layouts, general arrangements, elevations and cross-sections drawings for all the equipment and facilities of the plant.</p> <p>iii) Flow diagram, process and instrumentation diagrams along with write up and system description.</p> <p>iv) Performance curves for Absorber</p> <p>v) Piping isometric, composite layout and fabrication drawings.</p> <p>vi) Piping engineering diagrams, pipe and fittings schedules, valve schedules, hanger and support schedules, insulation schedules.</p> <p>vii) Technical data sheets for all bought out and manufactured items. Contractor shall use the Employer's specifications as a base for placement of orders on their sub vendors.</p> <p>viii) Detailed design calculations for components, system, piping etc., wherever applicable including sizing calculations for all auxiliaries like mills, fans etc- as per criteria specified elsewhere in specification.</p> <p>ix) Absorber sizing calculations. Absorber performance data.</p>		
LOT-2 PROJECTS FLUE GAS DESULPHURISATION (FGD) SYSTEM PACKAGE	TECHNICAL SPECIFICATION SECTION – VI BID DOC. NO.:CS-0011-109(2)-9	PART-C GENERAL TECHNICAL REQUIREMENTS	PAGE 7 OF 83

CLAUSE NO.	GENERAL TECHNICAL REQUIREMENTS			
	<ul style="list-style-type: none"> x) Mass Balance Diagram xi) Characteristic Curves/ Performance Correction Curves. xii) Comprehensive list of all terminal points which interface with Employer's facilities, giving details of location, terminal pressure, temperature, fluid handled & end connection details, forces, moments etc. xiii) Power supply single line diagram, block logics, control schematics, electrical schematics, etc. xiv) Protection system diagrams and relay settings. xv) Cables schedules and interconnection diagrams. xvii) Cable routing plan. xviii) Instrument schedule, measuring point list, I/O list, Interconnection & wiring diagram, functional write-ups, and installation drawings for field mounted instruments, logic diagrams, control schematics, wiring and tubing diagrams of panels and enclosures etc. Drawings for open loop and close loop controls (both hardware and software). Motor list and valve schedule including type of actuator etc. xix) Alarm and annunciation/ Sequence of Event (SOE) list and alarms & trip set points. xx) Sequence and protection interlock schemes. xxi) Type test reports, insulation co-ordination study report xxii) Control system configuration diagrams and card circuit diagrams and maintenance details. xxiii) Detailed Control system manuals. xxiv) Detailed flow chart for digital control system. xv) Mimic diagram layout, Assignment for other application engg. drawings and documents. xxvi) Civil and Structural works drawings and documents for all structures, facilities, architectural works, foundations underground and overground works and super-structural works as included in the 			
<p style="text-align: center;">LOT-2 PROJECTS FLUE GAS DESULPHURISATION (FGD) SYSTEM PACKAGE</p>	<p style="text-align: center;">TECHNICAL SPECIFICATION SECTION – VI BID DOC. NO.:CS-0011-109(2)-9</p>	<p style="text-align: center;">PART-C GENERAL TECHNICAL REQUIREMENTS</p>	<p style="text-align: center;">PAGE 8 OF 83</p>	

CLAUSE NO.	GENERAL TECHNICAL REQUIREMENTS			
8.03.02	<p>scope of the bidder civil calculation sheets including structural analysis and design alongwith output results.</p> <p>xxvii) Underground facilities, levelling, sanitary, land scaping drawings.</p> <p>xxviii) Geotechnical investigation and site survey reports (if and as applicable).</p> <p>xxix) Model study reports wherever applicable.</p> <p>xxx) Functional & guarantee test procedures and test reports.</p> <p>xxxi) Documentation in respect of Quality Assurance System, and Documentation in respect of Commissioning, as listed out elsewhere in this specification.</p> <p>xxxii) Maintenance schedule for Absorber & auxiliaries clearly indicating interval, duration if shutdown required, manhours required and tools & tackles required for maintenance.</p> <p>The Contractor's while submitting the above documents/ drawings for approval/ reference as the case may be, shall mark on each copy of submission the reference letter alongwith the date vide which the submissions are made.</p> <p>INSTRUCTION MANUALS</p> <p>The Contractor shall make first submission of instruction manual for all the equipments covered under the Contract as per agreed engineering information schedule. The Instruction manuals shall contain full details required for erection, commissioning, operation and maintenance of each equipment. The manual shall be specifically compiled for this project. After finalisation and approval of the Employer the Instruction Manuals shall be submitted as indicated in Annexure-IV. The Contract shall not be considered to be completed for purposes of taking over until the final Instructions manuals have been supplied to the Employer. The Instruction Manuals shall comprise of the following.</p> <p>A) ERECTION MANUALS</p> <p>The erection manuals shall be submitted atleast three (3) months prior to the commencement of erection activities of particular equipment/system. The erection manual should contain the following as a minimum.</p> <p>a) Erection strategy.</p> <p>b) Sequence of erection.</p>			
<p align="center">LOT-2 PROJECTS FLUE GAS DESULPHURISATION (FGD) SYSTEM PACKAGE</p>	<p align="center">TECHNICAL SPECIFICATION SECTION – VI BID DOC. NO.:CS-0011-109(2)-9</p>	<p align="center">PART-C GENERAL TECHNICAL REQUIREMENTS</p>	<p align="center">PAGE 9 OF 83</p>	

CLAUSE NO.	GENERAL TECHNICAL REQUIREMENTS		
	<p>c) Erection instructions.</p> <p>d) Critical checks and permissible deviation/tolerances.</p> <p>e) List of tool, tackles, heavy equipments like cranes, dozers, etc.</p> <p>f) Bill of Materials</p> <p>g) Procedure for erection and General Safety procedures to followed during erection/installation.</p> <p>h) Procedure for initial checking after erection.</p> <p>i) Procedure for testing and acceptance norms.</p> <p>j) Procedure / Check list for pre-commissioning activities.</p> <p>k) Procedure / Check list for commissioning of the system.</p> <p>l) Safety precautions to be followed in electrical supply distribution during erection.</p> <p>B) OPERATION & MAINTENANCE MANUALS</p> <p>a) The manual shall be a two rim PVC bound stiff sided binder able to withstand constant usage or where a thicker type is required it shall have locking steel pins, the size of the manual shall not be larger than international size A3. The cover shall be printed with the Project Name, Services covered and Volume / Book number Each section of the manual shall be divided by a stiff divider of the same size as the holder. The dividers shall clearly state the section number and title. All written instructions within the manual not provided by the manufacturers shall be typewritten with a margin on the left hand side.</p> <p>b) The arrangement and contents of O & M manuals shall be as follows:</p> <p>1) <u>Chapter 1 - Plant Description</u>: To contain the following sections specific to the equipment/system supplied</p> <p>(a) Description of operating principle of equipment / system with schematic drawing / layouts.</p>		
<p align="center">LOT-2 PROJECTS FLUE GAS DESULPHURISATION (FGD) SYSTEM PACKAGE</p>	<p align="center">TECHNICAL SPECIFICATION SECTION – VI BID DOC. NO.:CS-0011-109(2)-9</p>	<p align="center">PART-C GENERAL TECHNICAL REQUIREMENTS</p>	<p align="center">PAGE 10 OF 83</p>

CLAUSE NO.	GENERAL TECHNICAL REQUIREMENTS 		
	<p>(b) Functional description of associated accessories / controls. Control interlock protection write up.</p> <p>(c) Integrated operation of the equipment alongwith the intended system. (This is to be given by the supplier of the Main equipment by taking into account the operating instruction given by the associated suppliers).</p> <p>(d) Exploded view of the main equipment, associated accessories and auxiliaries with description. Schematic drawing of the equipment alongwith its accessories and auxiliaries.</p> <p>(e) Design data against which the plant performance will be compared.</p> <p>(f) Master list of equipments, Technical specification of the equipment/ system and approved data sheets.</p> <p>(g) Identification system adopted for the various components, (it will be of a simple process linked tagging system).</p> <p>(h) Master list of drawings (as built drawing - Drawings to be enclosed in a separate volume).</p> <p>2) <u>Chapter 2.0 - Plant Operation</u>: To contain the following sections specific to the equipment supplied</p> <p>(a) Protection logics provided for the equipment alongwith brief philosophy behind the logic, Drawings etc.</p> <p>(b) Limiting values of all protection settings.</p> <p>(c) Various settings of annunciation/interlocks provided.</p> <p>(d) Startup and shut down procedure for equipment alongwith the associated systems in step mode.</p> <p>(e) Do's and Don'ts related to operation of the equipment.</p> <p>(f) Safety precautions to be take during normal operation. Emergency instruction on total power failure condition/lubrication failure/any other conditions.</p> <p>(g) Parameters to be monitored with normal value and limiting values.</p> <p>(h) Equipment isolating procedures.</p>		
<p align="center">LOT-2 PROJECTS FLUE GAS DESULPHURISATION (FGD) SYSTEM PACKAGE</p>	<p align="center">TECHNICAL SPECIFICATION SECTION – VI BID DOC. NO.:CS-0011-109(2)-9</p>	<p align="center">PART-C GENERAL TECHNICAL REQUIREMENTS</p>	<p align="center">PAGE 11 OF 83</p>

CLAUSE NO.	GENERAL TECHNICAL REQUIREMENTS		
	<p>(i) Trouble shooting with causes and remedial measures.</p> <p>(j) Routine testing procedure to ascertain healthiness of the safety devices alongwith schedule of testing.</p> <p>(k) Routine Operational Checks, Recommended Logs and Records</p> <p>(l) Change over schedule if more than one auxiliary for the same purpose is given.</p> <p>(m) Preservation procedure on long shut down.</p> <p>(n) System/plant commissioning procedure.</p> <p>3) <u>Chapter 3.0 - Plant Maintenance-</u> To contain the following sections specific to the equipment supplied.</p> <p>(a) Exploded view of each of the equipments. Drawings alongwith bill of materials including name, code no. & population.</p> <p>(b) Exploded view of the spare parts and critical components with dimensional drawings (In case of Electronic cards, the circuit diagram to be given) and spare parts catalogue for each equipment.</p> <p>(c) List of Special T/ P required for Overhauling /Trouble shooting including special testing equipment required for calibration etc.</p> <p>(d) Stepwise dismantling and assembly procedure clearly specifying the tools to be used, checks to be made, records to be maintained etc. Clearance to be maintained etc.</p> <p>(e) Preventive Maintenance schedules linked with running hours/calendar period alongwith checks to be carried out.</p> <p>(f) Overhauling schedules linked with running hours/calendar period alongwith checks to be done.</p> <p>(g) Long term maintenance schedules</p> <p>(h) Consumables list alongwith the estimated quantity required during normal running and during maintenance like Preventive Maintenance and Overhauling.</p> <p>(i) List of lubricants with their Indian equivalent, Lubrication Schedule including charts showing lubrication checking, testing and replacement procedure to be carried daily, weekly, monthly & at</p>		
<p align="center">LOT-2 PROJECTS FLUE GAS DESULPHURISATION (FGD) SYSTEM PACKAGE</p>	<p align="center">TECHNICAL SPECIFICATION SECTION – VI BID DOC. NO.:CS-0011-109(2)-9</p>	<p align="center">PART-C GENERAL TECHNICAL REQUIREMENTS</p>	<p align="center">PAGE 12 OF 83</p>

CLAUSE NO.	GENERAL TECHNICAL REQUIREMENTS			
8.03.03	<p>longer intervals to ensure trouble free operation and quantity required for complete replacement.</p> <p>(j) Tolerance for fitment of various components.</p> <p>(k) Details of sub vendors with their part no. in case of bought out items.</p> <p>(l) List of spare parts with their Part No, total population, life expediency & their interchangeability with already supplied spares to NTPC.</p> <p>(m) List of mandatory and recommended spare list along with manufacturing drawings, material specification & quality plan for fast moving consumable spares.</p> <p>(n) Lead time required for ordering of spares from the equipment supplier, instructions for storage and preservation of spares.</p> <p>(o) General information on the equipment such as modification carried out in the equipment from its inception, equipment population in the country / foreign country and list of utilities where similar equipments have been supplied.</p> <p>After finalization and approval of the Employer, the O & M Manuals shall be submitted as indicated in Annexure-VI. The Contract shall not be considered to be completed for purposes of taking over until the final Instructions manuals (both erection and O & M manuals have been supplied to the Employer.</p> <p>If after the commissioning and initial operation of the plant, the instruction manuals (Erection and /or O &M manuals) require modifications/additions/changes, the same shall be incorporated and the updated final instruction manuals shall be submitted by the Contractor to the Employer for records and number of copies shall be as mentioned in Annexure-VI.</p>			
8.03.03	PLANT HANDBOOK AND PROJECT COMPLETION REPORT			
8.03.03.01	PLANT HANDBOOK			
	<p>The Contractor shall submit to the Employer a preliminary plant hand book preferably in A-4 size sheets which shall contain the design and performance data of various plants, equipments and systems covering the complete project including</p> <p>i) Design and performance data.</p> <p>ii) Process & Instrumentation diagrams.</p> <p>iii) Single line diagrams.</p>			
LOT-2 PROJECTS FLUE GAS DESULPHURISATION (FGD) SYSTEM PACKAGE	TECHNICAL SPECIFICATION SECTION – VI BID DOC. NO.:CS-0011-109(2)-9	PART-C GENERAL TECHNICAL REQUIREMENTS	PAGE 13 OF 83	

CLAUSE NO.	GENERAL TECHNICAL REQUIREMENTS		
	iv) Sequence & Protection Interlock Schemes. v) Alarm and trip values. vi) Performance Curves. vii) General layout plan and layout of main plant building and auxiliary buildings viii) Important Do's & Don't's	<p>The plant handbook shall be submitted within twelve (12) months from the date of award of contract. After the incorporation of Employer's comments, the final plant handbook complete in all respects shall be submitted three (3) months before start-up and commissioning activities.</p>	
8.03.03.02	PROJECT COMPLETION REPORT	<p>The Contractor shall submit a Project Completion Report at the time of handing over the plant.</p>	
8.03.04	DRAWINGS	<p>a) i) All the FGD plant layouts shall be made in computerised 3D modelling system. The Employer reserves the right to review the 3D model at different stages during the progress of engineering. The layout drawings submitted for Employer's review shall be fully dimensioned and extracted from 3D model after interference check.</p> <p>ii) All documents submitted by the Contractor for Employer's review shall be in electronic form (soft copies) along with the desired number of hard copies as per Annexure-VI of Part-C. The soft copies shall be uploaded by the vendors in C-folders, a Web-based system of NTPC ERP, for which a username and password will be allotted to the new vendor by NTPC.</p> <p>Similarly, the vendor can download the drawings/documents, approved/ commented by NTPC, through above site.</p> <p>The soft copies of identified drawings/documents shall be in pdf format, whereas the attachments/reply to the submitted document(s) can be in .doc, .xls, .pdf, .dwg or .std formats.</p> <p>iii) Final copies of the approved drawings along with requisite number of hard copies shall be submitted as per Annexure-VI of Part-C.</p> <p>iv) Contractor shall prepare the model of all the facilities located in FLUE GAS DESULPHURISATION (FGD) SYSTEM PACKAGE (including all</p>	
LOT-2 PROJECTS FLUE GAS DESULPHURISATION (FGD) SYSTEM PACKAGE	TECHNICAL SPECIFICATION SECTION – VI BID DOC. NO.:CS-0011-109(2)-9	PART-C GENERAL TECHNICAL REQUIREMENTS	PAGE 14 OF 83

CLAUSE NO.	GENERAL TECHNICAL REQUIREMENTS			
	<p>facilities), and any other facility in an integrated & intelligent 3D software solution using rule-based, data centric 3D Design software with equipment drawings, data sheets, intelligent P&ID correlated with intelligent 3D Model, BOQ, schematics and logic diagrams etc. attached to the respective equipment / systems in the aforesaid 3D model. Contractor shall make a presentation on 3D model every 3 months from LOA to enable NTPC to review the progress of engineering. After the completion of engineering the corresponding complete 3D review model shall be handed over to the employer for its reference.</p> <p>Contractor shall provide 3D model (which shall include visual interference check, walk-through animation, video simulation for major equipment placement and removal, visual effect, photo realism etc), which is extracted from intelligent 3D model, for employer's review as & when desired by employer. However, all piping layouts, equipment layouts, floor plans, ducting layout (Air/flue gas, A/C, Ventilation etc.), General Arrangement drawings of major buildings, structural arrangement drawings and RCC layout drawings shall necessarily be extracted from the aforesaid 3D model and submitted for employer's review along with the 3D review model to enable NTPC to review and approve these drawings.</p> <p>b) All documents/text information shall be in latest version of MS Office / MS Excel / PDF FORMAT as applicable.</p> <p>c) All drawings submitted by the Contractor including those submitted at the time of bid shall be in sufficient detail indicating the type, size, arrangement, weight of each component for packing and shipment, the external connection, fixing arrangement required, the dimensions required for installation and interconnections with other equipments and materials, clearance and spaces required between various portions of equipment and any other information specifically requested in the drawing schedules.</p> <p>d) Each drawing submitted by the Contractor (including those of subvendors) shall bear a title block at the right hand bottom corner with clear mention of the name of the Employer, the system designation, the specifications title, the specification number, the name of the Project, drawing number and revisions. If standard catalogue pages are submitted the applicable items shall be indicated therein. All titles, notings, markings and writings on the drawing shall be in English. All the dimensions should be in metric units.</p> <p>e) The drawings submitted by the Contractor (or their subvendors) shall bear Employer's drawing number in addition to contractor's (their sub-vendor's) own drawing number. Employer's drawing numbering system shall be made available to the successful bidder so as to enable him to assign Employer's drawing numbers to the drawings to be submitted by him during the course of execution of the Contract.</p>			
<p align="center">LOT-2 PROJECTS FLUE GAS DESULPHURISATION (FGD) SYSTEM PACKAGE</p>	<p align="center">TECHNICAL SPECIFICATION SECTION – VI BID DOC. NO.:CS-0011-109(2)-9</p>	<p align="center">PART-C GENERAL TECHNICAL REQUIREMENTS</p>	<p align="center">PAGE 15 OF 83</p>	

CLAUSE NO.	GENERAL TECHNICAL REQUIREMENTS			
	<p>The Contractor shall also furnish a "Master Drawing List" which shall be a comprehensive list of all drawings/ documents/ calculations envisaged to be furnished by him during the detailed engineering to the Employer. Such list should clearly indicate the purpose of submission of these drawings i.e. "FOR APPROVAL" or "FOR INFORMATION ONLY".</p> <p>Similarly, all the drawings/ documents submitted by the Contractor during detailed engineering stage shall be marked "FOR APPROVAL" or "FOR INFORMATION" prior to submission. Further, space shall be identified on each drawing for Approval stamp and electronic signature.</p> <p>f) The furnishing of detailed engineering data and drawings by the Contractor shall be in accordance with the time schedule for the project. The review of these documents/ data/ drawings by the Employer will cover only general conformance of the data/ drawings/ documents to the specifications and contract, interfaces with the equipments provided by others and external connections & dimensions which might affect plant layout. The review by the Employer should not be construed to be a thorough review of all dimensions, quantities and details of the equipments, materials, any devices or items indicated or the accuracy of the information submitted. The review and/ or approval by the Employer/ Project Manager shall not relieve the Contractor of any of his responsibilities and liabilities under this contract.</p> <p>g) After the approval of the drawings, further work by the Contractor shall be in strict accordance with these approved drawings and no deviation shall be permitted without the written approval of the Employer.</p> <p>h) All manufacturing, fabrication and execution of work in connection with the equipment / system, prior to the approval of the drawings, shall be at the Contractor's risk. The Contractor is expected not to make any changes in the design of the equipment /system, once they are approved by the Employer. However, if some changes are necessitated in the design of the equipment/system at a later date, the Contractor may do so, but such changes shall promptly be brought to the notice of the Employer indicating the reasons for the change and get the revised drawing approved again in strict conformance to the provisions of the Technical Specification.</p> <p>i) Drawings shall include all installations and detailed piping layout drawings. Layout drawings for all piping of 65 mm and larger diameter shall be submitted for review/ approval of Employer prior to erection. Small diameter pipes shall however be routed as per site conditions in consultation with site authority/ representative of Employer based on requirements of such piping indicated in approved/ finalised Flow Scheme/ Process & Instrumentation Diagrams and/or the requirements cropping up for draining & venting of larger diameter piping or otherwise after their erection as per actual physical condition for the entire scope of work of this package.</p>			
<p align="center">LOT-2 PROJECTS FLUE GAS DESULPHURISATION (FGD) SYSTEM PACKAGE</p>	<p align="center">TECHNICAL SPECIFICATION SECTION – VI BID DOC. NO.:CS-0011-109(2)-9</p>	<p align="center">PART-C GENERAL TECHNICAL REQUIREMENTS</p>	<p align="center">PAGE 16 OF 83</p>	

CLAUSE NO.	GENERAL TECHNICAL REQUIREMENTS			
8.04.00	<p>Assessing & anticipating the requirement and supply of all piping and equipment shall be done by the contractor well in advance so as not to hinder the progress of piping & equipment erection, subsequent system charging and its effective draining & venting arrangement as per site suitability.</p> <p>j) As Built Drawings</p> <p>After final acceptance of individual equipment / system by the Employer, the Contractor will update all original drawings and documents for the equipment / system to “as built” conditions and submit no. of copies as per Annexure VI.</p> <p>k) Drawings must be checked by the Contractor in terms of its completeness, data adequacy and relevance with respect to Engineering schedule prior to submission to the Employer. In case drawings are found to be submitted without proper checking by the Contractor, the same shall not be reviewed and returned to the Contractor for re-submission. The contractor shall make a visit to site to see the existing facilities and understand the layout completely and collect all necessary data/ drawings at site which are needed as an input to the engineering. The contractor shall do the complete engineering including interfacing and integration of all his equipment, systems & facilities within his scope of work as well as interface engineering & integration of systems, facilities, equipment & works under Employer's scope and submit all necessary drawings/ documents for the same.</p> <p>l) The Contractor shall submit adequate prints of drawing / data / document for Employer's review and approval. The Employer shall review the drawings and return soft copy to the Contractor authorizing either to proceed with manufacture or fabrication, or marked to show changes desired. When changes are required, drawings shall be re-submitted promptly, with revisions clearly marked, for final review. Any delays arising out of the failure of the Contractor to submit/rectify and resubmit in time shall not be accepted as a reason for delay in the contract schedule.</p> <p>m) All engineering data submitted by the Contractor after final process including review and approval by the Project Manager/ Employer shall form part of the contract documents and the entire works covered under these specification shall be performed in strict conformity with technical specifications unless otherwise expressly requested by the Project Manager in writing.</p> <p>n) The Contractor shall submit drawings in line with the suggestive MDL covered in Part-B, Section-VI of Technical Specification and which shall be duly integrated with approved PERT network.</p> <p>ENGINEERING INFORMATION SUBMISSION SCHEDULE</p>			
<p>LOT-2 PROJECTS FLUE GAS DESULPHURISATION (FGD) SYSTEM PACKAGE</p>	<p>TECHNICAL SPECIFICATION SECTION – VI BID DOC. NO.:CS-0011-109(2)-9</p>	<p>PART-C GENERAL TECHNICAL REQUIREMENTS</p>	<p>PAGE 17 OF 83</p>	

CLAUSE NO.	GENERAL TECHNICAL REQUIREMENTS			
	<p>Prior to the award of Contract, a Detailed Engineering Information Submission Scheduler/Master Drawing List duly integrated with approved PERT network shall be tied up with the Employer. For this, the bidder shall furnish a detailed list of engineering information alongwith the proposed submission schedule. This list would be a comprehensive one including all engineering data / drawings / information for all bought out items and manufactured items. The information shall be categorized into the following parts.</p> <p>i) Information that shall be submitted for the approval to the Employer before proceeding further, and</p> <p>ii) Information that would be submitted for Employer's information only.</p> <p>The Master Drawing List (MDL) shall be updated periodically and submitted to the employer, highlighting the changes made in MDL.</p> <p>The schedule should allow adequate time for proper review and incorporation of changes/ modifications, if any, to meet the contract without affecting the equipment delivery schedule and overall project schedule. The early submission of drawings and data is as important as the manufacture and delivery of equipment and hardware and this shall be duly considered while determining the overall performance and progress.</p> <p>8.05.00 ENGINEERING PROGRESS AND EXCEPTION REPORT</p> <p>8.05.01 The Contractor shall submit every month an Engineering progress and Exception Report giving the status of each engineering information including</p> <p>a) A list of drawings/engineering information which remains unapproved for more than four (4) weeks after the date of first submission</p> <p>b) Drawings which were not submitted as per agreed schedule.</p> <p>8.05.02 The draft format for this report shall be furnished to the Employer within four (4) weeks of the award of the contract, which shall then be discussed and finalised with the Employer.</p> <p>8.06.00 Engineering Co-ordination Procedure</p> <p>8.06.01 The following principal coordinators will be identified by respective organizations at time of award of contract:</p> <p>NTPC Engineering Coordinator (NTPC EC):</p> <p>Name :</p>			
<p align="center">LOT-2 PROJECTS FLUE GAS DESULPHURISATION (FGD) SYSTEM PACKAGE</p>	<p align="center">TECHNICAL SPECIFICATION SECTION – VI BID DOC. NO.:CS-0011-109(2)-9</p>	<p align="center">PART-C GENERAL TECHNICAL REQUIREMENTS</p>	<p align="center">PAGE 18 OF 83</p>	

CLAUSE NO.	GENERAL TECHNICAL REQUIREMENTS			
8.06.02	<p>Designation :</p> <p>Address :</p> <p>a) Postal :</p> <p>b) Telegraphic / e-Mail :</p> <p>c) FAX : TELEPHONE :</p> <p>Contractor's/ Vendor's Engineering Coordinator (VENDOR EC):</p> <p>Name :</p> <p>Designation :</p> <p>Address :</p> <p>a) Postal :</p> <p>b) Telegraphic / e-Mail :</p> <p>c) FAX : TELEPHONE :</p> <p>All engineering correspondence shall be in the name of above coordinators on behalf of the respective organizations.</p>			
8.06.03	<p>Contractor's/Vendor's Drawing Submission and Approval Procedure:</p> <p>a) All data/information furnished by Vendor in the form of drawings/ documents/catalogues or in any other form for NTPC's information/ interface and or review and approval are referred by the general term "drawings".</p> <p>b) The 'Master drawings list' indicating titles, Drawing Number, Date of submission and approval etc. shall be finalised mutually between Contractor and Employer before the award of contract. This list shall be updated if required at suitable interval during detailed engineering.</p> <p>c) All drawings (including those of subvendor's) shall bear at the right hand bottom corner the 'title plate' with all relevant information duly filled in. The Contractor shall furnish this format to his subvendor along with his purchase order for subvendor's compliance.</p> <p>d) Employer and contractor shall follow their own numbering systems for the drawings. However, Employer shall intimate the contractor, NTPC drawing number on receipt of the first submission of each drawing. Vendor,</p>			
<p align="center">LOT-2 PROJECTS FLUE GAS DESULPHURISATION (FGD) SYSTEM PACKAGE</p>	<p align="center">TECHNICAL SPECIFICATION SECTION – VI BID DOC. NO.:CS-0011-109(2)-9</p>	<p align="center">PART-C GENERAL TECHNICAL REQUIREMENTS</p>	<p align="center">PAGE 19 OF 83</p>	

CLAUSE NO.	GENERAL TECHNICAL REQUIREMENTS			
	<p>thereafter, shall indicate NTPC's drawing number in subsequent Submission, in the space provided for this purpose in title plate, in addition to his own drawing number.</p> <p>e) The contractor shall make a visit to site to see the existing facilities and understand the layout completely and collect all necessary data / drawings at site which are needed as an input to the engineering. The contractor shall do the complete engineering including interfacing and integration of all his equipment, systems & facilities within his scope of work as well as interface engineering & integration of systems, facilities, equipment & works under Employer's scope and submit all necessary drawings/ documents for the same.</p> <p>f) Drawings must be checked by the Contractor in terms of its completeness, data adequacy and relevance with respect to engineering schedule prior to submission to the Employer. In case drawings are found to be submitted without proper endorsement for checking by the Contractor, the same shall not be reviewed and returned to the Contractor for re-submission.</p> <p>g) The Contractor shall submit adequate prints of drawing / data / document for Employer's review and approval. The drawings submitted by the Contractor/vendor shall be reviewed by NTPC and their comments shall be forwarded within four (4) weeks of receipt of drawings. Upon review of each drawing, depending on the correctness and completeness of the drawing, the same will be categorized and approval accorded in one of the following categories :</p> <p>CATEGORY- I: Approved</p> <p>CATEGORY- II Approved, subject to incorporation of comments/ modification as noted. Resubmit revised drawing incorporating the comments.</p> <p>CATEGORY –III Not approved. Resubmit revised drawings for approval after incorporating comments/ modification as noted.</p> <p>CATEGORY -IV For information and records.</p> <p>h) Contractor shall resubmit the drawings approved under Category II, III & IVR within three (3) weeks of receipt of comments on the drawings, incorporating all comments. Every revision of the drawing shall bear a revision index wherein such revisions shall be highlighted in the form of description or marked up in the drawing identifying the same with relevant revision Number enclosed in a triangle (eg. 1, 2, 3 etc). Contractor shall not make any changes in the portions of the drawing other than those commented. If changes are required to be made in the portions already approved, the</p>			
<p align="center">LOT-2 PROJECTS FLUE GAS DESULPHURISATION (FGD) SYSTEM PACKAGE</p>	<p align="center">TECHNICAL SPECIFICATION SECTION – VI BID DOC. NO.:CS-0011-109(2)-9</p>	<p align="center">PART-C GENERAL TECHNICAL REQUIREMENTS</p>	<p align="center">PAGE 20 OF 83</p>	

CLAUSE NO.	GENERAL TECHNICAL REQUIREMENTS			
	<p>Contractor shall resubmit the drawing identifying the changes for Employer's review and approval. Drawings resubmitted shall show clearly the portions where the same are revised marking the relevant revision numbers and Employer shall review only such revised portion of documents.</p> <p>i) In case, the Contractor/ Vendor does not agree with any specific comment, he shall furnish the explanation for the same to NTPC for consideration. In all such cases the Contractor shall necessarily enclose explanations along with the revised drawing (taking care of balance comments) to avoid any delay and/or duplication in review work.</p> <p>j) It is responsibility of the Contractor/ Vendor to get all the drawings approved in the Category I & IV (as the case may be) and complete engineering activities within the agreed schedule. Any delay arising out of submission and modification of drawings shall not alter the contract completion schedule.</p> <p>k) If Contractor/ Vendor fails to resubmit the drawings as per the schedule, construction work at site will not be held up and work will be carried out on the basis of comments furnished on previous issues of the drawing.</p> <p>l) These comments will be taken care by the contractor while submitting the revised drawing.</p> <p>The contractor shall use a single transmittal for drawings. Submission. This shall include transmittal numbers and date, number of copies being sent, names of the agencies to whom copies being sent, drawing number and titles, remarks or special notes if any etc.</p>			
9.00.00	TECHNICAL CO-ORDINATION MEETING			
9.01.00	<p>The Contractor shall be called upon to organise and attend monthly Design/ Technical Co-ordination Meetings (TCMs) with the Employer/Employer's representatives and other Contractors of the Employer during the period of contract. The Contractor shall attend such meetings at his own cost at NEW DELHI / NOIDA or at mutually agreed venue as and when required and fully co-operate with such persons and agencies involved during the discussions.</p>			
9.02.00	<p>The Contractor should note that Time is the essence of the contract. In order to expedite the early completion of engineering activities, the Contractor shall submit all drawings as per the agreed Engineering Information Submission Schedule. The drawings submitted by the Contractor will be reviewed by the Employer as far as practicable within three (3) weeks from the date of receipt of the drawing .The comments of the Employer shall then be discussed across the table during the above Technical Co-ordination Meeting (s) wherein best efforts shall be made by both sides to ensure the approval of the drawing.</p>			
<p align="center">LOT-2 PROJECTS FLUE GAS DESULPHURISATION (FGD) SYSTEM PACKAGE</p>	<p align="center">TECHNICAL SPECIFICATION SECTION – VI BID DOC. NO.:CS-0011-109(2)-9</p>	<p align="center">PART-C GENERAL TECHNICAL REQUIREMENTS</p>	<p align="center">PAGE 21 OF 83</p>	

CLAUSE NO.	GENERAL TECHNICAL REQUIREMENTS			
9.02.01	<p>The Contractor shall ensure availability of the concerned experts / consultants/ personnel who are empowered to take necessary decisions during these meetings. The Contractor shall be equipped with necessary tools and facilities so that the drawings/documents can be resubmitted after incorporating necessary changes and approved during the meeting itself.</p>			
9.02.02	<p>Should any drawing remain unapproved for more than six (6) weeks after it's first submission ,this shall be brought out in the monthly Engineering Progress and Exception Report with reasons thereof.</p>			
9.03.0	<p>Any delays arising out of failure by the Contractor to incorporate Employer's comments and resubmit the same during the TCM shall be considered as a default and in no case shall entitle the Contractor to alter the Contract completion date.</p>			
10.00.00	<p>DESIGN IMPROVEMENTS</p> <p>The Employer or the Contractor may propose changes in the specification of the equipment or quality thereof and if the parties agree upon any such changes the specification shall be modified accordingly.</p> <p>If any such agreed upon change is such that it affects the price and schedule of completion, the parties shall agree in writing as to the extent of any changing the price and/or schedule of completion before the Contractor proceeds with the change. Following such agreement, the provision thereof, shall be deemed to have been amended accordingly.</p>			
11.00.00	<p>EQUIPMENT BASES</p> <p>A cast iron or welded steel base plate shall be provided for all rotating equipment which is to be installed on a concrete base, unless otherwise specifically agreed to by the Employer. Each base plate shall support the unit and its drive assembly, shall be of a neat design with pads for anchoring the units, shall have a raised lip all around, and shall have threaded drain connections.</p>			
12.00.00	<p>PROTECTIVE GUARDS</p> <p>Suitable guards shall be provided for protection of personnel on all exposed rotating and/or moving machine parts. All such guards shall be designed for easy installation and removal for maintenance purpose.</p>			
13.00.00	<p>LUBRICANTS, SERVO FLUIDS AND CHEMICALS</p>			
13.01.00	<p>I. All the first fills of consumables and one years topping requirement of consumables such as greases, oil, lubricants, servo fluids / control fluids, gases and essential chemicals etc. which will be required to put the equipment covered under the scope of specifications, into successful commissioning / initial operation and to establish completion of facilities shall</p>			
<p>LOT-2 PROJECTS FLUE GAS DESULPHURISATION (FGD) SYSTEM PACKAGE</p>		<p>TECHNICAL SPECIFICATION SECTION – VI BID DOC. NO.:CS-0011-109(2)-9</p>	<p>PART-C GENERAL TECHNICAL REQUIREMENTS</p>	<p>PAGE 22 OF 83</p>

CLAUSE NO.	GENERAL TECHNICAL REQUIREMENTS		
	 <p>be supplied by the Contractor. Suitable standard lubricants as available in India are desired. Efforts should be made to limit the variety of lubricants to minimum.</p> <p>Bidder shall supply a quantity not less than 10 % of the full charge or one (1) year topping requirement mentioned above (whichever is higher) of each variety of lubricants, servo fluids, gases, chemicals etc (as detailed above) which is expected to be utilized during the first year of operation. The additional quantity shall be supplied in separate container.</p>		
13.02.00	<p>As far as possible lubricants marketed by the Indian Oil Corporation shall be used. The variety of lubricants shall be kept to a minimum possible.</p>		
	<p>Detailed specifications for the lubricating oil, grease, gases, servo fluids, control fluids, chemicals etc. required for the complete plant covered herein shall be furnished. On completion of erection, a complete list of bearings/ equipment giving their location and identification marks shall be furnished to the Employer alongwith lubrication requirements.</p>		
14.00.00	<p>LUBRICATION</p>		
14.01.00	<p>Equipment shall be lubricated by systems designed for continuous operation. Lubricant level indicators shall be furnished and marked to indicate proper levels under both standstill and operating conditions.</p>		
15.00.00	<p>MATERIAL OF CONSTRUCTION</p>		
15.01.00	<p>All materials used for the construction of the equipment shall be new and shall be in accordance with the requirements of this specification. Materials utilised for various components shall be those which have established themselves for use in such applications.</p>		
16.00.00	<p>RATING PLATES, NAME PLATES & LABELS</p>		
16.01.00	<p>Each main and auxiliary item of plant including instruments shall have permanently attached to it in a conspicuous position, a rating plate of non-corrosive material upon which shall be engraved manufacturer's name, equipment, type or serial number together with details of the ratings, service conditions under which the item of plant in question has been designed to operate, and such diagram plates as may be required by the Employer.</p>		
16.02.00	<p>Each item of plant shall be provided with nameplate or label designating the service of the particular equipment. The inscriptions shall be approved by the Employer or as detailed in appropriate section of the technical specifications.</p>		
<p>LOT-2 PROJECTS FLUE GAS DESULPHURISATION (FGD) SYSTEM PACKAGE</p>	<p>TECHNICAL SPECIFICATION SECTION – VI BID DOC. NO.:CS-0011-109(2)-9</p>	<p>PART-C GENERAL TECHNICAL REQUIREMENTS</p>	<p>PAGE 23 OF 83</p>

CLAUSE NO.	GENERAL TECHNICAL REQUIREMENTS			
16.03.00	Such nameplates or labels shall be of white nonhygroscopic material with engraved black lettering or alternately, in the case of indoor circuit breakers, starters, etc. of transparent plastic material with suitably coloured lettering engraved on the back. The name plates shall be suitably fixed on both front and rear side.			
16.04.00	Items of plant such as valves, which are subject to handling, shall be provided with an engraved chromium plated nameplate or label with engraving filled with enamel. The name plates for valves shall be marked in accordance with MSS standard SP-25 and ANSI B 16.34 as a minimum.			
16.05.00	Hanger/ support numbers shall be marked on all pipe supports, anchors, hangers, snubbers and restraint assemblies. Each constant and variable spring support shall also have stamped upon it the designed hot and cold load which it is intended to support. Suitable scale shall also be provided to indicate load on support or hanger.			
16.06.00	Valves, steam traps and strainers shall be identified by Employer's tag number of a metal tap permanently attached to non pressure parts such as the yoke by a stainless steel wire. The direction of flow shall also be marked on the body.			
16.07.00	<p>Safety and relief valves shall be provided with the following:</p> <ol style="list-style-type: none"> Manufacturer's identification. Nominal inlet and outlet sizes in mm. Set pressure in Kg/cm² (abs). Blowdown and accumulation as percentage of set pressure. Certified capacity in Kg of saturated steam per hour or in case of liquid certified capacity in litres of water per minute. 			
16.08.00	All such plates, instruction plates, etc. shall be bilingual with Hindi inscription first, followed by English. Alternatively, two separate plates one with Hindi and the other with English inscriptions may be provided.			
16.09.00	All segregated phases of conductors or bus ducts, indoor or outdoor, shall be provided with coloured phase plates to clearly identify the phase of the system.			
17.00.00	<p>TOOLS AND TACKLES</p> <p>The Contractor shall supply with the equipment one complete set of all special tools and tackles and other instruments required and other instruments for the erection, assembly, disassembly and proper maintenance of the plant and equipment and systems (including software). These special tools will also include special material handling equipment, jigs and fixtures for maintenance and calibration / readjustment,</p>			
<p>LOT-2 PROJECTS FLUE GAS DESULPHURISATION (FGD) SYSTEM PACKAGE</p>		<p>TECHNICAL SPECIFICATION SECTION – VI BID DOC. NO.:CS-0011-109(2)-9</p>	<p>PART-C GENERAL TECHNICAL REQUIREMENTS</p>	<p>PAGE 24 OF 83</p>

CLAUSE NO.	GENERAL TECHNICAL REQUIREMENTS			
	<p>checking and measurement aids etc. A list of such tools and tackles shall be submitted by the Bidder alongwith the offer.</p> <p>The price of each tool / tackle shall be deemed to have been included in the total bid price. These tools and tackles shall be separately packed and sent to site. The Contractor shall also ensure that these tools and tackles are not used by him during erection, commissioning and initial operation. For this period the Contractor should bring his own tools and tackles. In case these tools and tackles are used by the Contractor during erection, commissioning or initial operation the same shall be refurbished repaired/replaced as required to the satisfaction of the Employer before handing over to the Employer. All the tools and tackles shall be of reputed make acceptable to the Employer.</p> <p>18.00.00 WELDING</p> <p>18.01.00 If the manufacturer has special requirements relating to the welding procedures for welds at the terminals of the equipments to be per formed by others the requirements shall be submitted to the Employer in advance of commencement of erection work.</p> <p>19.00.00 COLOUR CODE FOR ALL EQUIPMENTS/ PIPINGS/ PIPE SERVICES</p> <p>19.01.00 All equipment/ piping/ pipe services are to be painted by the Contractor in accordance with Employer's standard colour coding scheme, which will be furnished to the Contractor during detailed engineering stage.</p> <p>20.00.00 PROTECTION AND PRESERVATIVE SHOP COATING</p> <p>20.01.00 PROTECTION</p> <p>All coated surfaces shall be protected against abrasion, impact, discoloration and any other damages. All exposed threaded portions shall be suitably protected with either metallic or a nonmetallic protection device. All ends of all valves and piping and conduit equipment connections shall be properly sealed with suitable devices to protect them from damage. The parts which are likely to get rusted, due to exposure to weather, should also be properly treated and protected in a suitable manner. All primers/paints/coatings shall take into account the hot humid, corrosive & alkaline, subsoil or over ground environment as the case may be. The requirements for painting specification shall be complied with as detailed out in Part-A & B of the Technical Specification.</p> <p>20.02.00 PRESERVATIVE SHOP COATING</p> <p>All exposed metallic surfaces subject to corrosion shall be protected by shop application of suitable coatings. All surfaces which will not be easily accessible after the shop assembly, shall be treated beforehand and protected for the life of the</p>			
<p align="center">LOT-2 PROJECTS FLUE GAS DESULPHURISATION (FGD) SYSTEM PACKAGE</p>	<p align="center">TECHNICAL SPECIFICATION SECTION – VI BID DOC. NO.:CS-0011-109(2)-9</p>	<p align="center">PART-C GENERAL TECHNICAL REQUIREMENTS</p>	<p align="center">PAGE 25 OF 83</p>	

CLAUSE NO.	GENERAL TECHNICAL REQUIREMENTS			
	<p>equipment. All surfaces shall be thoroughly cleaned of all mill scales, oxides and other coatings and prepared in the shop. The surfaces that are to be finish-painted after installation or require corrosion protection until installation, shall be shop painted as per the requirements covered in the relevant part of the Technical Specification.</p> <p>Transformers and other electrical equipments, if included shall be shop finished with one or more coats of primer and two coats of high grade resistance enamel. The finished colors shall be as per manufacturer's standards, to be selected and specified by the Employer at a later date.</p> <p>20.03.00 Shop primer for all steel surfaces which will be exposed to operating temperature below 95 degrees Celsius shall be selected by the Contractor after obtaining specific approval of the Employer regarding the quality of primer proposed to be applied. Special high temperature primer shall be used on surfaces exposed to temperature higher than 95 degrees Celsius and such primer shall also be subject to the approval of the Employer.</p> <p>20.04.00 All other steel surfaces which are not to be painted shall be coated with suitable dust preventive compound subject to the approval of the Employer.</p> <p>20.05.00 All piping shall be cleaned after shop assembly by shot blasting or other means approved by the Employer. Lube oil piping or carbon steel shall be pickled.</p> <p>20.06.00 Painting for Civil structures and equipment/system covered under this package shall be done as specified under technical requirements on civil works in relevant part of this specifications.</p> <p>21.00.00 QUALITY ASSURANCE PROGRAMME</p> <p>21.01.00 To ensure that the equipment and services under the scope of contract whether manufactured or performed within the Contractor's works or at his sub-contractor's premises or at the Employer's site or at any other place of work are in accordance with the specifications, the Contractor shall adopt suitable quality assurance programme to control such activities at all points, as necessary. Such programmes shall be outlined by the Contractor and shall be finally accepted by the Employer/authorised representative after discussions before the award of the contract. The QA programme shall be generally in line with ISO-9001/IS-14001. A quality assurance programme of the contractor shall generally cover the following:</p> <ol style="list-style-type: none"> a) His organisation structure for the management and implementation of the proposed quality assurance programme b) Quality System Manual c) Design Control System 			
<p align="center">LOT-2 PROJECTS FLUE GAS DESULPHURISATION (FGD) SYSTEM PACKAGE</p>	<p align="center">TECHNICAL SPECIFICATION SECTION – VI BID DOC. NO.:CS-0011-109(2)-9</p>	<p align="center">PART-C GENERAL TECHNICAL REQUIREMENTS</p>	<p align="center">PAGE 26 OF 83</p>	

CLAUSE NO.	GENERAL TECHNICAL REQUIREMENTS			
	<p>d) Documentation Control System</p> <p>e) Qualification data for Bidder's key Personnel.</p> <p>f) The procedure for purchase of materials, parts, components and selection of sub-contractor's services including vendor analysis, source inspection, incoming raw-material inspection, verification of materials purchased etc.</p> <p>g) System for shop manufacturing and site erection control including process controls and fabrication and assembly controls.</p> <p>h) Control of non-conforming items and system for corrective actions.</p> <p>i) Inspection and test procedure both for manufacture and field activities.</p> <p>j) Control of calibration and testing of measuring testing equipments.</p> <p>k) System for Quality Audits.</p> <p>l) System for indication and appraisal of inspection status.</p> <p>m) System for authorising release of manufactured product to the Employer.</p> <p>n) System for handling storage and delivery.</p> <p>o) System for maintenance of records, and</p> <p>p) Furnishing of quality plans for manufacturing and field activities detailing out the specific quality control procedure adopted for controlling the quality characteristics relevant to each item of equipment/component as per formats enclosed as Annexure-I and Annexure-II respectively.</p>			
22.00.00	GENERAL REQUIREMENTS - QUALITY ASSURANCE			
22.01.00	<p>All materials, components and equipment covered under this specification shall be procured, manufactured, erected, commissioned and tested at all the stages, as per a comprehensive Quality Assurance Programme. An indicative programme of inspection/tests to be carried out by the contractor for some of the major items is given in the respective technical specification. This is, however, not intended to form a comprehensive programme as it is the contractor's responsibility to draw up and implement such programme duly approved by the Employer. The detailed Quality Plans for manufacturing and field activities shall be drawn up by the Bidder and will be submitted to Employer for approval. Schedule of finalisation of such quality plans will be finalised before award on enclosed format No. QS-01-QAI-P-1/F3-R0. Monthly progress reports shall be furnished.</p>			
<p align="center">LOT-2 PROJECTS FLUE GAS DESULPHURISATION (FGD) SYSTEM PACKAGE</p>	<p align="center">TECHNICAL SPECIFICATION SECTION – VI BID DOC. NO.:CS-0011-109(2)-9</p>	<p align="center">PART-C GENERAL TECHNICAL REQUIREMENTS</p>	<p align="center">PAGE 27 OF 83</p>	

CLAUSE NO.	GENERAL TECHNICAL REQUIREMENTS			
22.02.00	<p>Manufacturing Quality Plan will detail out for all the components and equipment, various tests/inspection, to be carried out as per the requirements of this specification and standards mentioned therein and quality practices and procedures followed by Contractor's/ Sub-contractor's/ sub-supplier's Quality Control Organisation, the relevant reference documents and standards, acceptance norms, inspection documents raised etc., during all stages of materials procurement, manufacture, assembly and final testing/performance testing. The Quality Plan shall be submitted on electronic media through C-folders, a web based system of NTPC ERP in addition to hard copy, for review and approval. After approval the same shall be submitted in compiled form on CD-ROM (As per format at Annexure-I)</p>			
22.03.00	<p>Field Quality Plans will detail out for all the equipment, the quality practices and procedures etc. to be followed by the Contractor's "Site Quality Control Organisation", during various stages of site activities starting from receipt of materials/equipment at site (As per format at Annexure – II).</p>			
22.04.00	<p>The Bidder shall also furnish copies of the reference documents/plant standards/acceptance norms/tests and inspection procedure etc., as referred in Quality Plans along with Quality Plans. These Quality Plans and reference documents/standards etc. will be subject to Employer's approval without which manufacturer shall not proceed. These approved documents shall form a part of the contract. In these approved Quality Plans, Employer shall identify customer hold points (CHP), i.e. test/checks which shall be carried out in presence of the Employer's Project Manager or his authorised representative and beyond which the work will not proceed without consent of Employer in writing. All deviations to this specification, approved quality plans and applicable standards must be documented and referred to Employer along with technical justification for approval and positioning.</p>			
22.05.00	<p>The contractor shall submit to the Employer Field Welding Schedule for field welding activities in the format enclosed at Annexure-V. The field welding schedule shall be submitted to the Employer along with all supporting documents, like welding procedures, heat treatment procedures, NDT procedures etc. at least ninety days before schedule start of erection work at site.</p>			
22.06.00	<p>The contractor shall have suitable Field Quality Organization with adequate manpower at Employer's site, to effectively implement the Field Quality Plan (FQP) and Field Quality Management System for site activities. The contractor shall submit the details of proposed FQA setup (organizational structure and manpower) for employer's approval. The FQA setup shall be in place at least one month before the start of site activities.</p>			
22.07.00	<p>No material shall be despatched from the manufacturer's works before the same is accepted, subsequent to predespatch final inspection including verification of records of all previous tests/inspections by Employer's Project Manager/Authorised representative and duly authorised for despatch by issuance of Material Despatch</p>			
<p align="center">LOT-2 PROJECTS FLUE GAS DESULPHURISATION (FGD) SYSTEM PACKAGE</p>	<p align="center">TECHNICAL SPECIFICATION SECTION – VI BID DOC. NO.:CS-0011-109(2)-9</p>	<p align="center">PART-C GENERAL TECHNICAL REQUIREMENTS</p>	<p align="center">PAGE 28 OF 83</p>	

CLAUSE NO.	GENERAL TECHNICAL REQUIREMENTS			
	Clearance Certificate (MDCC).			
22.08.00	All material used for equipment manufacture including casting and forging etc. shall be of tested quality as per relevant codes/standards. Details of results of the tests conducted to determine the mechanical properties; chemical analysis and details of heat treatment procedure recommended and actually followed shall be recorded on certificates and time temperature chart. Tests shall be carried out as per applicable material standards and/or agreed details			
22.09.00	All welding and brazing shall be carried out as per procedure drawn and qualified in accordance with requirements of ASME Section IX/BS-4870 or other International equivalent standard acceptable to the Employer. All welding/brazing procedures shall be submitted to the Employer or its authorised representative for approval prior to carrying out the welding/brazing.			
22.10.00	All brazers, welders and welding operators employed on any part of the contract either in Contractor's/his sub-contractor's works or at site or elsewhere shall be qualified as per ASME Section-IX or BS-4871 or other equivalent International Standards acceptable to the Employer.			
22.11.00	Welding procedure qualification & Welder qualification test results shall be furnished to the Employer for approval. However, where required by the Employer, tests shall be conducted in presence of Employer/authorized representative.			
22.12.00	For all IBR pressure parts and high pressure piping welding, the latest applicable requirements of the IBR (Indian Boiler Regulations) shall also be essentially complied with. However, other piping system ASME B31.1 or other relevant code as applicable shall be followed. Similarly, any other statutory requirements for the equipment/systems shall also be complied with. On all back-gauged welds MPI/LPI shall be carried before seal welding			
22.13.00	All the heat treatment results shall be recorded on time temperature charts and verified with recommended regimes.			
22.14.00	No welding shall be carried out on cast iron components for repair.			
22.15.00	Unless otherwise proven and specifically agreed with the Employer, welding of dissimilar materials and high alloy materials shall be carried out at shop only.			
22.16.00	All non-destructive examination shall be performed in accordance with written procedures as per International Standards. The NDT operator shall be qualified as per SNT-TC-IA (of the American Society of non-destructive examination) or equivalent. NDT shall be recorded in a report, which includes details of methods and equipment used, result/evaluation, job data and identification of personnel employed and details of co-relation of the test report with the job.			
LOT-2 PROJECTS FLUE GAS DESULPHURISATION (FGD) SYSTEM PACKAGE	TECHNICAL SPECIFICATION SECTION – VI BID DOC. NO.:CS-0011-109(2)-9	PART-C GENERAL TECHNICAL REQUIREMENTS	PAGE 29 OF 83	

CLAUSE NO.	GENERAL TECHNICAL REQUIREMENTS			
22.17.00	<p>In general all plates of thickness greater than 40mm & for pressure parts plates of thickness equal to or greater than 25mm shall be ultrasonically tested otherwise as specified in respective equipment specification. All bar stock/Forging of diameter equal to or greater than 40 mm shall be ultrasonically tested.</p> <p>The Contractor shall list out all major items/ equipment/ components to be manufactured in house as well as procured from sub-contractors (BOI). All the sub-contractor proposed by the Contractor for procurement of major bought out items including castings, forging, semi-finished and finished components/equipment etc., list of which shall be drawn up by the Contractor and finalised with the Employer, shall be subject to Employer's approval on enclosed format No. QS-01-QAI-P-01/F3. The contractor's proposal shall include vendor's facilities established at the respective works, the process capability, process stabilization, QC systems followed, experience list, etc. along with his own technical evaluation for identified sub-contractors enclosed and shall be submitted to the Employer for approval within the period agreed at the time of pre-awards discussion and identified in "DR" category prior to any procurement. Monthly progress reports on sub-contractor detail submission / approval shall be furnished preferably on enclosed format at Annexure-IV. Such vendor approval shall not relieve the contractor from any obligation, duty or responsibility under the contract.</p>			
22.18.00	<p>For components/equipment procured by the contractors for the purpose of the contract, after obtaining the written approval of the Employer, the contractor's purchase specifications and inquiries shall call for quality plans to be submitted by the suppliers. The quality plans called for from the sub-contractor shall set out, during the various stages of manufacture and installation, the quality practices and procedures followed by the vendor's quality control organisation, the relevant reference documents/standards used, acceptance level, inspection of documentation raised, etc.</p> <p>Such quality plans of the successful vendors shall be finalised with the Employer and such approved Quality Plans shall form a part of the purchase order/contract between the Contractor and sub-contractor. With in three weeks of the release of the purchase orders /contracts for such bought out items /components, a copy of the same without price details but together with the detailed purchase specifications, quality plans and delivery conditions shall be furnished to the Employer on the monthly basis by the Contractor along with a report of the Purchase Order placed so far for the contract.</p>			
22.19.00	<p>Employer reserves the right to carry out quality audit and quality surveillance of the systems and procedures of the Contractor's or their sub-contractor's quality management and control activities. The contractor shall provide all necessary assistance to enable the Employer carry out such audit and surveillance.</p>			
22.20.00	<p>The contractor shall carry out an inspection and testing programme during manufacture in his work and that of his sub-contractor's and at site to ensure the</p>			
<p align="center">LOT-2 PROJECTS FLUE GAS DESULPHURISATION (FGD) SYSTEM PACKAGE</p>	<p align="center">TECHNICAL SPECIFICATION SECTION – VI BID DOC. NO.:CS-0011-109(2)-9</p>	<p align="center">PART-C GENERAL TECHNICAL REQUIREMENTS</p>	<p align="center">PAGE 30 OF 83</p>	

CLAUSE NO.	GENERAL TECHNICAL REQUIREMENTS			
	<p>mechanical accuracy of components, compliance with drawings, conformance to functional and performance requirements, identity and acceptability of all materials parts and equipment. Contractor shall carry out all tests/inspection required to establish that the items/equipment conform to requirements of the specification and the relevant codes/standards specified in the specification, in addition to carrying out tests as per the approved quality plan.</p>			
22.21.00	<p>Quality audit/surveillance/approval of the results of the tests and inspection will not, however, prejudice the right of the Employer to reject the equipment if it does not comply with the specification when erected or does not give complete satisfaction in service and the above shall in no way limit the liabilities and responsibilities of the Contractor in ensuring complete conformance of the materials/equipment supplied to relevant specification, standard, data sheets, drawings, etc.</p>			
22.22.00	<p>For all spares and replacement items, the quality requirements as agreed for the main equipment supply shall be applicable.</p>			
22.23.00	<p>Repair/rectification procedures to be adopted to make the job acceptable shall be subject to the approval of the Employer/ authorised representative.</p>			
22.24.00	<p>Environmental Stress Screening</p> <p>Environmental stress screening test process / procedure for eliminating infant mortile components for DDCMIS / PLC based system & for other systems having substantial electronics components (as determined by employer) like Electronic transmitter, CCTV components, PA systems etc. shall be necessarily furnished for any sub vendors proposed for vendor assessment and approval for this contract. For other approved sub vendors of above mentioned systems, contractor shall furnish the test procedure for eliminating infant mortile components in case, if it is asked for by the employer before these items are offered for inspection / dispatched to site.</p>			
22.25.00	<p>The Contractor / Sub-contractor shall carry out routine test on 100% item at contractor / sub-contractor's works. The quantum of check / test for routine & acceptance test by employer shall be generally as per criteria / sampling plan defined in referred standards. Wherever standards have not been mentioned quantum of check / test for routine / acceptance test shall be as agreed during detailed engineering stage.</p>			
22.26.00	<p>Software Reliability / Quality Certification</p> <p>Certification from OEM's authorized signatory that software offered with DDCMIS, PLC, CCTV, PA, Pyrometer, CEMS, AAQMS, EQMS, BHMS etc. declaring that the all the offered software(s) had gone through the established software quality test and offered software is not of β-version and offered software is also free from all known bugs as on date of approval of systems documents by NTPC as a part of quality documentation review and approval process during detail engineering.</p>			
23.00.00	<p>QUALITY ASSURANCE DOCUMENTS</p>			
<p>LOT-2 PROJECTS FLUE GAS DESULPHURISATION (FGD) SYSTEM PACKAGE</p>	<p>TECHNICAL SPECIFICATION SECTION – VI BID DOC. NO.:CS-0011-109(2)-9</p>	<p>PART-C GENERAL TECHNICAL REQUIREMENTS</p>	<p>PAGE 31 OF 83</p>	

CLAUSE NO.	GENERAL TECHNICAL REQUIREMENTS			
23.01.00	The Contractor shall be required to submit the QA Documentation in two hard copies and two CD ROMs, as identified in respective quality plan with tick (✓)mark.			
23.01.01	<p>Each QA Documentation shall have a project specific Cover Sheet bearing name & identification number of equipment and including an index of its contents with page control on each document.</p> <p>The QA Documentation file shall be progressively completed by the Supplier's sub-supplier to allow regular reviews by all parties during the manufacturing.</p> <p>The final quality document will be compiled and issued at the final assembly place of equipment before despatch. However CD-Rom may be issued not later than three weeks.</p>			
23.02.00	<p>Typical contents of QA Documentation is as below:-</p> <ul style="list-style-type: none"> (a.) Quality Plan (b.) Material mill test reports on components as specified by the specification and approved Quality Plans. (c.) Manufacturer / works test reports/results for testing required as per applicable codes and standard referred in the specification and approved Quality Plans. (d.) Non-destructive examination results /reports including radiography interpretation reports. Sketches/drawings used for indicating the method of traceability of the radiographs to the location on the equipment. (e.) Heat Treatment Certificate/Record (Time- temperature Chart) (f.) All the accepted Non-conformance Reports (Major/Minor)/deviation, including complete technical details / repair procedure). (g.) CHP / Inspection reports duly signed by the Inspector of the Employer and Contractor for the agreed Customer Hold Points. (h.) Certificate of Conformance (COC) wherever applicable. (i.) MDCC 			
23.03.00	Similarly, the contractor shall be required to submit two sets (two hard copies and two CD ROMs), containing QA Documentation pertaining to field activities as per Approved Field Quality Plans and other agreed manuals/ procedures, prior to commissioning of individual system.			
<p align="center">LOT-2 PROJECTS FLUE GAS DESULPHURISATION (FGD) SYSTEM PACKAGE</p>	<p align="center">TECHNICAL SPECIFICATION SECTION – VI BID DOC. NO.:CS-0011-109(2)-9</p>	<p align="center">PART-C GENERAL TECHNICAL REQUIREMENTS</p>	<p align="center">PAGE 32 OF 83</p>	

CLAUSE NO.	GENERAL TECHNICAL REQUIREMENTS			
23.04.00	<p>Before despatch / commissioning of any equipment, the Supplier shall make sure that the corresponding quality document or in the case of protracted phased deliveries, the applicable section of the quality document file is completed. The supplier will then notify the Inspector regarding the readiness of the quality document (or applicable section) for review.</p> <p>(a.) If the result of the review carried out by the Inspector is satisfactory, the Inspector shall stamp the quality document (or applicable section) for release.</p> <p>(b.) If the quality document is unsatisfactory, the Supplier shall endeavor to correct the incompleteness, thus allowing to finalize the quality document (or applicable section) by time compatible with the requirements as per contract documents. When it is done, the quality document (or applicable section) is stamped by the Inspector.</p> <p>(c.) If a decision is made for despatch, whereas all outstanding actions cannot be readily cleared for the release of the quality document by that time, the supplier shall immediately, upon shipment of the equipment, send a copy of the quality document Review Status signed by the Supplier Representative to the Inspector and notify of the committed date for the completion of all outstanding actions & submission. The Inspector shall stamp the quality document for applicable section when it is effectively completed. The submission of QA documentation package shall not be later than 3 weeks after the despatch of equipment.</p>			
23.05.00	<p>TRANSMISSION OF QA DOCUMENTATION</p> <p>On release of QA Documentation by Inspector, one set of quality document shall be forwarded to Corporate Quality Assurance Department and other set to respective Project Site of Employer.</p> <p>For the particular case of phased deliveries, the complete quality document to the Employer shall be issued not later than 3 weeks after the date of the last delivery of equipment.</p>			
24.00.00	<p>PROJECT MANAGER'S SUPERVISION</p>			
24.01.00	<p>To eliminate delays and avoid disputes and litigation, it is agreed between the parties to the Contract that all matters and questions shall be referred to the Project Manager and without prejudice to the provisions of 'Arbitration' clause in Section GCC, the Contractor shall proceed to comply with the Project Manager's decision.</p>			
24.02.00	<p>The work shall be performed under the supervision of the Project Manager.</p>			
<p>LOT-2 PROJECTS FLUE GAS DESULPHURISATION (FGD) SYSTEM PACKAGE</p>	<p>TECHNICAL SPECIFICATION SECTION – VI BID DOC. NO.:CS-0011-109(2)-9</p>	<p>PART-C GENERAL TECHNICAL REQUIREMENTS</p>	<p>PAGE 33 OF 83</p>	

CLAUSE NO.	GENERAL TECHNICAL REQUIREMENTS			
	<p>The scope of the duties of the Project Manager pursuant to the Contract, will include but not be limited to the following:</p> <ul style="list-style-type: none"> (a.) Interpretation of all the terms and conditions of these documents and specifications (b.) Review and interpretation of all the Contractor's drawing, engineering data, etc (c.) Witness or his authorised representative to witness tests and trials either at the manufacturer's works or at site, or at any place where work is performed under the contract (d.) Inspect, accept or reject any equipment, material and work under the contract (e.) Issue certificate of acceptance and/or progressive payment and final payment certificates (f.) Review and suggest modifications and improvement in completion schedules from time to time, and (g.) Supervise Quality Assurance Programme implementation at all stages of the works. 			
25.00.00	INSPECTION, TESTING AND INSPECTION CERTIFICATES			
25.01.00	The word 'Inspector' shall mean the Project Manager and/or his authorised representative and/or an outside inspection agency acting on behalf of the Employer to inspect and examine the materials and workmanship of the works during its manufacture or erection.			
25.02.00	The Project Manager or his duly authorised representative and/or an outside inspection agency acting on behalf of the Employer shall have access at all reasonable times to inspect and examine the materials and workmanship of the works during its manufacture or erection and if part of the works is being manufactured or assembled on other premises or works, the Contractor shall obtain for the Project Manager and for his duly authorised representative permission to inspect as if the works were manufactured or assembled on the Contractor's own premises or works.			
25.03.00	The Contractor shall give the Project Manager/Inspector fifteen (15) days written notice of any material being ready for testing. Such tests shall be to the Contractor's account except for the expenses of the Inspector's. The Project Manager/Inspector, unless the witnessing of the tests is virtually waived and confirmed in writing, will attend such tests within fifteen (15) days of the date on which the equipment is			
LOT-2 PROJECTS FLUE GAS DESULPHURISATION (FGD) SYSTEM PACKAGE	TECHNICAL SPECIFICATION SECTION – VI BID DOC. NO.:CS-0011-109(2)-9	PART-C GENERAL TECHNICAL REQUIREMENTS	PAGE 34 OF 83	

CLAUSE NO.	GENERAL TECHNICAL REQUIREMENTS			
	<p>noticed as being ready for test/inspection failing which the contractor may proceed with test which shall be deemed to have been made in the inspector's presence and he shall forthwith forward to the inspector duly certified copies of test reports in two (2) copies.</p>			
25.04.00	<p>The Project Manager or Inspector shall within fifteen (15) days from the date of inspection as defined herein give notice in writing to the Contractor, or any objection to any drawings and all or any equipment and workmanship which is in his opinion not in accordance with the contract. The Contractor shall give due consideration to such objections and shall either make modifications that may be necessary to meet the said objections or shall inform in writing to the Project Manager/Inspector giving reasons therein, that no modifications are necessary to comply with the contract.</p>			
25.05.00	<p>When the factory tests have been completed at the Contractor's or sub-contractor's works, the Project Manager /Inspector shall issue a certificate to this effect fifteen (15) days after completion of tests but if the tests are not witnessed by the Project Manager /Inspectors, the certificate shall be issued within fifteen (15) days of the receipt of the Contractor's test certificate by the Project Manager /Inspector. Project Manager /Inspector to issue such a certificate shall not prevent the Contractor from proceeding with the works. The completion of these tests or the issue of the certificates shall not bind the Employer to accept the equipment should it, on further tests after erection be found not to comply with the contract.</p>			
25.06.00	<p>In all cases where the contract provides for tests whether at the premises or works of the Contractor or any sub-contractor, the Contractor, except where otherwise specified shall provide free of charge such items as labour, material, electricity, fuel, water, stores, apparatus and instruments as may be reasonably demanded by the Project Manager /Inspector or his authorised representatives to carry out effectively such tests on the equipment in accordance with the Contractor and shall give facilities to the Project Manager/Inspector or to his authorised representative to accomplish testing.</p>			
25.07.00	<p>The inspection by Project Manager / Inspector and issue of Inspection Certificate thereon shall in no way limit the liabilities and responsibilities of the Contractor in respect of the agreed Quality Assurance Programme forming a part of the contract.</p>			
25.08.00	<p>To facilitate advance planning of inspection in addition to giving inspection notice as specified at clause no 25.03.00 of this chapter, the Contractor shall furnish quarterly inspection programme indicating schedule dates of inspection at Customer Hold Point and final inspection stages. Updated quarterly inspection plans will be made for each three consecutive months and shall be furnished before beginning of each calendar month.</p>			
25.09.00	<p>All inspection, measuring and test equipment used by contractor shall be calibrated periodically depending on its use and criticality of the test/measurement to be done. The Contractor shall maintain all the relevant records of periodic calibration and</p>			
<p align="center">LOT-2 PROJECTS FLUE GAS DESULPHURISATION (FGD) SYSTEM PACKAGE</p>	<p align="center">TECHNICAL SPECIFICATION SECTION – VI BID DOC. NO.:CS-0011-109(2)-9</p>	<p align="center">PART-C GENERAL TECHNICAL REQUIREMENTS</p>	<p align="center">PAGE 35 OF 83</p>	

CLAUSE NO.	GENERAL TECHNICAL REQUIREMENTS			
	<p>instrument identification, and shall produce the same for inspection by NTPC. Wherever asked specifically, the contractor shall re-calibrate the measuring/test equipment in the presence of Project Manager / Inspector.</p>			
25.10.00	<p>Associated document for Quality Assurance programme</p>			
25.10.01	<p>Manufacturing Quality Plan Format No. : QS-01-QAI-P-09/F1-R1 enclosed at Annexure-I.</p>			
25.10.02	<p>Field Quality Plan Format No.: QS-01-QAI-P-09/F2-R1 enclosed at Annexure-II.</p>			
25.10.03	<p>List of items requiring quality plan and sub supplier approval. Format No.: QS-01-QAI-P-01/F3-R0 (Annexure-III).</p>			
25.10.04	<p>Status of items requiring Quality Plan and sub supplier approval. Format enclosed at Annexure-IV.</p>			
25.10.05	<p>Field Welding Schedule Format enclosed at Annexure-V.</p>			
25.11.00	<p>Not Used</p>			
25.12.00	<p>DEMONSTRATION OF APPLICATION ENGINEERING</p>			
25.12.01	<p>Based on NTPC inputs, the Contractor shall prepare and submit typical implemented scheme in their system (Control system & HMI) on sample basis. The typical cases to be covered shall include but not be limited to the following.</p> <p>(i) Logics/Loops:</p> <ul style="list-style-type: none"> a) Drive logics implementation for each type of binary drive along with its display in HMI. b) Sequence implementation along with its display in HMI. c) Single non-cascade controller implementation. d) Cascade loop implementation. e) Master slave implementation with different slave combination. f) Temperature & pressure compensation for flow signals & pressure compensation for level signals as applicable. <p>(ii) HMI Functions:</p> <ul style="list-style-type: none"> a) LVS Annunciation. 			
<p>LOT-2 PROJECTS FLUE GAS DESULPHURISATION (FGD) SYSTEM PACKAGE</p>	<p>TECHNICAL SPECIFICATION SECTION – VI BID DOC. NO.:CS-0011-109(2)-9</p>	<p>PART-C GENERAL TECHNICAL REQUIREMENTS</p>	<p>PAGE 36 OF 83</p>	

CLAUSE NO.	GENERAL TECHNICAL REQUIREMENTS			
	b) Graphics. c) HSR d) Logs/Reports. e) Calculations (Basic & Performance Calculations).			
25.12.02	<p>The above typical cases shall be finalized with the Employer through Technical Co-ordination meetings.</p> <p>After review and finalization of the typical cases, the implementation of each logic & control loop shall be carried out by the Contractor based on NTPC inputs. After implementation of these logics & loops, the Contractor shall test each logic /loop and record the observations in a format to be provided by the Employer and demonstrate to Employer at Employer premises during engineering finalization. Any modifications as a result of the demonstration shall be done and documented as part of the test report along with the final scheme. Similarly, HMI functions shall also be demonstrated by the Contractor at Employer premises & the results shall be documented as part of test report.</p>			
25.12.03	<p>During the integrated testing at the Contractor's works, only sample checks shall be done by the Employer for the items covered in above application engineering demonstration.</p>			
26.00.00	<p>PRE-COMMISSIONING AND COMMISSIONING FACILITIES</p>			
26.01.00	<p>(a) As soon as the facilities or part thereof has been completed operationally and structurally and before start-up, each item of the equipment and systems forming part of facilities shall be thoroughly cleaned and then inspected jointly by the Employer and the Contractor for correctness of and completeness of facility or part thereof and acceptability for initial pre-commissioning tests, commissioning and start-up at Site. The list of pre-commissioning tests to be performed shall be as mutually agreed and included in the Contractor's quality assurance programme as well as those included in Part-D, Section-VI and elsewhere in the Technical Specifications.</p> <p>(b) The Contractor's pre-commissioning/ commissioning/start-up engineers, specially identified as far as possible, shall be responsible for carrying out all the pre-commissioning tests at Site. On completion of inspection, checking and after the pre-commissioning tests are satisfactorily over, the commissioning of the complete facilities shall be commenced during which period the complete facilities, equipments shall be operated integral with sub-systems and supporting equipment as a complete plant.</p>			
<p>LOT-2 PROJECTS FLUE GAS DESULPHURISATION (FGD) SYSTEM PACKAGE</p>		<p>TECHNICAL SPECIFICATION SECTION – VI BID DOC. NO.:CS-0011-109(2)-9</p>	<p>PART-C GENERAL TECHNICAL REQUIREMENTS</p>	<p>PAGE 37 OF 83</p>

CLAUSE NO.	GENERAL TECHNICAL REQUIREMENTS			
26.01.00	<p>(c) All piping system shall be flushed, steam blown, air blown as required and cleanliness demonstrated using acceptable industry standards. Procedures to accomplish this work shall be submitted for approval to the Employer six months prior to the respective implementations. The Employer will approve final verification of cleanliness.</p> <p>(d) The time consumed in the inspection and checking of the units shall be considered as a part of the erection and installation period.</p> <p>(e) The check outs during the pre - commissioning period should be programmed to follow the construction completion schedule. Each equipment/system, as it is completed in construction and turned over to Employer's commissioning (start-up) Engineer(s), should be checked out and cleaned. The checking and inspection of individual systems should then follow a prescribed commissioning documentation [SLs(standard check list)/TS(testing schedule)/CS(commissioning schedule)] approved by the employer.</p> <p>(f) The Contractor during initial operation and performance testing shall conduct vibration testing to determine the 'base line' of performance of all plant rotating equipment. These tests shall be conducted when the equipment is running at the base load, peak load as well as lowest sustained operating condition as far as practicable.</p> <p>Contractor shall furnish the commissioning organization chart for review & acceptance of employer at least twelve months prior to the schedule date of commissioning of 1st unit. The chart should contain:</p> <p>(1.) Biodata including experience of the Commissioning Engineers.</p> <p>(2.) Role and responsibilities of the Commissioning Organisation members.</p> <p>(3.) Expected duration of posting of the above Commissioning Engineers at site.</p>			
26.02.00	<p>Initial Operation</p> <p>(a) On completion of all pre-commissioning activities/ tests and as a part of commissioning the complete facilities shall be put on 'Initial Operation' during which period all necessary adjustments shall be made while operating over the full load range enabling the facilities to be made ready for the Guarantee Tests.</p> <p>(b) The 'Initial Operation' of the complete facility as an integral unit shall be conducted for 720 continuous hours. During the period of initial operation of 720 hours, the FGD System shall operate continuously at full load for a period not less than 72 hours.</p>			
<p>LOT-2 PROJECTS FLUE GAS DESULPHURISATION (FGD) SYSTEM PACKAGE</p>	<p>TECHNICAL SPECIFICATION SECTION – VI BID DOC. NO.:CS-0011-109(2)-9</p>	<p>PART-C GENERAL TECHNICAL REQUIREMENTS</p>	<p>PAGE 38 OF 83</p>	

CLAUSE NO.	GENERAL TECHNICAL REQUIREMENTS			
26.03.00	<p>The Initial Operation shall be considered successful, provided that each item/part of the facility can operate continuously at the specified operating characteristics, for the period of Initial Operation with all operating parameters within the specified limits and at or near the predicted performance of the equipment/ facility.</p> <p>The Contractor shall intimate the Employer about the commencement of initial operation and shall furnish adequate notice to the Employer in this respect.</p> <p>(c) Any operational interruption in the FGD System due to constraints attributable to the Employer shall be construed as Deemed to be in operation.</p> <p>(d) An Initial Operation report comprising of observations and recordings of various parameters to be measured in respect of the above Initial Operation shall be prepared by the Contractor. This report, besides recording the details of the various observations during initial operation shall also include the dates of start and finish of the Initial Operation and shall be signed by the representatives of both the parties. The report shall have sheets, recording all the details of interruptions occurred, adjustments made and any minor repairs done during the Initial Operation. Based on the observations, necessary modifications/repairs to the plant shall be carried out by the Contractor to the full satisfaction of the Employer to enable the latter to accord permission to carry out the Guarantee tests on the facilities. However, minor defects which do not endanger the safe operation of the equipment, shall not be considered as reasons for with- holding the aforesaid permission.</p> <p>Guarantee Tests</p> <p>a) The final test as to prove the Functional Guarantees shall be conducted at Site by the Contractor in presence of the Employer. The contractor's Commissioning, start-up Engineer shall make the unit ready to conduct such test before start of initial operation. Such test shall be conducted along with the Initial Operations.</p> <p>b) These tests shall be binding on both the parties of the Contract to determine compliance of the equipment with the functional guarantee.</p> <p>c) For performance/ demonstration tests instrumentations, of accuracy class shall be as per specified test codes. The numbers and location of the instruments shall be as per the specified test codes. In addition the values of parameters shall be logged from the information system provided under Employer's Distributed Digital Control Monitoring and Information system. Test will be conducted at specified load points.</p>			
<p align="center">LOT-2 PROJECTS FLUE GAS DESULPHURISATION (FGD) SYSTEM PACKAGE</p>	<p align="center">TECHNICAL SPECIFICATION SECTION – VI BID DOC. NO.:CS-0011-109(2)-9</p>	<p align="center">PART-C GENERAL TECHNICAL REQUIREMENTS</p>	<p align="center">PAGE 39 OF 83</p>	

CLAUSE NO.	GENERAL TECHNICAL REQUIREMENTS			
27.00.00	<p>d) Any special equipment, tools and tackles required for the successful completion of the Guarantee Tests shall be provided by the Contractor, free of cost.</p> <p>e) The Guarantee tests and specific tests to be conducted on equipments have been brought out in detail elsewhere in the specifications.</p> <p>TAKING OVER</p> <p>Upon successful completion of Initial Operations and all the tests conducted to the Employer's satisfaction, the Employer shall issue to the Contractor a Taking over Certificate as a proof of the final acceptance of the equipment. Such certificate shall not unreasonably be with held nor will the Employer delay the issuance thereof, on account of minor omissions or defects which do not affect the commercial operation and/or cause any serious risk to the equipment. Such certificate shall not relieve the Contractor of any of his obligations which otherwise survive, by the terms and conditions of the Contract after issuance of such certificate.</p>			
28.00.00	TRAINING OF EMPLOYER'S PERSONNEL			
28.01.00	Training for Employers O&M Personnel			
	<p>The scope of service under training of Employer's engineers shall include a training module covering upto six (6) man months in the areas of Operation & Maintenance.</p> <p>Such training should enable the personnel to individually take the responsibility of operating and maintaining the FGD system in a manner acceptable to the Employer.</p>			
28.02.00	Training for Employers Engineering Personnel			
	<p>The scope of services under training for Employer's engineering personnel shall also necessarily include three (3) man months. This shall cover all disciplines viz, Mechanical, Electrical, C&I, & QA etc. and shall include all the related areas like Design familiarization, training on product design features and product design softwares of major equipment and systems, engineering, manufacturing, erection, commissioning, training on operating features of equipment, quality assurance and testing, plant visits and visits to manufacturer's works, exposure to various kinds of problems which may be encountered in fabrication, manufacturing, erection, welding etc. An indicative module of the training requirement of Employer's Engineering personnel is attached as Annexure-VII.</p>			
<p align="center">LOT-2 PROJECTS FLUE GAS DESULPHURISATION (FGD) SYSTEM PACKAGE</p>	<p align="center">TECHNICAL SPECIFICATION SECTION – VI BID DOC. NO.:CS-0011-109(2)-9</p>	<p align="center">PART-C GENERAL TECHNICAL REQUIREMENTS</p>	<p align="center">PAGE 40 OF 83</p>	

CLAUSE NO.	GENERAL TECHNICAL REQUIREMENTS			
28.03.00	<p>Bidder shall furnish in his offer, details of training module(s) covering above requirements which shall be subject to Employer's approval. Consolidated training period included above (i.e. 6 man months and 3 man months respectively for O&M and Engineering) is indicative only. Employer reserves the right to re appropriate the training period between O&M and engineering depending upon the details of training module proposed by the Bidder.</p>			
28.04.00	<p>Exact details, extent of training and the training schedule shall be finalised based on the Bidder's proposal within two (2) months from placement of award.</p>			
28.05.00	<p>In all the above cases, wherever the training of Employer's personnel is arranged at the works of the manufacturer's it shall be noted that the lodging and boarding of the Employer's personnel shall be at the cost of Contractor. The Contractor shall make all necessary arrangements towards the same.</p>			
28.06.00	<p>Take off prices (product wise) should be indicated by the Bidder in the Bid Proposal Sheets. Employer reserves the right to include or exclude these item(s) during placement of Award.</p> <p>Note: For training purposes, one (1) man month implies 30 working days (excluding all intervening holidays) per person.</p>			
29.00.00	<p>SAFETY ASPECTS DURING CONSTRUCTION AND ERECTION</p> <p>In addition to the requirements given in Erection Conditions of Contract (ECC) the following shall also cover:</p> <ul style="list-style-type: none"> i) Working platforms should be fenced and shall have means of access. ii) Ladders in accordance with Employer's safety rules for construction and erection shall be used. Rungs shall not be welded on columns. All the stairs shall be provided with handrails immediately after its erection. 			
30.00.00	<p>NOISE LEVEL</p> <p>The equivalent 'A' weighted sound pressure level measured at a height of 1.5 m above floor level in elevation and at a distance of one (1) metre horizontally from the nearest surface of any equipment/machine, furnished and installed under these specifications, expressed in decibels to a reference of 0.0002 microbar, shall not exceed 85 dBA . However for Ball Mills the noise levels as per following shall also be acceptable:</p> <ul style="list-style-type: none"> a) Ball Mill < 90 dBA 			
31.00.00	<p>PACKAGING AND TRANSPORTATION</p>			
<p>LOT-2 PROJECTS FLUE GAS DESULPHURISATION (FGD) SYSTEM PACKAGE</p>		<p>TECHNICAL SPECIFICATION SECTION – VI BID DOC. NO.:CS-0011-109(2)-9</p>	<p>PART-C GENERAL TECHNICAL REQUIREMENTS</p>	<p>PAGE 41 OF 83</p>

CLAUSE NO.	GENERAL TECHNICAL REQUIREMENTS											
	<p>All the equipments shall be suitably protected, coated, covered or boxed and crated to prevent damage or deterioration during transit, handling and storage at Site till the time of erection. While packing all the materials, the limitation from the point of view of the sizes of railway wagons available in India should be taken account of. The Contractor shall be responsible for any loss or damage during transportation, handling and storage due to improper packing. The Contractor shall ascertain the availability of Railway wagon sizes from the Indian Railways or any other agency concerned in India well before effecting despatch of equipment. Before despatch it shall be ensured that complete processing and manufacturing of the components is carried out at shop, only restricted by transport limitation, in order to ensure that site works like grinding, welding, cutting & preassembly to bare minimum. The Employer's Inspector shall have right to insist for completion of works in shops before despatch of materials for transportation.</p>											
32.00.00	ELECTRICAL EQUIPMENTS/ENCLOSURES											
32.01.00	<p>All electrical equipments and devices, including insulation, heating and ventilation devices shall be designed for ambient temperature and a maximum relative humidity as specified elsewhere in the specifications.</p>											
33.00.00	INSTRUMENTATION AND CONTROL											
	<p>All instrumentation and control systems/ equipment/ devices/ components, furnished under this contract shall be in accordance with the requirements stated herein, unless otherwise specified in the detailed specifications.</p>											
33.01.00	<p>All instrument scales and charts shall be calibrated and printed in metric units and shall have linear graduation. The ranges shall be selected to have the normal reading at 75% of full scale.</p> <p>All scales and charts shall be calibrated and printed in Metric Units as follows:</p> <table border="0" data-bbox="386 1339 1333 1780"> <tr> <td style="padding-right: 20px;">1. Temperature</td> <td>- Degree centigrade (deg C)</td> </tr> <tr> <td>2. Pressure</td> <td>- Kilograms per square centimetre (Kg/cm²). Pressure instrument shall have the unit suffixed with 'a' to indicate absolute pressure. If nothing is there, that will mean that the indicated pressure is gauge pressure.</td> </tr> <tr> <td>3. Draught</td> <td>- Millimetres of water column (mm wc).</td> </tr> <tr> <td>4. Vacuum</td> <td>- Millimeters of mercury gauge (mm Hg) or water column (mm Wcl).</td> </tr> </table>			1. Temperature	- Degree centigrade (deg C)	2. Pressure	- Kilograms per square centimetre (Kg/cm ²). Pressure instrument shall have the unit suffixed with 'a' to indicate absolute pressure. If nothing is there, that will mean that the indicated pressure is gauge pressure.	3. Draught	- Millimetres of water column (mm wc).	4. Vacuum	- Millimeters of mercury gauge (mm Hg) or water column (mm Wcl).	
1. Temperature	- Degree centigrade (deg C)											
2. Pressure	- Kilograms per square centimetre (Kg/cm ²). Pressure instrument shall have the unit suffixed with 'a' to indicate absolute pressure. If nothing is there, that will mean that the indicated pressure is gauge pressure.											
3. Draught	- Millimetres of water column (mm wc).											
4. Vacuum	- Millimeters of mercury gauge (mm Hg) or water column (mm Wcl).											
<p align="center">LOT-2 PROJECTS FLUE GAS DESULPHURISATION (FGD) SYSTEM PACKAGE</p>	<p align="center">TECHNICAL SPECIFICATION SECTION – VI BID DOC. NO.:CS-0011-109(2)-9</p>	<p align="center">PART-C GENERAL TECHNICAL REQUIREMENTS</p>	<p align="center">PAGE 42 OF 83</p>									

CLAUSE NO.	GENERAL TECHNICAL REQUIREMENTS			
	5. Flow (Gas) 6. Flow (Steam) 7. Flow (Liquid) 8. Flow base 9. Density	- Tonnes/ hour - Tonnes/ hour - Tonnes / hour - 760 mm Hg. 0 deg.C - Grams per cubic centimeter.		
33.02.00	<p>All instruments and control devices provided on panels shall be of miniaturized design, suitable for modular flush mounting on panels with front draw out facility and flexible plan-in connection at rear.</p>			
33.03.00	<p>All electronic modules shall have gold plated connector fingers and further all input and output modules shall be short circuit proof. These shall also be tropicalised & components shall be of industrial grade or better.</p>			
34.00.00	<p>ELECTRICAL NOISE CONTROL</p> <p>The equipment furnished by the Contractor shall incorporate necessary techniques to eliminate measurement and control problems caused by electrical noise. Areas in Contractor's equipment which are vulnerable to electrical noise shall be hardened to eliminate possible problems. Any additional equipment, services required for effectively eliminating the noise problems shall be included in the proposal. The equipment shall be protected against ESD as per IEC-61000-2. Radio Frequency interference (RFI) and Electro Magnetic Interference (EMI) protection against hardware damage and control system mal-operations/errors shall be provided for all systems as per EN-50082-2 (1995).</p>			
35.00.00	<p>SURGE PROTECTION FOR SOLID STATE EQUIPMENT</p> <p>All solid state systems /equipment shall be able to withstand the electrical noise and surge as encountered in actual service conditions and inherent in a power plant and shall meet the requirements of surge protection as defined in ANSI C37.90.1-1989 on its suitable equivalent class of IEC 254-4. Details of the features incorporated and relevant tests carried out. The test certificates. etc. shall be submitted by the Bidder.</p>			
36.00.00	<p>INSTRUMENT AIR SYSTEM</p> <p>The instrument air supply system as supplied by the Bidder for various pneumatic control & instrumentation devices like pneumatic actuators, power cylinders, E/P converters, piping / tubing etc.</p>			
LOT-2 PROJECTS FLUE GAS DESULPHURISATION (FGD) SYSTEM PACKAGE		TECHNICAL SPECIFICATION SECTION – VI BID DOC. NO.:CS-0011-109(2)-9	PART-C GENERAL TECHNICAL REQUIREMENTS	PAGE 43 OF 83

CLAUSE NO.	GENERAL TECHNICAL REQUIREMENTS			
37.00.00	<p>Each pneumatic instrument shall have an individual air shut - off valve. The pressure regulating valve shall be equipped with an internal filter, a 50 mm pressure gauge and a built-in filter housing blow down valve.</p> <p>TAPPING POINTS FOR MEASUREMENTS</p> <p>Tapping points shall include probes, wherever applicable, for analytical measurements and sampling.</p> <p>For direct temperature measurement of all working media, one stub with internal threading of approved pattern shall be provided along with suitable plug and washer. The Contractor will be intimated about thread standard to be adopted.</p> <p>The following shall be provided on equipment by the Bidder. The standard which is to be adopted, will be intimated to the Contractor.</p> <ul style="list-style-type: none"> i) Temperature test pockets with stub and thermowell ii) Pressure test pockets 			
38.00.00	<p>SYSTEM DOCUMENTATION</p> <p>The Bidder shall provide drawings, system overview & description, hardware/software details, technical literature, functional & hardware schemes, bill of material, parts list, interconnection diagrams, data sheets, erection/ installation/ commissioning procedures, instruction/ operating manuals, etc. for each of the C& I system / sub-systems/ equipment supplied under this package. The documentation shall include complete details of the C&I systems/ sub-systems/ equipment to enable review by Employer during detailed engineering stage and to provide information to plant personnel for operation & Maintenance (including quick diagnostics & trouble shooting) of these C&I systems/ sub-systems/ equipment at site. The minimum documentation requirements for C&I systems shall be as stipulated under C&I "Technical Data Sheets" Part of specifications. In addition to this, system documentation for control system shall include as a minimum to that specified elsewhere in the Technical Specification.</p> <p>The exact format, submission schedule and contents of various documents shall be as finalised during detailed engineering stage.</p>			
38.01.00	<p>Bill of material (instrument list) for all C&I equipment/ devices shall be furnished by the bidder in standard formats as approved by the Employer.</p>			
39.00.00	<p>MAINTENANCE MANUALS OF ELECTRONIC MODULES</p> <p>The Contractor shall have to furnish two (2) sets of all maintenance manual of each and every electronic card/module as employed on the various systems and</p>			
<p>LOT-2 PROJECTS FLUE GAS DESULPHURISATION (FGD) SYSTEM PACKAGE</p>	<p>TECHNICAL SPECIFICATION SECTION – VI BID DOC. NO.:CS-0011-109(2)-9</p>	<p>PART-C GENERAL TECHNICAL REQUIREMENTS</p>	<p>PAGE 44 OF 83</p>	

CLAUSE NO.	GENERAL TECHNICAL REQUIREMENTS			
	<p>equipment including peripherals etc., offered by him. The Contractor will also have to furnish the data regarding the expected failure rate of various modules and other system components. Further , the contractor shall furnish a set of operating manuals which should include block diagrams ,make, model/type ,details wiring and external connection drawings etc as required to do the testing and maintenance of the electronic modules.</p>			
<p align="center">LOT-2 PROJECTS FLUE GAS DESULPHURISATION (FGD) SYSTEM PACKAGE</p>	<p align="center">TECHNICAL SPECIFICATION SECTION – VI BID DOC. NO.:CS-0011-109(2)-9</p>	<p align="center">PART-C GENERAL TECHNICAL REQUIREMENTS</p>	<p align="center">PAGE 45 OF 83</p>	

CLAUSE NO.	GENERAL TECHNICAL REQUIREMENTS		
LIST OF CODES AND STANDARDS			
	Indian Standards	Title	International and Internationally recognised standards
	IS:277	Galvanised steel sheets (plain or corrugated)	
	IS:655	Specification for metal air duct	
	IS:800	Code of practice for use of structural steel in general building construction	BS 449:1969 BS 5950 ASA A57, 1-1952
	IS:807	Code of practice for design, manufacture, erection and testing (Structural portion) of cranes and hoists 6588 (Issued by Standards Association of Australia). DIN 120:1936 (Sheet 1) DIN 120:1936 (Sheet 2) 327 part-I, 1951 BS 466 part-II, 1960 BS 644:1960 BS 1757:1951 BS 2573:part-I:1960	Draft Revision of A.S. NO. CS.2 SAA Crane and Hoist code Doc:No. BU/4 Rev
	IS:875	Code of practice for design loads (other than earthquake) for buildings and structures Leading standards (issued by Canadian Standard) DIN-1055-1955 (Issued by ASA)	National Building code of Canada (1953)-Part-IV Design section 4.1
LOT-2 PROJECTS FLUE GAS DESULPHURISATION (FGD) SYSTEM PACKAGE	TECHNICAL SPECIFICATION SECTION – VI BID DOC. NO.:CS-0011-109(2)-9	PART-C GENERAL TECHNICAL REQUIREMENTS	PAGE 46 OF 83

CLAUSE NO.	GENERAL TECHNICAL REQUIREMENTS			
	IS:1239 Part-I	Mild steel tubes	(ISO/R 65-1957) (ISO/R-64-1958) (ISO/R-65-1958) (BS 1387 : 1957)	
	IS:1239 Part-II	Mild steel tubulars and other wrought steel pipe fittings	BS 1387 : 1967 BS 1387 :1967 BS 1740 :1965	
	IS:2825	Code for unfired vessels		
	IS:1520	Horizontal centrifugal pumps for clear cold and fresh water		
	IS:1600	Code for practice for performance of constant speed IC Engines for general purpose		
	IS:1601	Specification for performance of constant speed IC Engines for general Purpose		
	IS:1893	Criteria for earthquake resistant design of structures		
	IS1978-1971	Line Pipe April 1969.	API Standards 5L	
	IS:2254-1970	Dimensions of vertical shaft motor for pumps	IEC Pub 72-1 part I NEMA Pub MG 1 1954	
	IS:2266	Steel wire ropes for general engineering purposes	BS :302 : 1968	
	IS:2312	Propellant type Ventilation fans		
	IS:2365	Steel wire suspension ropes for lifts and hoists	BS : 1957	
<p align="center">LOT-2 PROJECTS FLUE GAS DESULPHURISATION (FGD) SYSTEM PACKAGE</p>	<p align="center">TECHNICAL SPECIFICATION SECTION – VI BID DOC. NO.:CS-0011-109(2)-9</p>	<p align="center">PART-C GENERAL TECHNICAL REQUIREMENTS</p>	<p align="center">PAGE 47 OF 83</p>	

CLAUSE NO.	GENERAL TECHNICAL REQUIREMENTS		
	<p>IS:3346</p> <p>IS:3354</p> <p>IS:3401</p> <p>IS:3588</p> <p>IS:3589</p> <p>IS:3677</p> <p>IS:3815</p> <p>IS:3895</p> <p>IS:3963</p> <p>IS:3975</p> <p>IS:4503</p>	<p>Method for the determination of thermal conductivity of thermal insulation materials (two slab guarded hot plate method)</p> <p>Outline dimensions for electric lifts.</p> <p>Silica gel</p> <p>Specification for electrical axial flow fans</p> <p>Electrically welded steel pipes for water, gas and sewage (200mm to 2000 mm Nominal Diameter)</p> <p>Unbonded rock and slag wool for thermal insulation</p> <p>Point hook with shank for general engineering purposes</p> <p>Specification for monocrystalline semiconductor rectifier cells and stacks</p> <p>Roof extractor unit</p> <p>Mild steel wires, strips and tapes for armouring cables</p> <p>Shell and tube type heat Exchanger</p>	<p>DIN 52612 (Deutscher Normenausschuss)</p> <p>ASTM C 163-1964 (American Society of Testing and materials)</p> <p>ASTM C 167-1974</p> <p>ASTM C 177-1963</p> <p>BS 482 - 1968 Doc.:67/3 1284 (Revision of BS 2903) (Issued BS)</p>
<p>LOT-2 PROJECTS FLUE GAS DESULPHURISATION (FGD) SYSTEM PACKAGE</p>	<p>TECHNICAL SPECIFICATION SECTION – VI BID DOC. NO.:CS-0011-109(2)-9</p>	<p>PART-C GENERAL TECHNICAL REQUIREMENTS</p>	<p>PAGE 48 OF 83</p>

CLAUSE NO.	GENERAL TECHNICAL REQUIREMENTS		
IS:4540	Specification for monory-stallines rectifire assembly equipment		
IS:4671	Expanded polystyrene for thermal insulation purpose		
IS:4736	Hot dip zinc coating on steel tubes		
IS:4894	Centrifugal fans		
IS:5456	Code of practice for testing of positive displacement type air compressors and exhauster (For Test Tolerance Only)		
IS:5749	Forged ramshorn hooks	Entwurf DIN 15402 Blett 1 Entwurf DIN 15402 BS 3017-1958	
IS:6392	Steel pipe flanges	BS 4504 : 1969	
IS:6524 Part-I	Code of practice for design of tower cranes Static and rail mounted	BS 2799 : 1956	
IS:7098	Cross linked Polyethylene insulated PVC sheathed cables	Standard No. 1 to IPCEA (USA) Pub. No. 5-66-524	
IS:7373	Specification for wrought aluminium and aluminium sheet and strips		
IS:7938	Air receivers for compressed air installation		
ISO:1217	Displacement compressor-Acceptance test		
ASHRAE-33	Methods of testing for rating of forced circulation air cooling and air heating coils.		
ASHRAE-52-76	Air cleaning device used in general ventilation for removing particle matter.		
LOT-2 PROJECTS FLUE GAS DESULPHURISATION (FGD) SYSTEM PACKAGE	TECHNICAL SPECIFICATION SECTION – VI BID DOC. NO.:CS-0011-109(2)-9	PART-C GENERAL TECHNICAL REQUIREMENTS	PAGE 49 OF 83

CLAUSE NO.	GENERAL TECHNICAL REQUIREMENTS		
	<p>ASHRAE-22-72</p> <p>ASHRAE 23-67</p> <p>ARI-450-6</p> <p>ARI-550</p> <p>ARI-410</p> <p>ARI-430/435 BS:848 (Part-1,2)</p> <p>BS:400</p> <p>BS:401</p> <p>CTI Code ACT-105</p> <p>ANSI-31.5</p> <p>ASME-PTC- 23-1958</p> <p>AMCA A-21C</p> <p>API:618</p> <p>HYDRAULIC INSTITUTE STANDARDS.</p> <p>HYDRANT SYSTEM MANUALS OF TAC.</p> <p>TAC MANUALS OF SPRAY SYSTEM</p> <p>NFPA USA/ NSC UK/ UL USA/ FM USA STANDARDS.</p> <p>INDIAN EXPLOSIVES ACT.</p> <p>INDIAN FACTORIES ACT.</p> <p>STANDARD OF TUBULAR EXCHANGER MANUFACTURER'S ASSOCIATION.</p>	<p>Method of testing for rating of water cooled refrigerant condensers.</p> <p>Methods of testing for rating of positive displacement refrigerant compressors.</p> <p>Standard for water cooled refrigerant condensers.</p> <p>Standard for centrifugal water chilling packages.</p> <p>Standard for forced circulation air cooling and air heating coils</p> <p>Central station AHU/Application of Central Station AHU Fans</p> <p>Low carbon steel cylinders for the storage & transport of permanent gases.</p> <p>Low carbon steel cylinders for the storage & transport of liquified gases.</p> <p>Acceptance test code for Water Cooling Tower.</p> <p>Refrigerant piping</p> <p>Atmospheric Water Cooling Equipment</p> <p>Test Code for air moving devices</p> <p>Reciprocating Compressor for general refinery services.</p>	
LOT-2 PROJECTS FLUE GAS DESULPHURISATION (FGD) SYSTEM PACKAGE	TECHNICAL SPECIFICATION SECTION – VI BID DOC. NO.:CS-0011-109(2)-9	PART-C GENERAL TECHNICAL REQUIREMENTS	PAGE 50 OF 83

CLAUSE NO.	GENERAL TECHNICAL REQUIREMENTS			
	<p>CODE AND STANDARD FOR CIVIL WORKS</p> <p>Some of the applicable Standards, Codes and references are as follows:</p> <p>Excavation & Filling</p> <p>IS: 2720 (Part-II, IV TO VIII, XIV, XXI, XXIII, XXIV, XXVII TO XXIX, XL) Methods of test for soils-determination for water content etc.</p> <p>IS: 4701 Code of practice for earth work on canals.</p> <p>IS: 9758 Guide lines for Dewatering during construction.</p> <p>IS: 10379 Code of practice for field control of moisture and compaction of soils for embankment and sub-grade.</p> <p>Properties, Storage and Handling of Common Building Materials</p> <p>IS: 269 Specification for ordinary Portland cement, 33 grade.</p> <p>IS: 383 Specification for coarse and fine aggregates from natural sources for concrete.</p> <p>IS: 432 Specification for mild steel and (Parts 1&2) medium tensile steel bars and hard-drawn steel wires for concrete reinforcement.</p> <p>IS: 455 Specification for Portland slag cement.</p> <p>IS: 702 Specification for Industrial bitumen.</p> <p>IS: 712 Specification for building limes.</p> <p>IS: 808 Rolled steel Beam channel and angle sections.</p> <p>IS: 1077 Specification for common burnt clay building bricks.</p> <p>IS: 1161 Specification of steel tubes for structural purposes.</p> <p>IS: 1363 Hexagon head Bolts, Screws and nuts of production grade C.</p> <p>IS: 1364 Hexagon head Bolts, Screws and Nuts of Production grade A & B.</p> <p>IS: 1367 Technical supply conditions for Threaded fasteners.</p> <p>IS: 1489 Specification for Portland-pozzolana cement: (Part-I) Fly ash based.</p>			
<p align="center">LOT-2 PROJECTS FLUE GAS DESULPHURISATION (FGD) SYSTEM PACKAGE</p>	<p align="center">TECHNICAL SPECIFICATION SECTION – VI BID DOC. NO.:CS-0011-109(2)-9</p>	<p align="center">PART-C GENERAL TECHNICAL REQUIREMENTS</p>	<p align="center">PAGE 51 OF 83</p>	

CLAUSE NO.	GENERAL TECHNICAL REQUIREMENTS		
	(Part-II) IS: 1542 IS: 1566 IS: 1786 IS: 2062 IS: 2116 IS: 2386 (Parts-I to VIII) IS: 3150 IS: 3495 (Parts-I to IV) IS: 3812 IS: 4031 IS: 4032 IS: 4082 IS: 8112 IS: 8500 IS: 12269 IS: 12894 Cast-In-Situ Concrete and Allied Works IS: 280 IS: 456	Calcined clay based. Specification for sand for plaster. Specification for hard-drawn steel wire fabric for concrete reinforcement. Specification for high strength deformed bars for concrete reinforcement. Specification for steel for general structural purposes. Specification for sand for masonry mortars. Testing of aggregates for concrete. Hexagonal wire netting for general purpose. Methods of tests of burnt clay building bricks. Specification for fly ash, for use as pozzolana and admixture. Methods of physical tests for hydraulic cement. Methods of chemical analysis of hydraulic cement. Recommendations on stacking and storage of construction materials at site. Specification for 43 grade ordinary portland cement. Medium and high strength structural steel. 53 grade ordinary portland cement. Specification for Fly ash lime bricks. Specification for mild steel wire for general engineering purposes. Code of practice for plain and reinforced concrete.	
LOT-2 PROJECTS FLUE GAS DESULPHURISATION (FGD) SYSTEM PACKAGE	TECHNICAL SPECIFICATION SECTION – VI BID DOC. NO.:CS-0011-109(2)-9	PART-C GENERAL TECHNICAL REQUIREMENTS	PAGE 52 OF 83

CLAUSE NO.	GENERAL TECHNICAL REQUIREMENTS		
	IS: 457 IS: 516 IS: 650 IS: 1199 IS: 1791 IS: 1838 (Part-I) IS: 2204 IS: 2210 IS: 2438 IS: 2502 IS: 2505 IS: 2506 IS: 2514 IS: 2645 IS: 2722 IS: 2750 IS: 2751 IS: 3025 IS: 3366 IS: 3370	Code of practice for general construction of plain & reinforced concrete for dams & other massive structures. Method of test for strength of concrete. Specification for standard sand for testing of cement. Methods of sampling and analysis of concrete. General requirements for batch type concrete mixers. Specification for preformed fillers for expansion joints in concrete pavements and structures (non-extruding and resilient type). Code of practice for construction of reinforced concrete shell roof. Criteria for the design of reinforced concrete shell structures and folded plates. Specification for roller pan mixer. Code of practice for bending and fixing of bars for concrete reinforcement. General requirements for concrete vibrators, immersion type. General requirements for concrete vibrators, screed board type. Specification for concrete vibrating tables. Specification for Integral cement water proofing compounds. Specification for portable swing weigh batches for concrete. (single and double bucket type) Specification for Steel scaffolding. Code of practice for welding of mild steel plain and deformed bars for reinforced concrete construction. Methods of sampling and test waste water. Specification for Pan vibrators. Code of practice for concrete structures for the storage of	
LOT-2 PROJECTS FLUE GAS DESULPHURISATION (FGD) SYSTEM PACKAGE	TECHNICAL SPECIFICATION SECTION – VI BID DOC. NO.:CS-0011-109(2)-9	PART-C GENERAL TECHNICAL REQUIREMENTS	PAGE 53 OF 83

CLAUSE NO.	GENERAL TECHNICAL REQUIREMENTS		
	<p>(Part I to IV)</p> <p>IS: 3414</p> <p>IS: 3550</p> <p>IS: 3558 concrete.</p> <p>IS: 4014 (Parts I & II)</p> <p>IS: 4326 of buildings.</p> <p>IS: 4461</p> <p>IS: 4656</p> <p>IS: 4925</p> <p>IS: 4990</p> <p>IS: 4995 (Parts I & II)</p> <p>IS: 5256</p> <p>IS: 5525 concrete work.</p> <p>IS: 5624</p> <p>IS: 6461</p> <p>IS: 6494</p> <p>IS: 6509</p> <p>IS: 7861</p> <p>IS: 9012</p> <p>IS: 9103</p>	<p>liquids.</p> <p>Code of practice for design and installation of joints in buildings.</p> <p>Methods of test for routine control for water used in industry.</p> <p>Code of practice for use of immersion vibrators for consolidating concrete.</p> <p>Code of practice for steel tubular scaffolding.</p> <p>Code of practice for earthquake resistant design and construction of buildings.</p> <p>Code of practice for joints in surface hydro-electric power stations.</p> <p>Specification for form vibrators for concrete.</p> <p>Specification for batching and mixing plant.</p> <p>Specification for plywood for concrete shuttering work.</p> <p>Criteria for design of reinforced concrete bins for the storage of granular and powdery materials.</p> <p>Code or practice for sealing joints in concrete lining on canals.</p> <p>Recommendations for detailing of reinforcement in reinforced concrete work.</p> <p>Specification for foundation bolts.</p> <p>Glossary of terms relating to cement concrete.</p> <p>Code of practice for water proofing of underground water reservoirs and swimming pools.</p> <p>Code of practice for installation of joints in concrete pavements.</p> <p>Code of practice for extreme weather concreting. (Parts I & II)</p> <p>Recommended practice for shot concreting.</p> <p>Specification for admixtures for concrete.</p>	
LOT-2 PROJECTS FLUE GAS DESULPHURISATION (FGD) SYSTEM PACKAGE	TECHNICAL SPECIFICATION SECTION – VI BID DOC. NO.:CS-0011-109(2)-9	PART-C GENERAL TECHNICAL REQUIREMENTS	PAGE 54 OF 83

CLAUSE NO.	GENERAL TECHNICAL REQUIREMENTS		
	IS: 9417	Recommendations for welding cold worked steel bars for reinforced concrete construction.	
	IS: 10262	Recommended guidelines for concrete mix design.	
	IS: 11384	Code of practice for composite construction in structural steel and concrete.	
	IS: 11504	Criteria for structural design of reinforced concrete natural draught cooling towers.	
	IS: 12118	Specification for two-parts poly sulphide.	
	IS: 12200	Code of practice for provision of water stops at transverse contraction joints in masonry and concrete dams.	
	IS: 13311	Method of non-destructive testing of concrete.	
	Part-1	Ultrasonic pulse velocity.	
	Part-2	Rebound hammer.	
	SP:23	Handbook of concrete mixes	
	SP: 24	Explanatory Handbook on IS: 456-1978	
	SP: 34	Handbook on concrete reinforcement and detailing.	
	Precast Concrete Works		
	SP: 7(PartVI/	National Building Code- Structural design of prefabrication and Sec.7) systems building.	
	IS: 10297	Code of practice for design and construction of floors and roofs using precast reinforced/prestressed concrete ribbed or cored slab units.	
	IS: 10505	Code of practice for construction of floors and roofs using pre-cast reinforced concrete units.	
	Masonry and Allied Works		
	IS: 1905	Code of Practice for Structural Safety of Buildings-Masonry walls.	
	IS: 2212	Code of Practice for Brickwork.	
LOT-2 PROJECTS FLUE GAS DESULPHURISATION (FGD) SYSTEM PACKAGE	TECHNICAL SPECIFICATION SECTION – VI BID DOC. NO.:CS-0011-109(2)-9	PART-C GENERAL TECHNICAL REQUIREMENTS	PAGE 55 OF 83

CLAUSE NO.	GENERAL TECHNICAL REQUIREMENTS		
	IS: 2250	Code of Practice for Preparation and use of Masonry Mortar.	
	SP: 20	Explanatory hand book on masonry code.	
	Sheeting Works		
	IS:277	Galvanised steel sheets (plain or corrugated).	
	IS: 459	Unreinforced corrugated and semi-corrugated asbestos cement sheets.	
	IS: 513	Cold-rolled carbon steel sheets.	
	IS: 730	Specification for fixing accessories for corrugated sheet roofing.	
	IS: 1626	Specification for Asbestos cement building pipes and pipe fittings, gutters and gutter fittings and roofing fittings.	
	IS: 2527	Code of practice for fixing rain water gutters and down pipe for roof drainage.	
	IS: 3007	Code of practice for laying of asbestos cement sheets.	
	IS: 5913	Methods of test for asbestos cement products.	
	IS: 7178	Technical supply conditions for tapping screw.	
	IS: 8183	Bonded mineral wool.	
	IS: 8869	Washers for corrugated sheet roofing.	
	IS: 12093	Code of practice for laying and fixing of sloped roof covering using plain and corrugated galvanised steel sheets.	
	IS: 12866	Plastic translucent sheets made from thermosetting polyester resin (glass fibre reinforced).	
	IS: 14246	Specification for continuously pre-painted galvanised steel sheets and coils.	
	Fabrication and Erection of Structural Steel Work		
	IS: 2016	Specification for plain washers.	
<p align="center">LOT-2 PROJECTS FLUE GAS DESULPHURISATION (FGD) SYSTEM PACKAGE</p>	<p align="center">TECHNICAL SPECIFICATION SECTION – VI BID DOC. NO.:CS-0011-109(2)-9</p>	<p align="center">PART-C GENERAL TECHNICAL REQUIREMENTS</p>	<p align="center">PAGE 56 OF 83</p>

CLAUSE NO.	GENERAL TECHNICAL REQUIREMENTS		
	IS: 814 IS: 1852 IS: 3502 IS: 6911 IS: 3757 IS: 6623 IS: 6649 IS: 800 IS: 816 IS: 4000 IS: 9595 IS: 817 IS: 1811 IS: 9178 IS: 9006 IS: 7215 IS: 12843 IS: 4353 SP: 6 (Part 1 to 7)	Specification for covered Electrodes for Metal Arc Welding for weld steel. Specification for Rolling and Cutting Tolerances for Hot rolled steel products. Specifications for chequered plate. Specification for stainless steel plate, sheet and strip. Specification for high strength structural bolts Specification for high strength structural nuts. High Tensile friction grip washers. Code of practice for use of structural steel in general building construction. Code of practice for use of Metal Arc Welding for General Construction. Code of practice for assembly of structural joints using high tensile friction grip fasteners. Code of procedure of Manual Metal Arc Welding of Mild Steel. Code of practice for Training and Testing of Metal Arc Welders. Qualifying tests for Metal Arc Welders (engaged in welding structures other than pipes). Criteria for Design of steel bins for storage of Bulk Materials. Recommended Practice for Welding of Clad Steel. Tolerances for fabrication steel structures. Tolerance for erection of structural steel. Recommendations for submerged arc welding of mild steel and low alloy steels. ISI Hand book for structural Engineers.	
LOT-2 PROJECTS FLUE GAS DESULPHURISATION (FGD) SYSTEM PACKAGE	TECHNICAL SPECIFICATION SECTION – VI BID DOC. NO.:CS-0011-109(2)-9	PART-C GENERAL TECHNICAL REQUIREMENTS	PAGE 57 OF 83

CLAUSE NO.	GENERAL TECHNICAL REQUIREMENTS		
	IS: 1608 IS: 1599 IS : 228 IS : 2595 IS : 1182 IS : 3664 IS : 3613 IS : 3658 IS : 5334	Method of Tensile Testing of Steel products other than sheets, strip, wire and tube. Method of Bend Tests for Steel products other than sheet, strip, wire and tube Methods of chemical Analysis of pig iron, cast iron and plain carbon and low alloy steel. Code of Practice for Radio graphic testing. Recommended practice for Radiographic Examination of fusion welded butt joints in steel plates. Code of practice for Ultra sonic Testing by pulse echo method. Acceptance tests for wire flux combination for submerged Arc Welding. Code of practice for Liquid penetrant Flaw Detection. Code of practice for Magnetic Particle Flaw Detection of Welds. Plastering and Allied Works IS : 1635 IS : 1661 IS : 2333 IS : 2402 IS : 2547 IS : 3150 Acid and Alkali Resistant Lining IS : 158 IS : 412	
LOT-2 PROJECTS FLUE GAS DESULPHURISATION (FGD) SYSTEM PACKAGE	TECHNICAL SPECIFICATION SECTION – VI BID DOC. NO.:CS-0011-109(2)-9	PART-C GENERAL TECHNICAL REQUIREMENTS	PAGE 58 OF 83

CLAUSE NO.	GENERAL TECHNICAL REQUIREMENTS		
	IS : 4441 IS : 4443 IS : 4456 IS : 4457 IS : 4832 IS : 4860 IS : 9510 Water Supply, Drainage and Sanitation IS : 458 IS : 554 IS : 651 IS : 774 IS : 775 IS : 778 IS : 781 IS : 782 IS : 783	Code of practice for use of silicate type chemical resistant mortars. Code of practice for use of resin type chemical resistant mortars. Method of test for chemical resistant tiles. (Part I & II) Specification for ceramic unglazed vitreous acid resistant tiles. Specification for chemical resistant mortars. Part I Silicate type Part II Resin type Part III Sulphur type Specification for acid resistant bricks. Specification for bitumasitc, Acid resisting grade. Specification for concrete pipes. Dimensions for pipe threads, where pressure tight joints are made on thread. Specification for salt glazed stoneware pipes. Flushing cisterns for water closets and urinals. Cast iron brackets and supports for wash basins and sinks. Copper alloy gate, globe and check valves for water works purposes. Cast copper alloy screw down bib taps and stop valves for water services. Caulking lead. Code of practice for laying of concrete pipes.	
LOT-2 PROJECTS FLUE GAS DESULPHURISATION (FGD) SYSTEM PACKAGE	TECHNICAL SPECIFICATION SECTION – VI BID DOC. NO.:CS-0011-109(2)-9	PART-C GENERAL TECHNICAL REQUIREMENTS	PAGE 59 OF 83

CLAUSE NO.	GENERAL TECHNICAL REQUIREMENTS		
	IS : 1172 IS : 1230 IS : 1239 IS : 1536 IS : 1537 IS : 1538 IS : 1703 IS : 1726 IS : 1729 IS : 1742 IS : 1795 IS : 1879 IS : 2064 IS : 2065 IS : 2326 IS : 2470 (Part-I & II) IS : 2501 IS : 2548 IS : 2556 (Part 1 to 15) IS : 2963	Basic requirements for water supply, drainage and sanitation. Cast iron rain water pipes and fittings. Mild steel tubes, tubulars and other wrought steel fittings. Centrifugally cast (Spun) iron pressure pipes for water, gas and sewage. Vertically cast iron pressure pipes for water, gas and sewage. Cast iron fittings for pressure pipe for water, gas and sewage. Ball valves (horizontal plunger type) including float for water supply purposes. Cast iron manhole covers and frames. Sand cast iron spigot and socket, soil, water and ventilating pipes, fittings and accessories. Code of practice for building drainage. Pillar taps for water supply purposes. Malleable cast iron pipe fittings. Code of practice for selection, installation and maintenance of sanitary appliances. Code of practice for water supply in building. Automatic flushing cisterns for urinals. Code of practice for installation of septic tanks. Copper tubes for general engineering purposes. Plastic seat and cover for water-closets. Vitreous sanitary appliances (vitreous china). Non-ferrous waste fittings for wash basins and sinks.	
LOT-2 PROJECTS FLUE GAS DESULPHURISATION (FGD) SYSTEM PACKAGE	TECHNICAL SPECIFICATION SECTION – VI BID DOC. NO.:CS-0011-109(2)-9	PART-C GENERAL TECHNICAL REQUIREMENTS	PAGE 60 OF 83

CLAUSE NO.	GENERAL TECHNICAL REQUIREMENTS		
	IS : 3114 IS : 3311 IS : 3438 IS : 3486 IS : 3589 IS : 3989 IS : 4111 (Part I to IV) IS : 4127 IS : 4764 IS : 4827 IS : 5329 IS : 5382 IS : 5822 IS : 5961 IS : 7740 IS : 8931 IS : 8934 IS : 9762 IS : 10446	Code of practice for laying of cast iron pipes. Waste plug and its accessories for sinks and wash basins. Silvered glass mirrors for general purposes. Cast iron spigot and socket drain pipes. Electrically welded steel pipes for water, gas and sewage (200mm to 2000mm nominal diameter). Centrifugally cast (Spun) iron spigot and socket soil, waste and ventilating pipes, fittings and accessories. Code of practice for ancillary structure in sewerage system. Code of practice for laying of glazed stone-ware pipes. Tolerance limits for sewage effluents discharged into inland-surface waters. Electro plated coating of nickel and chromium on copper and copper alloys. Code of practice for sanitary pipe work above ground for buildings. Rubber sealing rings for gas mains, water mains and sewers. Code of practice for laying of welded steel pipes for water supply. Cast iron grating for drainage purpose. Code of practice for road gullies. Cast copper alloy fancy bib taps and stop valves for water services. Cast copper alloy fancy pillar taps for water services. Polyethylene floats for ball valves. Glossary of terms for water supply and sanitation.	
LOT-2 PROJECTS FLUE GAS DESULPHURISATION (FGD) SYSTEM PACKAGE	TECHNICAL SPECIFICATION SECTION – VI BID DOC. NO.:CS-0011-109(2)-9	PART-C GENERAL TECHNICAL REQUIREMENTS	PAGE 61 OF 83

CLAUSE NO.	GENERAL TECHNICAL REQUIREMENTS			
	IS : 10592	Industrial emergency showers, eye and face fountains and combination units.		
	IS : 12592	Specification for precast concrete manhole covers and frames.		
	IS : 12701	Rotational moulded polyethylene water storage tanks.		
	SP: 35	Hand book on water supply and drainage.		
	-	Manual on Sewerage and sewage treatment (Published by CPH & EEO) As updated.		
	Doors, Windows and Allied Works			
	IS : 204	Tower Bolts		
	Part-I	Ferrous metals.		
	Part-II	Nonferrous metals.		
	IS : 208	Door Handles.		
	IS : 281	Mild steel sliding door bolts for use with padlocks.		
	IS : 362	Parliament Hinges.		
	IS : 420	Specification for putty, for use on metal frames.		
	IS : 1003 Part-I door	Specification for timber panelled and glazed shutters- (Part-I) shutters.		
	IS : 1038	Steel doors, windows and ventilators.		
	IS : 1081	Code of practice for fixing and glazing of metal (steel and aluminium) doors, windows and ventilators.		
	IS : 1341	Steel butt hinges.		
	IS : 1361	Steel windows for industrial buildings.		
	IS : 1823	Floor door stoppers.		
	IS : 1868	Anodic coatings on Aluminium and its alloys.		
	IS : 2202 (Part-II)	Specification for wooden flush door shutters (solid core type); particle board face panels and hard board face panels		
LOT-2 PROJECTS FLUE GAS DESULPHURISATION (FGD) SYSTEM PACKAGE	TECHNICAL SPECIFICATION SECTION – VI BID DOC. NO.:CS-0011-109(2)-9	PART-C GENERAL TECHNICAL REQUIREMENTS	PAGE 62 OF 83	

CLAUSE NO.	GENERAL TECHNICAL REQUIREMENTS		
	IS:2209 IS:2553 IS:2835 IS:3548 IS:3564 IS : 3614 IS:4351 IS:5187 IS:5437 IS:6248 IS:6315 IS:7196 IS:7452 IS:10019 IS:10451 IS:10521 R oof Water Proofing and AlliedWorks IS:1203 IS:1322 IS:1346 IS:1580	Mortice locks (vertical type). Safety glass Flat transparent sheet glass. Code of practice for glazing in buildings. Door closers (Hydraulically regulated). Fire check doors; plate, metal covered and rolling type. Steel door frames. Flush bolts. Wired and figured glass Metal rolling shutters and rolling grills. Floor springs (hydraulically regulated) for heavy doors. Hold fasts. Hot rolled steel sections for doors, windows and ventilators. Mild steel stays and fasteners. Steel sliding shutters (top hung type). Collapsible gates. Methods of testing tar and bitumen. Specification for bitumen felts for water proofing and damp proofing. Code of practice for water proofing of roofs with bitumen felts. Specification for bituminous compound for water proofing and caulking purposes.	
LOT-2 PROJECTS FLUE GAS DESULPHURISATION (FGD) SYSTEM PACKAGE	TECHNICAL SPECIFICATION SECTION – VI BID DOC. NO.:CS-0011-109(2)-9	PART-C GENERAL TECHNICAL REQUIREMENTS	PAGE 63 OF 83

CLAUSE NO.	GENERAL TECHNICAL REQUIREMENTS		
	IS:3067	Code of practice for general design details and preparatory work for damp proofing and water proofing of buildings.	
	IS:3384	Specification for bitumen primer for use in water proofing and damp proofing.	
	Floor Finishes and Allied Works		
	IS:1237	Specification for cement concrete flooring tiles.	
	IS:1443	Code of practice for laying and finishing of cement concrete flooring tiles.	
	IS:2114	Code of practice for laying in-situ terrazzo floor finish.	
	IS:2571	Code of practice for laying in-situ cement concrete flooring.	
	IS:3462	Specification for unbacked flexible PVC flooring.	
	IS:4971	Recommendations for selection of industrial floor finishes.	
	IS:5318	Code of practice for laying of flexible PVC sheet and tile flooring.	
	IS:8042	Specification for white portland cement.	
	IS:13801	Specification for chequered cement concrete flooring tiles.	
	Painting and Allied Works		
	IS:162	Specification for fire resisting silicate type, brushing, for use on wood, colour as required.	
	IS:1477	Code of practice for painting of ferrous metals in buildings.	
	Part-I	Pretreatment.	
	Part-II	Painting.	
	IS:1650	Specification for colours for building and decorative finishes.	
	IS:2074	Specification for red oxide-zinc chrome, priming, ready mixed paint air drying.	
	IS:2338	Code of practice for finishing of wood and wood based materials.	
	Part-I	Operations and workmanship	
LOT-2 PROJECTS FLUE GAS DESULPHURISATION (FGD) SYSTEM PACKAGE	TECHNICAL SPECIFICATION SECTION – VI BID DOC. NO.:CS-0011-109(2)-9	PART-C GENERAL TECHNICAL REQUIREMENTS	PAGE 64 OF 83

CLAUSE NO.	GENERAL TECHNICAL REQUIREMENTS		
	Part-II IS:2395 Part-I Part-II IS:2524 Part-I Part-II IS:2932 IS:2933 IS:4759 IS:5410 IS:5411 (Part-I) IS:6278 IS:10403 Piling and Foundation IS:1080 IS:1904 IS:2911 IS:2950 IS:2974 (Part-I TO V) IS:6403	Schedules Code of practice for painting concrete, masonry and plaster surfaces. Operations and workmanship. Schedule. Code of practice for painting of nonferrous metals in buildings. Pretreatment. Painting. Specification of synthetic enamel paint, exterior, under-coating and finishing. Specification enamel paint, under coating and finishing. Code of practice for hot dip zinc coating on structural steel and other allied products. Specification for cement paint Specification for plastic emulsion paint-for exterior use Code of practices for white washing and colour washing. Glossary of terms relating to building finishes. Code of practice for design and construction of simple spread foundations. Code of practice for design and construction of foundations in Soils; General Requirements. Code of practice for designs and construction of Pile foundations (Relevant Parts). Code of practice for designs and construction of Raft (Part-I) foundation. Code of practice for design and construction of machine foundations. Code of practice for determination of Allowable Bearing pressure on Shallow foundation.	
LOT-2 PROJECTS FLUE GAS DESULPHURISATION (FGD) SYSTEM PACKAGE	TECHNICAL SPECIFICATION SECTION – VI BID DOC. NO.:CS-0011-109(2)-9	PART-C GENERAL TECHNICAL REQUIREMENTS	PAGE 65 OF 83

CLAUSE NO.	GENERAL TECHNICAL REQUIREMENTS		
	IS:8009	Code of practice for calculation of settlement of foundation subjected to symmetrical vertical loads.	
	Part-I	Shallow foundations.	
	Part-II	Deep foundations.	
	IS:12070	Code of practice for design and construction of shallow foundations on rocks.	
	DIN:4024	Flexible supporting structures for machines with rotating machines.	
	VDI:2056	Criteria for assessing mechanical vibrations of machines.	
	VDI:2060	Criteria for assessing rotating imbalances in machines.	
	Stop Log and Trash Rack		
	IS:4622	Recommendations for fixed - wheel gates structural design.	
	IS:5620	Recommendations for structural design criteria for low head slide gates.	
	IS:11388	Recommendations for design of trash rack for intakes.	
	IS:11855	General requirements for rubber seals for hydraulic gates.	
	Roads		
	IRC:5	Standard specifications and Code of practice for road bridges, section-I general Features of Design.	
	IRC:14	Recommended practice of 2cm thick bitumen and tar carpets.	
	IRC:16	Specification for priming of base course with bituminous primers.	
	IRC:19	Standard specifications and code of practice for water bound macadam.	
	IRC:21	Standard specifications and Code of practice for road bridges, section-III - Cement concrete (plain and reinforced).	
	IRC:34	Recommendations for road construction in waterlogged areas.	
	IRC:36	Recommended practice for the construction of earth embankments for road works.	
	IRC:37	Guidelines for the Design of flexible pavements.	
	IRC:56	Recommended practice for treatment of embankment slopes for erosion control.	
	IRC:73	Geometric design standards for rural (non-urban) highways.	
	IRC:86	Geometric Design standards for urban roads in plains.	
<p align="center">LOT-2 PROJECTS FLUE GAS DESULPHURISATION (FGD) SYSTEM PACKAGE</p>	<p align="center">TECHNICAL SPECIFICATION SECTION – VI BID DOC. NO.:CS-0011-109(2)-9</p>	<p align="center">PART-C GENERAL TECHNICAL REQUIREMENTS</p>	<p align="center">PAGE 66 OF 83</p>

CLAUSE NO.	GENERAL TECHNICAL REQUIREMENTS		
	<p>IRC:SP:13</p> <p>IRC - Public- ation</p> <p>IS:73</p> <p>Loadings</p> <p>IS:875 (Pt. I to V)</p> <p>IS:1893</p> <p>IS:4091</p> <p>IRC:6</p> <p>M.O.T.</p> <p>Safety</p> <p>IS:3696 (Part I & II)</p> <p>IS:3764</p> <p>IS:4081</p> <p>IS:4130</p> <p>IS:5121</p> <p>IS:5916</p> <p>IS:7205</p> <p>IS:7293</p> <p>IS:7969</p> <p>IS:11769</p> <p>- Indian Explosives Act. 1940 as updated.</p> <p>Architectural design of buildings</p> <p>SP:7</p> <p>SP:41</p>	<p>Guidelines for the design of small bridges & culverts.</p> <p>Ministry of Surface Transport (Roads Wing), Specifications for road and bridge works.</p> <p>Specification for paving bitumen</p> <p>Code of practice for design loads other than earthquake) for buildings and structures.</p> <p>Criteria for earthquake resistant design of structures.</p> <p>Code of Practice for design and construction of foundation for transmission line towers & poles.</p> <p>Standard specifications & code of practice for road bridges, Section-II Loads and stresses.</p> <p>Deptt. of railways Bridge Rules.</p> <p>Safety code for scaffolds and ladders.</p> <p>Safety code for excavation work.</p> <p>Safety code for blasting and related drilling operations.</p> <p>Safety code for demolition of buildings.</p> <p>Safety code for piling and other deep foundations.</p> <p>Safety code for construction involving use of hot bituminous materials.</p> <p>Safety code for erection on structural steelwork.</p> <p>Safety code for working with construction machinery.</p> <p>Safety code for handling and storage of building materials</p> <p>Guidelines for safe use of products containing asbestos.</p> <p>National Building Code of India</p> <p>Hand book on functional requirements of buildings (other than industrial buildings)</p>	
<p>LOT-2 PROJECTS FLUE GAS DESULPHURISATION (FGD) SYSTEM PACKAGE</p>	<p>TECHNICAL SPECIFICATION SECTION – VI BID DOC. NO.:CS-0011-109(2)-9</p>	<p>PART-C GENERAL TECHNICAL REQUIREMENTS</p>	<p>PAGE 67 OF 83</p>

CLAUSE NO.	GENERAL TECHNICAL REQUIREMENTS			
	<p>Miscellaneous</p> <p>IS:802 Code of practice for use of structural steel in (Relevant parts) overhead transmission line towers.</p> <p>IS:803 Code of practice for design, fabrication and erection of vertical mild steel cylindrically welded in storage tanks.</p> <p>IS:10430 Creteria for design of lined canals and liner for selection of type of lining.</p> <p>IS:11592 Code of practice for selection and design of belt conveyors.</p> <p>IS:12867 PVC handrails covers.</p> <p>CIRIA Design and construction of buried thin-wall pipes.</p> <p>Publication</p>			
<p>LOT-2 PROJECTS FLUE GAS DESULPHURISATION (FGD) SYSTEM PACKAGE</p>	<p>TECHNICAL SPECIFICATION SECTION – VI BID DOC. NO.:CS-0011-109(2)-9</p>	<p>PART-C GENERAL TECHNICAL REQUIREMENTS</p>	<p>PAGE 68 OF 83</p>	

CLAUSE NO.	GENERAL TECHNICAL REQUIREMENTS			
	<p data-bbox="386 226 1424 296">REFERENCE CODES AND STANDARDS FOR CONTROL AND INSTRUMENTATION</p> <p data-bbox="386 323 1424 464">The design, manufacture, inspection, testing & installation of all equipment and system covered under this specification shall conform to the latest editions of codes and standards mentioned below and all other applicable VDE, IEEE, ANSI, ASME, NEC, NEMA, ISA AND Indian Standards and their equivalents.</p> <p data-bbox="386 548 756 579">Temperature Measurements</p> <ol data-bbox="386 611 1424 856" style="list-style-type: none"> 1. Instrument and apparatus for temperature measurement - ASME PTC 19.3 (1974). 2. Temperature measurement - Thermocouples ANSI MC 96.1 - 1982. 3. Temperature measurement by electrical Resistance thermometers - IS:2806. 4. Thermometer - element - Platinum resistance - IS:2848. <p data-bbox="386 884 708 915">Pressure Measurements</p> <ol data-bbox="386 947 1424 1192" style="list-style-type: none"> 1. <ol data-bbox="477 947 1424 1073" style="list-style-type: none"> a) Instruments and apparatus for pressure measurement - ASME PTC 19.2 (1964). b) Electronic transmitters BS:6447. 2. Bourdon tube pressure and vacuum gauges - IS:3624 - 1966. 3. Process operated switch devices (Pr. Switch) BS-6134. <p data-bbox="386 1220 654 1251">Flow Measurements</p> <p data-bbox="386 1276 1424 1346">Instruments and apparatus for flow measurements - ASME PTC 19.5 (1972) Interim supplement, Part-II.</p> <p data-bbox="386 1373 1065 1404">Measurement of fluid flow in closed conduits - BS-1042.</p> <p data-bbox="386 1432 1214 1463">Electronic Measuring Instrument & Control Hardware/ Software</p> <ol data-bbox="386 1495 1424 1749" style="list-style-type: none"> 1. Automatic null balancing electrical measuring instruments - ANSI C 39.4 (Rev. 1973): IS:9319. 2. Safety requirements for electrical and electronic measuring and controlling instrument - ANSI C 39.5 - 1974. 3. Compatibility of analog signals for electronic industrial process instruments - ISA - S 50.1 (1982) ANSI MC 12.1 - 1975. 			
<p data-bbox="233 1871 610 1940">LOT-2 PROJECTS FLUE GAS DESULPHURISATION (FGD) SYSTEM PACKAGE</p>	<p data-bbox="651 1871 951 1940">TECHNICAL SPECIFICATION SECTION – VI BID DOC. NO.:CS-0011-109(2)-9</p>	<p data-bbox="1013 1871 1232 1940">PART-C GENERAL TECHNICAL REQUIREMENTS</p>	<p data-bbox="1300 1871 1386 1919">PAGE 69 OF 83</p>	

CLAUSE NO.	GENERAL TECHNICAL REQUIREMENTS			
	<ol style="list-style-type: none"> 4. Dynamic response testing of process control instrumentation ISA - S 26 (1968). 5. Surge Withstand Capability (SWC) tests - ANSI C 37.90 a/IEEE-472 or suitable class of IEC-255-4 equivalent to ANSI C37.90a/IEEE-472. 6. Printed circuit boards - IPC TM - 650, IEC 326 C. 7. General requirement and tests for printed wiring boards - IS 7405 (Part-I) 1973. 8. Edge socket connectors - IEC 130-11. 9. Requirements and methods of testing of wire wrap terminations DIN 41611 Part-2. 10. Dimensions of attachment plugs & receptacles - ANSI C 73 - 1973 (Supplement ANSI C 73 a - 1980). 11. Direct acting electrical indicating instrument - IS:1248 - 1968 (R). 12. Standard Digital Interface for Programmable Instrumentation - IEEE-488.2 - 1990. 13. Information Processing Systems - Local Area Networks - Part 2 : Logical Link Control - IEEE-802.2 - 1989. 14. Standard for Local Area Networks : Carrier Sense Multiple Access with Collision Detection - IEEE-802.3 - 1985. 15. Supplements A, B, C and E to Carrier Sense Multiple Access with Collision Detection - IEEE-802.3 - 1988. 16. Standard for Local Area Networks : Token - Passing Bus Access Method - IEEE-802.4 - 1985. 17. Standard for Local Area Networks : Token - Ring Access Method and Physical Layer Specification - IEEE-802.5 - 1985. 18. IEEE Guide to Software Requirements Specifications - IEEE-830 - 1984. 19. Hardware Testing of Digital Process Computers - ISA RP55.1 - 1983. 20. Electromagnetic Susceptibility of Process Control Instrumentation - SAMA PMC 33.1 - 1978. 21. Interface Between the Data Terminal Equipment and Data Circuit - Terminating Equipment Employing Serial Binary Data Interchange - EIA-232-D-1987. 			
<p align="center">LOT-2 PROJECTS FLUE GAS DESULPHURISATION (FGD) SYSTEM PACKAGE</p>	<p align="center">TECHNICAL SPECIFICATION SECTION – VI BID DOC. NO.:CS-0011-109(2)-9</p>	<p align="center">PART-C GENERAL TECHNICAL REQUIREMENTS</p>	<p align="center">PAGE 70 OF 83</p>	

CLAUSE NO.	GENERAL TECHNICAL REQUIREMENTS			
	<p>22. Electromagnetic Compatibility for Industrial Process Measurement and Control Equipment, Part 3 : Radiated Electromagnetic Field Requirements - IEC 801-3-1984.</p> <p>Instrument Switches and Contact</p> <p>1. Contact rating - AC services NEMA ICS 2 - 1978 (with revision through May 1983), Part - 2-125, A6000.</p> <p>2. Contact rating - DC services NEMA ICS 2-1978 Part-2 125, N600.</p> <p>Enclosures</p> <p>1. Type of Enclosures - NEMA ICS Part - 6 - 1978 (with Rev. 1 4/80) through 110.22 (Type 4 to 13).</p> <p>2. Racks, panels and associated equipment - EIA : RS - 310 C- 1983 (ANSI C 83.9 - 1972).</p> <p>3. Protection class for Enclosures, cabinets, control panels & desks - IS:2147 - 1962.</p> <p>Apparatus, enclosures and installation practices in hazardous area</p> <p>1. Classification of hazardous area - NFPA 70 - 1984, Article 500.</p> <p>2. Electrical Instruments in hazardous dust location - ISA - 512.11, 1973.</p> <p>3. Intrinsically safe apparatus - NFPA 493 1978.</p> <p>4. Purged and pressurised enclosure for electrical equipment in hazardous location - NFPA 496-1982.</p> <p>5. Enclosures for Industrial Controls and Systems - NEMA IS 1.1 - 1977.</p>			
<p>LOT-2 PROJECTS FLUE GAS DESULPHURISATION (FGD) SYSTEM PACKAGE</p>	<p>TECHNICAL SPECIFICATION SECTION – VI BID DOC. NO.:CS-0011-109(2)-9</p>	<p>PART-C GENERAL TECHNICAL REQUIREMENTS</p>	<p>PAGE 71 OF 83</p>	

CLAUSE NO.	GENERAL TECHNICAL REQUIREMENTS			
	<p>Sampling System</p> <ol style="list-style-type: none"> 1. Stainless steel material of tubing and valves for sampling system - ASTMA 296-82, Grade 7 P 316. 2. Submerged helical coil heat exchangers for sample coolers ASTM D11 92-1977. 3. Water and steam in power cycle - ASME PTC 19.11. 4. Standard methods of sampling system - ASTM D 1066-99. <p>Annunciators</p> <ol style="list-style-type: none"> 1. Specifications and guides for the use of general purpose annunciators - ISA S 19.1, 1979. 2. Surge withstand capability tests - ANSI C 37.90a - 1989/IEEE-472 or suitable class of IEC 255-4 equivalent to ANSI C37.90a 1989/IEEE-472 3. Damp heat cycling test - IS:2106 4. Specification for Electromagnetic Susceptibility - SAMA DMC 33, 1/78 <p>Protections</p> <ol style="list-style-type: none"> 1. Relays and relay system associated with electric power apparatus. ANSI C 37.90, 1 - 1989. 2. General requirements & tests for switching devices for control and auxiliary circuits including contactor relays - IS:6875 (Part-I) - 1973. 3. Turbine water damage prevention - ASME TDP-1-1980. 4. Boiler safety interlocks - NFPA 85 - 2011 or latest version. 			
<p align="center">LOT-2 PROJECTS FLUE GAS DESULPHURISATION (FGD) SYSTEM PACKAGE</p>	<p align="center">TECHNICAL SPECIFICATION SECTION – VI BID DOC. NO.:CS-0011-109(2)-9</p>	<p align="center">PART-C GENERAL TECHNICAL REQUIREMENTS</p>	<p align="center">PAGE 72 OF 83</p>	

CLAUSE NO.	GENERAL TECHNICAL REQUIREMENTS			
	<p>UPS System</p> <ol style="list-style-type: none"> 1. Practices and requirements for semi-conductor power rectifiers - ANSI C 34.2, 1973. 2. Relays and relays system associated with electrical power apparatus - ANSI C 3.90 - 1983. 3. Surge withstand capability test - ANSI C 37.90 1 -1989. 4. Performance testing of UPS - IEC 146. 5. Stationary cells & Batteries Lead Acid type (with tubular positive plates) specification IS-1651-1991. 6. Recommended practice for sizing large lead storage batteries for generating stations & sub-stations - IEEE-485-1985. 7. Printed Circuit Board - IPC TM 650, IEC 326C. 8. General Requirements & tests for printed wiring boards, IS:7405 (Part-I) 1973. <p>Control Valves</p> <ol style="list-style-type: none"> 1. Control valve sizing - Compressible & Incompressible fluids - ISA S 75.01-1985. 2. Face to face dimensions of control valves - ANSI B 16.00 - 1973. 3. ISA Hand Book of Control Valves - (ISBN : B: 1047-087664-234-2). 4. Codes for pressure piping - ANSI B 31.1 5. Control Valve leak class - ISA RP 39.6 <p>Process Connection & Piping</p> <ol style="list-style-type: none"> 1. Codes for pressure piping "power piping" - ANSI B 31.1. 2. Seamless carbon steel pipe ASTM - A - 106. 3. Forged & Rolled Alloy steel pipe flanges, forged fittings and valves and parts - ASTM - A - 182. 4. Material for socket welded fittings - ASTM - A - 105. 5. Seamless ferritic alloy steep pipe - ASTM - A - 335. 			
<p align="center">LOT-2 PROJECTS FLUE GAS DESULPHURISATION (FGD) SYSTEM PACKAGE</p>	<p align="center">TECHNICAL SPECIFICATION SECTION – VI BID DOC. NO.:CS-0011-109(2)-9</p>	<p align="center">PART-C GENERAL TECHNICAL REQUIREMENTS</p>	<p align="center">PAGE 73 OF 83</p>	

CLAUSE NO.	GENERAL TECHNICAL REQUIREMENTS		
	<div style="text-align: right; border: 1px solid black; padding: 2px; width: fit-content; margin: 0 auto;"> एनटीपीसी NTPC </div> <p>6. Pipe fittings of wrought carbon steel and alloy steel - ASTM - A - 234.</p> <p>7. Composition bronze of ounce metal castings - ASTM - B - 62.</p> <p>8. Seamless Copper tube, bright annealed - ASTM - B - 168.</p> <p>9. Seamless copper tube - ASTM - B - 75.</p> <p>10. Dimension of fittings - ANSI - B - 16.11.</p> <p>11. Valves flanged and butt welding ends - ANSI - B - 16.34.</p> <p>Instrument Tubing</p> <p>1. Seamless carbon steel pipe - ASTM - A 106.</p> <p>2. Material of socketweld fittings - ASTM - A105.</p> <p>3. Dimensions of fittings - ANSI - B - 16.11.</p> <p>4. Code for pressure piping, welding, hydrostatic testing - ANSI B 31.1.</p> <p>Cables</p> <p>1. Thermocouples extension wires/cables - ANSI MC 96.1 - 1992.</p> <p>2. Requirements for copper conductor-Wiring cables for telecommunications & information processing system - VDE:0815.</p> <p>3. Colour coding of single or multi-pair cables - ICEA - S - 61-402 (third edition) NEMA WCS - 1979 with revisions through 2/83.</p> <p>4. Insulation & Sheathing compounds for cables : VDE 0207 (Part-4, 5 & 6).</p> <p>5. Guide design and installation of cable systems in power generating stations (insulation, jacket materials) - IEEE Std. 422-1977.</p> <p>6. Rules for Testing insulated cables and flexible cables : VVDE - 0472</p> <p>7. Requirements of vertical flame propagation test - IEEE 383 - 1974 (R 1980)</p> <p>8. Standard specification for tinned soft or annealed copper wire for electrical purpose - ASTM B-33-81.</p> <p>9. Oxygen index and temperature index test - ASTM D - 2863.</p> <p>10. Smoke density measurement test - ASTMD - 2843.</p> <p>11. Acid gas generation test - IEC - 754 - 1.</p>		
<p style="text-align: center;">LOT-2 PROJECTS FLUE GAS DESULPHURISATION (FGD) SYSTEM PACKAGE</p>	<p style="text-align: center;">TECHNICAL SPECIFICATION SECTION – VI BID DOC. NO.:CS-0011-109(2)-9</p>	<p style="text-align: center;">PART-C GENERAL TECHNICAL REQUIREMENTS</p>	<p style="text-align: center;">PAGE 74 OF 83</p>

CLAUSE NO.	GENERAL TECHNICAL REQUIREMENTS			
	<p>12. Swedish Chimney test - SEN - 4241475 (F3).</p> <p>13. Teflon (FEP) insulation & sheath test - ASTM D - 2116.</p> <p>14. Thermocouple compensating cables - Testing requirements & sampling plan IS:8784.</p> <p>15. PVC insulated electric cables for working voltage upto and including 1100 V - IS:1554 (Part-I).</p> <p>Cable Trays, Conduits</p> <p>1. Guide for design and installation of cable systems in power generating station (Cable trays, support systems, conduits) - IEEE Std. 422, 1977, NEMA VE-1 1979, NFPA 70-1984.</p> <p>2. -do- Test Standards. NEMA VE-1-1979.</p> <p>3. Zinc coating "hot dip" on assembled products for galvanising of carbon steel cable trays - ASTM A - 386-78.</p> <p>Public Address System</p> <p>1. Specifications for loud speakers - IS:7741 (Part-I, II and III)</p> <p>2. Code of safety requirement for electric mains operated audio amplifiers - IS:1301</p> <p>3. Specification for Public Address Amplifiers - IS:10426.</p> <p>4. Code of practice for outdoor installation of PA system - IS:1982.</p> <p>5. Code of practice for installation for indoor amplifying and sound distribution system - IS:1881.</p> <p>6. Basic environmental testing procedures for electronic and electrical items - IS:9000.</p> <p>7. Characteristics and methods of measurements for sound system equipment - IS:9302</p> <p>8. Code of practice of electrical wiring installations (System voltage not exceeding 650 volts) - IS:732</p> <p>9. Rigid steel conduits for electric wiring - IS:9537 (Part-I and II)</p> <p>10. Fittings for rigid steel conduits for electrical wiring - IS:2667</p>			
<p align="center">LOT-2 PROJECTS FLUE GAS DESULPHURISATION (FGD) SYSTEM PACKAGE</p>	<p align="center">TECHNICAL SPECIFICATION SECTION – VI BID DOC. NO.:CS-0011-109(2)-9</p>	<p align="center">PART-C GENERAL TECHNICAL REQUIREMENTS</p>	<p align="center">PAGE 75 OF 83</p>	

CLAUSE NO.	GENERAL TECHNICAL REQUIREMENTS			
	<p>11. Degree of protection provided by enclosure for low voltage switchgear and control gear - IS:2147.</p> <p>Vibration Monitoring System</p> <ol style="list-style-type: none"> 1. API 670 - 1994 2. BS : 4675 Part-2 			
<p>LOT-2 PROJECTS FLUE GAS DESULPHURISATION (FGD) SYSTEM PACKAGE</p>	<p>TECHNICAL SPECIFICATION SECTION – VI BID DOC. NO.:CS-0011-109(2)-9</p>	<p>PART-C GENERAL TECHNICAL REQUIREMENTS</p>	<p>PAGE 76 OF 83</p>	

ANNEXURE-I

MFGR.'s LOGO	MANUFACTURER'S NAME AND ADDRESS	MANUFACTURING QUALITY PLAN		PROJECT :
		ITEM :	QP NO.:	PACKAGE :
		SUB-SYSTEM:	REV.NO.:	CONTRACT NO. :
			DATE:	MAIN-SUPPLIER:
			PAGE: OF....	

SL. NO	COMPONENT & OPERATIONS	CHARACTERISTICS	CLASS	TYPE OF CHECK	QUANTUM OF CHECK		REFERENCE DOCUMENT	ACCEPTANCE NORMS	FORMAT OF RECORD		AGENCY			REMARKS
					M	C / N				D*	M	C	N	
1.	2.	3.	4.	5.	6.		7.	8.	9.	D*	**	10.		11.

		LEGEND: * RECORDS, IDENTIFIED WITH "TICK" (✓) SHALL BE ESSENTIALLY INCLUDED BY SUPPLIER IN QA DOCUMENTATION. ** M: MANUFACTURER/SUB-SUPPLIER C: MAIN SUPPLIER, N: NTPC P: PERFORM W: WITNESS AND V: VERIFICATION, AS APPROPRIATE, CHP: NTPC SHALL IDENTIFY IN COLUMN "N" AS 'W'	 FOR NTPC USE	DOC. NO.:		REV..... CAT.....	
MANUFACTURER/ SUB-SUPPLIER	MAIN-SUPPLIER						
SIGNATURE				REVIEWED BY	APPROVED BY	APPROVAL SEAL	

FORMAT NO.: QS-01-QAI-P-09/F1-R1

1/1

ENGG. DIV./QA&I

LOT-2 PROJECTS FLUE GAS DESULPHURISATION (FGD) SYSTEM PACKAGE	TECHNICAL SPECIFICATION SECTION – VI BID DOC. NO.:CS-0011-109(2)-9	PART-C GENERAL TECHNICAL REQUIREMENT	PAGE 76 OF 83
---	--	---	---------------

ANNEXURE-II

SUPPLIER'S LOGO	SUPPLIER'S NAME AND ADDRESS	FIELD QUALITY PLAN		PROJECT :
		ITEM :	QP NO.:	PACKAGE :
		SUB-SYSTEM:	REV. NO.:	CONTRACT NO. :
			DATE:	MAIN-SUPPLIER:
			PAGE: OF....	

SL. NO	ACTIVITY AND OPERATION	CHARACTERISTICS / INSTRUMENTS	CLASS OF CHECK #	TYPE OF CHECK	QUANTUM OF CHECK	REFERENCE DOCUMENT	ACCEPTANCE NORMS	FORMAT OF RECORD		REMARKS
1.	2.	3.	4.	5.	6.	7.	8.	9.	D*	10.

MANUFACTURER/ SUB-SUPPLIER	MAIN-SUPPLIER	LEGEND: * RECORDS, INDENTIFIED WITH "TICK" (√) SHALL BE ESSENTIALLY INCLUDED BY SUPPLIER IN QA DOCUMENTATION. LEGEND TO BE USED: CLASS # : A = CRITICAL, B=MAJOR, C=MINOR; 'A' SHALL BE WITNESSED BY NTPC FQA, 'B' SHALL BE WITNESSED BY NTPC ERECTION / CONSTRUCTION DEPTT. AND 'C' SHALL BE WITNESSED BY MAIN SUPPLIER (A & B CHECK SHALL BE NTPC CHP STAGE)	 FOR NTPC USE	DOC. NO.:		REV.....	
				REVIEWED BY	APPROVED BY	APPROVAL SEAL	

FORMAT NO.: QS-01-QAI-P-09/F2-R1

1/1

ENGG. DIV./QA&I

LOT-2 PROJECTS FLUE GAS DESULPHURISATION (FGD) SYSTEM PACKAGE	TECHNICAL SPECIFICATION SECTION – VI BID DOC. NO.:CS-0011-109(2)-9	PART-C GENERAL TECHNICAL REQUIREMENT	PAGE 77 OF 83
---	--	---	---------------

THIS IS PART OF TECHNICAL SPECIFICATION PE- IS-468-571-A90T REV 00.

ANNEXURE-III

	Project :	Stage :	LIST OF ITEMS REQUIRING QUALITY PLAN AND SUB-SUPPLIER APPROVAL	DOC. NO.:
	Package :			REV. NO.:
	Supplier :			DATE :
	Contractor No. :		SUB-SYSTEM :	PAGE : OF

S. N.	Item	QP/ Insp. Cat.	QP No.	QP Sub. Schedule	QP approval schedule	Proposed sub-supplier	Place	Sub-suppliers approval status / category	Sub-supplier Details submission schedule	Remarks

LEGENDS

SYSTEM SUPPLIER/SUB-SUPPLIER APPROVAL STATUS CATEGORY (SHALL BE FILLED BY NTPC)

A – For these items proposed vendor is acceptable to NTPC. To be indicated with letter “A” in the list alongwith the condition of approval, if any.

DR – For these items “Detailed required” for NTPC review. To be identified with letter “DR” in the list.

NOTED – For these items vendors are approved by Main Supplier and accepted by NTPC without specific vendor approval from NTPC. To be identified with “NOTED.”

QP/INSPN CATEGORY:

CAT-I : For these items the Quality Plans are approved by NTPC and the final acceptance will be on physical inspection witness by NTPC.

CAT-II : For these items the Quality Plans approved by NTPC. However no physical inspection shall be done by NTPC. The final acceptance by NTPC shall be on the basis review of documents as per approved QP.

CAT-III : For these items Main Supplier approves the Quality Plans. The final acceptance by NTPC shall be on the basis certificate of conformance by the main supplier.

UNITS/WORKS : Place of manufacturing Place of Main Supplier of multi units/works.

THIS IS PART OF TECHNICAL SPECIFICATION PIE-TS-468-571-A901 REV.00.

LOT-2 PROJECTS FLUE GAS DESULPHURISATION (FGD) SYSTEM PACKAGE	TECHNICAL SPECIFICATION SECTION – VI BID DOC. NO.:CS-0011-109(2)-9	PART-C GENERAL TECHNICAL REQUIREMENT	PAGE 78 OF 83
---	--	---	---------------

ANNEXURE-IV

	Project :	Stage :	STATUS OF ITEM REQUIRING QP& SUB-SUPPLIER APPROVAL					DOC. NO.:			
	Package :							REV. NO.:			
	Contractor :							DATE :			
	Contractor No. :							PAGE : OF			
S. N.	Item / Service	QP/ Insp. Cat.	QP Sub. Schedule Approval schedule	Date of submission	Date of comm t Appl.	Status Code C/II/I	Proposed Sub-suppliers	Place of manufacturing works	Approval Status	Sub-supplier detail submission schedule	Remarks
FORMAT						1/1	Engg. Div. / QA&I				

THIS IS PART OF TECHNICAL SPECIFICATION PE-TS-468-571-A901 REV 00.

ANNEXURE-V

	Project :		Stage :		FIELD WELDING SCHEDULE (To be raised by the contractor) Welding Code:							DOC. NO.:				
	Contractor :											REV. NO.:				
	Contractor No. :				DATE :											
	System :				PAGE : OF											
Sl. No.	DRG No. for Weld Location and Identification mark	Description of parts to welded	Matl. Spec.	Dimensions		Process of welding	Type of Weld	Electrode filler spec.	WPS. No.	Min. pre-heat	Heat treatment		NDT method/ Quantum	REF		Remarks
											Temp.	Holding time		Spec. No.	ACC Norm Ref.	
NOTES:																
SIGNATURE																
FORMAT						1/1						Engg. Div. / QA&I				

THIS IS PART OF TECHNICAL SPECIFICATION PE-TS-468-571-A901 REV 00.



CLAUSE NO.	GENERAL TECHNICAL REQUIREMENTS (Annexure-VI)																																		
	<table border="1"> <thead> <tr> <th data-bbox="359 331 454 436">S.No</th> <th data-bbox="454 331 901 436">Description of Drgs/Docs</th> <th data-bbox="901 331 1093 436">No of Prints</th> <th data-bbox="1093 331 1455 436">of No of CD ROMs/DVDs/Portable Hard Disk</th> </tr> </thead> <tbody> <tr> <td data-bbox="359 436 454 1265">1</td> <td data-bbox="454 436 901 1265"> Drawings, Data sheets, Design calculations, Purchase specifications and other documents First submission and submission with major changes <ul style="list-style-type: none"> ▪ Layout (A0&A1 sizes) ▪ Other Drawings/Documents (A0&A1 sizes) ▪ P&ID (All sizes) a) Final drawings/documents (Directly to site) b) "As Built" Drawing/Documents (Directly to site) c) Analysis reports of Equipments / piping /structures components/system employing software packages as detailed in the specifications. </td> <td data-bbox="901 436 1093 1265"></td> <td data-bbox="1093 436 1455 1265"></td> </tr> <tr> <td data-bbox="359 1265 454 1339">2</td> <td data-bbox="454 1265 901 1339">Erection Manual (Directly to site)</td> <td data-bbox="901 1265 1093 1339">4 sets</td> <td data-bbox="1093 1265 1455 1339">2</td> </tr> <tr> <td data-bbox="359 1339 454 1473">3</td> <td data-bbox="454 1339 901 1473"> Operation & Maintenance manual i) First Submission </td> <td data-bbox="901 1339 1093 1473">1 set</td> <td data-bbox="1093 1339 1455 1473">--</td> </tr> <tr> <td data-bbox="359 1473 454 1547"></td> <td data-bbox="454 1473 901 1547">ii) Final Submission (Directly to site)</td> <td data-bbox="901 1473 1093 1547">4 sets</td> <td data-bbox="1093 1473 1455 1547">2</td> </tr> <tr> <td data-bbox="359 1547 454 1653">4</td> <td data-bbox="454 1547 901 1653"> Plant Hand Book i) First Submission </td> <td data-bbox="901 1547 1093 1653">1</td> <td data-bbox="1093 1547 1455 1653">1</td> </tr> <tr> <td data-bbox="359 1653 454 1825">5</td> <td data-bbox="454 1653 901 1825"> Commissioning and Performance Test Procedure manual i) First Submission </td> <td data-bbox="901 1653 1093 1825">1 set</td> <td data-bbox="1093 1653 1455 1825">--</td> </tr> <tr> <td data-bbox="359 1825 454 1930"></td> <td data-bbox="454 1825 901 1930">ii) Final Submission (Directly to site)</td> <td data-bbox="901 1825 1093 1930">4 sets</td> <td data-bbox="1093 1825 1455 1930">2</td> </tr> </tbody> </table>	S.No	Description of Drgs/Docs	No of Prints	of No of CD ROMs/DVDs/Portable Hard Disk	1	Drawings, Data sheets, Design calculations, Purchase specifications and other documents First submission and submission with major changes <ul style="list-style-type: none"> ▪ Layout (A0&A1 sizes) ▪ Other Drawings/Documents (A0&A1 sizes) ▪ P&ID (All sizes) a) Final drawings/documents (Directly to site) b) "As Built" Drawing/Documents (Directly to site) c) Analysis reports of Equipments / piping /structures components/system employing software packages as detailed in the specifications.			2	Erection Manual (Directly to site)	4 sets	2	3	Operation & Maintenance manual i) First Submission	1 set	--		ii) Final Submission (Directly to site)	4 sets	2	4	Plant Hand Book i) First Submission	1	1	5	Commissioning and Performance Test Procedure manual i) First Submission	1 set	--		ii) Final Submission (Directly to site)	4 sets	2		
S.No	Description of Drgs/Docs	No of Prints	of No of CD ROMs/DVDs/Portable Hard Disk																																
1	Drawings, Data sheets, Design calculations, Purchase specifications and other documents First submission and submission with major changes <ul style="list-style-type: none"> ▪ Layout (A0&A1 sizes) ▪ Other Drawings/Documents (A0&A1 sizes) ▪ P&ID (All sizes) a) Final drawings/documents (Directly to site) b) "As Built" Drawing/Documents (Directly to site) c) Analysis reports of Equipments / piping /structures components/system employing software packages as detailed in the specifications.																																		
2	Erection Manual (Directly to site)	4 sets	2																																
3	Operation & Maintenance manual i) First Submission	1 set	--																																
	ii) Final Submission (Directly to site)	4 sets	2																																
4	Plant Hand Book i) First Submission	1	1																																
5	Commissioning and Performance Test Procedure manual i) First Submission	1 set	--																																
	ii) Final Submission (Directly to site)	4 sets	2																																
LOT-2 PROJECTS FLUE GAS DESULPHURISATION (FGD) SYSTEM PACKAGE	TECHNICAL SPECIFICATION SECTION – VI BID DOC. NO.:CS-0011-109(2)-9	PART-C GENERAL TECHNICAL REQUIREMENTS Annexure-VI	PAGE 81 OF 83																																

THIS IS PART OF TECHNICAL SPECIFICATION PE-TS-468-571-A901 REV 00.



CLAUSE NO.	GENERAL TECHNICAL REQUIREMENTS (Annexure-VI)			
S.No	Description of Drgs/Docs	No of Prints	No of CD ROMs/DVDs/Portable Hard Disk	
6	Performance and Functional Guarantee Test Report i) First Submission	2 sets	-	
	ii) Approved Copies (Direct to Site)	4 sets	2	
7	Project Completion Report (Directly to site)	6 sets	2	
8	QA programme including Organisation for implementation and QA system manual(with revisions)	1	-	
9	Vendor details in respect of proposed vendors including contractor's evaluation report.	2	-	
10	Manufacturing QPs, Field QPs, Field welding schedules and their reference document like test procedures, WPS, POR etc i) For review/comment	1	-	
	ii) Approved final copies of Field QPs, Field welding schedules and their reference document like test procedures, WPS, POR etc (Direct to Site)	4	2	
11	Welding Manual, Heat Treatment Manuals, Storage & preservation manuals i) For review/comment	1 set	-	
	ii) Approved copies (Direct to Site)	4 sets	2	
12	QA Documentation Package for items / equipment manufactured and despatched to site	2 sets	2	
13	QA Documentation Package for field activities on equipment/systems at site	2 sets	2	
LOT-2 PROJECTS FLUE GAS DESULPHURISATION (FGD) SYSTEM PACKAGE	TECHNICAL SPECIFICATION SECTION – VI BID DOC. NO.:CS-0011-109(2)-9	PART-C GENERAL TECHNICAL REQUIREMENTS Annexure-VI	PAGE 82 OF 83	

THIS IS PART OF TECHNICAL SPECIFICATION PE-TS-468-571-A901 REV 00.

	NSPCL BHILAI (2X250MW) GYPSUM DEWATERING EQUIPMENT TECHNICAL SPECIFICATION (ELECTRICAL PORTION)	SPECIFICATION No: PE-TS-468-571-A901	
		SECTION : I	
		SUB-SECTION : C-3	
		REV. 00	

SECTION: I

SUB-SECTION: C-3

TECHNICAL SPECIFICATION (ELECTRICAL PORTION)

THIS IS PART OF TECHNICAL SPECIFICATION PE-TS-468-571-A901 REV 00.

2X250 MW NTPC BHILAI FGD

TECHNICAL SPECIFICATION GYPSUM DEWATERING EQUIPMENT (ELECTRICAL PORTION)



BHARAT HEAVY ELECTRICALS LIMITED
POWER SECTOR
PROJECT ENGINEERING MANAGEMENT
NOIDA, UP [INDIA]



TITLE:
**ELECTRICAL EQUIPMENT SPECIFICATION
FOR
GYPSUM DEWATERING EQUIPMENT
2X250 MW BHILAI FGD**

SPECIFICATION NO. Page 184 of 539
VOLUME NO. : **II-B**
SECTION: **I**
REV NO. : **00** DATE: 14.05.2020
SHEET: 1 OF 1

CONTENTS

SECTION	TITLE	NO OF SHEETS
I	SPECIFIC TECHNICAL REQUIREMENTS	3
I	ELECTRICAL SCOPE BETWEEN BHEL & VENDOR (ANNEURE-I)	2
I	ELECTRICAL LOAD DATA FORMAT (ANNEXURE-II)	1
I	CABLE SCHEDULE FORMAT (ANNEXURE-III)	1
I	TECHNICAL SPECIFICATION FOR MOTORS	10
I	MOTOR DATASHEET-A	1
I	MOTOR DATASHEET-C	2
II	STANDARD SPECIFICATION FOR LV MOTORS	5
II	REFERENCE QUALITY PLAN	3
II	TECHNICAL SPECIFICATION FOR CABLE TRAYS & ACCESSORIES	7
II	TYPICAL DETAILS OF CABLE TRAYS AND ACCESSORIES	2

The requirements mentioned in Section-I shall prevail and govern in case of conflict between the same and the corresponding requirements mentioned in the descriptive portion in Section-II.



TITLE :
**ELECTRICAL EQUIPMENT SPECIFICATION
FOR
GYPSUM DEWATERING EQUIPMENT**

2X250 MW BHILAI FGD

SPECIFICATION NO. Page 185 of 539
VOLUME NO. : **II-B**
SECTION : **I**
REV NO. : **00** DATE : **14.05.2020**
SHEET : 1 OF 3

TECHNICAL SPECIFICATION

FOR

GYPSUM DEWATERING EQUIPMENT

(ELECTRICAL PORTION)



TITLE :
**ELECTRICAL EQUIPMENT SPECIFICATION
FOR
GYPSUM DEWATERING EQUIPMENT**

2X250 MW BHILAI FGD

SPECIFICATION NO. Page 186 of 539
VOLUME NO. : **II-B**
SECTION : **I**
REV NO. : **00** DATE : **14.05.2020**
SHEET : 2 OF 3

1.0 EQUIPMENT & SERVICES TO BE PROVIDED BY BIDDER:

- a) Services and equipment as per “Electrical Scope between BHEL and Vendor”.
- b) Any item/work either supply of equipment or erection material which have not been specifically mentioned but are necessary to complete the work for trouble free and efficient operation of the plant shall be deemed to be included within the scope of this specification. The same shall be provided by the bidder without any extra charge.
- c) Supply of mandatory spares as specified in the specifications of mechanical equipments.
- d) Electrical load requirement for GYPSUM DEWATERING EQUIPMENT (all AC & DC loads at different voltage levels like 415V AC, 240 V AC, 220 V DC etc).
- e) All equipment shall be suitable for the power supply fault levels and other climatic conditions mentioned in the enclosed project information.
- f) Bidder to furnish list of makes for each equipment at contract stage, which shall be subject to customer/BHEL approval without any commercial and delivery implications to BHEL
- g) Various drawings, data sheets as per required format, Quality plans, calculations, test reports, test certificates, operation and maintenance manuals etc shall be furnished as specified at contract stage. All documents shall be subject to customer/BHEL approval without any commercial implication to BHEL.
- h) Motor shall meet minimum requirement of motor specification.
- i) Vendor to clearly indicate equipment locations and local routing lengths in their cable listing furnished to BHEL.
- j) Cable BOQ worked out based on routing of cable listing provided by the vendor for “ both end equipment in vendor’s scope”shall be binding to the vendor with +10 % margin to take care of slight variation in routing length & wastages.

2.0 EQUIPMENT & SERVICES TO BE PROVIDED BY PURCHASER FOR ELECTRICAL & TERMINAL POINTS:

Refer “Electrical Scope between BHEL and Vendor”.

3.0 DOCUMENTS TO BE SUBMITTED ALONG WITH BID

3.1 The electrical specification without any deviation from the technical/quality assurance requirements stipulated shall be deemed to be complied by the bidder in case bidder furnishes the overall compliance of package technical specification in the form of compliance certificate/No deviation certificate.

3.2 No technical submittal such as copies of data sheets, drawings, write-up, quality plans, type test certificates, technical literature, etc, is required during tender stage. Any such submission even if made, shall not be considered as part of offer.



TITLE :
**ELECTRICAL EQUIPMENT SPECIFICATION
FOR
GYPSUM DEWATERING EQUIPMENT**

2X250 MW BHILAI FGD

SPECIFICATION NO. Page 187 of 539
VOLUME NO. : **II-B**
SECTION : **I**
REV NO. : **00** DATE : **14.05.2020**
SHEET : 3 OF 3

4.0 List of enclosures :

- a) Electrical scope between BHEL & vendor (Annexure –I)
- b) Technical specification for motors.
- c) Datasheets & quality plan for motors.
- d) Electrical Load data format (Annexure –II)
- e) BHEL cable listing format (Annexure –III)

REV-0, DATE: 14.05.2020

ELECTRICAL SCOPE BETWEEN BHEL AND VENDOR**PACKAGES: GYPSUM DEWATERING EQUIPMENT****SCOPE OF VENDOR: SUPPLY & SUPERVISION OF VENDOR'S EQUIPMENT****PROJECT: 2X250 MW BHILAI FGD**

S.NO	DETAILS	SCOPE SUPPLY	SCOPE E&C	REMARKS
1	11 kV / 3.3 KV / 415 V Switchgear	BHEL	BHEL	HT motor (If applicable), (Motor feeder) power supply shall be provided by BHEL For all LT motor & Auxiliary supply, 415 V AC (3 ph. 4 wire)/240 V AC (supply feeder) shall be provided by BHEL based on load data provided by vendor at contract stage for all equipment supplied by vendor as part of contract. Any other voltage level (AC/DC) required will be derived by the vendor.
2	Local Push Button Station (for motors)	BHEL	BHEL	Located near the motor.
3	Power cables, control cables and screened control cables for a) both end equipment in BHEL's scope b) both end equipment in vendor's scope c) one end equipment in vendor's scope	BHEL BHEL BHEL	BHEL BHEL BHEL	1. For 3.b) & c): Sizes of cables required shall be informed by vendor at contract stage (based on inputs provided by BHEL) in the form of cable listing. Finalisation of cable sizes shall be done by BHEL. Vendor shall provide lugs & glands accordingly. 2. Termination at BHEL equipment terminals by BHEL. 3. Termination at Vendor equipment terminals by Vendor.
4	Junction box for control & instrumentation cable	Vendor	BHEL	Number of Junction Boxes shall be sufficient and positioned in the field to minimize local cabling (max 10-12 mtrs) and trunk cable.
5	Any special type of cable like compensating, co-axial, prefab, MICC etc.	Vendor	BHEL	
6	Cable trays, accessories & cable trays supporting system 100/ 50 mm cable trays/ Conduits/ Galvanised steel cable troughs for local cabling	BHEL Vendor	BHEL BHEL	Local cabling from nearby main route cable tray (BHEL scope) to equipment terminal (vendor's scope) shall be through 100/ 50 mm. cable trays/ conduits/ Galvanised steel cable troughs, as per approved layout drawing during contract stage.
7	a. Cable glands b. Lugs and bimetallic strip for equipment supplied by Vendor	Vendor Vendor	BHEL BHEL	a. Double compression Ni-Cr plated brass cable glands b. Solder less crimping type heavy duty tinned copper lugs for power and control cables.
8	Conduit and conduit accessories for cabling between	Vendor	BHEL	Conduits shall be medium duty, hot dip galvanised cold rolled mild steel

THIS IS PART OF TECHNICAL SPECIFICATION PE-TS-468-571-A901 REV 00.

REV-0, DATE: 14.05.2020

ELECTRICAL SCOPE BETWEEN BHEL AND VENDOR**PACKAGES: GYPSUM DEWATERING EQUIPMENT****SCOPE OF VENDOR: SUPPLY & SUPERVISION OF VENDOR'S EQUIPMENT****PROJECT: 2X250 MW BHILAI FGD**

	equipment supplied by vendor			rigid conduit as per IS: 9537.
9	Lighting	BHEL	BHEL	
10	Equipment grounding (including electronic earthing) & lightning protection	BHEL	BHEL	
11	Below grade grounding	BHEL	BHEL	
12	LT Motors with base plate and foundation hardware.	Vendor	BHEL	Makes shall be subject to customer/ BHEL approval at contract stage.
13	HT Motor with base plate and foundation hardware.	Vendor	BHEL	Makes shall be subject to customer/ BHEL approval at contract stage.
14	HT cable & Cable termination kit for HT Motor	BHEL	BHEL	
15	Mandatory spares	Vendor	-	Vendor to quote as per specification.
16	Recommended O & M spares	Vendor	-	As specified elsewhere in specification
17	Any other equipment/ material/ service required for completeness of system based on system offered by the vendor (to ensure trouble free and efficient operation of the system).	Vendor	BHEL	
18	a) Input cable schedules (Control & Screened Control Cables) b) Cable interconnection details for above c) Cable block diagram	Vendor Vendor Vendor	- - -	Cable listing for Control and Instrumentation Cable and electronic earthing cable in enclosed excel format shall be submitted by vendor during detailed engineering stage.
19	Electrical Equipment & cable tray layout drawings	-	-	Vendor to furnish drawing (both in print form as well as in AUTOCAD) of Gypsum Dewatering Building layout clearly indicating all motors, panels, JB's etc. which require cabling along with their terminal box/location/ Foundation etc.
20	Electrical Equipment GA drawing	Vendor	-	For necessary interface review.

NOTES:

1. Make of all electrical equipment/ items supplied shall be reputed make & shall be subject to approval of BHEL/customer after award of contract.
2. All QPs shall be subject to approval of BHEL/customer after award of contract without any commercial implication.
3. In case the requirement of Junction Box arises on account of Power Cable size mis-match due to vendor engineering at later stage, vendor shall supply the Junction Box for suitable termination.

LOAD TITLE	RATING (KW / A)		UNIT (U)/STN (S)	Nos.		VOLTAGE CODE*	FEEDER CODE**	EMER. LOAD (Y)	CONT.(C)/INTT.(I)	STARTING TIME >5 SEC (Y)	LOCATION	BOARD NO.	CABLE		BLOCK CABLE DRG. No.	CONT ROL CODE	REMA RKS	LOAD No.	VERIFICATI ON FROM MOTOR DATASHEE T (Y/N)	KKS NO
	NAME PLATE	MAX. CONT. DEMAND (MCR)		RUNNING	STANDBY								SIZE CODE	NOs						
1	2	3	4	5	6	7	8	9	10	11	12	13	14	15	16	17	18	19	20	21

ANNEXURE-II

THIS IS PART OF TECHNICAL SPECIFICATION PE-TS-468-b71-A901 (REV.00)

NOTES: 1. COLUMN 1 TO 12 & 18 SHALL BE FILLED BY THE REQUISITIONER (ORIGINATING AGENCY); REMAINING COLUMNS ARE TO BE FILLED UP BY PEM (ELECTRICAL)/ CUSTOMER
 2. ABBREVIATIONS : * VOLTAGE CODE (7):- (ac) A=11 KV, B=6.6 KV, C=3.3 KV, D=415 V, E=240 V (1 PH), F=110 V (cc): G=220 V, H=110 V, J=48 V, K=+24V, L=-24 V
 **: FEEDER CODE (8):- U=UNIDIRECTIONAL STARTER, B=BI-DIRECTIONAL STARTER, S=SUPPLY FEEDER, D=SUPPLY FEEDER (CONTACTER CONTROLLED)

LOAD DATA (ELECTRICAL)	JOB NO.		ORIGINATING AGENCY	PEM (ELECTRICAL)	
	PROJECT TITLE	2X250 MW BHILAI FGD	NAME	DATA FILLED UP ON	
	SYSTEM	GYPSUM DEWATERING EQUIPMENT	SIGN.	DATA ENTERED ON	
	DEPTT. / SECTION	MAX	SHEET 1 OF 1	REV. 00	DE'S SIGN. & DATE



SUB-SECTION-II-E2

MOTORS

THIS IS PART OF TECHNICAL SPECIFICATION PE-TS-468-571-A901 REV 00.

**LOT-2 PROJECTS
FLUE GAS DESULPHURISATION (FGD) SYSTEM PACKAGE**

**TECHNICAL SPECIFICATION
SECTION-VI
BID DOCUMENT NO.: CS-0011-109(2)-9**

CLAUSE NO.	TECHNICAL REQUIREMENTS		
			
	MOTORS		
1.00.00	GENERAL REQUIREMENTS		
1.01.00	For the purpose of design of equipment/systems, an ambient temperature of 50 deg. Centigrade and relative humidity of 95% (at 40 deg C) shall be considered. The equipment shall operate in a highly polluted environment.		
1.02.00	All equipment's shall be suitable for rated frequency of 50 Hz with a variation of +3% & -5%, and 10% combined variation of voltage and frequency unless specifically brought out in the specification.		
1.03.00	Contactor shall provide fully compatible electrical system, equipment's, accessories and services.		
1.04.00	All the equipment, material and systems shall, in general, conform to the latest edition of relevant National and international Codes & Standards, especially the Indian Statutory Regulations.		
1.05.00	Paint shade shall be as per RAL 5012 (Blue) for indoor and outdoor equipment.		
1.06.00	The responsibility of coordination with electrical agencies and obtaining all necessary clearances for Contactors equipment and systems shall be under the Contactor scope.		
1.07.00	Degree of Protection Degree of protection for various enclosures as per IEC60034-05 shall be as follows :-		
	i)	Indoor motors	- IP 54
	ii)	Outdoor motors	- IP 55
	iii)	Cable box-indoor area	- IP 54
	iv)	Cable box-Outdoor area	- IP 55
2.00.00	CODES AND STANDARDS		
	1)	Three phase induction motors	: IS/IEC:60034
	2)	Single phase AC motors	: IS/ IEC:60034
	3)	Crane duty motors	: IS:3177, IS/IEC:60034
	4)	DC motors/generators	: IS:4722, IS/IEC:60034
	5)	Energy Efficient motors	: IS 12615, IEC:60034-30
LOT-2 PROJECTS FLUE GAS DESULPHURISATION (FGD) SYSTEM PACKAGE	TECHNICAL SPECIFICATION SECTION – VI, PART-B BID DOC NO : CS-0011-109(2)-9	SUB SECTION-II-E2 MOTORS	PAGE 1 OF 9

CLAUSE NO.	TECHNICAL REQUIREMENTS		
			
3.00.00	TYPE		
3.01.00	AC Motors: <ul style="list-style-type: none"> a) Squirrel cage induction motor suitable for direct-on-line starting. b) Continuous duty LT motors upto 200 KW Output rating (at 50 deg.C ambient temperature), shall be Premium Efficiency class-IE3, conforming to IS 12615, or IEC:60034-30. HT motors shall have minimum design efficiency of 95 %. However, tolerance on this efficiency value shall be applicable as per IEC 60034 c) Crane duty motors shall be slip ring/ squirrel cage Induction motor as per the requirement. d) Motor operating through variable frequency drives shall be suitable for inverter duty with VPI insulation. Also these motors shall comply the requirements stipulated in IEC: 60034-18-41 and IEC: 60034-18-42 as applicable. e) Motors operating through variable frequency drives shall also meet the requirements mentioned in subsection for VFD. 		
3.02.00	DC Motors	Shunt wound.	
4.00.00	RATING		
	(a) Continuously rated (S1). However, crane motors shall be rated for S4 duty, 40% cyclic duration factor.		
	(b) Whenever the basis for motor or driven equipment ratings are not specified in the corresponding mechanical specification sub-sections, maximum continuous motor ratings shall be at least 10% above the maximum load demand of the driven equipment under entire operating range including voltage and frequency variations.		
5.00.00	TEMPERATURE RISE		
	Air cooled motors		
	70 deg. C by resistance method for both thermal class 130(B) & 155(F) insulation.		
	Water cooled		
	80 deg. C over inlet cooling water temperature mentioned elsewhere, by resistance method for both thermal class 130(B) & 155(F) insulation.		
6.00.00	OPERATIONAL REQUIREMENTS		
6.01.00	Starting Time		
LOT-2 PROJECTS FLUE GAS DESULPHURISATION (FGD) SYSTEM PACKAGE	TECHNICAL SPECIFICATION SECTION – VI, PART-B BID DOC NO : CS-0011-109(2)-9	SUB SECTION-II-E2 MOTORS	PAGE 2 OF 9

CLAUSE NO.	TECHNICAL REQUIREMENTS 		
6.01.01	For motors with starting time upto 20 secs. at minimum permissible voltage during starting, the locked rotor withstand time under hot condition at highest voltage limit shall be at least 2.5 secs. more than starting time.		
6.01.02	For motors with starting time more than 20 secs. and upto 45 secs. at minimum permissible voltage during starting, the locked rotor withstand time under hot condition at highest voltage limit shall be at least 5 secs. more than starting time.		
6.01.03	For motors with starting time more than 45 secs. at minimum permissible voltage during starting, the locked rotor withstand time under hot condition at highest voltage limit shall be more than starting time by at least 10% of the starting time.		
6.01.04	Speed switches mounted on the motor shaft shall be provided in cases where above requirements are not met.		
6.02.00	Torque Requirements		
6.02.01	Accelerating torque at any speed with the lowest permissible starting voltage shall be at least 10% motor rated torque.		
6.02.02	Pull out torque at rated voltage shall not be less than 205% of rated torque. It shall be 275% for crane duty motors.		
6.03.00	Starting voltage requirement <ul style="list-style-type: none"> (a) Up to 85% of rated voltage for ratings below 110 KW (b) Up to 80% of rated voltage for ratings from 110 KW to 200 KW (c) Up to 85% of rated voltage for ratings from 201 KW to 1000 KW (d) Up to 80% of rated voltage for ratings from 1001 KW to 4000 KW (e) Up to 75 % of rated voltage for ratings above 4000KW 		
7.00.00	DESIGN AND CONSTRUCTIONAL FEATURES		
7.01.00	Suitable single phase space heaters shall be provided on motors rated 30KW and above to maintain windings in dry condition when motor is standstill. Separate terminal box for space heaters & RTDs shall be provided. However for flame proof motors, space heater terminals inside the main terminal box may be acceptable.		
7.02.00	All motors shall be either Totally enclosed fan cooled (TEFC) or totally enclosed tube ventilated (TETV) or Closed air circuit air cooled (CACA) type. However, motors rated 3000KW or above can be Closed air circuit water cooled (CACW). The method of movement of primary and secondary coolant shall be self-circulated by fan or pump directly mounted on the rotor of the main motor as per IEC 60034-6. However VFD driven motors can be offered with forced cooling type with machine mounted fan or pump driven by separate electric motor. Motors and EPB located in hazardous areas shall have flame proof enclosures conforming to IS:2148 as detailed below		
LOT-2 PROJECTS FLUE GAS DESULPHURISATION (FGD) SYSTEM PACKAGE	TECHNICAL SPECIFICATION SECTION – VI, PART-B BID DOC NO : CS-0011-109(2)-9	SUB SECTION-II-E2 MOTORS	PAGE 3 OF 9

CLAUSE NO.	<p style="text-align: center;">TECHNICAL REQUIREMENTS</p> 		
7.03.00	<p>(a) Fuel oil area : Group – IIB</p> <p>(b) Hydrogen generation : Group - IIC or (Group-I, Div-II as per plant area NEC) or (Class-1, Group-B, Div-II as per NEMA /IEC60034)</p> <p>Winding and Insulation</p> <p>(a) Type : Non-hygroscopic, oil resistant, flame resistant</p> <p>(b) Starting duty : Two hot starts in succession, with motor initially at normal running temperature.</p> <p>(c) 11kV, 6.6kV & 3.3 kV AC motors : Thermal class 155 (F) insulation. The winding insulation process shall be total Vacuum Pressure Impregnated i.e resin poor method. The lightning Impulse & interturn insulation surge withstand level shall be as per IEC-60034 part-15.</p> <p>(d) 240VAC, 415V AC & 220V DC motors : Thermal Class (B) or better</p>		
7.04.00	Motors rated above 1000KW shall have insulated bearings/housing to prevent flow of shaft currents.		
7.05.00	Motors with heat exchangers shall have dial type thermometer with adjustable alarm contacts to indicate inlet and outlet primary air temperature.		
7.06.00	Noise level for all the motors shall be limited to 85 dB(A) except for BFP motor for which the maximum limit shall be 90dB(A). Vibration shall be limited within the limits prescribed in IS:12075 / IEC 60034-14 . Motors shall withstand vibrations produced by driven equipment. HT motor bearing housings shall have flat surfaces, in both X and Y directions, suitable for mounting 80mmX80mm vibration pads.		
7.07.00	In HT motors, at least four numbers simplex / two numbers duplex platinum resistance type temperature detectors shall be provided in each phase stator winding. Each bearing of HT motor shall be provided with dial type thermometer and minimum 2 numbers duplex platinum resistance type temperature detectors.		
7.08.00	Motor body shall have two earthing points on opposite sides.		
7.09.00	11 KV motors shall be offered with Separable Insulated Connector (SIC) as per IEEE 386. The offered SIC terminations shall be provided with protective cover and trifurcating sleeves. SIC termination kit shall be suitable for fault level of 25 KA for 0.17 seconds.		
7.10.00	3.3/6.6 KV motors shall be offered with dust tight phase separated double walled (metallic as well as insulated barrier) Terminal box. Contractor shall provide termination kit for the offered Terminal box. The offered Terminal Box shall be		
<p style="text-align: center;">LOT-2 PROJECTS FLUE GAS DESULPHURISATION (FGD) SYSTEM PACKAGE</p>	<p style="text-align: center;">TECHNICAL SPECIFICATION SECTION – VI, PART-B BID DOC NO : CS-0011-109(2)-9</p>	<p style="text-align: center;">SUB SECTION-II-E2 MOTORS</p>	<p style="text-align: center;">PAGE 4 OF 9</p>

CLAUSE NO.	<p style="text-align: center;">TECHNICAL REQUIREMENTS</p> 		
	<p>suitable for fault level of 250 MVA for 0.12 sec. Removable gland plates of thickness 3 mm (hot/cold rolled sheet steel) or 4 mm (non magnetic material for single core cables) shall be provided.</p>		
7.11.00	<p>The spacing between gland plate & centre of bottom terminal stud shall be as per Table-I.</p>		
7.12.00	<p>All motors shall be so designed that maximum inrush currents and locked rotor and pullout torque developed by them at extreme voltage and frequency variations do not endanger the motor and driven equipment.</p>		
7.13.00	<p>The motors shall be suitable for bus transfer schemes provided on the 11kV, 6.6kV, 3.3 kV /415V systems without any injurious effect on its life.</p>		
7.14.00	<p>For motors rated 2000 KW & above, neutral current transformers of PS class shall be provided on each phase in a separate neutral terminal box.</p>		
7.15.00	<p>The size and number of cables (for HT motors) to be intimated to the successful Contactor during detailed engineering and the Contactor shall provide terminal box suitable for the same.</p>		
8.00.00	<p>The ratio of locked rotor KVA at rated voltage to rated KW shall not exceed the following (without any further tolerance):</p> <p>(a) From 50KW & upto 110KW : 11.0</p> <p>(b) From 110 KW & upto 200 KW : 9.0</p> <p>(c) Above 200 KW & upto 1000KW : 10.0</p> <p>(d) From 1001KW & upto 4000KW : 9.0</p> <p>(e) Above 4000KW : 6 to 6.5</p>		
10.00.00	TYPE TEST		
10.01.00	HT MOTORS		
10.01.01	<p>The Contactor shall carry out the type tests as listed in this specification on the equipment to be supplied under this contract. The Contactor shall indicate the charges for each of these type tests separately in the relevant schedule of Section - VII- (BPS) and the same shall be considered for the evaluation of the bids. The type tests charges shall be paid only for the test(s) actually conducted successfully under this contract and upon certification by the Employer's engineer.</p>		
10.01.02	<p>The type tests shall be carried out in presence of the Employer's representative, for which minimum 15 days notice shall be given by the Contactor. The Contactor shall obtain the Employer's approval for the type test procedure before conducting the type test. The type test procedure shall clearly specify the test set-up,</p>		
<p style="text-align: center;">LOT-2 PROJECTS FLUE GAS DESULPHURISATION (FGD) SYSTEM PACKAGE</p>	<p style="text-align: center;">TECHNICAL SPECIFICATION SECTION – VI, PART-B BID DOC NO : CS-0011-109(2)-9</p>	<p style="text-align: center;">SUB SECTION-II-E2 MOTORS</p>	<p style="text-align: center;">PAGE 5 OF 9</p>

CLAUSE NO.	TECHNICAL REQUIREMENTS 		
10.01.03	<p>instruments to be used, procedure, acceptance norms, recording of different parameters, interval of recording, precautions to be taken etc. for the type test(s) to be carried out.</p>		
10.01.04	<p>In case the Contactor has conducted such specified type test(s) within last ten years as on the date of bid opening, he may submit during detailed engineering the type test reports to the Employer for waiver of conductance of such test(s). These reports should be for the tests conducted on the equipment similar to those proposed to be supplied under this contract and test(s) should have been either conducted at an independent laboratory or should have been witnessed by a client. The Employer reserves the right to waive conducting of any or all the specified type test(s) under this contract. In case type tests are waived, the type test charges shall not be payable to the Contactor.</p>		
10.01.05	<p>Further the Contactor shall only submit the reports of the type tests as listed in "LIST OF TESTS FOR WHICH REPORTS HAVE TO BE SUBMITTED" and carried out within last ten years from the date of bid opening. These reports should be for the test conducted on the equipment similar to those proposed to be supplied under this contract and the test(s) should have been either conducted at an independent laboratory or should have been witnessed by a client. However if the Contactor is not able to submit report of the type test(s) conducted within last ten years from the date of bid opening, or in the case of type test report(s) are not found to be meeting the specification requirements, the Contactor shall conduct all such tests under this contract at no additional cost to the Employer either at third party lab or in presence of client/Employers representative and submit the reports for approval.</p>		
10.01.05	<p>LIST OF TYPE TESTS TO BE CONDUCTED</p> <p>The following type tests shall be conducted on each type and rating of HT motor</p> <p>(a) No load saturation and loss curves upto approximately 115% of rated voltage</p> <p>(b) Measurement of noise at no load.</p> <p>(c) Momentary excess torque test (subject to test bed constraint).</p> <p>(d) Full load test(subject to test bed constraint)</p> <p>(e) Temperature rise test at rated conditions. During heat run test, bearing temp., winding temp.,coolant flow and its temp. shall also be measured. In case the temperature rise test is carried at load other than rated load, specific approval for the test method and procedure is required to be obtained. Wherever ETD's are provided, the temperature shall be measured by ETD's also for the record purpose.</p>		
<p align="center">LOT-2 PROJECTS FLUE GAS DESULPHURISATION (FGD) SYSTEM PACKAGE</p>	<p align="center">TECHNICAL SPECIFICATION SECTION – VI, PART-B BID DOC NO : CS-0011-109(2)-9</p>	<p align="center">SUB SECTION-II-E2 MOTORS</p>	<p align="center">PAGE 6 OF 9</p>

CLAUSE NO.	TECHNICAL REQUIREMENTS 		
10.01.06	<p>LIST OF TESTS FOR WHICH REPORTS HAVE TO BE SUBMITTED</p> <p>The following type test reports shall be submitted for each type and rating of HT motor</p> <ul style="list-style-type: none"> (a) Degree of protection test for the enclosure followed by IR, HV and no load run test. (b) Terminal box-fault level withstand test for each type of terminal box of HT motors only. (c) Lightning Impulse withstand test on the sample coil shall be as per clause no. 4.3 IEC-60034, part-15 (d) Surge-withstand test on inter-turn insulation shall be as per clause no. 4.2 of IEC 60034, part-15 		
10.02.00	<p>LT Motors</p>		
10.02.01	<p>LT Motors supplied shall be of type tested design. During detailed engineering, the Contactor shall submit for Employer's approval the reports of all the type tests as listed in this specification and carried out within last <i>ten</i> years from the date of bid opening. These reports should be for the test conducted on the equipment similar to those proposed to be supplied under this contract and the test(s) should have been either conducted at an independent laboratory or should have been witnessed by a client.</p>		
10.02.02	<p>However if the Contactor is not able to submit report of the type test(s) conducted within last ten years from the date of bid opening, or in the case of type test report(s) are not found to be meeting the specification requirements, the Contactor shall conduct all such tests under this contract at no additional cost to the Employer either at third party lab or in presence of client/Employers representative and submit the reports for approval.</p>		
10.02.03	<p>LIST OF TESTS FOR WHICH REPORTS HAVE TO BE SUBMITTED</p> <p>The following type test reports shall be submitted for each type and rating of LT motor of above 100 KW only</p> <ul style="list-style-type: none"> 1. Measurement of resistance of windings of stator and wound rotor. 2. No load test at rated voltage to determine input current power and speed 3. Open circuit voltage ratio of wound rotor motors (in case of Slip ring motors) 4. Full load test to determine efficiency power factor and slip 5. Temperature rise test 		
<p>LOT-2 PROJECTS FLUE GAS DESULPHURISATION (FGD) SYSTEM PACKAGE</p>	<p>TECHNICAL SPECIFICATION SECTION – VI, PART-B BID DOC NO : CS-0011-109(2)-9</p>	<p>SUB SECTION-II-E2 MOTORS</p>	<p>PAGE 7 OF 9</p>

CLAUSE NO.	TECHNICAL REQUIREMENTS 				
<p>10.03.00</p> <p>10.04.00</p>	<p>6. Momentary excess torque test.</p> <p>7. High voltage test</p> <p>8. Test for vibration severity of motor.</p> <p>9. Test for noise levels of motor(Shall be limited as per clause no 7.06.00 of this section)</p> <p>10. Test for degree of protection and</p> <p>11. Overspeed test.</p> <p>12. Type test reports for motors located in fuel oil area having flame proof enclosures as per IS 2148 / IEC 60079-1</p> <p>All acceptance and routine tests as per the specification and relevant standards shall be carried out. Charges for these shall be deemed to be included in the equipment price.</p> <p>The type test reports once approved for any projects shall be treated as reference. For subsequent projects of NTPC, an endorsement sheet will be furnished by the manufacturer confirming similarity and "No design Change". Minor changes if any shall be highlighted on the endorsement sheet.</p>	<p>LOT-2 PROJECTS FLUE GAS DESULPHURISATION (FGD) SYSTEM PACKAGE</p>	<p>TECHNICAL SPECIFICATION SECTION – VI, PART-B BID DOC NO : CS-0011-109(2)-9</p>	<p>SUB SECTION-II-E2 MOTORS</p>	<p>PAGE 8 OF 9</p>

CLAUSE NO.	TECHNICAL REQUIREMENTS																														
	<div style="text-align: right; border: 1px solid black; padding: 2px; width: fit-content; margin: 0 auto;">एनटीपीसी NTPC</div> <p style="text-align: center;">TABLE - I</p> <p style="text-align: center;">DIMENSIONS OF TERMINAL BOXES FOR LV MOTORS</p> <table border="0" style="width: 100%; border-collapse: collapse;"> <thead> <tr> <th style="text-align: left; width: 60%;">Motor MCR in KW</th> <th style="text-align: left;">Minimum distance between centre of bottom terminal stud and gland plate in mm</th> </tr> </thead> <tbody> <tr> <td>UP to 3 KW</td> <td>As per manufacturer's practice.</td> </tr> <tr> <td>Above 3 KW - upto 7 KW</td> <td style="text-align: right;">85</td> </tr> <tr> <td>Above 7 KW - upto 13 KW</td> <td style="text-align: right;">115</td> </tr> <tr> <td>Above 13 KW - upto 24 KW</td> <td style="text-align: right;">167</td> </tr> <tr> <td>Above 24 KW - upto 37 KW</td> <td style="text-align: right;">196</td> </tr> <tr> <td>Above 37 KW - upto 55 KW</td> <td style="text-align: right;">249</td> </tr> <tr> <td>Above 55 KW - upto 90 KW</td> <td style="text-align: right;">277</td> </tr> <tr> <td>Above 90 KW - upto 125 KW</td> <td style="text-align: right;">331</td> </tr> <tr> <td>Above 125 KW-upto 200 KW</td> <td style="text-align: right;">385/203 (For Single core cables only)</td> </tr> </tbody> </table> <p>For HT motors the distance between gland plate and the terminal studs shall not be less than 500 mm.</p> <p>PHASE TO PHASE/ PHASE TO EARTH AIR CLEARANCE:</p> <p>NOTE: Minimum inter-phase and phase-earth air clearances for LT motors with lugs installed shall be as follows:</p> <table border="0" style="width: 100%; border-collapse: collapse;"> <thead> <tr> <th style="text-align: left; width: 60%;">Motor MCR in KW</th> <th style="text-align: left;">Clearance</th> </tr> </thead> <tbody> <tr> <td>UP to 110 KW</td> <td style="text-align: right;">10mm</td> </tr> <tr> <td>Above 110 KW and upto 150 KW</td> <td style="text-align: right;">12.5mm</td> </tr> <tr> <td>Above 150 KW</td> <td style="text-align: right;">19mm</td> </tr> </tbody> </table>			Motor MCR in KW	Minimum distance between centre of bottom terminal stud and gland plate in mm	UP to 3 KW	As per manufacturer's practice.	Above 3 KW - upto 7 KW	85	Above 7 KW - upto 13 KW	115	Above 13 KW - upto 24 KW	167	Above 24 KW - upto 37 KW	196	Above 37 KW - upto 55 KW	249	Above 55 KW - upto 90 KW	277	Above 90 KW - upto 125 KW	331	Above 125 KW-upto 200 KW	385/203 (For Single core cables only)	Motor MCR in KW	Clearance	UP to 110 KW	10mm	Above 110 KW and upto 150 KW	12.5mm	Above 150 KW	19mm
Motor MCR in KW	Minimum distance between centre of bottom terminal stud and gland plate in mm																														
UP to 3 KW	As per manufacturer's practice.																														
Above 3 KW - upto 7 KW	85																														
Above 7 KW - upto 13 KW	115																														
Above 13 KW - upto 24 KW	167																														
Above 24 KW - upto 37 KW	196																														
Above 37 KW - upto 55 KW	249																														
Above 55 KW - upto 90 KW	277																														
Above 90 KW - upto 125 KW	331																														
Above 125 KW-upto 200 KW	385/203 (For Single core cables only)																														
Motor MCR in KW	Clearance																														
UP to 110 KW	10mm																														
Above 110 KW and upto 150 KW	12.5mm																														
Above 150 KW	19mm																														
LOT-2 PROJECTS FLUE GAS DESULPHURISATION (FGD) SYSTEM PACKAGE	TECHNICAL SPECIFICATION SECTION – VI, PART-B BID DOC NO : CS-0011-109(2)-9	SUB SECTION-II-E2 MOTORS	PAGE 9 OF 9																												



TITLE

LV MOTORS**DATA SHEET-A**

2X250 MW BHILAI FGD

SPECIFICATION NO. Page 202 of 539

VOLUME

II B

SECTION

D

REV. NO.

DATE:14.05.2020

SHEET 1

OF 2

ANNEXURE-III

- 1.0 Design ambient temperature : 50 °C
- 2.0 Maximum acceptable kW rating of LV motor : 200KW *
- 3.0 Installation (Indoors/ Outdoors) : As required
- 4.0 Details of supply system
- a) Rated voltage (with variation) : 415V ± 10%
 - b) Rated frequency (with variation) : 50 Hz + 3 % to - 5%
 - c) Combined voltage & freq. variation : 10% (sum of absolute values)
 - d) System fault level at rated voltage : 50 kA for 1 sec
 - e) Short time rating for terminal boxes
 - o 110 kW and above (Breaker Controlled) : 50 KA for 0.25 sec.
 - o Below 110 kW (Contactor Controlled) : 50 KA protected by HRC fuse
 - f) LV System grounding : Solidly
- 5.0 Winding & Insulation : Class F with temp rise limited to class B
- 6.0 Minimum voltage for starting (As percentage of rated voltage) : 85% for motor ratings below 110kW
80% for motor ratings from 110kW to 200kW.
- 7.0 Power cables data : Shall be given during detailed engg.
- 8.0 Earth Conductor Size & Material : Shall be given during detailed engg.
- 9.0 Space heater supply (for motors >=30kw) : 240 V, 1φ, 50 Hz
- 10.0 Rating up to which Single phase motor : Acceptable below 0.2 kW
- 11.0 Locked rotor current
- a) Limit as percentage of FLC : As per IS 12615
- 12.0 Makes : BHEL/ Customer approval (Package owner to take care)
- 13.0 Paint shade : Blue (RAL 5012) – Corrosion proof
- 14.0 Degree Of protection for motor/ terminal box : Degree of protection for various enclosures as per IEC60034-05 shall be as follows:-
- i) Indoor motors - IP 54
 - ii) Outdoor motors - IP 55
 - iii) Cable box-indoor area - IP 54
 - iv) Cable Box-Outdoor area - IP 55

* **LT motors of continuous duty shall be energy efficient IE3 class conforming to IS-12615**

15.0 TESTING REQUIREMENTS: IN LINE WITH SPECIFICATION

THIS IS PART OF TECHNICAL SPECIFICATION PE-TS-468-571-A901 REV 00.

	TITLE	<p align="center">MOTORS</p> <p align="center">DATA SHEET – C</p> <p align="center">2X250 MW BHILAI FGD</p>	SPECIFICATION NO. Page 203 of 539
			VOLUME II B
			SECTION D
			REV NO. 00 DATE 14.05.2020
			SHEET 1 OF 2

S. No.	Description	Data to be filled by successful bidder
A.	General	
1	Manufacturer & country of origin	
2	Motor type	
3	Type of starting	
4	Name of the equipment driven by motor & Quantity	
5	Maximum Power requirement of driven equipment	
6	Rated speed of Driven Equipment	
7	Design ambient temperature	
B.	Design and Performance Data	
1	Frame size & type designation	
2	Type of duty	
3	Rated Voltage	
4	Permissible variation for	
5	a) Voltage	
6	b) Frequency	
7	c) Combined voltage & frequency	
8	Rated output at design ambient temp (by resistance method)	
9	Synchronous speed & Rated slip	
10	Minimum permissible starting voltage	
11	Starting time in sec with mechanism coupled	
12	a) At rated voltage	
13	b) At min starting voltage	
14	Locked rotor current as percentage of FLC (including IS tolerance)	
15	Torque	
	a) Starting	
	b) Maximum	
16	Permissible temp rise at rated output over ambient temp & method	
17	Noise level at 1.0 m (dB)	
18	Amplitude of vibration	
19	Efficiency & P.F. at rated voltage & frequency	
	a) At 100% load	
	c) At 75% load	

THIS IS PART OF TECHNICAL SPECIFICATION PE-TS-468-571-A901 REV-00.

NAME OF VENDOR			SEAL	REV.	
NAME	SIGNATURE	DATE			

	TITLE	SPECIFICATION NO. Page 204 of 539	
	MOTORS		VOLUME II B
	DATA SHEET – C		SECTION D
	2X250 MW BHILAI FGD		REV NO. 00 DATE 14.05.2020
			SHEET 2 OF 2

S. No.	Description	Data to be filled by successful bidder
	c) At starting	
C.	Constructional Features	
1	Method of connection of motor driven equipment	
2	Applicable Standard	
3	DOP of Enclosure	
4	Method of cooling	
5	Class of insulation	
6	Main terminal box	
	a) Type	
	b) Power Cable details (Conductor, size, armour/unarmour)	
	c) Cable Gland & lugs details (Size, type & material)	
	d) Permissible Fault level (kArms & duration in sec)	
7	Space heater details (Voltage & watts)	
8	Flame proof motor details (if applicable)	
	a) Enclosure	
	b) suitability for hazardous area	
	i Zone	O / I / II
	ii Group	IIA / IIB / IIC
9	No. of Stator winding	
10	Winding connection	
11	Kind of rotor winding	
12	Kind of bearings	
13	Direction of rotation when viewed from NDE	
14	Paint Shade & type	
15	Net weight of motor	
16	Outline mounting drawing No (To be enclosed as annexure)	
D.	Characteristic curves/ drawings (To be enclosed for motors of rating $\geq 55KW$)	
	a) Torque speed characteristic	
	b) Thermal withstand characteristic	
	c) Current vs time	
	d) Speed vs time	

THIS IS PART OF TECHNICAL SPECIFICATION PE-TS-468-571-A901 REV 00.

NAME OF VENDOR			SEAL	REV.	
NAME	SIGNATURE	DATE			



TITLE :
GENERAL TECHNICAL REQUIREMENTS

FOR

LV MOTORS

SPECIFICATION NO. : PE-SS-999-506-E101
VOLUME NO. : II-B
SECTION : D
REV NO. : 00 DATE : 29/08/2005
SHEET : 1 OF 1

GENERAL TECHNICAL REQUIREMENTS

FOR

LV MOTORS

SPECIFICATION NO.: PE-SS-999-506-E101 Rev 00



TITLE :
GENERAL TECHNICAL REQUIREMENTS

FOR

LV MOTORS

SPECIFICATION No. PE-SS-999-506-E101
Page No. 06 of 539
VOLUME NO. : **II-B**
SECTION : **D**
REV NO. : **00** DATE : 29/08/2005
SHEET : 1 OF 4

1.0 INTENT OF SPECIFICATION

The specification covers the design, materials, constructional features, manufacture, inspection and testing at manufacturer's work, and packing of Low voltage (LV) squirrel cage induction motors along with all accessories for driving auxiliaries in thermal power station.

Motors having a voltage rating of below 1000V are referred to as low voltage (LV) motors.

2.0 CODES AND STANDARDS

Motors shall fully comply with latest edition, including all amendments and revision, of following codes and standards:

IS:325	Three phase Induction motors
IS : 900	Code of practice for installation and maintenance of induction motors
IS: 996	Single phase small AC and universal motors
IS: 4722	Rotating Electrical machines
IS: 4691	Degree of Protection provided by enclosures for rotating electrical machines
IS: 4728	Terminal marking and direction of rotation rotating electrical machines
IS: 1231	Dimensions of three phase foot mounted induction motors
IS: 8789	Values of performance characteristics for three phase induction motors
IS: 13555	Guide for selection and application of 3-phase A.C. induction motors for different types of driven equipment
IS: 2148	Flame proof enclosures for electrical appliance
IS: 5571	Guide for selection of electrical equipment for hazardous areas
IS: 12824	Type of duty and classes of rating assigned
IS: 12802	Temperature rise measurement for rotating electrical machines
IS: 12065	Permissible limits of noise level for rotating electrical machines
IS: 12075	Mechanical vibration of rotating electrical machines

In case of imported motors, motors as per IEC-34 shall also be acceptable.

3.0 DESIGN REQUIREMENTS

3.1 Motors and accessories shall be designed to operate satisfactorily under conditions specified in data sheet-A and Project Information, including voltage & frequency variation of supply system as defined in Data sheet-A

3.2 Motors shall be continuously rated at the design ambient temperature specified in Data Sheet-A and other site conditions specified under Project Information
Motor ratings shall have at least a 15% margin over the continuous maximum demand of the driven equipment, under entire operating range including voltage & frequency variation specified above.

3.3 Starting Requirements

3.3.1 Motor characteristics such as speed, starting torque, break away torque and starting time shall be properly co-ordinated with the requirements of driven equipment. The accelerating torque at any speed with the minimum starting voltage shall be at least 10% higher than that of the driven equipment.

3.3.2 Motors shall be capable of starting and accelerating the load with direct on line starting without exceeding acceptable winding temperature.

THIS IS PART OF TECHNICAL SPECIFICATION PE-TS-468-571-A901 REV 00.



TITLE :
GENERAL TECHNICAL REQUIREMENTS

FOR

LV MOTORS

SPECIFICATION No. 07 of 539
PE-SS-999-506-E101
VOLUME NO. : **II-B**
SECTION : **D**
REV NO. : **00** DATE : 29/08/2005
SHEET : 2 OF 4

The limiting value of voltage at rated frequency under which a motor will successfully start and accelerate to rated speed with load shall be taken to be a constant value as per Data Sheet - A during the starting period of motors.

3.3.3 The following frequency of starts shall apply

- i) Two starts in succession with the motor being initially at a temperature not exceeding the rated load temperature.
- ii) Three equally spread starts in an hour the motor being initially at a temperature not exceeding the rated load operating temperature. (not to be repeated in the second successive hour)
- iii) Motors for coal conveyor and coal crusher application shall be suitable for three consecutive hot starts followed by one hour interval with maximum twenty starts per day and shall be suitable for minimum 20,000 starts during the life time of the motor

3.4 **Running Requirements**

3.4.1 Motors shall run satisfactorily at a supply voltage of 75% of rated voltage for 5 minutes with full load without injurious heating to the motor.

3.4.2 Motor shall not stall due to voltage dip in the system causing momentary drop in voltage upto 70% of the rated voltage for duration of 2 secs.

3.5 **Stress During bus Transfer**

3.5.1 Motors shall withstand the voltage, heavy inrush transient current, mechanical and torque stress developed due to the application of 150% of the rated voltage for at least 1 sec. caused due to vector difference between the motor residual voltage and the incoming supply voltage during occasional auto bus transfer.

3.5.2 Motor and driven equipment shafts shall be adequately sized to satisfactorily withstand transient torque under above condition.

3.6 Maximum noise level measured at distance of 1.0 metres from the outline of motor shall not exceed the values specified in IS 12065.

3.7 The max. vibration velocity or double amplitude of motors vibration as measured at motor bearings shall be within the limits specified in IS: 12075.

4.0 **CONSTRUCTIONAL FEATURES**

4.1 Indoor motors shall conform to degree of protection IP: 54 as per IS: 4691. Outdoor or semi-indoor motors shall conform to degree of protection IP: 55 as per IS: 4691 and shall be of weather-proof construction. Outdoor motors shall be installed under a suitable canopy

4.2 Motors upto 160KW shall have Totally Enclosed Fan Cooled (TEFC) enclosures, the method of cooling conforming to IC-0141 or IC-0151 of IS: 6362.

Motors rated above 160 KW shall be Closed Air Circuit Air (CACA) cooled

4.3 Motors shall be designed with cooling fans suitable for both directions of rotation.

THIS IS PART OF TECHNICAL SPECIFICATION PE-TS-468-571-A901 REV 00.



TITLE :
GENERAL TECHNICAL REQUIREMENTS

FOR

LV MOTORS

SPECIFICATION NO. of 539 PE-SS-999-506-E101
VOLUME NO. : II-B
SECTION : D
REV NO. : 00 DATE : 29/08/2005
SHEET : 3 OF 4

- 4.4. Motors shall not be provided with any electric or pneumatic operated external fan for cooling the motors.
- 4.5. Frames shall be designed to avoid collection of moisture and all enclosures shall be provided with facility for drainage at the lowest point.
- 4.6. In case Class 'F' insulation is provided for LV motors, temperature rise shall be limited to the limits applicable to Class 'B' insulation.
In case of continuous operation at extreme voltage limits the temperature limits specified in table-1 of IS:325 shall not exceed by more than 10°C.
- 4.7. **Terminals and Terminal Boxes**
- 4.7.1. Terminals, terminal leads, terminal boxes, windings tails and associated equipment shall be suitable for connection to a supply system having a short circuit level, specified in the Data Sheet-A.

Unless otherwise stated in Data Sheet-A, motors of rating 110 kW and above will be controlled by circuit breaker and below 110 kW by switch fuse-contactor. The terminal box of motors shall be designed for the fault current mentioned in data sheet "A".
- 4.7.2. unless otherwise specified or approved, phase terminal boxes of horizontal motors shall be positioned on the left hand side of the motor when viewed from the non-driving end.
- 4.7.3. Connections shall be such that when the supply leads R, Y & B are connected to motor terminals A B & C or U, V & W respectively, motor shall rotate in an anticlockwise direction when viewed from the non-driving end. Where such motors require clockwise rotation, the supply leads R, Y, B will be connected to motor terminals A, C, B or U W & V respectively.
- 4.7.4. Permanently attached diagram and instruction plate made preferably of stainless steel shall be mounted inside terminal box cover giving the connection diagram for the desired direction of rotation and reverse rotation.
- 4.7.5. Motor terminals and terminal leads shall be fully insulated with no bar live parts. Adequate space shall be available inside the terminal box so that no difficulty is encountered for terminating the cable specified in Data Sheet-A.
- 4.7.6. Degree of protection for terminal boxes shall be IP 55 as per IS 4691.
- 4.7.7. Separate terminal boxes shall be provided for space heaters.. If this is not possible in case of LV motors, the space heater terminals shall be adequately segregated from the main terminals in the main terminal box. Detachable gland plates with double compression brass glands shall be provided in terminal boxes.
- 4.7.8. Phase terminal boxes shall be suitable for 360 degree of rotation in steps of 90 degree for LV motors.
- 4.7.9. Cable glands and cable lugs as per cable sizes specified in Data Sheet-A shall be included. Cable lugs shall be of tinned Copper, crimping type.
- 4.8. Two separate earthing terminals suitable for connecting G.I. or MS strip grounding conductor of size given in Data Sheet-A shall be provided on opposite sides of motor frame. Each terminal box shall have a grounding terminal.

4.9. **General**

THIS IS PART OF TECHNICAL SPECIFICATION PE-TS-468-571-A901 REV 00.



TITLE :
GENERAL TECHNICAL REQUIREMENTS

FOR

LV MOTORS

SPECIFICATION No. of 539
PE-SS-999-506-E101
VOLUME NO. : **II-B**
SECTION : **D**
REV NO. : **00** DATE : 29/08/2005
SHEET : 4 OF 4

- 4.9.1 Motors provided for similar drives shall be interchangeable.
- 4.9.2 Suitable foundation bolts are to be supplied alongwith the motors.
- 4.9.3 Motors shall be provided with eye bolts, or other means to facilitate safe lifting if the weight is 20Kgs. and above.
- 4.9.4 Necessary fitments and accessories shall be provided on motors in accordance with the latest Indian Electricity rules 1956.
- 4.9.5 All motors rated above 30 kW shall be provided with space heaters to maintain the motor internal air temperature above the dew point. Unless otherwise specified, space heaters shall be suitable for a supply of 240V AC, single phase, 50 Hz.
- 4.9.6 Name plate with all particulars as per IS: 325 shall be provided
- 4.9.7 Unless otherwise specified, the colour of finish shall be grey to Shade No. 631 and 632 as per IS:5 for motors installed indoor and outdoor respectively. The paint shall be epoxy based and shall be suitable for withstanding specified site conditions.
- 5.0 INSPECTION AND TESTING**
- 5.1 All materials, components and equipments covered under this specification shall be procured, manufactured, as per the BHEL standard quality plan No. PED-506-00-Q-006/0 and PED-506-00-Q-007/2 enclosed with this specification and which shall be complied.
- 5.2 LV motors of type-tested design shall be provided. Valid type test reports not more than 5 year shall be furnished. In the absence of these, type tests shall have to be conducted by manufacturer without any commercial implication to purchaser.
- 5.3 All motors shall be subjected to routine tests as per IS: 325 and as per BHEL standard quality plan.
- 5.4 Motors shall also be subjected to additional tests, if any, as mentioned in Data Sheet A.
- 6.0 DRAWINGS TO BE SUBMITTED AFTER AWARD OF CONTRACT**
- a) OGA drawing showing the position of terminal boxes, earthing connections etc.
- b) Arrangement drawing of terminal boxes.
- c) Characteristic curves:
(To be given for motor above 55 kW unless otherwise specified in Data Sheet).
- i) Current vs. time at rated voltage and minimum starting voltage.
- ii) Speed vs. time at rated voltage and minimum starting voltage.
- iii) Torque vs. speed at rated voltage and minimum voltage.
For the motors with solid coupling the above curves i), ii), iii) to be furnished for the motors coupled with driven equipment. In case motor is coupled with mechanical equipment by fluid coupling, the above curves shall be furnished with and without coupling.
- iv) Thermal withstand curve under hot and cold conditions at rated voltage and max. permissible voltage.

THIS IS PART OF TECHNICAL SPECIFICATION PE-TS-468-571-A901 REV 00.



SUB-SECTION-V-QE1

MOTORS

THIS IS PART OF TECHNICAL SPECIFICATION PE-TS-468-571-A901 REV 00.

**LOT-2 PROJECTS
FLUE GAS DESULPHURISATION (FGD) SYSTEM PACKAGE**

**TECHNICAL SPECIFICATION
SECTION-VI
BID DOCUMENT NO.: CS-0011-109(2)-9**



QUALITY ASSURANCE

MOTOR

TESTS/CHECKS	Visual	Dimensional	Make/Type/Rating /General	Physical Inspection	Mech/Chem. Properties	NDT /DP/PI/UT	Metallography	Electrical Characteristics	Welding/Brazing(WPS/PQR)	Heat Treatment	Magnetic Characteristics	Hydraulic/Leak/Pressure Test	Thermal Characteristics	Run out	Dynamic Balancing	Routine & Acceptance tests as per IS-325/IS-4722 /IS- 9283/IS-2148/IEC60034\IEC 60079-II /IS-12615	Vibration	Over speed	Tan delta, shaft voltage & polarization index test	Paint shade, thickness & adhesion
Plates for stator frame, end shield, spider etc.	Y	Y	Y	Y	Y	Y	Y	Y		Y										
Shaft	Y	Y	Y	Y	Y	Y	Y			Y										
Magnetic Material	Y	Y	Y	Y	Y			Y			Y									
Rotor Copper/Aluminium	Y	Y	Y	Y	Y			Y		Y										
Stator copper	Y	Y	Y	Y	Y			Y		Y			Y							
SC Ring	Y	Y	Y	Y	Y	Y		Y	Y	Y										
Insulating Material	Y		Y	Y	Y			Y		Y										
Tubes, for Cooler	Y	Y	Y	Y	Y	Y				Y		Y								
Sleeve Bearing	Y	Y	Y	Y	Y	Y				Y		Y								
Stator/Rotor, Exciter Coils	Y	Y	Y	Y				Y	Y	Y										
Castings, stator frame, terminal box and bearing housing etc.	Y	Y	Y	Y	Y	Y			Y	Y										
Fabrication & machining of stator, rotor, terminal box	Y	Y				Y			Y	Y										



QUALITY ASSURANCE

CLAUSE NO.

Wound stator	Y	Y																	
Wound Exciter	Y	Y																	
Rotor complete	Y	Y																	
Exciter, Stator, Rotor, Terminal Box assembly	Y	Y																	
Accessories, RTD, BTD, CT, Space heater, antifriction bearing, gaskets etc.	Y	Y																	
Complete Motor	Y	Y	Y													Y	Y	Y	Y

Note: 1. This is an indicative list of tests/checks. The manufacture is to furnish a detailed Quality Plan indicating the practices & Procedure followed along with relevant supporting documents during QP finalization. However, No QP for LT motor upto 50KW.
 2. Additional routine tests for Flame proof motors shall be applicable as per relevant standard
 3. Makes of major bought out items for HT motors will be subject to NTPC approval.
 4. Y1 = for HT Motor / Machines only.

**LOT-2 PROJECTS
 FLUE GAS DESULPHURISATION (FGD)
 SYSTEM PACKAGE**

**TECHNICAL SPECIFICATION
 SECTION – VI
 BID DOC. NO.:CS-0011-109(2)-9**

**PART-B
 SUB-SECTION-V-QE1
 MOTORS**

THIS IS PART OF TECHNICAL SPECIFICATION PE-TS-468-571-A901 REV 00.



CLAUSE NO.	TECHNICAL REQUIREMENTS		
<p>2.01.06</p> <p>2.01.07</p> <p>2.01.08</p> <p>2.01.09</p> <p>2.01.10</p> <p>2.01.11</p> <p>3.00.00</p> <p>3.01.00</p> <p>3.01.01</p> <p>3.01.02</p> <p>3.01.03</p> <p>3.01.04</p> <p>3.01.05</p>	<p>Exit signs shall be provided near doors for personnel escape in case of emergency</p> <p>Boiler Area</p> <p>Cable trays in boiler & ESP area shall be supported from the boiler and ESP structures. The same shall be coordinated with SG/ESP contractor.</p> <p>Cable trays in these areas shall be in vertical formation to avoid dust accumulation. No cable trenches shall be provided in boiler/ESP area.</p> <p>Two separate cable routes shall be provided for cable routing of working and standby drives or different set/group (say 50% capacity) of auxiliaries.</p> <p>OffSite Area</p> <p>For feeder in bidder's scope for offsite areas, overhead cable tray arrangement shall be followed. However cable trenches/slit may also be acceptable, for some areas, if found to be required during detailed engineering.</p> <p>Cable trenches provided shall be separated from fuel oil area to avoid oil accumulation.</p> <p>The cable slits to be used for motor/equipment power/control supply shall be sand filled & covered with PCC after cabling.</p> <p>Sizing criteria, derating factors for the cables shall be met as per respective chapters. However for the power cables, the minimum conductor size shall be 6 sq.mm. for aluminium conductor and 2.5 sq.mm. for copper conductor cable.</p> <p>Conscious exceptions to the above guidelines may be accepted under special conditions but suitable measures should be taken at such location to:</p> <ul style="list-style-type: none"> • Meet all safety requirements • Safeguard against fire hazards, mechanical damage, flooding of water, oil accumulation, electrical faults/interferences, etc <p>EQUIPMENT DESCRIPTION</p> <p>Cable trays, Fittings & Accessories</p> <p>Cable trays shall be ladder/perforated type as specified complete with matching fittings (like brackets, elbows, bends, reducers, tees, crosses, etc.) accessories (like side coupler plates, etc. and hardware (like bolts, nuts, washers, G.I. strap, hook etc.) as required. Cable tray shall be ladder type for power & control cables and perforated for instrumentation cables.</p> <p>Cable trays, fittings and accessories shall be fabricated out of rolled mild steel sheets free from flaws such as laminations, rolling marks, pitting etc. These (including hardware) shall be hot dip galvanized as per Clause No. 3.13.00 of this chapter.</p> <p>Cable trays shall have standard width of 150 mm, 300 mm & 600 mm and standard lengths of 2.5 metre. Thickness of mild steel sheets used for fabrication of cable trays and fittings shall be 2 mm. The thickness of side coupler plates shall be 3 mm.</p> <p>Cable troughs shall be required for branching out few cables from main cable route. These shall be U-shaped, fabricated of mild steel sheets of thickness 2 mm and shall be hot dip galvanised as per Clause No. 3.13.00 of this chapter. Troughs shall be standard width of 50 mm & 75 mm with depth of 25 mm.</p> <p>The tolerance for cable tray and accessories shall be as per IS 2102 (Part-1).</p>		
<p>LOT-2 PROJECTS FLUE GAS DESULPHURISATION (FGD) SYSTEM PACKAGE</p>	<p>TECHNICAL SPECIFICATION SECTION – VI BID DOC. NO.:CS-0011-109(2)-9</p>	<p>PART-B SUB SECTION-II-E6 CABLING, EARTHING & LIGHTNING PROTECTION</p>	<p>Page 3 of 23</p>



CLAUSE NO.	TECHNICAL REQUIREMENTS		
<p>3.02.00</p> <p>3.02.01</p> <p>3.02.02</p> <p>3.02.03</p>	<p>Tolerance Class: - Coarse</p> <p>Support System for Cable Trays</p> <p>Cable tray support system shall be pre-fabricated out of single sheet as per enclosed tender drawings.</p> <p>Support system for cable trays shall essentially comprise of the two components i.e. main support channel and cantilever arms. The main support channel shall be of two types : (i) C1:- having provision of supporting cable trays on one side and (ii) C2:-having provision of supporting cable trays on both sides. The support system shall be the type described hereunder</p> <p>a. Cable supporting steel work for cable racks/cables shall comprise of various channel sections, cantilever arms, various brackets, clamps, floor plates, all hardwares such as lock washers, hexagon nuts, hexagon head bolt, support hooks, stud nuts, hexagon head screw, channel nut, channel nut with springs, fixing studs, etc.</p> <p>b. The system shall be designed such that it allows easy assembly at site by using bolting. All cable supporting steel work, hardwares fittings and accessories shall be prefabricated factory galvanised.</p> <p>c. The main support and cantilever arms shall be fixed at site using necessary brackets, clamps, fittings, bolts, nuts and other hardware etc. to form various arrangements required to support the cable trays. Welding of the components shall not be allowed. However, welding of the bracket (to which the main support channel is bolted) to the overhead beams, structural steel, insert plates or reinforcement bars will be permitted. Any cutting or welding of the galvanised surface shall be brushed and red lead primer, oil primer & aluminium paint shall be applied</p> <p>d. All steel components, accessories, fittings and hardware shall be hot dip galvanised after completing welding, cutting, drilling and other machining operation.</p> <p>e. The typical arrangement of flexible support system is shown in the enclosed drawings and described briefly below:</p> <p>The main support channel and cantilever arms shall be fabricated out of 2.5 thick rolled steel sheet conforming to IS 1079.</p> <p>f. Cantilever arms of 320 mm, 620mm and 750 mm in length are required, and shall be as shown in the enclosed drawing. The arm portion shall be suitable for assembling the complete arm assembly on to component constructed of standard channel section. The back plate shall allow sufficient clearance for fixing bolt to be tightened with tray in position.</p> <p>g. Support system shall be able to withstand</p> <ul style="list-style-type: none"> • weight of the cable trays • weight of the cables (75 Kg/Metre run of each cable tray) • Concentrated load of 75 Kg between every support span. • Factor of safety of minimum 1.5 shall be considered. <p>The size of structural steel members or thickness of sheet steel of main support channel and cantilever arms and other accessories as indicated above or in the enclosed drawings are indicative only. Nevertheless, the support system shall be designed by the bidder to fully</p>		
<p>LOT-2 PROJECTS FLUE GAS DESULPHURISATION (FGD) SYSTEM PACKAGE</p>	<p>TECHNICAL SPECIFICATION SECTION – VI BID DOC. NO.:CS-0011-109(2)-9</p>	<p>PART-B SUB SECTION-II-E6 CABLING, EARTHING & LIGHTNING PROTECTION</p>	<p>Page 4 of 23</p>



CLAUSE NO.	TECHNICAL REQUIREMENTS		
	<p>meet the requirements of type tests as specified. In case the system fails in the tests, the components design modification shall be done by the Bidder without any additional cost to the Employer. The bidder shall submit the detailed drawings of the system offered by him alongwith the bid.</p> <p>3.02.04 Four legged structure shall be provided wherever there is change in elevation and change in direction</p> <p>3.02.05 FOR COAL HANDLING PLANT/FGD PLANT AREA THE FOLLOWING SHALL ALSO BE APPLICABLE:</p> <p>a) All overhead cable routes shall be along the route of the conveyor gallery on separate supporting structures and cables shall be laid in vertical trays. The bottom of the steel shall be such that the existing facilities, movement of trucks/human beings etc. does not get affected. The cable trestle shall have a minimum 600mm clear walk way and shall have maintenance platforms as required. The bottom of the steel supporting structure shall be generally at 3.0M above the grade level except for rail/road crossings where it shall be at 8.0M above grade level. Tap offs from the overhead cable trestle can be through shallow trenches with prior approval of the Employer. Directly buried cable, if essential, shall not have concentration of more than 4 cables on one route.</p> <p>b) Cable trenches shall be provided only in Switchgear/MCC rooms.</p> <p>c) Cables shall not be routed through the conveyor galleries except for the equipment located in the conveyor galleries for a particular conveyor i.e. protection switches, receptacles etc.</p> <p>d) Cables for PCS and BSS shall be routed along the conveyors through GI conduits.</p> <p>3.03.00 Pipes, Fittings & Accessories</p> <p>3.03.01 Pipes offered shall be complete with fittings and accessories (like tees, elbows, bends, check nuts, bushings, reducers, enlargers, coupling caps, nipples etc.) The size of the pipe shall be selected on the basis of maximum 40% fill criteria</p> <p>3.03.02 GI Pipes shall be of medium duty as per IS: 1239</p> <p>3.03.03 Duct banks shall be High Density PE pipes encased in PCC (10% spare of each size, subject to minimum one) with suitable water-proof manholes.</p> <p>3.03.04 Hume pipes shall be NP3 type as per IS 458.</p> <p>3.03.05 TERNE Coated Flexible Steel Conduits shall be water proof and rust proof made of heat resistant lead coated steel. Conduit diameter shall be uniform throughout its length. Internal surface of the conduit shall be free from burrs and sharp edges. Conduits shall be complete with necessary accessories for proper termination of the conduit with junction boxes and lighting fixtures</p> <p>3.03.06 HDPE pipes and conduits shall be PE-80, PN-10 type as per IS 4984/IS 8008 part-I.</p> <p>3.04.00 Junction Boxes</p>		
<p>LOT-2 PROJECTS FLUE GAS DESULPHURISATION (FGD) SYSTEM PACKAGE</p>	<p>TECHNICAL SPECIFICATION SECTION – VI BID DOC. NO.:CS-0011-109(2)-9</p>	<p>PART-B SUB SECTION-II-E6 CABLING, EARTHING & LIGHTNING PROTECTION</p>	<p>Page 5 of 23</p>



CLAUSE NO.	TECHNICAL REQUIREMENTS		
3.04.01	<p>Junction box shall be made of Fire retardant material. Material of JB shall be Thermoplastic or thermosetting or FRP type. The box shall be provided with the terminal blocks, mounting bracket and screws etc. The cable entry shall be through galvanized steel conduits of suitable diameter. The JB shall have suitable for installing glands of suitable size on the bottom of the box. The JB shall be suitable for surface mounting on ceiling/structures. The JB shall be of grey color RAL 7035. All the metal parts shall be corrosion protected. Junction box surface should be such that it is free from crazings, blisterings, wrinkling, colour blots/striations. There should not be any mending or repair of surface. JB's will be provided with captive screws so that screws don't fall off when cover is opened. JB's mounting brackets should be of powder coated MS. Type test reports for the following tests shall be furnished:-</p> <p>(a) Impact resistance for impact energy of 2 Joules (IK07) as per BS EN50102</p> <p>(b) Thermal ageing at 70deg C for 96 hours as per IEC60068-2-2Bb.</p> <p>(c) Class of protection shall be IP 55.</p> <p>(d) HV test.</p>		
3.04.02	<p>Terminal blocks shall be 1100V grade, of suitable current rating, made up of unbreakable polyamide 6.6 grade. The terminals shall be screw type or screw-less (spring loaded) / cage clamp type with lugs. Marking on terminal strips shall correspond to the terminal numbering in wiring diagrams. All metal parts shall be of non-ferrous material. In case of screw type terminals the screw shall be captive, preferably with screw locking design. All terminal blocks shall be suitable for terminating on each side the required cables/wire size. All internal wiring shall be of cu. Conductor PVC wire.</p>		
3.05.00	<p>Terminations & Straight Through Joints</p>		
3.05.01	<p>Termination and jointing kits for 33kV, 11 kV, 6.6 KV and 3.3 kV grade XLPE insulated cables shall be of proven design and make which have already been extensively used and type tested. Termination kits and jointing kits shall be Pre-moulded type or heat shrinkable type. Further Cold shrinkable type termination and jointing kits are also acceptable. The Cold shrinkable type kits shall be type tested as per relevant standards. Calculation to withstand the required fault level shall also be furnished in case of cold shrinkable type kits. 33 kV, 11 kV, 6.6 KV and 3.3kV grade joints and terminations shall be type tested and Type test reports as per IS:13573 Part-II and IEC60502 shall be furnished. Also, heat shrink material shall comply with requirements of ESI 09-13 (external tests). Critical components used in cable accessories shall be of tested and proven quality as per relevant product specification/ESI specification. Cable joints and terminations should be with FRLS properties as per IEC 60754-1&2. Kit contents shall be supplied from the same source as were used for type testing. The kit shall be complete with the tinned copper solderless crimping type cable lugs & ferrule or mechanical connectors (wherein bolts are tightened that shear off at an appropriate torque) as per DIN standard suitable for aluminium compacted conductor cables. (Tender drg. no 0000-211-POE -A-51-RA of cable lug attached at the end of this chapter).</p>		
3.05.02	<p>Straight through joint and termination shall be capable of withstanding the fault level of 21 KA for 0.12 Sec. with dynamic peak of 52 KA for 33 KV system & of 40 kA for 0.12 sec with a dynamic peak of 100 kA for 11 kV, 6.6 KV & 3.3 KV system. Straight through joints shall have provisions for shield connection and earthing wherever required and complete with all accessories and consumables suitable for storage without deterioration at a temperature of 50 deg. C with shelf life of more than five years. 1.1 kV grade straight through joints shall also be of proven design</p>		
3.05.03	<p>1.1 KV grade Straight Through Joint shall be of proven design.</p>		
<p>LOT-2 PROJECTS FLUE GAS DESULPHURISATION (FGD) SYSTEM PACKAGE</p>	<p>TECHNICAL SPECIFICATION SECTION – VI BID DOC. NO.:CS-0011-109(2)-9</p>	<p>PART-B SUB SECTION-II-E6 CABLING, EARTHING & LIGHTNING PROTECTION</p>	<p>Page 6 of 23</p>



CLAUSE NO.	TECHNICAL REQUIREMENTS		
<p>3.06.00</p> <p>3.06.01</p> <p>3.07.00</p> <p>3.07.01</p> <p>3.08.00</p> <p>3.08.01</p> <p>3.09.00</p> <p>3.09.01</p> <p>3.10.00</p> <p>3.10.01</p> <p>3.11.00</p>	<p>Cable glands</p> <p>Cable shall be terminated using double compression type cable glands. Testing requirements of Cable glands shall conform to BS:6121 and gland shall be of robust construction capable of clamping cable and cable armour (for armoured cables) firmly without injury to insulation. Cable glands shall be made of heavy duty brass machine finished and nickel chrome plated. Thickness of plating shall not be less than 10 micron. All washers and hardware shall also be made of brass with nickel chrome plating Rubber components shall be of neoprene or better synthetic material and of tested quality. Cable glands shall be suitable for the sizes of cable supplied/erected.</p> <p>Cable lugs/ferrules</p> <p>Cable lugs/ferrules for power cables shall be tinned copper solderless crimping type suitable for aluminium compacted conductor cables. Cable lugs and ferrules for control cables shall be tinned copper type. The cable lugs for control cables shall be provided with insulating sleeve and shall suit the type of terminals provided on the equipments. Cable lugs and ferrule shall conform to IS/DIN standards.</p> <p>Trefoil clamps</p> <p>Trefoil clamps for single core cables shall be pressure die cast aluminum or fibre glass or nylon and shall include necessary fixing accessories like G.I. nuts, bolts, washers, etc. Trefoil clamps shall have adequate mechanical strength, when installed at 1 mtr intervals, to withstand the forces generated by the peak value of maximum system short circuit current.</p> <p>Cable Clamps & Ties</p> <p>The cable clamps/ties required to clamp multicore cables shall be of SS-316 material, 12mm wide, polyester coated ladder lock type. The clamps/ties shall have self locking arrangement & shall have sufficient strength. The cable clamps/ties shall be supplied in finished individual pieces of suitable length to meet the site requirements.</p> <p>Receptacles</p> <p>Receptacles boxes shall be fabricated out of MS sheet of 2mm thickness and hot dipped gavanised or of die-cast aluminium alloy of thickness not less than 2.5 mm. The boxes shall be provided with two nos. earthing terminals, gasket to achieve IP55 degree of protection, terminal blocks for loop-in loop-out for cable of specified sizes, mounting brackets suitable for surface mounting on wall/column/structure, gland plate etc. The ON-OFF switch shall be rotary type heavy duty, double break, AC23 category, suitable for AC supply. Plug and Socket shall be shrouded Die-cast aluminium. Socket shall be provided with lid safety cover. Robust mechanical interlock shall be provided such that the switch can be put ON only when the plug is fully engaged and plug can be withdrawn only when the switch is in OFF position. Also cover can be opened only when the switch is in OFF position. Wiring shall be carried out with 1100 V grade PVC insulated stranded aluminium/copper wire of adequate size. The Terminal blocks shall be of 1100 V grade. The Terminal blocks shall be of 1100 V grade made up of unbreakable polymide 6.6 grade with adequate current rating and size. The welding receptacles shall be provided with RCCB/RCD of 30mA sensitivity having facility for manual testing/checking of operation of RCCB/RCD.</p> <p>Cable Drum Lifting Jack</p> <p>The jack for cable drum lifting shall be of screw type with 10 ton capacity. The cable drum jacks shall be manufactured from fabricated steel. The spindles supplied with the cable</p>		
<p>LOT-2 PROJECTS FLUE GAS DESULPHURISATION (FGD) SYSTEM PACKAGE</p>	<p>TECHNICAL SPECIFICATION SECTION – VI BID DOC. NO.:CS-0011-109(2)-9</p>	<p>PART-B SUB SECTION-II-E6 CABLING, EARTHING & LIGHTNING PROTECTION</p>	<p>Page 7 of 23</p>



CLAUSE NO.	TECHNICAL REQUIREMENTS		
	<p>drum jack shall be manufactured using BSEN-24 grade steel bar with locking collars. Jack nests shall be of SG cast steel. Cable drum jack supplied shall have undergone load testing and reports for the same shall be submitted. At least Two Nos. of jacks shall be supplied for NTPC use. Contractor has to make arrangements for his own jacks for cable reeling/unreeling under his scope of installation.</p>		
3.12.00	Galvanising		
3.12.01	Galvanising of steel components and accessories shall conform to IS:2629 , IS4759 & IS:2633. Additionally galvanising shall be uniform, clean smooth, continuous and free from acid spots.		
3.12.02	The amount of zinc deposit over threaded portion of bolts, nuts, screws and washers shall be as per IS:1367 . The removal of extra zinc on threaded portion of components shall be carefully done to ensure that the threads shall have the required zinc coating on them as specified		
3.13.00	Welding		
3.13.01	The welding shall be carried out in accordance with IS:9595. All welding procedures and welders qualification shall also be followed strictly in line with IS:9595		
4.00.00	INSTALLATION		
4.01.00	Cable tray and Support System Installation		
4.01.01	Cables shall run in cable trays mounted horizontally or vertically on cable tray support system which in turn shall be supported from floor, ceiling, overhead structures, trestles, pipe racks, trenches or other building structures.		
4.01.02	Horizontally running cable trays shall be clamped by bolting to cantilever arms and vertically running cable trays shall be bolted to main support channel by suitable bracket/clamps on both top and bottom side rails at an interval of 2000 mm in general. For vertical cable risers/shafts cable trays shall be supported at an interval of 1000mm in general. Fixing of cable trays to cantilever arms or main support channel by welding shall not be accepted. Cable tray installation shall generally be carried out as per the approved guidelines/ drawings. Vendor shall design the support system along with tray, spacing etc in line with tray loadings/drawings.		
4.01.03	The cantilever arms shall be positioned on the main support channel with a minimum vertical spacing of 300 mm unless otherwise indicated.		
4.01.04	The contractor shall fix the brackets/ clamps/ insert plates using anchor fasteners. Minimum size of anchor fasteners shall be M 8 X 50 and material shall be stainless steel grade 316 or better. Anchor fastener shall be fixed as recommended by manufacturer and as approved by site engineer. For brick wall suitable anchor fasteners shall be used as per the recommendations of manufacturer. Make of anchor fasteners subject to QA approval and the same shall be finalized at pre-award stage.		
4.01.05	All cable way sections shall have identification, designations as per cable way layout drawings and painted/stenciled at each end of cable way and where there is a branch connection to another cable way. Minimum height of letter shall be not less than 75 mm. For long lengths of trays, the identification shall be painted at every 10 meter. Risers shall additionally be painted/stenciled with identification numbers at every floor.		
4.01.06	In certain cases it may be necessary to site fabricate portions of trays, supports and other non standard bends where the normal prefabricated trays, supports and accessories may		
<p align="center">LOT-2 PROJECTS FLUE GAS DESULPHURISATION (FGD) SYSTEM PACKAGE</p>	<p align="center">TECHNICAL SPECIFICATION SECTION – VI BID DOC. NO.:CS-0011-109(2)-9</p>	<p align="center">PART-B SUB SECTION-II-E6 CABLING, EARTHING & LIGHTNING PROTECTION</p>	<p align="center">Page 8 of 23</p>

THIS IS PART OF TECHNICAL SPECIFICATION PE-TS-468-571-A901 REV 00.



CLAUSE NO.	TECHNICAL REQUIREMENTS												
	<p>not be suitable. Fabricated sections of trays, supports and accessories to make the installation complete at site shall be neat in appearance and shall match with the prefabricated sections in the dimensions. They shall be applied with one coat of red lead primer, one coat of oil primer followed by two finishing coats of aluminium paint.</p> <p>4.02.00 Conduits/Pipes/Ducts Installation</p> <p>4.02.01 The Contractor shall ensure for properly embedding conduit pipe sleeves wherever necessary for cabling work. All openings in the floor/roof/wall / cable tunnel/cable trenches made for conduit installation shall be sealed and made water proof by the Contractor.</p> <p>4.02.02 GI pull wire of adequate size shall be laid in all conduits before installation. Metallic conduit runs at termination shall have two lock nuts wherever required for junction boxes etc.</p> <p>4.02.03 Conduit runs/sleeves shall be provided with PVC bushings having round edge at each end. All conduits/pipes shall have their ends closed by caps until cables are pulled. After cables are pulled, the ends of conduits/pipes shall be sealed with Glass wool/Cement Mortar/Putty to prevent entrance of moisture and foreign material</p> <p>4.02.04 Exposed conduit/pipe shall be adequately supported by racks, clamps, straps or by other approved means. Conduits /pipe support shall be installed square and true to line and grade with an average spacing between the supports as given below, unless specified otherwise</p> <table border="1" data-bbox="357 904 948 1182"> <thead> <tr> <th>Conduit /pipe size (dia).</th> <th>Spacing</th> </tr> </thead> <tbody> <tr> <td>Upto 40 mm</td> <td>1 M</td> </tr> <tr> <td>50 mm</td> <td>2.0 M</td> </tr> <tr> <td>65-85 mm</td> <td>2.5 M</td> </tr> <tr> <td>100 mm and above</td> <td>3.0 M</td> </tr> </tbody> </table> <p>4.02.05 For bending of conduits, bending machine shall be arranged at site by the contractor to facilitate cold bending. The bends formed shall be smooth.</p> <p>4.03.00 Junction Boxes Installation</p> <p>4.03.01 Junction boxes shall be mounted at a height of 1200mm above floor level or as specified in the drawings and shall be adequately supported/mounted on masonry wall by means of anchor fasteners/ expandable bolts or shall be mounted on an angle, plate or other structural supports fixed to floor, wall, ceiling or equipment foundations.</p> <p>4.04.00 Cable Installation</p> <p>4.04.01 Cable installation shall be carried out as per IS:1255 and other applicable standards.</p> <p>4.04.02 For Cable unloading, pulling etc following guidelines shall be followed in general:</p> <p>a) Cable drums shall be unloaded, handled and stored in an approved manner on hard and well drained surface so that they may not sink. In no case shall be drum be stored flat i.e. with flange horizontal. Rolling of drums shall be avoided as far as possible. For short distances, the drums may be rolled provided they are rolled slowly and in proper direction as marked on the drum. In absence of any indication, the drums may be rolled in the same direction as it was rolled during taking up the cables. For unreeling the cable, the drum shall be mounted on suitable jacks or on cable wheels and shall be rolled slowly so that cable comes out over the drum and not from below. All possible care shall be taken during unreeling and laying to avoid</p>			Conduit /pipe size (dia).	Spacing	Upto 40 mm	1 M	50 mm	2.0 M	65-85 mm	2.5 M	100 mm and above	3.0 M
Conduit /pipe size (dia).	Spacing												
Upto 40 mm	1 M												
50 mm	2.0 M												
65-85 mm	2.5 M												
100 mm and above	3.0 M												
<p>LOT-2 PROJECTS FLUE GAS DESULPHURISATION (FGD) SYSTEM PACKAGE</p>	<p>TECHNICAL SPECIFICATION SECTION – VI BID DOC. NO.:CS-0011-109(2)-9</p>	<p>PART-B SUB SECTION-II-E6 CABLING, EARTHING & LIGHTNING PROTECTION</p>	<p>Page 9 of 23</p>										

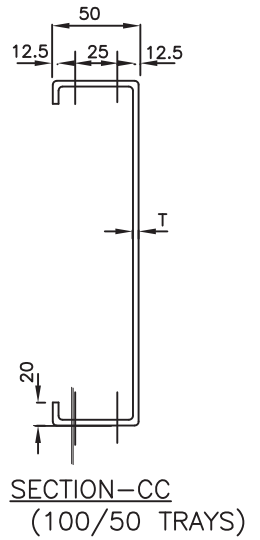
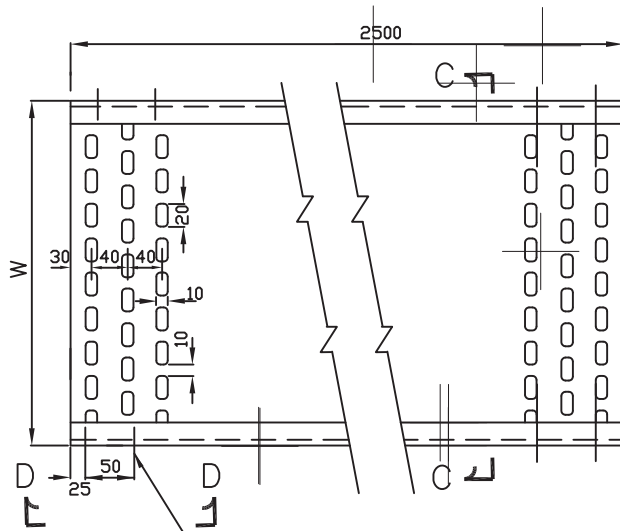

4 HOLES 10mm DIA.

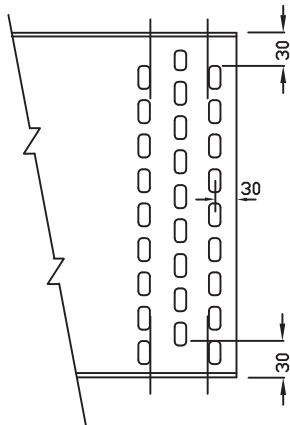

ARRANGEMENT OF PERFORATIONS

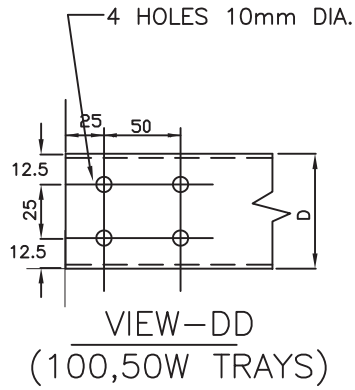

TRAY WIDTH W (mm)	100	50
TRAY DEPTH D (mm)	50	50
T (mm)	2	2

PERFORATED TYPE TRAY

THIS IS PART OF TECHNICAL SPECIFICATION PE-TS-468-571-A901 REV.00.



TYPICAL DETAILS OF CABLE TRAYS AND ACCESSORIES

DWG. NO.

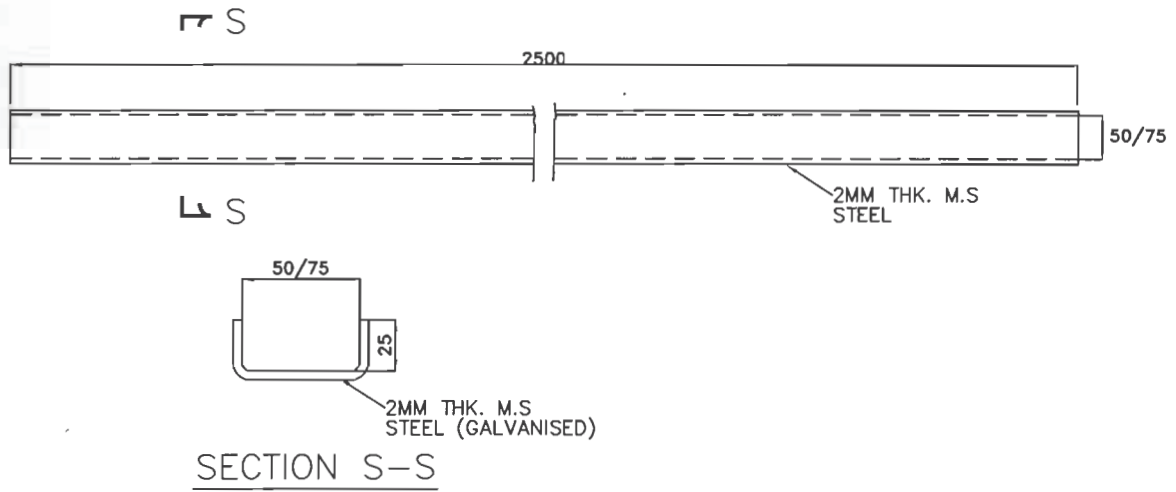

CABLE TROUGHS

SEE GENERAL NOTES IN SHEET 11.

THIS IS PART OF TECHNICAL SPECIFICATION PE-TS-468-571-A901 REV 00.



TYPICAL DETAILS OF
CABLE TRAY AND ACCESSORIES

BHEL DRAWING NO.
PE-DG-427-507-E005

SH 10 OF 11

REV 00

	NSPCL BHILAI (2X250 MW)	SPECIFICATION No: PE-TS-468-571-A901	
	GYPSUM DEWATERING EQUIPMENT	SECTION : I	
		SUB-SECTION : C-4	
		REV. 00	
TECHNICAL SPECIFICATION (C&I PORTION)			

SECTION: I
SUB-SECTION: C-4
TECHNICAL SPECIFICATION (C&I PORTION)

THIS IS PART OF TECHNICAL SPECIFICATION PE-TS-468-571-A901 REV 00.

	2X250 MW NSPCL BHILLAI TPP-FGD(LOT-2)	SECTION: C
	TECHNICAL REQUIREMENTS (C&I) GYPSUM DEWATERING EQUIPMENT	

**CONTROL AND INSTRUMENTATION
FOR
GYPSUM DEWATERING EQUIPMENT**

THIS IS PART OF TECHNICAL SPECIFICATION PE-TS-468-571-A901 REV 00.

	2X250 MW NSPCL BHILLAI TPP-FGD(LOT-2)	DESG	CM
	JOB NO: 468	CHKD	RKR
	REV. NO. 00	DATE: 19.05.2020	APPD



**C&I SPECIFICATION FOR
GYPSUM DEWATERING EQUIPMENT**

SECTION: C
SUB SECTION: C&I

**C&I SPECIFICATION FOR
GYPSUM DEWATERING EQUIPMENT**

1

THIS IS PART OF TECHNICAL SPECIFICATION PE-TS-468-571-A901 REV 00.



C&I SPECIFICATION FOR GYPSUM DEWATERING EQUIPMENT

SECTION: C
SUB SECTION: C&I

INDEX

S. No.	DESCRIPTION
1	TITLE SHEET
2	INDEX SHEET
3	C&I SPECIFIC TECHNICAL REQUIREMENTS
4	GENERAL TECHNICAL SPECIFICATION
5	LIST OF DOCUMENTS/DELIVERABLES
6	MEASURING INSTRUMENTS (PRIMARY & SECONDARY)
7	DATA SHEETS FOR MOTORISED VALVE ACTUATOR
8	SIGNL EXCHANGE BETWEEN DRIVES & DCS
9	DRIVE AND INSTRUMENT INTERFACE DIAGRAM
10	INSTRUMENT CABLE INTERCONNECTION AND TERMINATION PHILOSOPHY
11	QUALITY ASSURANCE
12	TYPE TEST REQUIREMENT
13	INSTRUMENT STUB DETAILS
14	INSTRUMENT INSTALLATION DRAWING
15	MANDATORY SPARE LIST
16	SUB VENDOR LIST

THIS IS PART OF TECHNICAL SPECIFICATION PE-TS-468-571-A901 REV 00.



**C&I SPECIFICATION FOR
GYPSUM DEWATERING EQUIPMENT**

SECTION: C
SUB SECTION: C&I

**C&I SPECIFIC TECHNICAL REQUIREMENT
FOR DCS BASED
GYPSUM DEWATERING EQUIPMENT**

1

THIS IS PART OF TECHNICAL SPECIFICATION PE-TS-468-571-A901 REV 00.



C&I SPECIFICATION FOR (GYPSUM DEWATERING EQUIPMENT

SECTION: C
SUB SECTION: C&I

Specific Technical Requirements (C&I):

1. GYPSUM DEWATERING EQUIPMENT (GDE) shall be operated from DCS (BHEL's scope).
2. The Contractor shall provide complete Instrumentation along with necessary fittings, accessories and valve manifold etc for control, monitoring and operation of entire GDE except marked as BHEL's scope in P&ID attached in specification. All instruments shall be provided with durable epoxy coating for housing and all exposed surfaces of the instruments.
3. All the Electronic Transmitter for Pressure, Temperature and DP based Flow /Level measurements shall be genuine, verifiable PROFIBUS PA protocol compatible instruments. The transmitters shall be connected to DDCMIS through PROFIBUS PA protocol complying to IEC 61158 directly from transmitter. This is subject to customer approval and BHEL decision shall be final.
4. Electrical Actuators (as applicable) shall be Non-Intrusive type electric actuators envisaged with integral starter. The interface of these actuators with DCS shall be of two types viz. with Hardwired interface and with PROFIBUS DP interface. All actuator settings including torque, limit shall be possible without opening the actuator cover and LCD indication shall be available integral to actuator body. Open/Close command termination logic suitably built inside the actuator Details shall be referring in the specification.
5. All ON, OFF, and INCHING Type electric actuators shall be PROFIBUS DP compatible. However, the exact protocol shall be based on finalized protocol of DCS. If PROFIBUS DP protocol is envisaged, then actuator shall have two (redundant) PROFIBUS DP ports for connecting the redundant PROFIBUS DP cables. That is if one PROFIBUS DP cable is cut or not working/not available, then complete actuator functionality shall be available through the second redundant cable without any manual intervention.
6. The PROFIBUS protocol design shall be further validated by BHEL and approved by NTPC during detailed engineering and any variation/ changes required based on DDCMIS system requirements and actual field installation, operational philosophy etc. shall be considered by bidder without any implications.
7. The requirements given are to be read in conjunction with detailed Technical specification enclosed in the specification. Further in case of any discrepancy in the requirement within the same section noted by the bidder in the specification, the same will be brought to the notice of BHEL in the form of pre- bid clarification. In absence of any pre-bid clarification, the more stringent requirement as per interpretation of customer shall prevail without any commercial implication.
8. The make of the items shall be from sub-vendor list. However, the make/model of various instruments/items/systems shall be subject to approval of owner/purchaser during detailed engineering stage. No commercial and delivery implication in this regard shall be acceptable. In case of any conflict or repetition of clauses in the specification, the more stringent requirements among them are to be complied with.

THIS IS PART OF TECHNICAL SPECIFICATION PE-TS-468-571-A901 REV 00.



C&I SPECIFICATION FOR GYPSUM DEWATERING EQUIPMENT

SECTION: C
SUB SECTION: C&I

10. All instruments (except PROFIBUS PA compatible transmitters) and control elements shall be terminated on JB/LCP in field and JB/LCP are in bidder's scope for bidder's supplied instrument and in BHEL's scope for BHEL's supplied instrument. Number of Junction Boxes shall be sufficient and positioned in the field to minimize local cabling (max 12-15 mtrs) and trunk cable.
11. The contacts of equipment mounted instruments; sensors, switches etc. For external connection including spare contacts shall be wired out to suitably located junction boxes by bidder.
12. For cable scope refer to electrical scope between BHEL and vendor defined in electrical specification.
13. The design, manufacture, inspection, testing, site calibration and installation of all C&I equipment and systems covered under this specification shall conform to the latest editions of applicable codes and standards.
14. Bidder to provide mandatory spares as per mandatory spares list.
15. The specifications for instruments mentioned in the specification are minimum requirements. The detail specifications shall be finalized during detail engineering. The bidders shall specifically mention any deviation they would like to take on the C&I specification. In absence of only deviation, a No deviation certificate is to be furnished.
16. The quantity of instruments for the system shall be as per tender P & ID wherever provided of the respective system as a minimum, for bidding purpose. However, Bidder shall also include in his proposal all the instruments and devices that are needed for the completeness of the plant auxiliary system/ equipment supplied by the bidder, even if the same is not specifically appearing in the P & ID. During detail engineering if any additional instruments are required for safe & reliable operation of plant, bidder shall supply the same without any price implication.
17. Bidder to provide input/output list, drives list, junction box schedule and termination details, recommended control logics / write-up etc. the list of documents to be submitted after award of contract is to be referred by bidder.
18. All the transmitters supplied by Bidder shall be rack mounted. The transmitter racks shall be in Bidder's scope of supply. All transmitters shall be HART compatible.
19. Bidder to perform tests of C&I items/instruments/systems as per Quality plans/type test attached in the specification. However, if any test not specified in the quality plan but specified in specification Tests for I&C equipment included elsewhere in specification will have to perform by Bidder without any cost implication.
20. Instrument installation and accessories required for the same shall be in Bidder's scope and shall be submitted after award of contract. However, any instrument/ analyser installation not covered in the same shall be subject to customer and BHEL approval during detailed engineering. Bidder to provide erection hardware including junction boxes, canopies, structural steel as required.

THIS IS PART OF TECHNICAL SPECIFICATION PE-TS-468-571-A901 REV 00.



C&I SPECIFICATION FOR GYPSUM DEWATERING EQUIPMENT

SECTION: C
SUB SECTION: C&I

21. Provision for separate Terminal block/wiring diagram for power and control blocks of control panel to be ensured.
22. All Temperature sensors shall be Duplex type and temperature transmitter shall be provided for all temperature measurement applications. Bidder to provide temperature transmitter, JB/Rack & other erection hardware.
23. Bidder to provide temperature sensor along with temperature transmitter for HT drives i.e. Pump and Motor for BRG and winding temp measurement.
24. Vibration Monitoring System, is envisaged for HT Motor, which is in BHEL scope. However, for mounting of vibration sensors/probe, vendor to provide vibration pad (of dimension of 80mm x 80mm x 10mm each) for mounting of sensors and a notch/slot for mounting of key phasor.
25. Bidder to provide Flow measuring device suitable for the service condition, which shall be decided by BHEL/customer during detail engineering. Bidder to comply the requirement without any commercial implication.
26. Bidder to furnish electrical load/UPS load data during detailed engineering.
27. 415VAC /230 V UPS Power supply shall be provided by BHEL at a single point, further distribution to various instruments/equipment of the system shall be in bidder scope. Bidder to include necessary power distribution board in his scope. Any power supply other than the above, if required by any instrument/equipment has to be derived by the bidder from the above supply & all necessary hardware for the same shall be in bidder scope. Bidder to submit the power requirement along with the bid.
28. Power supply derived for contact interrogation, interposing relay and solenoid shall generally be ungrounded 24 V D.C. only.
29. Interface of MCC, HT SWGR, Solenoid valves, field instruments, Actuators etc. with DDCMIS based control system shall be as per Drive Control Philosophy enclosed in specification.
30. Local control panel and VFD panel, if any required for operation shall be in bidder scope.
31. The solenoid operated valves/Dampers/Gate shall have a limit switch for open/close feedback. Solenoid Valve shall be rated for 24V Dc only.
32. All field instruments enclosure shall be IP65, local panel/cabinet enclosure shall be IP 55, unless otherwise specified.
33. Diaphragm seal shall be provided with Instruments having contact with corrosive media.
34. To ensure availability, adequate redundancy in system design shall be provided at hardware, software and sensor level. For the protection system, independent sensing device shall be provided to ensure adequate safety of plant equipment.
35. Redundancy of sensors shall be provided by bidder



C&I SPECIFICATION FOR GYPSUM DEWATERING EQUIPMENT

SECTION: C
SUB SECTION: C&I

- (i) Triple redundancy for all Analog and binary inputs required for protection of system/drives.
(ii) For all other control functions dual redundancy of the sensors shall be provided by the bidder.
36. Double root valve shall be provided for all pressure tapings where the pressure exceeds 40kg/cm².
37. Use of process actuated shall be avoided unless unavoidable.
38. Number of pairs to be selected for Screen /Control cable
- a) F-Type: 2P/4P/8P/12P (Size: 0.5sqmm²)
 - b) G-Type: 2P/4P/8P/12P (Size: 0.5sqmm²)
 - c) Core Cable: 3CX2.5sqmm²/ 5CX2.5sqmm²/ 12CX1.5sqmm²
39. Instrument installation shall be as per the attached "Standard Hook-up diagram of instrument."
40. In addition to requirements specified here, all C&I systems/ sub-systems/ equipment/ devices shall also meet other requirements stipulated under other Sub-sections/ parts/ sections of specification. In case of any conflict and repetition of clauses in the specification, BHEL discretion will prevail. The requirements given are to be read in conjunction with detailed Technical specification enclosed.
41. All field instruments shall be weatherproof, drip tight, dust tight and splash proof suitable for use under outdoor ambient conditions prevalent in the subject plant. All field-mounted instruments shall be mounted in suitable locations where maximum accessibility for maintenance is achieved. All the field instruments shall also be provided with SS tag nameplate and double compression type Nickel-plated brass cable gland. Gaskets, Fasteners, Counter and mating flange (SS316 material), nuts & bolts etc. shall also be included, wherever required with the field instruments.
42. All the outdoor field instruments such as analysers/transmitters/meters etc. shall be provided with suitable Free standing cabinet(s)/panel/rack/canopy so that the equipment are protected against rain/ sunlight etc.
43. All instruments should be supplied with valid calibration and test certificates provided by OEM.
44. At least 20% spare unused terminals shall be provided everywhere including local junction boxes, instrument racks/enclosures, termination/marshalling cabinets, etc.
45. Drive control philosophy/signal exchange list attached elsewhere in the specification are Tentative. Shall be finalized during detailed engineering.
46. The successful bidder shall furnish Instrument Schedule, I/O list, Drive list, Cable Schedule, Cable interconnection (DCS end terminal details shall be provided to the successful bidder during detail engineering to incorporate in cable interconnection), JB grouping, Annunciation list, SOE list, List of Instruments/devices for HART in BHEL approved format. Also reusable database format like MS Excel, MS Access etc. of these documents shall also be provided in BHEL approved format. Soft copy of the formats shall be provided to the successful bidder.



C&I SPECIFICATION FOR GYPSUM DEWATERING EQUIPMENT

SECTION: C
SUB SECTION: C&I

Note:-

1. All equipment items shall be of latest design with proven on track record.
2. The above given scope is indicative & minimum. Any item/ equipment not indicated above however required for the completeness of the system is to be supplied by bidder without any technical, commercial and delivery implication to BHEL.
3. Documents of C&I System shall be submitted to end user/owner for approval during detail engineering. Changes, if any, shall be accommodated by the bidder without any price/time implication.



**C&I SPECIFICATION FOR
GYPSUM DEWATERING EQUIPMENT**

SECTION: C
SUB SECTION: C&I

**GENERAL TECHNICAL REQUIREMENTS
(GYPSUM DEWATERING EQUIPMENT)**

THIS IS PART OF TECHNICAL SPECIFICATION PE-TS-468-571-A901 REV 00.

	SPECIFICATION FOR CONTROL & INSTRUMENTATION FOR AUX PACKAGES	SPECIFICATION NO.:	
		VOLUME	
		SUB SECTION	
		REV. NO.	DATE :
		SHEET	OF

GENERAL REQUIREMENT

- 1.0 Bidder shall provide complete and independent control & instrumentation system with all accessories, auxiliaries and associated equipments for the safe, efficient and reliable operation of auxiliary systems.
- 2.0 The quantity of instruments for auxiliary system shall be as per tender P & ID wherever provided of the respective system as a minimum, for bidding purpose. However, Bidder shall also include in his proposal all the instruments and devices that are needed for the completeness of the plant auxiliary system/ equipment supplied by the bidder, even if the same is not specifically appearing in the P & ID. During detail engineering if any additional instruments are required for safe & reliable operation of plant, bidder shall supply the same without any price implication.
- 3.0 Measuring instruments/equipment and subsystems offered by the bidder shall be from reputed experienced manufacturers of specified type and range of equipment, whose guaranteed and trouble free operation has been proven. Further all the instruments shall be of proven reliability, accuracy, and acceptable international standards and shall be subject to employer's approval. All instrumentation equipment and accessories under this specification shall be furnished as per technical specification, ranges, makes/ numbers as approved by the employer' during detail engineering.
- 4.0 The necessary root valves, impulse piping, drain cocks, gauge-zeroing cocks, valve manifold and all the other accessories required for mounting/ erection of these local instruments shall be furnished, even if not specifically asked for, on as required basis. The contacts of equipment mounted instruments; sensors, switches etc for external connection including spare contacts shall be wired out to suitably located junction boxes.
- 5.0 The customer specification attached as Specific Technical Requirement will supercede the Data sheets, if there is any mismatch.



**C&I SPECIFICATION FOR
GYPSUM DEWATERING EQUIPMENT**

SECTION: C
SUB SECTION: C&I

LIST OF DOCUMENTS/DELIVERABLES

THIS IS PART OF TECHNICAL SPECIFICATION PE-TS-468-571-A901 REV 00.



C&I SPECIFICATION FOR GYPSUM DEWATERING EQUIPMENT

SECTION: C
SUB SECTION: C&I

LIST OF DELIVERABLES OF PEM - C&I DEPARTMENT#

Sl. No.	DRAWING NO.#	DRAWING/DOCUMENT TITLE#	CATEGORY #
1#	PE-V4-468-145-I901#	CONTROL & OPERATIONAL WRITE-UP FOR THE# SYSTEM WITH SET POINTS#	A#
2#	PE-V4-468-145-I902#	CONTROL SCHEME/LOGIC DIAGRAM (TO BE# IMPLEMENTED IN DDCMIS)#	A#
3#	PE-V4-468-145-I903#	HMI PICTURES/PLANT SCHEMATICS#	A#
4#	PE-V4-468-145-I904#	INSTRUMENT SCHEDULE WITH SET POINTS#	A#
5#	PE-V4-468-145-I905#	I/O LIST (ANALOG & BINARY)#	A#
6#	PE-V4-468-145-I906#	DRIVE LIST/SOLENOID/ACTUATOR VALVE LIST# WITH LOCATION DATA#	A#
7#	PE-V4-468-145-I907#	FIELD JB/LIE/LIR,DRIVES TERMINATIONS#	A#
8#	PE-V4-468-145-I908#	DATASHEETS FOR INSTRUMENTS, JBs, etc.#	A#
9#	PE-V4-468-145-I909#	QUALITY PLANS (INSTRUMENTS, VMS, etc.)#	A#
10#	PE-V4-468-145-I910#	INSTRUMENT HOOK-UP DRAWING#	A#
11#	PE-V4-468-145-I911#	THERMOWELL SIZING CALCULATION#	A#
12#	PE-V4-468-145-I913#	CABLE SCHEDULE & INTERCONNECTION#	A#
13#	PE-V4-468-145-I914#	ANNUNCIATION & SOE LIST#	A#

#

NOTES:#

ANY OTHER DOCUMENT DECIDED DURING DETAILED ENGINEERING SHALL BE PROVIDED BY BIDDER WITHOUT ANY COMMERCIAL/TECHNICAL IMPLICATION.#

CONTRACTOR TO SUBMIT REUSABLE DATABASE FORMATS IN BHEL/CUSTOMER APPROVED FORMATS LIKE MS EXCEL, MS ACCESS OF DOCUMENTS LIKE INSTRUMENT SCHEDULE, I/O LIST, DRIVE LIST, FIELD JB TERMINATIONS, CABLE SCHEDULE & INTERCONNECTION, etc.#
SOFT COPY OF FORMATS SHALL BE PROVIDED TO SUCCESSFUL BIDDERS.#

THIS IS PART OF TECHNICAL SPECIFICATION PE-TS-468-571-A901 REV 00.



**C&I SPECIFICATION FOR
GYPSUM DEWATERING EQUIPMENT**

SECTION: C
SUB SECTION: C&I

**MEASURING INSTRUMENTS
(PRIMARY & SECONDARY)
&
SPECIFICATION FOR ELECTRONIC
TRANSMITTERS**

1

THIS IS PART OF TECHNICAL SPECIFICATION PE-TS-468-571-A901 REV 00.



CLAUSE NO.	TECHNICAL REQUIREMENTS		
1.00.00	MEASURING INSTRUMENTS (PRIMARY AND SECONDARY)		
1.01.00	Measuring instruments/equipment and subsystems offered by the Bidder shall be from reputed experienced manufacturers of specified type and range of equipment, whose guaranteed and trouble free operation has been proven. Refer Sub-section Basic Design Criteria. Further, all instruments shall be of proven reliability, accuracy, and repeatability requiring a minimum of maintenance and shall comply with the acceptable international standards and shall be subject to Employer's approval.		
1.02.00	Every panel-mounted instrument requiring power supply shall be provided with easily replaceable glass cartridge fuses of suitable rating. Every instrument shall be provided with a grounding terminal and shall be suitably connected to the panel grounding bus.		
1.03.00	All transmitters, sensors, switches and gauges for parameters like pressure, temperature, level, flow etc. as required for the safe and efficient operation and maintenance as well as for operator and management information (including all computation) of equipment in the system under the scope of specification shall be provided on as required basis with in quoted lump sum price. The Contractor shall furnish all Instrumentation / Control equipment & accessories under this specification as per technical specification, ranges, makes & model as approved by the Employer during detailed engineering.		
1.04.00	The necessary root valves, impulse piping, drain cocks, gauge-zeroing cocks, valve manifolds and all the other accessories required for mounting/erection of these local instruments shall be furnished, even if not specifically asked for, on as required basis. The contacts of equipment mounted instruments, sensors, switches etc. for external connection including spare contacts shall be wired out in flexible/rigid conduits, independently to suitably located common junction boxes. The proposal shall include the necessary cables, flexible conduits, junction boxes and accessories for the above purpose. Double root valves shall be provided for all pressure tapping where the pressure exceeds 40 Kg./sq.cm.		
1.05.00	<p>All instruments envisaged for sea water applications, shall be provided with wetted parts made of Monel/ Hastelloy C or any other material (if provenness experience of the proposed material for such applications is established by contractor).</p> <p>For Chlorine application: Instruments shall be provided with wetted parts (e.g. diaphragm seal, etc.) made of Hastelloy C. Also, filled liquid shall be Fluorolube oil/ Inert Hydrocarbon / CTFE etc., for these applications.</p> <p>For applications of FECL3 solution: Instruments shall be provided with wetted parts (e.g. diaphragm seal, etc.) made of Tantalum.</p>		
1.06.00	For coastal areas, all instruments shall be provided with durable epoxy coating for housings and all exposed surfaces of the instruments.		
1.07.00	The instruments, for which technical specification is not attached, shall be supplied as per the standard and proven practice of the contractor. The same shall be established by the contractor during detailed engineering by providing detailed explanation/concepts, if required by the employer, of such implementation along with standard documentation.		
<p align="center">LOT-2 PROJECTS FLUE GAS DESULPHURISATION (FGD) SYSTEM PACKAGE</p>	<p align="center">TECHNICAL SPECIFICATION SECTION – VI BID DOC. NO.:CS-0011-109(2)-9</p>	<p align="center">PART-B SUB-SECTION-III-C2 MEASURING INSTRUMENTS</p>	<p align="center">PAGE 1 OF 40</p>



CLAUSE NO.	TECHNICAL REQUIREMENTS																	
13.00.00	<p>FIELD INSTRUMENTS BASED ON FIELDBUS</p> <p>The following instruments shall be connected to DDCMIS through fieldbus i.e. FOUNDATION Fieldbus/PROFIBUS PA protocol complying to IEC 61158 directly from transmitter.</p>																	
13.01.00	<p>Electronic Transmitter for Pressure, Differential Pressure and DP based Flow / Level measurements.</p> <table border="1" data-bbox="381 814 1414 1724"> <thead> <tr> <th data-bbox="381 842 488 894">S No.</th> <th data-bbox="488 842 756 894">Features</th> <th data-bbox="756 842 1414 894">Essential/Minimum Requirements</th> </tr> </thead> <tbody> <tr> <td data-bbox="381 894 488 940">1.</td> <td data-bbox="488 894 756 940">Type of Transmitter</td> <td data-bbox="756 894 1414 940">FOUNDATION Fieldbus/PROFIBUS PA based output</td> </tr> <tr> <td data-bbox="381 940 488 1192">2.</td> <td data-bbox="488 940 756 1192">Accuracy</td> <td data-bbox="756 940 1414 1192"> ± 0.060 % of calibrated range (minimum) for calibrated range greater than 400 mmwc. $+0.065$% of calibrated range (minimum) for calibrated range greater than 250 kg/cm². ± 0.10 % of calibrated range (minimum) for calibrated range less than 400 mmwc. </td> </tr> <tr> <td data-bbox="381 1192 488 1499">3.</td> <td data-bbox="488 1192 756 1499">Stability</td> <td data-bbox="756 1192 1414 1499"> 0.25 % of calibrated range for 10 years for calibrated range greater than equal to 400 mmwc on standard conditions of manufacturer. 0.2 % of calibrated range for 1 years for calibrated range less than 400 mmwc on standard conditions of manufacturer. 0.15% of calibrated range for 5 years for DPT with static pressure greater than 250 kg/cm². </td> </tr> <tr> <td data-bbox="381 1499 488 1640">4</td> <td data-bbox="488 1499 756 1640">Turn down</td> <td data-bbox="756 1499 1414 1640"> 50:1 for greater than or equal to span of 400mmwcl. 20:1 for span below 400mmwcl. 10:1 for span greater than 250 kg/cm² </td> </tr> </tbody> </table> <p>(Above mentioned (2,3,4) parameters/features of offered models shall be strictly as defined in standard published catalogue of the manufacturer only).</p>			S No.	Features	Essential/Minimum Requirements	1.	Type of Transmitter	FOUNDATION Fieldbus/PROFIBUS PA based output	2.	Accuracy	± 0.060 % of calibrated range (minimum) for calibrated range greater than 400 mmwc. $+0.065$ % of calibrated range (minimum) for calibrated range greater than 250 kg/cm ² . ± 0.10 % of calibrated range (minimum) for calibrated range less than 400 mmwc.	3.	Stability	0.25 % of calibrated range for 10 years for calibrated range greater than equal to 400 mmwc on standard conditions of manufacturer. 0.2 % of calibrated range for 1 years for calibrated range less than 400 mmwc on standard conditions of manufacturer. 0.15% of calibrated range for 5 years for DPT with static pressure greater than 250 kg/cm ² .	4	Turn down	50:1 for greater than or equal to span of 400mmwcl. 20:1 for span below 400mmwcl. 10:1 for span greater than 250 kg/cm ²
S No.	Features	Essential/Minimum Requirements																
1.	Type of Transmitter	FOUNDATION Fieldbus/PROFIBUS PA based output																
2.	Accuracy	± 0.060 % of calibrated range (minimum) for calibrated range greater than 400 mmwc. $+0.065$ % of calibrated range (minimum) for calibrated range greater than 250 kg/cm ² . ± 0.10 % of calibrated range (minimum) for calibrated range less than 400 mmwc.																
3.	Stability	0.25 % of calibrated range for 10 years for calibrated range greater than equal to 400 mmwc on standard conditions of manufacturer. 0.2 % of calibrated range for 1 years for calibrated range less than 400 mmwc on standard conditions of manufacturer. 0.15% of calibrated range for 5 years for DPT with static pressure greater than 250 kg/cm ² .																
4	Turn down	50:1 for greater than or equal to span of 400mmwcl. 20:1 for span below 400mmwcl. 10:1 for span greater than 250 kg/cm ²																
<p align="center">LOT-2 PROJECTS FLUE GAS DESULPHURISATION (FGD) SYSTEM PACKAGE</p>	<p align="center">TECHNICAL SPECIFICATION SECTION – VI BID DOC. NO.:CS-0011-109(2)-9</p>	<p align="center">PART-B SUB-SECTION-III-C2 MEASURING INSTRUMENTS</p>	<p align="center">PAGE 34 OF 40</p>															



CLAUSE NO.	TECHNICAL REQUIREMENTS		
5	Housing	Weather proof as per IP-67, metallic housing with durable corrosion resistant coating	
6.	Electrical connection	½" NPT(F) FOUNDATION Fieldbus/PROFIBUS PA compatible	
7.	Process connection	½" NPT (F)	
8.	Operating Ambient temperature	85 deg C without display. 70 deg C with display.	
	Overpressure	150% of max operating pressure	
9.	Accessories	<p>-Diaphragm seal, pulsation dampeners, syphon etc. as required by service and operating condition.</p> <p>-2 valve manifold for absolute & gauge pressure transmitters, -3-valve for DP and 5 valve manifold for level/flow applications.</p> <p>-The valve manifold shall be non-integral type.</p> <p>-For hazardous area, enclosure as described in NEC article 5.</p>	
10.	Mounting	2 inch pipe mounting with Enclosure/Rack/Canopy.	
11.	Diagnostics & display	Self-Indicating feature and digital display on transmitter	
Notes			
<ul style="list-style-type: none"> - For primary air/ secondary air/flue gas/ furnace pressure applications, DP type transmitters shall be provided for pressure measurement below 2000 mmwc. 			
<ul style="list-style-type: none"> - LVDT type is not acceptable. 			
<ul style="list-style-type: none"> - Where the process fluids are corrosive, viscous, solid bearing or slurry type, diaphragm seals shall be provided. Parts below the diaphragm shall be removable for cleaning. The entire volume above the diaphragm shall be completely filled with an inert liquid suitable for the application. 			
<p align="center">LOT-2 PROJECTS FLUE GAS DESULPHURISATION (FGD) SYSTEM PACKAGE</p>	<p align="center">TECHNICAL SPECIFICATION SECTION – VI BID DOC. NO.:CS-0011-109(2)-9</p>	<p align="center">PART-B SUB-SECTION-III-C2 MEASURING INSTRUMENTS</p>	<p align="center">PAGE 35 OF 40</p>



CLAUSE NO.	TECHNICAL REQUIREMENTS								
2.02.00	<p>GUIDED WAVE RADAR TYPE LEVEL TRANSMITTER</p> <table border="1" data-bbox="386 1449 1372 1759"> <tr> <td data-bbox="391 1455 613 1570">Type</td> <td data-bbox="618 1455 1367 1570">Microprocessor based 2 wire type (loop powered), HART protocol compatible Guided wave radar transmitter.</td> </tr> <tr> <td data-bbox="391 1577 613 1640">Principle</td> <td data-bbox="618 1577 1367 1640">TDR (Time domain reflectometry)</td> </tr> <tr> <td data-bbox="391 1646 613 1753">Probe Type & Material</td> <td data-bbox="618 1646 1367 1753">(i) Coaxial probe of SS316/316L. If required, probe shall be suitable for overfill prevention.</td> </tr> </table>			Type	Microprocessor based 2 wire type (loop powered), HART protocol compatible Guided wave radar transmitter.	Principle	TDR (Time domain reflectometry)	Probe Type & Material	(i) Coaxial probe of SS316/316L. If required, probe shall be suitable for overfill prevention.
Type	Microprocessor based 2 wire type (loop powered), HART protocol compatible Guided wave radar transmitter.								
Principle	TDR (Time domain reflectometry)								
Probe Type & Material	(i) Coaxial probe of SS316/316L. If required, probe shall be suitable for overfill prevention.								
<p>LOT-2 PROJECTS FLUE GAS DESULPHURISATION (FGD) SYSTEM PACKAGE</p>	<p>TECHNICAL SPECIFICATION SECTION – VI BID DOC. NO.:CS-0011-109(2)-9</p>	<p>PART-B SUB-SECTION-III-C2 MEASURING INSTRUMENTS</p>	<p>PAGE 3 OF 40</p>						

THIS IS PART OF TECHNICAL SPECIFICATION PE-TS-468-571-A901 REV 00.



CLAUSE NO.	TECHNICAL REQUIREMENTS		
		(ii) Rod probe, cable probe of SS316/SS316L can be used for applications wherever coaxial probe is not suitable.	
Output signal		4-20 mA DC along with superimposed digital signal (based on HART protocol), suitable for over fill prevention.	
Accuracy		+/- 0.5% of calibrated span or minimum 5mm.	
Power supply		24 VDC +/- 10%.	
Housing		Weather proof as per IP-65, metallic housing with durable corrosion resistance coating.	
Adjustment/ calibration		Using hand held HART calibrator	
Zero & span adjustment		Continuous, temper proof, remote as well as manual adjustability from instrument. It should be possible to calibrate the instrument without any level in the tank/sump etc.	
Display		Integral digital display.	
Load Impedance		500 ohms (minimum).	
Electromagnetic compatibility		Shall meet EN 61326-1 (1997) and AmdtA1, class A equipment/EN 50081-2 & EN 5008 1-2 & EN 50082-2	
Mounting		<p>(i) External cage shall be provided where ever side mounting is required. External cage and other mounting accessories to be provided by the contractor.</p> <p>(ii) Where ever top mounting is required, all mounting accessories, stilling well (as required) etc., shall be provided by the contractor.</p> <p>(iii) All weather canopy shall be provided for protection from direct sunlight and direct rain for open locations.</p>	
	<p>Note: Four wire type transmitters can also be provided for applications where 2- wire transmitter has some technical limitations, subject to employer's approval during detailed engineering stage. However, in such cases isolated 4-20 mA</p>		
<p>LOT-2 PROJECTS FLUE GAS DESULPHURISATION (FGD) SYSTEM PACKAGE</p>	<p>TECHNICAL SPECIFICATION SECTION – VI BID DOC. NO.:CS-0011-109(2)-9</p>	<p>PART-B SUB-SECTION-III-C2 MEASURING INSTRUMENTS</p>	<p>PAGE 4 OF 40</p>



CLAUSE NO.

TECHNICAL REQUIREMENTS

2.03.00

Ultrasonic Type level Transmitter

DC (analog) output shall be provided. Power supply required for such transmitters shall be 240V AC / 24V DC.

S.No.	Features	Essential/Minimum requirement
1.	Type of Transmitter	Non-contact Microprocessor based 2 wire type (loop powered), HART protocol compatible Ultrasonic transmitter.
2.	Output signal	4-20 mA DC (Analog) along with superimposed digital signal (based on HART protocol).
3.	Accuracy	+/- 0.5% of calibrated span or minimum 5mm.
4.	Power supply	24 V DC +/- 10%.
5.	Temperature compensation	To be provided within transducer.
6.	Housing	Weather proof as per IP-65, metallic housing with durable corrosion resistance coating.
7.	Adjustment/calibration/maintenance	Using hand held HART calibrator
8.	Zero and Span adjustment	Continuous, tamper proof, remote as well as manual adjustability from instrument. It should be possible to calibrate the instrument without any level in the tank/sump etc.
9.	Sensor Material	Corrosion resistant material to suit individual application requirement.
10.	False signal tolerance	Transmitter shall be capable of ignoring false echoes from internal tank/sumps obstructions such as pipes, heating coils or agitator blades. Also transmitter shall have adjustable damping circuitry.



CLAUSE NO.	TECHNICAL REQUIREMENTS		
11.	Range	Range of transmitter shall be capable of covering the complete level span of tank taking care of blocking distance, frequency attenuation due to surface, obstructions, vapors etc.	
12.	Display	Integral digital display	
13.	Diagnostics	Loss of echo alarm etc.	
14.	Load Impedance	500 ohms (minimum).	
15.	Electrical Connection	Plug and socket	
16.	Accessories	<ul style="list-style-type: none"> • All weather canopy shall be provided for protection from direct sunlight and direct rain for open locations. • All mounting accessories required for erection and commissioning shall be provided. • For hazardous area, explosion proof enclosure as described in NEC article 500 	
<p>Note:</p> <p>1) Contractor can also provide Radar type transmitter as per above specification in place of ultrasonic transmitter subject to approval by Employer during detailed Engineering. Sonic frequency based transmitters can also be provided under “ultrasonic transmitters” category for fly ash silo level.</p> <p>2) Four wire type transmitters can also be provided for applications where 2- wire transmitter has some technical limitations, subject to employer’s approval during detailed engineering stage. However, in such cases isolated 4-20 mA DC (analog) output shall be provided. Power supply required for such transmitters shall be 240V AC / 24V DC.</p>			
<p align="center">LOT-2 PROJECTS FLUE GAS DESULPHURISATION (FGD) SYSTEM PACKAGE</p>	<p align="center">TECHNICAL SPECIFICATION SECTION – VI BID DOC. NO.:CS-0011-109(2)-9</p>	<p align="center">PART-B SUB-SECTION-III-C2 MEASURING INSTRUMENTS</p>	<p align="center">PAGE 6 OF 40</p>



CLAUSE NO.	TECHNICAL REQUIREMENTS		
	<p>3) For applications where transmitter location is not accessible, the transmitter shall have separate sensor unit and electronic unit for such applications. It shall be possible to mount the electronic unit at accessible location.</p>		
<p>LOT-2 PROJECTS FLUE GAS DESULPHURISATION (FGD) SYSTEM PACKAGE</p>	<p>TECHNICAL SPECIFICATION SECTION – VI BID DOC. NO.:CS-0011-109(2)-9</p>	<p>PART-B SUB-SECTION-III-C2 MEASURING INSTRUMENTS</p>	<p>PAGE 7 OF 40</p>

THIS IS PART OF TECHNICAL SPECIFICATION PE-TS-468-571-A901 REV 00.



CLAUSE NO.	TECHNICAL REQUIREMENTS									
3.02.00	<p>Resistance Temperature Detector (RTD)</p> <table border="1"> <thead> <tr> <th data-bbox="397 1690 446 1753">Sr. No.</th> <th data-bbox="487 1690 592 1717">Features</th> <th data-bbox="860 1690 1263 1717">Essential/Minimum Requirements</th> </tr> </thead> <tbody> <tr> <td> </td> <td> </td> <td> </td> </tr> </tbody> </table>			Sr. No.	Features	Essential/Minimum Requirements				
Sr. No.	Features	Essential/Minimum Requirements								
<p>LOT-2 PROJECTS FLUE GAS DESULPHURISATION (FGD) SYSTEM PACKAGE</p>	<p>TECHNICAL SPECIFICATION SECTION – VI BID DOC. NO.:CS-0011-109(2)-9</p>	<p>PART-B SUB-SECTION-III-C2 MEASURING INSTRUMENTS</p>	<p>PAGE 9 OF 40</p>							

THIS IS PART OF TECHNICAL SPECIFICATION PE-TS-468-571-A901 REV 00.



CLAUSE NO.	TECHNICAL REQUIREMENTS		
	<p>1 Type of RTD.</p> <p>2 No. of element</p> <p>3 Housing/Head</p> <p>4 Insulation and sheathing of RTD</p> <p>5 Calibration and accuracy</p> <p>6 Accessories</p> <p>7 Standard</p> <p>NOTES :</p> <p>1) The specifications for RTDs of winding/ bearings of motor/pump, can be as per their manufacturer standards. The manufacturer shall submit the adequate supporting documents for establishing their standard practice. However the type of RTD shall be Pt100.</p> <p>2) The specifications of temp elements for air conditioning & ventilation system / process can be as per system manufacturer's standards. The manufacturer shall submit the adequate supporting documents for establishing their standard practice.</p>	<p>: Four wire, Pt-100 (100 Ohms resistance at zero degree Centigrade).</p> <p>: Duplex</p> <p>: IP-65/Diecast Aluminium. Head of TE to be provided with sufficient space and arrangement to mount head mounted temperature transmitter (as applicable). Plug in connectors are to be provided for external signal cable connection. TE terminal head shall be spring loaded for positive contacts with the thermo well</p> <p>: Mineral (magnesium oxide) insulation and SS316 sheath,</p> <p>: As per IEC-751/ DIN-43760 Class-A for RTD</p> <p>: Thermo well and associated fittings</p> <p>: IEC-751/ DIN-43760 for RTD and ASME PTC-19.3 for Thermo-well.</p>	
<p>LOT-2 PROJECTS FLUE GAS DESULPHURISATION (FGD) SYSTEM PACKAGE</p>	<p>TECHNICAL SPECIFICATION SECTION – VI BID DOC. NO.:CS-0011-109(2)-9</p>	<p>PART-B SUB-SECTION-III-C2 MEASURING INSTRUMENTS</p>	<p>PAGE 10 OF 40</p>



CLAUSE NO.	TECHNICAL REQUIREMENTS		
3.04.00	<p>Thermo well (for all process temp. elements)</p> <p>(a) Shall be one piece solid bored type of 316 SS of step-less tapered design. (As per ASME PTC 19.3, 1974)</p> <p>(b) For Mill classifier outlet long life solid sintered tungsten carbide material of high abrasion resistance shall be provided.</p> <p>(c) For Air & Flue gas 316 SS protecting tube with welded cap. (However contractor shall provide better material for Flue gas service if required based on the specified boiler design parameters).</p> <p>(d) For furnace zone, impervious ceramic protecting tube of suitable material along with Incoloy supporting tubes and adjustable flanges.</p>		
3.05.00	<p>TEMPERATURE TRANSMITTER (TT)</p> <p>Following specifications are applicable for Dual input/ Single input temperature transmitter.</p> <p>Temperature transmitter shall be 2-wire (loop powered) directly powered from 4-20mA input cards of DDCMIS. TT shall be fully compatible with thermocouples and RTDs being provided by the contractor. Temperature compensation for thermocouples shall be performed in the temperature transmitter itself.</p>		
<p>LOT-2 PROJECTS FLUE GAS DESULPHURISATION (FGD) SYSTEM PACKAGE</p>	<p>TECHNICAL SPECIFICATION SECTION – VI BID DOC. NO.:CS-0011-109(2)-9</p>	<p>PART-B SUB-SECTION-III-C2 MEASURING INSTRUMENTS</p>	<p>PAGE 11 OF 40</p>



CLAUSE NO.	TECHNICAL REQUIREMENTS		
	<p>S No.</p> <p>1.</p> <p>2.</p> <p>3.</p> <p>4.</p> <p>5.</p> <p>6.</p> <p>7.</p> <p>8.</p> <p>9.</p>	<p>Features</p> <p>Output</p> <p>Input</p> <p>Isolation</p> <p>EMC compatibility</p> <p>Power supply</p> <p>Housing</p> <p>Electrical connection</p> <p>Diagnostics display</p> <p>Operating Ambient temperature</p> <p>Mounting</p> <p>Accessories</p> <p>Composite Accuracy</p>	<p>Essential/Minimum Requirements</p> <p>2-wire (power supply from input card of control system) with 4-20mA output with superimposed HART protocol signal</p> <p>Same transmitter shall be capable to handle Pt-100 RTD, Thermocouples –K, R & ,S types (Selectable through HART terminal/calibrator)</p> <p>Min 500 VAC</p> <p>As per EN 61326</p> <p>24 V C +/- 10%</p> <p>Weather proof as per IP-67, metallic housing with durable corrosion resistant coating</p> <p>Plug and Socket connector except hazardous area</p> <p>& Self-Indicating feature and digital display on transmitter</p> <p>85 deg C without display. 70 deg C with display.</p> <p>2 inch pipe mounting with Canopy.</p> <p>As required by service and operating condition.</p> <p>(Refer note 2)</p> <p>RTD =<0.25% of 0-250 deg C span T/C-K type =<0.2% of 0-600 deg C span CJC accuracy (for thermocouples) shall be =< 1 deg C</p> <p>Notes:</p> <p>1. In case of failure (open or burn-out) of RTD/thermocouple, transmitter shall provide low temperature output.</p> <p>2. Dual input temperature transmitter shall have bump less changeover facility to second sensor in case first sensor fails. This changeover is to be alarmed in control system.</p> <p>3. Composite accuracy is to be calculated as summation of all applicable accuracies of temperature transmitter for converting sensor input to output (e.g., A/D accuracy, basic accuracy, digital accuracy, etc.) and temperature effect on these accuracies at ambient temperature of 50 deg C, based on the figure/ formula given in the standard product catalogue for span as specified above for various types of temperature elements specified. All such accuracy/ temperature effect figures in</p>
<p>LOT-2 PROJECTS FLUE GAS DESULPHURISATION (FGD) SYSTEM PACKAGE</p>	<p>TECHNICAL SPECIFICATION SECTION – VI BID DOC. NO.:CS-0011-109(2)-9</p>	<p>PART-B SUB-SECTION-III-C2 MEASURING INSTRUMENTS</p>	<p>PAGE 12 OF 40</p>



CLAUSE NO.

TECHNICAL REQUIREMENTS

4.00.00

catalogue shall be first converted to deg C, and then percentage of this converted accuracy in specified span shall be calculated to compare with the specified composite accuracy figures. All temperature transmitters shall be interchangeable (i.e. can be used for either RTD or thermocouple) and composite accuracy shall be met for each type of input as specified above.

4. Above mentioned parameters/features of offered models shall be strictly as defined in standard published catalogue of the manufacturer only.
5. Dual input temperature transmitters can also be accepted in place of single input TT.

SPECIFICATIONS FOR PR. GAUGE, D.P. GAUGE, TEMP. GAUGE AND LEVEL GAUGE.

SI. No	FEATURES	ESSENTIAL/MINIMUM REQUIREMENTS		
		Pr. Gauge/ DP Gauge/ Draught gauges	Temperature Gauge	Level Gauge
1	Sensing Element	Bourdon for high pressure, Diaphragm/ Bellow for low pr.	Inert gas actuated/ Liquid filled other than mercury	Tempered * toughened Borosilicate gauge glass steel armoured reflex or transparent type.
2	Material of sensing element	SS 316	SS 316	
3	Material of movement	SS 304	SS 304	
4	Body material	Die-cast aluminium	Die-cast aluminium	Forged carbon steel/304 SS
5	Dial size	150mm	150 mm	Tubular covering entire range
6	End connection	1/2 inch NPT (M)	1/2 inch or 3/4 inch NPT (M).	Process connection as per ASME PTC and drain/vent 15 NB
7	Accuracy	±1% of span	± 1% of span	± 2%
8	Scale	Linear, 270° arc graduated in metric units	Linear, 270° arc graduated in °C	Linear vertical
9	Range selection	Shall cover 125% of max. operating press	Shall cover 125% of max. operating temp	Shall cover max. Operating level.

LOT-2 PROJECTS
FLUE GAS DESULPHURISATION (FGD)
SYSTEM PACKAGE

TECHNICAL SPECIFICATION
SECTION – VI
BID DOC. NO.:CS-0011-109(2)-9

PART-B
SUB-SECTION-III-C2
MEASURING
INSTRUMENTS

PAGE 13 OF 40

THIS IS PART OF TECHNICAL SPECIFICATION PE-TS-468-571-A901 REV 00.



CLAUSE NO.	TECHNICAL REQUIREMENTS			
10	Over range	125% of FSD	125% of FSD	-
11	Housing	Weather and dust proof as per IP-55	Weather and dust proof as per IP-55	CS/304 SS leak proof
12	Zero/span adjustment	Provided	Provided	--
13	Identification	Engraved with service legend or laminated phenolic name plate		
14	Accessories	Blow out disc, siphon, snubber, pulsation dampener, chemical seal (if required by process) gauge isolation valve	SS Thermowell	Gasket for all KEL-F shield for transparent type vent and drain valves of Steel/SS as per CS/Alloy process Requirement.
Notes:-				
*Bicolour type level gauges will be provided for applications involving steam and water except for condensate and feed water services.				
Length of gauge glass shall not be more than 1400 mm. If the vessel is higher, multiple gauge glasses with 50 mm overlapping shall be provided.				
Where the process fluids are corrosive, viscous, solid bearing or slurry type, diaphragm seals shall be provided. Parts below the diaphragm shall be removable for cleaning. The entire volume above the diaphragm shall be completely filled with an inert liquid suitable for the application.				
5.00.00	PROCESS ACTUATED SWITCHES			
	FEATURES	ESSENTIAL / MINIMUM REQUIREMENTS		
		Pressure/ Draft Switches/ DP Switches	Temperature switches	Level switches
	Sensing Element	Piston actuated for high pressure and diaphragm or bellows for low pr./ vacuum.	Vapor pressure sensing, liquid filled bellow type with SS bulb and capillary (5 m minimum, to suit application)	Capacitance types, float type, conductivity type, RF type, Ultrasonic type as per suitability to the application.
	Material	316 SS	Bulb 316 SS/ capillary 304 SS	316 SS
	End connection	½ inch NPT (F)	½ inch NPT (F)	Manufacturer standard
LOT-2 PROJECTS FLUE GAS DESULPHURISATION (FGD) SYSTEM PACKAGE	TECHNICAL SPECIFICATION SECTION – VI BID DOC. NO.:CS-0011-109(2)-9	PART-B SUB-SECTION-III-C2 MEASURING INSTRUMENTS	PAGE 14 OF 40	



CLAUSE NO.	TECHNICAL REQUIREMENTS				
6.00.00	Over range/ proof pressure	150% of maximum operating pr.	-	150% of maximum operating pr.	
	Repeatability	+/- 0.5% of full range			
	No. of contacts	2 NO+ 2NC SPDT snap action dry contact			
	Rating of contacts	60 V DC, 6 VA (or more if required by DDCMIS)			
	Elect. Connection	Plug in socket.			
	Set point adjustment	Provided over full range.			
	Dead band adjustment	Adjustable/ fixed as per requirement of application.			
	Enclosure	Weather and dust proof as per IP-55, metallic housing.			
	Accessories	Siphon, snubber, chemical seal, pulsation dampeners as required by process	Thermo well of 316 SS and packing glands	All mounting accessories	
	Mounting	Suitable for enclosure/ rack mounting or direct mounting	Suitable for rack mounting or direct mounting	-	
	Power Supply (wherever required)	As per Contractor's Standard practice.			
	Notes :-	<p>1) Where the process fluids are corrosive, viscous, solid bearing or slurry type, diaphragm seals shall be provided. Parts below the diaphragm shall be removable for cleaning. The entire volume above the diaphragm shall be completely filled with an inert liquid suitable for the application.</p> <p>2) Pressure/ Diff pressure switches for very low press/ DP measurements can have sensor material other than SS316 in case of any technical limitation and the offered product is standard product of the manufacture for very low pressure applications.</p> <p>3) Repeatability can be upto +/-1% of full range in case of switches with diaphragm seals or very low pressure/DP range.</p> <p>4) The specifications of switches for air conditioning & ventilation system / process can be as per system manufacturer's standards. The manufacturer shall submit the adequate supporting documents for establishing their standard practice.</p>			
	6.00.00	<p>SOLENOID VALVES</p> <p>Solenoid valves shall fulfill the following requirements: -</p>			
<p>LOT-2 PROJECTS FLUE GAS DESULPHURISATION (FGD) SYSTEM PACKAGE</p>	<p>TECHNICAL SPECIFICATION SECTION – VI BID DOC. NO.:CS-0011-109(2)-9</p>	<p>PART-B SUB-SECTION-III-C2 MEASURING INSTRUMENTS</p>	<p>PAGE 15 OF 40</p>		



CLAUSE NO.	TECHNICAL REQUIREMENTS			
7.00.00	<p>Type 2/3/4 way SS 316/ forged brass (depending on the application subject to Employer's approval during detailed engg.)</p> <p>Power supply 24V DC.</p> <p>Plug in connector connection.</p> <p>Insulation : Class "H"</p> <p>Limit switches</p> <p>Limit switches shall be silver plated with high conductivity and non-corrosive type. Contact rating shall be sufficient to meet the requirement of Fire alarm Control System subject to a minimum of 60V, 6VA rating. Protection class shall be IP-55.</p>			
<p>LOT-2 PROJECTS FLUE GAS DESULPHURISATION (FGD) SYSTEM PACKAGE</p>	<p>TECHNICAL SPECIFICATION SECTION – VI BID DOC. NO.:CS-0011-109(2)-9</p>	<p>PART-B SUB-SECTION-III-C2 MEASURING INSTRUMENTS</p>	<p>PAGE 16 OF 40</p>	



CLAUSE NO.	TECHNICAL REQUIREMENTS			
7.00.00	<p>Type 2/3/4 way SS 316/ forged brass (depending on the application subject to Employer's approval during detailed engg.)</p> <p>Power supply 24V DC.</p> <p>Plug in connector connection.</p> <p>Insulation : Class "H"</p> <p>Limit switches</p> <p>Limit switches shall be silver plated with high conductivity and non-corrosive type. Contact rating shall be sufficient to meet the requirement of Fire alarm Control System subject to a minimum of 60V, 6VA rating. Protection class shall be IP-55.</p>			
9.00.00	SPECIFICATION FOR FLOW ELEMENTS			
9.01.00	<p>Orifice Plate</p> <p>Features</p> <p>Type</p> <p>Material</p> <p>Thickness</p> <p>Material of branch pipe</p>	<p>Essential/Minimum Requirements</p> <p>Concentric as per ASME PTC-19.5 (Part-II), ISA RP-3.2, 1960 or BS-1042, ISO 5167</p> <p>316 SS</p> <p>3 mm for main pipe diameter up to 300 mm and 6 mm for main pipe dia above 300 mm.</p> <p>Same as main pipe</p>		
<p>LOT-2 PROJECTS FLUE GAS DESULPHURISATION (FGD) SYSTEM PACKAGE</p>	<p>TECHNICAL SPECIFICATION SECTION – VI BID DOC. NO.:CS-0011-109(2)-9</p>	<p>PART-B SUB-SECTION-III-C2 MEASURING INSTRUMENTS</p>	<p>PAGE 16 OF 40</p>	

THIS IS PART OF TECHNICAL SPECIFICATION PE-TS-468-571-A901 REV 00.



CLAUSE NO.	TECHNICAL REQUIREMENTS			
	Root valve type Root valve material Root valve size Impulse pipe of same material up to root valve Tappings Beta Ratio Beta Ratio calculation to be submitted Assembly drg. and flow Vs DP Curves Accessories Contractor shall submit certified flow calculation and differential pressure vs. flow curves for each element for Employer's approval. Sizing calculation, precise flow calculation for all the flow elements, fabrication and assembly drawings and installation drawings shall be submitted for Employer's approval.	Globe Same as pipe material 1 / 2 inch or 1 inch (as applicable) Required Flanged weld neck or D & D/2 with 3 pairs of tapping (as applicable). Root valves to be provided in all the tappings. However for flow elements in CPU, DM & PT plant- 2 Pairs of Tappings shall be provided as minimum. 0.34 to 0.7 Yes Yes Root valves, flanges, Vent/drain hole(As required)		
LOT-2 PROJECTS FLUE GAS DESULPHURISATION (FGD) SYSTEM PACKAGE	TECHNICAL SPECIFICATION SECTION – VI BID DOC. NO.:CS-0011-109(2)-9	PART-B SUB-SECTION-III-C2 MEASURING INSTRUMENTS	PAGE 17 OF 40	

CLAUSE NO.	TECHNICAL REQUIREMENTS																													
9.04.00	ROTAMETERS <table border="1" data-bbox="383 241 1341 716"> <thead> <tr> <th data-bbox="383 241 493 289">Sr. No.</th> <th data-bbox="493 241 711 289">Features</th> <th data-bbox="711 241 1341 289">Essential / minimum requirements</th> </tr> </thead> <tbody> <tr> <td data-bbox="383 289 493 331">1.</td> <td data-bbox="493 289 711 331">Type</td> <td data-bbox="711 289 1341 331">Variable Area Metal Tube</td> </tr> <tr> <td data-bbox="383 331 493 373">2.</td> <td data-bbox="493 331 711 373">Fluid media</td> <td data-bbox="711 331 1341 373">Water/oil</td> </tr> <tr> <td data-bbox="383 373 493 415">3.</td> <td data-bbox="493 373 711 415">Tube body</td> <td data-bbox="711 373 1341 415">SS316</td> </tr> <tr> <td data-bbox="383 415 493 457">4.</td> <td data-bbox="493 415 711 457">Material of float</td> <td data-bbox="711 415 1341 457">316 SS</td> </tr> <tr> <td data-bbox="383 457 493 499">5.</td> <td data-bbox="493 457 711 499">Indicator</td> <td data-bbox="711 457 1341 499">Linear scale</td> </tr> <tr> <td data-bbox="383 499 493 583">6.</td> <td data-bbox="493 499 711 583">Accessories</td> <td data-bbox="711 499 1341 583">Flange, orifice in case of bypass Rota meter (for line size above 100 mm)</td> </tr> <tr> <td data-bbox="383 583 493 657">7.</td> <td data-bbox="493 583 711 657">Housing protection class</td> <td data-bbox="711 583 1341 657">IP-55</td> </tr> <tr> <td data-bbox="383 657 493 716">8.</td> <td data-bbox="493 657 711 716">Accuracy</td> <td data-bbox="711 657 1341 716">± 2% of measured value.</td> </tr> </tbody> </table>			Sr. No.	Features	Essential / minimum requirements	1.	Type	Variable Area Metal Tube	2.	Fluid media	Water/oil	3.	Tube body	SS316	4.	Material of float	316 SS	5.	Indicator	Linear scale	6.	Accessories	Flange, orifice in case of bypass Rota meter (for line size above 100 mm)	7.	Housing protection class	IP-55	8.	Accuracy	± 2% of measured value.
Sr. No.	Features	Essential / minimum requirements																												
1.	Type	Variable Area Metal Tube																												
2.	Fluid media	Water/oil																												
3.	Tube body	SS316																												
4.	Material of float	316 SS																												
5.	Indicator	Linear scale																												
6.	Accessories	Flange, orifice in case of bypass Rota meter (for line size above 100 mm)																												
7.	Housing protection class	IP-55																												
8.	Accuracy	± 2% of measured value.																												
10.00.00	ANALYSER INSTRUMENTS (OTHER THAN CEMS)																													
10.01.00	Common requirements:- <table border="1" data-bbox="383 856 1422 1766"> <tbody> <tr> <td data-bbox="383 856 456 999">1</td> <td data-bbox="456 856 672 999">Type</td> <td data-bbox="672 856 1422 999">Microprocessor based with self-indicating type diagnostic feature. Output signal: 4-20 mA DC galvanically isolated. Binary Signal: 2NO+2NC</td> </tr> <tr> <td data-bbox="383 999 456 1115">2</td> <td data-bbox="456 999 672 1115">Display</td> <td data-bbox="672 999 1422 1115">Digital display with reading in engineering units. Display of the measurement values as well as all the information required for checking/maintenance of the analyzer.</td> </tr> <tr> <td data-bbox="383 1115 456 1188">3</td> <td data-bbox="456 1115 672 1188">Zero & span Adjustment</td> <td data-bbox="672 1115 1422 1188">To be provided for all selectable ranges.</td> </tr> <tr> <td data-bbox="383 1188 456 1241">4</td> <td data-bbox="456 1188 672 1241">Ambient temp.</td> <td data-bbox="672 1188 1422 1241">0-50°C unless defined otherwise.</td> </tr> <tr> <td data-bbox="383 1241 456 1356">5</td> <td data-bbox="456 1241 672 1356">Analyser enclosure Type/Material</td> <td data-bbox="672 1241 1422 1356">Weather protection for analyser mounted inside analyser panel shall be IP-22 or better. For all other analysers, weather protection class shall be IP-55.</td> </tr> <tr> <td data-bbox="383 1356 456 1409">6</td> <td data-bbox="456 1356 672 1409">Calibration</td> <td data-bbox="672 1356 1422 1409">Auto & Manual (from Remote).</td> </tr> <tr> <td data-bbox="383 1409 456 1461">7</td> <td data-bbox="456 1409 672 1461">Power Supply</td> <td data-bbox="672 1409 1422 1461">To be arranged by Contractor subject to Employer's approval.</td> </tr> <tr> <td data-bbox="383 1461 456 1682">8</td> <td data-bbox="456 1461 672 1682">Others</td> <td data-bbox="672 1461 1422 1682">i) All interconnection tubing and cabling between probe and analyser / analyser panel and cabling from analyser/ analyser panel to FGD Control system are to be provided by Contractor. ii) All the calibration gases (certified cylinder) required for one year continuous operation shall be provided. The calibration gas container material shall not contaminate the calibration gas.</td> </tr> <tr> <td data-bbox="383 1682 456 1766">9</td> <td data-bbox="456 1682 672 1766">Compliance to standards</td> <td data-bbox="672 1682 1422 1766">USEPA, TUV, MCERTS or equivalent standards</td> </tr> </tbody> </table>			1	Type	Microprocessor based with self-indicating type diagnostic feature. Output signal: 4-20 mA DC galvanically isolated. Binary Signal: 2NO+2NC	2	Display	Digital display with reading in engineering units. Display of the measurement values as well as all the information required for checking/maintenance of the analyzer.	3	Zero & span Adjustment	To be provided for all selectable ranges.	4	Ambient temp.	0-50°C unless defined otherwise.	5	Analyser enclosure Type/Material	Weather protection for analyser mounted inside analyser panel shall be IP-22 or better. For all other analysers, weather protection class shall be IP-55.	6	Calibration	Auto & Manual (from Remote).	7	Power Supply	To be arranged by Contractor subject to Employer's approval.	8	Others	i) All interconnection tubing and cabling between probe and analyser / analyser panel and cabling from analyser/ analyser panel to FGD Control system are to be provided by Contractor. ii) All the calibration gases (certified cylinder) required for one year continuous operation shall be provided. The calibration gas container material shall not contaminate the calibration gas.	9	Compliance to standards	USEPA, TUV, MCERTS or equivalent standards
1	Type	Microprocessor based with self-indicating type diagnostic feature. Output signal: 4-20 mA DC galvanically isolated. Binary Signal: 2NO+2NC																												
2	Display	Digital display with reading in engineering units. Display of the measurement values as well as all the information required for checking/maintenance of the analyzer.																												
3	Zero & span Adjustment	To be provided for all selectable ranges.																												
4	Ambient temp.	0-50°C unless defined otherwise.																												
5	Analyser enclosure Type/Material	Weather protection for analyser mounted inside analyser panel shall be IP-22 or better. For all other analysers, weather protection class shall be IP-55.																												
6	Calibration	Auto & Manual (from Remote).																												
7	Power Supply	To be arranged by Contractor subject to Employer's approval.																												
8	Others	i) All interconnection tubing and cabling between probe and analyser / analyser panel and cabling from analyser/ analyser panel to FGD Control system are to be provided by Contractor. ii) All the calibration gases (certified cylinder) required for one year continuous operation shall be provided. The calibration gas container material shall not contaminate the calibration gas.																												
9	Compliance to standards	USEPA, TUV, MCERTS or equivalent standards																												
LOT-2 PROJECTS FLUE GAS DESULPHURISATION (FGD) SYSTEM PACKAGE	TECHNICAL SPECIFICATION SECTION – VI BID DOC. NO.:CS-0011-109(2)-9	PART-B SUB-SECTION-III-C2 MEASURING INSTRUMENTS	PAGE 19 OF 40																											



CLAUSE NO.	TECHNICAL REQUIREMENTS		
	10	Type of Technology	<p>SO₂/NO_x :- Hot-extractive sampling type/ Dilution Extractive/ In-situ (Path) type</p> <p>Note:- For Hot extractive sampling type and Dilution extractive sampling type system – The components involved in sample handling system shall be imported & further, Sample handling system design shall be vetted by Original Analyzer Manufacturer (OAM). Necessary documents shall be furnished during detailed engineering in order to establish the above requirement. Technical expert of OAM shall witness testing of sample handling system and validate it. Alternatively sampling handling system assembled at Original Analyzer manufacturer (OAM) works shall also be accepted.</p>
	11	Measurement range, tapping point	As per FGD system design and process parameters.
<p>LOT-2 PROJECTS FLUE GAS DESULPHURISATION (FGD) SYSTEM PACKAGE</p>	<p>TECHNICAL SPECIFICATION SECTION – VI BID DOC. NO.:CS-0011-109(2)-9</p>		<p>PART-B SUB-SECTION-III-C2 MEASURING INSTRUMENTS</p>
<p>PAGE 20 OF 40</p>			

THIS IS PART OF TECHNICAL SPECIFICATION PE-TS-468-571-A901 REV 00.



CLAUSE NO.	TECHNICAL REQUIREMENTS		
10.05.00	pH Analyser		
LOT-2 PROJECTS FLUE GAS DESULPHURISATION (FGD) SYSTEM PACKAGE	TECHNICAL SPECIFICATION SECTION – VI BID DOC. NO.:CS-0011-109(2)-9	PART-B SUB-SECTION-III-C2 MEASURING INSTRUMENTS	PAGE 22 OF 40

THIS IS PART OF TECHNICAL SPECIFICATION PE-TS-468-571-A901 REV 00.



CLAUSE NO.

TECHNICAL REQUIREMENTS

a)	Type	: Cell - flow through
b)	Accuracy	: $\pm 1\%$ of reading
c)	Range	: 0 - 14 pH freely programmable (For others)
d)	No. of steams	: Single
e)	Temp. compensation	: Automatic



CLAUSE NO.	TECHNICAL REQUIREMENTS		
14.05.00	<p>Electronic Flow-Meter</p> <p>The electronic flow meter shall include flow sensor and flow indicator cum integrator / totaliser and shall include all required accessories for satisfactory operation. The flow meter shall be based on full bore electromagnetic principle and shall be electronic type of proven design, make and model acceptable to the owner.</p> <p>The Bidder shall submit all necessary technical literature and details of selection criteria of the instrument offered to substantiate the model selected. The Bidder shall also furnish list of similar installation along with feedback on satisfactory performance of the instruments.</p> <p>The flow meter shall meet or exceed the following requirement :</p> <p>(a) Output : 4-20 mA DC Isolated output</p> <p>(b) Accuracy : $\pm 0.5\%$ of calibrated span or better *</p> <p>(c) Repeatability : $\pm 0.2\%$ of calibrated span or better</p> <p>(d) Power Supply : 240V AC $\pm 10\%$, 50 HZ $\pm 5\%$/ 24 V DC, to be arranged by the contractor.</p> <p>(f) Protection class : IP-55</p> <p>(e) Flow tube : SS304</p> <p>(f) liner : Hard Rubber</p> <p>The flow meter shall provide local indication for instantaneous flow. It should also be possible to get local display for daily and monthly discharge. The flow meter shall indicate totaliser/ integrator to get the daily and monthly discharge as stated above.</p>		
<p>LOT-2 PROJECTS FLUE GAS DESULPHURISATION (FGD) SYSTEM PACKAGE</p>	<p>TECHNICAL SPECIFICATION SECTION – VI BID DOC. NO.:CS-0011-109(2)-9</p>	<p>PART-B SUB-SECTION-III-C2 MEASURING INSTRUMENTS</p>	<p>PAGE 40 OF 40</p>



CLAUSE NO.	TECHNICAL REQUIREMENTS		
<p>1.00.00</p> <p>1.01.00</p> <p>1.02.00</p> <p>1.02.01</p> <p>1.02.02</p> <p>2.00.00</p> <p>2.01.00</p> <p>2.01.01</p> <p>2.01.02</p> <p>2.02.00</p> <p>2.03.00</p>	<p>GENERAL:</p> <p>Actuators shall be designed for valve operation to ensure proper function in accordance with specifications given below and complying to EN15714-2 or equivalent. All standards, specifications and codes of practice referred to herein shall be the latest editions including all applicable official amendments and revisions.</p> <p>This sub-section of specification is applicable for following types of electric actuators:</p> <p>Modulating duty electric actuators:</p> <p>These shall be provided as per standard practice of OEM of equipment, meeting other requirements of specifications. For specifications of Blade pitch actuators, refer clause no. 5.00.00 of this chapter.</p> <p>Electric actuators for valves/ dampers/ gates (other than covered in 1.02.01):</p> <p>These actuators shall be Non-Intrusive type electric actuators. The interface of these actuators with DDCMIS shall be of two types viz. with Hardwired interface and with Fieldbus interface. The common requirements of both these type of actuators are specified at clause 2.00.00, specific requirements of Non-Intrusive hardwired actuators are specified at clause 3.00.00 and specific requirements of Non-Intrusive fieldbus actuators are specified at clause 4.00.00. The applications where these two types of actuators are to be provided is specified in Part-A of Technical Specifications.</p> <p>COMMON REQUIREMENTS FOR NON INTRUSIVE ELECTRIC ACTUATORS</p> <p>TYPE:</p> <p>The actuators shall have integral starters with built in SPP (Single Phasing Preventer). 415 V, 3 phase 3 wire power supply shall be given to the actuator from switch board as applicable through a switch fuse unit. Control voltage of the motor starter shall be 110 V AC / 24 V DC, derived suitably from 415V power supply.</p> <p>The actuators shall be Non- Intrusive electric actuator. All actuator settings including torque, limit shall be possible without opening the actuator cover and LCD indication shall be available integral to actuator body.</p> <p>RATING:</p> <p>(a) Supply Voltage & frequency: 415V +/- 10%, 3 Phase, 3 Wire & 50HZ +/-5%.</p> <p>(b) Sizing:</p> <p>Open/Close at rated speed against designed differential pressure at 90% of rated voltage.</p> <p>For ON/OFF type: Three successive open-close operations or 15 minutes, whichever is higher.</p> <p>For inching type: 150 starts per hour or required cycles, whichever is higher.</p> <p>CONSTRUCTION:</p> <p>(a) Enclosure:</p> <p>Totally enclosed weatherproof, minimum IP-68 degree of protection.</p> <p>(b) Manual Wheel:</p> <p>Shall disengage automatically during motor operation.</p>		
<p>LOT-2 PROJECTS FLUE GAS DESULPHURISATION (FGD) SYSTEM PACKAGE</p>	<p>TECHNICAL SPECIFICATION SECTION – VI BID DOC. NO.:CS-0011-109(2)-9</p>	<p>PART-B SUB-SECTION-III-C8 ELECTRIC ACTUATORS</p>	<p>PAGE 1 OF 4</p>



CLAUSE NO.	TECHNICAL REQUIREMENTS		
2.04.00	<p>MOTOR:</p> <p>(a) Type : Squirrel cage induction motor suitable for Direct On Line (DOL)starting.</p> <p>(b) Enclosure: Totally enclosed, self-ventilated.</p> <p>(c) Insulation Class F. Temperature rise 70 Deg C. over 50 Deg C ambient.</p> <p>(d) Bearings: Double shielded, grease lubricated antifriction.</p> <p>(e) Earth Terminals: Two</p> <p>(f) Protection: Single Phasing Protection, Over heating protection through Thermostat (as applicable) and wrong phase sequence protection shall be provided over and above other protection features standard to bidder's design. Suitable means shall be provided to diagnose the type of fault locally.</p>		
2.05.00	<p>POSITION/TORQUE TRANSMITTER:</p> <p>The Position/ Limit measurement shall be done using absolute encoders which will give information of position/ limit in both the directions. Electronic measurement of torque shall be provided.</p>		
2.06.00	<p>LOCAL OPERATION:</p> <p>It shall be possible to operate the actuator locally also. Lockable local/remote selection shall be provided on the actuator.</p>		
2.07.00	<p>LCD DISPLAY:</p> <p>A local LCD display shall be provided to give information regarding actuator alarms, status and valve position indications as a minimum in local.</p>		
2.08.00	<p>WIRING:</p> <p>Suitable voltage grade copper wire.</p>		
2.09.00	<p>TERMINAL BLOCK:</p> <p>For power cables, the grade of TBs shall be minimum 650V.</p>		
2.10.00	<p>ACCESSORIES:</p> <p>All required accessories (if applicable) for calibration / settings/ configuration of various parameters of actuator shall be provided. For quantities, please refer Part A of technical specifications.</p>		
<p>LOT-2 PROJECTS FLUE GAS DESULPHURISATION (FGD) SYSTEM PACKAGE</p>	<p>TECHNICAL SPECIFICATION SECTION – VI BID DOC. NO.:CS-0011-109(2)-9</p>	<p>PART-B SUB-SECTION-III-C8 ELECTRIC ACTUATORS</p>	<p>PAGE 2 OF 4</p>



CLAUSE NO.	TECHNICAL REQUIREMENTS		
2.11.00	SIL CERTIFICATION: All actuators shall be certified for SIL 2 or better.		
3.00.00	SPECIFIC REQUIREMENTS FOR NON INTRUSIVE HARDWIRED ACTUATORS		
3.01.00	INTERFACES: For ON-OFF and INCHING type actuators interface with the control system shall be through hardwired signal only. <ul style="list-style-type: none"> (a) Open/Close command, open/ close status and disturbance monitoring signal (common contact for Overload, Thermostat, control supply failure, L/R selector switch at local & other protections operated) shall be provided hardwired. (b) The actuator shall be able to accept open/close command at 24V DC with max. 2.5VA load from control system. Accordingly suitable isolated interface in the actuator shall be provided. (c) Open/close command termination logic shall be suitably built inside actuator. (d) For typical wiring diagram Refer Tender Drawing No. 0000-999-POI-A-063 (Except plug & socket connector, if not applicable) 		
3.02.00	TERMINAL BOX: Suitable terminals/ connectors, integral to actuator, for terminating instrumentation & power cables shall be provided. Necessary glands for power cables and instrumentation cables shall be provided.		
4.00.00	SPECIFIC REQUIREMENTS FOR NON INTRUSIVE FIELDBUS ACTUATORS		
4.01.00	INTERFACES: For ON-OFF and INCHING type actuators interface with the control system shall be through fieldbus network. <ul style="list-style-type: none"> (a) Open/ close commands, open/ close feedback status, disturbance signal etc. shall be available to the Control System through the fieldbus network along with diagnostics. The detailed diagnostics including the actuator operating data shall be available to the DDCMIS through the fieldbus network. (b) All actuators shall be Foundation Fieldbus/ Profibus compatible. However the exact protocol shall be based on finalized protocol of DDCMIS. If Profibus DP protocol is envisaged then actuator shall have two (redundant) Profibus DP ports for connecting the redundant Profibus DP cables. That is if one profibus cable is cut or not working/ not available, then complete actuator functionality shall be available through the second redundant cable without any manual intervention. (c) Open/close command termination logic shall be suitably built inside actuator. 		
LOT-2 PROJECTS FLUE GAS DESULPHURISATION (FGD) SYSTEM PACKAGE	TECHNICAL SPECIFICATION SECTION – VI BID DOC. NO.:CS-0011-109(2)-9	PART-B SUB-SECTION-III-C8 ELECTRIC ACTUATORS	PAGE 3 OF 4



CLAUSE NO.

TECHNICAL REQUIREMENTS

4.02.00

TERMINAL BOX:

Suitable terminals/ connectors, integral to actuator, for terminating fieldbus cables and power cables shall be provided. Necessary glands for power cables and armored fieldbus cables shall be provided.

LOT-2 PROJECTS
FLUE GAS DESULPHURISATION (FGD)
SYSTEM PACKAGE

TECHNICAL SPECIFICATION
SECTION – VI
BID DOC. NO.:CS-0011-109(2)-9

PART-B
SUB-SECTION-III-C8 ELECTRIC
ACTUATORS

PAGE
4 OF 4

THIS IS PART OF TECHNICAL SPECIFICATION PE-TS-468-571-A901 REV 00.



CLAUSE NO.	TECHNICAL REQUIREMENTS		
	CONTROL VALVES, ACTUATORS & ACCESSORIES		
1.00.00	CONTROL VALVES & ACCESSORIES		
1.01.00	General Requirements		
1.01.01	The control valves and accessories equipment furnished by the Bidder shall be designed, constructed and tested in accordance with the latest applicable requirements of code for pressure piping ANSI B 31.1, the ASME Boiler & pressure vessel code, Indian Boiler Regulation (IBR), ISA, and other standards specified elsewhere as well as in accordance with all applicable requirements of the “Federal Occupational Safety and Health Standards, USA” or acceptable equal standards. All the Control Valves, their actuators and accessories to be furnished under this Sub-section will be fully suitable and compatible with the modulating loops covered under the Specification.		
1.01.02	All the control valves and accessories offered by the Bidder, shall be from reputed, experienced manufacturers of specified type and range of valves.		
1.02.00	CONTROL VALVE SIZING & CONSTRUCTION		
1.02.01	The design of all valve bodies shall meet the specification requirements and shall conform to the requirements of ANSI (USA) for dimensions, material thickness and material specification for their respective pressure classes.		
1.02.02	The valve sizing shall be suitable for obtaining maximum flow conditions with valve opening at approximately 80% of total valve stem travel and minimum flow conditions with valve stem travel not less than 10% of total valve stem travel. All the valves shall be capable of handling at least 120% of the required maximum flow. Further, the valve stem travel range from minimum flow condition to maximum flow condition shall not be less than 50% of the total valve stem travel. The sizing shall be in accordance with the latest edition of ISA handbook on control valves. While deciding the size of valves, Bidder shall ensure that valves trim exit outlet velocity as defined in ISA handbook does not exceed 8 m/sec for liquid services, 150 m/sec. for steam services and 50% of sonic velocity for flashing services. Bidder shall furnish the sizing calculations clearly indicating the outlet velocity achieved with the valve size selected by him as well as noise calculations, which will be subject to Employer’s approval during detailed engineering.		
1.02.03	Control valves for steam and water applications shall be designed to prevent cavitation, wire drawing, flashing on the downstream side of valve and down stream piping. Thus for cavitation/flashing service, only valve with anti cavitation trim shall be provided. Detailed calculations to establish whether cavitation will occur or not for any given application shall be furnished.		
1.02.04	Control valves shall have leakage rate as per leakage Class-IV.		
LOT-2 PROJECTS FLUE GAS DESULPHURISATION (FGD) SYSTEM PACKAGE	TECHNICAL SPECIFICATION SECTION – VI BID DOC. NO.:CS-0011-109(2)-9	PART-B SUB-SECTION-III-C7 CONTROL VALVES, ACTUATORS & ACCESSORIES	PAGE 1 OF 5

THIS IS PART OF TECHNICAL SPECIFICATION PE-TS-468-571-A901 REV 00.



CLAUSE NO.	TECHNICAL REQUIREMENTS		
1.02.05	The control valve induced noise shall be limited to 85 dBA at 1 meter from the valve surface under actual operating conditions. The noise abatement shall be achieved by valve body and trim design and not by use of silencers.		
2.00.00	VALVE CONSTRUCTION		
2.01.00	All valves shall be of globe /Butterfly body design & straightaway pattern with single or double port, unless other wise specified or recommended by the manufacturer to be of angle body type. Rotary valve may alternatively be offered when pressure and pressure drops permit.		
2.02.00	Valves with high lift cage guided plugs & quick-change trims shall be supplied.		
2.03.00	Cast Iron valves are not acceptable.		
2.04.00	Bonnet joints for all control valves shall be of the flanged and bolted type or other construction acceptable to the Employer. Bonnet joints of the internal threaded or union type will not be acceptable.		
2.05.00	Plug shall be of one-piece construction cast, forged or machined from solid bar stock. Plug shall be screwed and pinned to valve stems or shall be integral with the valve stems.		
2.06.00	All valves connected to vacuum on down stream side shall be provided with packing suitable for vacuum applications (e.g. double vee type chevron packing)		
2.07.00	Valve characteristic shall match with the process characteristics.		
2.08.00	Extension bonnets shall be provided when the maximum temperature of flowing fluid is greater than 280 deg. C.		
2.09.00	Flanged valves shall be rated at no less then ANSI press class of 300 lbs.		
3.00.00	<p>VALVE MATERIALS</p> <p>Refer mechanical sections for body and trim materials. The exact body and trim materials shall be finalised during detailed engineering depending on the service applications.</p> <p>However, Bidder may offer valves with body and trim materials better than specified materials and in such cases Bidder shall furnish the comparison of properties including cavitation resistance, hardness, tensile strength, strain energy, corrosion resistance and erosion resistance etc. of the offered material vis-a-vis the specified material for Employer's consideration and approval.</p>		
<p>LOT-2 PROJECTS FLUE GAS DESULPHURISATION (FGD) SYSTEM PACKAGE</p>	<p>TECHNICAL SPECIFICATION SECTION – VI BID DOC. NO.:CS-0011-109(2)-9</p>	<p>PART-B SUB-SECTION-III-C7 CONTROL VALVES, ACTUATORS & ACCESSORIES</p>	<p>PAGE 2 OF 5</p>



CLAUSE NO.	TECHNICAL REQUIREMENTS															
4.00.00	<p>END PREPARATION</p> <p>Valve body ends shall be either butt welded/socket welded, flanged (Rubber lined for condensate service) or screwed as finalised during detailed engineering and as per Employer's approval. The welded ends wherever required shall be butt welded type as per ANSI B 16.25 for control valves of sizes 65 mm and above. For valves size 50 mm and below welded ends shall be socket welded as per ANSI B 16.11. Flanged ends wherever required shall be of ANSI pressure-temperature class equal to or greater than that of the control valve body.</p>															
5.00.00	<p>VALVE ACTUATORS</p> <p>All Control Valves shall be furnished with Pneumatic Actuators. The Bidder shall be responsible for proper selection and sizing of valve actuators in accordance with the pressure drop and maximum shut off pressure and leakage class requirements. The valve actuators shall be capable of operating at 60 deg.C continuously.</p> <p>Valve actuators and stems shall be adequate to handle the unbalanced forces occurring under the specified flow conditions or the maximum differential pressure specified. An adequate allowance for stem force, at least 0.15 Kg/sq.cm. per linear millimeter of seating surface, shall be provided in the selection of the actuator to ensure tight seating unless otherwise specified.</p> <p>The travel time of the pneumatic actuators shall not exceed 10 seconds.</p>															
6.00.00	<p>CONTROL VALVE ACCESSORY DEVICES</p>															
6.01.00	<p>All pneumatically actuated control valve accessories such as air locks, hand wheels/hand-jacks, limit switches, Microprocessor based Positioner, diffusers, external volume chambers, position transmitters (capacitance or resistance type only), reversible pilot for Positioner, tubing and air sets, solenoid valves and junction boxes etc. shall be provided as per the requirements.</p>															
7.00.00	<p>SPECIFICATIONS FOR MICROPROCESSOR BASED POSITIONERS</p> <table border="1" data-bbox="412 1360 1458 1766"> <tbody> <tr> <td data-bbox="412 1360 483 1423">1</td> <td data-bbox="483 1360 651 1766" rowspan="4">Electrical</td> <td data-bbox="651 1360 911 1423">a) Input signal</td> <td data-bbox="911 1360 1458 1423">4-20 mA</td> </tr> <tr> <td data-bbox="412 1423 483 1528"></td> <td data-bbox="651 1423 911 1528">b) Power Supply</td> <td data-bbox="911 1423 1458 1528">Loop powered from the output card of control system.</td> </tr> <tr> <td data-bbox="412 1528 483 1665"></td> <td data-bbox="651 1528 911 1665">c) Hart Protocol</td> <td data-bbox="911 1528 1458 1665">Compatibility for remote calibration & diagnostics (Super-imposed Hart signal on input signal (4-20 mA))</td> </tr> <tr> <td data-bbox="412 1665 483 1766"></td> <td data-bbox="651 1665 911 1766">d) Valve position sensing</td> <td data-bbox="911 1665 1458 1766">Non contact type position sensing with 4-20 mA output signal</td> </tr> </tbody> </table>			1	Electrical	a) Input signal	4-20 mA		b) Power Supply	Loop powered from the output card of control system.		c) Hart Protocol	Compatibility for remote calibration & diagnostics (Super-imposed Hart signal on input signal (4-20 mA))		d) Valve position sensing	Non contact type position sensing with 4-20 mA output signal
1	Electrical	a) Input signal	4-20 mA													
		b) Power Supply	Loop powered from the output card of control system.													
		c) Hart Protocol	Compatibility for remote calibration & diagnostics (Super-imposed Hart signal on input signal (4-20 mA))													
		d) Valve position sensing	Non contact type position sensing with 4-20 mA output signal													
<p>LOT-2 PROJECTS FLUE GAS DESULPHURISATION (FGD) SYSTEM PACKAGE</p>		<p>TECHNICAL SPECIFICATION SECTION – VI BID DOC. NO.:CS-0011-109(2)-9</p>	<p>PART-B SUB-SECTION-III-C7 CONTROL VALVES, ACTUATORS & ACCESSORIES</p>	<p>PAGE 3 OF 5</p>												



CLAUSE NO.	TECHNICAL REQUIREMENTS			
2	Environment	a) Operating Temp	(-)30 To 80 Deg. C	
		b) Humidity	0-95 %	
		c) Protection Class	IP-65 Minimum	
4	Test reports/ certificates	Factory Valve Signature Tests reports (Pr vs Valve travel and Travel vs I/P signal) are to be provided.		
		Test certificates as per Manufacture Standard/Relevant Standard are To Be Submitted		
5	Configuration/ calibration	Remote calibration, Auto & Manual calibration shall be possible. Universal HART Calibrator to be provided.		
6	Operating	Operating Range	Full range & split range signal.	
7	Modes	Valve Action	Direct & Reverse valve action(selectable)	
		Flow Characterization	Possible to fit valve characteristic curve - Linear & Equal Percentage.	
8.	Fail Safe/Fail Freeze	Fail safe/Fail freeze feature is to be provided. (In case, the fail freeze feature is not intrinsic to the positioner, Bidder shall achieve the same externally through solenoid valve connected in the pneumatic circuit).		
9	Pneumatic	Air capacity	Sufficient to handle the valves selected/ boosters to be supplied if required.	
		Air supply pressure	To suit air supply pressure/quality available.	
		Process connection	1/4 inch NPT	
10	Electrical Cable Entry	1/2-NPT, side or bottom entry to avoid water ingress.		
11	Performance	Characteristic Deviation	<=0.5 % Of Span	
LOT-2 PROJECTS FLUE GAS DESULPHURISATION (FGD) SYSTEM PACKAGE		TECHNICAL SPECIFICATION SECTION – VI BID DOC. NO.:CS-0011-109(2)-9	PART-B SUB-SECTION-III-C7 CONTROL VALVES, ACTUATORS & ACCESSORIES	PAGE 4 OF 5

THIS IS PART OF TECHNICAL SPECIFICATION PE-TS-468-571-A901 REV 00.



CLAUSE NO.	TECHNICAL REQUIREMENTS								
		Ambient Temp Effect	<=0.01 %/Deg C Or Better						
	12	EMC & CE Compliance	Required To International Standard Like EN/IEC. En50081-2& En50082 Or Equivalent						
	13	Accessories	<table border="1"> <tr> <td data-bbox="651 472 852 604">In-built operator panel</td> <td data-bbox="852 472 1458 604">Display with push buttons for configuration and display on the Positioner itself (password protected/hardware lock).</td> </tr> <tr> <td data-bbox="651 604 852 709">Press gauge block</td> <td data-bbox="852 604 1458 709">For supply & output pressure.</td> </tr> <tr> <td data-bbox="651 709 852 808">Mounting assembly</td> <td data-bbox="852 709 1458 808">On as required basis.</td> </tr> </table>	In-built operator panel	Display with push buttons for configuration and display on the Positioner itself (password protected/hardware lock).	Press gauge block	For supply & output pressure.	Mounting assembly	On as required basis.
In-built operator panel	Display with push buttons for configuration and display on the Positioner itself (password protected/hardware lock).								
Press gauge block	For supply & output pressure.								
Mounting assembly	On as required basis.								
8.00.00	<p>TEST AND EXAMINATION</p> <p>All valves shall be tested in accordance with the quality assurance programme agreed between the Employer and Contractor, which shall meet the requirements of IBR and other applicable codes mentioned elsewhere in the specifications. The tests shall include but not be limited to the following:</p> <p>8.01.00 Non Destructive Test as per ANSI B-16.34.</p> <p>8.02.00 Hydrostatic shell test in accordance with ANSI B 16.34 prior to seat leakage test.</p> <p>8.03.00 Valve closure test and seat leakage test in accordance with ANSI-B 16.34 and as per the leakage class indicated above.</p> <p>8.04.00 Functional Test: The fully assembled valves including actuators control devices and accessories shall be functionally tested to demonstrate times from open to close position.</p> <p>8.05.00 CV Test: Refer Cl.no 3.00.00 (8) Subsection IIIC-06 (Type test requirements)</p> <p>9.00.00 CONTROL VALVE QUANTITIES</p> <p>Bidder shall furnish all the control valves under this package as finalised during detailed engineering stage without any price repercussions whatsoever depending on the process requirements. All the control valves provided by the Bidder for this project shall meet the specifications requirements specified herein. Specification for control valves in this Sub-section has to be read in conjunction with other relevant Sub-sections of this specification.</p>								
LOT-2 PROJECTS FLUE GAS DESULPHURISATION (FGD) SYSTEM PACKAGE	TECHNICAL SPECIFICATION SECTION – VI BID DOC. NO.:CS-0011-109(2)-9	PART-B SUB-SECTION-III-C7 CONTROL VALVES, ACTUATORS & ACCESSORIES	PAGE 5 OF 5						

VFD

Variable Frequency Drive (VFD)

1.00.00

GENERAL

The Design, manufacture, erection, testing and performance of items and services provided under this specification shall comply with the latest edition including all applicable official amendments and revisions as on date of award of the following standards. In case of conflict between this specification and code (IS Code, standards, etc.) referred herein, the former shall prevail. All work shall be carried out as per the following codes and standards.

2.00.00

CODES AND STANDARDS

HT breaker	IEC:60056
DC reactor	IEC 60289
Transformers	IS:2026, IEC: 60076 IEC 61378
Bushing	IS: 2099, IEC 60137
Adjustable Speed Electrical Power Drive Systems	IEC 61800
Semiconductor converters–General requirements	IEC 60146
IEEE Recommended practices and requirements for harmonic control in electrical power systems	IEEE 519
Degrees of protection provided by enclosures (IP Code)	IEC 60529
Electrostatic immunity test	IEC1000-4-2
Fast transient immunity test	IEC1000-4-4
Surge immunity test	IEC1000-4-5
High-voltage switchgear and controlgear; Pt.102: Alternating current disconnectors and earthing switches	IEC 62271-102
High-voltage switchgear and controlgear; Pt.200: AC metal-enclosed switchgear and controlgear for rated voltages above 1 kV and up to and including 52 KV	IS/IEC: 62271-200
AC electricity meters	IS: 722
Metal oxide surge arrester without gap for AC system	IEC: 60099-4
Terminal blocks for copper conductors	IEC: 60947-7-1
Dry transformer	IS: 11171
Motor	IEC 60034-18-41 &42, IEC60034 / NEMA 30 & 31,
Contactors/Switches/Fuses etc.	IEC:60947, IS: 13947
Harmonics & EM compatibility	IEEE:519/IEC: 61000
VFD	IEC:60034/ IEC: 61800

Equipment complying with other internationally accepted standards will also be considered if they ensure performance and constructional features equivalent or superior to standards listed above. In such a case, the Bidder shall clearly indicate

the standard(s) adopted, furnish a copy in English of the latest revision amendments and revision in force as on date of opening of bid and shall clearly bring out the salient features for comparison.

3.00.00 **OPERATING CONDITIONS**

3.01.00 For the purpose of design of equipment/systems, an ambient temperature of 50 deg. Centigrade and also relative humidity of 95% at 40 deg. Celsius shall be considered.

3.02.00 All equipment shall be suitable for rated frequency of 50 Hz with a variation of +3% & -5%, and 10% combined variation of voltage and frequency unless specifically brought out in the specification.

3.03.00 The auxiliary AC voltage supply arrangement shall have 11/6.6/3.3kV and 415V systems (as applicable). It shall be designed to limit voltage variations as given below under worst operating condition:

- 1. 11kV/ 3.3 kV/ 6.6 KV : +/- 6%
- 2. 415V : +/- 10%

Note: The Voltage level mentioned above is the Nominal Voltage available at the input of the VFD System from the MCC/ Switchgear/transformer, based on the system requirement/Availability.

The voltage level for the VFD output to be fed to motor shall be as follows:-

- 1. Upto 400 kW : 415V/690V, Low Voltage, Three Phase AC
- 2. Above 400kW and upto 700 KW : 690V, Low Voltage, Three Phase AC
- 3. Above 700KW : Medium Voltage

From here onwards in the specifications all the VFD Systems consisting of either 415 V or 690 V may be termed as LV VFD while the higher rated VFD System shall be termed as MV VFD. If nothing is mentioned than the Clause is applicable for both the LV and the MV VFD until deliberated otherwise.

4.00.00 **SYSTEM DESCRIPTION**

Type of drive 3-Phase Diode / Thyristor / Multi Stage IGBT / IGCT / SGCT/ IEGT

5.00.00 Type of Cooling of VFD Naturally air cooled/forced air cooled/Liquid cooled

Converter Type Full wave diode rectifier/active front end type

Inverter Type Thyristor/IGBT/IGCT/SGCT/IEGT

GENERAL REQUIREMENTS

5.01.00 **Medium Voltage VFD:** The Variable frequency drive (VFD) system shall be of a modern proven design for similar applications in power plants/industry. The system

<p>5.02.00</p> <p>5.03.00</p> <p>5.04.00</p> <p>5.05.00</p> <p>6.00.00</p> <p>6.01.00</p> <p>6.02.00</p> <p>6.03.00</p> <p>6.04.00</p>	<p>shall be either Current Source Inverter (CSI) or Voltage Source Inverter (VSI) type with minimum eighteen (18) pulse design.</p> <p>415 V/690 V LV VFD: The Variable frequency drive (VFD) system shall be of a modern proven design for similar applications in power plants/industry. The system shall be either Current Source Inverter (CSI) or Voltage Source Inverter (VSI) type with minimum Twelve (12) pulse design. For drives less than 100 KW Six (6) pulse can be offered meeting all other requirements.</p> <p>The system shall be fully digital, PLC/Microprocessor based, energy efficient, and shall provide very high reliability, high power factor, low harmonic distortion and low vibration and wear and noise. It shall be easy to install in minimum time and expense and no special tools shall be required for routine maintenance.</p> <p>The offered equipment shall be with state of art technology and proven field track record. No prototype equipment shall be offered.</p> <p>The VFD manufacturer shall ensure the proper coordination of their VFD with the Driven Motor and the supply system. All the Motors which are to be driven by VFDs will be of Inverter duty type. Also these motors shall comply the requirements stipulated in IEC: 60034-18-41 and IEC: 60034-18-42 as applicable. The VFD operation shall have no inherent detrimental impact on the Motors/ cables & supply system.</p> <p>TECHNICAL AND OPERATIONAL REQUIREMENTS</p> <p>The system shall be designed to deliver the motor input current and torque for the complete speed torque characteristics of the driven equipment, with worst input supply voltage and frequency variation. The system shall be suitable for the load characteristics and the operational duty of the driven equipment.</p> <p>The overload capacity of the controller shall be 150% of the rated current of the motor for one minute for constant torque applications and 110% of rated current for one minute for variable torque applications at rated voltage. If the motor load exceeds the limit, the drive shall automatically reduce the frequency and voltage to the motor to guard against overload.</p> <p>The drive system shall be designed to operate in one or more of the following operating modes as to suit characteristics of the driven equipment or specified by the load:</p> <ul style="list-style-type: none"> a. Variable torque changing as a function of speed. b. Constant torque over a specific speed range. c. Constant power over a specific speed range. d. Any other as specified in data-sheet <p>VFDs shall comply with the latest edition of IEEE 519 & IEC 61000 for both individual as well as total harmonic voltage and current distortion limits. The Voltage and Current limits shall be applicable at the Point of Common Coupling (PCC), which shall be the MCC/ Switchgear/ from which the VFD system is fed.</p>
--	---

THIS IS PART OF TECHNICAL SPECIFICATION PE-TS-468-571-A901 REV 00.

6.05.00	The above compliance shall be verified by the field measurements of harmonics at the PCC with and without VFDs operation.
6.06.00	VFD shall be capable of withstanding the thermal and dynamic stresses and the transient mechanical torque, resulting from short circuit. Any damage resulting from such a short circuit or internal fault shall be limited to the component concerned.
6.07.00	The system shall be suitable to maintain speed variation within range 10-110% or as per the requirement of driven equipment with speed set accuracy of +1% of rated maximum speed and steady state regulation of +0.5% of rated speed as per system requirement.
6.08.00	The VFD System shall maintain a power factor of 0.95 (minimum) (for LV VFD system) and 0.9 (minimum) (for MV VFD system) in the entire operating range.
6.09.00	Maximum allowable audible noise from the VFD system will be 85 dB (A) at a distance of one meter under rated loaded with all cooling fan operating conditions.
6.10.00	All the circuit components shall be suitably protected against over voltages, surges, lightning etc.
6.11.00	The panels shall be designed to provide easy access to hardware, to facilitate replacement of cards in case of any failure.
6.12.00	All the VFDs for particular application shall be of same design so as to ensure 100 % interchangeability of components.
6.13.00	For each programmed warning and fault protection function, the VFD shall display a message in complete English words or Standard English abbreviations. At least 30 time tagged fault messages shall be stored in the drive's fault history.
6.14.00	The VFD cubicles shall be placed in air conditioned environment. However if VFDs of less than 100 kW are designed to operate in non-air condition environment the same shall also be acceptable.
6.15.00	The 3-Phase Thyristor/IGCT/SGCT/ multistage IGBT/IEGT based VFD system shall have minimum number of components to ensure very high reliability. The input side converter shall have 3-Phase Diode/Thyristor bridge configuration modular type and inverter shall be of 3-Phase Thyristor/IGCT/SGCT/multi stage IGBT/IEGT type, using Pulse Width Modulation or better technique for generating near sine wave output to motor.
6.16.00	Fiber optic cable connection shall be provided preferably to ensure high network reliability.
7.00.00	VFD COMPATIBILITY WITH THE MOTOR
7.01.00	MV VFD output current waveform, as measured at the motor, shall be inherently sinusoidal at nominal loads, with a total harmonic current and voltage distortion within acceptable/standard limits. VFD with transformers on output side are not acceptable.

THIS IS PART OF TECHNICAL SPECIFICATION PE-TS-468-571-A901 REV 00.

7.02.00	The system design shall not have any inherent output harmonic resonance in the operating speed range.
7.03.00	VFD shall provide stable operation of motor from high-voltage dv/dt stress, regardless of cable length to motor. The vendor shall clearly state the limitations in the motor cable distance in his proposal. However, due to system requirements & constraints if the cable length becomes critical, filters/ chokes etc. shall be provided by the VFD manufacturers as an integral part of the VFD to mitigate the reflected wave effect of harmonics.
8.00.00	BYPASS ARRANGEMENT (OPTIONAL, IF SPECIFIED)
8.01.00	The VFD System shall have an optional feature to run the motor under bypass arrangement for operation of Motor with VFD bypassed. During starting (under rated conditions) the motor will be switched on in VFD Mode to limit the starting current and after gaining speed, the load would be switched over to bypass mode.
8.02.00	Comprehensive motor protection scheme for protection and control for operation VFD during bypass mode shall be finalized during detailed engineering.
9.00.00	STANDBY VFD ARRANGEMENT (OPTIONAL, IF SPECIFIED)
9.01.00	A Common standby arrangement with auto/manual switchover shall be provided in case of failure of any VFD in a group of drives. Complete protection, interlocks & control required shall be provided in the changeover module.
10.00.00	EFFICIENCY
10.01.00	Efficiency (Drive only) shall be minimum 98% for both MV VFD and LV VFD. Overall efficiency shall be minimum 96.5% for LV VFD and minimum 94 % for MV VFD at rated load and speed. Overall Efficiency evaluation shall include input transformer, harmonic filters and power factor correction (if applicable), VFD converters, cooling fans and output filter, as applicable in the system. Auxiliary controls, such as internal VFD control boards, cooling fans/pumps.
10.02.00	In absence of valid test report, a factory test shall be performed at the VFD manufacturer's facility verifying the efficiencies. Manufactures who are supplying Drive and transformer from different locations, efficiency test will be conducted separately for Drive and transformer.
11.00.00	COOLING SYSTEM
11.01.00	The VFD shall be designed to operate indoor under temperature range of 0 deg C to 50 deg C and relative humidity of 95 %(at 40 deg C).
11.02.00	VFD manufacturer to primarily offer Air cooled Design. However in case of large ratings, liquid cooled drives may be accepted subject to employer's approval. In case of liquid cooled system, there shall be no necessity of continuous water supply system (Closed Loop System).
11.03.00	In case of Air cooled design, the VFD Cooling system shall be such that it puts minimum heat load inside the room and preferably throw the hot air outside the room with ventilation ducts. The Cooling system shall be designed in such a way that the Air Conditioning & Ventilation Air requirements are kept to minimum. The VFD

THIS IS PART OF TECHNICAL SPECIFICATION PE-TS-468-571-A901 REV 00.

	<p>Manufacturer shall furnish the data regarding heat load, air flow requirements during the detailed engineering.</p>	
11.04.00	<p>Air cooled VFDs shall be provided with cooling fans mounted integral to the VFD/ enclosure. The VFD shall include air-flow pressure switches and temperature detectors to monitor proper operation of the air cooling system. If the fan fails, the system must generate the alarm/trip for the fan failure.</p>	
12.00.00	<p>TRANSFORMER:</p>	
12.01.00	<p>Type: Outdoor Mineral oil filled ONAN type or Indoor natural air-cooled Dry type, Three phase unit, rectifier/converter duty type transformer.</p>	
12.02.00	<p>All other components, technical parameters shall be as per applicable IEC/IS.</p>	
12.03.00	<p>Enclosure for Dry Type Transformer (as applicable)</p> <p>Enclosure shall be of a tested quality sheet steel of minimum thickness 2 mm & shall also accommodate cable terminations. The housing door shall be interlocked such that it should be possible to open the door only when transformer is off. The enclosure shall be provided with lifting lugs and other hardware for floor mounting.</p>	
12.04.00	Core	<p>Shall be High grade non-ageing cold rolled grain oriented silicon steel Laminations.</p>
12.05.00	Winding conductor	<p>Shall be electrolytic grade copper. Windings shall be of class F insulation.</p>
12.06.00	Winding temperature Indicator (WTI)	<p>Shall be Platinum resistance type temperature detector in each limb.</p>
12.07.00	Thermistors	<p>Shall be embedded in each limb with alarm and trip contacts for remote annunciation.</p>
12.08.00	Temperature rise:	<p>Winding temperature rise shall be as per applicable IEC.</p>
13.00.00	<p>POWER CONVERTER:</p>	
13.01.00	<p>The static power converter shall consist of a line side converter for operation as a rectifier and a load side power converter for operation as a fully controller inverter. Power converter shall be fast switching, most efficient and low loss type.</p>	
13.02.00	<p>The converter shall be coordinated with the transformers. The converter shall be able to withstand a three phase short circuit current until interrupted by normal breaker operation.</p>	
13.03.00	<p>Adequate short circuit and over voltage protection shall be provided for the converter and inverter system.</p>	
13.04.00	<p>All power converter devices shall include protective devices, snubber networks and dv/dt networks as required.</p>	
13.05.00	<p>The current rating of the converter's semi-conductor components shall not be less than 120% of the nominal current flowing through the elements at full load of the VFD</p>	

THIS IS PART OF TECHNICAL SPECIFICATION PE-TS-468-571-A901 REV 00.

	<p>through the whole speed range. If the parallel connection of semiconductor is applied, the above current rating shall not be less than 140% of the above values.</p>
13.06.00	<p>All power diodes shall be of silicon type with minimum VBO rating at 2.5 times the rated operating voltage.</p>
13.07.00	<p>The power converter circuit shall be designed so that motor can be powered at its full nameplate rating continuously without exceeding its rated temperature rise nor reducing its service factor due to harmonic currents generated by the inverter operation. The conversion devices and associated heat sinks shall be assembled such that individual devices can be replaced without requiring the use of any special precautions / tools.</p>
13.08.00	<p>The cooling system of the electronic components, if provided, shall be monitored and necessary alarms shall be provided to prevent any consequential damage to the power control devices.</p>
14.00.00	<p>OUTPUT FILTER (AS APPLICABLE):</p>
14.01.00	<p>Output/ dv/dt filter shall be provided, if required. It shall be an integral part of the VFD system and included within the VFD enclosure. It shall inherently protect motor from high voltage dv/dt stress.</p>
15.00.00	<p>DC LINK CAPACITOR (AS APPLICABLE):</p>
15.01.00	<p>Capacitor shall be of self-healing film or electrolytic type having high life time. The capacitor shall be an integral part of VFD system. DC link Capacitors shall have discharge resistors which shall be capable of reducing the residual charges to zero just after the capacitor is disconnected from the supply source. The capacitor shall be suitable for high ripple currents.</p>
16.00.00	<p>AC/DC Reactor (As applicable)</p> <ol style="list-style-type: none"> 1) Type: Dry type, air cored, self cooled, indoor type. Suitable for withstanding earth fault continuously. 2) Insulation: Thermal Class 155(F), temperature rise is limited to thermal class 130 (B). 3) Noise level shall not exceed value specified in NEMA TR-1.
17.00.00	<p>VFD PANEL REQUIREMENTS</p>
17.01.00	<p>Enclosure frames and load bearing members shall be fabricated using suitable mild steel structural sections or pressed and shaped cold-rolled sheet steel of thickness 2.0 mm. Frames shall be enclosed in cold-rolled sheet steel of thickness 1.6 mm. Doors and covers shall also be of cold rolled sheet steel of thickness 1.6 mm. Stiffeners shall be provided wherever necessary. The gland plate thickness shall be 3.0 mm for hot / cold-rolled sheet steel and 4.0 mm for non-magnetic material. In case dry type transformer is provided inside VFD panels, the enclosure and in its frame thickness shall be same as indicated in this para.</p>
17.02.00	<p>The cable entry shall be from the bottom of the panel and a removable bolted un-drilled gland plate.</p>
17.03.00	<p>All Panels shall be of dust-proof and vermin-proof construction and shall be provided with a degree of protection of IP: 3X or better for MV VFD and IP: 4X or better for LV VFD as per IS/IEC 60947</p>

THIS IS PART OF TECHNICAL SPECIFICATION PE-TS-468-571-A901 REV 00.

17.04.00	Enclosures must be designed to avoid harmonic and inductive heating effects and to shield any outside equipment from interference, enclosing and shielding the complete to eliminate any radio frequency interference. The construction of the panel shall provide effective protection against electromagnetic emissions.
17.05.00	Each panel shall be provided with illuminating lamp, space heater with switch fuse and variable setting thermostat.
17.06.00	Proper ventilation using air filters and fans/pumps shall be provided in the panels to ensure that maximum temperature inside the cubicle is within permissible limits for reliable and continuous operation of the system.
18.00.00	<p>PAINTING</p> <p>Paint shade shall be as follows</p> <ul style="list-style-type: none"> a) VFD transformer : RAL 5012 (Blue), legend in black letter reactor enclosure b) Motors : RAL 5012 (Blue) c) VFD Panels : Front and rear panels in Grey (RAL9002). End panel sides in blue (RAL 5012)
19.00.00	HT SWITCHGEAR
19.01.00	The technical requirements of HT switchgear shall be as per chapter of HT switchgear in Part-B of Technical specifications. 11KV/3.3/415V Switch gears are in BHEL scope.
20.00.00	MOTORS
20.01.00	VFD shall be used to drive three (3) phase squirrel cage inverter duty Induction motor with VPI insulation (Resin poor) suitable for VFD application. These motors shall be provided with insulated bearing on at least one side.
20.02.00	Motors shall also meet the requirements mentioned in subsection for motors and relevant IS/IEC.
20.03.00	Motor shall be suitable for operation with a solid state power supply consisting of an adjustable frequency inverter for speed control & shall be suitable for the current waveforms produced by the power supply including the harmonics generated by the drive.
20.04.00	Motor insulation shall be designed to accept the applied voltage waveform, within the Vpeak and dv/dt limits as per IEC-61800.
20.05.00	Drive manufacturer shall coordinate with the motor manufacturer for proper selection of the motor for the given load application and the output characteristics of the drive.
20.06.00	Other requirements of motor shall be as stipulated in technical chapter of Motors in Part-B of technical specifications.
21.00.00	LT & HT CABLES
21.01.00	Contractor's scope shall also include LT and HT cables suitable for VFD system and Motors.
22.00.00	CONTROL AND PERFORMANCE REQUIREMENTS

THIS IS PART OF TECHNICAL SPECIFICATION PE-TS-468-571-A901 REV 00.

22.01.00 The VFD to provide an automatic current limiting feature to control motor currents during startup and provide a “soft start” torque profile for the motor load combination. Current and torque limit adjustments shall be provided to limit the maximum VFD output current and the maximum torque produced by the motor.

22.02.00 It shall be possible to vary the speed of the drive and control it in either Local or Remote mode. Local / Remote selection shall be done from VFD panel unless otherwise specified.

22.03.00 Provision shall be kept for exchange of information between different VFD control system parameters thru PLC/DDCMIS.

Man machine interface for (MV) VFD shall have one flat TFT monitor with keyboard (password protected) in the VFD room and a color laser printer for system alarm and monitoring located in control room.

- Parameter Monitoring:
- Input and output voltage of Drive
 - Input and output current of Drive
 - Motor speed
 - Input and output power frequency of Drive
 - Torque
 - Input and Output power of Drive system (covering transformer if applicable)
 - Output kWhr of Drive
 - Transformer (if applicable) temperature for alarm & trip.
 - Ambient temperature
 - Run/stop and local/remote status displayed

22.04.00 Drive shall be equipped with a front mounted operator console panel consisting of a backlit alphanumeric display and a keypad with keys for parameterization and adjusting parameter. Control panel shall be operable with password for changing the protection setting, safety interlock etc.

22.05.00 Operator console/Main Control Card shall have facility / port to connect external hardware such as Lap-Top etc. Console shall have facility for upload and download of all parameter settings from one drive to another drive for start up and operation.

22.06.00 User-friendly licensed software for operation and fault diagnostic shall be loaded in the drive system panel before commissioning.

23.00.00 PROTECTION FEATURES

23.01.00 The system offered shall incorporate adequate protection features as per IEC 61800-4: 2002 Table-8, properly coordinated for the drive control and for motor including following:

- i) Converter transformer: short circuit, over current, earth fault & winding temperature high protection.
- ii) Incoming and outgoing line surge protection.
- iii) Under / over voltage protection
- iv) Phase loss, phase reversal, overload, negative phase sequence, locked rotor protection.

- v) Instantaneous Over current & Earth fault protection
- vi) Converter/Inverter module failure indication.
- vii) Over frequency/speed protection.
- viii) Ventilation failure indication & alarm.
- ix) Over temperature of VFD
- x) Bearing temperature protection.
- xi) System earth fault protection.
- xii) Speed reference loss protection.

23.02.00 Under VFD Bypass Mode (if applicable) all the electrical protections related to the Motor shall remain applicable.

24.00.00 **CONTROL FEATURES**

24.01.00 Following controls shall be provided as a part of the Operator Control Panel or through separate switches on the front panel door.

- i) Start / stop (in local/remote mode)
- ii) Speed control (Raise / lower)
- iii) Acknowledge/Accept/ Test Push Button for annunciation
- iv) Auto / Manual / Test Mode select
- v) Emergency stop
- vi) Trip-Remote Breaker

25.00.00 **DIAGNOSTIC FEATURES**

25.01.00 The VFD shall include a microprocessor/PLC based digital diagnostic system which monitors its own control functions and displays faults and operating conditions.

25.02.00 Fault diagnostic shall be built into the system to supervise the operation and failure of the system. The information regarding failure of any of the system including shut down of the system shall be available. It shall be possible to retrieve the record of events prior to tripping of the system or de-energization. Auxiliary supply to the system components or to the electronics (firmware) for the diagnostics / display shall be taken care of by the manufacturer for this purpose.

26.00.00 **SERVICEABILITY / MAINTAINABILITY**

26.01.00 Power Component Accessibility: All power components in the converter sections shall be designed for rack-out accessibility for ease of maintenance and to minimize repair downtime.

26.02.00 Marking / Labeling: Sleeve type wire marker tags or other acceptable means of permanent identification shall be applied to power and control wiring. Individual labels shall be provided for all major components of the VFD system.

27.00.00 **STORAGE AND PRESERVATION**

27.01.00 The Contractor shall be responsible for the storage and preservation of all the equipments to be supplied under the VFD System, till the time of successful installation and commissioning. The equipment should be suitable for storage for long periods before installation. Contractor should take adequate measures to ensure that no damage happens to the VFD System due to storage and preservation.

28.00.00 **TESTS**

28.01.00 **ROUTINE TESTS**

All acceptance and routine tests as envisaged in QA section shall be carried out. Charges for these shall be deemed to be included in the equipment price.

28.02.00 **TYPE TESTS**

28.02.01 The Contractor shall carry out the type tests as listed in this specification on the equipment to be supplied under this contract. The bidder shall indicate the charges for each of these type tests separately in the relevant schedule and the same shall be considered for the evaluation of the bids. The type tests charges shall be paid only for the test(s) actually conducted successfully under this contract and upon certification by the employer's engineer.

28.02.02 The type tests shall be carried out in presence of the employer's representative, for which minimum 15 days' notice shall be given by the Contractor. The Contractor shall obtain the employer's approval for the type test procedure before conducting the type test. The type test procedure shall clearly specify the test set-up, instruments to be used, procedure, acceptance norms, recording of different parameters, interval of recording, precautions to be taken etc. for the type test(s) to be carried out.

28.02.03 In case the Contractor has conducted such specified type test(s) within last ten years as on the date of bid opening, he may submit during detailed engineering the type test reports to the Employer for waiver of conductance of such test(s). These reports should be for the tests conducted on the equipment similar to those proposed to be supplied under this contract and test(s) should have been either conducted at an independent laboratory or should have been witnessed by a client. The Employer reserves the right to waive conducting of any or all the specified type test(s) under this contract. In case type tests are waived, the type test charges shall not be payable to the Contractor.

28.02.04 Further the Contractor shall only submit the reports of the type tests as listed in "LIST OF TESTS FOR WHICH REPORTS HAVE TO BE SUBMITTED" and carried out within last ten years from the date of bid opening. These reports should be for the test conducted on the equipment similar to those proposed to be supplied under this contract and the test(s) should have been either conducted at an independent laboratory or should have been witnessed by a client. However if the Contractor is not able to submit report of the type test(s) conducted within last ten years from the date of bid opening, or in the case of type test report(s) are not found to be meeting the specification requirements, the Contractor shall conduct all such tests under this contract at no additional cost to the Employer either at third party lab or in presence of client/Employers representative and submit the reports for approval.

28.03.00

LIST OF TYPE TESTS TO BE CONDUCTED

The following type tests shall be conducted under this contract for MV VFD

- i) Overall efficiency determination of VFD system including transformer/ Harmonic filters etc at motor full load
- ii) Temperature rise test
- iii) Noise level
- iv) Harmonics of No load current.(Input/Output)

28.04.00

LIST OF TESTS FOR WHICH REPORTS HAVE TO BE SUBMITTED

The following type test reports shall be submitted for VFD Panels'

1) VFD panels (For LV VFD)

- i. Rated Current/ Output
- ii. Temperature rise test
- iii. Noise level test
- iv. Power Loss Determination Test
- v. Power factor measurement.
- vi. Degree of Protection Test
- vii. EMC Test
- viii. The Fast transient SWC tests as per ANSI / IEEE C37.901-2002 / IEC 60255-22-04-2008 / IEC 61800

2) VFD panels (For MV VFD)

- i. Rated Current/ Output
- ii. Current Sharing
- iii. Voltage Division
- iv. Power Loss Determination Test
- v. Power factor measurement.
- vi. Degree of Protection Test
- vii. The Fast transient SWC tests as per ANSI / IEEE C37.901-2002 / IEC 60255-22-04-2008 / IEC 61800

3) AC/DC Reactor

- i. Lightning impulse test(If applicable)
- ii. Heat run test
- iii. Short time current test(If applicable)
- iv. Noise level test

4) Transformers (In case of non integrated type)

- i. As per requirements mentioned in subsection for Transformer chapter in technical specifications.

CLAUSE NO.	TECHNICAL REQUIREMENTS		
1.00.00	CONTROL DESK & PANELS		
1.01.00	GENERAL		
1.01.01	All control desk, panels, LVS panel etc. shall be furnished fully wired with necessary provision for convenience outlets, internal lighting, grounding, ventilation, space heating, anti-vibration pads, internal piping & accessories as required for completeness of the system.		
1.01.02	All panels, desks, cabinets shall be free standing type & have bottom / top entry for cables to be finalised application wise during detailed engineering stage. The bottom of desk & cabinets shall be sealed with bottom plate, compression cable glands (double for field and single for inside rooms) and fire proof sealing material to prevent ingress of dust and propagation of fire. Sufficient number of power receptacles with disconnect switches shall be installed within all panels/desk.		
1.01.03	Exterior steel surface shall be sand blasted, ground smooth, filled, primed, sanded and smooth enamel painted to give a good finish subject to minimum paint thickness of 65-75 microns for sheet thickness of 3 mm and 50 microns for sheet thickness of 2mm. The exact color shall be finalised during detailed engineering.		
1.01.04	The design shall conform to the EN ISO 11064 (Ergonomical design of control room), Part-1,2 and 3.		
2.00.00	CONTROL DESK & PANEL		
2.01.00	GENERAL		
2.01.01	The exact dimensions, material, construction details, grounding, general arrangement etc. of Control Desk etc. shall be as per the actual requirement and shall be finalised during detailed engineering and subjected to Employer's Approval.		
2.01.02	For control desk mounted instruments/ devices etc., which are to be powered from UPS, all required conversion of interface equipments / accessories to make such devices compatible with UPS supply shall be provided. All necessary hardware like Input switches/ fuse unit for each feeder as well as switch fuse unit for each instrument/ device on the power supply line shall be provided. From UPS, redundant feeders shall be provided with suitably rated MCB and provision of fast auto changeover of UPS feeders.		
2.02.00	Control Desk (CD)		
2.02.01	Control desk shall be Modular, non-welded construction free standing table top type with front & back cover constructed of 1.6 mm thick CRCA steel plates. The tabletop of the control desk shall be arc-shaped for mounting TFT monitors & mice. The work surface of control desk shall be 30mm thick with the top 12mm of Acrylic Solid Surface (ASS) and the remaining 18mm of laminated medium density fiber board. Work surface shall be made of two different colors at same level and seamlessly joined in each section. The structure frame shall consist of extruded aluminum top and bottom horizontal beams and vertical support tensioned together to form an integrated, finished curvilinear shaped frame. Vertical & Horizontal supports, minimum 2.5mm and 2mm thick respectively, have to be provided for the structure frame. Extreme side legs shall be illuminated type and should complete the		
LOT-2 PROJECTS FLUE GAS DESULPHURISATION (FGD) SYSTEM PACKAGE	TECHNICAL SPECIFICATION SECTION – VI BID DOC. NO.:CS-0011-109(2)-9	PART-B SUB-SECTION-III-C9 CONTROL DESK & PANELS	PAGE 1 OF 3

CLAUSE NO.	TECHNICAL REQUIREMENTS		
<p>2.02.02</p> <p>2.02.03</p> <p>2.03.00</p> <p>2.04.00</p>	<p>overall form and aesthetics of the desk. It shall have concealed cable & wire way management system. Telephone sets shall be mounted on the control desk. Sliding keyboard trays shall be provided on the CD. The exact profile of the desk, dimension and the radius of curvature shall be finalised during detailed engineering stage.</p> <p>All operator monitors & mice shall be mounted on this CD.</p> <p>The cabling / wiring between OWS & CPU's, power supply cables etc. shall be aesthetically routed and concealed from view.</p> <p>Internal Panel/Desk Items</p> <p>Equipment and devices mounted within the panels/desk shall be mounted on suitable racks/brackets and shall be arranged for convenient access for adjustment and maintenance work.</p> <p>Furniture</p> <p>Bidder shall provide following industrial grade furniture items as a minimum from reputed manufacturers/suppliers meeting International Standards. The furniture shall be modular and latest with ease of operational features. The furniture shall be modern, aesthetically designed, modular, flexible, space saving and future safe. Each module shall have transparent cover and adjustable partition. It shall have locking provision for security. The components shall be suitable for integration/fabrication without any welding technology.</p> <ol style="list-style-type: none"> 1. Work Station furniture <p>Modular work station furniture, suitable for mounting servers & historians, programmer stations, PC based systems, printers (inkjet or A4 laser) etc. is to be provided..</p> 2. Server Rack <p>Server rack shall be provided to mount programmer stations, PC based systems (of rack type and tower type), Matrix KVM switcher, Mini UPS etc. Suitable arrangement for Ventillation and cooling shall be built in-</p> 3. PC rack <p>PC rack shall be provided to mount CPUs of work stations/PCs of OWS/LVS etc in Control Room.</p> 4. Chairs <p>Industry standard revolving chairs with wheels and with provision for adjustment of height (hydraulically/gas lift) shall be provided for the operators & other personnel in control room area. These shall be designed for sitting for long duration such that these are comfortable for the back.</p> 5. Tables 		
<p>LOT-2 PROJECTS FLUE GAS DESULPHURISATION (FGD) SYSTEM PACKAGE</p>	<p>TECHNICAL SPECIFICATION SECTION – VI BID DOC. NO.:CS-0011-109(2)-9</p>	<p>PART-B SUB-SECTION-III-C9 CONTROL DESK & PANELS</p>	<p>PAGE 2 OF 3</p>



SPECIFICATION FOR LOCAL PANELS

SPECIFICATION NO.: PE-SS -999- 145 -054A

VOLUME II B

SECTION D

REV. NO. 03

DATE : 16-09-2013

SHEET 1 OF 6

1.0 SCOPE

This specification covers the Design, Manufacture, Inspection and Testing at the manufacturer's works, proper packing for transportation and delivery to site, supervision, erection, and commissioning at site of Local Panels required for control and monitoring of the Auxiliary Plant & Equipment.

2.0 CODES AND STANDARDS

2.1 All the equipments specified herein shall comply with the requirements of the latest issue of the relevant National and International standards.

2.2 As a minimum requirement, the following standards shall be complied with:

- | | | | |
|----|--------------------------|---|---|
| a) | IS-6005 : 1998 | : | Code of practice for phosphating of iron and steel. |
| b) | IS-5 : 2007 | : | Colors for ready mixed paints and enamels. |
| c) | IS-1248:2003 | : | Direct Acting Indicating Analog Elec Measuring Instruments. |
| d) | IS/IEC 60947:Part 1:2004 | : | Low Voltage switchgear & control gear: Part-I (General Rules) |
| e) | IS-8828:1996 | : | Circuit breaker for household and similar installations. |
| f) | IS-13947 (Part-I):1993 | : | Low Voltage switchgear & control gear : Part-I (General Rules) |
| g) | ISA-18.1:1979 | : | Annunciator Sequences and Specification |
| h) | NFPA-496:2003 | : | Purged & Pressurised Enclosure for Electrical Equipment in Hazardous Locations. |

3.0 TECHNICAL REQUIREMENTS

3.1 Panel Construction

3.1.1 The local panels shall house the secondary instruments, annunciation system, Single loop controller, Control switches / push buttons, indicating lamps/LED cluster, relays, timers and other devices required for operation and monitoring of the equipment locally.

3.1.2 The panels shall be of free standing type either welded construction on angle iron (minimum section of 50 x 50 x 4 mm) structure or folded construction by sheet metal formation depending upon the equipments to be mounted on it. The panels shall be robustly built and stiffeners as necessary shall be provided.

3.1.3 The panel shall be suitably reinforced to ensure adequate support for all instruments mounted thereon. All welds on exposed panel surfaces shall be ground smooth.

3.1.4 The salient features of construction shall be:

Sheet material: Cold rolled sheet steel

Frame thickness: Not less than 3.0mm

Enclosure thickness: Not less than 2.5 mm for load bearing sections (Mounted with instruments)
1.6 mm for doors and Not less than 2.0 mm for others

Panel Height: Not less than 2365 mm (Refer data sheet-A (No. PES-145A-DS1-0)

Gland plate thickness: 3.0mm

Base channel: ISMC 100 with anti-vibration mounting & foundation bolts.

3.1.5 The panel shall be provided with rear doors with integral lockable handle. The door when locked shall be held at minimum three places. The door width shall not be more than 550mm. The doors shall be provided with suitable stiffeners to prevent buckling. The handle shall be on the right side of the door. The door shall be removable type with concealed hinges to facilitate maintenance work. Suitable pocket inside the door shall be provided for keeping the drawings / documents. Double door shall be provided with suitable glass windows, as per the requirement.

3.1.6 Suitable neoprene gasket shall be provided on all doors and removable covers. Suitable ventilation system along with louvers shall be provided at bottom and top of the doors covered with removable wire mesh.



SPECIFICATION FOR LOCAL PANELS

SPECIFICATION NO.: PE-SS -999- 145 -054A	
VOLUME	II B
SECTION	D
REV. NO. 03	DATE : 16-09-2013
SHEET	2 OF 6

- 3.1.7 The class of protection shall be in accordance with IP-42 unless otherwise specified in the data sheet – A (No. PES-145-54A-DS1-0).
- 3.1.8 All steel surfaces shall be cleaned by sand / pellet blasting, treated for pickling, degreasing and phosphating etc. by seven tank method. The panel shall have a high quality finish and appearance. The panel shall be painted with two coats of primer followed by two coats of epoxy / synthetic enamel based final paint of color shade and finish as given in data sheet-A (No. PES-145A-DS1-0). Minimum thickness of the paint shall be 85 microns for external paint and 70 microns for internal paint.
- 3.1.9 The cable glands of the required size and type as given in data sheet-A (No. PES-145A-DS1-0) shall be supplied alongwith the Panel.
- 3.1.10 All operable and indicating devices shall be mounted on the front of the panel while aux. Relays / timers MCBs etc. required for realization of control logics shall be mounted on a mounting plate inside the panel. Auxiliary relays and timers etc. shall be grouped according to the control function. No operable or indicating devices shall be mounted below 750 mm and above 1800 mm (w.r.t. finished ground level). The devices shall be located in such a way so as to ensure easy access for operation / maintenance.
- 3.1.11 Single / dual control power supply feeders of voltage class as specified in data sheet-A (No. PES-145A-DS1-0) shall be provided by the purchaser. In case redundant power supply feeders are provided then auto changeover unit shall be mounted on the panel are in the panel supplier's scope. Where DC control power supply is specified an additional 240V, 50 Hz AC supply feeder for powering of space heater and lighting shall be provided by the purchaser. Suitable arrangement shall be provided inside the panel to receive and terminate the power supply feeder(s). For this purpose MCBs of suitable current rating shall be provided by the vendor. A supervisory relay along with a pilot lamp to indicate control supply 'ON' shall be provided on the panel. Any other power supply required for the operation of the devices mounted in the panel shall be arranged by the vendor.
- 3.1.12 The internal wiring shall be carried out with 1100 volt grade PVC insulated copper multi strand wire / flexible of 1.5mm² size. AC & DC wires shall be kept separate from each other. Separate coloured wires to be used for AC and DC circuits. All wires shall be properly numbered and identified with ferrules as per the Control scheme / wiring diagram. Wires shall be routed and run through PVC troughs.
- 3.1.13 Terminal blocks shall be clip on type, 1100 volts grade. Separate terminal blocks shall be used for AC & DC circuits. The terminals shall be suitable for terminating 0.5 mm² to 2.5mm² external cables. The TB points in terminal block shall be cage clamp type / screw type. The terminal for ammeters shall be provided with removable links for shorting CTs. Each terminal strip shall be provided with identification strip. The terminal shall not be mounted below 250 mm height from finished floor. The panel shall have ten (20) percent spare terminal.
- 3.1.14 The interior of each panel shall be suitably illuminated through fluorescent lamps / tube lights with shrouded cover of minimum 15W operable on 240V 50 Hz AC power supply through panel door switch. A 15 Amp. 3-pin Power receptacle shall be provided.
- 3.1.15 Suitable space heaters operable on 240 Volts 50 Hz AC power system shall be provided at the panel bottom. These shall be designed to maintain the panel temperature five (5) deg. C above the ambient temperature during maintenance shutdown. Suitable isolating and control devices comprising of MCB, thermostat etc. shall be provided for the space heater.
- 3.1.16 The panel shall be provided with a copper earth bus of 25 x 6 mm size running throughout the width of the panel. It shall be terminated internally with 10 mm bolts at extreme ends for connection to; main station earth. The panel mounted equipments / devices shall be connected to earth bus through green coloured PVC insulated stranded copper conductor of 2.5 mm² size.
- 3.1.17 Local Panel shall be provided with main name plate of 150 mm x 40 mm size having inscription of 20 mm height. The individual devices on the panels shall be as provided with separate name plate with inscription of 3 mm height. The instrument / devices shall be provided with stick on label plates inside the panel. The material of the main and individual labels shall be three (3) ply 3 mm thick Traffolyte



SPECIFICATION FOR LOCAL PANELS

SPECIFICATION NO.: PE-SS -999- 145 -054A

VOLUME II B

SECTION D

REV. NO. 03

DATE : 16-09-2013

SHEET 3 OF 6

Sheet / 2 mm Anodised Aluminium Plate. The inscription shall be with white letters on black background on traffolyte sheet. The labels shall be fixed by self tapping non-rusting screws.

3.1.18 Vendor shall furnish electric load and heat load list (in case panel is to be placed in ac environment) of each panel.

3.2 Hazardous Area Panel Requirement

3.2.1 The Local Panel located in hazardous area shall be pressurized as per NFPA-496 requirements to render it non-hazardous. Alarms shall be provided for local and remote annunciation when pressurisation falls below 2.5 mm of water column. Protection shall be of type Z of NFPA-496. It shall not be possible to switch ON the power of purged section unless it is purged as per the recommendation of NFPA-496. Vendor must provide a protective device on the panel to protect the panel from over pressurisation.

3.2.2 Vendor shall supply pressurisation kit consisting of valves, restriction orifices, dual filter regulation, pressure gauges, pressure switches, rotameter etc. Pressurisation kit shall be surface mounting on a metal board and located outside the local panel. Pressurisation kit shall further consist of solenoid valve flow switch, timer blow off safety device etc., so as to make purging fully automatic. However final start shall be manual. Panel protection against over pressure to be provided as per NFPA-496.

3.2.3 Pressurised local control panel pressurization kit assembly design shall provide minimum leakage flow through the Local Control Panel. Panel venting shall be as per NFPA-496.

3.2.4 All components in the local panel like indicating instruments, push buttons switches, lamps etc., which are required to be energized without panel pressurization or before completion of purge cycle shall be explosion proof as per NEMA-7 & suitable for area classification.

3.2.5 All push buttons etc. requiring frequent operation during machine running shall have good positive sealing. Weatherproof housing or cover to be provided wherever necessary. Vendor shall provide pressurisation bypass switch outside explosion proof enclosure of pressurized panel with lamp indication. This shall be used only during maintenance. All hinges, screws, other non-painted metallic parts shall be of stainless steel material.

3.2.6 Provision to switch off manually all types of power shall be provided in the panel. In addition, it shall also be possible to switch off power circuits / components which are powered from motor control centre or control room manually in case of pressurization failure. All such cables from MCC and main control room shall be terminated in explosion proof boxes (NEMA-7).

3.3 Control & Monitoring devices

3.3.1 Instruments like Indicators, recorders, single loop controllers etc. as applicable and specified elsewhere for the plant / equipment shall be supplied and mounted on the panel.

3.3.2 Alarm Annunciator System

It shall be solid state discrete facia type having a sequence of ISA-S18.1A or as specified, opaque facia windows of 70 mm x 50 mm size, having two (2) lamps per window, and hooter of 10W, and provision for repeat group alarm at remote. The annunciator shall be provided with ten (10) percent spare windows or minimum two (2) windows along with electronics.

3.3.3 Relays

The relays shall be electromagnetic type suitable for specified control supply. Its contact configuration and rating shall be suitable for the specified control function. However minimum contact rating shall be 5 Amp AC & 2 Amp DC as applicable. There shall be ten (10) percent spare contacts.

3.3.4 Timers

The timers shall be electronic type suitable for specified control supply. Its contact configuration and rating shall be suitable for the specified control function. However, minimum contact rating shall be 5 Amp AC & 2 Amp DC as applicable.



SPECIFICATION FOR LOCAL PANELS

SPECIFICATION NO.: PE-SS -999- 145 -054A

VOLUME II B

SECTION D

REV. NO. 03

DATE : 16-09-2013

SHEET 4 OF 6

3.3.5 Control / Selector Switches

Switches shall be Rotary Cam type with minimum of 5 Amps AC & 2 Amp DC continuous current rating. Selector switches shall be stay put type while control switches shall be spring-return-to-neutral type. Contact configuration and rating shall be as per the control function requirement. The switches shall be lockable type wherever specified. Each switch shall be provided with engraved plates indicating the switch position / functions.

3.3.6 Push Buttons / Indicating Lights

The push buttons shall be momentary action self-resetting type, however stop P.B. for unidirectional drives shall be provided with manual reset facility. Its contact configuration & rating shall be as required for the control function but minimum 2 NO + 2 NC of 5 Amp. AC rating. It shall have round coloured projecting tab and engraved escutcheon plate / inscription plate. Colour coding of push buttons shall be as under:

RED	Motor OFF / Valve CLOSE	YELLOW	Alarm acknowledge	Left Hand Side
GREEN	Motor ON / Valve OPEN	BLACK	Lamp test	Right Hand Side

Indicating lights shall be suitable for direct connections across specified power supplies. It shall be fitted with built in resistance to prevent circuit tripping on shorting of lamp filament. It shall be fitted with LED cluster type lamp replaceable from front.

GREEN	Motor OFF / Valve CLOSED condition	AMBER	Motor tripped	Left Hand Side
RED	Motor ON / Valve OPEN condition	WHITE	Normal / healthy	Right Hand Side

3.3.7 Ammeters

Ammeter shall be 96 x 96 mm size, 90 deg. deflection, 1.5% accuracy, 1 Amp. CT operated or with 4-20mA input and Flush mounting type as called for in the data sheet-A (No. PES-145-54A-DS1-0). Ammeters for motors shall have six (6) times folded scale at upper end to enable motor starting current indication

3.3.8 Miniature Circuit Breaker (MCB)

These shall be instantaneous magnetic trip type for short circuit in addition to current time inverse delayed thermal trip feature for over current protection. The housing of MCB shall be made of non-ignitable, high impact material. It shall have minimum short circuit rating of 9 KA for AC Voltages and 4 KA for DC Voltages.

3.3.9 Makes of various instruments / devices shall be as given below

1.	Alarm Annunciators	:	Procon / IIC
2.	Ammeters	:	AEP / IMP
3.	Control / Selector Switches	:	Alsthom / Kaycee / Siemens / L&T
4.	Push Buttons / Indicating Lamps	:	Siemens / L&T / Teknic / Alsthom
5.	Auxiliary Relays	:	Jyoti / Siemens / L&T / OEN
6.	Timers	:	L&T / Alsthom / Bhartiya Cutler Hammer
7.	MCBs	:	S&S Power Engg. / Indo Asian / MDS
8.	Terminal Blocks	:	Jyoti / Elmex

4.0 TESTING AND INSPECTION

4.1 The bidder shall adopt suitable quality assurance program to ensure that the equipments offered will meet the specification requirements in full.

4.2 BHEL's standard Quality Plan for LCP is enclosed with the specification. The bidder shall furnish his acceptance to BHEL's QP and submit the signed and stamped copy of QP along with the offer.



**SPECIFICATION FOR
LOCAL PANELS**

SPECIFICATION NO.: PE-SS -999- 145 -054A

VOLUME II B

SECTION D

REV. NO. 03

DATE : 16-09-2013

SHEET 5 OF 6

4.3 The vendor shall conduct the following tests as a minimum requirement:

4.3.1 Routine Tests

1. High Voltage (H.V.)
2. Insulation Resistance (I.R.)
3. Functional

4.3.2 Type Tests

1. Enclosure Class Test



SPECIFICATION FOR LOCAL PANELS

SPECIFICATION NO.: PE-SS -999- 145 -054A

VOLUME II B

SECTION D

REV. NO. 03

DATE : 16-09-2013

SHEET 6 OF 6

5.0 SPARES AND CONSUMABLES

5.1 Commissioning Spares and consumables

The bidder shall supply all commissioning spares and consumables 'as required' during Start-up, as part of the main equipment supply.

5.2. Mandatory Spares

The bidder shall offer alongwith main offer, the Mandatory Spares as specified elsewhere in the specification. The Mandatory Spares offered shall be of the same make and type as the main equipment.

5.3. Recommended Spares

The bidder shall furnish a list of Recommended Spares indicating the normal service expectancy period and frequency of replacement; quantities recommended for 3 years operation alongwith unit rate against each item to enable BHEL/BHEL's Customer to place a separate order later, if required.

6.0 DRAWINGS AND DOCUMENTS

6.1 The bidder shall furnish the following documents in required number of copies along with the bid :

1. Data Sheet no. PES-145A-DS1-0
2. General Arrangement Drawing.
3. Catalogue and technical information for instruments and devices.
4. Quality Plan.

6.2 The vendor shall furnish the following documents in required number as agreed after the award of contract:

1. Data Shee No. PES-145A-DS2-0
2. GA Drawing indicating layout of instruments, construction details, foundation details, cable gland plate alongwith cable glands and all details mentioned in this specification.
3. Control Schematic Diagram along with grouping of different terminals for various functions.
4. Catalogue and technical information for instruments and devices with selected options clearly marked.
5. O&M Manuals.
6. "As Built" Drawing.
7. CDs.

7.0 MARKING AND PACKING

7.1 Panel with all instruments / devices mounted on it shall be suitably packed & protected for the entire period of despatch, storage and erection against impact, abrasion, corrosion, incidental damage due to vermin, sunlight, high temperature, rain moisture, humidity, dust, sea-water spray (where applicable) as well as rough handling and delays in Transit and storage in open.

8.0 APPLICABLE DATA SHEET FORMS

This document shall be read with one or more of the following data sheet forms :

- | | | |
|-----------------------------------|---|-------------------------------|
| - Data sheet A&B for Local Panels | : | Data sheet no. PES-145A-DS1-0 |
| - Data sheet C for Local Panels | : | Data sheet no. PES-145A-DS2-0 |

No part of this document will be reproduced by any means without the written permission.
This document is the property of NATIONAL THERMAL POWER CORPORATION LTD.

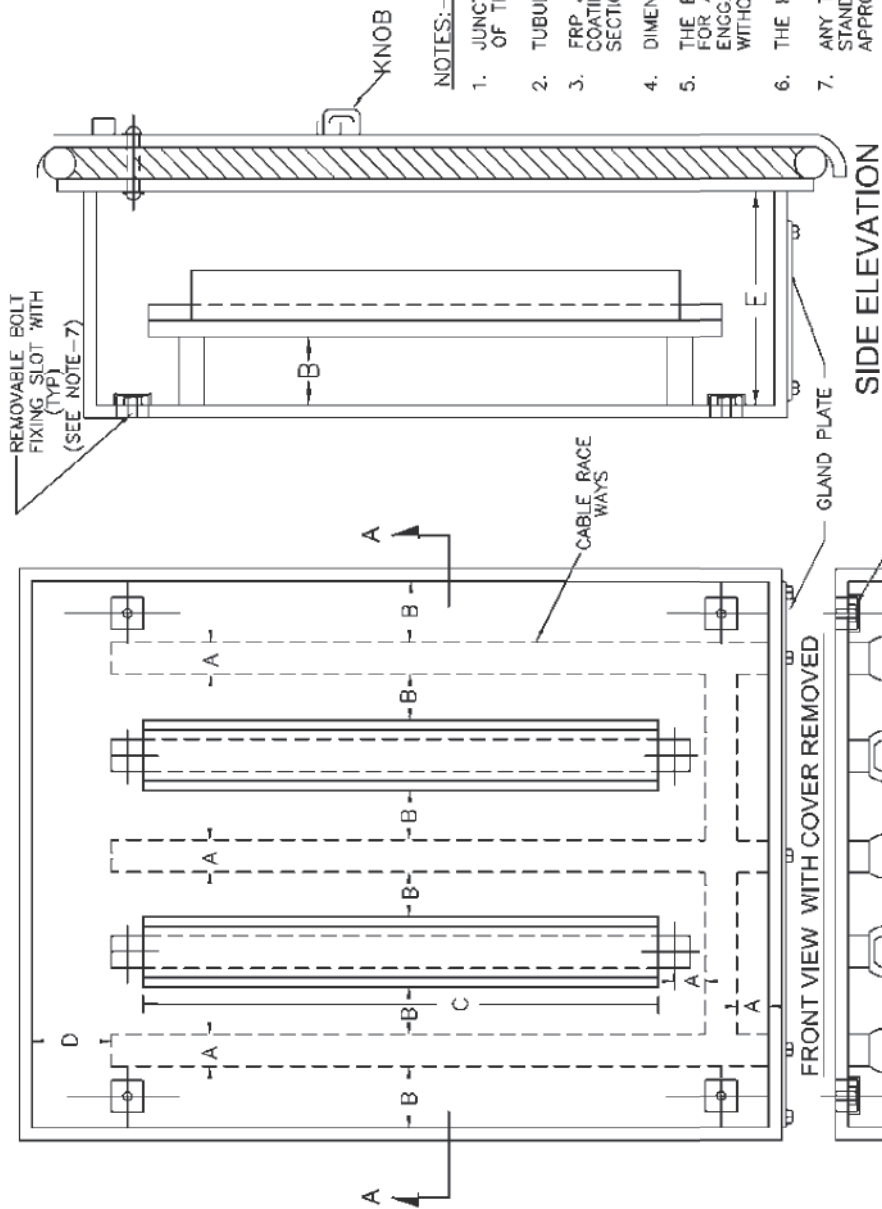

- A - 75 mm
- B - 25 mm
- C - SEE NOTE-4
- D - 100 mm
- E - 150 mm

NOTES:-

1. JUNCTION BOXES SHALL HAVE GLAND PLATES AT THE BOTTOM OF THE BOX ONLY.
2. TUBULAR TYPE GASKETS WILL BE USED.
3. FRP JUNCTION BOXES, SHALL BE PROVIDED WITH POLYURETHERENE COATING. ALSO REFER SUB SECTION INST CABLE, PART-B SECTION-VI FOR DETAILS.
4. DIMENSION OF 'C' SHALL BE BASED ON NO. OF TERMINAL BLOCKS.
5. THE EXACT TYPE & DIMENSION OF JUNCTION BOXES TO BE USED FOR A PARTICULAR APPLICATION SHALL BE AS DECIDED DURING DETAIL ENGG. STAGE AND SHALL BE SUBJECT TO EMPLOYER'S APPROVAL WITHOUT ANY PRICE REPERCUSSION.
6. THE KNOB FOR ALL THE JUNCTION BOXES SHALL BE IDENTICAL.
7. ANY TYPE OF SEALED FIXING ARRANGEMENT AS PER MANUFACTURER'S STANDARD CAN ALSO BE PROVIDED SUBJECT TO EMPLOYER'S APPROVAL.

FOR TENDER PURPOSE ONLY

NTPC LIMITED (A GOVERNMENT OF INDIA ENTERPRISE) ENGINEERING DIVISION		TYPICAL THERMAL POWER PLANT		Page 291 of 538	
PROJECT		TITLE		REV. NO.	
HINGE FOR THE DOOR		G.A. OF JUNCTION BOX		0000-999-POI-A-017	
SECTION-AA		SCALE		DRG. NO.	
KNOB		N.T.S.		D	
DRAWN		DATE		SIZE	
DESIGN		04.05.05		A4	
CHKD.		APPD		N.T.S.	
M		04.08.06		A4	
E		21.08.12		A4	
C&I		ARCH.		D	
CLEARED BY		PROJECT		TYPICAL THERMAL POWER PLANT	
D E S C R I P T I O N		TITLE		G.A. OF JUNCTION BOX	
A		PS		04.05.05	
B		PS		04.08.06	
C		PS		21.08.12	
D		PS		21.08.12	

THIS IS PART OF TECHNICAL SPECIFICATION PE-TS-468-571-A901-REV-00.

This drawing and the design it covers are the property of NTPC LTD. and must not be copied, loaned or exhibited either in part or in whole without written permission. Any contravention is liable for prosecution.

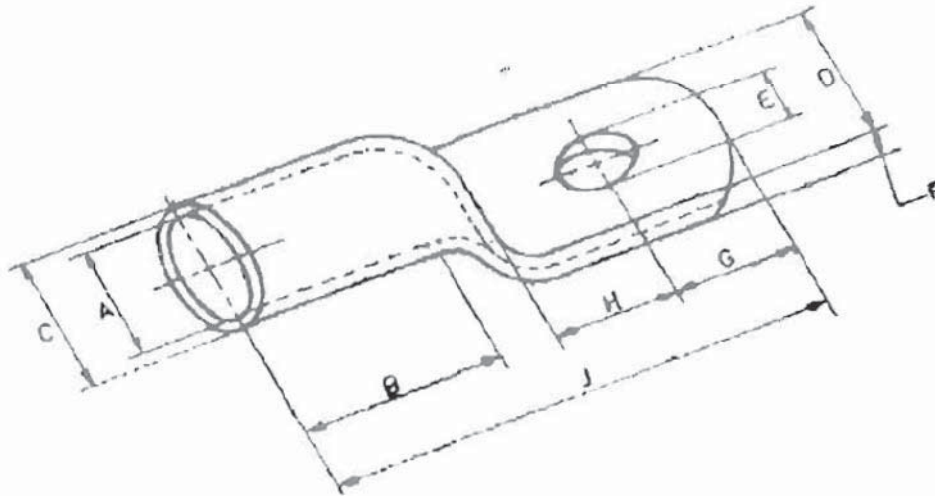

S.No.	Conductor Size HT Power Cables	E (Dimensions in mm)
1	95 sq.mm	13
2	150 sq.mm	17
3	300 sq.mm	17

RA	FOR TENDER PURPOSE	NEC	W
REV. NO.	DESCRIPTION	CHANGED	CHG	M	E	C	C&J	WCH	APP	DATE	CLEARED BY									
		NTPC LTD. (A GOVERNMENT OF INDIA ENTERPRISE) ENGINEERING DIVISION																		
PROJECT		STANDARD																		
TITLE		TYPICAL DRAWING FOR CABLE LUG																		
SIZE	SCALE	DRW. NO.	0000-211 POE A-051															DATE	DATE	
A4	1:1	VT																		

THIS IS PART OF TECHNICAL SPECIFICATION PE-TS-468-571-A901 REV 00.





**C&I SPECIFICATION
FOR GYPSUM DEWATERING EQUIPMENT**

**INSTRUMENTATION CABLE,
CABLE INTERCONNECTION AND
TERMINATION PHILOSOPHY**

CLAUSE NO.	TECHNICAL REQUIREMENTS																
1.00.00	INSTRUMENTATION CABLE, CONTROL & POWER SUPPLY CABLE, INTERNAL WIRING AND ELECTRICAL FIELD CONSTRUCTION MATERIAL (CABLE SUB-TRAYS ETC)																
1.01.00	General requirements																
1.01.01	All cables including special cables, internal wiring and electrical field construction material shall conform to this specification, Employer approved detail engineering drawings & documents and the latest edition of the relevant standards & guidelines. The Bidder shall furnish all material and services required for the completeness of the work identified in his scope as per this specification.																
1.01.02	The Contractor shall supply, erect, terminate and test all instrumentation cables for control and instrumentation equipment/devices/systems included under Contractor's scope and ensuring completeness of the control system.																
1.01.03	Any other application where it is felt that instrumentation cables are required due to system/operating condition requirements, are also to be provided by Contractor.																
1.01.04	Other type of cables like fiber optic/co-axial cables for system bus, cables for connection of peripherals etc. (under Contractor's scope) are also to be furnished by the Contractor.																
1.01.05	Contractor shall supply all cable erection and laying hardware from the main trunk routes like branch cable trays/sub-trays, supports, flexible conduits, cable glands, lugs, pull boxes etc. on as required basis for all the systems covered under this specification.																
1.01.06	Wherever the quantity has been defined as on as required basis, the same are to be furnished by contractor on as required basis within his quoted lump sum price without any further cost implication to the Employer.																
2.00.00	SPECIFICATION OF INSTRUMENTATION CABLE																
2.01.00	Common Requirements																
	<table border="1"> <thead> <tr> <th data-bbox="375 1163 472 1241">S. No.</th> <th data-bbox="477 1163 813 1241">Property</th> <th data-bbox="818 1163 1425 1241">Requirement</th> </tr> </thead> <tbody> <tr> <td data-bbox="375 1247 472 1304">1</td> <td data-bbox="477 1247 813 1304">Operating Voltage</td> <td data-bbox="818 1247 1425 1304">225 V (peak value)</td> </tr> <tr> <td data-bbox="375 1310 472 1472">2.</td> <td data-bbox="477 1310 813 1472">Codes and standard</td> <td data-bbox="818 1310 1425 1472">All instrumentation cables shall comply with VDE 0815, VDE 0207, Part 4, Part 5, Part 6, VDE 0816, VDE 0472, SEN 4241475, ANSI MC 96.1, IS-8784, IS-10810 (latest editions) and their amendments read along with this specification.</td> </tr> <tr> <td data-bbox="375 1478 472 1556">3.</td> <td data-bbox="477 1478 813 1556">Continuous operation suitability</td> <td data-bbox="818 1478 1425 1556">At 205 Deg C for Type-C cables & heat resistant cables, at 70 Deg C for all other type of cables.</td> </tr> <tr> <td data-bbox="375 1562 472 1829">4.</td> <td data-bbox="477 1562 813 1829"> Marking :- a. <i>Progressive automatic on-line sequential marking of length in meters to be provided at every one meter on outer sheath.</i> b. Marking to read 'FRLS' to be provided at every 5 meters on outer sheath except for Type-C cable c. Durable marking at intervals not exceeding 625 mm shall include manufacturer's name, insulation material, conductor's size, number of pairs, voltage rating, type of cable, year of manufacturer to be provided on outer sheath. </td> <td data-bbox="818 1562 1425 1829"></td> </tr> </tbody> </table>	S. No.	Property	Requirement	1	Operating Voltage	225 V (peak value)	2.	Codes and standard	All instrumentation cables shall comply with VDE 0815, VDE 0207, Part 4, Part 5, Part 6, VDE 0816, VDE 0472, SEN 4241475, ANSI MC 96.1, IS-8784, IS-10810 (latest editions) and their amendments read along with this specification.	3.	Continuous operation suitability	At 205 Deg C for Type-C cables & heat resistant cables, at 70 Deg C for all other type of cables.	4.	Marking :- a. <i>Progressive automatic on-line sequential marking of length in meters to be provided at every one meter on outer sheath.</i> b. Marking to read 'FRLS' to be provided at every 5 meters on outer sheath except for Type-C cable c. Durable marking at intervals not exceeding 625 mm shall include manufacturer's name, insulation material, conductor's size, number of pairs, voltage rating, type of cable, year of manufacturer to be provided on outer sheath.		
S. No.	Property	Requirement															
1	Operating Voltage	225 V (peak value)															
2.	Codes and standard	All instrumentation cables shall comply with VDE 0815, VDE 0207, Part 4, Part 5, Part 6, VDE 0816, VDE 0472, SEN 4241475, ANSI MC 96.1, IS-8784, IS-10810 (latest editions) and their amendments read along with this specification.															
3.	Continuous operation suitability	At 205 Deg C for Type-C cables & heat resistant cables, at 70 Deg C for all other type of cables.															
4.	Marking :- a. <i>Progressive automatic on-line sequential marking of length in meters to be provided at every one meter on outer sheath.</i> b. Marking to read 'FRLS' to be provided at every 5 meters on outer sheath except for Type-C cable c. Durable marking at intervals not exceeding 625 mm shall include manufacturer's name, insulation material, conductor's size, number of pairs, voltage rating, type of cable, year of manufacturer to be provided on outer sheath.																
LOT-2 PROJECTS FLUE GAS DESULPHURISATION (FGD) SYSTEM PACKAGE	TECHNICAL SPECIFICATION SECTION – VI BID DOC. NO.:CS-0011-109(2)-9	PART-B SUB-SECTION-III-C4 INSTRUMENTATION CABLES	PAGE 1 OF 12														

CLAUSE NO.	TECHNICAL REQUIREMENTS				
2.02.00	S. No.	Property	Requirement		
	5.	Allowable Tolerance on overall diameter	+/- 2 mm (maximum) over the declared value in data sheet		
	6.	Variation in diameter	Not more than 1.0 mm throughout the length of cable.		
	7.	Ovality at any cross-section	Not more than 1.0 mm		
	8.	CAGE-CLAMP suitability	To be provided		
	9.	Color	The outer sheath shall be of blue color.		
	10.	Others	Repaired cables shall not be acceptable.		
2.02.00	Specific Requirements				
	Specification Requirements	Type-A cable	Type-B cable	Type F & G cable	Type-C cable
	A. CONDUCTORS				
	Cross section area	0.5 sq. mm			
	Conductor material	ANSI type KX	ANSI type SX	Annealed bare copper	ANSI type KX
	Colour code	Yellow-Red	Black-Red	As per VDE-815	Yellow-Red
	Conductor Grade	As per ANSI MC 96.1		Electrolytic	As per ANSI MC 96.1
	No & dia of strands	7x0.3 mm (nom)			
	No. of Pairs	2	2	2/4/8/12/16/24 / 48	2
	Max. conductor loop resistance per Km (in ohm) at 20 deg. C	As per ANSI MC 96.1		73.4	As per ANSI MC 96.1
	Reference Standard	As per ANSI MC 96.1		VDE : 0815	As per ANSI MC 96.1
	B. INSULATION				
LOT-2 PROJECTS FLUE GAS DESULPHURISATION (FGD) SYSTEM PACKAGE	TECHNICAL SPECIFICATION SECTION – VI BID DOC. NO.:CS-0011-109(2)-9		PART-B SUB-SECTION-III-C4 INSTRUMENTATION CABLES	PAGE 2 OF 12	

CLAUSE NO.	TECHNICAL REQUIREMENTS				
Specification Requirements	Type-A cable	Type-B cable	Type F & G cable	Type-C cable	
Material	Extruded PVC type YI 3			Teflon (i.e. extruded FEP)	
Thickness in mm (Min/Max)	0.25/0.35			0.4 / 0.50 (nominal)	
Volume Resistivity (Min) in ohm-cm	1 x 10 ¹⁴ at 20 deg. C & 1x10 ¹¹ at 70 deg. C.			2.8x 10 ¹⁴ at 20 deg. C & 2x10 ¹¹ at 205 deg. C.	
C. PAIRING & TWISTING					
Max. lay of pairs (mm)	50				
Single layer of binder tape on each pair provided	Each core printed with number or Numbered binder tape to be provided on each pair	Yes		Each core printed with number or Numbered binder tape to be provided on each pair	
Bunch (Unit Formation) for more than 4P	N.A	To be provided		N.A	
Conductor /pair identification as per VDE0815	N.A.	To be provided		N.A.	
D. SHIELDING					
Type of shielding	Al-Mylar tape				
Individual pair shielding	No	To be provided for F-type cable		No	
Minimum thickness of Individual pair shielding	No	0.028mm (28 micron)		No	
Overall cable assembly shielding	To be provided				
Minimum thickness of Overall cable assembly shielding	0.055 mm (55 micron)				
Coverage / Overlapping	100% / 20%				
LOT-2 PROJECTS FLUE GAS DESULPHURISATION (FGD) SYSTEM PACKAGE	TECHNICAL SPECIFICATION SECTION – VI BID DOC. NO.:CS-0011-109(2)-9	PART-B SUB-SECTION-III-C4 INSTRUMENTATION CABLES	PAGE 3 OF 12		

CLAUSE NO.	TECHNICAL REQUIREMENTS				
Specification Requirements	Type-A cable	Type-B cable	Type F & G cable	Type-C cable	
Drain wire provided for individual shield	N.A.	Yes (for F-type)	Size- 0.5 sqmm No of strands-7 Dia of strands- 0.3mm Annealed Tin coated copper	N.A.	
Drain wire provided for overall shield	Yes, Size- 0.5 sqmm, No of strands-7, Dia of strands- 0.3mm, Annealed Tin coated copper				
E. FILLERS (if applicable)					
Non-hygroscopic, flame retardant	To be provided				
F. OUTER SHEATH					
Material	Extruded PVC compound YM1 with FRLS properties		Teflon (i.e. extruded FRP)		
Minimum Thickness at any point	1.8 mm		0.4 mm		
Nominal Thickness at any point	>1.8 mm		0.5 mm		
Resistant to water, fungus, termite & rodent attack	Required				
Minimum Oxygen index as per ASTM D-2863	29 %		N.A.		
Minimum Temperature index as per ASTM D-2863	250 deg.C		N.A.		
Maximum Acid gas generation by weight as per IEC-60754-1	20%		N.A.		
Maximum Smoke Density Rating as per ASTM D-2843	60%		N.A.		
(defined as the average area under the curve when the results of smoke density test plotted on a curve indicating light absorption vs. time as per ASTM D-2843)					
LOT-2 PROJECTS FLUE GAS DESULPHURISATION (FGD) SYSTEM PACKAGE	TECHNICAL SPECIFICATION SECTION – VI BID DOC. NO.:CS-0011-109(2)-9	PART-B SUB-SECTION-III-C4 INSTRUMENTATION CABLES	PAGE 4 OF 12		

THIS IS PART OF TECHNICAL SPECIFICATION PE-TS-468-571-A901 REV 00.

CLAUSE NO.	TECHNICAL REQUIREMENTS				
Specification Requirements	Type-A cable	Type-B cable	Type F & G cable	Type-C cable	
Reference standard	VDE207 Part 5,VDE-816			VDE207 Part 6 ASTM D2116	
G. Electrical Parameters					
Mutual Capacitance Between Conductors At 0.8 KHz (Max.)	200 nF/km		120 nF/km for F type 100 nF/km for G-type	200 nF/km	
Insulation Resistance (Min.)	100 M Ohm/Km				
Cross Talk Figure (Min.) At 0.8 KHz	60 dB		60 dB	60dB	
Characteristic Impedance (Max) At 1 KHz	N.A.		320 OHM FOR F-TYPE 340 OHM FOR G-TYPE	N.A.	
Attenuation Figure At 1 KHz (Max)	N.A.		1.2 db/km	N.A.	
H. COMPLETE CABLE					
Complete Cable assembly	Shall pass Swedish Chimney test as per SEN-SS 4241475 class F3.			N.A.	
Flammability	Shall pass flammability as per IEEE-383 read in conjunction to this specification			As per manufacturer's standard subject to employer's approval	
I. CABLE DRUM					
Type	Non-returnable wooden drum (wooden drum to be constructed from seasoned wood free from defects with wood preservative applied to entire drum) or steel drum.				
Length	1000 m \pm 5% for up to & including 12 pairs 500 m \pm 5% for above 12 pairs				
LOT-2 PROJECTS FLUE GAS DESULPHURISATION (FGD) SYSTEM PACKAGE	TECHNICAL SPECIFICATION SECTION – VI BID DOC. NO.:CS-0011-109(2)-9	PART-B SUB-SECTION-III-C4 INSTRUMENTATION CABLES	PAGE 5 OF 12		

THIS IS PART OF TECHNICAL SPECIFICATION PE-TS-468-571-A901 REV 00.

CLAUSE NO.	TECHNICAL REQUIREMENTS				
	Specification Requirements	Type-A cable	Type-B cable	Type F & G cable	Type-C cable
	<p>Note: Heat resistant instrumentation cable shall have same specification as of G/F type instrumentation cable as specified above, except that insulation and outer sheath material shall be Teflon and cable shall be suitable for continuous operation at 205 Deg. C</p> <p>Penetration of water resistance and impact resistance shall be as per IEC standard.</p> <p>SPECIFICATION OF CONTROL & POWER SUPPLY CABLES</p> <p>Refer Electrical sub-sections</p> <p>INSTRUMENTATION CABLE INTERCONNECTION AND TERMINATION PHILOSOPHY</p> <p>The cable interconnection philosophy to be adopted shall be such that extensive grouping of signals by large scale use of field mounted Group Junction Boxes (JBs) at strategic locations (where large concentration of signals are available, e.g. valves limit & torque switches, switchgear) is done and consequently cable with higher number of pairs are extensively used. The details of termination to be followed are mentioned in the given Table A.</p> <p>TABLE A: CABLE TERMINATION TO BE FOLLOWED</p>				
LOT-2 PROJECTS FLUE GAS DESULPHURISATION (FGD) SYSTEM PACKAGE	TECHNICAL SPECIFICATION SECTION – VI BID DOC. NO.:CS-0011-109(2)-9		PART-B SUB-SECTION-III-C4 INSTRUMENTATION CABLES		PAGE 6 OF 12

CLAUSE NO.	TECHNICAL REQUIREMENTS					
	Application		Type Of Termination			Type Of Cable
	FROM (A)	TO (B)	END A	END B		
	Valves/dampers drives (Integral Junction box)	Marshalling / Marshalling – cum Termination Cubicle / local group JB	Plug in connector	Post mount cage clamp type.	G	
	Transmitters, Process Actuated switches mounted in LIE/LIR	Integral Junction box of LIE/LIR	Plug in connector	Cage clamp (Rail mount) type.	F,G	
	RTD heads	Local junction box	Plug in connector	Cage clamp (Rail mount) type.	F	
	Thermocouple	Local junction box / CJC box (if applicable)	Plug in connector	Cage clamp (Rail mount) type.	A, B, C*	
	Other Field mounted Instrument	Local JB / Group JB	Plug in connector	Cage clamp (Rail mount) type.	F,G	
	RTD	Temperature transmitter	Plug in connector	Screwed, Cage clamp type	F	
	Thermocouple	Temperature transmitter	Plug in connector	Screwed, Cage clamp type	A, B, C*	
	Local Junction box, Temperature Transmitter, Int. Junction box of LIE/ LIR/ MCC/SWGR	Group JB	Cage clamp (Rail mount) type.	Cage clamp (Rail mount) type.	F,G	
	Local Junction box, Temperature Transmitter, Int. Junction box of LIE/ LIR/ Group JB / MCC/SWGR	Marshalling / Marshalling – cum Termination Cubicle	Cage clamp (Rail mount) type.	Cage clamp (Post mounted) type.	F,G	
	Marshalling cubicle/ Termination Cabinet	Electronic system cabinet	Cage clamp (Post mounted) type.	Plug-in connector / other system as per Mfr.'s Standard	Internal wiring	