

# Notice Inviting Tender- Special Conditions of Enquiry

BHARAT HEAVY ELECTRICALS LIMITED, JAGDISHPUR

Annexure-I

RFQ Ref: 2100098

Date: 09.10.2021

Instruction to Bidders and Special Terms and conditions for supply of Cold Rolled Non-Grain Oriented Sheet Steel under open tender enquiry. Online bids are invited in Two-Part Bid as per following details;

## 1. Tender quantity & tentative delivery schedule

Sl. No.	Item/Size	BHEL Spec	Size (in mm)			Qty in MT	Delivery
			Thk	Width	Length		
1	SU1091799822 Cold Rolled Non-Grain Oriented Sheet Steel Insulated, Gr-530	TM10472 Rev-03	0.5	710	COIL	1000	Within 16 WEEKS from the date of PO

- Quantity tolerance +/-5% shall be applicable
- Coil weight shall be 3 MT- 6MT subjected to consideration of nominal ID of the coil to be 508 mm and maximum OD up to 1500 mm.

2. **Pre-Qualification Criteria:** Compliance to Pre-Qualification Requirement (Attached at Annexure-III) is mandatory. In absence of PQR compliance, offer may be liable for rejection

3. **BIS license for supplying mill:** - BIS certification is mandatory for Cold Rolled NGO supplying mill from 01-Jul-2014 onwards or as per the Steel and Steel Products (Quality control) Second (Amendment) Order, 2012 dated 31.03.2014. Offer in line with Steel quality control order shall only be considered for further evaluation and price bid opening.

4. **Delivery Period:** BHEL's delivery requirement shall be as per enquiry and bidders are requested to consider the same while quoting their contractual delivery period. Delivery requirement shall be 16 weeks from date of PO.

## 5. Clause by Clause acceptance

A. Bidder shall confirm clause by clause acceptance to all the terms and conditions of the enquiry, Purchase specifications mentioned above and bring out deviations, if any from-

- Purchase specification of enquiry item- TM10472 Rev-03
- Packing and marking as per specification.
- Terms and conditions contained in this Annexure-I: Special condition of enquiry & General Terms and Conditions (Annexure-II).
- All testing requirement as called in the purchase specifications must be part of the MTC to be issued by the Mill at the time of supply.

B. BHEL reserve the right to accept or reject the bid for deviation offered w.r.t clause 5.A.

## 6. Evaluation of bids:

a. Offers will be evaluated on total delivered/landed cost (HESG in Rs PMT basis) at BHEL Jagdishpur and Purchase order will be awarded accordingly.

b. **Levy of Penalty for delayed performance:** - Penalty @ 0.5% per week or part there of subject to maximum of 10% on total order value shall be applicable for delayed performance on undelivered portion. Failure on the part of the bidder to accept this clause will attract the loading of maximum 10% on the quoted price for the purpose of evaluation. LD recovery, the applicable GST shall also be recoverable from vendors. Receipt of material at BHEL FSIP Jagdishpur will be taken as proof of delivery.

c. Bidders may note that quoted rates shall be loaded for any deviation from the terms & conditions given in this enquiry, to arrive at landed rate.

d. Offers will be evaluated at Merit duty basis. In case of any change in MOA, the same will be communicated to bidders before price bid opening.

## Notice Inviting Tender- Special Conditions of Enquiry

7. **Payment terms:** Payment shall be made within 90 days against receipt subject to acceptance of material or within 45 days against receipt subject to acceptance of material as per the MSMED act, whichever is applicable to the supplier with no bank charges.  
Udyam Registration certificate is to be submitted with bid Part-I by the bidders and is mandatory to avail MSE benefit.  
However, in case of any deviation from above payment terms offer may not be considered, if the same is accepted by BHEL will be loaded at the rate of SBI base rate + 6% for price comparison purposes on cost to BHEL basis as per present practice.
8. **Documentation:** One set of **Original Test Certificates** shall be sent by Courier addressed to Purchase department of respective unit of BHEL after the dispatch of goods to purchasing Units along with other documents as mentioned in the Annexure-II. Vendor should ensure that the Test certificates (TC) issued by them must include Purchase Order no., Customer name i.e., M/s Purchasing unit of BHEL. Test certificates should cover results of tests for Mechanical and Electrical properties as per specification for each Coil No / Heat No.
9. **Consignee Address-**The Store Officer, CS Store, BHEL FSIP, I.A. Jagdishpur, Distt. Amethi (U.P.)-227817
10. **Billing Address-**Dy. MANAGER (Finance-Store bill), BHEL FSIP, I.A. Jagdishpur, Distt. Amethi (U.P.)-227817
11. **Advisory Note:** Vendors are advised to ensure supply of material as per technical specifications and other technical documents. Further, vendors are advised to strictly adhere to tolerance ranges of the specifications. Any deviation from technical parameters will result in rejection of material. However, bidder to note that under exigency/urgency conditions, BHEL may accept the material with minor deviations after penalizing the vendors as per BHEL quality / engineering recommendations (Quality Deficiency Review Committee – QDRC) depending on the nature and gravity of quality issue.
12. Tender submission Process :
- The E-TENDER should be submitted through <https://eprocurebhel.co.in/nicgep/app>, in two part bid system not later than due date / due time. Tenders will be opened on due date / time.
  - All subsequent corrigendum/amendment shall be published on BHEL website ([www.bhel.com](http://www.bhel.com)) and government website (i.e. CPPP) and not in press. Hence, bidders are advised to be in touch with above website till the tender is finally opened.

### **NOTE: Reverse Auction shall be conducted against this tender enquiry**

13. Complete tender documents can be downloaded from BHEL corporate website [www.bhel.com](http://www.bhel.com) also.
14. Bidders to give acceptance to **Conciliation clause** as per annexure enclosed.
15. Compliance to **MAKE IN INDIA** circular issued by GoI:  
“For this procurement, the local content to categorize a supplier as a Class I local supplier / Class II local supplier / Non-Local Supplier and purchase preference to Class I local supplier, is as defined in Public Procurement (Preference to Make in India), Order 2017 dated 04.06.2020 issued by DPIIT. In case of subsequent orders issued by the nodal ministry, changing the definition of local content for items of the NIT, the same shall be applicable even if issued after issue of this NIT, but before opening of Part II bids against this NIT”  
**Only ‘Class I local supplier’ and ‘Class II local supplier’ as defined under the order shall be eligible to bid in procurements under this tender.**
- Important Note:** *The bidder will, when presenting his bid, declare whether other family firms or sister concern Affiliates / subsidiary firms are participating in same tender, so as to eliminate the possibility of cartel formation. Format for declaration is attached.*
16. The evaluation currency for this tender shall be INR
17. **Integrity Pact (IP) – Independent external monitor (IEM):-**
- IP is a tool to ensure that activities and transactions between the company and its bidders/contractors are handled in a fair, transparent and corruption free manner.  
Following Independent External Monitors (IEMs) on the present panel have been appointed by BHEL with the approval of CVC to oversee implementation of IP in BHEL.

## Notice Inviting Tender- Special Conditions of Enquiry

Sl. No.	Name of IEM	Contact Detail
1	Shri Arun Chandra Verma, IPS (Retd.)	<a href="mailto:acvermal@gmail.com">acvermal@gmail.com</a>
2	Shri Virendra Bahadur Singh, IPS (Retd.)	<a href="mailto:vbsinghips@gmail.com">vbsinghips@gmail.com</a>

- (b) The IP as enclosed with the tender is to be submitted (duly signed by authorized signatory who signs in the offer) along with techno commercial bid. Only those bidders who have entered into such an IP with BHEL would be competent to participate in the bidding. In other words, entering into this pact would be a preliminary qualification.
- (c) Please refer section 8 of the IP for roles and responsibilities of IEMs. In case of any complaint arising out of tendering process, the matter may be referred to any of the above IEMs mentioned in the tender. All correspondence with the IEMs shall be done through e-mails only.

Note:

No routine correspondence shall be addressed to the IEM (phone/ post/ email) regarding the clarifications, time extensions or any other administrative queries, etc on the tender issued. All such clarification/ issues shall be addressed directly to the tender issuing (procurement) department. For all clarifications/ issues related to the tender, Please contact:

Name	Vaibhav Jain	Manager-MM
Contact Detail	05361-224125	<a href="mailto:vjain@bhel.in">vjain@bhel.in</a>
Address	FP Administrative building, BHEL FSIP Jagdishpur - 227817	

### 18. Enclosure with Enquiry

- Annexure I-** Special conditions of the enquiry (3 pages): To be filled completely and **to be attached along with the Part-I-technical offer.**
- Annexure II-** General Terms and conditions of the enquiry and its annexures
- Annexure III-** Pre-Qualification Requirement
- Annexure IV-** Material specifications TM10472 Rev 03.
- Annexure V-** Integrity Pact

In case of any further assistance in this tender please contact following persons:

Vaibhav Jain / Manager (MM) BHEL Jagdishpur, Amethi (UP)- 227817 Ph: 05361-224125 Email: <a href="mailto:vjain@bhel.in">vjain@bhel.in</a>	Vasu Dev /Engineer (MM) BHEL Jagdishpur, Amethi (UP)- 227817 Ph: 05361-224238 Email: <a href="mailto:vasuyadav@bhel.in">vasuyadav@bhel.in</a>
--	--

Noted and accepted / accepted except the deviations enclosed

(Strike-off whichever is not applicable)

Name & Signature of Authorized signatory

# Notice Inviting Tender- Special Conditions of Enquiry

Annexure-II

Sl. No	Description	Supplier Confirmation
1	Confirmation to Supply Material as per Enquiry Material Specification	
2	Confirmation to Supply Material as per Enquiry size and quantity	
3	All testing requirement as called in the Purchase specifications must be part of the Mill TC report to be issued by the mill along with supply.	
4	Acceptance of late delivery penalty clause ( Refer Clause 9 of Annexure-II- Enquiry GTC & clause 6.b of Annexure I)	
5	Lead time for supply of Cold Rolled Non-Grain Oriented Sheet Steel shall be 12 weeks from date of PO.	
6	Confirmation that supplying mill is BIS approved for quoted material grade	
7	Supplier shall maintain minimum heat number for their supplies	
8	Validity of the rates (for issuance of Purchase Orders) - 90 days from technical bid opening date.	
9	Acceptance of Part order quantity	
10	Acceptance to conciliation clause	
11	In case of rejection, BHEL reserve the right to withhold the payment of rejected lot & supplier must withdraw the bill of exchange unconditionally.	
12	Inspection at BHEL shall be final & binding.	
<b><u>Additional details required</u></b>		
1	Delivery on FOR BHEL Unit basis with transit insurance risk to be borne by supplier. All transit risk shall be covered under clause inland Rail & Road-A (IRR-A).	
2	IGST / (CGST + SGST) extra as applicable against ITC	
3	Payment terms - ' <b>100% Direct within 90 days of receipt' and as per clause 16 of GTC.</b>	
4	Supplier shall have valid GST Registration	
5	Supplier shall mention their GSTN registration number in their invoices. Invoice no which is linked /uploaded in GSTN network shall be clearly indicated in invoice	
6	All invoices shall bear the HSN code for each item separately.	
7	Confirmation that all invoice particulars will be uploaded in the GSTN network / portal and all tax liability will be discharged as per GST rules and regulations.	
8	Submission of declaration for having local content as per of clause 15 of Annexure-I	

- For any deviation from BHEL Standard Commercial terms, your offer shall be loaded suitably.
- In case of deviation in any of the above conditions, please spell out clearly & strike off table not applicable.

**Sign & Seal of the Vendor**



## GENERAL TERMS AND CONDITIONS OF ENQUIRY

Sl. No.	Description
1	<b>General:</b>
A	These General terms & conditions (GTC) shall apply to all enquiries, notice inviting tenders, request for quotations concerning the supply of goods and / or rendering of services to Bharat Heavy Electricals Ltd., Jagdishpur (hereinafter referred to as BHEL or the Purchaser) or its Projects / Customers. Special / supplementary enquiry conditions, if any, will override the conditions in this annexure.
2	<b>General Instructions - Common for Indigenous &amp; Foreign enquiries</b>
A	<b>Through E- procurement-</b>
	<ol style="list-style-type: none"><li>1. Offer shall be submitted by the bidders in single / two parts as called in Tender enquiry.</li><li>2. Bid Part - I Technical cum Commercial bid Bid Part - II Price bid</li><li>3. Suppliers shall quote <b>price</b> on BHEL/authorised third party service provider <b>e-procurement site <a href="https://bhel.abcprocure.com">https://bhel.abcprocure.com</a></b>. Any deviation from the price format shall be clearly brought out in the offer Bid part-I.</li></ol> <p>The offer shall be uploaded on BHEL e-procurement site using Class III digital signature. <b>Bidders to put sign and seal on all the uploaded documents.</b> The quotation should be uploaded on the site before due date and time.</p> <p>Part-I of the bid shall contain complete item-wise scope of supply as offered vis-à-vis the scope of supply as per enquiry, all commercial terms and conditions etc. It is expected that bidders shall meet all our technical and commercial requirements and shall not deviate from them.</p>
B	<b>Through Tender Room</b>
B1	Sealed bids are invited for scope of Supply / Services as detailed in the enquiry. The quotation should be neatly typed and free from over writing/ erasures. Any correction or addition must be authenticated. The bid should be submitted in English or Hindi language. Relevant enclosures, supporting documents, catalogue, samples, if any, as required as per Notice Inviting Tender (NIT) conditions shall be sent along with technical offer. Rate should be quoted in the units asked for in the enquiry. The rates should be quoted both in figures and words. In case of discrepancy in figures and words, the rates quoted in words shall be considered.
B2	Bids shall be submitted in a Sealed cover with Enquiry No., Due date and Bidder's name indicated on the cover. In case of Two part Bid, technical bid containing technical offer, this GTC duly filled-in & signed; and <b>un-priced copy</b> of the Price Bid should be kept in one envelope. Price Bid containing only the price (as called for in the price format where required) should be kept in a separate envelope. Both envelopes indicating Part-I or Part-II as the case may be to be put in a bigger envelope, which should be addressed to In charge, Tender Box, Administrative Building BHEL FSIP, Industrial Area Jagdishpur, Dist. Amethi-227817, (U.P.) India. Enquiry No., due date and bidder's name must be mentioned on all envelopes. Offer must reach tender box of BHEL FSIP Jagdishpur by 15.00 PM IST on the enquiry due date.
B3	Offer received after <b>15.00 PM IST</b> of the due date will be termed as "Late Tender" and shall not be considered.
B4	Bidder can also submit offer through email, if called for in the enquiry, at the email address indicated in the enquiry. Such email offers shall be sent only on designated email-id to reach before 15.00 PM IST on the tender due date. BHEL will not be responsible for incomplete offers and the ones delivered late through e-mail.
C	Commercial Conditions quoted by the vendor in any place including as stated in bidder's 'General Terms and Conditions' if any, shall not be binding on the Purchaser and the conditions contained in this annexure, including special conditions, if any, for this enquiry shall only prevail.
D	<b>Wherever Reverse Auction is called for</b> <b>REVERSE AUCTION (RA):</b> "BHEL shall be resorting to Reverse Auction (RA) (Guidelines as available on <a href="http://www.bhel.com">www.bhel.com</a> ) for this tender. RA shall be conducted among all the techno-commercially qualified bidders. Price bids of all techno-commercially qualified bidders shall be opened and same shall be considered as initial bids of bidders in RA. In case any bidder(s) do(es) not participate in online Reverse Auction, their sealed envelope price bid along with applicable loading, if any, shall be considered for ranking."



## GENERAL TERMS AND CONDITIONS OF ENQUIRY

	<p><b>Wherever Reverse Auction is not called for</b></p> <p><b>PRICE BID OPENING:</b> Tender shall be finalized via price bid opening of all the techno-commercially qualified bidders in place of RA.</p> <p>Price bid should contain only price of item. Anything other than price of item shall be invalid. <i>Tender finalization mode (RA or Price bid opening) shall be specified in Special / supplementary enquiry conditions.</i></p>
E	The goods offered shall conform to BHEL specifications and / or National/International standards as mentioned in the Enquiry and the bidder is required to confirm his unconditional acceptance to the same. Vendors, seeking deviations from the specifications and any other conditions, may indicate the same clearly on a separate sheet, with reasons for such deviations. <b>BHEL reserves the right to reject the offer with deviations or load the deviations suitably for evaluation.</b>
F	Offers shall be submitted directly by vendor or his authorized agent only. Unsolicited offers shall be summarily rejected.
G	Bid in single part or techno-commercial bid in <b>two-part</b> system (as the case may be) will be opened on the due date. In case of two part bid, price bids of techno-commercially acceptable bidder(s) only shall be opened on the assigned date.
H	In case of changes in scope and / or technical specification and / or commercial terms & conditions, having price implication, techno-commercially acceptable bidders shall be asked by BHEL to submit the impact of such changes on their price bids. In case a bidder opts to submit revised price bid instead of impact called for, then latest price bid shall prevail.
I	The bidders will submit Integrity Pact, duly signed by its authorized signatory, where called for in the enquiry.
J	Wherever the enquiry is issued to unregistered vendor, the bidder shall visit ' www.bhel.com and online filled up "Supplier Registration Form" on BHEL link ( <a href="http://supplier.bhel.in">http://supplier.bhel.in</a> ) along-with all the supporting documents to be submitted.
K	BHEL expects that the bidder must respond to the enquiry. Regret letter, with valid reasons for not participating in the tender will be submitted where the bidder is unable to submit offer. Repeated lack of response on the part of vendor (Four non responses) may lead to his deletion from BHEL's approved vendor list.
L	Goods shall be properly packed to avoid transit damage. Suitable markings shall be provided to identify the goods with that of the PO No. and the consignee details.
M	Goods shall be consigned to Store Officer, BHEL, FSIP, IA Jagdishpur Dist- Amethi (U.P.) India, unless otherwise specified in the PO.
N	All corrigenda, addenda, amendments, time extensions, clarifications etc. to the tender will be hosted on BHEL website ( <a href="http://www.bhel.com">www.bhel.com</a> )/( <a href="https://eprocure.gov.in/epublish/app/">https://eprocure.gov.in/epublish/app/</a> )/( <a href="https://bhel.abcpocure.com">https://bhel.abcpocure.com</a> ) website only.
O	In the course of evaluation, if more than one bidder happens to occupy L-1 status, effective L-1 will be decided by soliciting discounts from the respective L-1 bidders. In case more than one bidder happens to occupy the L-1 status even after soliciting discounts, the L-1 bidder shall be decided by a toss / draw of lots, in the presence of the respective L-1 bidder (s) or their representative(s). Ranking will be done accordingly. BHEL's decision in such situations shall be final and binding.
P	The Purchaser can consider awarding tendered quantities among more than one bidder (after acceptance of L1 price by the other bidders) in the manner and proportion disclosed in the tender conditions. Purchaser can also consider awarding of part of the tendered quantity to other than L-1 bidder at L1 counter offered rates, if the quantity offered by the L-1 bidder is less than the quantity tendered for.
Q	The bidder shall submit price bid strictly in the price format, wherever provided for, in the enquiry. Any attempt on the part of the bidder to alter the contents of the price bid format in any manner, which in the opinion of BHEL can vitiate the tendering process, will lead to rejection of the bid, <b><i>besides BHEL taking appropriate punitive action as deemed fit.</i></b>
R	In case the bidder decides to sub-contract part of his activity / work to some of his vendors, details of such intended subcontracting shall be mentioned in the bid. This will however not absolve the bidder from his contractual obligations and responsibilities.
S	Wherever the minimum reserved capacity is called for in the tender, the offers of such bidders, who do not quote for the minimum reserved capacity, are liable to be rejected.



## GENERAL TERMS AND CONDITIONS OF ENQUIRY

3	<b>Delivery Terms</b>	
A	<b>Indigenous Purchase</b>	
	Goods shall be delivered on 'FOR Destination' basis (with freight and insurance in bidder scope) to the named destination unless otherwise called for in the enquiry.	
B	<b>Foreign Purchase — Imports</b>	
B1	<ol style="list-style-type: none"> <li>1. Goods shall be despatched by Sea, unless stated otherwise in the enquiry or purchase order.</li> <li>2. Terms of Delivery for Sea shipment shall be on CFR / CIF basis with 14 days' detention free period for FCL (Full Container Load) Cargo of GP &amp; HC Containers.</li> <li>3. For other cases - Other than GP &amp; HC Containers, LCL Cargo shall be delivered at Nhava Sheva (JNPT) &amp; Break-bulk Cargo at Mumbai (MPT).</li> <li>4. For Air consignments, the terms of delivery shall be FCA at BHEL nominated Airport.</li> <li>5. Freight amount shall be indicated separately in the offer in case of CIP/CFR/CIF.</li> <li>6. The number of detention free days and destination charges payable to shipping line must be mentioned in your offer and also on the Bill of Lading.</li> <li>7. Offer received on FOB basis may be considered on an exceptional basis. BHEL will load freight, marine insurance &amp; shipping line port handling charges etc. to work out landed cost at Sea Port.</li> <li>8. Please visit BHEL Jagdishpur website <a href="http://www.bhelbpl.co.in">www.bhelbpl.co.in</a> for details of named Air ports and Sea ports. Name of the gateway port so chosen by the Seller shall be indicated by the Bidder in his offer.</li> </ol>	
B2	<ol style="list-style-type: none"> <li>1. For delivery of FCL (Full Container Load) cargo, the Bidder shall provide minimum <b>14 days' detention free period</b> from the date of delivery at Port of Discharge / Place of Delivery (in case of ICD). Wherever the detention free period offered is less than 14 days, the bids shall be <b>loaded</b> for the period short of 14 days' period.</li> <li>2. <u>Port Congestion charges or any additional charges claimed by the shipping line at Port of Discharge / Place of Delivery shall be to the Seller's account.</u></li> </ol>	
4	<b>Vendor's particulars &amp; logistics information (Bidder to give details against each of the provisions)</b>	
A	Name of the vendor's executive to deal with this tender / project	
B	E-mail address of the contact person	
C	Telephone no. of the contact person	
D	Name of location from where the goods shall be offered for inspection and dispatch	
5	<b>Additional logistics information for Imports</b>	
A	Bid currency	
B	Charges applicable at discharge port up to BHEL's CFS (Container Freight Station) to be indicated in your offer and on the B/L	
C	Name of Airport in the country of dispatch for FCA delivery terms	
D	Estimated number, type & size of containers for delivery of tendered quantity (applicable where the goods are to be sent in FCL)	
E	No. of packages with cumulative gross weight and CBM volume (applicable for LCL & Break-bulk shipment)	



## GENERAL TERMS AND CONDITIONS OF ENQUIRY

F	Approx. distance in km. from Vendor's works to Port of Loading	Sea port /Air port
6	<b>Delivery Schedule &amp; Completion date</b>	
A	<ul style="list-style-type: none"> <li>• Instead of writing specific date against delivery offered, bidder shall commit delivery period in number of days / weeks/ months to suit the delivery period indicated in the enquiry.</li> <li>• Commencement of delivery period shall be reckoned from the date of PO / LOI or any other agreed milestone.</li> <li>• Seller shall deliver the goods in the manner and schedule agreed under the Purchase order.</li> <li>• Goods shall be delivered within contractual period or any extension thereof, if any, granted by the Purchaser.</li> <li>• If delivery is linked to approval of documents, time for submission of such documents to be indicated and delivery period to be indicated from approval of documents. This delivery schedule will be considered for processing delivery extension, wherever applicable.</li> <li>• BHEL reserves the right to cancel the order if material is not delivered within PO scheduled delivery.</li> <li>• In case of unsatisfactory performance on quality / delivery BHEL will have right to discontinue the contract in part or full.</li> </ul>	
B	In case of foreign supplies, the date of Bill of Lading (B/L) or AWB shall be taken as actual date of delivery.	
C	In case of Indigenous bidders, the date of delivery at named destination in India shall be taken as contractual delivery completion date where delivery terms are FOR destination. In case of 'Ex-works' delivery terms, the date of LR / RR shall be the contractual delivery completion date.	
7	<b>Transit Insurance</b>	
	Except where delivery terms are agreed on CIF basis for Imports & FOR destination basis for indigenous purchases, transit insurance will be covered by BHEL under its Open Marine Transit Insurance Policy. Seller shall inform dispatch particulars with value of consignment to the Purchaser within 07 days of dispatch for BHEL to arrange insurance coverage in its policy. Failure on the part of seller to inform dispatch particulars will make him liable to pay for any transit damages / losses suffered by the Purchaser.	
8	<b>Force Majeure</b>	
	<p>Notwithstanding anything contained in the contract, neither the Seller nor the Purchaser shall be held responsible for total or partial non-execution of any of the contractual obligations, should the obligation become unreasonably onerous or impossible due to occurrence of a 'Force Majeure' which directly affects the obligations to be performed by the Purchaser or the Seller; Such events include war, military operations of any nature, blockages, revolutions, insurrections, riots, civil commotions, insurgency, sabotage, acts of public enemy, fires, explosion, epidemics, quarantine restrictions, floods, earthquake, or acts of God, restrictions by Govt. authorities; over which the Seller or the Purchaser has no control.</p> <p>The party claiming to be affected by force majeure shall notify the other party in writing without delay, within two weeks on the intervention and on the cessation of such circumstance. Extension of time sought by the Seller along with supporting evidence and so granted by the Purchaser for the supply/ work affected, if any, shall not be construed as waiver in respect of remaining deliveries. Rescheduling of deliveries on account of force majeure conditions, if so agreed by the Purchaser, will not entail the Seller to claim any increase in the price on whatsoever account.</p> <p>Notwithstanding above provisions, Purchaser shall reserve the right to cancel the order/ Contract, wholly or partly, in order to meet the overall project schedule and make alternative arrangements. If deemed necessary, Purchaser may takeover partly processed material at a mutually agreed price.</p>	
9	<b>LD/Penalty for delayed performance.</b>	
A	<p>I. Subject to force majeure conditions, penalty shall be 0.5% of the total order value per week of delay or part thereof, subject a maximum of 10% of the total order value for deliveries going beyond contractual delivery period. Any deviation based on specific requirement shall be specified separately in the NIT.</p> <p>II. In case of staggered delivery schedule, LD shall be 0.5% of the undelivered portion per week or part thereof subject to a maximum of 10% of the undelivered portion.</p> <p>III. In case of any amendment / revision, the penalty shall be linked to the amended / revised PO.</p> <p>IV. Any loading on penalty clause shall be to the extent to which it is not agreed to by the bidder (at offered value). The same shall be intimated separately prior to price bid opening.</p> <p><b>Note:</b>  <b>“Recovery of LD will include GST as applicable”.</b></p>	



## GENERAL TERMS AND CONDITIONS OF ENQUIRY

	In case the contractually agreed delivery date falls on a holiday in BHEL FSIP Jagdishpur, the next working day shall be taken as contractual delivery date for compliance and applicability of LD / penalty.
B	<b>Risk Purchase</b>
	If the material is not supplied within the agreed delivery period, BHEL reserves the right to cancel the order and purchase the material from alternate source (s) at the Risk and Cost of the Seller. In such an event, it shall be obligatory on the part of seller to make good any loss suffered by the purchaser.
10	<b>Indian Agents and Agency commission</b>
A	BHEL prefers to deal directly with Foreign vendor, wherever required, for procurement of Goods. However if the Foreign Principal desires to avail services of an Indian Agent, then the Principal should ensure compliance to "regulatory guidelines" which will require submission of an agency agreement.
B	The CFR / CIF price quoted will be deemed to be inclusive of Indian Agency commission. Agency commission as disclosed by the bidder in his quoted CFR / CIF price will be paid in Indian Rupees on receipt & acceptance of Materials or its installation at destination, as the case may be. The lower of the 'TT buying rate prevailing on the date of technical bid opening or price bid opening shall be considered for computation of Agency commission.
C	In a tender either the Indian Agent on behalf of Principal / OEM or the Principal / OEM itself can bid, but both cannot bid simultaneously for same item / product in the same Tender. In case bids are received from both the Principal / OEM and the agent, bid received from the agent will be ignored.
D	If an agent submits Bid on behalf of the Principal / OEM, the same agent shall not submit bid on behalf of another Principal / OEM in the Tender, for the same Item / Product.
11	<b>Documentation:</b>
A	<b>Indigenous Purchase</b>
	Seller shall arrange to send to the consignee, Original Tax invoice (Buyer's copy and duplicate for Transporter), Commercial invoice in duplicate, consignee copy of LR & 2 sets each of Packing list, Test certificate, Guarantee / Warranty certificate, O & M manuals (where applicable), immediately on despatch of the goods. The distribution of such documents will be specified in the Purchase order.
B	<b>Foreign Purchase — Imports</b>
	<p><b>A. Vendor to share immediately Bill of lading with Import Invoice and packing list of material at <a href="mailto:mssea@bhel.in">mssea@bhel.in</a> and incorporate following detail in the bill of lading:</b></p> <p><b>a. Import &amp; export Code (IEC) of importer;</b> <b>b. GST Identification No (GSTIN) of importer;</b> <b>c. Official email id of importer (to be used for correspondence by shipping lines and Customs) – <a href="mailto:mssea@bhel.in">mssea@bhel.in</a> to be included.</b></p> <p><b>B. Seller shall send 1 set of following documents, in English, within 7 days of B/L date / 1 day of AWB date by courier to the Purchaser.</b></p> <ol style="list-style-type: none"><li>Express / Original 'Clean on board' Bill of Lading / AWB.</li><li>One set of Commercial Invoice, Packing list indicating container-wise Gross weight, Net weight, CBM volume, No. of packages with Dimensions of each package.</li><li>Original Certificate of Country of Origin issued by Chamber of Commerce.</li><li>One set of Original Test Certificates and O&amp;M Manual where called for.</li><li>Fumigation / Phyto Sanitary Certificate wherever cargo is packed in wooden packing or packing of plant origin material is used.</li><li>Supplier should additionally forward 2 sets of original documents mentioned at point 1 to 5 along with original bill to Lading through any international courier service / registered airmail or AWB by captain's mail within three days of obtaining the same directly to the following:</li></ol> <p>(i) AGM (M.S) Regional Operations Division BHEL 14th Floor Centre-1</p> <p>(ii) Sr.DGM (FIN) Administrative Bldg. BHEL, FSIP, IA Jagdishpur</p>



## GENERAL TERMS AND CONDITIONS OF ENQUIRY

World Trade Centre, Cuffe Parade  
Colaba, Mumbai 400 005 INDIA  
E-mail: [mssea@bhel.in](mailto:mssea@bhel.in)

Amethi, 227817, UP, India  
E-mail : [shashi.kumari@bhel.in](mailto:shashi.kumari@bhel.in)

And **confirm forwarding details** to Sr. DGM (MM), BHEL, FSIP, IA Jagdishpur 227817, Amethi , UP, India at [nasaifi@bhel.in](mailto:nasaifi@bhel.in) /[vjain@bhel.in](mailto:vjain@bhel.in)/[pkyadav@bhel.in](mailto:pkyadav@bhel.in)/[vasuyadav@bhel.in](mailto:vasuyadav@bhel.in)

7. In case the Seller decides to negotiate all 3 originals of B/L / AWB along with all original documents through negotiating Bank, non-negotiable documents (NNDs) consisting of copy of B/L / AWB & documents mentioned at Sl. no. 11- B2 to B5 will be sent by e-mail to the Purchaser at his e-mail address given in the PO with one copy to be mailed at [nasaifi@bhel.in](mailto:nasaifi@bhel.in) & [vjain@bhel.in](mailto:vjain@bhel.in) (for sea shipment). Other documents, as required, will be separately indicated in the Purchase Order. Additional expenditure, if any, incurred by the Purchaser by way of detention / demurrage, resulting out of delay attributable to the Seller in providing Negotiable documents, will be recovered from the Seller.

In case any discrepancy is raised by bankers / BHEL with respect to documents submitted, vendor to facilitate clearance of goods through Delivery Order.

C	<b>General</b>
	<ol style="list-style-type: none"><li>1. For Hazardous chemicals, the materials safety data sheet (MSDS) is to be submitted.</li><li>2. All certificates as called must be sent. BHEL may test any goods supplied and their decision is final irrespective of supplier's certificates. If test certificate and guarantee certificate are not received along with the document and stipulated in these specifications, BHEL reserves the right to get the material tested and recover the expenses from the supplier without awaiting supplier's confirmation</li></ol>
12	<b>Pricing Terms:</b>
	Prices once quoted shall remain firm within the validity or any extension thereof for placement of order, till complete execution of the order, without any escalation / increase for any reason, whatsoever, unless specifically provided for in the Enquiry & PO. In case of foreign vendors, the quoted price shall be taken as inclusive of Third Party Inspection and testing charges as called for in the NIT.
13	<b>Price Validity :</b>
	Unless stated otherwise in the enquiry, offer shall be valid for a period of <b>90 days</b> from the date of Techno- commercial (Part-I) bid opening date.
14	<b>Taxes &amp; Duties - Indigenous Purchase:</b>
A	Vendor to ensure timely remittance of SGST, CGST, IGST as applicable in time as per law.
B	Vendor to ensure compliance to filing of monthly GST sales return including BHELs supplies by 10 <sup>th</sup> of next calendar month in the online GST portal wherever applicable.
C	Vendors to declare filing of timely returns and GST remittance / likely remittance / ITC adjustment along with invoice.
D	Vendor to submit invoices compliant with GST invoice Rules
E	Vendors to comply with all statutory provisions as may be applicable at the time of despatch / sale. Any additional financial liability to BHEL on account of non-compliance by vendors shall be borne by them and shall be adjusted / recovered from the vendors. BHEL reserves the right to review the existing offers / contracts for any revision in terms, which may arise due to change in any statutory provisions to ensure that the benefit accrues to BHEL.
F	Vendor to ensure TAX INVOICE submission along with consignment
G	In respect of cases where the liability to discharge GST is on BHEL under reverse charge mechanism, vendors have to ensure timely submission of invoices and delivery of material / services to BHEL, so that there is no mismatch on both activities. In case there is any additional financial liability on BHEL on account of default on the part of the vendor on submission or delivery of material / services the same shall be passed on to them. In respect of free issue material by BHEL, vendors have to return the processed material within the time line as per the provisions of GST. In case of any additional tax liability on BHEL on account of non-compliance by the vendor, the additional financial implications on BHEL shall be passed on to the vendor.
H	Vendors to provide the applicable HSN / SAC codes as called for in the enquiry



## GENERAL TERMS AND CONDITIONS OF ENQUIRY

15	<b>Taxes &amp; Duties - Foreign Purchase — Imports</b>
	The offered prices shall be inclusive of all the Taxes and duties as applicable in the country of bidder / country of dispatch for the quoted CFR / CIF price.
16	<b>Payment Terms-</b>
A	<b>Indigenous:</b> 100% payment in 90 days of receipt (45 days for MSE including NSIC / Udyog Aadhar/EM-II/DIC along with valid CA certificate, registered suppliers as per relevant act in force), subject to acceptance of material at BHEL, on direct presentation of the documents. In case of despatch of material to site directly, site certification for receipt of materials is required unless otherwise provided for in the PO. <b>Any deviation from the above payment terms, if accepted (by BHEL), shall be loaded @ SBI base rate + 6% for the period of relaxation sought by bidder for the purpose of bid evaluation.</b>
B	<b>Foreign:</b> 100% direct Payment payable on 90 <sup>th</sup> day of B/L / AWB. <b>In case BHEL considers any deviation in payment terms i.e. early payment based on vendor's request, then bids shall be evaluated with loading @ SBI base rate + 6% for the period of relaxation sought by bidder for the purpose of bid evaluation.</b>
C	Foreign vendors to submit declaration of <b>Permanent Establishment and Business Connection (PEBC)</b> for remittances purpose. Declaration to be submitted in formats in either Annexure A or B whichever is applicable as per their transaction entered into with BHEL. In the absence of certificates from the vendor, withholding tax at applicable rates along with surcharge and cess will be recovered at the time of remittance to the vendor.
D	Foreign vendors to submit <b>Tax Residency Certificate (TRC) &amp; Form 10 F</b> (for obtaining DTAA benefits) as per Annexure C in respect of services. The TRC (tax residency certificate) is to be issued by the authorities of the government of vendor's country. If the informative part of the format (other than residency) is not furnished by the authorities the same may be furnished by the vendor as a declaration.
17	<b>Inspection of Goods</b>
A	The Seller shall give adequate notice, of 1 week or as mutually agreed period, in writing to the Purchaser (in case Customer inspection is involved) or BHEL appointed TPIA about the date and place at which the goods will be ready for inspection/ testing, as provided for in the contract.
B	Purchaser or his authorized representative shall be entitled to carry out inspection of material and Workmanship / Surveillance Audit at Seller's premises or at his sub-contractor's premises at all reasonable times during execution of contract; Such inspection, examination and testing, if made, shall not absolve the Seller from his obligations under the contract. Wherever required, BHEL may carry out testing at BHEL's testing Lab and in case of any rejection during such testing, replacement / rectification, as required, will have to be done by Supplier. If BHEL carries out any rectification of such rejected material, such cost will be recovered from Supplier's Bills. In case of Customer inspection as Supplier's Works, inspection clearance to be obtained from Customer and submitted to BHEL.
C	BHEL's representative from unit or Corporate Quality (CQ) is authorised to carry out audits along with TPIA at vendor's works before clearing the items for despatch.
D	All costs related to inspections and re-inspections shall be borne by the Seller. In case of inspection by BHEL and / or BHEL's customer, the cost of to & fro passage and Boarding & Lodging shall be borne by the Purchaser / Customer, unless otherwise specifically agreed. In case of foreign vendors, the cost of third party inspection, where called for, shall be deemed to be included in the quoted price. Seller shall be responsible to provide assistance such as labour, materials, electricity, fuels, stores, apparatus, instruments at his cost, as may be required and as may be reasonably demanded to carry out such tests effectively.



## GENERAL TERMS AND CONDITIONS OF ENQUIRY

E	<p><b>REJECTION:</b> If any goods are rejected, BHEL shall be at liberty to take action as per following at the risk and cost of supplier:</p> <ul style="list-style-type: none"><li>a) Allow the supplier, wherever mutually agreed, to rectify the rejected goods at BHEL's works within reasonable time as fixed by BHEL.</li><li>or</li><li>b) Allow the supplier to make free replacement within a specified period. Rejected goods can be lifted by the supplier there after.</li><li>or</li><li>c) In case payment has been done, allow supplier to refund equivalent value of rejected material by NEFT / RTGS or furnish Bank Guarantee for same amount before lifting the rejected goods. Fresh replacement shall be regulated as per terms and condition of the original Purchase Order. In case payment has not been done, allow the supplier, wherever mutually agreed, to rectify the rejected goods at supplier's works within reasonable time as fixed by BHEL.</li><li>or</li><li>d) Take alternate procurement action from elsewhere and recover the difference in total cost to BHEL including services, if any, incurred by BHEL in this regard from the supplier. The supplier shall not be entitled to any gain on repurchase.</li><li>or</li><li>e) Terminate the contract either in part or in whole at the discretion of BHEL and recover the loss, if any, from the supplier.</li><li>or</li><li>f) Any goods rejected by BHEL must be removed by the supplier after making payment through NEFT / RTGS within 45 days from the date of intimation of rejection or 30 days after receipt of the intimation of rejection whichever is earlier. If vendor fails to lift or allow despatch of rejected material at his cost within 90 days from the intimation of rejection, his claim on rejected material shall cease.</li></ul>
	<p><b>REJECTION:</b> <b>The supplier shall arrange replacement/repair within one month from the date of rejection intimation upon failure on supplier's part to comply. BHEL will take whatever appropriate action they may think fit in addition to repair/return of rejected material at the cost and risk of the supplier.</b></p>
18	<b>Guarantee / Warranty and corresponding Repairs / Replacement of Goods</b>
	<p>Manufacturer's works test / infection certificates shall be furnished along with the guarantee that material conforms strictly to the specification for general &amp; special conditions as laid down in the purchase order. Goods shall comply with the specifications for material, workmanship and performance. The warranty shall be for a period of 12 months from the date of receipt. If the delivery is found non-compliant during the warranty period, leading to rejection, the Seller shall arrange free replacement / repair of goods, within one month from the date of intimation or any mutually agreed period. The rejected goods shall be taken away by the Seller at his cost and replaced on Delivered Duty Paid (DDP) (FOR - BHEL Stores / designated destination basis) within such period. In the event of the Seller's failure to comply, Purchaser may take action as appropriate, including Repair / Replenish rejected goods &amp; disposal of rejections, at the risk &amp; cost of the Seller. In case the defects attributable to Seller are detected during processing of the goods at purchasers/ his subcontractor's works, the Seller shall be responsible for free replacement / repair of the goods as required by the purchaser.</p>
19	<b>Evaluation and Loading Criteria:</b>
	<p>Evaluation of the tender shall be on the basis of delivered cost, i.e. 'total cost to BHEL' w.r.t the technical scope and commercial conditions finalized after techno-commercial clarifications (after considering, inter alia, Customs Duty and GST / Other taxes as applicable). Exchange rate (TT selling rate of State Bank of India) applicable on the date of Part-I bid opening shall be considered for evaluation of foreign bids. If the relevant day happens to be a bank holiday in India, then the FOREX rate as on the previous bank working day shall be taken for evaluation. Foreign suppliers shall ensure that the benefits as applicable under Comprehensive Economic Partnership Agreement (CEPA) with Government of India are disclosed in the bid &amp; relevant documents such as Certificate of Country of Origin, issued by the appropriate authority in the country of Export is provided by the vendor along with dispatch documents. Bids shall be evaluated with such applicable benefits. In the event of Seller failing to provide appropriate documents for Purchaser to avail disclosed concessional duty benefits in India, financial loss, so incurred, will be to the Seller's account.</p>



## GENERAL TERMS AND CONDITIONS OF ENQUIRY

	The evaluation currency for this tender shall be INR.
20	<b>Variation of orders</b>
	No variation to the Purchase order is permitted unless authorised in writing and signed by or on behalf of purchase executive, BHEL Jagdishpur.
21	<b>Sub-contract</b>
	BHEL's order or part there off, if further to be subcontracted in exceptional circumstances the details of subcontracting and to whom to be subcontracted shall be furnished to BHEL and written permission shall be obtained from BHEL. However, it shall not absolve the supplier of the responsibility of fulfilling BHEL order requirements.
22	<b>Recovery / deductions of amount from supplier</b>
	A) Any amount on account of recovery from consignor / supplier under any condition shall be liable to be adjusted against any amount payable to the consignor / supplier against bills. B) For any deficiency in supplies where deduction is involved, an amount as decided by BHEL, shall be deducted from supplier's bills.
23	<b>Safety clause for Purchase Orders</b>
	The vendors shall maintain and ensure sufficient safety measures as required for inspections and test like HV test. Pneumatic test, Hydraulic test Spring test, Bend test, Material handling and safe working environment etc. to enable Inspection Agency for performing inspection. The vendor shall ensure that all the safety precautions specified in factories Act 1948 chapter-IV Section-21 to 41 are complied with respect to equipment's to be inspected. If any test equipment is found not complying with proper safety requirement, then the inspection agency may withhold inspection, till such time the desired safety requirements are met.
24	<b>Non-Disclosure Agreement</b>
	All Drawing and technical documents relating to the product or it's manufacture submitted by one party to the other, prior or subsequent to the formation of contract, shall remain property of the submitting party. Drawing, technical documents or other technical information received by one party, shall not without the consent of the other party, be used for any other purpose than that, for which they were provided. Such technical information shall not without the consent of the submitting party, otherwise be used or copied, reproduced, transmitted or communicated to a third party. Patterns supplied by BHEL will remain BHEL's property which shall be returned by the bidder on demand to BHEL. Bidder shall in no way share or use such intellectual property of BHEL to promote his own business with others. <b><i>BHEL reserves the right to claim damages from the bidder, or take appropriate penal action as deemed fit against the bidder, for any infringement of the provisions contained herein.</i></b>
	DRAWINGS, PATTERNS & TOOLS: All drawings, patterns & tools supplied by BHEL or made at BHEL's expense are BHEL's property. These cannot be used or referred to any other party and must only be used in the execution of BHEL's orders. These should be preserved at the supplier's cost for a period of not less than 5 years. Patterns & tools should be returned to BHEL within 90 days of issue of the same.
25	<b>Settlement of Disputes &amp; Arbitration</b>
A	All questions / interpretations regarding subject matter of the Contract shall be decided by the Purchaser on the request of the Seller and the decision of the Purchaser shall be final.
B	In case of dispute, steps shall be taken by the parties to the contract to settle the same through negotiations.
C	In case, dispute is not settled in negotiations, it shall be referred to Conciliator appointed by the competent authority of the Purchaser.
D	Except as provided elsewhere in this Contract, in case amicable settlement is not reached between the Parties, in respect of any dispute or difference; arising out of the formation, breach, termination, validity or execution of the Contract; or, the respective rights and liabilities of the Parties; or in relation to interpretation of any provision of the Contract; or, in any manner touching upon the Contract, then, either Party may, by a notice in writing to the other party refer such dispute or difference to the sole arbitration of an arbitrator appointed by Head of the BHEL Unit/Region/Division issuing the Contract. The Arbitrator shall pass a reasoned award and the award of the Arbitrator shall be final and binding upon the Parties. Subject as aforesaid, the provisions of Arbitration and Conciliation Act 1996 (India) or Statutory modifications or re-enactments



## GENERAL TERMS AND CONDITIONS OF ENQUIRY

	<p>thereof and the rules made thereunder and for the time being in force shall apply to the arbitration proceedings under this clause. The seat of arbitration shall be Lucknow.</p> <p>The cost of arbitration shall be borne as per award of the Arbitrator.</p> <p>Subject to the arbitration in terms of Clause above, the Courts at Lucknow shall have exclusive jurisdiction over any matter arising out of or in connection with this Contract.</p> <p>Notwithstanding the existence or any dispute or differences and / or reference for the arbitration, the Contractor shall proceed with and continue without hindrance the performance of its obligations under this Contract with due diligence and expedition in a professional manner except where the Contract has been terminated by either Party in terms of this Contract.</p>
	<p><b>In case of Contract with Public Sector Enterprise (PSE) or Government Department, the following shall be applicable:</b> In the event of any dispute or difference relating to the interpretation and application of the provisions of the Contract, such dispute or difference shall be referred by either Party for arbitration to the sole arbitrator in the Department of Public Enterprises to be nominated by the Secretary to the Government of India in-charge of the Department of Public Enterprises. The Arbitration and Conciliation Act, 1996 shall not be applicable to arbitration under this clause. The award of the arbitrator shall be binding upon the Parties to the dispute, provided, however, any Party aggrieved by such award may make further reference for setting aside or revision of the award to the Law Secretary, Department of Legal Affairs, Ministry of Law and Justice, Government of India. Upon such reference the dispute shall be decided by the Law Secretary or the Special Secretary or Additional Secretary when so authorized by Law Secretary, whose decision shall bind the Parties hereto finally and conclusively. The Parties to the dispute will share equally the cost of arbitration as intimated by the Arbitrator.</p>
E	The Seller shall continue to perform the contract, pending settlement of dispute(s).
26	<b>Applicable Laws and Jurisdiction of Courts</b>
	Indian laws both substantive and procedural, for the time being in force, including modifications thereto, shall govern the Contract including Arbitration proceedings. The competent Courts at Lucknow in the State of Uttar Pradesh, India shall have sole jurisdiction.
27	<b>RIGHT OF REJECTION /NON- PLACEMENT OF PO:</b> BHEL reserves the right to accept the offers in part or in full, or cancel the Tender enquiry without assigning any reason.
28	<b>Performance Bank Guarantee (PBG) / Security Deposit (SD)-(If applicable)</b>
A	Wherever PBG/SD (covering equipment / system / work performance guarantee) is called for in the Notice Inviting Tender (NIT) deviation shall not be accepted.
B	Bank Guarantee wherever called for, shall be in the BHEL prescribed format. In case the order is to be placed in foreign currency, the BG must also be in Foreign currency, so specified by the Purchaser.
C	Wherever Security Deposit (covering contract performance) is called for in the NIT, deviation shall not be accepted.
D	Composite 'Contract Performance Bank Guarantee' of matching value / validity, where both Security Deposit and Performance Bank Guarantee are required, shall not be construed as deviation.
E	Wherever the contract is for supply of Goods processed on labour basis from BHEL supplied materials, the materials shall be issued against a suitable Bank guarantee as specified in the Enquiry.
29	<b>Benefits earmarked for Purchase from Micro &amp; Small Enterprises (MSEs) — Indigenous Purchase</b>
A	MSE bidders shall submit along with bid relevant documents w.r.t. their respective MSE status as per extant norms. Date to be reckoned for determining the deemed validity will be the last date of Technical bid submission. Non- submission of such document will lead to consideration of their bid, at par with other bidders and MSE status of such bidders shall be shifted to Non- MSE supplier till the supplier submit these documents.
B	In tender, participating MSEs quoting price within price band of L1+15% shall also be allowed to supply a portion of requirement by bringing down their price to L1 price in a situation where L1 price is from someone other than a MSE and such MSE shall be allowed to supply up to 25% of total tendered value. In case of more than one such MSE, the supply shall be shared proportionately. A quantum of 6.25% out of 25% quantity, so earmarked, will be reserved for MSE's owned by SC / ST entrepreneurs who submit their bid with relevant documents provided that in event of failure of such MSE(s) to participate in tender process or meet tender requirements and L1 price, 6.25% sub-target for procurement earmarked for MSE(s) owned by SC or ST entrepreneurs shall be met from other MSE(s). <b>Special provision for Micro and small enterprises owned by Women in following cases:</b> - 3% reservation for women owned MSEs under following conditions



## GENERAL TERMS AND CONDITIONS OF ENQUIRY

	<p>i. In case of Proprietary MSE, proprietor is woman.          ii. In case of partnership MSE, the woman partner is holding at least 51% share in the unit.          iii. In case private limited companies, at least 51% share is held by woman promoters.  <b>In case of indivisible tender the full quantity shall be awarded to L1.</b></p>																									
C	<p>If an enterprise falling under MSE category as defined in the MSMED Act 2006, graduates to a higher category from it's original category or beyond the purview of the Act, it shall continue to avail all non-tax benefits of it's original category notified by the Ministry of Micro, Small and Medium Enterprise for a period of three years from the date of such graduation to the higher category.</p>																									
D	<p>MSE suppliers can avail the intended benefits only if they submit along with the offer, attested copies of either EM II certificate having deemed validity (five years from the date of issue of acknowledgement in EM II) or valid NSIC certificate or EM II certificate along with attested copy of a CA certificate (As per BHEL Format, where deemed validity of EM II certificate of five years has expired) applicable for the relevant financial year (latest audited). Date to be reckoned for determining the deemed validity will be the date of bid opening (Part 1 in case of two part bid). Non submission of such documents will lead to consideration of their bid at par with other bidders. No benefits shall be applicable for this enquiry if any deficiency in the above required documents are not submitted before price bid opening. If the tender is to be submitted through e-procurement portal, then the above required documents are to be uploaded on the portal. Documents should be notarized or attested by a Gazetted officer</p>																									
30	<p><b>Integrity Pact (IP) — Independent external monitors (IEM)</b>          For tenders in which integrity pact is applicable, following points stand valid :</p>																									
A	<p>IP is a tool to ensure that activities and transactions between the company and its bidders / contractors are handled in a fair, transparent and corruption free manner. A panel of Independent External Monitors (IEMs) have been appointed to oversee implementation of IP in BHEL.          The IP as enclosed with the tender is to be submitted (duly signed by authorized signatory who signs in the offer) along with techno commercial bid. Only those bidders who have entered into such an IP with BHEL would be competent to participate in the bidding. In other words, entering into this pact would be a preliminary qualification.</p> <p style="margin-left: 40px;">Name : -----          Address : -----          mail : -----</p> <p style="text-align: right; margin-right: 40px;">} As indicated in NIT / enquiry :201__</p>																									
B	<p>Please refer section 8 of the IP for roles and responsibilities of IEMs. In case of any complaint arising out of tendering process, the matter may be referred to the IEM mentioned in the tender.  <b>NOTE:</b> No routine correspondence shall be addressed to the IEM (phone / post / e-mail) regarding the clarifications, time extensions or any other administrative queries, etc. on the tender issued. All such clarifications / issues shall be addressed directly to the tender issuing (procurement) department.  <b>For all clarifications/ issues related to the tender, Please contact:</b></p> <table border="1" style="width: 100%; border-collapse: collapse;"> <thead> <tr> <th style="width: 30%;"></th> <th style="width: 35%; text-align: center;">( 1 )</th> <th style="width: 35%; text-align: center;">( 2 )</th> </tr> </thead> <tbody> <tr> <td><b>Name</b></td> <td>Vaibhav Jain</td> <td>Vasu Dev</td> </tr> <tr> <td><b>Landline No.</b></td> <td>05361-224125</td> <td>05361-224238</td> </tr> <tr> <td><b>Mobile No.</b></td> <td>9453666051</td> <td>9948631167</td> </tr> <tr> <td><b>Email</b></td> <td><a href="mailto:viain@bhel.in">viain@bhel.in</a></td> <td>vasuyadav@bhel.in</td> </tr> <tr> <td><b>Deptt.</b></td> <td colspan="2">Material Management</td> </tr> <tr> <td><b>Address</b></td> <td colspan="2">BHEL FSIP, Industrial Area Jagdishpur, District- Amethi (UP) PIN 227817</td> </tr> <tr> <td><b>Fax</b></td> <td colspan="2"></td> </tr> </tbody> </table>			( 1 )	( 2 )	<b>Name</b>	Vaibhav Jain	Vasu Dev	<b>Landline No.</b>	05361-224125	05361-224238	<b>Mobile No.</b>	9453666051	9948631167	<b>Email</b>	<a href="mailto:viain@bhel.in">viain@bhel.in</a>	vasuyadav@bhel.in	<b>Deptt.</b>	Material Management		<b>Address</b>	BHEL FSIP, Industrial Area Jagdishpur, District- Amethi (UP) PIN 227817		<b>Fax</b>		
	( 1 )	( 2 )																								
<b>Name</b>	Vaibhav Jain	Vasu Dev																								
<b>Landline No.</b>	05361-224125	05361-224238																								
<b>Mobile No.</b>	9453666051	9948631167																								
<b>Email</b>	<a href="mailto:viain@bhel.in">viain@bhel.in</a>	vasuyadav@bhel.in																								
<b>Deptt.</b>	Material Management																									
<b>Address</b>	BHEL FSIP, Industrial Area Jagdishpur, District- Amethi (UP) PIN 227817																									
<b>Fax</b>																										
31	<p><b>Fraud Prevention Policy :</b> The Bidder along with its associate / collaborators / sub-contractors / sub-vendors / consultants / service providers shall strictly adhere to BHEL Fraud Prevention Policy displayed on BHEL website <a href="http://www.bhel.com">www.bhel.com</a> and shall immediately bring to the notice of BHEL Management about any fraud or suspected fraud as soon as it comes to their notice.</p>																									
32	<p>GSTN nos. of vendors as well as GSTN No of BHEL must be mentioned on the invoices/bills of the materials. Please note that correct HSN code as well as rate of GST be mentioned in the invoice/bills.</p>																									
33	<p>BHEL FSIP GSTIN Reg. No: 09AAACB4146P2ZC          State Code: 09 (Uttar Pradesh)</p>																									



## GENERAL TERMS AND CONDITIONS OF ENQUIRY

34	<p><b>(a) Right of Acceptance:</b> BHARAT HEAVY ELECTRICALS LIMITED JAGDISHPUR reserves the right to reject any or all the bids/quotations without assigning any reason thereof. BHEL also reserves the right to increase or decrease the tendered quantities. Bidders should be prepared to accept order for reduced quantity without any extra charges.</p> <p><b>(b) Right of Rejection /Non- Placement of PO:</b> BHEL reserves the right to accept the offers in part or in full or cancel the Tender enquiry/PO without assigning any reason.</p> <p><b>(c)</b> Wherever BHEL business interest will contradict with any supplier, offer of that supplier may be rejected.</p>
35	<p><b>Integrity Commitment:</b> The offers of the bidders who are under suspension as also the offers of the bidders, who engage the services of the banned firms, shall be rejected. The list of banned firms is available on BHEL website <a href="http://www.bhel.com">www.bhel.com</a>. Integrity commitment, performance of the contract and punitive action thereof :</p>
A	<p><b>Commitment by BHEL :</b> BHEL commits to take all measures necessary to prevent corruption in connection with the tender process and execution of the contract. BHEL will during the tender process treat all bidder's in a transparent and fair manner, and with equity.</p>
B	<p><b>Commitment by bidder / Supplier / Contractor :</b></p> <ul style="list-style-type: none"> <li>- The bidder / supplier / contractor commit to take all measures to prevent corruption and will not directly or indirectly influence any decision or benefit which he is not legally entitled to nor will act or omit in any manner which tantamount to an offence punishable under any provision of the Indian Penal code, 1860 or any other law in force in India.</li> <li>- The bidder / supplier / contractor will, when presenting his bid, disclose any and all payments he has made, and is committed to or intends to make to agents, brokers or any other intermediaries in connection with the award of the contract and shall adhere to relevant guidelines issued from time to time by govt. of India / BHEL</li> <li>- The bidder / supplier / contractor will perform / execute the contract as per the contract terms &amp; conditions and will not default without any reasonable cause, which causes loss of business / money / reputation to BHEL.</li> </ul>
C	<p>If any bidder / supplier / contractor during pre-tendering / tendering / post tendering / award / execution / post execution stage indulges in mal-practices, cheating, bribery, fraud or / and other misconduct or formation of cartel so as to influence the bidding process or influence the price or acts or omits in any manner which tantamount to an offence punishable under any provision of the Indian Penal Code, 1860 or any other law in force in India, then action may be taken against such bidder / supplier / contractor as per the extant guidelines of the company available on <a href="http://www.bhel.com">www.bhel.com</a> and / or under applicable legal provisions.</p>
d	<p>Defaulter suppliers shall be treated as per Guidelines for Suspension of the Business Dealing with suppliers/contractors.</p>
36	<p><b>Deviation:</b> Any of the terms and conditions not acceptable to supplier, shall be explicitly mentioned in the tender. Otherwise, it will be treated as that all those terms and conditions as mentioned in the tender are acceptable in Toto.</p>
37	<p><b>Benefits earmarked to suppliers for Purchase under ' MAKE IN INDIA'</b></p>
	<p>Compliance to <b>MAKE IN INDIA</b> circular issued by GOI: "For this procurement, the local content to categorize a supplier as a Class I local supplier / Class II local supplier / Non-Local Supplier and purchase preference to Class I local supplier, is as defined in Public Procurement (Preference to Make in India), Order 2017 dated 04.06.2020 issued by DPIIT. In case of subsequent orders issued by the nodal ministry, changing the definition of local content for items of the NIT, the same shall be applicable even if issued after issue of this NIT, but before opening of Part II bids against this NIT" (Format Attached).</p>
	<p>As part of minimizing import content, Government of India, vide order no P-45021/2/2017-B.E.-II dated 15.06.2017, under the subject – Public Procurement ( Preference to Make in India ) -- has set the initiatives to encourage and promote indigenously manufactured goods within India and services provided by sources within India. . In line with this, bidders who manufacture the goods and provide services within India ( otherwise referred as local suppliers ) are given purchase preference and are entitled to benefits in the tender</p>
A	<p>Definitions</p>
(i)	<p>Local content means the amount of value added in India which shall, unless otherwise prescribed by the Nodal Ministry, be the total value of item procured ( excluding net domestic indirect taxes ) minus the value of imported content in the item ( including all customs duties ) as a proportion of the total value , in percent . Presently, the minimum local content required is 50%. The</p>



## GENERAL TERMS AND CONDITIONS OF ENQUIRY

	nodal ministry may prescribe a higher or lower percentage in respect of any particular item and may also prescribe the manner of calculation of local content.
(ii)	Local supplier means a supplier or service provider whose product or service offered for procurement meets the minimum local content as prescribed
(iii)	Margin of Purchase Preference means the maximum extent to which the price quoted by a local supplier may be above the L1 for the purpose of purchase preference. Presently the margin of Purchase preference is 20%.
<b>B</b>	Conditions under which preference is given
(i)	In procurement of goods in respect of which the Nodal ministry has communicated that there is sufficient local capacity and local competition, and where the estimated value of procurement is Rs 50 lakhs or less, only local suppliers shall be eligible. If the estimated value of procurement of such goods is more than Rs 50 lakhs, provisions of 37(B) (ii) and 37(B)(iii) shall apply.
(ii)	If the procurement of goods are not covered by 37(B)(i) and are divisible in nature, the following procedure shall be followed :
<i>a</i>	If L1 is a local supplier, the order for full quantity shall be awarded to local supplier
<i>b</i>	If L1 bid is not from a local supplier, 50% of the order quantity shall be awarded to L1. Thereafter, the lowest bidder among the local suppliers, shall be invited to match the L1 price for the remaining 50% quantity, subject to the local supplier's quoted price falling within the margin of purchase preference, and the order for that quantity shall be awarded to such local supplier subject to matching the L1 price. In case such lowest eligible local supplier fails to match the L1 price or accepts less than offered quantity, the next higher local supplier within the margin of purchase preference shall be invited to match the L1 price for remaining quantity and so on, and the order shall be awarded accordingly. In case some quantity is still left uncovered on local suppliers, then such balance quantity may also be ordered on the L1 bidder.
<i>iii</i>	If the procurement of goods are not covered by 37(B)(ii) and are not divisible in nature, and in procurement of services where the bid is evaluated on the price alone, the following procedure shall be followed :
<i>a</i>	If L1 is a local supplier, the order shall be awarded to local supplier
<i>b</i>	If L1 bid is not from a local supplier, then the lowest bidder among the local suppliers, will be invited to match the L1 price, subject to the local supplier's quoted price falling within the margin of purchase preference, and the order shall be awarded to such local supplier subject to matching the L1 price.  In case such lowest eligible local supplier fails to match the L1 price, the local supplier with the next higher bid within the margin of purchase preference shall be invited to match the L1 price and so on, and the order shall be awarded accordingly. In case none of the local suppliers within the margin of preference match the L1 price, then the order may be awarded to the L1 bidder.
<b>C</b>	Exemption of small purchases
	Notwithstanding anything contained at clause 38B above, <b>procurements</b> where the estimated value of procurement is less than Rs 5 lakhs are <b>exempt and</b> purchase preference shall not be accorded in such cases.
<b>D</b>	Verification of local content
(i)	The local supplier, at the time of tender, bidding or solicitation, shall be required to provide self-certification that the item offered meets the minimum local content and shall give details of the location(s) at which the local value addition is made.
(ii)	In cases of procurement for a value in excess of Rs 10 crores, the local supplier shall be required to provide a certificate from the statutory auditor or cost auditor of the company ( in case of companies ) or from a practicing cost accountant or practicing chartered accountant ( in respect of suppliers other than companies ) giving the percentage of local content.



## GENERAL TERMS AND CONDITIONS OF ENQUIRY

(iii)	False declarations shall be in breach of code of integrity and shall invite action as per guidelines for Suspension of Business dealings with Suppliers
E	In case of any disputes / clarifications, the extant guidelines of Government of India shall prevail.
38	<b>Model Clauses for Tenders</b>
I	Any bidder from a country which shares a land border with India will be eligible to bid in this tender only if the bidder is registered with the Competent Authority.
II	"Bidder" (including the term 'tenderer', 'consultant' or 'service provider' in certain contexts) means any person or firm or company, including any member of a consortium or joint venture (that is an association of several persons, or firms or companies), every artificial juridical person not falling in any of the descriptions of bidders stated hereinbefore, including any agency branch or office controlled by such person, participating in a procurement process.
III	"Bidder from a country which shares a land border with India" for the purpose of this Order means: -
a	An entity incorporated, established or registered in such a country; or
b	A subsidiary of an entity incorporated, established or registered in such a country; or
c	An entity substantially controlled through entities incorporated, established or registered in such a country; or
d	An entity whose beneficial owner is situated in such a country; or
e	An Indian (or other) agent of such an entity; or
f	A natural person who is a citizen of such a country; or
g	A consortium or joint venture where any member of the consortium or joint venture falls under any of the above
IV	The beneficial owner for the purpose of (iii) above will be as under:
1	In case of a company or limited liability Partnership, the beneficial owner is the natural person (s) who, whether acting alone or together, or through one or more juridical person, has a controlling ownership interest or who exercises control through other means. Explanation –
A	"Controlling ownership interest" means ownership of or entitlement to more than twenty-five per cent. Of shares or capital or profits of the company
B	"Control" shall include the right to appoint majority of the directors or to control the management or policy decisions including by virtue of their shareholding or management rights or shareholder's agreements of voting agreements;
2	In case of a partnership firm, the beneficial owner is the natural person (s) who, whether acting alone or together, or through one or more juridical of capital or profits of the partnership;
3	In case of an unincorporated association or body of individuals, the beneficial owner is the natural person (s), who, whether acting alone or together, or through one or more juridical person, has ownership of or entitlement to more than fifteen percent of the property of capital of profits of such association or body of individuals;
4	Where no natural person is identified under (1) or (2) or (3) above, the beneficial owner is the relevant natural person who holds the position of senior managing official;
5	In case of trust, the identification of beneficial owner (s) shall include identification of the author of the trust, the trustee, the beneficiaries with fifteen percent or more interest in the trust and any other natural person exercising ultimate effective control over the trust through a chain of control or ownership.
V	An agent is a person employed to do any act for another, or to represent another in dealings with third person.
39	<b>Conciliation</b>
	BHEL and bidder agree that if at any time (whether before, during or after the arbitral or judicial proceedings), any disputes (which term shall mean and include any dispute, difference, question or disagreement arising in connection with construction, meaning, operation, effect, interpretation or breach of the terms & conditions of order, which the parties are unable to settle



## GENERAL TERMS AND CONDITIONS OF ENQUIRY

	<p>mutually), arise inter-se the parties, the same may, be refereed by either party to Conciliation to be conducted through Independent Experts Committee to be appointed by competent authority of BHEL from the BHEL panel of Conciliators</p> <p>Notes:</p> <ol style="list-style-type: none"><li>1. No serving or a retired employee of BHEL/Administrative Ministry of BHEL shall be included in the BHEL Panel of Conciliators.</li><li>2. Any other person(s) can be appointed as Conciliator(s) who is/are mutually agreeable to both the parties from outside the BHEL Panel of Conciliators.</li></ol> <p>The proceedings of Conciliation shall broadly be governed by Part-III of the Arbitration and Conciliation Act 1996 or any statutory modification thereof. The details of Conciliations shall be governed by the BHEL Conciliation scheme 2018.</p>
40	<p><i>Important Note: The bidder will, when presenting his bid, declare whether other family firms or sister concern affiliates/subsidiary firms are participating in same tender, so as to eliminate the possibility of cartel formation. Format for declaration is attached.</i></p>
41	<p><b>If supplier does not mention against any terms of “General Terms and conditions” and “Special terms and conditions”. It shall be summarily concluded that respective terms are acceptable to supplier and no further clarification shall be asked.</b></p>







PRE-QUALIFICATION REQUIREMENTS (PQR) FOR COLD ROLLED NON-GRAIN ORIENTED SHEET STEEL GRADE-530, SPEC-TM10472 REV-03, SIZE-0.5X710XCOIL

RFQ NO. 2100098

Sl. No	Description of Pre-Qualification Required	Vendor's Response Complied (Yes/No)	Supporting Documents Required to accept Compliance
1	Only original manufacturers or their authorized distributors/agents will qualify. Traders/stockists etc. will not be considered.		Certificate of being original manufacturer or authorization letter from original manufacturer (for distributors/agents).
2	The original manufacturer should have adequate in-house manufacturing set up for manufacturing of Cold Rolled Non-Grain Oriented (CRNGO) Steel sheet.		Self-declaration to be submitted.
3	Source of raw material  -Use of only virgin raw material is acceptable from reputed national/international brands		Self-declaration to be submitted.
4	The company should have experience of supply of at least one Purchase order of quantity $\geq 50$ MT of Cold Rolled Non-Grain Oriented (CRNGO) Sheet Steel of Grade 530 or higher grade, of size range specified as below, in last 7 years. Size range: Thickness- 0.5 to 0.65 mm, width- $\geq 710$ mm		Copy of PO/ invoice with co-related test certificates to be submitted.

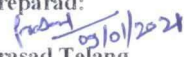
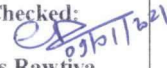
NOTE:

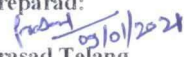
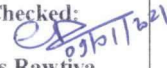
1. Compliance to above Pre-qualification requirements is mandatory. In absence of PQR compliance vendor's offer are liable for rejection.

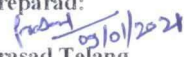
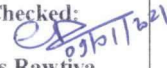
	 <p style="text-align: center;"><b>PRODUCT STANDARD</b> <b>TME DIVISION, BHOPAL</b></p>	<b>TM 10472</b> <b>Rev 03</b> <b>PAGE 01 OF 10</b>																
<b>COPYRIGHT AND CONFIDENTIAL</b> The information on this document is the property of <b>BHARAT HEAVY ELECTRICALS LIMITED</b> It must not be used directly or indirectly in any way detrimental to the interest of	<u><b>SPECIFICATION FOR COLD ROLLED NON- GRAIN ORIENTED (CRNO) ELECTRICAL STEEL SHEET / STRIP FOR MANUFACTURE OF 3-PHASE TRACTION MOTOR TYPE 6FRA6068 &amp; 6FXA7059</b></u>																	
	<p><b>1.0 SCOPE:</b> This specification governs the quality requirements of insulated (double side) unpigmented type cold rolled, non-grain oriented magnetic steel sheet or coil in finally annealed condition in 0.50 mm thickness.</p> <p><b>2.0 APPLICATION:</b> Laminations of Electrical Machines.</p> <p><b>3.0 RAW MATERIAL :</b></p> <p><b>3.1</b> The material should be Insulated (double side) unpigmented type Cold Rolled Non-Grain Oriented, Finally Annealed steel sheet of either of the following Grades.</p> <ul style="list-style-type: none"> <li>i) Grade V 530-50A to DIN 46400 Pt-I with C4/C6 coating (with minimum average 4 microns coating thickness on each side, Total 8 micros) (German origin)</li> <li>ii) Gr. M530-50A to EN-10106 with C4/C6 Coating (with minimum average 4 microns coating thickness on each side, Total 8 microns (European origin).</li> <li>iii) Gr. M530-50A with C4/C6 Coating (with minimum average 4 microns coating thickness on each side, Total 8 microns) to IEC: 60404-8-4.</li> <li>iv) M/s Thyssen Krupp Electrical Steel India Pvt. Ltd Grade 50C 530/C6A of C3Y type (with minimum average of 4 microns coating thickness on each side, Total 8 microns) to IS:648 &amp; IS 649.</li> <li>v) SAIL material Grade 50C 530 to IS: 648 with C3 coating with special imported varnish of M/s REMBRANDTIN / Austria Brand- REMISOL EB-5001 with minimum average of 4 microns coating thickness on each side (total 8 microns). This core plate varnish C6 (C3 Pigmented) shall be water reduceable, pigmented, Chromium free. Thermally resistant Phenolic Resins.</li> <li>vi) M/s JSW Steel Ltd. CRNO electrical steel Gr. 50C530 to IS:648 with C6 coating manufactured by using imported varnish of M/s REMBRANDTIN/Austria of M/s Dorf Ketal Chemicals India Pvt. Ltd./ Mumbai.</li> <li>vii) M/s POSCO India/ Pune CRNO electrical sheel Steel Gr. M530-50A to IEC: 60404-8-4 with C6/C3 coating manufactured at their OEM`s Pohang Plant/ Korea by using varnish of M/s A.K. Chemtech/ Korea.</li> <li>viii) M/s SAIL make CRNO electrical steel sheet Gr. 50C530 to IS:648 with C6 coating manufactured by using varnish of M/s Drof Ketal Chemicals India Pvt. Ltd./ Mumbai</li> </ul>																	
<b>Revision: 03</b>  <b>Date: 09/01/2021</b>	<table border="1"> <thead> <tr> <th>Distribution</th> <th>Qty.</th> </tr> </thead> <tbody> <tr> <td>TME</td> <td>1</td> </tr> <tr> <td>PRM</td> <td>1</td> </tr> <tr> <td>TXM</td> <td>1</td> </tr> <tr> <td>QFD</td> <td>1</td> </tr> </tbody> </table>	Distribution	Qty.	TME	1	PRM	1	TXM	1	QFD	1	<table border="1"> <tr> <td colspan="2" style="text-align: center;"> <b>Approved:</b>              (S P Singh)            Sr. DGM/ TME         </td> </tr> <tr> <td style="text-align: center;"> <b>Prepared:</b>              Prasad Telang            Dy. Mgr/ TME         </td> <td style="text-align: center;"> <b>Checked:</b>              Vikas Rawtiya            Sr. Mgr./TME         </td> <td style="text-align: center;"> <b>Date:</b>            09/01/2021         </td> </tr> </table>		<b>Approved:</b>  (S P Singh) Sr. DGM/ TME		<b>Prepared:</b>  Prasad Telang Dy. Mgr/ TME	<b>Checked:</b>  Vikas Rawtiya Sr. Mgr./TME	<b>Date:</b> 09/01/2021
Distribution	Qty.																	
TME	1																	
PRM	1																	
TXM	1																	
QFD	1																	
<b>Approved:</b>  (S P Singh) Sr. DGM/ TME																		
<b>Prepared:</b>  Prasad Telang Dy. Mgr/ TME	<b>Checked:</b>  Vikas Rawtiya Sr. Mgr./TME	<b>Date:</b> 09/01/2021																

	 <p><b>PRODUCT STANDARD</b> TME DIVISION, BHOPAL</p> <p>TME 2011</p>	<b>TM 10472</b>																				
		<b>Rev 03</b>																				
		<b>PAGE 02 OF 10</b>																				
<p><b>COPYRIGHT AND CONFIDENTIAL</b></p> <p>The information on this document is the property of <b>BHARAT HEAVY ELECTRICALS LIMITED</b> It must not be used directly or indirectly in any way detrimental to the interest of the company</p>	<p><b>4.0 DIMENSIONS AND TOLERANCES:</b></p> <p><b>4.1 Sizes:</b> Magnetic steel sheet shall be supplied to the dimensions specified on BHEL order.</p> <p><b>4.2 Tolerances:</b></p> <p><b>4.2.1 Thickness:</b></p> <p>The permissible deviation in nominal thickness shall be <math>\pm 8\%</math>. The variation in thickness in a direction parallel to the direction of rolling shall not exceed <math>\pm 8\%</math> of the nominal thickness.</p> <p>The variation in thickness in a direction perpendicular to the direction of rolling shall be <math>\pm 0.020</math> mm for a nominal thickness of 0.50mm. The measuring points should be at least 40 mm away from the edges of the sheets.</p> <p><b>4.2.2 Width:</b></p> <p>The tolerance for width of material supplied with trimmed edges shall be as follows:</p> <table border="1" data-bbox="437 1137 1311 1294"> <thead> <tr> <th colspan="2">Width (mm)</th> <th colspan="2">Tolerance (mm)</th> </tr> <tr> <th>Over</th> <th>Upto &amp; incld.</th> <th>Plus</th> <th>Minus</th> </tr> </thead> <tbody> <tr> <td>-</td> <td>150</td> <td>0.3</td> <td>0</td> </tr> <tr> <td>150</td> <td>500</td> <td>0.5</td> <td>0</td> </tr> <tr> <td>500</td> <td>1250</td> <td>1.5</td> <td>0</td> </tr> </tbody> </table> <p><b>4.2.3 Length:</b></p> <p>When supplied in sheet form the tolerance on length shall be + 1%, but shall not exceed + 10mm, -0.</p> <p><b>4.2.4 Straightness/Edge camber</b></p> <p>The straightness tolerances for the longitudinal edge (edge camber) over a gauge length of 2000 mm shall not exceed 4 mm for width upto and including 150mm and 2mm for widths exceeding 150mm.</p>		Width (mm)		Tolerance (mm)		Over	Upto & incld.	Plus	Minus	-	150	0.3	0	150	500	0.5	0	500	1250	1.5	0
Width (mm)		Tolerance (mm)																				
Over	Upto & incld.	Plus	Minus																			
-	150	0.3	0																			
150	500	0.5	0																			
500	1250	1.5	0																			



TME 2011

**PRODUCT STANDARD**  
TME DIVISION, BHOPAL

TM 10472

Rev 03

PAGE 03 OF 10

**COPYRIGHT AND CONFIDENTIAL**  
 The information on this document is the property of **BHARAT HEAVY ELECTRICALS LIMITED**  
 It must not be used directly or indirectly in any way detrimental to the interest of the company

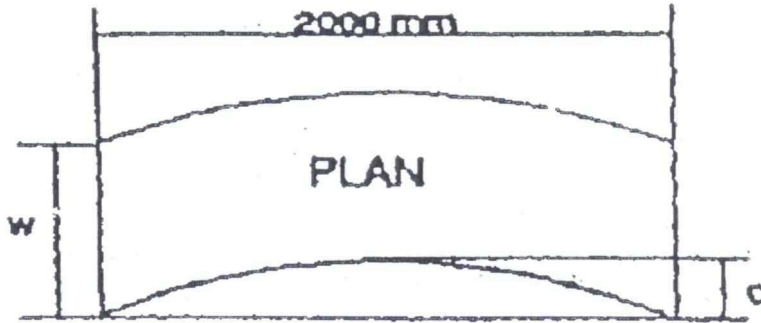

W = Width of Strip  
C = Edge Camber

**4.2.5 Edge Burr:**

The height of edge burr shall not exceed 50 microns.

**4.2.6 Bowing - Coils:**

The material when unwound from a coil shall be placed flat on a level smooth surface (surface plate) such that it has a radius not less than 3000 mm. The specimen should be stood upright and free from constraint with one longitudinal edge on the surface of the plate. A straight edge with a length of 500 mm. when placed against the specimen and when measuring the greatest distance '\*h\*' between the straight edge and the product should not be more than 10 mm as detailed below:

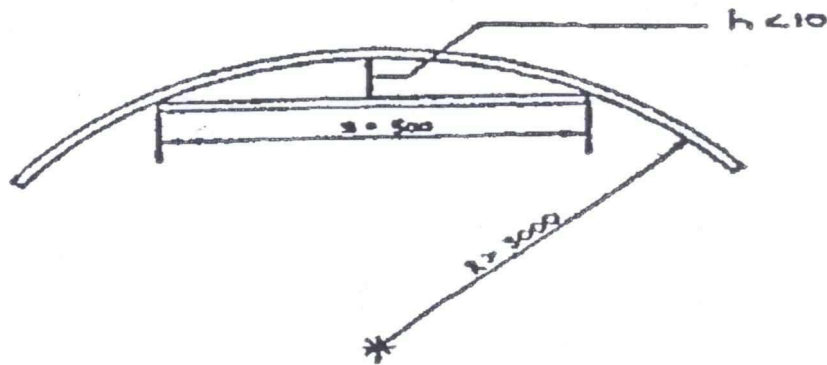

	 <p><b>PRODUCT STANDARD</b> TME DIVISION, BHOPAL</p> <p>TME 2011</p>	<p><b>TM 10472</b></p> <p><b>Rev 03</b></p> <p><b>PAGE 04 OF 10</b></p>						
<p style="writing-mode: vertical-rl; transform: rotate(180deg);"><b>COPYRIGHT AND CONFIDENTIAL</b></p> <p>The information on this document is the property of <b>BHARAT HEAVY ELECTRICALS LIMITED</b> It must not be used directly or indirectly in any way detrimental to the interest of the company</p>	<p><b>4.2.7 Waviness/Flatness</b> The Waviness/Flatness shall not exceed 1.5% (i.e the ratio of the wave height to wave length).</p> <p><b>5.0 FINISH:</b> The material shall have a smooth surface and shall be free from loose scale, buckle or dents, waviness and internal stresses.</p> <p><b>6.0 TEST SAMPLES:</b></p> <p>The test samples of the same heat/melt &amp; thickness shall be selected from the consignment as follows:</p> <table style="margin-left: 40px;"> <tr> <td>Up to 30 tonnes</td> <td>: 1 sample</td> </tr> <tr> <td>Above 30 to 60 tonnes</td> <td>: 2 samples</td> </tr> <tr> <td>Above 60 tonnes</td> <td>: 3 samples</td> </tr> </table> <p>The test samples shall be sufficient in size to provide the necessary test pieces.</p> <p><b>7.0 ACCEPTANCE TEST:</b></p> <p><b>7.1 Bend Test :</b> A test piece taken in rolling direction in the ordered thickness shall withstand a minimum of 10 bends, without fracture through 180 deg. Over a 5 mm radius jaws when tested to IS:649.</p> <p><b>7.2 Stacking Factor:</b> The surface quality of the sheets when measured in terms of stacking factor as per IS649 shall not be less be 95%.</p> <p><b>7.3 Total Specific Loss:</b> The specific total loss on aged specimens (A specimen which has been heated for 24 Hrs. at 225 deg. for 0.50 mm thickness) when tested as per IS:649 at frequency 50Hz and 1.5 Tesla should not exceed 5.30 W/Kg.</p> <p><b>7.4 AC Magnetization:</b> When tested to IS:649, the AC magnetic field (H) in Ampere/meter (Peak) shall show the following minimum corresponding values of magnetic induction (B) in Tesla (Peak) for 0.50 mm thick material.</p>		Up to 30 tonnes	: 1 sample	Above 30 to 60 tonnes	: 2 samples	Above 60 tonnes	: 3 samples
Up to 30 tonnes	: 1 sample							
Above 30 to 60 tonnes	: 2 samples							
Above 60 tonnes	: 3 samples							

	 <p><b>PRODUCT STANDARD</b> <b>TME DIVISION, BHOPAL</b></p> <p>TME 2011</p>	<p><b>TM 10472</b></p> <p><b>Rev 03</b></p> <p><b>PAGE 05 OF 10</b></p>						
<p style="writing-mode: vertical-rl; transform: rotate(180deg);"> <b>COPYRIGHT AND CONFIDENTIAL</b>            The information on this document is the property of <b>BHARAT HEAVY ELECTRICALS LIMITED</b>            It must not be used directly or indirectly in any way detrimental to the interest of the company         </p>	<p>AC magnetic Field Strength 'H' A/m Magnetic Induction, Min (B) Tesla (Peak)</p> <table border="0" style="margin-left: auto; margin-right: auto;"> <tr> <td style="padding-right: 40px;">2500 AT/M</td> <td>1.54</td> </tr> <tr> <td>5000 AT/M</td> <td>1.64</td> </tr> <tr> <td>10000 AT/M</td> <td>1.74</td> </tr> </table> <p><b>7.5 Anisotropy of losses:</b> When tested to IS:649 the Anisotropy losses shall not exceed <math>\pm 10\%</math>.</p> <p><b>7.6 Testing of insulation Coating:</b> The insulation coating when tested as detailed below shall show following properties.</p> <p><b>7.6.1 Selection of Test Samples for Insulation Coating :</b> The outermost and innermost turn of coil or the top-most and bottom most of a stack of sheets, shall be considered as wrapping and not representing the properties of the remaining material and hence shall not be considered for test specimen. In case of coils, the test specimens shall preferably be taken from the first external turn excluding the wrapping turn and in case of sheet, it shall be from the upper part of the stack. In special case, it can be taken from any other part also. The surface of the strip shall be free from contaminations and damages and shall be cut without deformation and as far as possible, without burrs. Any cleaning done shall not damage the insulation coating.</p> <p><b>7.6.2 Coating Layer Thickness :</b> Both sides of the sheet shall be coated and shall have a thickness of 4 to 7 microns on each side at least 15 readings shall be taken on each side at equal intervals.</p> <p><b>7.6.3 Surface Insulation Resistivity :</b> To be tested as per test procedure mentioned in relevant standard (refer BHEL specification AA10917).</p> <p><b>7.6.4 Type Tests*:</b> In addition to tests specified at 7.1 to 7.6.3.</p> <p><b>7.6.4.1 Adherence Test :</b> The surface coating shall be sufficiently adherent so that it does not get detached during insulation and shearing. In the reverse bending test with the bending radius of 5 mm the surface coating shall not be detached after bending through 90 deg.</p>		2500 AT/M	1.54	5000 AT/M	1.64	10000 AT/M	1.74
2500 AT/M	1.54							
5000 AT/M	1.64							
10000 AT/M	1.74							
	<p><b>7.6.4.2 Thermal Effect on coating :</b> Twelve specimen of the coated strip shall be clamped together under a pressure of 1 N/mm<sup>2</sup> approximately and fitted in the laboratory oven at a temperature specified in relevant Standards for a period specified in relevant Standards. After cooling to the room temperature, the surface insulation resistivity values of the middle ten specimens shall not be less than the minimum specified values mentioned in relevant Standards.</p>							

	 <p><b>PRODUCT STANDARD</b> TME DIVISION, BHOPAL</p> <p>TME 2011</p>	<p><b>TM 10472</b></p> <p><b>Rev 03</b></p> <p><b>PAGE 06 OF 10</b></p>
<p style="writing-mode: vertical-rl; transform: rotate(180deg);"><b>COPYRIGHT AND CONFIDENTIAL</b></p> <p>The information on this document is the property of <b>BHARAT HEAVY ELECTRICALS LIMITED</b> It must not be used directly or indirectly in any way detrimental to the interest of the company</p>	<p><b>7.6.4.3 Resistance to solvents Oils :</b> The specimen shall be kept in a container filled with boiling Trichloroethylene or xylene for 5 minutes. After removal and cooling to the room temperature, the coating shall not get soft enough so that it can be wiped off.</p> <p><b>*Note :</b> 'Type tests', shall be carried out when, 'Type Approval' to a supplier is given and repeated once in Five years for the approved supplier.</p> <p><b>8.0 TEST CERTIFICATES:</b> Three copies of test certificates shall be supplied, unless otherwise specified on order. In addition, the supplier shall ensure to enclose one copy of the test certificate along with their dispatch documents to facilitate quick clearance of the material.</p> <p>The test certificate shall bear the following information:</p> <p>TM10472 Rev No, BHEL Order No, Supplier's Name/Grade/Identification No., Size &amp; Weight, Melt No., Packet/ Bundle No. Test results of Dimensions &amp; Tolerances and Properties as per the concerned National standards &amp; Insulation coating, as above.</p> <p><b>9.0 SURFACE QUALITY OF STEEL SHEETS USED :</b></p> <p><b>9.1</b> The surface of the Steel sheets used shall be smooth and bright as further treatment and processing must not result in any burrs or uneven spots of thickness more than 0.02 mm.</p> <p><b>9.2</b> The sheets must be easy to cut without bending and should not result in premature wear on the cutting tools.</p> <p><b>10.0 SURFACE COATING (INSULATION) :</b></p> <p><b>10.1</b> Thickness of the surface coating on both sides shall be maintained at 4 μm (minimum) total 8 microns to be measured as per IS:649 Surface coating must have adhesive properties to withstand cutting and bending operations surface coating should be able to withstand a minimum of 10 bends of 90° with a bending radius of 5 mm without any damages in the surface coating. If this trial fails the Stampings has to undergo a factory cutting test.</p>	



TME 2011

**PRODUCT STANDARD**  
TME DIVISION, BHOPAL

TM 10472

Rev 03

PAGE 07 OF 10

**11.0 PACKING AND MARKING:****11.1 Material Supplied in Straight Length:**

Magnetic steel sheets shall be supplied in bundles. The packing shall be seaworthy and shall protect the material from damage in transit. A typical packing which would be suitable is shown below.

Each sheet shall be marked with supplier's grade/references.

These markings shall be along the rolling direction.

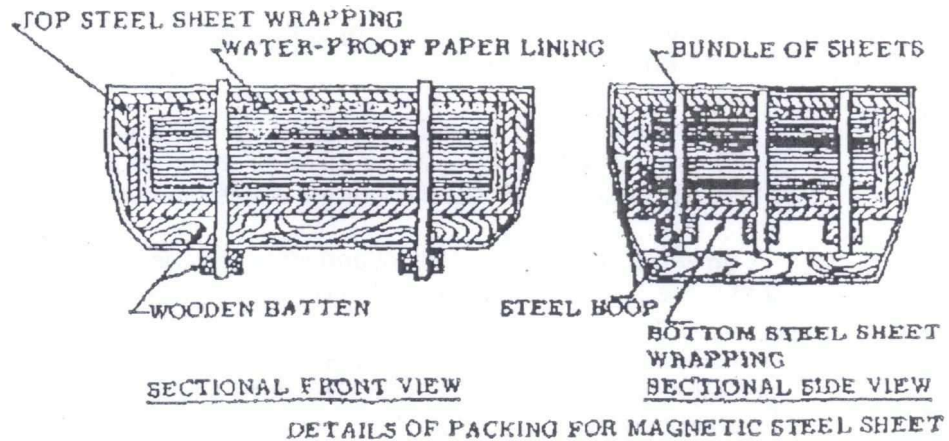
**Note:**

- Water proof paper lining shall be preferably Volatile Corrosion Inhibitor (V.C.I.) Coated Paper with an additional polythene (100 micron) enveloped.
- Approximate weight of each bundle shall be 2 to 3 metric tonnes. Bundle weighing 2 Metric tonnes is however preferred.
- The packing should ensure that there is no seepage of moisture and the sheets reach BHEL on completely rust free condition. It shall be strong enough to withstand handling at the docks, at sea and on the road.
- Mark/ Grade as well as name of OEM must be printed on Electrical sheet steel at a distance not more than 500 mm apart from each other.

**11.2 Material Supplied in Continuous Coil:**

The nominal weight of each coil shall be 1800-2000kg.

The nominal internal diameter of coil shall be 508 mm.

Packing shall be sea-worthy and shall protect the coils from damage and rusting during transit. The supplier's grade/reference shall be marked at every one meter intervals throughout the coil length.

	 <p><b>PRODUCT STANDARD</b> TME DIVISION, BHOPAL</p> <p>TME 2011</p>	<p><b>TM 10472</b></p>
		<p><b>Rev 03</b></p>
<p style="writing-mode: vertical-rl; transform: rotate(180deg);"><b>COPYRIGHT AND CONFIDENTIAL</b></p> <p>The information on this document is the property of <b>BHARAT HEAVY ELECTRICALS LIMITED</b> It must not be used directly or indirectly in any way detrimental to the interest of the company</p>	<p><b>Coils shall be vertically packed according to the instructions and drawing given below:</b></p> <ol style="list-style-type: none"> <li>a) An annular protection board shall be placed at either end of the coil.</li> <li>b) The coil shall then be wrapped with waterproof anti-rust proof paper by lapping axially all around the circumference.</li> <li>c) The coil shall then be covered by polyethylene sheet or anti-rust waterproof paper and the ends sealed properly.</li> <li>d) A galvanized sheet shall be wrapped on the outside of the coil and the top and bottom of the coils. Care shall be taken to ensure that the ends of the top and bottom of the coils extend sufficiently over the inside diameter of the coil.</li> <li>e) A galvanized sheet shall be wrapped on the inside of the coil. Care shall be taken that it overlaps sufficiently over the ends of the sheet mentioned in (d) above.</li> <li>f) Steel ring made from thick angle sheets shall be placed on the rim of the inner diameter at both ends of the coil. The rings shall be held at either ends at four points by steel bands.</li> <li>g) The coil should then be mounted on wooden skids held together by steel bands. Wooden skids must have cutouts to house the steel bands for tight fit and to avoid slippage.</li> <li>h) The packing shall ensure that there is no seepage of moisture and the coils reach BHEL in completely rust free condition. It shall be strong enough to withstand handling at the docks, at sea and on the road.</li> <li>i) Coils shall be sufficiently tight-wound to prevent collapse to an extent that would preclude their being mounted on a mandrel appropriate to the ordered internal diameter.</li> <li>j) Each package should indicate the, Sling Position, for lifting without damage. It is preferable to fix a suitable size of, 'Sheet Steel Angle', at the position where the Sling Rope is to be fitted to avoid slippage/damage/breakage of the wooden skid at four places.</li> </ol>	<p><b>PAGE 08 OF 10</b></p>



**PRODUCT STANDARD**  
TME DIVISION, BHOPAL

TME 2011

TM 10472

Rev 03

PAGE 09 OF 10

**COPYRIGHT AND CONFIDENTIAL**  
 The information on this document is the property of **BHARAT HEAVY ELECTRICALS LIMITED**  
 It must not be used directly or indirectly in any way detrimental to the interest of the company

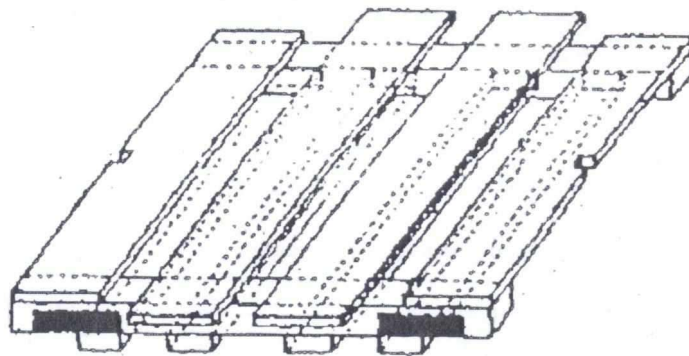
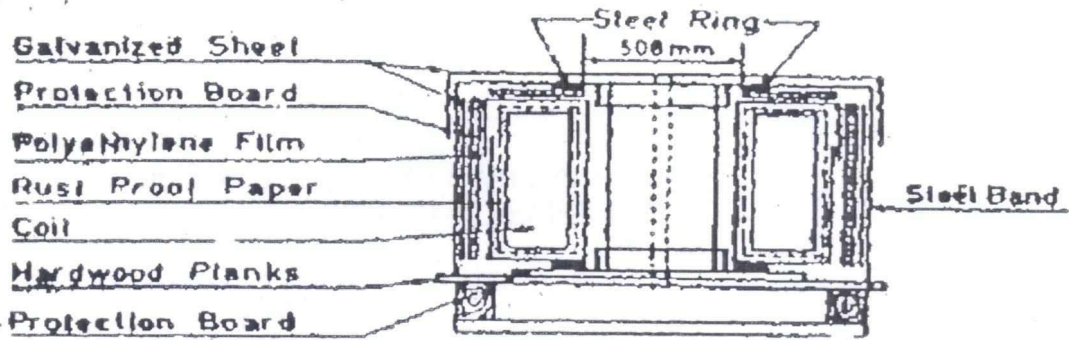
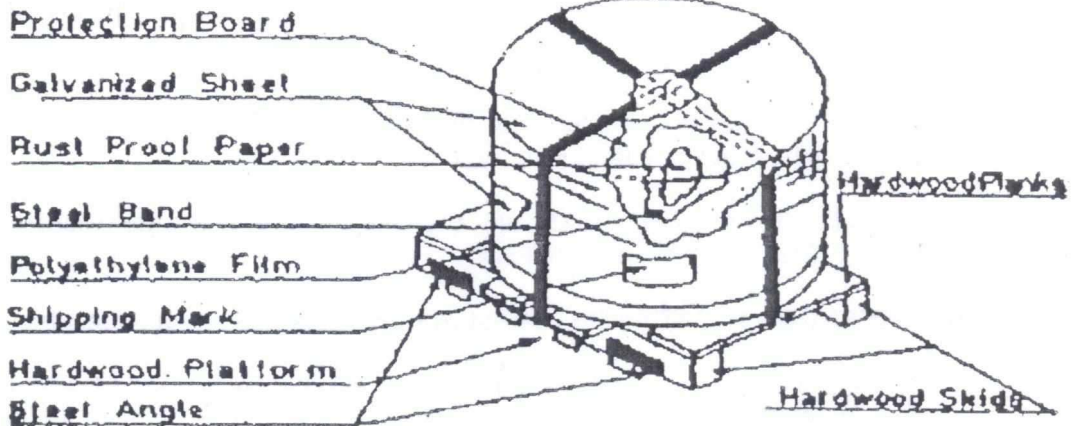

	 <p><b>PRODUCT STANDARD</b> TME DIVISION, BHOPAL</p> <p>TME 2011</p>	<p><b>TM 10472</b></p>												
		<p><b>Rev 03</b></p>												
		<p><b>PAGE 10 OF 10</b></p>												
<p style="writing-mode: vertical-rl; transform: rotate(180deg);"><b>COPYRIGHT AND CONFIDENTIAL</b></p> <p>The information on this document is the property of <b>BHARAT HEAVY ELECTRICALS LIMITED</b> It must not be used directly or indirectly in any way detrimental to the interest of the company</p>	<p><b>11.3 Marking:</b> A metal label/tag shall be securely attached with each bundle outside its wrapping and shall be legibly marked with the following information.</p> <p>TM10472 Rev No, BHEL Order No, Supplier's Name/Grade/Identification No., Size &amp; Weight, Melt No., Packet/Bundle No.</p> <p><b>12.0 REFERRED STANDARDS (Latest Publications Including Amendments):</b></p> <table border="0"> <tr> <td>1) AA 0851711</td> <td>2) AA 27541</td> <td>3) IS: 648</td> <td>4) IS:649</td> </tr> <tr> <td>5) DIN EN 10106</td> <td>5) DIN 50462</td> <td>7) AISI, C-6</td> <td>8) AA10917</td> </tr> <tr> <td>9) 4TMS.096.053</td> <td></td> <td></td> <td></td> </tr> </table> <hr/> <p style="text-align: center;"><b>GENERAL INFORMATION FOR CALCUALTION</b> <b>(NOT MANDATORY/TYPICAL VALUES)</b></p> <p>Density : 7.7 kg/dm<sup>3</sup></p> <p>Magnetic induction (B) at 30,000 A/m (Peak) A/C : Magnetic field Strength (H) (Peak) 1.97 Tesla, min - 0.5mm, thick</p> <p>Total specific loss at 1.0 Tesla : 2.30 watts/kg, max for 0.50mm</p> <p><u>Mechanical Properties (Typical):</u></p> <p>Tensile strength : 430 N/mm<sup>2</sup> Yield strength : 290 N/mm<sup>2</sup> Elongation on (5.65√So G.L . : 30%</p>		1) AA 0851711	2) AA 27541	3) IS: 648	4) IS:649	5) DIN EN 10106	5) DIN 50462	7) AISI, C-6	8) AA10917	9) 4TMS.096.053			
1) AA 0851711	2) AA 27541	3) IS: 648	4) IS:649											
5) DIN EN 10106	5) DIN 50462	7) AISI, C-6	8) AA10917											
9) 4TMS.096.053														

**INTEGRITY PACT****Between**

Bharat Heavy Electricals Ltd. (BHEL), a company registered under the Companies Act 1956 and having its registered office at "BHEL House", Siri Fort, New Delhi - 110049 (India) hereinafter referred to as "The Principal", which expression unless repugnant to the context or meaning hereof shall include its successors or assigns of the ONE PART

**and**

\_\_\_\_\_, (description of the party along with address), hereinafter referred to as "The Bidder/ Contractor" which expression unless repugnant to the context or meaning hereof shall include its successors or assigns of the OTHER PART

**Preamble**

The Principal intends to award, under laid-down organizational procedures, contract/s for

Supply of Cold Rolled Non-grain Oriented Sheet Steel, Insulated  
Gx-530, TM 10.472, Size - 0.5 X 710 X COIL

Tender Enquiry No. 2100098 The Principal values full compliance with all relevant laws of the land, rules and regulations, and the principles of economic use of resources, and of fairness and transparency in its relations with its Bidder(s)/ Contractor(s).

In order to achieve these goals, the Principal will appoint Independent External Monitor(s), who will monitor the tender process and the execution of the contract for compliance with the principles mentioned above.

**Section 1- Commitments of the Principal**

1.1 The Principal commits itself to take all measures necessary to prevent corruption and to observe the following principles:-

1.1.1 No employee of the Principal, personally or through family members, will in connection with the tender for, or the execution of a contract, demand, take a promise for or accept, for self or third person, any material or immaterial benefit which the person is not legally entitled to.

1.1.2 The Principal will, during the tender process treat all Bidder(s) with equity and reason. The Principal will in particular, before and during the tender process, provide to all Bidder(s) the same information and will not provide to any Bidder(s) confidential/ additional information through which the Bidder(s) could obtain an advantage in relation to the tender process or the contract execution.

1.1.3 The Principal will exclude from the process all known prejudiced persons.

1.2 If the Principal obtains information on the conduct of any of its employees which is a penal offence under the Indian Penal Code 1860 and Prevention of Corruption Act 1988 or any other statutory penal enactment, or if there be a substantive suspicion in this regard, the Principal will inform its Vigilance Office and in addition can initiate disciplinary actions:

*Vash*

## **Section 2 - Commitments of the Bidder(s)/ Contractor(s)**

- 2.1 The Bidder(s)/ Contractor(s) commit himself to take all measures necessary to prevent corruption. He commits himself to observe the following principles during his participation in the tender process and during the contract execution.
- 2.1.1 The Bidder(s)/ Contractor(s) will not, directly or through any other person or firm, offer, promise or give to the Principal or to any of the Principal's employees involved in the tender process or the execution of the contract or to any third person any material, immaterial or any other benefit which he/ she is not legally entitled to, in order to obtain in exchange any advantage of any kind whatsoever during the tender process or during the execution of the contract.
- 2.1.2 The Bidder(s)/ Contractor(s) will not enter with other Bidder(s) into any illegal or undisclosed agreement or understanding, whether formal or informal. This applies in particular to prices, specifications, certifications, subsidiary contracts, submission or non-submission of bids or any other actions to restrict competitiveness or to introduce cartelization in the bidding process.
- 2.1.3 The Bidder(s)/ Contractor(s) will not commit any penal offence under the relevant Indian Penal Code (IPC) and Prevention of Corruption Act; further the Bidder(s)/ Contractor(s) will not use improperly, for purposes of competition or personal gain, or pass on to others, any information or document provided by the Principal as part of the business relationship, regarding plans, technical proposals and business details, including information contained or transmitted electronically.
- 2.1.4 Foreign Bidder(s)/ Contractor(s) shall disclose the name and address of agents and representatives in India and Indian Bidder(s)/ Contractor(s) to disclose their foreign principals or associates. The Bidder(s)/ Contractor(s) will, when presenting his bid, disclose any and all payments he has made, and is committed to or intends to make to agents, brokers or any other intermediaries in connection with the award of the contract.
- 2.2 The Bidder(s)/ Contractor(s) will not instigate third persons to commit offences outlined above or be an accessory to such offences.
- 2.3 The Bidder(s)/ Contractor(s) shall not approach the Courts while representing the matters to IEMs and will await their decision in the matter.

## **Section 3 - Disqualification from tender process and exclusion from future contracts**

If the Bidder(s)/ Contractor(s), before award or during execution has committed a transgression through a violation of Section 2 above, or acts in any other manner such as to put his reliability or credibility in question, the Principal is entitled to disqualify the Bidder(s)/ Contractor(s) from the tender process or take action as per the separate "Guidelines on Banning of Business dealings with Suppliers/ Contractors", framed by the Principal.

## **Section 4 - Compensation for Damages**

- 4.1 If the Principal has disqualified the Bidder from the tender process prior to the award according to Section 3, the Principal is entitled to demand and recover the damages equivalent Earnest Money Deposit/ Bid Security.
- 4.2 If the Principal has terminated the contract according to Section 3, or if the Principal is entitled to terminate the contract according to section 3, the Principal shall be entitled to



demand and recover from the Contractor liquidated damages equivalent to 5% of the contract value or the amount equivalent to Security Deposit/ Performance Bank Guarantee, whichever is higher.

### **Section 5 - Previous Transgression**

- 5.1 The Bidder declares that no previous transgressions occurred in the last 3 years with any other company in any country conforming to the anti-corruption approach or with any other Public Sector Enterprise in India that could justify his exclusion from the tender process.
- 5.2 If the Bidder makes incorrect statement on this subject, he can be disqualified from the tender process or the contract, if already awarded, can be terminated for such reason.

### **Section 6 - Equal treatment of all Bidders/ Contractors / Sub-contractors**

- 6.1 The Principal will enter into agreements with identical conditions as this one with all Bidders and Contractors. In case of sub-contracting, the Principal contractor shall be responsible for the adoption of IP by his sub-contractors and shall continue to remain responsible for any default by his sub-contractors:
- 6.2 The Principal will disqualify from the tender process all bidders who do not sign this pact or violate its provisions.

### **Section 7 - Criminal Charges against violating Bidders/ Contractors /Subcontractors**

If the Principal obtains knowledge of conduct of a Bidder, Contractor or Subcontractor, or of an employee or a representative or an associate of a Bidder, Contractor or Subcontractor which constitutes corruption, or if the Principal has substantive suspicion in this regard, the Principal will inform the Vigilance Office.

### **Section 8 - Independent External Monitor(s)**

- 8.1 The Principal appoints competent and credible Independent External Monitor for this Pact. The task of the Monitor is to review independently and objectively, whether and to what extent the parties comply with the obligations under this agreement.
- 8.2 The Monitor is not subject to instructions by the representatives of the parties and performs his functions neutrally and independently. He reports to the CMD, BHEL.
- 8.3 The Bidder(s)/ Contractor(s) accepts that the Monitor has the right to access without restriction to all contract documentation of the Principal including that provided by the Bidder(s)/ Contractor(s). The Bidder(s)/ Contractor(s) will grant the monitor, upon his request and demonstration of a valid interest, unrestricted and unconditional access to his contract documentation. The same is applicable to Sub-contractor(s). The Monitor is under contractual obligation to treat the information and documents of the Bidder(s)/ Contractor(s) / Sub-contractor(s) with confidentiality in line with Non- disclosure agreement.
- 8.4 The Principal will provide to the Monitor sufficient information about all meetings among the parties related to the contract provided such meetings could have an impact on the contractual relations between the Principal and the Contractor. The parties offer to the Monitor the option to participate in such meetings.



- 8.5 The role of IEMs is advisory, would not be legally binding and it is restricted to resolving issues raised by an intending bidder regarding any aspect of the tender which allegedly restricts competition or bias towards some bidders. At the same time, it must be understood that IEMs are not consultants to the Management. Their role is independent in nature and the advice once tendered would not be subject to review at the request of the organization.
- 8.6 For ensuring the desired transparency and objectivity in dealing with the complaints arising out of any tendering process, the matter should be examined by the full panel of IEMs jointly as far as possible, who would look into the records, conduct an investigation, and submit their joint recommendations to the Management.
- 8.7 The IEMs would examine all complaints received by them and give their recommendations/ views to CMD, BHEL, at the earliest. They may also send their report directly to the CVO and the Commission, in case of suspicion of serious irregularities requiring legal/ administrative action. IEMs will tender their advice on the complaints within 10 days as far as possible.
- 8.8 The CMD, BHEL shall decide the compensation to be paid to the Monitor and its terms and conditions.
- 8.9 IEM should examine the process integrity, they are not expected to concern themselves with fixing of responsibility of officers. Complaints alleging mala fide on the part of any officer of the organization should be looked into by the CVO of the concerned organisation.
- 8.10 If the Monitor has reported to the CMD, BHEL, a substantiated suspicion of an offence under relevant Indian Penal Code/ Prevention of Corruption Act, and the CMD, BHEL has not, within reasonable time, taken visible action to proceed against such offence or reported it to the Vigilance Office, the Monitor may also transmit this information directly to the Central Vigilance Commissioner, Government of India.
- 8.11 The number of Independent External Monitor(s) shall be decided by the CMD, BHEL.
- 8.12 The word 'Monitor' would include both singular and plural.

### **Section 9 - Pact Duration**

- 9.1 This Pact shall be operative from the date IP is signed by both the parties till the final completion of contract for successful bidder and for all other bidders 6 months after the contract has been awarded. Issues like warranty / guarantee etc. should be outside the purview of IEMs.
- 9.2 If any claim is made/ lodged during currency of IP, the same shall be binding and continue to be valid despite the lapse of this pact as specified above, unless it is discharged/ determined by the CMD, BHEL.

### **Section 10 - Other Provisions**

- 10.1 This agreement is subject to Indian Laws and jurisdiction shall be registered office of the Principal, i.e. New Delhi.

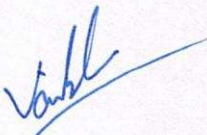

- 10.2 Changes and supplements as well as termination notices need to be made in writing. Side agreements have not been made.
- 10.3 If the Contractor is a partnership or a consortium, this agreement must be signed by all partners or consortium members.
- 10.4 Should one or several provisions of this agreement turn out to be invalid, the remainder of this agreement remains valid. In this case, the parties will strive to come to an agreement to their original intentions.
- 10.5 Only those bidders / contractors who have entered into this agreement with the Principal would be competent to participate in the bidding. In other words, entering into this agreement would be a preliminary qualification.

*Vaibhav Jain*

For & On behalf of the Principal

**वैभव जैन**  
**VAIBHAV JAIN**  
प्रबन्धक (सागरी प्रबन्धन)

(Office Seal) Manager (M M)  
बिहार, जगदीशपुर, ओ.डी. जगदीशपुर-अमेठी  
BHEL, FSIP, Ind. Area Jagdishpur-Amethi

For & On behalf of the Bidder/

Contractor

(Office Seal)

Place

*Jagdishpur (U.P.)*

Date

*09/10/2021*

Witness:

*Vasudev*  
*09/10/2021*

(Name & Address) *VASU DEV*

*Dy. Engineer - MM*

*BHEL Jagdishpur*

Witness: \_\_\_\_\_

(Name & Address) \_\_\_\_\_