



Bharat Heavy Electricals Limited Sub-Contracting (Turbine) HEEP,
BHEL, Ranipur, Haridwar-249403 (Uttarakhand) Ph. No.: 01334-285166
E-mail: amit.garg@bhel.in; Kumar.jitendra@bhel.in

NIT-NOTICE INVITING TENDER (OPEN TENDER IN TWO PART BID) THROUGH BHEL E-PROCUREMENT PORTAL

TENDER ENQUIRY NO.: X/6600/2024/0839/R/1

Salient Details of Notice Inviting Tender (NIT)					
Sl. No.	Issue	Description			
1	Item details	SN	Item	Drg. No.	Qty.
		1	ROUGH MACHINING OF HP INNER CASING	0105023050000	1 No.
2	Issue of Tender documents	From BHEL eProcurement website https://eprocurebhel.co.in/nicgep/app (Tender documents will be available for downloading from BHEL e-Procurement website till due date of submission)			
3	Due date of offer submission	Date: 24-02-2025 Time: 13:45 Hrs. https://eprocurebhel.co.in/nicgep/app <i>Offer to be submitted in online only through e-procurement Portal.</i> (Bidders are requested to visit website to view corrigendum/ addenda/ amendments/ extension/ modification etc. before submitting offer).			
4	Opening of Tender (Techno-Commercial Bid)	Date: 24-02-2025 Time: 14.00 Hrs. Note: <i>This tender being an e-tender, it shall be opened online only through the E-Procurement Portal. Participating bidders may witness the opening online only.</i>			
6	Latest updates	Latest updates on the important dates, Amendments, Correspondences, Corrigenda, Clarifications, Changes, Errata, Modifications, Revisions, etc to Tender Specifications will be hosted in BHEL e-tender portal https://eprocurebhel.co.in/nicgep/app and not in the newspapers. Bidders to keep themselves updated with all such information.			

Please submit your offer only for the above requirement subject to compliance of all **Buyer Added Bid Specific Additional Terms & Conditions, Special terms and conditions, Technical specifications and requirements, Latest Version of GENERAL INSTRUCTIONS AND STANDARD TERMS & CONDITIONS (GISTC)**. Please visit our site <https://hwr.bhel.com/bhelweb/CodeFiles/gistc.jsp> for latest revision of General Instructions and Standard Terms & Conditions (GISTC) for Tender Enquiries.

A Valid MSE certificate such as Udyam Registration issued from competent authority shall be submitted in support of Micro & Small Enterprises (MSEs). As per the OM No. F. No. 1(2)(1)/2016-MA dated. 09.02.2017 issued from the Office of Development Commissioner (Micro, Small Enterprises), "Traders and agents should not be allowed to avail the benefits extended under the PP Policy."

Bids shall be submitted by vendors as per Buyer added terms and conditions, special contract terms, technical terms and latest applicable GISTC

Drawings of Tender items and other documents will be provided only after receipt of Non-Disclosure Agreement (Duly filled, signed and stamped, on each pages) by the vendor. Vendor can provide scanned copy of Non-Disclosure Agreement through e-mail and ask for drawings & documents well before opening date and time of enquiry. BHEL Haridwar registered vendors are exempted for submission of Non-Disclosure Agreement. Format of Non-Disclosure Agreement is attached with tender document.

Please submit your lowest quotation / offer for the above requirement subject to our terms and conditions.

E-Procurement Portal Inputs

Procedure for Submission of Offer for E-Tender procedure for Submission of Tender is available in the "Bidder Manual for BHEL Bidders" at E-tender portal <https://eprocurebhel.co.in/nicgep/app>. Terms and conditions mentioned therein shall form integral part of the NIT and bidders shall abide by the same.

Hardware and Software requirements for participating in e-tender

Please refer the website for the minimum system requirements and setting document for Bidders under the link: <https://eprocurebhel.co.in/nicgep/app>

Digital Signature

Bidders against tender will necessarily have to obtain class - III DSCs. Procedure for application available on www.bhel.com. To know the procedure for obtaining Digital Signature Certificate (DSC), suppliers who are not having the DSC are advised to visit our website [http://www.bhel.com/home.php/Tender Notifications/Sample Checklist](http://www.bhel.com/home.php/Tender%20Notifications/Sample%20Checklist).

NIC portal Helpdesk Contacts

For any technical related queries please call at 24 x 7 Help Desk Number

0120-4001 002

0120-4200 462

0120-4001 005

0120-6277 787

International bidders are requested to prefix 91 as country code

Email Support

A) For any Issues or Clarifications relating to the published tenders, bidders are requested to contact the respective Tender Inviting Authority.

B) For Technical support: eproc@nic.in

Note: Offers/tenders submitted in the E-tender portal shall only be considered for further evaluation. Offers sent by FAX / E-mail / any mode other than E-tender would not be entertained.

SPECIAL NOTE: All documents to be submitted should be uploaded in respective places in the E-Tender portal as per the list mentioned given in this NIT. BHEL shall not be responsible for incomplete documents.

KINDLY READ "ESSENTIAL INSTRUCTIONS FOR BID SUBMISSION" THOROUGHLY. QUOTATION NOT IN ACCORDANCE WITH THE ABOVE INSTRUCTION ARE LIABLE TO BE DISQUALIFIED AND IGNORED.

ESSENTIAL INSTRUCTIONS FOR BID SUBMISSION

Clause 1.0 – Tender submission and opening

The tenders shall be submitted in **TWO PARTS** as described below on or before the due date and time of tender opening:

- a) Part-I (Cover I) : 1. Pre-Qualifying Requirement (PQR) duly filled and required documents as asked in PQR.
2. Techno-Commercial Bid. Techno-Commercial Terms & Conditions as per special terms and conditions, Buyer added terms and conditions alongwith various annexures should be filled by vendor and submitted along with part-1 of tender enquiry.
3. Replica of price bid (un-priced quotation) must be enclosed with part-1 of tender enquiry.
4. Deviation with reference to specification to be laid down on separate sheet. Cost of deviation is to be submitted along with the price bid essentially. In case vendor withdraws the deviation clauses the same will be considered for final evaluation.
5. Any other related documents.

b) Part-II (Cover II): The Price Bid in BOQ format shall comprise of the price bid only (with price) as per Tender Enquiry.

Part II containing Price Bid will be opened on a separate date for those vendors who have qualified in the Part I. The opening date of Part II will be intimated in advance to the vendors qualified in Part-I.

If replica of price bid (un-priced) is not submitted along with Part-I bid, the offer is liable to be rejected.

- Any corrections / amendments shall be properly & fully authenticated with signature.

The bidders will have to submit signed offer / bid through BHEL NIC portal only. Each page of quotation should be signed and stamped by authorized representative of vendor, else the offer is liable to be rejected. **Unsigned bids are liable to be ignored.**

Terms and conditions agreed by vendor in techno-commercial bid shall be finalized before price bid opening and any terms mentioned by vendor in price bid shall not be considered.

Clause No. 2.0:

As per directives of CENTRAL VIGILANCE COMMISSION, GOVERNMENT OF INDIA, one agent cannot represent two or more suppliers or quote on their behalf in a particular tender. If so found at any stage, BHEL Hardwar is likely to cancel Enquiries / POs to such suppliers. Further, such Indian Agent is likely to be de-listed (Black listed for business from BHEL)

Clause No. 3.0:

The offers of the bidders who are on the debarred list and also the offer of the bidders, who engage the services of the debarred firm, shall be rejected. The list of debarred firms is available on BHEL website www.bhel.com.

Special Terms & conditions of Tender Enquiry:

1. Loading Criteria:

- a) BHEL may load maximum penalty under LD clause, to the extent the same is not agreed by the vendor, for the purpose of comparative statement. Where deliveries quoted by the vendors are not suiting, BHEL may also ignore the offer of the vendor.
- b) Prices should be quoted on F.O.R. Destination basis. The offers quoted on other than F.O.R destination basis may result in non-consideration of such bids. In case BHEL accepts the EX-Works, prices such offers will be loaded with actual freight charges as per BHEL freight rate contract.
- c) Please quote your rates on FOR destination basis. However, the insurance will be arranged by BHEL. You can dispatch goods through any Indian Bank Association approved transporters having their branch at Haridwar/destination. For your convenience the names and addresses of transporters approved by IBA & BHEL are posted at <https://hwr.bhel.com/bhelweb/Home.jsp>." If any bidder still quotes on other than FOR destination basis, then his offer will be loaded by the maximum freight, packing & forwarding charges quoted by any other bidder from the same or nearby station, against the enquiry/freight rate available with BHEL.
- d) Loading of any deviation in the payment terms w.r.t. NIT terms shall be referenced as follows:
 - (a) Loading will be done @ Base rate of SBI + 6% (per annum) of basic cost of the items as per table mentioned under the clause 'Payment Terms' in GISTC.
 - (b) The base rate of SBI shall be considered as applicable on 31st March of preceding year from tender due date.

2. Material should come back within one year positively from the date of challan against which material was sent to sub-contractor. In case material is not returned within 12 months period, applicable GST with interest from the date of challan shall become payable on expiry of one-year period and the applicable GST with interest will be debited from sub-contractor account.

3. In case quantity is non-divisible in nature, the contract for such quantity will be awarded to L1 bidder. In such cases, quantity shall not be counter offered to MSE bidders.

4. Treatment of offers submitted by agents in OT:

- a) Either the agent could bid on behalf of the manufacturer/ supplier or the manufacturer/ supplier could bid directly but not both.
- b) In case bids are received from both the manufacturer/ supplier and the agent, bid received from the agent shall be ignored.
- c) The agent shall not be allowed to represent more than one manufacturer/ supplier in the same tender.
- d) The authorization letter from the manufacturer, clearly indicating contact details like Name, E-mail & address of manufacturer and relationship with agent and its validity to be submitted with bid. The authorization letter should be tender specific. In case order is to be placed and executed by the agent, the following aspects should be followed:
 - i) The manufacturer should meet the PQR requirement as defined in the tender.
 - ii) Manufacturer and bidder should Jointly confirm Guarantee for the Quality of product and timely delivery as stipulated in the NIT.
- e) BHEL will deal directly with the manufacturers / principal vendors and no correspondence with the agents will be entertained. The agents will not be permitted to visit / interact with BHEL on behalf of their principals. Subsequently also, no correspondence of any type will be made with any agent. (All individuals / companies - representing / Advisor / retainer ship basis or claimed to be part time employees for many OEMs / claiming to be channel or business partner for BHEL work / stockiest

not registered specifically etc. are Agents). Communications with only those agents who have submitted agency agreement with their respective principal may be done.

5. Without explicit written permission from BHEL, Haridwar:

- a) Vendors shall not pass on any Drawings/Documents or its contents/copy in any form which are being supplied by BHEL Haridwar with the Enquiry/Sub-Contract Order to any other party.
 - b) Vendors shall not Sub-Contract the work or part of it to any sub-vendor.
 - c) The Vendors shall not use BHEL Haridwar Drawings/documents (supplied by BHEL Haridwar) for supplying the item to any other party.
 - d) It shall be ensured that the material is procured (in case of party material) from BHEL approved supplier along with correlated test certificates. No waiver shall be acceptable in this. In case the repeat testing is required, it should be done at NABL accredited labs only. Failing above, BHEL Haridwar shall have the right to take necessary action (including legal action also) and/or impose the penalty, as deemed fit.
6. BHEL reserves the right to open the price bid (part-II) along with the opening of techno-commercial offer at its option and in that case, vendor will be informed accordingly.
7. In case of package wise evaluation, Prices shall be furnished for all items of package as per tender terms & conditions. **Else, the bid is liable for rejection.** Quotation must be clearly legible.
8. In the course of Evaluation, if more than one bidder happens to occupy L-1 status, effective L-1 will be decided by soliciting discounts from respective L-1 bidders. In case more than one bidder happens to occupy the L-1 status even after soliciting discounts, the L-1 bidder shall be decided by a toss/ draw of lots, in the presence of respective L-1 bidder(s) or their representative(s). Ranking will be done accordingly. BHEL decision in such situations shall be final and binding.
9. Any item not included in this tender quoted above and shown separately will not be taken cognizance of and shall be ignored while evaluation.
10. BHEL will evaluate the technical bids against essential criteria/requirements. BHEL may seek clarifications, if required, from the bidders. These clarifications will be communicated to the vendors through e-mail. The bidders will be given sufficient time to respond the clarifications.

The offers of those bidders, who are unable to respond in this time frame, are likely to be ignored.

11. All the bidders whose offers have been accepted by BHEL will be given notice for opening of their original price bid and supplementary impact bid (if applicable).
12. The quantity may undergo change at the time of ordering.
13. No standard gauges up to M42 shall be provided by BHEL.
14. All enclosures must be sent with the quotation with seal and signature.
15. In case of rejection, total material cost along with other commercial overheads will be recovered from Vendor.
16. For each supply, vendors are requested to raise separate Invoice along with Running Tally sheet (RTS), GST compliance Certificate, Copy of BHEL GST challan, Material receiving (Material sent by BHEL at vendor's work) document at vendor's works & Guarantee certificate. In case vendor will not submit material receiving document, then GST challan date mentioned in GST challan shall be considered as material receiving date at vendor's work. All invoices must be submitted in AIX-Turbine, BHEL Haridwar for further payment processing.

17. Mandatory e-invoice if turnover of vendor / contractor is more than Rs. 5 crores in any preceding financial year from 2017-18 onwards as per notification no. 10/2023-central tax w.e.f. 01.08.2023). also, invoice must include INR and QR code on tax invoice or declaration by vendor/contractor if turnover in any preceding financial year from 2017-18 onwards is less than Rs. 5 crores.
18. In case the vendor/contractor delays or fails to provide all the documents as per the purchase order/ work order at the time of submitting tax invoice to BHEL, any subsequent financial loss to BHEL on account of vendor/ contractor shall be to vendor's / contractor's account. BHEL has further right to take necessary steps to protect its interest at the time of release of payment.
19. Material shall be sent to sub-contractor against Bank Guarantee and Indemnity Bond. In case of rejection/non-delivery of material, material cost shall be recovered from sub-contractor by BHEL.
20. Where Bank Guarantee and Indemnity Bond clause not accepted by vendor, BHEL may ignore the offer of vendors.
21. Prices quoted should not be more than the prices quoted to any other BHEL units/offices/ divisions.
22. In the event of BHEL calling for supplementary bid, the part-II price Bid along with supplementary priced bid (if necessary) will be opened at a later date of only those bidders who have qualified in the Part I. The opening date of Part II along with supplementary price bid (if necessary) will be intimated in advance to the vendors qualified in Part-I.
23. Bid should be free from correction, overwriting, using corrective fluid, etc. Any interlineation, cutting, erasure or overwriting shall be valid only if they are attested under full signature(s) of person(s) signing the bid else bid shall be liable for rejection.
24. The material issued to sub-contractor as free issue material for machining/machining & assembly/ coating operations shall remain the property of BHEL, Haridwar. The sub-contractor shall use the materials only for BHEL contract and for no other purpose whatsoever. The sub-contractor shall be liable for the loss or damage to above material from whatsoever cause happening while such material is in the possession or under the control of the sub-contractor. All the materials of BHEL, Haridwar shall under no circumstances be hypothecated to any Bank or to any lending institution or to any Party whatsoever. It should not also be shown as the sub-contractor's assets in any of the statements of sub-contractor to any party. The sub-contractor shall produce document for the free issue material supplied to them to BHEL officials visiting the sub-contractor's unit for verifications/inspection purposes at any time. If sub-contractor fails to produce or properly account for the material so issued, BHEL Haridwar will take further action as deemed fit including the recovery of the value of material as per BHEL norms from the sub-contractor's running bills/ encash sub-contractor's Bank Guarantee/ Indemnity Bond (IB).

25. Action against Bidders / vendor / supplier / contractor in case of default:

In order to protect the commercial interests of BHEL, BHEL shall act against supplies / contractors by way of suspension of business dealings, who either fail to perform or are in default without any reasonable cause, cause loss of business/ money/ reputation, indulge in malpractices, cheating, bribery, fraud or any other misconduct or formation of cartels so as to influence the bidding process or influence the price etc.

Suspension of Business Dealings could be in the form of "Hold" or "Banning" a supplier/ contractor or a bidder and shall be as per "Guidelines for Suspension of Business Dealings with Suppliers/ Contractors" available at BHEL's website "<https://www.bhel.com/guidelines-suspension-business-dealings-supplierscontractors>".

26. "The offers of the bidders who are under suspension as also the offers of the bidders, who engage the services of the firms debarred across BHEL, shall be rejected. The list of firms debarred across BHEL is available on BHEL web site www.bhel.com.

1.0 Integrity commitment, performance of the contract and punitive action thereof:

1.1. Commitment by BHEL:

BHEL commits to take all measures necessary to prevent corruption in connection with the tender process and execution of the contract. BHEL will during the tender process treat all Bidder(s) in a transparent and fair manner, and with equity.

1.2. Commitment by Bidder/ Supplier/ Contractor:

1.2.1. The bidder/ supplier/ contractor commits to take all measures to prevent corruption and will not directly or indirectly influence any decision or benefit which he is not legally entitled to nor will act or omit in any manner which tantamount to an offence punishable under any provision of the Indian Penal Code, 1860 or any other law in force in India.

1.2.2. The bidder/ supplier/ contractor will, when presenting his bid, disclose any and all payments he has made, and is committed to or intends to make to agents, brokers or any other intermediaries in connection with the award of the contract and shall adhere to relevant guidelines issued from time to time by Govt. of India/ BHEL.

1.2.3. The bidder/ supplier/ contractor will perform/ execute the contract as per the contract terms & conditions and will not default without any reasonable cause, which causes loss of business/ money/ reputation, to BHEL.

If any bidder/ supplier/ contractor during pre-tendering/ tendering/ post tendering/ award/ execution/ post-execution stage indulges in malpractices, cheating, bribery, fraud or and other misconduct or formation of cartel so as to influence the bidding process or influence the price or acts or omits in any manner which tantamount to an offence punishable under any provision of the Indian Penal Code, 1860 or any other law in force in India, then, action may be taken against such bidder/ supplier/ contractor as per extant guidelines of the company available on [www. bhel.com](http://www.bhel.com) and/or under applicable legal provisions”.

Date :

Signature :

Name :

Designation :

Department :

M/s

UN-PRICE BID

Quotation no.....Dated.....

BHEL Tender Enquiry No.: X/6600/2024/0839/R/1

Sl. No.	Item Description	Drawing No.	Material By	Qty. (Nos)	Quoted/Not Quoted
1	ROUGH MACHINING OF HP INNER CASING	0105023050000	BHEL	1	

Seal and Signature of Supplier

BHARAT HEAVY ELECTRICALS LIMITED
Haridwar-249403
Buyer Added Bid Specific Additional Terms & Conditions (ATC)

Note: This Annexure has to be mandatorily filled & signed by the manufacturer (or) mill and submitted along with Technical bid.

Any deviation to the below mentioned terms shall be stated specifically in the comments column for each term and also in case of acceptance to our terms, it will be construed that the whole term is understood and agreed in totality without any deviation. (If otherwise mentioned).

SI No	BHEL Requirements	Supplier Comments
01	<p>Pre-Qualification Criteria:</p> <p>1.1 Technical (attached)</p> <p>1.2 Integrity Pact -Not Applicable</p> <p>1.3 Bidder must not be admitted under Corporate Insolvency Resolution Process or Liquidation as on date, by NCLT or any adjudicating authority/authorities, and shall submit undertaking (Annexure-4) to this effect.</p> <p>Explanatory Notes for the PQR:</p> <p>i. Credentials furnished by the bidder against "PRE-QUALIFYING CRITERIA" shall be verified from the issuing authority for its authenticity. In case, any credential (s) is/are found to be spurious, offer of the bidder is liable to be rejected. BHEL reserves the right to initiate any further action as per extant guidelines for Suspension of Business Dealings as applicable in BHEL.</p> <p>ii. Price Bids of only those bidders shall be opened who stand qualified after compliance of PQR.</p>	
02	<p>Scope of Supply:</p> <ol style="list-style-type: none"> 1. MACHINING IS TO BE CARRIED OUT AS PER DRAWINGS/STANDARDS, TECHNICAL REQUIREMENTS AND QUALITY PLAN REQUIREMENTS (AS PER ATTACHED SCOPE OF WORK/TDC) 2. JOB WILL BE SENT TO VENDOR AFTER CONTROL MARKING 3. JOINT PLANE MACHINING, PINNING AND ROUGH VB SHALL BE DONE BY SUBCONTRACTOR 4. GROOVE PLAN MACHINING SHALL BE DONE AS PER DRG NO – 91010730552 5. TECHNOLOGICAL JOINT PLANE FASTENERS AND TAPER PINS SHALL BE PROVIDED BY BHEL. 	
03	<p>PRICE BASIS:</p> <p>Price in INR should be quoted for F.O.R. DESTINATION delivery to BHEL Haridwar</p> <p>GSTIN : 05AAACB4146P1ZL</p>	
04	<p>TAXES & DUTIES:</p> <p>4.1 The Supplier/Vendor shall pay all (save the specific exclusions as enumerated in this clause) taxes, fees, license, charges, deposits, duties, tools, royalty, commissions, other charges, etc. which may be levied on the input goods & services consumed and output goods & services delivered in course of his operations in executing the contract. In case BHEL is forced to pay any of such taxes/duties, BHEL shall have the right to recover the same from his bills or otherwise as deemed fit along with the applicable overheads @5% and interest on the total value (i.e. amount paid by BHEL + overhead).</p> <p>However, provisions regarding GST on output supply (goods/service) and TDS/TCS as per Income Tax Act shall be as per following clauses.</p> <p>4.2 GST (Goods and Services Tax)</p> <p>4.2.1 GST as applicable on output supply (goods/services) are excluded from Supplier/Vendor's scope; therefore, contractor's price/rates shall be exclusive of GST. Reimbursement of GST is subject to compliance of following terms and conditions. BHEL shall have the right to deny payment of GST and to recover any loss to BHEL on account of tax, interest, penalty etc. for non-compliance of any of the following condition.</p>	

4.2.2 The admissibility of GST, taxes and duties referred in this chapter or elsewhere in the contract shall be limited to direct transactions between BHEL & its Supplier/Vendor. BHEL shall not consider GST on any transaction other than the direct transaction between BHEL & its Supplier/Vendor.

4.2.3 Supplier/Vendor shall obtain prior written consent of BHEL before billing the amount towards such taxes. Where the GST laws permit more than one option or methodology for discharging the liability of tax/levy/duty, BHEL shall have the right to adopt the appropriate one considering the amount of tax liability on BHEL/Client as well as procedural simplicity with regard to assessment of the liability. The option chosen by BHEL shall be binding on the Contractor for discharging the obligation of BHEL in respect of the tax liability to the Supplier/Vendor.

4.2.4 Supplier/Vendor has to submit GST registration certificate of the concerned state. Supplier/Vendor also needs to ensure that the submitted GST registration certificate should be in active status during the entire contract period.

4.2.5 Supplier/Vendor has to issue Invoice/Debit Note/Credit Note indicating HSN/SAC code, Description, Value, Rate, applicable tax and other particulars in compliance with the provisions of relevant GST Act and Rules made thereunder.

4.2.6 Supplier/Vendor has to submit GST compliant invoice within the due date of invoice as per GST Law. In case of delay, BHEL reserves the right of denial of GST payment if there occurs any hardship to BHEL in claiming the input thereof. In case of goods, Supplier/Vendor has to provide scan copy of invoice & GR/LR/RR to BHEL before movement of goods starts to enable BHEL to meet its GST related compliances. Special care should be taken in case of month end transactions.

4.2.7 Supplier/Vendor has to ensure that invoice in respect of such services which have been provided/completed on or before end of the month should not bear the date later than last working day of the month in which services are performed.

4.2.8 Subject to other provisions of the contract, GST amount claimed in the invoice shall be released on fulfilment of all the following conditions by the Supplier/Vendor: -

- a) Supply of goods and/or services have been received by BHEL.
- b) Original Tax Invoice has been submitted to BHEL.
- c) Supplier/Vendor has submitted all the documents required for processing of bill as per contract/purchase order/ work order.
- d) In cases where e-invoicing provision is applicable, Supplier/Vendor is required to submit invoice in compliance with e-invoicing provisions of GST Act and Rules made thereunder.
- e) Supplier/Vendor has filed all the relevant GST return (e.g. GSTR-1, GSTR-3B, etc.) pertaining to the invoice submitted and submit the proof of such return along with immediate subsequent invoice. In case of final invoice/ bill, contractor has to submit proof of such return within fifteen days from the due date of relevant return.
- f) Respective invoice has appeared in BHEL's GSTR - 2A for the month corresponding to the month of invoice and in GSTR-2B of the month in which such invoices has been reported by the contractor along with status of ITC availability as "YES" in GSTR-2B. Alternatively, BG of appropriate value may be furnished which shall be valid at least one month beyond the due date of confirmation of relevant payment of GST on GSTN portal or sufficient security is available to adjust the financial impact in case of any default by the Supplier/Vendor.
- g) Supplier/Vendor has to submit an undertaking confirming the payment of all due GST in respect of invoices pertaining to BHEL.

4.2.9 Any financial loss arises to BHEL on account of failure or delay in submission of any document as per contract/purchase order/work order at the time of submission of Tax invoice to BHEL, shall be deducted from Supplier/Vendor's bill or otherwise as deemed fit.

4.2.10 TDS as applicable under GST law shall be deducted from Supplier/Vendor's bill.

4.2.11 Supplier/Vendor shall comply with the provisions of e-way bill wherever applicable. Further wherever provisions of GST Act permits, all the e-way bills, road permits etc. required for transportation of goods needs to be arranged by the contractor.

4.2.12 Supplier/Vendor shall be solely responsible for discharging his GST liability according to the provisions of GST Law and BHEL will not entertain any claim of GST/interest/penalty or any other liability on account of failure of Supplier/Vendor in complying the provisions of GST Law or discharging the GST liability in a manner laid down thereunder.

	<p>4.2.13 In case declaration of any invoice is delayed by the vendor in his GST return or any invoice is subsequently amended/altere/deleted on GSTN portal which results in any adverse financial implication on BHEL, the financial impact thereof including interest/penalty shall be recovered from the Supplier/Vendor's due payment.</p> <p>4.2.14 Any denial of input credit to BHEL or arising of any tax liability on BHEL due to non-compliance of GST Law by the Supplier/Vendor in any manner, will be recovered along with liability on account of interest and penalty (if any) from the payments due to the Supplier/Vendor.</p> <p>4.2.15 In the event of any ambiguity in GST law with respect to availability of input credit of GST charged on the invoice raised by the contractor or with respect to any other matter having impact on BHEL, BHEL's decision shall be final and binding on the Supplier/Vendor.</p> <p>4.2.16 Variation in Taxes & Duties:</p> <p>Any upward variation in GST shall be considered for reimbursement provided supply of goods and services are made within schedule date stipulated in the contract or approved extended schedule for the reason solely attributable to BHEL. However downward variation shall be subject to adjustment as per actual GST applicability.</p> <p>In case the Government imposes any new levy/tax on the output service/goods after price bid opening, the same shall be reimbursed by BHEL at actual. The reimbursement under this clause is restricted to the direct transaction between BHEL and its Supplier/Vendor only and within the contractual delivery period only.</p> <p>In case any new tax/levy/duty etc. becomes applicable after the date of Bidder's offer but before opening of the price Bid, the Bidder/ Supplier/Vendor must convey its impact on his price duly substantiated by documentary evidence in support of the same before opening of price bid. Claim for any such impact after opening the price bid will not be considered by BHEL for reimbursement of tax or reassessment of offer.</p> <p>4.3 Income Tax:</p> <p>TDS/TCS as applicable under Income Tax Act, 1961 or rules made thereunder shall be deducted/collected from Supplier/Vendor's bill.</p> <p>4.4 Supplier HSN Code & Applicable GST % (To be filled by Supplier)_____</p>	
05	MATERIAL DISPATCH CLEARANCE CERTIFICATE (MDCC): (Not Applicable)	
06	<p>INSPECTION / INSPECTION & TESTING AT SUPPLIERS WORKS:</p> <p>BHEL reserves the right to inspect the material during manufacturing and also to get tested the material under dispatch from third party. The test results of third party test shall be final and binding on the Supplier/Vendor.</p> <p>BHEL will reserve the right to inspect/test the material during/after manufacturing at suppliers' works, and/or at BHEL Site. In case of rejection at any stage, Supplier/Vendor shall be liable to replace the materials at his own cost.</p> <p>Vendor should raise inspection call for BHEL / TPI inspection at least 4 days in advance to the planned date of inspection. if customer inspection is envisaged at vendor's works, vendor should give inspection call at least 7 days in advance to the planned date of inspection.</p>	
07	<p>DELIVERY: Within 210 days of receipt of materials from BHEL Haridwar at vendor's works.</p> <p>NOTE:</p> <p>a) If the delivery of supply as detailed above gets delayed beyond the delivery period, the Supplier/Vendor shall request for a delivery extension and BHEL at its discretion may extend the Contract. However, if any 'Delivery extension' is granted to the Supplier/Vendor for completion of supply, due to backlog attributable to the Supplier/Vendor, then it shall be without prejudice to the rights of BHEL to impose LD for the delays attributable to the Supplier/Vendor.</p>	
08	<p>TRANSIT INSURANCE: Transit Insurance of material is in BHEL scope.</p> <p>A. Transportation of BHEL Material: By BHEL at vendor works on freight paid basis.</p>	

	<p>B. Delivery basis: Delivery of finished item must essentially be FOR BHEL Haridwar basis. Freight for sending finished components from vendor works to BHEL Haridwar shall be borne by vendor at its own cost & responsibility.</p>									
09	<p>PAYMENT TERMS:</p> <p>a) Payment: 90% payment will be done after receipt and acceptance of items in HEEP, BHEL, Haridwar and balance 10% payment will be done after final account of materials (i.e. Scrap Accountal). Currency of payment will be Indian Rupees (₹). Quotation containing payment term other than above, is liable to be rejected.</p> <p>The payment shall be made within no. of days as defined in the below table from appointed day</p> <table border="1"> <thead> <tr> <th>Type of Bidder</th> <th>Within Number of Days</th> </tr> </thead> <tbody> <tr> <td>Micro & Small Enterprises (MSEs)</td> <td>45 Days</td> </tr> <tr> <td>Medium Enterprises</td> <td>60 Days</td> </tr> <tr> <td>Non MSME</td> <td>90 Days</td> </tr> </tbody> </table> <p>Appointed day means</p> <ul style="list-style-type: none"> The day of delivery of material i.e. C-Note Date, subject to submission of non-discrepant documents by vendor as per Purchase Order. <p>or</p> <ul style="list-style-type: none"> Where there is any objection regarding acceptance of goods, the same shall be informed to supplier within fifteen days from the day of the delivery of good. Appointed day will be the day on which such objection is removed by the supplier. <p>However, GST amount shall be reimbursed in line with compliance to Cl. No. 4 (Taxes & Duties) above.</p> <p>b) NO INTEREST PAYABLE TO CONTRACTOR No interest shall be payable on the security deposit or any other money due to the Supplier.</p> <p>Notwithstanding anything to the contrary contained in any other document comprising in the Contract, no interest shall be payable by BHEL to supplier/vendor/contractor on any moneys or balances including but not limited to the Security Deposit, EMD, Retention Money, RA Bills or the Final Bill, or any amount withheld and/or appropriated by BHEL. etc., which becomes or as the case may be, is adjudged to be due from BHEL to supplier/vendor/contractor whether under the Contract or otherwise.</p>	Type of Bidder	Within Number of Days	Micro & Small Enterprises (MSEs)	45 Days	Medium Enterprises	60 Days	Non MSME	90 Days	
Type of Bidder	Within Number of Days									
Micro & Small Enterprises (MSEs)	45 Days									
Medium Enterprises	60 Days									
Non MSME	90 Days									
10	<p>DOCUMENTS REQUIRED FOR BILL PROCESSING: The following documents are required to be sent with Material Dispatch/Billing Documents:</p> <ul style="list-style-type: none"> Original Tax Invoice in triplicate (As per Cl. No. 4 above). Guarantee Certificate Inspection Report GST compliance certificate Running Tally sheet 									
11	<p>BANK DETAILS FOR EMD & PERFORMANCE SECURITY SUBMISSION: For Electronic Fund Transfer the details are as below: a) Name of the Beneficiary: Bharat Heavy Electricals Limited b) Bank Particulars:</p> <p>Name of the Company - BHARAT HEAVY ELECTRICALS LTD. Address of the company – HEEP Haridwar 249403 Name of the bank - STATE BANK OF INDIA Bank branch - RANIPUR BRANCH City HARIDWAR Branch code - 000586 Account Number – 10667995458 Account type - CC IFSC code - SBIN0000586 MICR code – 249002005</p>									
12	EARNEST MONEY DEPOSIT: Not Applicable									
13	PERFORMANCE SECURITY: Not Applicable									
14	<p>BREACH OF CONTRACT, REMEDIES AND TERMINATION:</p> <p>14.1 The following shall amount to breach of contract:</p> <ol style="list-style-type: none"> Non-supply of material/ non-completion of work by the Supplier/Vendor within scheduled delivery/ completion period as per contract or as extended from time to time. 									

- II. The Supplier/Vendor fails to perform as per the activity schedule and there are sufficient reasons even before expiry of the delivery/ completion period to justify that supplies shall be inordinately delayed beyond contractual delivery/ completion period
- III. The Supplier/Vendor delivers equipment/ material not of the contracted quality.
- IV. The Supplier/Vendor fails to replace the defective equipment/ material/ component as per guarantee clause.
- V. Withdrawal from or abandonment of the work by the Supplier/Vendor before completion as per contract.
- VI. Assignment, transfer, subletting of Contract by the Supplier/Vendor without BHEL's written permission resulting in termination of Contract or part thereof by BHEL.
- VII. Non-compliance to any contractual condition or any other default attributable to Supplier/Vendor.
- VIII. Any other reason(s) attributable to Vendor towards failure of performance of contract. In case of breach of contract, BHEL shall have the right to terminate the Purchase Order/ Contract either in whole or in part thereof without any compensation to the Supplier/Vendor.
- IX. Any of the declarations furnished by the contractor at the time of bidding and/ or entering into the contract for supply are found untruthful and such declarations were of a nature that could have resulted in non-award of contract to the contractor or could expose BHEL and/ or Owner to adverse consequences, financial or otherwise.
- X. Supplier/Vendor is convicted of any offence involving corrupt business practices, antinational activities or any such offence that compromises the business ethics of BHEL, in violation of the Integrity Pact entered into with BHEL has the potential to harm the overall business of BHEL/ Owner.

Note- Once BHEL considers that a breach of contract has occurred on the part of Supplier/Vendor, BHEL shall notify the Supplier/Vendor by way of notice in this regard. Contractor shall be given an opportunity to rectify the reasons causing the breach of contract within a period of 14 days.

In case the contractor fails to remedy the breach, as mentioned in the notice, to the satisfaction of BHEL, BHEL shall have the right to take recourse to any of the remedial actions available to it under the relevant provisions of contract.

14.2 Remedies in case of Breach of Contract.

- i. Wherein the period as stipulated in the notice issued under clause 14.1 has expired and Supplier/Vendor has failed to remedy the breach, BHEL will have the right to terminate the contract on the ground of "Breach of Contract" without any further notice to contractor.
- ii. Upon termination of contract, BHEL shall be entitled to recover an amount equivalent to 10% of the Contract Value for the damages on account of breach of contract committed by the Supplier/Vendor. This amount shall be recovered by way of encashing the security instruments like performance bank guarantee etc available with BHEL against the said contract. In case the value of the security instruments available is less than 10% of the contract value, the balance amount shall be recovered from other financial remedies (i.e. available bills of the Supplier/Vendor, retention amount, from the money due to the Supplier/Vendor etc. with BHEL) or the other legal remedies shall be pursued.
- iii. wherever the value of security instruments like performance bank guarantee available with BHEL against the said contract is 10% of the contract value or more, such security instruments to the extent of 10% contract value will be encashed. In case no security instruments are available or the value of the security instruments available is less than 10% of the contract value, the 10% of the contract value or the balance amount, as the case may be, will be recovered in all or any of the following manners:
- iv. In case the amount recovered under sub clause (a) above is not sufficient to fulfil the amount recoverable then; a demand notice to deposit the balance amount within 30 days shall be issued to Supplier/Vendor.
- v. If Supplier/Vendor fails to deposit the balance amount within the period as prescribed in demand notice, following action shall be taken for recovery of the balance amount:
 - a) from dues available in the form of Bills payable to defaulted Supplier/Vendor against the same contract.
 - b) If it is not possible to recover the dues available from the same contract or dues are insufficient to meet the recoverable amount, balance amount shall be recovered from any money(s) payable to Supplier/Vendor under any contract with other Units of BHEL including recovery from security deposits or any other deposit available in the form of security instruments of any kind against Security deposit or EMD.

- vi. In-case recoveries are not possible with any of the above available options, Legal action shall be initiated for recovery against defaulted supplier/Vendor.
- vii. It is an agreed term of contract that this amount shall be a genuine pre-estimate of damages that BHEL would incur in completion of balance contractual obligation of the contract through any other agency and BHEL will not be required to furnish any other evidence to the Supplier/Vendor for the purpose of estimation of damages.
- viii. In addition to the above, imposition of liquidated damages, debarment, termination, de-scoping, short-closure, etc., shall be applied as per provisions of the contract.

Note:

1) The defaulting Supplier/Vendor shall not be eligible for participation in any of the future enquiries floated by BHEL to complete the balance work. The defaulting contractor shall mean and include:

- (a) In case defaulted Supplier/Vendor is the Sole Proprietorship Firm, any Sole Proprietorship Firm owned by same Sole Proprietor.
- (b) In case defaulted Supplier/Vendor is The Partnership Firm, any firm comprising of same partners/ some of the same partners; or sole proprietorship firm owned by any partner(s) as a sole proprietor.

LD against delay in executed supply in case of Termination of Contract:

LD against delay in executed supply shall be calculated in line with LD clause no. 18.0 below, for the delay attributable to Supplier/Vendor. For limiting the maximum value of LD, contract value shall be taken as Executed Value of supply till termination of contract.

Method for calculation of “LD against delay in executed supply in case of termination of contract” is given below.

- i. Let the time period from scheduled date of start of supply till termination of contract excluding the period of Hold (if any) not attributable to contractor = T1
- ii. **Let the value of executed supply till the time of termination of contract= X**
- iii. Let the Total Executable Value of supply for which inputs/fronts were made available to Supplier/Vendor and were planned for execution till termination of contract = Y
- iv. Delay in executed supply attributable to Supplier/Vendor i.e. $T2 = [1 - (X/Y)] \times T1$
- v. LD shall be calculated in line with LD clause (clause 18.0) of the Contract for the delay attributable to Supplier/Vendor taking “X” as Contract Value and “T2” as period of delay attributable to Supplier/Vendor.

15 BILL TO/ SHIP TO ADDRESS:

To
 Manager
 HEEP Haridwar
 Uttrakhand-249403

16 GUARANTEE/WARRANTY:

Guarantee period for Supply of material shall be 18 calendar months from the date of last dispatch.

Vendor should submit Guarantee Certificate along with each supply of components. Components shall warrant for requirements as per BHEL drawings and other technical conditions. If the same are found defective owing to faulty workmanship/incomplete work within a period of 18 Months from the date of receipt, the supplier shall make good of it / replace/ repair/ complete the same free of cost. If rework/ repairing/Completion etc. is done by BHEL, the charges for same shall be deducted from the Sub-Contractor account.

17 MICRO AND SMALL ENTERPRISES (MSE):

Any Bidder falling under MSE category shall furnish the following details & submit documentary evidence/ Govt. Certificate etc. in support of the same along with their techno-commercial offer.

Type under MSE	UDYAM No	SC/ST Owned	Women Owned	Others (Excluding SC/ST/Women)
Micro				
Small				

Note: If the bidder does not furnish the above, offer shall be processed construing that the bidder is not falling under MSE category.

	<p>a) MSE suppliers can avail the intended benefits in respect of the procurements related to the Goods and Services only (Definition of Goods and Services as enumerated by Govt. of India vide Office Memorandum F. No. 21(8)/2011-MA dtd. 09/11/2016 office of AS & DC, MSME) only if they submit along with the offer, attested copies of either Udyam Registration. Date to be reckoned for determining the deemed validity will be the last date of Technical Bid submission. Non-submission of supporting document in NIC portal will lead to consideration of their bids at par with other bidders. No benefits shall be applicable for this enquiry if the above required documents are not uploaded at the time of bid submission. Documents submitted by the bidder shall be verified by BHEL for rendering the applicable benefits.</p>	
<p>18</p>	<p>LIQUIDATED DAMAGE: Liquidated Damages, wherever referred under this Tender/Agreement, shall mean and refer to the damages, not in the nature of penalty, which the contractor agrees to pay in the event of delay in delivery of supplies, breach of contract etc. as the case may be.</p> <p>Liquidated Damages leviable upon the Supplier/Vendor is a sum which is agreed by the parties as a reasonable and genuine pre-estimate of damages which will be suffered by BHEL on account of delay/breach on the part of the Supplier/Vendor.</p> <p>If the Seller/Service Provider fails to deliver any or all of the Goods/Services within the original/re-fixed delivery period(s) specified in the contract/PO, the Buyer/BHEL will be entitled to deduct/recover the Liquidated Damages for the delay, unless covered under Force Majeure conditions aforesaid, @ 0.5% of the contract value of delayed quantity per week or part of the week of delayed period as pre-estimated damages not exceeding 10% of the contract value of delayed quantity without any controversy/dispute of any sort whatsoever.</p>	
<p>19</p>	<p>INTEGRITY PACT (IP): Not Applicable</p>	
<p>20</p>	<p>PREFERENCE TO MAKE IN INDIA:</p> <p>For this procurement, the local content to categorize a Supplier/Vendor as a Class I local supplier/ Class II local Supplier/Non-Local Supplier and purchase preferences to Class I local supplier, is as defined in Public Procurement (Preference to Make in India), Order 2017 dated 19.07.2024 issued by DPIIT. In case of subsequent orders issued by the nodal ministry, changing the definition of local content for the items of the Bid, the same shall be applicable even if issued after issue of this Bid, but before opening of Part-II bids against this Bid.</p> <p>For contracts valuing more than Rs 10 Crores, local content (in cases of self-certification submitted by bidders at the time of tendering) will be re-verified during execution of contract by Cost/ Chartered Accountant, and in case of defaults, penalty upto 10% of the contract value shall be imposed.</p> <p>20.1 Compliance to Restrictions under Rule 144 (xi) of GFR 2017:</p> <p>I. Any bidder from a country which shares a land border with India will be eligible to bid in this tender only if the bidder is registered with the Competent Authority. The Competent Authority for the purpose of this Clause shall be the Registration Committee constituted by the Department for Promotion of Industry and Internal Trade (DPIIT).</p> <p>II. "Bidder" (including the term 'tenderer', 'consultant' or 'service provider' in certain contexts) means any person or firm or company, including any member of a consortium or joint venture (that is an association of several persons, or firms or companies), every artificial juridical person not falling in any of the descriptions of bidders stated hereinbefore, including any agency branch or office controlled by such person, participating in a procurement process.</p> <p>III. "Bidder from a country which shares a land border with India" for the purpose of this Clause means: -</p> <ol style="list-style-type: none"> a. An entity incorporated established or registered in such a country; or b. A subsidiary of an entity incorporated established or registered in such a country; or c. An entity substantially controlled through entities incorporated, established or registered in such a country; or d. An entity whose beneficial owner is situated in such a country; or e. An Indian (or other) agent of such an entity; or f. A natural person who is a citizen of such a country; or g. A consortium or joint venture where any member of the consortium or joint venture falls under any of the above. <p>IV. The beneficial owner for the purpose of (III) above will be as under:</p>	

1. In case of a company or Limited Liability Partnership, the beneficial owner is the natural person(s), who, whether acting alone or together or through one or more juridical person, has a controlling ownership interest or who exercises control through other means.

Explanation

- a. "Controlling ownership interest" means ownership of or entitlement to more than twenty-five per cent of shares or capital or profits of the company.
 - b. "Control" shall include the right to appoint majority of the directors or to control the management or policy decisions including by virtue of their shareholding or management rights or shareholders agreements or voting agreements.
2. In case of a partnership firm, the beneficial owner is the natural person(s) who, whether acting alone or together, or through one or more juridical person, has ownership of entitlement to more than fifteen percent of capital or profits of the partnership.
 3. In case of an unincorporated association or body of individuals, the beneficial owner is the natural person(s), who, whether acting alone or together, or through one or more juridical person has ownership of or entitlement to more than fifteen percent of the property or capital or profits of the such association or body of individuals.
 4. Where no natural person is identified under (1) or (2) or (3) above, the beneficial owner is the relevant natural person who holds the position of senior managing official;
 5. In case of a trust, the identification of beneficial owner(s) shall include identification of the author of the trust, the trustee, the beneficiaries with fifteen percent or more interest in the trust and any other natural person exercising ultimate effective control over the trust through a chain of control or ownership.
 - (i) The bidder shall provide undertaking for their compliance to this Clause, in the format provided in Annexure-13.
 - (ii) Registration of the bidder with Competent Authority should be valid at the time of submission of bids and at the time of acceptance of the bids

21 Settlement of Dispute:

If any dispute or difference of any kind whatsoever shall arise between BHEL and the Supplier/Vendor, arising out of the contract for the performance of the work whether during the progress of contract termination, abandonment or breach of the contract, it shall in the first place referred to Designated Engineer for amicable resolution by the parties. Designated Engineer (to be nominated by BHEL for settlement of disputes arising out of the contract) who within 60 days after being requested shall give written notice of his decision to the contractor. Save as hereinafter provided, such decision in respect of every matter so referred shall forthwith be given effect to by the Supplier/Vendor who shall proceed with the work with all due diligence, whether he or BHEL desires to resolve the dispute as hereinafter provided or not.

If after the Designated Engineer has given written notice of this decision to the party and no intention to pursue the dispute has been communicated to him by the affected party within 30 days from the receipt of such notice, the said decision shall become final and binding on the parties. In the event the Supplier/Vendor being dissatisfied with any such decision or if amicable settlement cannot be reached then all such disputed issues shall be resolved through conciliation in terms of the BHEL Conciliation Scheme 2018 as per Clause 21.1

21.1 Conciliation:

Any dispute, difference or controversy of whatever nature howsoever arising under or out of or in relation to this Agreement (including its interpretation) between the Parties, and so notified in writing by either Party to the other Party (the "Dispute") shall, in the first instance, be attempted to be resolved amicably in accordance with the conciliation procedure as per BHEL Conciliation Scheme 2018. The proceedings of Conciliation shall broadly be governed by Part-III of the Arbitration and Conciliation Act 1996 or any statutory modification thereof and as provided in - "Procedure for conduct of conciliation proceedings" (as available in www.bhel.com)).

Note: Ministry of Finance has issued OM reference No. 1/2/24 dated 03.06.2024 regarding "Guidelines for Arbitration and Mediation in Contracts of Domestic Public Procurement. In the said OM it has been recommended that Government departments/ Entities/agencies are to encourage mediation under the Mediation Act. 2023. The said Act has not yet been notified by the Government. Therefore, the clause "Settlement of Disputes" shall be modified accordingly as and when the Mediation Act 2023 gets notified.

21.2 ARBITRATION:

21.2.1 Except as provided elsewhere in this Contract, in case Parties are unable to reach amicable settlement (whether by Conciliation to be conducted as provided in Clause 21.1 herein above or otherwise) in respect of any dispute or difference; arising out of the formation, breach, termination, validity or execution of the Contract; or, the respective rights and liabilities of the Parties; or, in relation to interpretation of any provision of the Contract; or, in any manner touching upon the Contract (hereinafter referred to as the 'Dispute'), then, either Party may, refer the disputes to **Delhi International Arbitration Centre (DIAC)** and such dispute to be adjudicated by Sole Arbitrator appointed in accordance with the Rules of said Arbitral Institution.

21.2.2 A party willing to commence arbitration proceeding shall invoke Arbitration Clause by giving notice to the other party in terms of section 21 of the Arbitration & Conciliation Act, 1996 (hereinafter referred to as the 'Notice') before referring the matter to arbitral institution. The Notice shall be addressed to the Head of the Unit, BHEL, executing the Contract and shall contain the particulars of all claims to be referred to arbitration with sufficient detail and shall also indicate the monetary amount of such claim including interest, if any.

21.2.3 After expiry of 30 days from the date of receipt of aforesaid notice, the party invoking the Arbitration shall submit that dispute to the Arbitral Institution- **Delhi International Arbitration Centre (DIAC)**- and that dispute shall be adjudicated in accordance with their respective Arbitration Rules. The matter shall be adjudicated by a Sole Arbitrator who shall necessarily be a Retd Judge having considerable experience in commercial matters to be appointed/nominated by the respective institution. The cost/expenses pertaining to the said Arbitration shall also be governed in accordance with the Rules of the respective Arbitral Institution. The decision of the party invoking the Arbitration for reference of dispute to **Delhi International Arbitration Centre (DIAC)**-for adjudication of that dispute shall be final and binding on both the parties and shall not be subject to any change thereafter. The institution once selected at the time of invocation of dispute shall remain unchanged.

21.2.4 The fee and expenses shall be borne by the parties as per the Arbitral Institutional rules.

21.2.5 The Arbitration proceedings shall be in English language and the seat of Arbitration shall be **Haridwar**.

21.2.6 Subject to the above, the provisions of Arbitration & Conciliation Act 1996 and any amendment thereof shall be applicable. All matters relating to this Contract and arising out of invocation of Arbitration clause are subject to the exclusive jurisdiction of the Court(s) situated at **Haridwar**.

21.2.7 Notwithstanding any reference to the Designated Engineer or Conciliation or Arbitration herein, a. the parties shall continue to perform their respective obligations under the Contract unless they otherwise agree. Settlement of Dispute clause cannot be invoked by the Contractor, if the Contract has been mutually closed or 'No Demand Certificate' has been furnished by the Contractor or any Settlement Agreement has been signed between the Employer and the Contractor.

21.2.8 It is agreed that Mechanism of resolution of disputes through arbitration shall be available only in the cases where the value of the dispute is less than Rs. 10 Crores.

21.2.9 In case the disputed amount Claim, Counter claim including interest is Rs. 10 crores and above, the parties shall be within their rights to take recourse to remedies other than Arbitration, as may be available to them under the applicable laws after prior intimation to the other party. Subject to the aforesaid conditions, provisions of the Arbitration and Conciliation Act, 1996 and any statutory modifications or re-enactment thereof as amended from time to time, shall apply to the arbitration proceedings under this clause.

21.2.10 In case, multiple arbitrations are invoked (whether sub-judice or arbitral award passed) by any party to under this contract, then the cumulative value of claims (including interest claimed or awarded) in all such arbitrations shall be taken in account while arriving at the total claim in dispute for the subject contract for the purpose of clause 14.2.9. Disputes having cumulative value of less than 10 crores shall be resolved through arbitration and any additional dispute shall be adjudicated by the court of competent jurisdiction.

21.3 In case of Contract with Public Sector Enterprise (PSE) or a Government Department, the following shall be applicable:

In the event of any dispute or difference relating to the interpretation and application of the provisions of commercial contract(s) between Central Public Sector Enterprises (CPSEs)/ Port Trusts inter se and also between CPSEs and Government Departments/Organizations (excluding disputes concerning Railways,

	Income Tax, Customs & Excise Departments), such dispute or difference shall be taken up by either party for resolution through AMRCD (Administrative Mechanism for Resolution)	
22	<p>JURISDICTION Subject to clause 21 of this contract, the Civil Court having original Civil Jurisdiction at Haridwar, Uttarakhand shall alone have exclusive jurisdiction in regard to all matters in respect of the Contract.</p> <p>GOVERNING LAWS `1 The contract shall be governed by the Law for the time being in force in the Republic of India.</p>	
23	<p>FORCE MAJEURE</p> <p>23.1 "Force Majeure" shall mean circumstance which is: a) beyond control of either of the parties to contract, b) either of the parties could not reasonably have provided against the event before entering into the contract, c) having arisen, either of the parties could not reasonably have avoided or overcome, and d) not substantially attributable to either of the parties and Prevents the performance of the contract, such circumstances include but shall not be limited to:</p> <ol style="list-style-type: none"> i. War, hostilities, invasion, act of foreign enemies. ii. Rebellion, terrorism, revolution, insurrection, military or usurped power, or civil war. iii. Riot, commotion or disorder by persons other than the contractor's personnel and other employees of the contractor and sub-contractors. iv. Strike or lockout not solely involving the contractor's personnel and other employees of the contractor and sub-contractors. v. Encountering munitions of war, explosive materials, ionizing radiation or contamination by radio-activity, except as may be attributable to the contractor's use of such munitions, explosives, radiation or radio- activity. vi. Natural catastrophes such as earthquake, tsunami, volcanic activity, hurricane or typhoon, flood, fire, cyclones etc. vii. Epidemic, pandemic etc. <p>23.2 The following events are explicitly excluded from Force Majeure and are solely the responsibilities of the non-performing party: a) any strike, work-to-rule action, go-slow or similar labour difficulty (b) late delivery of equipment or material (unless caused by Force Majeure event) and (c) economic hardship.</p> <p>23.3 If either party is prevented, hindered or delayed from or in performing any of its obligations under the Contract by an event of Force Majeure, then it shall notify the other in writing of the occurrence of such event and the circumstances thereof within 15 (fifteen) days after the occurrence of such event.</p> <p>23.4 The party who has given such notice shall be excused from the performance or punctual performance of its obligations under the Contract for so long as the relevant event of Force Majeure continues and to the extent that such party's performance is prevented, hindered or delayed. The Time for Completion shall be extended by a period of time equal to period of delay caused due to such Force Majeure event.</p> <p>23.5 Delay or non-performance by either party hereto caused by the occurrence of any event of Force Majeure shall not</p> <ol style="list-style-type: none"> i) Constitute a default or breach of the Contract. ii) Give rise to any claim for damages or additional cost expense occasioned thereby, if and to the extent that such delay or non-performance is caused by the occurrence of an event of Force Majeure. <p>23.6 BHEL at its discretion may consider short closure of contract after 1 year of imposition of Force Majeure in line with extant guidelines. In any case, Supplier/Vendor cannot consider deemed short-closure after 1 year of imposition of Force Majeure.</p>	
24	<p>Non-Disclosure Agreement: The bidders shall enter into the Non-disclosure agreement separately.</p>	
25	<p>Cartel Formation The Bidder declares that they will not enter into any illegal or undisclosed agreement or understanding, whether formal or informal with other Bidder(s). This applies in particular to prices, specifications, certifications, subsidiary contracts, submission or non-submission of bids or any other actions to restrict competitiveness or to introduce cartelization in the bidding process. In case, the Bidder is found having indulged in above activities, suitable action shall be taken by BHEL as per extant policies/ guidelines.</p>	

26	Fraud Prevention Policy Bidder along with its associate /collaborators /sub-contractors /sub-vendors / consultants / service providers shall strictly adhere to BHEL Fraud Prevention Policy displayed on BHEL website http://www.bhel.com and shall immediately bring to the notice of BHEL Management about any fraud or suspected fraud as soon as it comes to their notice.									
27	Suspension of Business Dealings with Suppliers / Contractors: The offers of the bidders who are under suspension as also the offers of the bidders, who engage the services of the banned firms / principal / agents, shall be rejected. The list of banned firms is available on BHEL website www.bhel.com . If any bidder / supplier / contractor during pre-tendering / tendering / post tendering / award /execution / post-execution stage indulges in any act, including but not limited to, mal-practices, cheating, bribery, fraud or and other misconduct or formation of cartel so as to influence the bidding process or influence the price or tampers the tendering process or acts or omits in any manner which tantamount to an offence punishable under any provision of the Indian Penal Code, 1860(Bhartiya Nyaya Samhita 2023) or any other law in force in India, or does anything which is actionable under the Guidelines for Suspension of Business dealings, action may be taken against such bidder / supplier / contractor as per extant guidelines of the company available on www.bhel.com and / or under applicable legal provisions. Guidelines for suspension of business dealings is available in the webpage: http://www.bhel.com/vender_registration/vender.php .									
28	Bid should be free from correction, overwriting, using corrective fluid, etc. Any interlineation, cutting, erasure or overwriting shall be valid only if they are attested under full signature(s) of person(s) signing the bid else bid shall be liable for rejection. In the event of any Technical or Commercial queries, the same may please be addressed to the following BHEL concerned before Part I opening- <table border="1" data-bbox="161 875 1339 1010"> <tr> <td data-bbox="161 875 751 913">Amit Kumar/Manager (AIX-T)</td> <td data-bbox="751 875 1339 913">Sudip Kumar Srivastava/Sr. Manager (AIX-T)</td> </tr> <tr> <td data-bbox="161 913 751 952">Email ID: amit.garg@bhel.in</td> <td data-bbox="751 913 1339 952">Email ID: sudip@bhel.in</td> </tr> <tr> <td data-bbox="161 952 751 990">Landline: 01334-285623</td> <td data-bbox="751 952 1339 990">Landline: 01334-285497</td> </tr> <tr> <td data-bbox="161 990 751 1010">Mobile: 9815344974</td> <td data-bbox="751 990 1339 1010">Mobile: 9760560821</td> </tr> </table>	Amit Kumar/Manager (AIX-T)	Sudip Kumar Srivastava/Sr. Manager (AIX-T)	Email ID: amit.garg@bhel.in	Email ID: sudip@bhel.in	Landline: 01334-285623	Landline: 01334-285497	Mobile: 9815344974	Mobile: 9760560821	
Amit Kumar/Manager (AIX-T)	Sudip Kumar Srivastava/Sr. Manager (AIX-T)									
Email ID: amit.garg@bhel.in	Email ID: sudip@bhel.in									
Landline: 01334-285623	Landline: 01334-285497									
Mobile: 9815344974	Mobile: 9760560821									
29	Order of Precedence: In the event of any ambiguity or conflict between the Tender Documents, the order of precedence shall be in the order below: a. Amendments/Clarifications/Corrigenda/Errata etc. issued in respect of the tender documents by BHEL. b. Buyer Added Bid Specific ATC c. Special conditions of the contract d. Technical Conditions of Contract (TCC) e. GISTC									
30	Quality Requirements: <ol style="list-style-type: none"> 1. Ordering shall be done on BHEL accepted sub-contractors only 2. Inspection by BHEL/BHEL nominated inspection agency as per drawing /Standard and quality plan requirements 3. Sub-contractor to provide a summary sheet of documents/TCs provided for correlation. 4. Sub-contractor to mention relevant QP clauses on all TCs/ reports for every lot. 5. Quality plan no. QP/QA/20240839 dated 09.01.2025 is attached, which is to be followed. 									
31	Scrap: Scrap generated during the machining operation is to be retained by the vendor free of cost (Treated as Deemed Sales) and vendor must adjust/pass on the benefit to BHEL while quoting the rates. Scrap generated during the machining operation is non-chargeable, only GST and applicable taxes on scrap value will be recovered from vendor's end. The scrap rate will be calculated based on the monthly market scrap price Published in MSTC Bulletin/any other document under category of scrap. The difference between raw material weight and finalized weight shall be considered for the calculation of scrap generation.									
32	Validity: Validity of the offer should be minimum 120 days from tender opening date.									
33	Order Acknowledgement (If order awarded): In case order acknowledgement is not received within 7 days, purchase order will be deemed to be accepted by vendor.									
34	Submission of Bank Guarantee for free issue material and Indemnity bond: Bank Guarantee (BG) of value ₹15.64 lacs and Indemnity Bond (IB) of value ₹2.98 Crore in BHEL prescribed format should be submitted. Without submission of Bank Guarantee and Indemnity Bond, materials shall not be handed over to vendor. (The value of Bank Guarantee and Indemnity Bond is for complete quantities of all items of the enquiry. The vendor has to submit the Bank Guarantee and Indemnity Bond for the value of									

	item quantities issued/ordered on him, which will be communicated to vendor separately after placement of order). BHEL reserves the right to ask for the Bank Guarantee and Indemnity Bond for increased amount depending upon the material availability with the SUB-CONTRACTOR from time to time.	
35	<p>Conflict of interest: A bidder shall not have conflict of interest with other bidders. Such conflict of interest can lead to anti-competitive practices to the detriment of Procuring Entity's interests. The bidder found to have a conflict of interest shall be disqualified. A bidder may be considered to have a conflict of interest with one or more parties in this bidding process, if:</p> <ul style="list-style-type: none"> a) they have controlling partner (s) in common; or b) they receive or have received any direct or indirect subsidy/ financial stake from any of them; or c) they have the same legal representative/agent for purposes of this bid; or d) they have relationship with each other, directly or through common third parties, <u>that puts them in a position to have access to information about or influence on the bid of another Bidder; or</u> e) Bidder participates in more than one bid in this bidding process. Participation by a Bidder in more than one Bid will result in the disqualification of all bids in which the parties are involved. <u>However, this does not limit the inclusion of the components/ subassembly/ Assemblies from. one bidding manufacturer in more than one bid; or</u> f) In cases of agents quoting in offshore procurements, on behalf of their principal manufacturers, one agent cannot represent two manufacturers or quote on their behalf in a particular tender enquiry. One manufacturer can also authorise only one agent/dealer. There can be only one bid from the following: 1. The principal manufacturer directly or through one Indian agent on his behalf; and 2. Indian/foreign agent on behalf of only one principal; or g) A Bidder or any of its affiliates participated as a consultant in the preparation of the design or technical specifications of the contract that is the subject of the Bid; or h) In case of a holding company having more than one independently manufacturing units, or more than one unit having common business ownership/management, only one unit should quote. Similar restrictions would apply to closely related sister companies. Bidders must proactively declare such sister/ common business/ management units in same/similar line of business. " 	
36	<p>Compliances of GISTC: Bidder/Vendor has to ensure the submission of their offer for Tender Enquiry only after the compliances of BHEL Haridwar's Buyer Added Bid Specific Additional Terms & Conditions, Special terms and conditions, Technical specifications and requirements, Latest Version of GENERAL INSTRUCTIONS AND STANDARD TERMS & CONDITIONS (GISTC). Please visit our site https://hwr.bhel.com/bhelweb/CodeFiles/gistc.jsp for Latest Version of General Instructions and Standard Terms & Conditions (GISTC) for Tender Enquiries</p>	
37	<p>Reverse Auction: BHEL shall be resorting to Reverse Auction (RA) (Guidelines as available on https://www.bhel.com/guidelines-reverse-auction-2024 for this tender. RA shall be conducted among the techno-commercially qualified bidders. Price bids of all techno-commercially qualified bidders shall be opened. same shall be considered for RA. In case any bidder(s) do(es) not participate in online Reverse Auction, their sealed envelope price bid along with applicable loading, if any, shall be considered for ranking.</p>	
38	<p>Details of Contact Person Name, Designation, Department complete postal, E-mail address & Fax no, phone, Mobile no. to be mentioned.</p>	
39	<p>Method of evaluation: Item-wise basis</p>	
40	<p>Note:</p> <ol style="list-style-type: none"> 1. In the event of our customer order covering this tender being cancelled /placed on hold /otherwise modified, BHEL would be constrained to accordingly cancel / hold / modify the tender at any stage of execution. 2. BHEL may negotiate the L1 rate, if not meeting our budget / estimated cost. BHEL may re-float the tender opened, if L1 price is not acceptable to BHEL even after negotiation. Any deviation from the conditions specified in TECHNO-COMMERCIAL TERMS AND CONDITIONS - Annexure-A, will lead to rejection of offer. 3. Any change in applicable rates of Tax or any other statutory levies (Direct / Indirect) or any new introduction of any levy by means of statute and its corresponding liability for the deliveries beyond the agreed delivery date for reasons not attributable to BHEL will be to vendors account. BHEL will not reimburse the same and any subsequent claim in this respect will be summarily rejected. 4. BHEL reserves its right to reject an offer due to unsatisfactory past performance by the respective Vendor in the execution of any contract to any BHEL project / Unit. 5. The offers of the bidders who are under suspension and also the offers of the bidders, who engage the services of the banned firms /principal/agents, shall be rejected. The list of banned firms is available on BHEL web site www.bhel.com. 	

	6. Recovery / deduction as applicable as per Direct and Indirect taxes as notified by Govt. Of India from time to time will be made and information/certificate for such deduction/recoveries shall be provided by BHEL to the vendor.	
41	<p>Enclosure: Annexure-1: Check List. Annexure-2: Offer forwarding letter / tender submission letter Annexure-3: No Deviation Certificate Annexure-4: Declaration regarding Insolvency/ Liquidation/ Bankruptcy Proceedings Annexure-5: Declaration by Authorized Signatory Annexure-6: Declaration by Authorized Signatory regarding Authenticity of submitted Documents Annexure-8: Integrity Pact Annexure-10: Declaration reg. Related Firms & their areas of Activities Annexure-11: Declaration for relation in BHEL Annexure- 12: Declaration reg. minimum local content in line with revised public procurement Annexure- 13: Declaration regarding compliance to Restrictions under Rule 144 (xi) of GFR 2017 Annexure-14: Bank Account Details for E-Payment Annexure-15: Power of Attorney for submission of tender. Annexure-16: Proforma of Bank Guarantee for Earnest Money. Annexure-17: Proforma of Bank Guarantee for Performance Security. Annexure-18: List of Consortium Bank.</p>	
Signature and seal		

Pre-Qualifying Requirement (PQR)

HP INNER CASING (Drg. no. - 010502305000) Rough Vertical Boring & Horizontal Boring Machining		Indent No. 20240607
SL. No.	REQUIREMENT	REMARKS
1	<p>Only those vendors should quote who have following machine, facilities installed & operational at their works for following operations for machining, fitting works of "HP Inner Casing" as per Drg. No. 010502305000 and applicable Groove Plan machining Drg No. 91010730552.</p> <p>Raw material casting (Drg. No. 01050256901) shall be supplied to vendor for rough machining work after control marking. Vendor to carry out machining as per Technical Delivery Condition (TDC) and Drg. provided . Vendor to provide point wise acceptance of TDC terms with their offer.</p>	<p>Vendor to confirm & provide point wise acceptance of TDC each terms.</p>
2	<p>Vendor must have suitable toolings / facility such as Marking Table / Machine Bed etc. in good working condition, to facilitate marking / transfer marking of job (as required). Vendor must have suitable facility for lifting / handling the subject job.</p>	<p>Vendor to confirm.</p>
3	<p>Turning / Vertical Boring Operation :-</p>	
3.1	<p>CNC Vertical Boring Machine, suitable for Vertical Boring of HP Inner Casing as per drawing & T.R.'s requirement. Machine Requirement : (a) Table diameter of machine = 2500 mm or more. (b) Maximum Turning Height of job = 3500 mm or more. (c) Ram Stroke =2800 mm or more (d) Weight capacity of machine = 45 Tons or more.</p>	<p>(a) Vendor to confirm. (b) Vendor to provide machine details / specification for referred operation.</p>
4	<p>Horizontal Boring work :-</p>	
4.1	<p>Vendor must have suitable CNC Horizontal Boring machine with suitable attachments for machining of Joint Plans, holes, Threaded holes, Slots as per Drg. and TDC.</p>	<p>(a) Vendor to confirm. (b) Vendor to provide machine accuracies & Gemotrical details / specification for referred operation.</p>
5	<p>Fitting work :-</p>	
5.1	<p>Vendor must have suitable facility / arrangement for different fitting / assembly works to be done as per drawing & TR.</p>	<p>Vendor to confirm.</p>
6	<p>Vendor to confirm that above machines (as per pt. no. 3 & 4) are available at their works & are in good working condition with capability of achieving accuracies, surface finish & tolerances as per drawing requirements. If necessary, Vendor can suggest alternate machines (other than specified in pt. no. 3 & 4) for machining job with accuracies, surface finish & tolerances as per drawing, for review & acceptance by BHEL.</p>	<p>Vendor to confirm & submit the machine accuracies & Geometry details along with specification.</p>
7	<p>Vendor to confirm that all the dimensions, accuracies & surface finish of the component shall be met as per Technical Requirements & drawing.</p>	<p>Vendor to confirm.</p>
8	<p>Vendor to note that all tools, measuring equipments, technological items etc. required for manufacturing of subject item shall be arranged by vendor, in case of order.</p>	<p>Vendor to confirm.</p>
9	<p>BHEL reserves the right to verify the information provided by vendor. BHEL may also visit vendor works if so desired by BHEL. In case, the information provided by vendor is found to be false/ incorrect, their offer shall be rejected.</p>	<p>Vendor to note & Confirm.</p>

 (I K Ranjan) 13/01/24
 Mgr. (TTX)

 (R P Singh)
 Sr. Mgr. (NCT)

 HARIDWAR	Technical Delivery Condition for Sub-contracting for Rough Machining of HP Inner Casing for 800 MW ST Drg.no. 01050230500; 91010730552	Indent no. 20240607 Page 1 of 4
--	---	---

Scope of Work





H.P. Inner Casing of 800MW Steam Turbine in rough machined condition with Blade grooves, is proposed to be procured as per machining details & technical requirements furnished in drg.no. 01050230500 & 91010730552.

Casing raw material is Alloy steel casting in two halves (Tensile Strength: 630-750 Mpa).

A) HP Inner Casing casting halves will be sent to vendor from BHEL Haridwar after control marking.

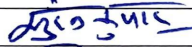
B) Scope of work for machining by vendor includes the following: -

- Joint Plane of casing halves will be machined with 0.5mm finishing allowance, with original drawing accuracies.
- Machining of joint plane holes, back counters & threaded holes as per Section FA-FA, FB-FB, PC-PC, PD-PD, BA-BA, BB-BB, PF-PF, G-G & H-H (Sheet-2- H.P.I.C. Drg.) in both halves to be done, considering allowance on joint plane. Machining of four lifting holes as per section- UU, U1U1, view V & Y & view of upper part (sheet-3), Section WW & view WA of drg. Machining of holes for clamping (dia. 50) as per view of upper part (sheet-3) of drg.
- Refer Detail BC (Sheet-3, HPIC drg.), Groove dia. 146.72 H10+0.160 with width 3.2+0.1 is **not** to be machined by vendor.
- Final machining of Guide Column holes (Section GG), Press Out holes (Section HH). For Pin holes (Section PF-PF), initially hole dia. 20 to be machined by vendor, in place of Pin dia. 30. Guide Column hole (Section GG) not to be made in casing Lower Half.
- Final Machining of Taper pin holes to be done in assembled condition, as per Sec PF-PF. Two halves of the casings are to be assembled together with joint plane fasteners and taper pins (item no. 505, 506, 507, 508, 509, 510, 511 & 515 of CBOM 01050230600). These joint plane fasteners and taper pins shall be provided by BHEL. Vertical boring operation to be carried out in assembled condition.
- Groove machining for stellite deposite, as per "1. ROUGH GROOVE" (sheet -3 - H.P.I.C. Drg.) to be done.

TTX	Surinder Kumar, Sr. Mgr.		
NCT	R.P. Singh, Sr. Mgr.		
TUM	Arbind Kumar Choubey, Sr. Mgr.		
TUM-PLG	Sudip Kr Srivastav, Sr. Mgr.		
DEPTT.	NAME	SIGNATURE	DATE



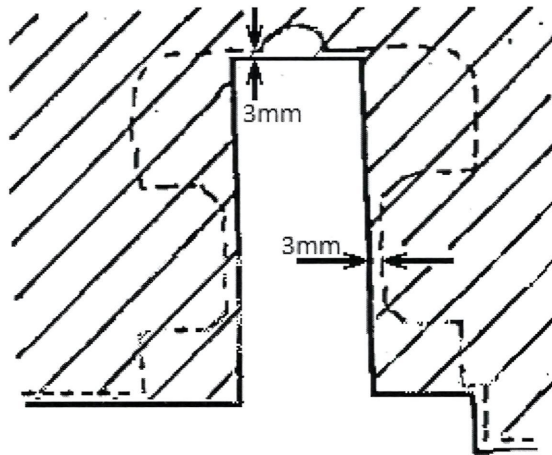

- Refer Detail-Z, Q1 & Q2 in H.P. Inner drawing. Shaft seal area T grooves are to be machined with 3mm finishing allowance (at tool point) on all axial dimensions & radial dimensions. In these grooves the T portion shall be machined at BHEL. Only Neck width is to be rough machined. Refer “T-Groove Rough Machining” detail.
- Refer Detail-Z in H.P. Inner drawing. Groove on Dia. 853 with width 21-0.5mm is not to be machined by vendor.
- Refer Groove Plan Casing drg. 91010730552. All details / dimensions are to be machined with 3mm finishing allowance (at tool point) on all axial dimensions & radial dimensions, with original drawing accuracies. In Blade grooves the T portion shall be machined at BHEL. Only Neck width is to be rough machined. Refer “T-Groove Rough Machining” detail.
- Refer Groove Plan casing drawing, zone E-8. Step dia. 810+0.3 with width 23; groove with width 8H7 at dia. 835+0.3 & face at distance 2765 are not to be machined by vendor. Only dia. 743 is to be rough machined.



T- GROOVE ROUGH MACHINING

C) Important points: Vendor to note following important points:





- In Groove Plan drawing, all the axial dimensions in specified tolerances are to be maintained from reference plane.
- All other requirements of QP, Standards and technical requirements specified on the drawings for specified scope of work to followed.

TTX	Surinder Kumar, Sr. Mgr.		
NCT	R.P. Singh, Sr. Mgr.		
TUM	Arbind Kumar Choubey, Sr. Mgr.		
TUM-PLG	Sudip Kr Srivastav, Sr. Mgr.		
DEPTT.	NAME	SIGNATURE	DATE

 HARIDWAR	Technical Delivery Condition for Sub-contracting for Rough Machining of HP Inner Casing for 800 MW ST <u>Drg.no. 01050230500; 91010730552</u>	Indent no. Page 3 of 4
--	---	---------------------------

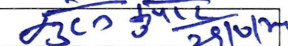
- No flaws like blow holes, shrinkage, inclusions etc. should open up during machining. However, if any flaw opens up during machining, vendor shall immediately intimate detail and location of flaw and corrective action proposed. Further machining will be suspended till BHEL approves corrective action.
- BHEL shall furnish clarifications, if any, w.r.to scope of work or drg. dimensions / technical requirements to the vendor to enable it to submit technical / commercial offer.
- Party must ensure that all requirements indicated in the drg. regarding:
 - Surface finishes (Ra value indicated in microns).
 - Sizes and tolerances.
 - Geometrical accuracies e.g. run-outs, concentricity, parallelity, perpendicularity etc. shall be fully met.
 Reference surfaces are clearly marked in the concerned drawings.

- D) After machining, inspection report is to be submitted to BHEL for final clearance.
- E) Inspection of the job at supplier's works shall be carried out as per BHEL approved quality plan by BHEL/ agency authorized by BHEL for which adequate prior notice (min. 4weeks) shall be given by the supplier.
- F) All the machined surfaces must be protected against rust / corrosion by steam washable rust preventive suitable for six months.
- G) Machined job shall be packed properly. Packing should be suitable to protect any damage to job (special care to be taken to protect finished machined surfaces) during handling and transportation.
- H) All cross-referred documents given in Annexure-I



TTX	Surinder Kumar, Sr. Mgr.		 29/10/17
NCT	R.P. Singh, Sr. Mgr.		
TUM	Arbind Kumar Choubey, Sr. Mgr.		
TUM-PLG	Sudip Kr Srivastav, Sr. Mgr.		
DEPTT.	NAME	SIGNATURE	DATE

 HARIDWAR	Technical Delivery Condition for Sub- contracting for Rough Machining of HP Inner Casing for 800 MW ST <u>Drg.no. 01050230500; 91010730552</u>	Indent no. Page 4 of 4
--	--	-------------------------------

ANNEXURE-I

List of drawings / standards to be referred

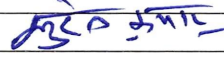
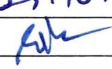
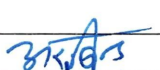
1. HP Inner Casing (Finish machined drawing).....01050230500
2. Groove Plan Casing91010730552
3. Blade groove.....31010730513
4. Blade groove.....31010730014
5. Blade groove.....31010730013
6. Blade groove.....31010705512
7. Blade groove.....31010730012
8. Log Sheet.....01050230500LS
9. Log Sheet.....91010730552LS
10. Machining of Alignment points in ST casing.....HW0690199
11. Product standards
 - a. Dimensions of threaded Holes.....ST01013

TTX	Surinder Kumar, Sr. Mgr.		28.10.24
NCT	R.P. Singh, Sr. Mgr.		
TUM	Arbind Kumar Choubey, Sr. Mgr.		
TUM-PLG	Sudip Kr Srivastav, Sr. Mgr.		
DEPTT.	NAME	SIGNATURE	DATE

ANNEXURE- 1**CHECK LIST**

NOTE: - Suppliers are required to fill in the following details in their Letterhead and no column should be left blank

A	Name and Address of the Supplier		
B	GSTN No. of the Supplier (Place of Execution of Contract / Purchase Order)		
C	Details of Contact person for this Tender	Name: Mr./ Ms. Designation: Telephone No: Mobile No: Email ID:	
D	EMD DETAILS	Not Applicable	
E	DESCRIPTION	APPLICABILITY (BY BHEL)	ENCLOSED BY BIDDER
i.	Whether Pre - Qualification Criteria is understood and provided proper supporting documents.	Applicable/ Not Applicable	YES / NO
ii.	Whether all pages of the Tender documents including annexures, appendices etc are read and understood	Applicable/ Not Applicable	YES / NO
iv.	Copy of PAN Card & GST registration	Applicable/ Not Applicable	YES / NO
v.	Submission of MSE certificate as specified in Tender	Applicable/ Not Applicable	YES / NO
vi.	Offer forwarding letter / tender submission letter as per Annexure – 2	Applicable/ Not Applicable	YES / NO
vii.	Submission of Certificate of No Deviation as per Annexure – 3	Applicable/ Not Applicable	YES / NO
viii.	Declaration regarding Insolvency/ Liquidation/ Bankruptcy Proceedings as per Annexure – 4	Applicable/ Not Applicable	YES / NO
ix.	Declaration by Authorized Signatory as per Annexure – 5	Applicable/ Not Applicable	YES / NO
x.	Declaration by Authorized Signatory regarding Authenticity of submitted Documents Annexure – 6	Applicable/ Not Applicable	YES / NO
xiv.	Declaration reg. Related Firms & their areas of Activities as per Annexure – 10	Applicable/ Not Applicable	YES / NO
xv.	Declaration for relation in BHEL as per Annexure – 11	Applicable/ Not Applicable	YES / NO

xvi.	Declaration reg. minimum local content in line with revised public procurement as per Annexure – 12	Applicable/ Not Applicable	YES / NO
xvii.	Declaration regarding compliance to Restrictions under Rule 144 (xi) of GFR 2017 as per Annexure – 13	Applicable/ Not Applicable	YES / NO
xix.	Power of Attorney for submission of tender as per Annexure – 15	Applicable/ Not Applicable	YES / NO

NOTE: Strike off 'YES' or 'NO', as applicable. Tender not accompanied by the prescribed above applicable documents are liable to be summarily rejected.

DATE:

Sign. of the AUTHORISED SIGNATORY
(With Name, Designation and Company seal)

OFFER FORWARDING LETTER / TENDER SUBMISSION LETTER

(To be typed and submitted in the Letter Head of the Company/Firm of Bidder)

Offer Reference No:

Date:

To,
Manager / AIX-T
3rd Floor, Main Admin building HEEP Haridwar-249403
Uttarakhand. Phone: 01334-285623, Email: amit.garg@bhel.in

Dear Sir,

Sub: Submission of Offer against Tender Reference No: **X/6600/2024/0839/R/1**

Having examined the tender documents against your Tender Reference No.dt..... and having understood the provisions of the said tender documents and having thoroughly studied the requirements of BHEL related to the work tendered for, in connection with, we hereby submit our offer for the proposed work in accordance with terms and conditions mentioned in the tender documents, at the prices quoted by us and as per the indicated delivery schedule.

Should our Offer be accepted by BHEL for Award, I/we further agree to furnish 'Security Deposit' for the work as provided for in the Tender Conditions within the stipulated time as may be indicated by BHEL.

I/We further agree to execute all the works referred to in the said Tender documents upon the terms and conditions contained or referred to therein and as detailed in the appendices annexed thereto.

I/We have deposited herewith the requisite Earnest Money Deposit (EMD) as per details furnished in the Check List.

Authorized Representative of Bidder
Signature:
Name:
Address:

Place:
Date:

CERTIFICATE OF NO DEVIATION

(To be Typed & submitted in the Letter Head of the Company/Firm of Bidder)

To,

Manager / AIX-T
3rd Floor, Main Admin building HEEP Haridwar-249403
Uttarakhand. Phone: 01334-285623, Email: amit.garg@bhel.in

Dear Sir,

Subject: No Deviation Certificate

Ref:

- 1) Tender Reference No: **X/6600/2024/0839/R/1**
- 2) All other pertinent issues till date

We hereby confirm that we have not changed/ modified/materially altered any of the tender documents as downloaded from the website/ issued by BHEL and in case of such observance at any stage, it shall be treated as null and void.

We also hereby confirm that we have neither set any Terms and Conditions and nor have we taken any deviation from the Tender conditions together with other references applicable for the above referred Bid.

We further confirm our unqualified acceptance to all Terms and Conditions, unqualified compliance to Tender Conditions.

We confirm to have submitted offer in accordance with tender instructions and as per aforesaid references.

Thanking you,

Yours faithfully,

(Signature, date & seal of authorized representative of the bidder)

Date:

Place:

UNDERTAKING

(To be typed and submitted in the Letter Head of the Company/Firm of Bidder)

To,

Manager / AIX-T
3rd Floor, Main Admin building HEEP Haridwar-249403
Uttarakhand. Phone: 01334-285623, Email: amit.garg@bhel.in

Dear Sir/Madam,

Sub: DECLARATION REGARDING INSOLVENCY/ LIQUIDATION/ BANKRUPTCY
PROCEEDINGS

Ref: Tender Reference No: **X/6600/2024/0839/R/1**

I/We, declare that, I/We am/are not under insolvency resolution process or liquidation or Bankruptcy Code Proceedings (IBC) as on date, by NCLT or any adjudicating authority/authorities, which will render us ineligible for participation in this tender.

Sign. of the AUTHORISED SIGNATORY (With Name, Designation and Company seal)

Place:

Date:

DECLARATION BY AUTHORISED SIGNATORY OF BIDDER
(To be typed and submitted in the Letter Head of the Company/Firm of Bidder)

To,

Manager / AIX-T
3rd Floor, Main Admin building HEEP Haridwar-249403
Uttarakhand. Phone: 01334-285623, Email: amit.garg@bhel.in

Dear Sir,

Sub: Declaration by Authorized Signatory

Ref:

- 1) Tender Reference No: **X/6600/2024/0839/R/1**
- 2) All other pertinent issues till date

I/We, hereby certify that all the information and data furnished by me with regard to the above Tender Specification are true and complete to the best of my knowledge. I have gone through the specifications, conditions, stipulations and all other pertinent issues till date, and agree to comply with the requirements and Intent of the specification.

I further certify that I am authorized to represent on behalf of my Company/Firm for the above-mentioned tender and a valid Power of Attorney to this effect is also enclosed.

Yours faithfully,

(Signature, Date & Seal of Authorized
Signatory of the Bidder) Date:

Enclosed: Power of Attorney

DECLARATION BY AUTHORISED SIGNATORY OF BIDDER

(To be typed and submitted in the Letter Head of the Company/Firm of Bidder)

To,

Manager / AIX-T
3rd Floor, Main Admin building HEEP Haridwar-249403
Uttarakhand. Phone: 01334-285623, Email: amit.garg@bhel.in

Dear Sir,

Sub : Declaration by Authorized Signatory regarding Authenticity of submitted documents.

Ref :

- 1) **Tender Reference No: X/6600/2024/0839/R/1**
- 2) All other pertinent issues till date

I/We, hereby certify that all the documents submitted by us in support of possession of “Qualifying Requirements” are true copies of the original and are fully compliant required for qualifying / applying in the bid and shall produce the original of same as and when required by Bharat Heavy Electricals Limited.

I / We hereby further confirm that no tampering is done with documents submitted in support of our qualification as bidder. I / We understand that at any stage (during bidding process or while executing the awarded contract) if it is found that fake / false / forged bid qualifying / supporting documents / certificates were submitted, it would lead to summarily rejection of our bid / termination of contract. BHEL shall be at liberty to initiate other appropriate actions as per the terms of the Bid / Contract and other extant policies of Bharat Heavy Electricals Limited.

Yours faithfully,

(Signature, Date & Seal of Authorized
Signatory of the Bidder)

Date:

DECLARATION

Date:

To,

Manager / AIX-T
 3rd Floor, Main Admin building HEEP Haridwar-249403
 Uttarakhand. Phone: 01334-285623, Email: amit.garg@bhel.in

Dear Sir/ Madam,

Sub: Details of related firms and their area of activities

Please find below details of firms owned by our family members that are doing business/ registered for same item with BHEL, (NA, if not applicable)

1	Material Category/ Work Description	
	Name of Firm	
	Address of Firm	
	Nature of Business	
	Name of Family Member	
	Relationship	
2	Material Category/ Work Description	
	Name of Firm	
	Address of Firm	
	Nature of Business	
	Name of Family Member	
	Relationship	
3		

Note: I certify that the above information is true and I agree for penal action from BHEL in case any of the above information furnished is found to be false.

Regards, (_)
 From: M/s

Supplier Code:

Address:

DECLARATION FOR RELATION IN BHEL

(To be typed and submitted in the Letter Head of the Company/Firm of Bidder failing which the offer of Bidder is liable to be summarily rejected)

To,

Manager / AIX-T
3rd Floor, Main Admin building HEEP Haridwar-249403
Uttarakhand. Phone: 01334-285623, Email: amit.garg@bhel.in

Dear Sir,

Sub: Declaration for relation in BHEL

Ref:

1) **Tender Reference No: X/6600/2024/0839/R/1**

I/We hereby submit the following information pertaining to relation/relatives of Proprietor/Partner(s)/ Director(s) employed in BHEL

Tick (√) any one as applicable:

1. The Proprietor, Partner(s), Director(s) of our Company/Firm DO NOT have any relation or relatives employed in BHEL

OR

2. The Proprietor, Partner(s), or Director(s) of our Company/Firm HAVE relation/relatives employed in BHEL and their particulars are as below:

- i.
- ii.

(Signature, Date & Seal of Authorized
Signatory of the Bidder)

Note:

1. Attach separate sheet, if necessary.
2. If BHEL Management comes to know at a later date that the information furnished by the Bidder is false, BHEL reserves the right to take suitable against the Bidder/Contractor.

DECLARATION REGARDING MINIMUM LOCAL CONTENT IN LINE WITH REVISED PUBLIC PROCUREMENT (PREFERENCE TO MAKE IN INDIA), ORDER 2017 DATED 19TH JULY, 2024 AND SUBSEQUENT ORDER(S)

(To be typed and submitted in the Letter Head of the Entity/Firm providing certificate as applicable)

To,
Manager / AIX-T
3rd Floor, Main Admin building HEEP Haridwar-249403
Uttarakhand. Phone: 01334-285623, Email: amit.garg@bhel.in

Dear Sir,
Sub: Declaration reg. minimum local content in line with Public Procurement (Preference to Make in India), Order 2017-Revision, dated 04th June, 2020 and subsequent order(s).

Ref:
1) Tender Reference No: **X/6600/2024/0839/R/1**
2) All other pertinent issues till date

We hereby certify that the items/works/services offered by -----
(supplier name) has a local content of% and this meets the local content requirement for ‘Class-I local supplier’ / ‘Class II local supplier’ ** as defined in Public Procurement (Preference to Make in India), Order 2017-Revision dated 19.07.2024 issued by DPIIT and subsequent order(s).

The details of the location(s) at which the local value addition is made are as follows:

- | | |
|------|------|
| 1. _ | 2. _ |
| 3. _ | 4. _ |

Thanking you, Yours faithfully,

(Signature, Date & Seal of
Authorized Signatory of the Bidder)

** - Strike out whichever is not applicable.

Note:

1. Bidders to note that above format, duly filled & signed by authorized signatory, shall be submitted along with the techno-commercial offer.
2. In case the bidder's quoted value is in excess of Rs. 10 crores, the authorized signatory for this declaration shall necessarily be the statutory auditor or cost auditor of the company (in the case of companies) or a practicing cost accountant or practicing chartered accountant (in respect of suppliers other than companies).
3. In the event of false declaration, actions as per the above order and as per BHEL Guidelines shall be initiated against the bidder.

DECLARATION REGARDING COMPLIANCE TO RESTRICTIONS UNDER RULE 144 (xi)
OF GFR 2017

(To be typed and submitted in the Letter Head of the Entity/ Firm providing certificate as applicable)

To,

Manager / AIX-T
3rd Floor, Main Admin building HEEP Haridwar-249403
Uttarakhand. Phone: 01334-285623, Email: amit.garg@bhel.in

Dear Sir,

Sub: Declaration regarding compliance to Restrictions under Rule 144 (xi) of GFR 2017

Ref:

- 1) Tender Reference No: **X/6600/2024/0839/R/1**
- 2) All other pertinent issues till date

I have read the clause regarding restrictions on procurement from a bidder of a country which shares a land border with India. I certify that(SPECIFY THE NAME OF THE ORGANIZATION HERE), is not from such a country/ has been registered with the Competent Authority (attach valid registration by the Competent Authority, i.e., the Registration Committee constituted by the Dept. for Promotion of Industry and Internal Trade (DPIIT)).

I hereby certify that we fulfil all requirements in this regard and is eligible to be considered.

Thanking you,
Yours faithfully,

(Signature, Date & Seal of
Authorized Signatory of the Bidder)

Note: Bidders to note that in case above certification given by a bidder, whose bid is accepted, is found to be false, then this would be a ground for immediate termination and for taking further action in accordance with law and as per BHEL guidelines.

POWER OF ATTORNEY for SUBMISSION OF TENDER

(To be typed on non-judicial stamp paper of minimum Rs. 100/- and Notarized)

KNOW ALL MEN BY THESE PRESENTS, that I/We do hereby make, nominate, constitute and appoint Mr.

....., whose signature given below herewith to be true and lawful Attorney of M/s..... hereinafter called 'Company', for submitting Tender/entering into Contract and inter alia, sign, execute all papers and to do necessary lawful acts on behalf of Company with M/s Bharat Heavy Electricals Ltd, Works Contracts Management (WCM), in connection withvide.....

And the Company do hereby agree to ratify and confirm all acts, deeds, things or proceedings as may be lawfully done by the said attorney and by or on behalf of the company and in the name of the company, by virtue of the powers conferred herein and the same shall be binding on the company and shall have full force and effect.

IN WITNESS WHEREOF, the common seal of the company has been hereunto affixed in the manner hereinafter appearing on the document.

Dated at, this, day of.....

Director/CMD/Partner/Proprietor

Signature of Mr. (Attorney)

Attested by: Director/CMD/Partner/Proprietor

Witness

Notary Public



BHARAT HEAVY ELECTRICALS LIMITED

HEEP-HARIDWAR, UTTARAKHAND (249403)

General Instructions and Standard Terms & Conditions for bidding against Tender Enquiry (GISTC)

For Indian Bidders (Version May-2024, Rev: 07)

Table of Contents

1. GENERAL.....	1
2. ORIGIN OF QUOTATION	1
3. SUBMISSION OF TENDER.....	1
4. TENDER OPENING.....	2
5. SPECIFICATION, DRAWINGS & STANDARD	2
6. PRICE SCHEDULE.....	3
7. REVERSE AUCTION.....	3
8. DELIVERY TERMS	3
9. LD FOR LATE DELIVERY	4
10. PAYMENT TERMS.....	4
11. TAXES & DUTIES.....	5
12. BANK GUARANTEE.....	6
13. GUARANTEE / WARRANTY AND CORRESPONDING REPAIRS / REPLACEMENT OF GOODS	6
14. QUALITY REQUIREMENT.....	6
15. VALIDITY	6
16. RIGHT OF ACCEPTANCE	6
17. TRANSIT INSURANCE	7
18. RISK PURCHASE	7
19. FORCE MAJEURE CLAUSE.....	7
20. NON-DISCLOSURE AGREEMENT	8
21. SETTLEMENT OF DISPUTES / ARBITRATION.....	8
22. WHARFAGE / DEMURRAGE RESPONSIBILITY.....	8
23. CONDITIONS FOR AVAILING MICRO & SMALL ENTERPRISES (MSE'S) BENEFITS	8
24. INFORMATION TO THE BIDDERS	10
25. MAKE IN INDIA (GOVT-NOTIFICATION)	10
26. RESTRICTIONS UNDER RULE 144(XI) OF THE GENERAL FINANCIAL RULES (GFRs), 2017	12
27. NOTE.	12

1. GENERAL.

These general terms & conditions shall apply to all the Tender Enquiries, notice inviting tenders, request for quotations concerning the supply of goods and / or rendering of services to Bharat Heavy Electricals Ltd., HEEP, Haridwar (hereinafter referred to as BHEL or the Purchaser). In case of placement of order these conditions will become part of Purchase Order (P.O) until unless the deviations are specifically agreed by BHEL.

2. ORIGIN OF QUOTATION.

"A bidder shall not have conflict of interest with other bidders. Such conflict of interest can lead to anti-competitive practices to the detriment of Procuring Entity's interests. **The bidder found to have a conflict of interest shall be disqualified.** A bidder may be considered to have a conflict of interest with one or more parties in this bidding process, if:

- they have controlling partner (s) in common; **or**
- they receive or have received any direct or indirect subsidy/ financial stake from any of them; **or**
- they have the same legal representative/agent for purposes of this bid; **or**
- they have relationship with each other, directly or through common third parties, that puts them in a position to have access to information about or influence on the bid of another Bidder; or
- Bidder participates in more than one bid in this bidding process. Participation by a Bidder in more than one Bid will result in the disqualification of all bids in which the parties are involved. However, this does not limit the inclusion of the components/ sub-assembly/ Assemblies from one bidding manufacturer in more than one bid; or
- In cases of agents quoting in offshore procurements, on behalf of their principal manufacturers, one agent cannot represent two manufacturers or quote on their behalf in a particular tender enquiry. One manufacturer can also authorise only one agent/dealer. There can be only one bid from the following:
 - The principal manufacturer directly or through one Indian agent on his behalf; and
 - Indian/foreign agent on behalf of only one principal;**or**
- A Bidder or any of its affiliates participated as a consultant in the preparation of the design or technical specifications of the contract that is the subject of the Bid; **or**
- In case of a holding company having more than one independently manufacturing units, or more than one unit having common business ownership/management, only one unit should quote. Similar restrictions would apply to closely related sister companies. Bidders must proactively declare such sister/ common business/ management units in same/similar line of business. "

B. SUBMISSION OF TENDER.

- Bid / Quotation must be enclosed in sealed cover on which tender enquiry number and the due date MUST BE written and be invariably sent under REGISTERED POST / SPEED POST / COURIER / Dropped in the Tender Box: addressed as follows:

Quotation against Enquiry No. _____

Dated: _____

Due on: _____

To,

**THE HEAD OF MATERIALS MANAGEMENT,
Heavy Electrical Equipment Plant,
Bharat Heavy Electricals Limited,
HARIDWAR-249403 (Uttarakhand), INDIA.**

- TENDER ROOM is located at: Room No. - 415, 4th Floor, Main Admin. Building, BHEL-HEEP, Haridwar.



BHARAT HEAVY ELECTRICALS LIMITED

HEEP-HARIDWAR, UTTARAKHAND (249403)

General Instructions and Standard Terms & Conditions for bidding against Tender Enquiry (GISTC)

For Indian Bidders (Version May-2024, Rev: 07)

- c) In case of Three / Two Part Bid, technical bid containing technical offer, duly signed and un-priced copy of the Price Bid should be kept in one envelope. Price Bid containing only the price should be kept in a separate envelope. All envelopes indicating Part-1 or Part-2 or Part-3 as the case may be to be put in a bigger envelope. Please note that un-priced bid should be the exact replica of price bid but without prices.
- d) The bid / quotation must be posted before due date, keeping allowance for postal transit time. Quotations sent by any mode but not received in time will be ignored. Tender received through authorized E-mail is also acceptable. However, in time submission of tender in tender box shall be the responsibility of the bidder, sent through any mode. Documents submitted with the offer / bid shall be signed and stamped in each page by authorized representative of the bidder.
- e) Any additional documents submitted by supplier / bidder, during processing of registration application / tender or after placement of order shall not be accepted unless it is submitted with forwarding letter and duly signed and stamped.
- f) The bids of the bidders who are on the banned list and also the bids of the bidders, who engage the services of the banned firms, shall be rejected. The cutting / overwriting in the bid / offer must be duly attested by the signatories to the bid. The list of firms banned by BHEL is available on BHEL web site www.bhel.com.
- g) Being PMD vendor, if you are not quoting against this tender enquiry, please send your regret letter positively for our reference with valid reasons for not participating in the tender enquiry. Repeated lack of response on the part of bidder may lead to deletion such PMD vendor from BHEL's approved vendor list.
- h) The bidders will submit Integrity Pact, duly signed by its authorized signatory, along with their bids wherever estimated tender value is Rs. 2 Crore or more.
- i) In case of open tender, technically qualified unregistered bidders may apply online for registration through <http://www.bhel.com/index.php/vender>.
- j) BHEL reserves the right to award tendered quantities among more than one bidder (after acceptance of L1 price by the other bidders). BHEL can also consider awarding of part of the tendered quantity to other than L-1 bidder at L1 counter offered rates, if the quantity offered by the L-1 bidder is less than the quantity tendered for.
- k) In case of e-Tendering (Online bidding through e-portal), offline bid submitted in hard copy or in any other form by the vendor / supplier will not be accepted and will be rejected out rightly. Only e-portal bid will be accepted.

4. TENDER OPENING.

Tender opening is scheduled to start in the Tender Room at 2:00 PM, on the due date. Therefore, bid / quotations must reach this office / tender Box latest by 1:45 PM on due date. Only participating bidders are allowed to attend tender opening. **TENDERS RECEIVED AFTER THE SPECIFIED TIME OF THEIR 'SUBMISSION' WILL BE TREATED AS LATE TENDERS AND SHALL NOT BE CONSIDERED UNDER ANY CIRCUMSTANCES.** The bidders or their authorized representatives may be allowed to attend tender opening if duly authorized by their principals, through a tender specific letter on that particular day. General authorization letter is not acceptable.

Note: - Foreign bidders willing to attend the bid opening has to provide the requisite documents to the concerned Purchase executives for arranging gate pass for them.

5. SPECIFICATION, DRAWINGS & STANDARD.

- a) Bidders must give their detailed specification in the quotation along with relevant technical literature / catalogue etc. against the tender enquiry.
- b) The Bid should be accompanied with relevant copies of catalogues, drawings or specification as per tender enquiry.



BHARAT HEAVY ELECTRICALS LIMITED

HEEP-HARIDWAR, UTTARAKHAND (249403)

General Instructions and Standard Terms & Conditions for bidding against Tender Enquiry (GISTC)

For Indian Bidders (Version May-2024, Rev: 07)

If these documents are not furnished, the offer is liable to be rejected.

- c) Wherever national / international (N/IN) standards are referred, the latest N/IN standards are to be followed. Mention year & date of standard revision that shall be followed for the supply.
- d) All Drawings and Standards are proprietary of BHEL. It must not be used in anyway detrimental to the interest of BHEL or without permission of BHEL.

6. PRICE SCHEDULE.

- a) Kindly quote your prices in figures and words both. In case of any discrepancy in value, the prices quoted in words shall be considered for evaluation and establishing L1 status.
- b) Prices quoted should not be more than the prices quoted to any other BHEL units / offices / divisions. Vendor to submit copy of latest Purchase Order placed by any unit of BHEL for similar items in the technical bid. In case no order has been placed on such items, specific confirmation that no order has been placed on such items should be provided.
- c) Prices should be quoted on F.O.R. Destination basis. Transit insurance shall be arranged by BHEL and not to be included in the prices. The offers quoted on other than F.O.R destination basis may result in non-consideration of such bids.
- d) In case BHEL accepts the EX-Works prices, such offers will be loaded by 1.5% of EX-Works value towards freight or with actual freight charges as per BHEL freight rate contract whichever is higher.
- e) In case of Indigenous items covered by DGS & D Rate Contract, the bidders should submit latest valid copy of the rate contract along with bid / quotation
- f) Applicable **IGST / CGST / SGST** and any other statutory levy should be indicated separately and clearly in the bid / quotation.

- g) Bidders can dispatch goods through any Indian Bank Association approved transporters having their branch at HARIDWAR / destination. If material is dispatched through other than Indian Bank Association approved transporter, material to be delivered on door delivery BHEL Stores basis.
- h) In case of dispatch of material through any other unapproved transporter, payment shall be made only after receipt of material and any additional charges payable to the transporter shall be to the bidder's account.
- i) Any demurrage / godown rent payable to the transporter / or to godown's owner due to any delay attributed by the supplier shall be recovered from supplier's account.
- j) Currency of Evaluation shall be INR.

NB: Financial evaluation of L1, L2Status will be on the basis of Landed Cost to BHEL.

7. REVERSE AUCTION.

Wherever RA is declared in the special terms and conditions of tender enquiry, following shall be applicable and Bidders to confirm the same:

"BHEL shall be resorting to Reverse Auction (RA) (Guidelines as available on www.bhel.com) for this tender. RA shall be conducted among all the techno-commercially qualified bidders.

Price bids of all techno-commercially qualified bidders shall be opened and same shall be considered as initial bids of bidders in RA. In case any bidder(s) do(es) not participate in online Reverse Auction, their sealed envelope price bid along with applicable loading, if any, shall be considered for ranking."

8. DELIVERY TERMS.

- a) Goods shall be delivered on 'FOR Destination' basis to the named destination unless otherwise called for in the tender enquiry.
- b) Loading on account of 3rd party inspection charges in case of Indian bidders shall be 0.20%.



BHARAT HEAVY ELECTRICALS LIMITED

HEEP-HARIDWAR, UTTARAKHAND (249403)

General Instructions and Standard Terms & Conditions for bidding against Tender Enquiry (GISTC)

For Indian Bidders (Version May-2024, Rev: 07)

9. LIQUIDATED DAMAGES (LD) FOR LATE DELIVERY.

a) Where items of Purchase Order are independently usable.

Liquidated Damages (LD) for Late Deliveries shall be applicable @0.5% per week or part thereof on the value of respective delayed supplies subject to a maximum of 10% of the value of respective delayed supplies. Value of delayed supplies will mean the Gross Value payable to the vendor (Before LD) against such supplies excluding taxes and duties.

b) Where the total items are required for a main equipment and items are interdependent.

Liquidated Damages (LD) for Late Deliveries shall be applicable @0.5% per week or part thereof on total value of Purchase Order subject to maximum of 10% of the total value of Purchase Order. Purchase Order value for this purpose shall be the Total Gross Value payable to the vendor (Before LD) excluding taxes and duties.

c) Bidders are requested to quote the best delivery meeting the delivery requirements. BHEL reserves the right to reject the offers not meeting BHEL's delivery requirement.

d) Commencement of delivery period shall be reckoned from the date of PO / LOI or any other agreed milestone.

e) Bidder shall deliver the goods in the manner and schedule agreed under the terms and conditions of Purchase order.

f) **DELIVERY IN CASE OF REJECTION:** In case the material is rejected, then date of replacement will be considered as the actual date of delivery.

g) **DELIVERY AGAINST BANK DOCUMENTS:** In case payment terms quoted by bidder are documents through bank, and the delivery terms being "FOR Haridwar / FOR Transporter Go-down" then date of delivery will be date of intimation by transporter / bidder of delivery of material at Haridwar for the LD purpose.

h) Where the payments are through bank, the documents may be presented for negotiation to BHEL authorized / nominated bank.

i) Payment of Liquidated Damages (LD) shall not in any way relieve the vendor from any of its obligations & liabilities under the contract.

10. PAYMENT TERMS.

a) BHEL's standard payment term is Payment after receipt and acceptance of materials / items at HEEP, BHEL-Store or at desired destination unless otherwise specified in Special Terms attached to the tender enquiry.

b) BHEL reserves the right to accept or reject the offer of the bidder who quotes the payment term other than BHEL's standard payment term.

c) Loading on account of deviation in payment terms shall be done as per extant rules of BHEL-Haridwar.

d) 100% payment along with taxes, freight & insurance will be made after receipt and acceptance of material and within 75 days from the date of invoice subject to submission of non-discrepant documents within 15 days of supply as per terms and conditions of Purchase Order. In case any discrepancy found in the documents, BHEL will notify the same to vendor within 7 days of receipt. Vendor has to clear all the discrepancies in one go within 7 days thereafter else the payment of vendor may get delayed.

e) For MSEs (covered under MSME Act) which are registered and periodically renewed with BHEL, the payment will be made within 45 days or as prescribed in the relevant act.

f) Adherence to the above time schedule of payment is contingent upon Vendor complying with GST Rules w.r.t availment of Input Tax Credit by BHEL.

g) In case GST credit is delayed / denied to BHEL, due to non / delayed receipt of goods and / or tax invoice or expiry of the timeline prescribed in GST Law for availing such ITC, or any other reason not attributable to BHEL, GST amount shall be recoverable from Vendor along with interest levied / leviable on BHEL.

h) The taxes and duties that are reimbursed would be the ones applicable as on the contractual Purchase order delivery date or the amount actually paid whichever is less.



BHARAT HEAVY ELECTRICALS LIMITED

HEEP-HARIDWAR, UTTARAKHAND (249403)

General Instructions and Standard Terms & Conditions for bidding against Tender Enquiry (GISTC)

For Indian Bidders (Version May-2024, Rev: 07)

i) **The loading criteria for the different payment terms shall be as under;**

Payment Terms	Days of Loading
After Receipt & Acceptance of material within 75 days of supply.	No Loading
Against Delivery at BHEL-Stores Haridwar.	45
Against documents through bank (CAD):	45
Letter of Credit (LC)	120
Usance LC	No Loading if usance period is > 120 Days.
	Loading of days' difference i.e. difference between 120 days and usance period if the usance period is < 75 days.
Advance	Delivery Period + 120 Days - Advance Payment Days.

11. TAXES & DUTIES.

- a) The bidder to specify in their offer (part 1 bid) the category of their registration under GST like Registered, Unregistered and composite dealer.
- b) The provisional GST registration number of Bharat Heavy Electrical Ltd, Heavy Electricals Equipment Plant, Ranipur, Haridwar is "05AAACB4146P1ZL" with state Code as "05" and State Name as "Uttarakhand".
- c) Please quote our provisional GST registration number in all invoices raised for supply of goods and services under GST regime and also ensure filing of timely return and payment of tax and compliance of other applicable provisions on supplier under GST regime.
- d) No GST will be reimbursed to unregistered or composite dealer. In the event, any GST is quoted by composite dealer, the same shall be added to the cost of supply in evaluating the bid.
- e) Since, input credit of GST will be available to BHEL-Haridwar only after correct filing of return and payment of applicable GST by supplier, reimbursement of GST shall be made by

BHEL-Haridwar on matching of vendor inputs at GST portal, ensuring availability of input credit to BHEL Haridwar. Payment of GST will be made to vendor after matching of input credit and vendor to ensure submission of their invoices along with consent to accept payment of tax after such matching in all cases where bills are submitted directly to BHEL-Haridwar or through bank or under LC or through any other mode.

- f) In the event of any disallowance of input credit or applicability of interest or any other financial liability arises on BHEL-Haridwar due to any default of supplier under GST, such implication shall be to supplier's account.
- g) In the event of any change in the status of the vendor after the submission of the bid but before the supply, GST applicable at the time of supply or in the bid, based on the registration status of the vendor, whichever is lower shall be payable.
- h) Where ever applicable If PAN (Permanent Account Number) of the recipient is not available, income tax is deductible either at the normal rate or at the rate of 20 percent, whichever is higher as per Section 206AA of Indian Income Tax Act 1961.
- i) The bidder shall clearly indicate HSN (*Harmonised System Nomenclature*) / SAC (*Service Accounting Code*), its description and applicable rate of GST for each item in his techno-commercial bid.
- j) Statutory Variation in Taxes & duties as applicable at the time of supply shall be payable. However, in the event of no change in law but bidder quoting certain tax structure in bid document which is lower than the applicable one, such amount shall be the maximum amount of tax that can be claimed by bidder.
- k) **IMPORTED GOODS OFFERED BY INDIAN BIDDERS AGAINST DEALER INVOICE:** Wherever the material being offered is imported, the bidder must quote the prices inclusive of IGST. The rate and value of IGST as included in the price must be indicated separately. In case quantum of IGST is not mentioned by the bidder the same will not be considered for



BHARAT HEAVY ELECTRICALS LIMITED

HEEP-HARIDWAR, UTTARAKHAND (249403)

General Instructions and Standard Terms & Conditions for bidding against Tender Enquiry (GISTC)

For Indian Bidders (Version May-2024, Rev: 07)

evaluation. However, bidder will have to pass on the benefit of IGST to BHEL at the time supply.

- l) In case of directly dispatchable items to Customer's Site, BHEL-Haridwar will inform the GST registration number of the respective customer which must be mentioned on the vendor's invoice. Vendor to ensure availability of such information from BHEL-Haridwar before dispatch of any material. However, while filing GSTN-1, BHEL Haridwar GSTN number to be quoted.

Note: - Vendors must ensure compliance of all the applicable rules and procedure as envisaged in the GST Regime. Any loss to BHEL-Haridwar due to fault / non-compliance by the vendor will be to the vendor's account.

12. BANK GUARANTEE.

In case the bank guarantees are required to be deposited towards security deposit/performance guarantee or for any other purpose as per the terms of this tender enquiry, such bank guarantees of the requisite value in the denominated currency of the purchase order should be from one of the Indian branch of BHEL consortium banks and the bank guarantee should be in the proforma as prescribed by BHEL. The proforma of bank guarantee and the list of consortium banks are displayed at BHEL website www.bhelhwr.co.in. However, in case the bank guarantee is not from BHEL consortium banks, then the bidder has to get the bank guarantee confirmed from one of the Indian branch of BHEL consortium banks and the bank charges for such confirmation will be borne by the bidder.

13. GUARANTEE / WARRANTY AND CORRESPONDING REPAIRS / REPLACEMENT OF GOODS.

Goods shall comply with the specifications for material, workmanship and performance. Unless otherwise specified, the warranty shall be for a period of 18 months from the date of receipt. If the delivery is found non-compliant during the warranty period, leading to rejection, the Seller shall arrange free replacement / repair of goods, within one month from the date of intimation or any mutually agreed period. The rejected goods shall be taken away by the Seller at his cost and

replaced on Delivered Duty Paid (DDP) (FOR - BHEL Stores / designated destination basis) within such period. In the event of the Seller's failure to comply, Purchaser may take action as appropriate, including Repair / Replenish rejected goods & disposal of rejections, at the risk & cost of the Seller. In case the defects attributable to Seller are detected during processing of the goods at BHEL or at our subcontractor's works, the Seller shall be responsible for free replacement / repair of the goods as required by BHEL.

- b) **RETURN OF REJECTED MATERIAL FOR REPLACEMENT:** The bidder shall have to pay 5% incidental charges while taking back supplied material if it is found rejected on receipt. The rejected material shall be sent back only after receipt of replacement / submission of BG / refund of amount paid.

14. QUALITY REQUIREMENT.

Your bid / quotation should have specific confirmation regarding meeting all our quality requirements such as. (i) Test Certificate (TC), (ii) Guarantee Certificate (GC) / Warranty Certificate (WC), (iii) Quality Plan (QP) (if applicable); and (iv) Pre-Dispatch Inspection at your works (if applicable).

15. VALIDITY.

The quotation should be valid for a minimum period of 90 days effective from the date of opening of tender, unless otherwise specified in the tender enquiry.

16. RIGHT OF ACCEPTANCE.

- a) **BHARAT HEAVY ELECTRICALS LIMITED HARIDWAR** reserves the right to reject any or all the bids / quotations without assigning any reason thereof. BHEL also reserves the right to increase or decrease the tendered quantities. Bidders should be prepared to accept order for reduced quantity without any extra charges.
- b) Any discount / revised offer / bids submitted by a bidder on its own shall be considered, provided it is received on or before the due date and time of offer / bid submission (Part-1). Conditional discounts shall not be considered for evaluation of tenders.



BHARAT HEAVY ELECTRICALS LIMITED

HEEP-HARIDWAR, UTTARAKHAND (249403)

General Instructions and Standard Terms & Conditions for bidding against Tender Enquiry (GISTC)

For Indian Bidders (Version May-2024, Rev: 07)

- c) Unsolicited discounts / revised offers / bids given after Part-1 bid opening shall not be accepted. No change in price will be permitted within the validity period asked for in the tender enquiry.
- d) In case of changes in scope and / or technical specification and / or commercial terms & conditions having price implication, techno-commercially acceptable bidders shall be asked by BHEL to submit the impact of such changes on their price bids. In case a bidder opts to submit revised price bid instead of impact called for then the latest price bid shall prevail. However, in both situations, original price bid will be necessarily opened.
- e) The bidder whose bid is technically not accepted will be informed & EMD wherever submitted shall be returned after finalization of contract. EMD shall be forfeited in the event of bidder opting out after tender opening.
- f) BHEL reserves the right to short close the existing Purchase Order / Rate Contract / Work Order or any extension thereof at any stage.

17. TRANSIT INSURANCE.

- a) Transit Insurance will be covered by BHEL under its open Insurance Policy. Seller shall inform dispatch particulars (Purchase Order, RR /GR, Invoice value etc.) to "Finance department (Store bill Section), BHEL Ranipur, Haridwar (Uttarakhand-India) with value of consignment to the Purchaser within 07 days of dispatch for BHEL to arrange insurance coverage in its policy. Failure on the part of seller to inform dispatch particulars will make him liable to pay for any transit damages / losses suffered by the Purchaser.
- b) If Quoted Prices are inclusive of transit insurance, no weightage shall be given while evaluating the bids for Cost of Insurance, being in BHEL Scope.

18. RISK PURCHASE.

In case of abnormal delays (beyond the maximum late delivery period as per LD clause) in supplies / defective supplies or non-fulfillment of any other terms and conditions given in Purchase Order, BHEL may cancel the Purchase Order in full or part thereof, and may also make the purchase of such material from elsewhere / alternative source at the risk and cost of the supplier. BHEL will take all reasonable steps to get the material from alternate source at optimum cost. If bidder does not agree to the above Risk Purchase Clause, BHEL reserves the right to reject the offer. In case for compelling reasons BHEL accepts the offer without acceptance of this clause by the bidder and in the eventuality of Risk Purchase, appropriate action will be taken as per BHEL extant rules. This will be without prejudice to any other right of BHEL under the contract or under General Law.

19. FORCE MAJEURE CLAUSE.

Notwithstanding any other thing contained anywhere else in the contract or PO (Purchase Order), In case the discharge of obligation under the contract by either party is impeded or made unreasonably onerous, neither party shall be considered in breach of the contract to the extent that performance of their respective obligation is prevented by an event of Force Majeure that arises after the effective date (PO date).

In the above clause, Force Majeure means an event beyond the control of the parties to the contract which prevents a party from complying with any obligation of the contract including but not limited to:

- Act of God (Such as but not limited to earthquake, drought, tidal waves, floods etc.).
- War (whether war be declared or not), Hostilities Invasion, Act of foreign enemy etc.
- Rebellion, revolution, insurrection, civil war etc.
- Contamination of Radio Activity from any nuclear fuel or from any other nuclear waste or any other hazardous materials.
- Riots, commotions, strike unless restricted to the employees of supplier.
- Acts of terrorism.



BHARAT HEAVY ELECTRICALS LIMITED

HEEP-HARIDWAR, UTTARAKHAND (249403)

General Instructions and Standard Terms & Conditions for bidding against Tender Enquiry (GISTC)

For Indian Bidders (Version May-2024, Rev: 07)

- g) Other unforeseeable circumstances beyond the control of the parties and which the affected party cannot avoid even by using its best efforts.
- h) Cancellation of contract by customer.
- i) Change in law / government. Regulation making the performance impossible.
- j) Pandemic or Epidemic.

The party claiming to be affected by force majeure shall notify the other party in writing immediately without delay on the intervention and on the cessation of such circumstances.

Irrespective of any extension of time, if an event of force majeure occurs and its effect continues for more than 180 days the affected party shall have right to cancel the contract.

As soon as reasonably practicable following the date of commencement of a Force Majeure Event, and within a reasonable time following the date of termination of a Force Majeure Event, either Party invoking it shall submit to the other Party reasonable proof of the nature of the Force Majeure Event and of its effect upon the performance of the Party's obligations under this Agreement.

The party shall, and shall ensure that its Subcontractors shall, at all times take all reasonable steps within their respective powers and consistent with Good Operating Practices (but without incurring unreasonable additional costs) to:

- a) Prevent Force Majeure Events affecting the performance of the party's obligations under this Agreement.
- b) mitigate the effect of any Force Majeure Event and
- c) Comply with its obligations under this Agreement.

If the war like situation has developed in a country where a seller's works is located in this P.O. or there is political instability and Indian Embassy located in that country forbids or advises for not having any business dealing with the sellers located in such zone / region/ country, then BHEL reserves the right to cancel the order.

20. NON-DISCLOSURE AGREEMENT.

All Drawing and Technical Documents relating to the product or it's manufacture submitted by one party to the other, prior or

subsequent to the formation of contract, shall remain property of the submitting party. Drawing, technical documents or other technical information received by one party, shall not without the consent of the other party, be used for any other purpose than that, for which they were provided. Such technical information shall not without the consent of the submitting party, otherwise be used or copied, reproduced, transmitted or communicated to a third party. Patterns supplied by BHEL will remain BHEL's property which shall be returned by the bidder on demand to BHEL. Bidder shall in no way share or use such intellectual property of BHEL to promote his own business with others or to gain a commercial advantage. BHEL reserves the right to claim damages from the bidder, or take appropriate action as deemed fit against the bidder, for any infringement of the provisions contained herein as available under law or equity.

21. SETTLEMENT OF DISPUTES / ARBITRATION.

In case of any dispute arising out of as in connection with this contract, the same shall be referred to arbitration under Arbitration & Conciliation Act 1996 of a sole arbitrator who shall be appointed by mutual consent of the parties. The seat & venue of arbitration shall be Haridwar.

The proceedings shall be conducted in English. The Governing law of contract shall be the substantive law of India.

22. WHARFAGE / DEMURRAGE RESPONSIBILITY.

In the event of delay in receipt of documents by Manager (Stores-Shipping) BHEL-Haridwar and in case where dispatches are made through Unapproved Transporter the sole responsibility for wharfage / demurrage for such delay shall be that of supplier.

23. CONDITIONS FOR AVAILING MICRO & SMALL ENTERPRISES (MSE'S) BENEFITS.

- a) "MSE Suppliers can avail the intended benefits only if they submit along with the offer, attested copies of either EM II certificate having deemed validity (**five years** from the date of issue of acknowledgement in EM II) or valid NSIC certificate or EM II certificate along with attested copy of a CA certificate



BHARAT HEAVY ELECTRICALS LIMITED

HEEP-HARIDWAR, UTTARAKHAND (249403)

General Instructions and Standard Terms & Conditions for bidding against Tender Enquiry (GISTC)

For Indian Bidders (Version May-2024, Rev: 07)

(Format enclosed at annexure-1 where deemed validity of EM II certificate of five years has expired) applicable for the relevant financial year (latest audited). Date to be reckoned for determining the deemed validity will be the date of bid opening (Part 1 in case of two-part bid) or vendor has to give Udyog Adhar Memorandum (UAM). Non submission of such documents will lead to consideration of their bid at par with other bidders. No benefit shall be applicable for this enquiry if any deficiency in the above required documents is found or the requisite documents are not submitted before price bid opening. If the tender is to be submitted through e-procurement portal, then the above require document are to be uploaded on the portal. Documents should be notarized or attested by a Gazetted officer. **UAM need not required to be notarized or attested.**

b) Any new supplier will be eligible for registration with BHEL as MSE supplier provided at least any one of the following documents are submitted along with application for registration: -

1. Udyog Adhar Memorandum (UAM).
2. Valid National Small Industries Commission (NSIC) Certificate.
3. Entrepreneurs Memorandum part II (EM II) certificate (valid based on deemed validity of 5 years) or
4. EM II certificate along with attested copy of CA Certificate (as per prescribed format at annexure-A) applicable for the relevant financial year (latest audited), where the deemed validity of EM II is over.
5. However, credentials of all MSE suppliers will be verified before advancing the intended benefits.
6. MSE bidders claiming SC/ST status will have to submit SC/ST certificate of the Proprietor from competent authority. Attested (notarized or attested by Gazetted officer) copy to be submitted along with the offer.
7. In case techno-commercial accepted bidders include MSE source and their prices (based on landed cost – considering quoted prices) are within the price band of 15% w.r.t. L-1 bidder, then BHEL can offer **25%** of quantity of respective item (rounded off to nearest number) to MSE bidders at L-1 price and in case, more than one MSE bidder is in 15 % band and the same is accepted by more than one MSE bidders then **25%** quantities of respective items will be considered for ordering on proportionate basis amongst MSE bidders.

8. There will be minimum of **3%** reservation for women owned MSEs within the above mentioned 25% reservation.
9. The reservation for MSEs owned by SC/ST will be **6.25%** { 25% out of target of 25% - refer para 4 of Public Procurement Policy for the Micro and Small Enterprises(MSEs)}.
10. The definition of MSEs owned by Women Entrepreneurs is clarified as under:
 - a) In case of proprietary MSE, proprietor shall be Woman.
 - b) In case of partnership MSE, the Woman partners shall be holding at least 51% of share in the unit.
 - c) In case of Private Limited companies, at least 51% share shall be held by Women promoters.
11. The definition of MSEs owned by SC/ST is clarified as under:
 - a) In case of proprietary MSE, proprietor(s) shall be SC/ST.
 - b) In case of partnership MSE, the SC/ST partners shall be holding at least 51% of shares in the unit.
 - c) In case of Private Limited companies, at least 51% share shall be held by SC/ST promoters.
12. While distributing the **25%** quantity amongst MSE bidders the decimal points in quantity shall be ignored for all the bidders except the L-1 amongst MSE bidders. Balance quantity after allocating the quantity to other MSE bidders ignoring the quantities in decimal, shall be given to L-1 (amongst MSE) bidder. However, if there are more than one MSE bidder at the same price level than preference for additional quantities due to ignoring off the decimal (as mentioned above) shall be given to the bidder offering favorable terms to BHEL and if the conditions offered are also same then preference will be given to the bidder having high SPR rating.
13. In case there are more than one MSE bidders (with different landed cost to BHEL) within 15% price band of lowest bidder and quantity to be offered is 1 no. only, then preference shall be given to the MSE bidder with lowest landed cost.
14. In case there are more than one MSE bidders (with same landed cost to BHEL) within 15% price band of lowest bidder and quantity to be offered is 1 no. only, then preference shall be given first, based on the favorable terms in the bid and in case terms are also same, the bidder with high SPR rating shall be given preference.
15. If L1 bidder is MSE bidder, entire quantity will be given to such MSE bidder only.



BHARAT HEAVY ELECTRICALS LIMITED

HEEP-HARIDWAR, UTTARAKHAND (249403)

General Instructions and Standard Terms & Conditions for bidding against Tender Enquiry (GISTC)

For Indian Bidders (Version May-2024, Rev: 07)

16. Note: It may however be noted that MSE guidelines as on date (Date of Technical Bid Opening Part-1) shall prevail.

17. "As per the OM No. F.No. 1(2)(1)/2016-MA dtd. 09.02.2017 issued from the Office of Development Commissioner (Micro, Small & Medium Enterprises), "Traders and agents should not be allowed to avail the benefits extended under the PP Policy."

In view of this, it is clarified that benefits of MSE (such as EMD Waiver, Tender fee exemption, Price preference, Payment preference etc.) will be given only to those MSE Vendors who are manufacturers of offered items against the NIT. No MSE benefits shall be provided to Agents / Stockists / Dealers / Traders etc. for the items offered but not manufactured by themselves."

24. INFORMATION TO THE BIDDERS.

a) Purchase related information is available at our Business-to-Business (B2B) Portal available on our website <https://hwr.bhel.com>. The user ID & password can be obtained by sending a request to concerned purchase executives.

b) Intimate your change in mail address or communication address or changes, if any, by email to AGM (SDX/MM) giving your bidder Code.

c) Please resolve your rejections and unexecuted overdue purchase order immediately which are posted at our B2B Portal, which can be visited through our site <https://hwr.bhel.com>

d) Copy of this Tender Enquiry is being sent through the post.

e) The Bidder declares that they will not enter into any illegal or undisclosed agreement or understanding, whether formal or informal with other bidder(s). This applies in particular to prices, specifications, certifications, subsidiary contracts, submission or non-submission of bids or any other actions to restrict competitiveness or to introduce cartelization in the bidding process.

In case, the bidder is found having indulged in above activities, suitable action shall be taken by BHEL as per extant policies/guidelines.

f) Supplier must upload digitally signed e-Invoice on B2B portal for processing of Bills.

In other cases, inked signed hard copy of Invoice to be submitted for processing of Bills.

25. MAKE IN INDIA (GOVT-NOTIFICATION).

A. This tender enquiry shall be governed by notification no. P-45021/2/2017-PP (BE-II) dated 04.06.2020 of government of INDIA and subsequent circulars issued afterwards. Accordingly, the minimum local content, the margin of purchase preference and the procedure for preference to make in INDIA shall be adhered.

B. The margin of purchase preference shall be 20%.

- 'Class-I local Supplier' means a supplier or service provider, whose goods, services or works offered for procurement, has local content equal to or more than 50%, as defined under this order.
- 'Class-II local Supplier' means a supplier or service provider, whose goods, services or works offered for procurement, has local content more than 20% but less than 50%, as defined under this order.
- 'Non- local Supplier' means a supplier or service provider, whose goods, services or works offered for procurement, has local content less than or equal to 20%, as defined under this order.

C. Vendor to specifically confirm if they are Class-I or Class-II local supplier or not as per above mentioned notification.

Accordingly, the 'Class-I local supplier' / 'Class-II local Supplier' at the time of tender, bidding or solicitation shall be required to indicate percentage of local content and provide self-certification that the item offered meets the local content requirement for 'Class-I local supplier' / 'Class-II local Supplier', as the case may be. They shall also give details of the location(s) at which the local value addition is made.

D. In cases of Procurement for a Value in Excess of Rs. 10 Crores, the 'Class-I local supplier' / 'Class-II local Supplier' shall be required to provide a Certificate from the Statutory Auditor or Cost Auditor of the Company (in the case of companies) or from a practicing Cost Accountant or practicing Chartered Accountant (in respect of suppliers other than companies) giving the percentage of Local Content.



BHARAT HEAVY ELECTRICALS LIMITED

HEEP-HARIDWAR, UTTARAKHAND (249403)

General Instructions and Standard Terms & Conditions for bidding against Tender Enquiry (GISTC)

For Indian Bidders (Version May-2024, Rev: 07)

E. Requirement of Purchase Preference:

Purchase preference shall be given to 'Class-I local supplier' in procurements undertaken by procuring entities in the manner specified hereunder -

a. In the procurements of goods or works, which are covered by para 3(b) of mentioned Govt. circular and which are divisible in nature, the 'class-I local supplier' shall get purchase preference over 'Class-II supplier' as well as 'Non-local supplier', as per following procedure:

- i. Among All qualified bids, the lowest bid will be termed as L1. If L1 is 'Class-I local supplier', the contract for full quantity will be awarded to L1.
- ii. If L1 bid is not a 'Class-I local supplier', 50% of the order quantity shall be awarded to L1. Thereafter, the lowest bidder among the 'Class-I local supplier' will be invited to match the L1 price for the remaining 50% quantity subject to the class-I local supplier's quoted price falling within the margin of purchase preference, and contract for that quantity shall be awarded to such 'Class-I local supplier' subject to matching the L1 price. In case such lowest eligible 'Class-I local supplier' fails to match the L1 price or accepts less than the offered quantity, the next higher 'Class-I local supplier' within the margin of purchase preference shall be invited to match the L1 price for remaining quantity and so on, and contract shall be awarded accordingly. In case some quantity is still left uncovered on Class-I local supplier, then such balance quantity may also be ordered on the L1 bidder".

b. In the procurements of goods or works, which are covered by para 3(b) of mentioned Govt. circular and which are not divisible in nature, and in procurement of services where the bid is evaluated on price alone, the 'class-I local supplier' shall get purchase preference over 'Class-II supplier' as well as 'Non-local supplier', as per following procedure:

- i. Among all qualified bids, the lowest bid will be termed as L1. If L1 is 'Class-I local supplier', the contract will be awarded to L1.
- ii. If L1 is not 'Class-I local supplier', the lowest bidder among the 'Class-I local supplier', will be invited to match the L1 price subject to Class-I local supplier's quoted price falling

within the margin of purchase preference, and the contract shall be awarded to such 'Class-I local supplier' subject to matching the L1 price.

- iii. In case such lowest eligible 'Class-I local supplier', fails to match the L1 price, the 'Class-I local supplier' with the next higher bid within the margin of purchase preference shall be invited to match the L1 price and so on and contract shall be awarded accordingly. In case none of the 'Class-I local supplier' within the margin of purchase preference matches the L1 prices, the contract may be awarded to the L1 bidder.

c. 'Class-II local supplier' will not get purchase preference in any procurement, undertaken by procuring entities.

F. For this procurement, the local content to categorize a supplier as a Class-I local supplier/ Class-II local supplier/ Non-local supplier and purchase preference to Class-I local supplier, is as defined in Public Procurement (Preference to Make in India), Order 2017 dated 04.06.2020 issued by DPIIT. In case of subsequent orders issued by nodal ministry, changing the definition of local content for the items of the NIT, the same shall be applicable even if issued after issue of this NIT, but before opening of Part-II bids against this NIT.

G. Procurements where estimated value to be procured is less than Rs. 5 lakhs shall be exempted from GOI order No. P-45021/2/2017-PP (BE-II) dated 04.06.2020.

H. For procurement of Goods & Services which are divisible in nature, following shall be operated for **MSE bidders** under Public procurement Policy for the Micro and Small Enterprises (MSEs) Amendment Order, 2019, Ref. No. AA: SSP: MSE: Amndt, dtd. 30.11.2018, Circular No. 44 of 2018-19;-

a. If L1 bid is not from "Class-I local Supplier" and price quoted by MSE bidder falls within the margin of Purchase preference (L1+15% for MSEs), then 25 % of total order quantity of respective item (rounded off to nearest number) shall be awarded to MSE bidder, subject to MSE bidder matching the L1 Price. Out of Remaining 75% quantity, distribution shall be operated as per below sub-clause (2) –

b. If "Class- I Local Supplier" (Next to L1, other than MSE) quoted price falling within the Margin of Purchase Preference, and "Class-I local supplier" matches the L1 price,



BHARAT HEAVY ELECTRICALS LIMITED

HEEP-HARIDWAR, UTTARAKHAND (249403)

General Instructions and Standard Terms & Conditions for bidding against Tender Enquiry (GISTC)

For Indian Bidders (Version May-2024, Rev: 07)

then 50% of remaining Quantity (after allocation of 25% to MSE) i.e. 37.5% shall be awarded to local supplier and 37.5% shall be awarded to foreign bidder.

Note: L1 Price refers to lowest evaluated / landed cost to Company.

For Further details, please refer GOI order no. P-45021 / 2 / 2017 - PP (BE-II) dated 04.06.2020.

26. RESTRICTIONS UNDER RULE 144(XI) OF THE GENERAL FINANCIAL RULES (GFRs), 2017

All provisions of Order No. F.No.6/18/2019-PPD of Department of Expenditure (DoE) shall be applicable for this tender enquiry (Order copy is available at <https://doe.gov.in/procurement-policy-divisions>). Accordingly, any bidder from a country which shares a land border with India (except the countries to which the Govt. of India has extended lines of credit or in which the Govt. of India is engaged in development projects for which list is available at <https://www.mea.gov.in/>) will be eligible to bid in this tender only if the bidder is registered with the Competent Authority as specified in Annex I of the said Order of DoE.

Updated list of the countries to which lines of credit have been extended or in which development projects are undertaken are available on the Ministry of External affairs website (<https://www.mea.gov.in/>)

For the purpose of this order, definition of Bidder from a country which shares a land border with India shall be same as defined in the Annex III of the said order.

Registration with the competent authority as stipulated in the said order is responsibility of bidder. Bidder has to submit a certificate certifying following along with offer:

"I have read the clause regarding restrictions on procurement from a bidder of a country which shares a land border with India;

I certify that bidder (... Name of Bidder) is not from such a country or, if from such a country, has been registered with the Competent Authority. I hereby certify that bidder (.....Name of bidder) fulfils all requirements in this regard and is eligible to be considered"

If the bidder is from such country which shares a land border with India evidence of valid registration by the Competent Authority shall also be attached along with offer."

27. NOTE.

- a) Special conditions of enquiry, if enclosed by BHEL, will supersede the respective standard / general terms of enquiry.
- b) Any other Standard terms and Conditions of the bidder attached / referred against the tender enquiry will be treated as null and void ab initio.
- c) In order to protect the commercial interests of BHEL, it becomes necessary to take action against suppliers / contractors by way of suspension of business dealings, who either fail to perform or are in default without any reasonable cause, cause loss of business / money / reputation, indulged in malpractices, cheating, bribery, fraud or any other misconducts or formation of cartel so as to influence the bidding process or influence the price etc. Guidelines for Suspension of Business Dealings with Suppliers / Contractors shall prevail over which is available at BHEL website <http://www.bhel.com>
- d) The bidder along with its associate / collaborators / sub-contractors / sub-vendors / consultants / service providers shall strictly adhere to BHEL Fraud Prevention Policy displayed on BHEL website <http://www.bhel.com> and shall immediately bring to the notice of BHEL-Management about any fraud or suspected fraud as soon as it comes to their notice.
- e) "BHEL shall recover the amount of compensation paid to victim(s) by BHEL towards loss of life / permanent disability due to an accident which is attributable to the negligence of contractor, agency or firm or any of its employees as detailed below;
 1. **Victim:** Any person who suffers permanent disablement or dies in an accident as defined below.
 2. **Accident:** Any death or permanent disability resulting solely and directly from any unintended and unforeseen injurious



BHARAT HEAVY ELECTRICALS LIMITED

HEEP-HARIDWAR, UTTARAKHAND (249403)

General Instructions and Standard Terms & Conditions for bidding against Tender Enquiry (GISTC)

For Indian Bidders (Version May-2024, Rev: 07)

occurrence caused during the manufacturing / operation and works incidental thereto at BHEL factories/ **offices and precincts** thereof , project execution , erection and commissioning, services, repairs and maintenance, trouble shooting, serving , overhaul, renovation and retrofitting , trial operation, performance guarantee testing undertaken by the company or during any works / during working at BHEL Units/ Offices/ townships and premises/ project sites.

3. Compensation in respect of each of the victims:

- (i) In the event of death or **permanent disability** resulting from **Loss of both limbs**: Rs. 10,00,000/- (Rs. Ten Lakh).
- (ii) In the event of **other permanent disability**: Rs. 7,00,000/- (Rs. Seven Lakh).

4. Permanent Disablement: A disablement that is classified as a permanent total disablement under the proviso to Section 2(l) of the Employees Compensation Act, 1923.”

f) The bidder shall be in compliance with applicable laws, rules and regulations throughout the terms of the contract for conducting its business generally and to perform its obligations under this contract.