

TD-106-1
Rev.5

Form No.



**PRODUCT STANDARD
TURBINES & COMPRESSORS
HYDERABAD**

TC-6-2743

Rev.No. 02

SHT 1 OF 67

This job specification shall be completely filled-in, duly signed by supplier and enclosed along with offer.

**TECHNICAL SPECIFICATION OF 1 X 800MW NORTH CHENNAI
OXIDATION BLOWER**

CONTENTS

1.0	SCOPE
2.0	LIST OF ANNEXURES
3.0	APPLICABLE CODES & REGULATIONS
4.0	PROJECT INFORMATION
5.0	INTENT OF SPECIFICATION
6.0	PROVENESS CRITERIA
7.0	TECHNICAL INFORMATION
8.0	MATERIAL CODES
9.0	SCOPE OF SUPPLY
10.0	GENERAL REQUIREMENTS
11.0	PACKING INSTRUCTIONS
12.0	SUPERVISION OF ERECTION, TESTING & COMMISSIONING
13.0	EXCLUSION
14.0	INSPECTION AND TESTING
15.0	PAINTING
16.0	SPARES, TOOLS & TACKLES
17.0	PERFORMANCE GUARANTEE
18.0	BID EVALUATION CRITERIA FOR POWER CONSUMPTION
19.0	LIQUIDATED DAMAGES FOR POWER CONSUMPTION
20.0	WARRANTY
21.0	FIRST FILL OF CONSUMABLES
22.0	TRAINING
23.0	CONFLICT
24.0	DOCUMENTATION
25.0	PRICE SCHEDULE
	ANNEXURES

COPYRIGHT AND CONFIDENTIAL
The information on this document is the property of BHARAT HEAVY ELECTRICALS LIMITED
It must not be used directly or indirectly in any way detrimental to the interest of the company

Ref. Doc

Rev No. 05	Revisions: Refer to record of revisions	Prepared: DILEEP	Approved: YVRL	Date: 03.05.2021
----------------------	---	----------------------------	--------------------------	----------------------------

	PRODUCT STANDARD TURBINES & COMPRESSORS HYDERABAD	TC-6-2743
		Rev.No. 02
		SHT 2 OF 67

1.0 SCOPE:

This specification describes the requirements of oxidation blower for 1X800 MW North Chennai FGD projects.

2.0 LIST OF ANNEXURES:

Annexure No.	Annexure Description
3K	Provenness Criteria
I	Qualification requirement
II	Technical Data Sheet
III	Schedule of guarantees
IV	List of commissioning spares
V	Mandatory spare instrument list
VI	List of Deviations/ Exceptions
VII	Reference List
VIII	Documents to be submitted along with offer
IX	Documents to be submitted after award of offer
X	Various clauses of inspection & testing
XI	General instruments specifications
XII	Motor specification
XIII	P & ID drawing indicating scope of supply

3.0 APPLICABLE CODES & REGULATIONS:

The design and materials shall conform to the requirements of applicable codes and regulations of the latest edition. The design, manufacture, installation and testing of the Oxidation Blower shall follow the latest applicable Indian/International (AISI / ASME/EN) Standards.

4.0 PROJECT INFORMATION:

The North Chennai Thermal Power Station is a power station situated about 25 kilometres from Chennai city. It is one of the major power plants of Tamil Nadu. The North Chennai Thermal Power Station was commissioned in 1994 in the Thiruvallur district. It was built there due to its proximity to the Ennore Port, which also supplies Ennore Thermal Power Station. Ennore is a suburb in Chennai, India. It is situated on a peninsula and is bounded by the Korttalaiyar River, Ennore creek and the Bay of Bengal. The creek separates Ennore from the Ennore Port and Athipattu Pudunagar.

a.	Owner	North Chennai Thermal power station
b.	Buyer	BHEL, Hyderabad
c.	Process/Application	Flue Gas Desulphurization

A) SITE CONDITIONS

Design point

1. Ambient Temperature and Relative Humidity		
	Ambient Temperature (Design)	: 30 deg C
	Relative Humidity	: 75 %

	PRODUCT STANDARD TURBINES & COMPRESSORS HYDERABAD	TC-6-2743
		Rev.No. 02
		SHT 3 OF 67

B) WATER ANALYSIS

The following service water to be used for quenching the Oxidation air discharge temperature <70 deg C.

S.No	Constituents	Unit	value
1.	Temperature	Deg C	35
2.	pH	--	7.5-8.2
3.	LSI		0-0.2
4.	Alkalinity		< 100PPM of CaCo3
5.	Hardness		<80 PPM
6.	Chloride		<350PPM
7.	Sodium		<170 PPM

5.0 INTENT OF SPECIFICATION

This specification covers the minimum requirements for the complete design, material, manufacturing, shop inspection, testing at the manufacturer's works, supervision of erection & commissioning and performance testing of Oxidation blower along with accessories which is to be furnished in the Flue Gas Desulphurization plant of 1X800MW North Chennai FGD Project. The following points may be noted.

- a. There is only one unit of 800 MW and is envisaged with one FGD system. The FGD system will be provided with 2 numbers of Oxidation Blower (1 working + 1 standby) which are located inside the Recirculation Pump & Oxidation Blower shed.
- b. Bidder shall assume full unit responsibility for the entire equipment assembly and make all possible efforts to comply strictly with the requirements of this specification and other specifications/attachments to inquiry/order.
- c. The Bidder shall offer only proven design which meets the proveness criteria indicated in **Annexure-I of TC62743**. Necessary document evidences as per **Annexure-3K of TC62743** for qualification shall be submitted along with the bid. If the Bidder doesn't meet the specified proveness criteria, then the Bidder will not be allowed to participate in the tender.
- d. In case, deviations are considered essential by the Bidder (after exhausting all possible efforts), the same shall be separately listed in the Bidder's proposal under separate section, titled as "List of Deviations/Exceptions to the Enquiry as listed in **Annexure VI of TC62743**.
- e. Any deviation, not listed under the above section, even if reflected in any other portion of the proposal, shall not be considered applicable.
- f. No deviation or exception shall be permitted without the prior written approval of the purchaser.
- g. Compliance to this specification shall not relieve the Bidder of the responsibility of furnishing equipment and accessories/auxiliaries of proper design, materials and workmanship to meet the specified start up and operating conditions.

	PRODUCT STANDARD TURBINES & COMPRESSORS HYDERABAD	TC-6-2743
		Rev.No. 02
		SHT 4 OF 67

- h. In case, the bidder considers requirement of additional instrumentation, controls, safety devices and any other accessories/auxiliaries essential for safe and satisfactory operation of the equipment, the same shall be recommended along with reasons in a separate section and include the same in scope of supply.
- i. All accessories, items of work, though not indicated but required to make the system complete for its safe, efficient, reliable and trouble free operation and maintenance shall also be in supplier's scope unless specifically excluded.

6.0 PROVENNESS CRITERIA:

The Bidders are required to meet the Qualification Requirement (QR) for Oxidation Blower as per **Annexure-I of TC62743** & necessary documents evidence requirement as per **Annexure-3K of TC62743** along with necessary supporting documents. Bidder's offer will be rejected if the bidder fails to meet the Qualification criteria.

	PRODUCT STANDARD	TC-6-2743
	TURBINES & COMPRESSORS	Rev.No. 02
	HYDERABAD	SHT 5 OF 67

7.0 TECHNICAL INFORMATION

Sl. No	Description	Requirement		
1.	Quantity	2 Nos (1 Working + 1 standby) per unit .Total 2 Nos.		
2.	Parameters			
	Operating Points	(1)Design Point	(2)Operating point-1	(3)Guarantee Point
	Blower capacity	9450 Nm³/hr-wet.	7340Nm³/hr-wet.	7120 Nm³/hr-wet.
	Discharge pressure	8500 mmWC	7800 mmWC	7650 mmWC
	Relative humidity	75%	75%	75%
	Suction temperature	30.0° C	30.0° C	30.0° C
	Atmospheric pressure	1012 hPa		
	Discharge temperature	<70° C		
	Type of Blower	Single stage, integrally geared, single or dual vane centrifugal type oxidation blowers complete with integral gearbox, lube oil system, instrumentation and accessories. The blowers will be used for supplying a variable volume of air to the absorber reaction tank.		
	Duty	Continuous		
3.	Cooling water			
	Inlet temperature	38° C		
	Increase in temperature	Max 10 degrees		
	Pressure loss	<0.05 MPa (Max)		
	Supply pressure	0.5 MPa		
4.	Air Composition (Wet)	Design point	Operating Point	Guarantee point
	H ₂ O	3.144 vol%	3.144 vol%	3.144 vol%
	O ₂	20.34 vol%	20.34 vol%	20.34 vol%
	N ₂	Balance	Balance	Balance
5.	Material of construction			
	Casing	Vendor to provide		
	Shaft	Vendor to provide		
	Impeller	Vendor to provide		
6.	Voltage level for Motors	a) Up to 0.2KW – Single phase 240V AC/ 3phase 415V AC b) Above 0.2 KW and up to 200 KW- 3phase 415V AC c) Above 200 KW and up to 1500 KW- 3phase 3.3kV AC d) Above 1500KW-11 kV		
7.	Air filter filtering efficiency	Vendor to provide along with name of vendor supplying the Air Filter		
8.	Blower Driver	Motor		
9.	Cooling system for reducing the temperature of air at the blower outlet to <70 deg Celsius	Quenching/Cooling arrangement with water injection arrangement to be provided. Heat exchanger should not be provided. Water analysis is given in Table -Water Analysis Below Refer Annexure-1- Attached Reference drawing of Quenching Nozzle from MHPS		

	PRODUCT STANDARD TURBINES & COMPRESSORS HYDERABAD	TC-6-2743
		Rev.No. 02
		SHT 6 OF 67

Sl. No	Description	Requirement
		Quenching Nozzle back pressure- <1.0 bar(g)
10.	Instrumentation execution	<p>a) All field transmitter like pressure, temperature, flow, level, DP etc. shall be foundation fieldbus or profibus type. The exact type shall be informed during detail engineering. Vendor shall quote foundation fieldbus type transmitter in its base offer. Vendor to include 'price implication' if any, in its commercial offer as a separate line item against heading "Price implication (+ / -) for Profibus type transmitters". In case there is no price implication, vendor to indicate the same in the technical offer.</p> <p>b) Control Valve Actuators: Electrical actuators shall to be of Fieldbus type.</p> <p>c) Rotor Vibration Sensors: 02 nos on DE side and 02 nos on NDE side.</p> <p>d) Bearing Temperature Sensors: 02 nos on DE side and 02 nos on NDE side.</p> <p>e) SPARES LIST / Philosophy – As per Annexure V of TC62743</p>

11	POWER SUPPLY	
	The following voltage levels shall apply:	
	3.3 kV ±6%,50 Hz	Voltage for motors equal to / bigger than 200 KW and for power distribution within the plant.
	415 V ±10%, 50Hz	Standard voltage for power supplies to small electric power consumers and motors up to 200 KW lighting and domestic power outlets
	Bidder shall design and supply the equipment suitable for satisfactory operation under above mentioned power supply condition.	

Note: Stand by oxidation blower should start automatically once the working oxidation blower trips due to failure.

	PRODUCT STANDARD TURBINES & COMPRESSORS HYDERABAD	TC-6-2743
		Rev.No. 02
		SHT 7 OF 67

8.0 MATERIAL CODES

Var No	Description	Material Code
01	2x100% Single stage, integrally geared, single or dual vane centrifugal type oxidation blowers complete with integral gearbox, lube oil system, instrumentation and accessories.	TC9762743016
02	Impeller Assembly	TC9762743024
03	Set of Bearings (Required 1No. each for complete replacement of all bearings in one Blower)	TC9762743032
04	Suction air filter	TC9762743040
05	Commissioning spares	TC9762743059
06	Blower instrumentation spare- (Spare list as per Annexure V Philosophy)	TC9762743067

9. SCOPE OF SUPPLY:

Scope for the bidders shall include Design, Supply, and Supervision of Erection & Commissioning

Design: Includes basic engineering, detail engineering, preparation and submission of engineering drawings/calculations/datasheets/quality assurance documents/field quality plans, storage instructions commissioning procedures, operation & maintenance manuals, performance guarantee test procedures and assisting BHEL in obtaining time bound approval from customer.

Supply: Includes manufacturing/fabrication, stage inspections, final inspections, shop floor testing, painting & packing

Supervision of Erection & commissioning: Includes supervision of erection & commissioning, supervision of trial operation, training of customer's O&M Personnel.

Supplier's scope shall cover complete air blower unit including sub-systems, start-up spares and special tools (typically) as given below. The scope of supply for air blower shall include but not limited to the following:

Sl. No	Scope of Supply for each Blower
1.	Suction filter, throtlter/ IGV including silencer along with filter support structure
2.	Suction & Discharge silencers
3.	Suction expansion joint
4.	Suction piping from filter up to blower suction nozzle
5.	Air Blower
6.	Gear Box (or) Belt & Pulley (if required)
7.	Coupling between motor & gear box (or) Belt and Pulley (as applicable)

	PRODUCT STANDARD TURBINES & COMPRESSORS HYDERABAD	TC-6-2743
		Rev.No. 02
		SHT 8 OF 67
8.	Non sparking coupling guards (between motor & gear box and between gear box & Blower as applicable or Belt and Pulley)	
9.	Discharge expansion joint	
10.	Blow-off control valve with required accessories such as solenoid valve limit switches, positioner etc completely tubed and wired to junction box	
11.	Blow-off silencer	
12.	Complete Blow-off piping	
13.	Discharge non return valve	
14.	Discharge Silencer	
15.	Motor operated isolation valve in discharge	
16.	Discharge piping from Blower outlet up to isolation valve	
17.	Foundation bolts for complete blower and Motor frame.	
18.	Anti-vibration pad, if required	
19.	Common Base frame for Blower, gear box (as applicable) and motor	
20.	Lube Oil System for blower and gear box (details to be provided by vendor)	
21.	Casing drain terminated at battery limit with flange	
22.	Acoustic hood to meet specified noise level (if applicable)	
23.	Accessory Piping within the skid	
24.	Companion flanges with gaskets and fasteners at all terminal points	
25.	Differential pressure Indicator across suction filter	
26.	Vibration Monitoring: Provision for Vibration Monitoring & Temperature elements wired up to JB.	
27.	Pressure Indicator in the discharge line	
28.	All Cabling up to junction boxes with double compression cable glands	
29.	Junction Boxes	
30.	Safety Valves required for the blower	
31.	Electrical items as required like lube oil pump motors, heaters etc are to be included in vendor scope	
32.	Mechanical Running at shop with vendor's shop motor	
33.	Performance test at shop	
34.	Supervision of erection / commissioning , start-up and trial run of blower	
35.	Start-up & Commissioning spares as applicable to be included in base quote	
36.	O&M spares with price breakup	
37.	Special tools & Tackles as applicable	
38.	Painting as per specification	
39.	Packing & Forwarding	
40.	Power cabling is not in vendor scope. Power cables will be provided up to consumption point by BHEL.	
41.	All other items, instruments shall be as per P&ID given in Annexure- IX	
42.	Any other items required for completeness of the equipment except the items covered in the exclusions.	
43.	Bidder shall refer to the P&ID enclosed in Annexure – IX for detailed clarity on the scope.	
Common Scope: For two Blower		
44.	Discharge air piping from individual blower isolation valve to flow element in common discharge line.	
45.	Quenching system to bring the discharge temperature to <70 deg C .	

	PRODUCT STANDARD	TC-6-2743
	TURBINES & COMPRESSORS	Rev.No. 02
	HYDERABAD	SHT 9 OF 67
46.	Cooling water supply to Gearbox or Bearing and return will be provided at one point near battery limit. Further distribution is in vendor scope.	
47.	Instrument air supply will be provided at one point near battery limit. Further distribution is in vendor scope.	
All the instruments/items which have to be supplied by Blower vendor is indicated in the P&ID enclosed . Any other items / components not indicated in the P&ID , but required as per blower manufacturer's standard practice or required for blower operation shall also be provided.		
9.1 CONSTRUCTION FEATURES		
a.	Each blower shall be a complete unit with casing, rotor, shaft and drive unit etc.	
b.	The Blowers shall be Single stage integrally geared centrifugal type with lube oil system, instrumentation and accessories. It shall be compact and simple in design requiring minimum number of spares.	
c.	The oxidation blowers should be complete with drive arrangement consisting of coupling, coupling guard, base frame shock absorbers, mounting bolts, air filter, Acoustic enclosures, silencers, safety valves and check valves etc.	
d.	The oxidation blowers shall be designed for continuous operation along with suitable quenching arrangement with temperature measurement and control to meet the exit temperature < 70 deg C. The Bidder shall specify the cooling water requirement for reducing the temperature of discharge air.	
e.	The rotor shall be ground all over and accurately machined. The rotor along with other rotating parts shall be statically balanced and then dynamically balanced as per ISO 1940 to ensure efficiency, vibration, performance and long bearing life.	
f.	The air intake filter cum silencer, preferably dry type, to prevent dust and other atmospheric impurities from entering the blower shall be provided for each blower. Air filter shall have better filtering efficiency.	
9.2 COOLING ARRANGEMENT		
a.	The discharge air temperature <70 Deg C may be obtained by quenching arrangement with water injection at the common discharge with temperature measurement.	
b.	In case of casing cooling, the vendor shall consider the water quality available and accordingly select the casing material to withstand the corrosion, if any. The inside of the casing also to be coated with corrosion resistant materials of adequate thickness to enhance corrosion resistance of the Blower.	
c.	The vendor to provide the following accessories along with cooling arrangement (with auto drain) <ul style="list-style-type: none"> ▪ Required pipe fittings within the scope of terminal points ▪ Required number of spray nozzles ▪ Water quantity required ▪ Required flow control devices like valves, pressure gauges and other instruments. ▪ Scheme & arrangement drawing shall be mentioned in offer. 	

	PRODUCT STANDARD	TC-6-2743
	TURBINES & COMPRESSORS	Rev.No. 02
	HYDERABAD	SHT 10 OF 67
9.3	CASING	
a)	Casing shall be of robust construction. It shall be made from Casting or fabricated from heavy gauges steel sheets or plates or bidder's proven design standard.	
b)	In case of castings, the casing will be of Gray Cast Iron confirming to IS: 210 grade 25 or equivalent, designed for the duty conditions or proven design standard. Castings shall be free from all defects and blowholes and shall be machined to close tolerance. In case of fabricated casings, it shall be rigidly reinforced and supported by structural members. Weld seams shall be continuous to have air-tight enclosure.	
c)	Casings shall also have smooth interior to avoid accumulation of dense particles. Inlet shall be spun to have a smooth contour.	
d)	If necessary, provision for ready access to the interiors of casings and other possible trouble points shall be made by means of readily removable, bolted on plates or by hinged and latched doors.	
e)	Any connections shall be flanged. Flange diameter and drilling shall conform to ANSI B16.5 Class 150	
9.4	ROTORS & IMPELLERS	
a)	The rotor shall be made of cast iron or forged steel or proven design standard.	
b)	Rotor assemblies shall be statically balanced and then dynamically balanced as per ISO 1940.	
c)	The Impeller material should be as per their standard for air application.	
9.5	SHAFT, SHAFT SEALS AND BEARINGS:	
a)	The shaft shall be made of alloy steel or bidder's proven design standard.	
b)	Shafts shall be conservatively designed to transmit maximum power required and to assure rigidity. Shafts shall be machined and ground to close tolerances and shall be tapered to permit easy removal of the seals and bearings.	
c)	Shaft shall run in high precision heavy duty bearings. Lubrication system provided shall be such that visual checking of lubricant level is possible	
d)	The shaft shall be finished to close tolerance at the rotor, coupling, pulley and bearing diameters. The size of shaft shall be calculated on the basis of maximum combined shear stress. This shear stress shall not exceed 30 percent of the elastic limit in tension or 18 percent of ultimate tensile strength.	
e)	The design of shaft shall also take into consideration the critical speed of the shaft, which shall be at least 20% above the operating speed or 60 to 75% of the operating speed to minimize vibrations. Shafts shall be tapered to permit easy removal of the seals and bearings	
f)	Shaft seals shall be provided to seal rotating shafts. Shaft seals shall be of the labyrinth type, of non-sparking material and shall be horizontally split to facilitate maintenance. The housing shall be of cast iron or fabricated steel construction and shall be horizontally split to provide access to all bearings and shafts.	

	PRODUCT STANDARD	TC-6-2743
	TURBINES & COMPRESSORS	Rev.No. 02
	HYDERABAD	SHT 11 OF 67
g)	The bearings may be ball, roller or sleeve bearing. If sleeve bearings are used these shall be machined for close running fit. The bearings shall be designed to take the necessary radial load as well as the net axial thrust. Bearings shall be lubricated properly and sized for an operating life minimum of 50,000 hours on the basis of maximum load.	
h)	Blower induced vibration due to flow pulsations shall be avoided through suitable design.	
i)	Bearing temperature sensor shall be provided for remote monitoring of the bearing metal temperature of blowers. 2 Nos of Duplex RTD shall be provided to measure bearing temperature at DE and NDE ends.	
9.6	BELT & PULLEY/ COUPLING	
a)	The HT drive motor is excluded from the scope of supply. However, the bidder shall supply coupling or belt and pulley for secondary transmission.	
b)	Coupling shall be of flexible type. The Bidder shall furnish both halves of the coupling. Both the Coupling halves shall be bored and keyed to fit shafts of the blower and the motor by bidder.	
c)	All rotating parts such as coupling or belt & pulley shall be covered with suitable protective guards. Guards shall be easily removable type.	
9.7	BASE PLATE	
a.	A common base plate shall be provided for Blower assembly & Motor and same shall be rigidly constructed, adequately braced and provided with finish pads for mounting blower.	
b.	Suitable holes shall be provided for grouting and these shall be so located that the base plate can be grouted in place without disturbing the blower and motor.	
c.	Common base plate for Blower and Motor shall be in the scope of the bidder and the details of the Motor will be furnished to the bidder to provide Motor mounting bolts.	
9.8	MOTORS	
	<ul style="list-style-type: none"> ▪ Above 0.2 kW and upto 200 kW: 3 phase 415 V AC-VENDOR SCOPE ▪ Above 200 kW and upto 1500 kW: 3.3 KV- BHEL SCOPE ▪ Above 1500 kW: 11 KV-BHEL SCOPE 	
9.9	ACCESSORIES:	
1.	Lube Oil Unit : (If applicable)	
a)	Each blower shall be furnished with an integral lubricating oil package. Each package shall be complete with single water to oil heat exchanger, full flow oil filter and oil pump. The oil pump shall be direct driven from the blower shaft. The complete package shall be factory wired, assembled and mounted on the base plate. Air cooled LO System shall be applied. If cooling water is required, bidder shall provide the supply requirements(flow, pressure) and the return conditions(temperature, pressure drop)	
b)	Emergency power supply is not available. The Lubricating oil system shall be designed that will satisfy the required lubrication for bearing at the time of electric power failure also.	
c)	Oil Bath System for Lubrication can also be provided instead of Lube oil system for machine to coast down	
2.	Coupling Guards- All rotating parts outside casing such shall be covered by the guard.	

	PRODUCT STANDARD	TC-6-2743
	TURBINES & COMPRESSORS	Rev.No. 02
	HYDERABAD	SHT 12 OF 67
3.	Intake Air Filter Silencers:	
a)	Each blower shall be provided with an inlet filter silencer of dry type and a conical shaped screen ahead of the filter. Filters shall be capable of removing minimum 82 percent of all particles 10 microns and larger. Suitable filter area shall be provided for air suction. The suction area shall be minimum of twice the inlet pipe area. Differential pressure gauges shall be provided in filters to monitor any clogging in filters. Silencers shall be provided in discharge also.	
4.	Expansion Joints:	
a)	Expansion Joints shall be provided at the suction and discharge of each blower	
5.	Safety Valves:	
a)	Each blower shall be provided with a safety relief valve on its discharge.	
b)	The valve, valve operator and controller shall be remotely mounted to prevent vibration damage. The valve shall be mounted in an easily accessible location to allow for maintenance and testing	
c)	The safety valve discharge piping shall be routed to a location such that personnel exposure to the discharge is prevented.	
6.	Piping and Valves:	
a)	All interconnecting piping whichever is necessary for operation of each unit shall be provided complete with shut off valves, check valves, strainers and fittings. Details of Oxidation blower piping : Material: A53-B or equivalent suitable for specified application	
b)	Details of valves are given below: i) BUTTERFLY VALVE Rating: CL 150, Body: A216WCB, Trim:13CR, Lining: EPDM, Connection: WAFER Operation: Electrically operated with hand wheel integral starter type. ii) CHECK VALVE: Rating: CL 150, Body: A395, Trim: 13CR, connection: RF , Type: BC,SWING. iii) GATE VALVE: Rating: CL 150, Body: A105, Trim:13CR, Lining: Seat STL, Connection: SW, Operation: Hand wheel, Bonnet: BB,OS&Y	
7.	Blower control:	
a)	Blower should be provided with suitable control equipment for smooth running to avoid surge, choke etc.	
b)	Bidder to provide the control logic for the oxidation blower	
c)	Control of the blower shall be done from the DCS located in the FGD control room. Bidder shall	

	PRODUCT STANDARD	TC-6-2743
	TURBINES & COMPRESSORS	Rev.No. 02
	HYDERABAD	SHT 13 OF 67
	provide all inputs for the same.	
8.	Blower Shut Down:	
a)	Following is a typical list of abnormal conditions which might require blower shut down/Alarm. The contractor shall propose the exact conditions which require shutdown/alarm Blower shutdown signals: a) Discharge air temperature high b) Discharge pressure low or high. Temperature transmitter for initiating shutdown of blower during when “Discharge air temperature high” shall be supplied by Bidder. Pressure Switch for initiating Shutdown of blower during when “Discharge pressure low or high” shall be supplied by Bidder.	
b)	In addition to the Instrumentation & Control devices, sensing conditions which require shut down an emergency stop push button shall be provided. The push button shall be wired to the terminal blocks in the control cabinet for external connection to the blower controller.	
c)	Provision shall be made to shut off the blower automatically when the level of lubricating oil falls below the design value. Suitable provision shall be made to take the signal to PLC / DCS system. In case of water cooling, the blower shall be shut off automatically whenever the pressure of the cooling water supply line falls below preset value.	
9.	PROVISSION FOR VIBRATION MONITERING:	
	Shaft vibration sensors shall be provided. These shall be provided for X axis & Y axis vibration measurement in bearing housing. The vibration sensor transducer output shall be 4-20mA for connection to DCS/PLC.	
10	INSTRUMENTS AND ACTUATORS:	
	All instruments & actuators shall be connected to DDCMIS through fieldbus i.e. FOUNDATION Fieldbus/PROFIBUS PA protocol complying to IEC 61158. All electric actuators shall be with integral starters (non-intrusive with SIL2 certification). Bidder shall refer to Annexure VII of TC52545 for specification of Instruments.	

10.0	GENERAL REQUIREMENTS
1.	Metric unit shall be used in the drawings and in the any displays on the equipment’s.
2.	Descriptions in the drawings, in the documents, and in the displays shall be in English
3.	All rotating parts such as coupling shall be covered with suitable protective guards. Guards shall be easily removable type.
4.	The equipment shall be designed to withstand the corrosive and moist environment in which these are proposed to operate.
5.	Noise level produced shall not exceed 85 dB measured at a distance of 1.0 meters from the source in any direction and 1.5m above operating floor. Predicted sound pressure levels for the

	PRODUCT STANDARD	TC-6-2743
	TURBINES & COMPRESSORS	Rev.No. 02
	HYDERABAD	SHT 14 OF 67
	blower drive assemblies shall be submitted as part of the proposal data. The Acoustic enclose should be suitably designed to meet the required Noise Level.	
6.	The overall vibration level shall be as per ISO7919-3.	
7.	Suitable drain connections shall be provided.	
8.	The equipment shall be suitable for stable operation continuously.	
9.	Limit of connection: The buyer (BHEL) has an intention to minimize interface for utilities as much as possible. The bidder shall consider this requirement in the planning stage of layout for the equipment. The bidder shall provide the header piping for utilities and branch piping to each nozzle. Terminal points for all utilities shall be located at skid edge. The bidder shall specify all terminal points with tie-in number in the P&ID and submit it in the proposal to confirm the scope of supply.	
10.	Service life: Entire equipment except wearing parts shall be designed and fabricated for a minimum service life of 30 years of operation or 200,000 full load operating hours whichever is longer.	
11.	Corrosion allowance: Corrosion allowance for entire equipment shall be in accordance with latest applicable international standard.	
12.	Unless otherwise specified , flanges shall be in accordance with ANSI B16.5 Class 150	
13.	Name plate: All equipment shall be provided with nameplates indicating the item number and service name. Name plates shall be of 304 Stainless steel plate and placed at a readily visible location. Nameplate of main equipment shall have enough information, which will be confirmed during engineering phase. Stainless steel nameplates for all instruments and valves shall be provided.	
14.	Rotation arrows shall be cast in or attached with stainless steel plate on each item of rotation equipment at a readily visible location.	
15.	Unless otherwise specified, all equipment items where the weight exceeds 15 kg shall be provided with suitable lifting lugs, ears or ring bolts or tapped holes for lifting rings. Minimum shock factor for lifting lugs shall be minimum 2.0. The position of lifting lugs and reference dimension shall be shown on GA and/or outline drawings. NDT shall be conducted for lifting lugs. When any spreader bars are required for lifting and laydown, the bidder shall provide spreader bar with equipment.	
16.	Skid Mount/Transportation: Equipment shall be fabricated as skid mount design as much as practical to minimize erection at the site.	
17.	Two pieces of stainless steel earth lugs shall be provided with equipment diagonally. The position of earth lugs shall be shown on each GA and/or outline drawing.	
18.	Provide double nuts for anchor bolts	
19.	Bidder shall provide allowable vibration level on foundation in foundation drawings and/or general arrangement drawings.	
20.	If the driver/driven equipment train is in the resonance condition or any vibration problems occur, the bidder shall solve the problems in a timely manner.	

	PRODUCT STANDARD	TC-6-2743
	TURBINES & COMPRESSORS	Rev.No. 02
	HYDERABAD	SHT 15 OF 67
21.	The bidder shall have full responsibility for vibration control of the equipment train at the site and the unit's satisfactory performance, even if the foundation and drivers are provided by the BHEL.	
22.	Bidder shall provide the mating flanges with the necessary gaskets.	
23.	All the surfaces of the carbon steel should be rust prevented before shipment for the period of at least 12 months for storage and construction.	
24.	Bidder to specify capacity of crane or hoist required for material handling and the details of heaviest component to be handled.	
25.	The list of all Bought out items with makes and country of origin to be mentioned along with offer to be submitted.	
26.	Quality Plan to be submitted along with the offer.	
27.	During entire period of the equipment / project erection, commissioning & operation, the bidders shall strictly follow and adhere to the guidelines for effective Health & Safety Management. Supply of safety gears/PPE for bidder's/bidder's sub vendor personnel deputed at site for Supervision of E&C, PG tests etc. shall be in bidder's scope.	
28.	Cost towards the participation in discussions/meetings, technical discussions/meetings with customer for approval of drawing/documents etc. shall be included in bidder scope. TA/DA, boarding and lodging to attend these meetings shall be borne by the bidder.	
29.	Material of construction for all equipment/components shall be subject to BHEL/ End customer approval during detail engineering. Accordingly bidder shall consider MOC for all equipment/component as per best engineering practice, global standard and global references.	
30.	Bidder to provide sub vendor list and Bidder shall strictly adhere to BHEL/END CUSTOMER approved vendor list.	
31.	It shall be the complete responsibility of the successful bidders to obtain "Sub Vendor Approval" from END CUSTOMER for all equipments & components. Any delay in sub vendor's approval should not affect the project schedule. If any of the sub vendors does not have the approval of END CUSTOMER, the same may be replaced with another END CUSTOMER approved sub-vendor only, without any price implications to BHEL	
32.	<p>The modalities of inspection (Stage, Final, In-process) shall be finalized during detail engineering after submission of quality assurance plan (QAP). It shall be reviewed by END CUSTOMER & BHEL. Bidder shall follow the procedures of inspection as per the approved QAP. Bidder has to submit the following documents along with inspection call and if any other documents required as per approved QAP.</p> <ul style="list-style-type: none"> - Raw material inspection certificate - Internal test reports - Statutory certificates as required. - All inspection & testing shall be carried out based on the following documents: <ul style="list-style-type: none"> a. Relevant Standards 	

	PRODUCT STANDARD	TC-6-2743
	TURBINES & COMPRESSORS	Rev.No. 02
	HYDERABAD	SHT 16 OF 67
	<ul style="list-style-type: none"> b. Specifications c. Approved drawings d. Data Sheets e. Calibration certificate for all the measuring instruments f. Bidder should also coordinate in getting the MDCC's (Material Dispatch clearance certificate) and all types of IC's (Inspection Certificates) from the customer/customer's consultant along with BHEL. 	
33.	Minor Chipping i.e. up to 50 mm thk, micro leveling and providing shim plates for erection of equipment / item at site shall be in the scope of bidder.	
34.	During detail engineering, bidder to strictly adhere to BHEL/ END CUSTOMER drawing formats, document numbering, quality plan & FQP formats.	
35.	The identification and numbering of equipment, systems, items, etc. of supply, as well as of all documents and drawings shall be in accordance with the VGB guideline RDS-PP (Reference Designation System for Power Plants - KKS system).	
36.	Complete detail engineering drawings, calculations, selection of components etc. shall be reviewed & subject to approval of BHEL during detail engineering	
37.	Bidder shall furnish necessary inputs & drawings of all equipment in editable Auto CAD/ MS-Word /Excel format.	
38.	During detail engineering, successful bidder shall ensure flow of drawings/documents as per schedule. Any comments from BHEL should be addressed timely by the bidder.	
39.	Bidder to note that list above is not exhaustive and any work /items required for completing the smooth operation and ensuring satisfactory running of the machines till final hand over to the end user shall also be in the scope of the bidder.	
40.	<p>Bidder shall submit the signed and stamped copy of all the pages which constitutes this technical enquiry specification signed by authorized signatory and clearly mentioning each clause under following two categories to avoid any ambiguity in scope understanding & the scope division along with technical offer.</p> <ul style="list-style-type: none"> a. "Accepted without deviation and considered in scope of work" b. "Not considered in scope of work" 	
11.0	PACKING INSTRUCTIONS	
1.	<p>Proper packing to be ensured. Each package or shipping units shall be clearly marked or stenciled on at least two sides as follows.</p> <p style="text-align: center;">1X800MW NORTH CHENNAI THERMAL POWER STATION ENNORE, CHENNAI DISTRICT TAMILNADU, INDIA</p> <p>EPC CONTRACTOR: BHARAT HEAVY ELECTRICALS LIMITED, INDIA</p>	

	PRODUCT STANDARD TURBINES & COMPRESSORS HYDERABAD	TC-6-2743
		Rev.No. 02
		SHT 17 OF 67
	In addition, each package or shipping unit shall have the symbol painted in red on at least two sides of the package, covering one fourth of the area of the side.	
2.	<p>Indigenous Supply: Oxidation Blower & sub system assembly shall be wrapped in polythene bags & packed in a strong rigid wooden crate. Rain water should not enter into the Oxidation Blower internals during storage in the outer yard of power plant.</p> <p>Imported Supply: All imported supply (supplies from outside India) should be packed as per standard packaging norms.</p>	
3.	Equipment and process materials shall be packed and semi-knocked down, to the extent possible, to facilitate handling and storage and to protect bearings and other machine surfaces from oxidation. Each container, box, crate or bundle shall be reinforced with steel strapping in such a manner that breaking of one strap will not cause complete failure of packaging. The packing shall be of best standard to withstand rough handling and to provide suitable protection from tropical weather while in transit and while awaiting erection at the site.	
4.	Equipment and materials in wooden cases or crates shall be properly cushioned to withstand the abuse of handling, transportation and storage. Packing shall include preservatives suitable to tropical conditions. All machine surfaces and bearings shall be coated with oxidation preventive compounds. All parts subject to damage when in contact with water shall be coated with suitable grease and wrapped in heavy asphalt or tar impregnated paper.	
5.	Crates and packing material used for shipping will become the property of owner.	
6.	Packaging or shipping units shall be designed within the limitations of the unloading facilities of the receiving ports and the ship will be used. It shall be the bidder's responsibility to investigate these limitations and to provide suitable packaging and shipping to permit transportation to site.	
7.	Packing shall be part of the equipment cost and shall not be subject to return. The packing should ensure integrity and cohesiveness of each delivery batch of equipment during transportation. In case of equipment assemblies and unit's delivery in the packing of glass, plastics or paper the specification of packing with the material and weight characteristics are to be indicated.	
8.	<p>Each package should have the following inscriptions and signs stenciled with an indelible ink legibly and clearly:</p> <ol style="list-style-type: none"> a. Destination b. Package Number c. Gross and Net Weight d. Dimensions e. Lifting places f. Handling marks and the following delivery marking 	
9.	Separate packing has to be done for each unit. Each package or shipping units shall be clearly marked or stenciled on at least two sides as per the Dispatch Address given in the indent/enquiry. In addition, each package or shipping unit shall have the symbol painted in red on at least two sides of the package, covering one fourth of the area of the side.	

	PRODUCT STANDARD TURBINES & COMPRESSORS HYDERABAD	TC-6-2743
		Rev.No. 02
		SHT 18 OF 67
10.	Each part of the equipment which is to be shipped as a separate piece or smaller parts packed within the same case shall be legibly marked to show the unit of which it is part, and match marked to show its relative position in the unit, to facilitate assembly in the field. Unit marks and match marks shall be made with steel stamps and with paint.	
11.	Each case shall contain a packing list showing the detailed contents of the package. When any technical documents are supplied together with the shipment of materials no single package shall contain more than one set of such documents. Shipping papers shall clearly indicate in which packages the technical documents are contained.	
12.	The case number shall be written in the form of a fraction, the numerator of which is the serial number of the case and the denominator the total number of case in which a complete unit of equipment is packed.	
13.	Wherever necessary besides usual inscriptions the cases shall bear special indication such as “Top”, “Do not turn over”, “Care” , “Keep Dry” etc. as well as indication of the center of gravity (with red vertical lines) and places for attaching slings (with chain marks)	
14.	Marking for Safe handling: To ensure safe handling, packing case shall be marked to show the following: <ul style="list-style-type: none"> a. Upright position b. Sling position and center of Gravity position c. Storage category d. Fragile components (to be marked properly with a clear warning for safe handling) 	
15.	Each crate or package is to contain a packing list in a waterproof envelope. All items are to be clearly marked for easy identification against the packing List. All cases, packages etc. are to be clearly marked on the outside to indicate the total weight where the weight is bearing and the correct position of the slings are to bear an identification mark relating them to the appropriate shipping documents. All stencil marks on the outside of cases are either to be made in waterproof material or protected by shellac or varnish to prevent obliteration in transit.	
16.	The packing slip shall contain the following information: - Customer name, Name of the equipment, Purchase Order number with Date, Address of the delivery site, Name and Address of the Sender, Serial Number of Blower & accessories, BHEL item Code, Gross Weight and Net weight of Supplied items.	
17.	Prior to transport from manufacturer’s work to destination, components of the unit shall be completely cleaned to remove any foreign particles. Flange faces and other machined surfaces shall be protected by an easily removable rust preventive coating followed by suitable wrapping.	
18.	All necessary painting, corrosion protection & preservation measures shall be taken as specified in painting schedule. Supplier shall consider the coastal environment zone which is defined as “very severe” during final finishing/shipping.	
19.	Successful bidder shall furnish the detail packing /shipment box details with information like packing box size, type of packing, weight of each consignment, sequence no. of dispatch, no. of consignment for each deliverable item against each billing break up units/ billable blocks. Without these details the BBU shall not be approved during detail engineering. Also, complete billing break-up with above mentioned details shall be submitted within 10days	

	PRODUCT STANDARD	TC-6-2743
	TURBINES & COMPRESSORS	Rev.No. 02
	HYDERABAD	SHT 19 OF 67
	of LOI.	
20.	All items/equipment shall be dispatched in properly packed condition (i.e. no item shall be dispatched in loose condition such that it becomes difficult to store/identify its location at site at a later stage).	
21.	Cases which cannot be marked as above shall have metal tags with the necessary markings on them. The metal tags shall be securely attached to the packages with strong steel binding wire. Each piece, Skid, Case or package shipped separately shall be labelled or tagged properly.	
12.0	SUPERVISION OF ERECTION, TESTING AND COMMISSIONING	
1.	<p>The erection of Oxidation Blower will be done by owner as per Erection Manual and check List. However, the bidder shall make one visit per FGD system for the supervision of erection, pre-commissioning & post-commissioning check-up, start-up, testing and trial runs of all the items covered under the scope of supply.</p> <p>There will be one visits for the two blowers'. The bidder will be informed well in advance for the visit. Bidder shall include 6 working days per visit in the offer with minimum 1 visit. For 1 unit 6 working days must be included.</p> <p>BHEL shall conduct performance test of FGD package at site. Vendor shall provide supervision services for site performance test on per diem basis for each unit.</p>	
2.	TA/DA, boarding and lodging for bidder supervisor/ site engineers shall be borne by the bidder and shall be inclusive in supply portion.	
3.	Price comparison for evaluating the lowest bid will be considered all main supply, supervision of E&C charges and mandatory spares price all together.	
13.0	EXCLUSION	
	<p>The following work associated with the air blower will be by others:</p> <ul style="list-style-type: none"> a. Supply of main drive HT motor b. Civil foundations c. Walkways, platforms and ladders d. Element handling hoists 	
14.0	INSPECTION AND TESTING	
	The General inspection requirements to be considered are as below:	
1.	Bidder shall furnish written copies of shop production, fabrication and quality test procedures and drawings to be used on the Blowers for review by BHEL/ END CUSTOMER prior to manufacture.	
2.	The Bidder shall furnish MRT & Performance test procedure in line with international standard. The test procedure will be reviewed and approved by the BHEL/ END CUSTOMER.	
3.	Out of 2 Oxidation Blower, performance test of 1 No will be witnessed by BHEL/ TPI/ END CUSTOMER before dispatch of machine at the Bidder's works or where the test facilities are available. A notice of minimum three (3) weeks shall be given for witnessing the test.	
4.	The Bidder shall conduct performance test for the remaining 1 blower and submit the reports.	

	PRODUCT STANDARD	TC-6-2743
	TURBINES & COMPRESSORS	Rev.No. 02
	HYDERABAD	SHT 20 OF 67
5.	Final inspection and release by BHEL/ END CUSTOMER is a mandatory requirement unless specially waived.	
6.	A dynamic balancing certificate stating that the rotating assembly has been balanced dynamically shall be sent to BHEL/ END CUSTOMER within one (1) week of the successful completion of balancing.	
7.	Acceptance tolerance of actual versus guaranteed performance for capacity, Static head, efficiency and power absorbed shall be as per applicable standard.	
8.	Vibration levels shall be measured during shop running/performance tests.	
9.	Contract shaft seals shall be used during shop tests, unless the seal design is unsuitable for the shop-test condition.	
10.	Blower shall not be released for shipment, until shop tests data and performance tests curves have been approved by Owner.	
11.	Bidder should furnish performance guarantee as per applicable standard guarantee for the design, manufacture, material and safe operation of the equipment's.	
12.	Bidder shall arrange all calibrated gauges, Instruments during testing.	
13.	Mechanical running and the performance test shall be carried out. Bidder shall arrange Motor for the shop test and inspection.	
14.	The performance test may be carried out using air at shop and shall be converted to the design condition.	
15.	Inspection and testing will be done as per END CUSTOMER approved Quality Plan. In case of order placed on foreign Vendor, Vendor shall engage and appoint at their cost of any reputed third Party Inspection Agencies having international presence for carrying out inspection of equipment's and material at vendor's & sub vendors works. Sample QP(indicative) is attached as Annexure-X of TC62743 .	
15.0	PAINTING	
1.	Surface Preparation : Blast cleaning to Sa 2½ (Near white metal) with surface profile 35-50µm	
2.	Primer Coat : Two coats of red oxide Zn Phosphate (Alkyd base to IS 12744); 25 microns each coat	
3.	Finish: Two coats of Synthetic enamel long oil alkyd to IS2932; 35 microns each coat Shade: Light grey Shade no. 631 of IS:5 Total 70 µ	
4.	Total DFT – 120 microns	
5.	Rust preventive paint after inspection at shop floor before dispatch shall be in bidder's scope	
6.	Corrosion protection, coating and galvanizing, painting shall be taken care by the bidder. The	

	PRODUCT STANDARD	TC-6-2743
	TURBINES & COMPRESSORS	Rev.No. 02
	HYDERABAD	SHT 21 OF 67
	above painting schedule is tentative and shall be subject to approval of BHEL / END CUSTOMER during detailed Engg/after placement of PO.	
16.0	SPARES, TOOLS & TACKLES	
16.1	START UP & COMMISSIONING SPARES	
	Start-up & Commissioning Spares shall be part of the main supply of Oxidation blowers. Start-up & commissioning spares are those spares which may be required during the start-up and commissioning of the equipment/system. All spares required for successful operation till commissioning of Oxidation blowers shall come under this category. Bidder shall provide an adequate stock of such start up and commissioning spares to be brought by him to the site for the equipment erection and commissioning. The spares must be available at site before the equipment's are energized. These start-up & commissioning spare part list shall not be included in "Initial Spare Parts List".	
16.2	INITIAL SPARE PARTS (MANDATORY SPARES):	
	<p>Bidder shall quote for the "mandatory spares" as per the enquiry, and it will be considered for L1 evaluation. Initial spare parts items shall be handed over separately and shall not be mixed with the supply of the main equipment parts. Spares shall be sent in pre-decided lots in containers/secure boxes. All boxes/containers are to be distinctly marked in red color with boldly written "S" mark on each face of the containers. Spares shall not be dispatched before dispatch of corresponding main equipment's. Each item shall be labelled in English and be packed against damage and sealed to prevent deterioration from corrosion. The protection shall be sufficient for a minimum of 10 years' storage in a dry weatherproof building.</p> <p>All spares supplied under this contract shall be strictly inter-changeable with the parts for which they are intended for replacements. All the mandatory spares shall be manufactured along with the main equipment components as a continuous operation as per same specification and quality plan.</p> <p>All spares to be used during this contract shall be strictly inter-changeable with the parts for which they are intended for replacements.</p>	
16.3	RECOMMENDED SPARES	
	In addition to the spare parts mentioned above, the bidder shall also provide a list of recommended spares for 3 years of normal operation of the plant and should be independent of the list of the mandatory spares. Prices of recommended spares will not be used for evaluation of the bids. The price of these spares shall remain valid up to 6 months after placement of Notification of Award for the main equipment.	
16.4	SPECIAL TOOLS & TACKLES:	
	Any special tools & tackles required for the entire equipment to disassemble, assemble or maintain the units (One set for each unit), they shall be included in the quotation and furnished as part of the initial supply of the machine. List of special tools & tackles shall be decided by bidder as per his proven practice. When special tools are provided, they shall be packaged in separate, boxes with lugs and marked as "Special Tools for (tag / item number)." Each tool shall be stamped or tagged to indicate its intended usage. Levers and eye bolts for the removal of parts to be serviced shall be submitted with special tools.	
17.0	PERFORMANCE GUARANTEE	
	<p>All performance tests for blowers shall be carried out in accordance with any latest international codes/standards.</p> <p>1) Bidder shall furnish Performance guarantee for the design, manufacture, material, safe and trouble-free operation of the Oxidation Blower and its accessories</p>	

	PRODUCT STANDARD	TC-6-2743
	TURBINES & COMPRESSORS	Rev.No. 02
	HYDERABAD	SHT 22 OF 67
	<p>2) Capacity and head of the blower to be guaranteed as per Annexure-I of TC62743.</p> <p>3) The bidder shall guarantee 98% availability of equipment for a continues period of 120 days</p> <p>4) Noise level of blower train shall be ≤ 85 dB (A) at 1m horizontal distance from equipment/enclosures and 1.5m above operating floor is to be guaranteed.</p> <p>5) The overall shaft vibration levels for Integrally geared type centrifugal compressor shall be as per ISO7919-3. The overall shaft vibration for zone A/B shall be as per following equation In SI units: $A = 4800/\text{SQRT}(N)$ Where, A = amplitude of unfiltered vibration, in μm true peak to peak, N = maximum continuous speed, in rpm.</p> <p>6) Acceptance tests to be carried out as per the procedure defined by the bidder which shall be submitted for END CUSTOMER's approval.</p> <p>7) In the event that the performance test is unsuccessful in meeting performance guarantees, bidder shall take necessary remedial action at his cost and the performance test shall be repeated.</p>	
18.0	BID EVALUATION CRITERIA FOR POWER CONSUMPTION:	
1.	<p>POWER GUARANTEE Bidder to specify the guaranteed shaft power with zero positive tolerance per blower operating at the Guarantee point of clause 7.0 of this specification in their offer. This power value shall be used for loading and penalty criteria.</p>	
2.	<p>BID EVALUATION CRITERIA FOR POWER CONSUMPTION:</p> <p>Power consumption quoted by bidder shall be limited to the ceiling value specified below.</p> <p>The Lowest of the power consumption quoted by any qualified bidder shall be taken as the base or ceiling value. Bid prices of other bidders will be loaded for every KW excess over the ceiling value as per the formula given below.</p> <p>In case, Guaranteed Shaft power offered by the bidder exceeds the ceiling value specified above, his bid price will be loaded for excess power consumption as per the formula given below.</p> <p>Adjustment factor for excess power consumption in INR = $(\text{GPC}-\text{CV}) \times \text{PL} \times 2$ No's of Blowers</p> <p>GPC- Guaranteed Power Consumption quoted by bidder in KW</p> <p>CV- Lowest of the power consumption quoted by any bidder</p> <p>PL- Power Loading @ 2,35,360 INR /KW</p>	
19.0	LIQUIDATED DAMAGES FOR POWER CONSUMPTION	
1.	<p>If actual Power Consumption of blower during shop PG Test measured at compressor coupling for the Guarantee point exceeds the value guaranteed by the bidder., liquidated damages for shortfall in performance shall be deducted from contract price as per the formula given below</p>	

	PRODUCT STANDARD	TC-6-2743
	TURBINES & COMPRESSORS	Rev.No. 02
	HYDERABAD	SHT 23 OF 67
	<p>Liquidated damage deductible in INR = (GPC-APC) X P X 2 No's of Blowers</p> <ul style="list-style-type: none"> • GPC- Guaranteed Power Consumption quoted by bidder in KW • APC- Actual Power Consumption in KW • P- Penalty @ 2,35,360 INR/ KW <p>Penalty for short fall in performance as mentioned above shall be deducted from contract price. Such penalty shall be levied with limitation of total contract price.</p> <p>Since performance test is witnessed for the first blower, LD charges are applicable for remaining 1 No of blower based on performance result of first blower.</p>	
2	<p>Minimum Acceptance Level: 105% of Functional Guarantee Value. END CUSTOMER/ BHEL reserves the right to reject the equipment if actual power consumption exceeds the minimum acceptance level.</p>	
20.0	WARRANTY/ DEFECT LIABILITY	
1.	<p>The warranty period shall be 12 months from the date of completion of trail operation of each FGD. Provided that the successful bidder shall extend the provisions of this warranty to cover all repaired and replacement parts furnished under the warranty obligations hereunder, subject to the warranty period for the same being for a period of 24 months from the date on which replacement or renewal work is completed.</p> <p>The Defect Liability Period shall be twenty four (24) months commencing immediately upon COD of the FGD Plant.</p> <p>At the end of the Defects Liability Period, the contractor liability ceases except for latent defects. The contractor's liability for latent defects warranty shall be limited to a period of five (5) years from the end of Defects Liability Period. For the purpose of the this clause, the latent defects shall be the defects inherently lying within the material or arising out of design deficiency which do not manifest themselves during the Defects Liability Period.</p>	
2.	<p>In case of failure of the equipment to meet the guarantee, END CUSTOMER/BHEL reserves the right to reject the equipment. However, END CUSTOMER/ BHEL reserves the right to use the equipment until new equipment supplied by bidder meets the guaranteed requirement.</p>	
21.0	FIRST FILL OF CONSUMABLES:	
1.	<p>Bidder's scope shall also include supply and filling of all chemicals, reagents, resins, lubricants, grease, filters and consumable items for operation up to COD including top up requirements at the time of issuance of PAC/declaration of COD. All lubricants proposed for the plant operation shall be suitable for all operating and environmental conditions that will be met on site consistent with good maintenance procedures as instructed in the maintenance manuals.</p>	
2.	<p>Detailed specifications for the lubricating oil, grease, gases, servo fluids, control fluids, chemicals including items qualities and quantities required per month of the plant operation for the END CUSTOMER/BHEL's approval herein shall be furnished eighteen (18) months prior scheduled COD of the 1st unit. On completion of erection complete list of bearings/equipment giving their location and identification marks shall be furnished to END CUSTOMER along with lubrication requirements. All types of chemicals, consumables, lubricants and grease shall be readily obtainable locally and the number of different types shall be kept to a minimum. For each type and grade of lubricant recommended, bidder shall list at least three equivalent lubricants manufactured by alternative companies.</p>	

	PRODUCT STANDARD	TC-6-2743
	TURBINES & COMPRESSORS	Rev.No. 02
	HYDERABAD	SHT 24 OF 67
22.0	TRAINING	
	<p>Successful bidder shall provide comprehensive training for END CUSTOMER Engineering, O&M, Erection & Commissioning staffs at site covering all aspects of the Oxidation blower-Operation & Maintenance, Troubleshooting etc.</p>	
23.0	CONFLICT	
	<p>Bidder's equipment shall be designed for and shall meet the service, performance and minimum level of quality requirements specified. Bidder shall be solely responsible for advising BHEL in writing of any conflicts between the specifications and Bidder's design, including performance and levels of quality. Bidder agrees that its obligations, liabilities and warranties shall not be diminished or extinguished due to its meeting the requirements of the Specification.</p>	
24.0	DOCUMENTATION	
	<p>The Successful bidder shall submit necessary data, documents, reports (including lateral analysis report) and drawings for review, approval with requirements as specified in this specification.</p> <p>Drawings that are reviewed by the END CUSTOMER/BHEL will be returned to bidder with a transmittal letter with any comments and / or questions marked on the drawings or noted in the letter. All comments and questions must be resolved before resubmission of drawings / documents. If the design has not developed enough to resolve some of the comments or questions, bidder shall place a "hold" on those items or areas of design.</p> <p>END CUSTOMER / BHEL reserves the right to return drawings unprocessed to bidder if there exists any evidence that bidder has not acknowledged all comments and questions.</p> <p>All necessary GA drawings, sections, sub-assembly drawings, specifications of main and sub components and necessary set of operation & maintenance manual as asked by END CUSTOMER must be furnished by bidder in soft and hard copy forms. For all documents softcopy format shall be searchable pdf, however in addition all drawings, diagrams like P&IDS shall be supplied in ACAD or other editable format and all lists in Excel format. Further break up of technical documents will be discussed during finalization of the purchase contract.</p> <p>Unless agreed otherwise, ten (10) hard copies and five (05) sets of electronic copies of all documents are to be submitted in the English language. Electronic Copies shall be submitted in primary original data format (e.g. DOC, XLS, DWG) as well as in a printable non-proprietary document format (e.g. PDF). Especially P&IDs shall be submitted as DWG files and PDF files. Bidder to ensure submission of hard copies as per END CUSTOMER's requirement for all engineering drg/doc and for all subsequent revisions along with a soft copy through email to concerned project team. However all the engineering related information shall be furnished in soft form to BHEL.</p>	

	PRODUCT STANDARD TURBINES & COMPRESSORS HYDERABAD	TC-6-2743
		Rev.No. 02
		SHT 25 OF 67

25.0 PRICE SCHEDULE					
Sl No	Description	Material Code	Quantity	Unit Price	Total Price
01	2x100% Single stage, integrally geared, single or dual vane centrifugal type oxidation blowers complete with integral gearbox, lube oil system, instrumentation and accessories.	TC9762743016	2		
02	Impeller Assembly	TC9762743024	1		
03	Set of Bearings (Required 1No. each for complete replacement of all bearings in one Blower)	TC9762743032	1		
04	Suction air filter	TC9762743040	2		
05	Commissioning spares	TC9762743059	2		
06	Blower instrumentation spare- (Spare list as per Annexure V Philosophy)	TC9762743067	1		
07	Pre-commissioning / Commissioning supervision		Per Diem		
Total price for evaluation					

Remarks:

Vendor shall provide Per Diem rate for supervision of commissioning. This is inclusive of travel, boarding and lodging. 6 no of working days at site will be considered for evaluation purpose. Refer clause no. 12.0 for details

	PRODUCT STANDARD TURBINES & COMPRESSORS HYDERABAD	TC-6-2743
		Rev.No. 02
		SHT 26 OF 67

ANNEXURES:

ANNEXURE –3K

Provenness Criteria/Qualification Requirement (SUB-QR) for

Oxidation Blower Project Project: North Chennai (1X800 MW)

Clause No.

4.00.00 **QUALIFYING REQUIREMENTS FOR EQUIPMENTS/SYSTEMS**

4.01.00 **Provenness criteria for critical equipment, auxiliaries, systems and bought out items:**

Only Blower manufacturers can seek for Qualification and order will be placed on Blower Manufacturer only. The Bidder is required to meet the provenness criteria and/or qualification requirement for Oxidation Blower as per criteria stipulated below:

4.01.01 Oxidation Blowers for Flue Gas Desulphurisation (FGD) System offered by the Bidder shall be only from such manufacturer(s) who has previously designed (either by itself or under collaboration / licensing agreement), manufactured the respective equipment(s) of the type, application and minimum equipment rating as stipulated below such that the respective equipment(s) should have been in successful operation in at least one (1) plant for a period not less than one(1) year reckoned as on enquiry floating date.

Name of Equipment	Type of Equipment	Application	Equipment Rating
Oxidation Blowers	Single stage integrally geared centrifugal compressor	Wet Limestone based FGD application in Coal fired power plant or any other process application	80% of the flow & 100% of the head of the offered Oxidation Blower

Bidder shall offer and supply only the type of the above equipment(s) for which he himself is qualified

4.01.03 A JV / Subsidiary Company formed for manufacturing and supply of equipment(s) as listed at clause no. 4.01.01 above in India, can also manufacture such equipment(s), provided that it has a valid collaboration or licensing agreement for design, engineering, manufacturing of such equipment(s) in India with a qualified equipment manufacturer who meets the requirements stipulated at clause 4.01.01 above (or the technology provider of the qualified equipment manufacturer) for the respective equipment(s). Before taking up the manufacturing of such equipment(s), the bidder/ his sub-vendor(s) must create /have created manufacturing facilities at his works as per collaborator's/licenser's design, manufacturing and quality control system for such equipment(s).

	PRODUCT STANDARD TURBINES & COMPRESSORS HYDERABAD	TC-6-2743
		Rev.No. 02
		SHT 27 OF 67

Further, in such a case, such qualified equipment manufacturers should have, directly or indirectly through its holding company/ subsidiary company, at least 26% equity participation in the Indian Joint Venture Company/ Subsidiary Company, which shall be maintained for a lock-in period of seven (7) years from the date of incorporation of such Joint Venture/ Subsidiary or upto the end of defect liability period of the contract, whichever is later.

4.01.04 In case the Bidder or the proposed sub-vendor is not manufacturer of proven Oxidation Blowers as per clause 4.01.01 above but is a manufacturer of Blowers/compressors for minimum 50 NM³/min capacity, the Bidder or the proposed sub-vendor can also manufacture Oxidation Blowers, provided it has collaboration or valid licensing agreement for design, engineering, manufacturing, supply of such Oxidation Blowers in India with such manufacturer who meet the requirements stipulated at clause 4.01.01 above for the Oxidation Blowers. Before taking up the manufacturing of such equipment, the bidder/ his sub-vendor must create /have created manufacturing facilities at his works as per collaborator's /licenser's design, manufacturing and quality control system for such equipments.

4.01.05 Before taking up the manufacturing of such equipment(s) as per clause 4.01.01,4.01.03,4.01.04 above, the Bidder must create (or should have created) manufacturing and testing facilities at its works as per Collaborator / licensor's design, manufacturing and quality control system for such equipments duly certified by the Collaborator / licensor. Further, the Collaborator / Licensor shall provide (or should have provided) all design, design calculation, manufacturing drawings and must provide (or should have provided) technical and quality surveillance assistance and supervision during manufacturing, erection, testing, commissioning of equipments.

Note to clause 4.01.01

Whenever the term 'coal fired' is appearing above, "Coal" shall be deemed to also include bituminous coal/brown coal/lignite.

Bidder shall submit the Annexure 3K enclosed along with Supporting Documents. Also, Bidder has to submit Reference list of Plants where Oxidation Blowers have been supplied.

	PRODUCT STANDARD TURBINES & COMPRESSORS HYDERABAD	TC-6-2743
		Rev.No. 02
		SHT 28 OF 67

Oxidation Blowers: We declare that we/ our Sub-vendor, have designed (either by itself or under collaboration/ licensing agreement), *manufactured/ * got manufactured and supplied at least one (1) number of oxidation blower of minimum 80% of the flow and 100% of head of the offered blower working in FGD application or any other process application and which has been in successful operation for minimum one (1) year as reckoned as on enquiry floating date as per the details furnished below:

Sl. No.	Description	Reference Work
1.	Name of the reference plant & location:	
2.	Client name and his address: Oxidation	
3.	No. of units and capacity in MW of unit:	
4.	Whether power plant is coal fired	-*Yes/*No
5.	Whether operating in a Wet Limestone based FGD application in Coal fired power plant	-*Yes/*No
6.	Name of equipment manufacturer & address:	
7.	Date of commission of the <u>equipments</u> :	
8.	Model no. of the equipment:	
9.	Brief Technical particulars of the <u>equipments</u> :	
10.	Flow-Nm ³ /h
11.	Head- mmWC
12.	Whether the equipment(s) are in successful operation in atleast one (01) plant for a period not less than one (01) year reckoned as on the date of consideration for approval but not later than six months to award date of contract to the Main bidder	-*Yes/*No
13.	Flue gas Desulphurization system details:	*Technical extract/ *paper letter/ *email/ *Drawing from user or *contract document or *scheme or *any document in public domain enclosed at annexure....to Attachment-3K
14.	Scope of Work:	*Letter of Award or *Contract or *P.O. enclosed at Annexure.....to Attachment-3K
15.	Performance details:	*Certificate/*Letter/*E-mail from End user enclosed at Annexure.....to Attachment-3K

* Strike off whichever is not applicable.

Signature of authorized signatory.....

	PRODUCT STANDARD TURBINES & COMPRESSORS HYDERABAD	TC-6-2743
		Rev.No. 02
		SHT 29 OF 67

ANNEXURE –I QUALIFICATION REQUIREMENT.

The Bidders are required to meet the Qualification Requirement (QR) for Oxidation Blowers as per criteria stipulated below and necessary documents evidence requirement as per Annexure-3K.

System offered by the bidder shall be only from such manufacturer(s) who has previously designed (either by itself or under collaboration/ licensing agreement), manufactured/ got manufactured the equipment of the type, application and minimum equipment rating as stipulated below such that the equipment should have been in successful operation in at least 1 plant for a period not less than 1 year reckoned as on enquiry floating date.

Name of equipment	Type of equipment	Application	Equipment rating
Oxidation Blowers	Single stage integrally geared centrifugal compressor	Wet Limestone based FGD application in coal fired power plant or any other process application	80% of the flow & 100% of head of the offered oxidation Blower

SIGNATURE OF BIDDER -----

NAME -----

DESIGNATION -----

	PRODUCT STANDARD TURBINES & COMPRESSORS HYDERABAD	TC-6-2743
		Rev.No. 02
		SHT 30 OF 67

ANNEXURE –II- TECHNICAL DATA SHEET

Sl. No	Description	Data
1.0	GENERAL	
	a. Client	: BHEL-HPEP Hyderabad
	b. Project	: North Chennai (1X800 MW)
	c. Ultimate Customer	: TANGEDCO
	d. Location	: Thiruvallur District Tamilnadu, India
	e. Service	: Continuous
	f. Installation	: In-door
	g. No of Blowers for each unit	: 1 Working + 1 Standby
	h. Total number of Blowers	: Unit-1 - 2 No's
2.0	MANUFACTURER DETAILS	
	a. Model	:
	b. Type	: Single stage integrally geared centrifugal compressor
	c. Type of Driver	: As per specification
	d. Area classification	: Safe
	e. No of Stage	: Applicable/ Not Applicable
3.0	OPERATING CONDITION	
	a. Gas composition % by weight / Mole percent	: Atmospheric air
	b. Solids at suction g/m ³	: As per ambient condition
	c. Relative humidity at suction %	: As per ambient condition
	d. Molecular weight	: As per ambient condition
	e. Specific weight at suction Kg/m ³	: As per ambient condition
	f. Capacity at suction Nm ³ / Hr	: As per clause 5.0
	g. Suction pressure KPa	: As per clause 5.0
	h. Discharge pressure mmWc	: As per clause 5.0
	i. Differential Pressure	: Bidder to confirm
	j. Suction temperature Deg C	: Ambient
	k. Discharge temperature Deg C	: <70
4.0	PERFORMANCE DATA	
	a. Capacity Nm ³ /Hr	: #
	b. Static efficiency %	: #
	c. BKW Normal / Maximum KW	: #
	d. BKW at minimum suction temperature KW	: #
	e. Motor rating KW	: #
	f. Motor Speed rpm	: #
	g. Discharge pressure static (inclusive of losses) mmWc	: #
	h. Differential pressure (inclusive of losses) mmWc	: #
	i. Speed Maximum/ Normal/Minimum	: #
	j. Noise level	: #
	k. Performance curve	: #
5.0	CONSTRUCTION DATA	
	a. Manufacturer	:



**PRODUCT STANDARD
TURBINES & COMPRESSORS
HYDERABAD**

TC-6-2743

Rev.No. 02

SHT 31 OF 67

	b. Model No.	:	#
	c. Suction	:	Single
	d. Suction Rating / Size	:	#
	e. Discharge Rating / Size	:	#
	f. Type of rotor	:	#
	g. Size of rotor Dia mm	:	#
	h. Journal bearing: Type / Size:	:	#
	i. Thrust bearing: Type / Size:	:	#
	j. Bearing cooling required	:	Yes / No - Bidder to confirm
	k. Cooling water required	:	Bidder to confirm the quantity
	l. Type of drive	:	As per specification
	m. Shaft seal	:	Packing / Rubber seal
	n. Size / Code	:	#
	o. Type of coupling	:	#
	p. Service factor	:	#
	q. GD ² at drive shaft end	:	#
	r. Rotation viewed from coupling end	:	Clock wise / Counter clock wise
	s. Fluid Coupling	:	Yes / No - Bidder to confirm
	t. Fluid Coupling make	:	#
	u. Fluid Coupling control	:	#
	v. Suction filter	:	Required
	w. Degree of filtration	:	#
	x. Base plate common to Blower. Inboard bearing housing and fluid coupling & Motor	:	Yes / No - Bidder to confirm
	y. Total weight kg	:	#
	z. Maximum Erection weight kg	:	#
6.0	MATERIALS		
	a. Casing	:	#
	b. Rotor	:	#
	c. Shaft	:	#
	d. Packing Seal	:	#
	e. Suction filter elements/ housing	:	#
	f. Base frame	:	#

Note - Vendor to full up the columns marked with “ # “

SIGNATURE OF BIDDER -----

NAME -----

DESIGNATION -----

	PRODUCT STANDARD TURBINES & COMPRESSORS HYDERABAD	TC-6-2743
		Rev.No. 02
		SHT 32 OF 67

ANNEXURE III- SCHEDULE OF GUARANTEES

Sl. No	Description	Data
1.	Rated capacity of Blower Nm³/hr	:
2.	Total head at design capacity mmWc	:
3.	Guaranteed power consumption at rated capacity & head kW	:
4.	Noise level at a distance of 1.0 meter from the equipment at site and 1.5 m above operating floor dB(A)	:
5.	Maximum vibration (peak to peak amplitude at site) microns	:
6.	Equipment Availability (%)	:

SIGNATURE OF BIDDER -----

NAME -----

DESIGNATION -----

	PRODUCT STANDARD TURBINES & COMPRESSORS HYDERABAD	TC-6-2743
		Rev.No. 02
		SHT 33 OF 67

ANNEXURE IV- VENDOR TO PROVIDE THE LIST OF COMMISSIONING SPARES

Sl. No.	Description	Quantity
1.		
2.		
3.		
4.		
5.		

Qty will be Number or Set as applicable

- Vendor to identify each and every item which they consider as commissioning spares. Each and every part that is considered to fall under guarantee clause shall be indicated in this list.
- Rubber items which are having a **Shelf-Life** will also be considered as wear item.

SIGNATURE OF BIDDER -----

NAME -----

DESIGNATION -----

	PRODUCT STANDARD TURBINES & COMPRESSORS HYDERABAD	TC-6-2743
		Rev.No. 02
		SHT 34 OF 67

ANNEXURE V- VENDOR TO PROVIDE APPLICABLE MANDATORY INSTRUMENTATION SPARE LIST AS PER FOLLOWING SPARE INSTRUMENTATION PHILOSOPHY:

Vendor shall submit the bill of material of each item on mandatory spare, indicating the quantity used in main as well as spares.

S.NO	OXIDATION BLOWER INSTRUMENT SPARE ITEM DESCRIPTION / SPARE PHILOSOPHY	QTY
1	ALL TYPE OF TRANSMITTERS INCLUDING SENSORS.	10% OR 1 NO. OF EACH TYPE AND MODEL WHICHEVER IS MORE.
2	TEMPERATURE ELEMENTS	10% OR 2 NO. OF EACH TYPE AND LENGTH, WHICHEVER IS MORE.
3	TEMPERATURE TRANSMITTERS	10% OF EACH TYPE AND LENGTH
4	LIMIT SWITCHES FOR ISOLATION VALVES	2 NO. OF EACH TYPE
5	LOCAL INDICATORS LIKE TEMPERATURE GAUGES, PRESSURE GAUGES, DIFFERENTIAL PRESSURE GAUGES, FLOW GAUGES, FLOW METERS ETC.,	5% OR 1 NO. OF EACH MAKE, MODEL AND TYPE WHICHEVER IS MORE.
6	ANY OTHER INSTRUMENT (FLOW TRANSMITTER, DENSITY METER) (AS APPLICABLE)	10% OR 1 NO. OF EACH TYPE AND MODEL WHICHEVER IS MORE
7	VALVES OF ALL TYPES AND MODELS	10% OR 1 NO. OF EACH TYPE, CLASS, SIZE AND MODEL WHICHEVER IS MORE.
8	2 WAY, 3WAY, 5WAY VALVE MANIFOLDS	10% OR 1 NO. OF EACH TYPE, CLASS, SIZE AND MODEL WHICHEVER IS MORE.
9	FITTINGS	10% OR 1 PACKET OF EACH TYPE, CLASS, SIZE AND MODEL WHICHEVER IS MORE.
10	PURGE METERS	5% OF EACH MODEL OR 1 NO. WHICHEVER IS MORE.
11	FILTER REGULATORS	20% OF EACH MODEL OR 2 NOS. WHICHEVER IS MORE.
12	PNEUMATIC AND ELECTRO-HYDRAULIC ACTUATOR ASSEMBLY	10% OR 1 NO. OF EACH TYPE, MODEL AND RATING, WHICHEVER IS MORE.
13	VALVE TRIM (INCLUDING CAGE, PLUG, STEM, SEAT RINGS, GUIDE BUSHINGS ETC.)	1 SET FOR EACH TYPE OF CONTROL VALVE.
14	DIAPHRAGMS, O' RINGS, SEALS ETC. OF ALL TYPES MAKE ETC.	100%

	PRODUCT STANDARD TURBINES & COMPRESSORS HYDERABAD	TC-6-2743
		Rev.No. 02
		SHT 35 OF 67

15	PRESSURE GAUGES OF ALL TYPES, MAKE, RATING ETC.	10% OR 2 NOS. OF EACH TYPE WHICHEVER IS MORE
16	SOLENOID VALVES (IF APPLICABLE)	10% OR 2 NOS. OF EACH TYPE WHICHEVER IS MORE
17	POSITIONER UNITS (COMPLETE UNIT) & ACCESSORIES (LINK ASSEMBLY)	10% OR 1 NO. OF EACH TYPE WHICHEVER IS MORE
18	PNEUMATIC AIR-FILTER/REGULATOR OF EACH TYPE, MAKE RATING ETC.	10% OR 2 NOS., WHICHEVER IS MORE
19	AIR LOCK RELAYS	10% OR 2 NOS. OF EACH TYPE WHICHEVER IS MORE

ANNEXURE –VI: LIST OF DEVIATIONS/EXCEPTIONS TO THE ENQUIRY DOCUMENT

Sl No	Clause No	Page No	Description of Deviation

Note- 1. Supplier shall submit this form indicating technical deviation if any, indicating each clause no. If there is no technical deviation, Supplier shall submit this form indicating "NO DEVIATION"

2. Deviation Listed elsewhere other than the above format shall not be considered for offer evaluation.

SIGNATURE OF BIDDER -----

NAME -----

DESIGNATION -----

	PRODUCT STANDARD TURBINES & COMPRESSORS HYDERABAD	TC-6-2743
		Rev.No. 02
		SHT 36 OF 67

ANNEXURE – VII: REFERENCE LIST as per format shown below.

S.No	Project Name , Customer & Plant capacity	Coal fired Yes/ No	Wet Lime stone Based FGD Yes/ No	Model	Capacity Nm ³ /hr.	Head mm Wc	Speed rpm	Year of Comm g	Qty

SIGNATURE OF BIDDER -----

NAME -----

DESIGNATION -----

	PRODUCT STANDARD TURBINES & COMPRESSORS HYDERABAD	TC-6-2743
		Rev.No. 02
		SHT 37 OF 67

ANNEXURE –VIII: DOCUMENTS TO BE SUBMITTED ALONG WITH THE OFFER

Sl. No.	Description	Purpose
1.	Annexure to qualification requirements : Attachment -3K	Qualification Requirement (QR)
2.	Reference plant details of similar or higher capacity oxidation blower supplied as per Annexure-VI	Qualification Requirement (QR)
3.	Proforma Invoice of Supply	Consideration of Bid
4.	Proforma Invoice of Mandatory Spares	Consideration of Bid
5.	Proforma Invoice for Supervision of Erection & Commissioning	Consideration of Bid
6.	Seal & Sign of bidder on all pages of specification	Technical Evaluation of Bid (TEB)
7.	Filled Data Sheets of & All accessories as per Annexure-II	TEB
8.	Deviation List (if any) as per Annexure-V	TEB
9.	Schedule of Guarantee as per Annexure-III	TEB
10.	Blower & Motor Sizing Calculation	TEB
11.	GA drawing including cross sectional view & BOM of Oxidation Blower	TEB
12.	P & ID diagram of oxidation blower & Lube oil system	TEB
13.	Performance curves i. Flow v/s Total Pressure ii. Flow v/s Efficiency iii. Flow v/s Power consumption iv. Torque v/s Speed curve for motor selection	TEB
14.	Required Electric power & other Utility List	TEB
15.	Make of all bought out items & sub vendor list	TEB
16.	Quality Plan	TEB
17.	List of Start-up & Commissioning Spares	TEB
18.	List of Special Tools	TEB
19.	Delivery Schedule	TEB
20.	Catalogue	TEB
21.	Price bid	Price Bid

SIGNATURE OF BIDDER -----

NAME -----

DESIGNATION -----

	PRODUCT STANDARD TURBINES & COMPRESSORS HYDERABAD	TC-6-2743
		Rev.No. 02
		SHT 38 OF 67

ANNEXURE –IX: DOCUMENTS TO BE SUBMITTED AFTER AWARD OF CONTRACT

Sl. No.	Description	Handing over of Documents after Contract (in weeks)	Purpose
1.	Utility Consumption & Lubricating Oil List	2	Customer Approval
2.	Foundation Drawing, Anchor Bolts, static & dynamic details	2	Customer Approval
3.	GA drawing including cross sectional view of Oxidation Blower & Accessories with bill of material (in PDF & Autocad format)	2	Customer Approval
4.	P&ID drawing of Oxidation Blower & Lube Oil System in PDF & AUTOCAD format	3	Customer Approval
5.	Filled Data Sheets of Oxidation Blower & All accessories	3	Customer Approval
6.	Quality Plan with Inspection & Performance Test Procedure at site	3	Customer Approval
7.	Blower & HT Motor Sizing Calculation	4	Customer Approval
8.	Performance curves i. Flow v/s Total Pressure ii. Flow v/s Efficiency iii. Flow v/s Power consumption iv. Torque v/s Speed curve for motor selection	4	Customer Approval
9.	Motor Rating in Kw	4	Customer Approval
10.	Sub vendors List	4	Customer Approval
11.	Manufacturing Schedule	4	Customer Approval
12.	List of Special Tools	8	E&C
13.	List of Start-up & Commissioning Spares	9	E&C
14.	Required Electric power	10	E&C
15.	Pre- Commissioning Check List	10	E&C
16.	Installation & assembly procedure	10	E&C
17.	Erection & Commissioning Schedule	10	E&C
18.	Recommended Repair Procedure	10	E&C
19.	Operation and Maintenance Manual (10 hardcopies and 5 electronic copies in English)	10	E&C
20.	Electrical Load List with Single Line Diagram	10	BHEL Review
21.	Control Logic of Oxidation Blower	10	BHEL Review
22.	Catalogue	10	BHEL Review
23.	Proforma Packing List	12	Dispatch

SIGNATURE OF BIDDER -----

NAME -----

DESIGNATION -----

	PRODUCT STANDARD TURBINES & COMPRESSORS HYDERABAD	TC-6-2743
		Rev.No. 02
		SHT 39 OF 67

ANNEXURE-X:

Refer to various clauses of inspection and Testing. Sample QP enclosed.

SIGNATURE OF BIDDER -----

NAME -----

DESIGNATION -----

	PRODUCT STANDARD	TC-6-2743
	TURBINES & COMPRESSORS	Rev.No. 02
	HYDERABAD	SHT 40 OF 67

INSPECTION AND TESTING REQUIREMENT

Sl.No	Annexure to Enquiry no:	Date
	BHEL/ Customer Requirement	##Specific confirmations by the manufacture
1	Quality Plan Requirement:	
	(i) MQP (Manufacturing Quality Plan) shall be submitted in attached format for BHEL/ Customer review & approval. Typical MQP is attached for indicative purposes for guidance & use.	
	(ii) MQP shall invariably cover w.r.t Inward inspection including on Raw material Procurement, In process and Final inspection in elaborated way/ details.	
	(iii) Bidder shall also to give specific confirmation that on need basis, their competent officials shall visit to BHEL/ customer for finalization of Quality plan including test procedure/methodology during pre-award / post-award approval / detailed engineering in the event of an order.	
	(iv) No deviation on BHEL/ Customer approved MQP is acceptable.	
	(v) Bidder shall agree to submit all cross referred documents other than codes/standards to BHEL/ Customer/ Consultant.	
	Important Notes shall be included in M QP : (a) Latest revision of Standards & Specification shall apply. Only International Standards are applicable. Indian & Chinese Standards are not applicable (b) Materials shall be procured in compliance to Functional Technical Specification. (c) Inspection shall be in compliance with Approved Quality Control Procedure for the Product. (d) NDT shall be carried out by Qualified Personnel with compliance to Approved NDT Procedures and Acceptance Norms, as per ASME Section V. (e) Gauges and measuring Instruments, with valid calibration only shall be used. (f) Cleaning and Painting of products shall be carried out as per Approved Painting Schedule. (g) Finished Products shall be packed to comply with Approved Packing Schedule. (h) Welding shall be carried out by Qualified Personnel with compliance to Approved NDT Procedures and Acceptance Norms, as per ASME Section V.	
2	Domestic / Inland Inspection will be carried out by BHEL/ BHEL appointed Third Party Inspection Agency (TPIA) / Customer/ Customer Appointed Inspection Agency/ Consultanat. This is applicable for all Stage inspection and Final Inspection identified as "W" - Witness or "CHP" - Customer Hold Point as per customer approved Quality Plan/ Technical specification / Approved Drawing/ Approved Data sheet / Scheme / PID / PFD / SLD (Process Instrumentation Diagram / Process Flow Diagram / Single Line Diagram) etc (As applicable).	
3	Inspection Agency for Foreign Bidders and also for Indian Bidder but importing from Foreign Sources: (1) Any one of the following Third Party Inspection Agency (TPIA) shall be appointed by the bidder and same shall be furnished by the bidder in techno commercial bid itself. (2) The details of TPIA with contact details like Name of the official, Phone no, Email id shall also to be submitted during pre/ post award. However cost for such inspection agency shall be borne by the bidder only. Inspection charges for such inspection agency shall be indicated separately so that if BHEL/ Customer is undertaking the inspection by on their own, then these charges non claimable by the bidder. List of TPIA 1.M/s Bureau Veritas 2.M/s TUV-Nord 3.M/s TUV-SUD 4.M/s TUV Rheinland 5.M/s Lloyds Register 6. M / s DNV	



**PRODUCT STANDARD
TURBINES & COMPRESSORS
HYDERABAD**

TC-6-2743

Rev.No. 02

SHT 41 OF 67

Sl.No	BHEL / Customer Requirement	## Specific confirmations by the manufacture
4	Stage Inspection during manufacturing Process : Stage Inspection during manufacturing shall be carried out as per approved quality plan and all necessary documents shall be provided for review, verification and clearance for further processing. This inspection call shall be given well in advance (atleast 2 weeks before) to TPV Bidder's own inspection agency to avoid delay in the manufacturing processes.	
5	Inspection before despatch for domestic supplier : Inspection before despatch at supplier's works shall be carried out by BHEL/BHEL appointed inspection agency. Inspection shall be done as per approved Quality plan/ Technical specification/ Approved Drawing/ Approved Data sheet .	
6	Inspection at Foreign Source/ Supplier: (a) As in sl no: 3, shall be ensured without fail (b) No material/ Items shall be despatched without getting the written communication from BHEL/ Customer Inspection carried out by BHEL/BHEL appointed Third Party Inspection Agency (TPIA) / Customer/ Customer Apointed Inspection Agency/ Consulatnat. This is applicable for all Stage Inspection and Final Inspection identified as "W" - Witness or "CHP" - Customer Hold Point as per customer approved Quality Plan/ Technical specification / Approved Drawing/ Approved Data sheet / Scheme / PID/ PFD / SLD (Process Instrumental Diagram / Process Flow Diagram / Single Line Diagram) etc (As applicable). Inspection before despatch for Foreign supplier : Inspection before despatch at supplier's works shall be carried out by bidder appointed inspection agencies having International presence at vendors and or vendor's sub vendor works. Inspection shall be done as per approved Quality plan/ Technical specification/ Approved Drawing/ Approved Data sheet by TPJA mentioned in Sl no: 03 at supplier's cost.	
7	Painting shall be done strictly as per BHEL/ Customer approved painting schedule / scheme only. Paint Thickness / Paint shade shall be ensured as per BHEL/ Customer approved painting schedule / specification / data sheet etc. No deviation is acceptable unless otherwise accepted by BHEL/Customer in writing. Any conflict if any among BHEL/ Customer approved painting schedule / Spec / data sheet etc shall be brought to the notice to BHEL well in advance before proceeding including the BOI being procured for assy / skid like motors etc	
8	Specific conformation for document package in the event of an order (2 Hard copies & soft copy in PDF file) is to be given containing the following with proper linkages (I) Index Sheet (II) MOP/ ROP/ Endorsement Sheet (As applicable) (III) TCs Identified by BHEL/ Customer for record for "CHP" / "W" and Verification portion ("V") as given in approved OP. (iv) Final inspection report + TC including Chemical + Mechanical + HT + NDT etc (v) Third party inspection report + TC (vi) Customer CHP/ MDCC (vii) Type test / Performance Test reports conducted (viii) Type test / Performance Test approval/ clearance obtained from BHEL/ Customer (ix) BOM with As Build Drgs with actual make / rating used with BHEL/ customer approved drawings.	
9	Packing / Seaworthy Packing shall be as per BHEL Packing schedule / approved drg / sketch. This shall be ensured to take care tarnist / handling / transhipment In Road / Sea / Air. Photographs are to be submitted for BHEL review before despatching the material as per contract conditions.	
10	Outsourcing of test facilities: Bidder shall ensure all the testing facilities in house. However if any of the test facilities are not available with successful bidder, then bidder shall ensure the same at NABL accredited third party lab / Govt / Govt Lab for major testing such as NDT, Electrical & Mechanical testing.	
11	Important Note: No deviation on the above requirement 01 to 10 is acceptable w.r.t Quality Requirement and those offers not meeting these specific customer requirement is liable for rejection and hence the bidder shall submit all the required documentary evidances in the offer itself.	
12	## Necessorily to be filled up by the bidder at the time of offer itself otherwise the offer may not be considered w.r.t Quality Requirement being customer specific requirement.	



**PRODUCT STANDARD
TURBINES & COMPRESSORS
HYDERABAD**

TC-6-2743

Rev.No. 02

SHT 42 OF 67

SAMPLE QUALITY PLAN

 Ranipet	MANUFACTURER'S NAME AND ADDRESS M/S BHEL: BAP: RANIPET 632 406 TAMIL NADU		STANDARD QUALITY PLAN										
	ITEM: OXIDATION BLOWER SYSTEM: FGD							QP NO FGS:722					
								REV. NO: 00					
								DATE: 12.02.2019					
							PAGE NO: Page 1 of 2						
SL. NO	COMPONENT & OPERATIONS	CHARACTERISTICS	CLASS	TYPE OF CHECK	QUANTUM OF CHECK		REFERENCE DOCUMENT	ACCEPTANCE NORMS	FORMAT OF RECORD	AGENCY			REMARKS
					M	B				M	C	N	
1.	2.	3.	4.	5.	6.		7.	8.	9.	D*	** 10.		11.

1.1	Blower parts – (Casing Impeller Shaft etc.)	Chem.& Mech. Dimensions Surface Defects	MA MA	Review of MTC Measurement Visual	1/Heat 100% 100%		Appd. Dwg./Datasheet	TC & IR	√	P P P	V - -	V - -		
1.2	Shaft	UT	MA	Testing	100%	ASME Section-V	Tech. Spec./ Manufacturer UT Procedure	UT Report	√	P	V	V		
2.0	CASING													
2.1	Machining of Components	Dimensions Surface Defects	MA	Measurement Visual	100% 100%		Appd.Dwg.	IR		P	-	-		
2.2	Hydro test of Casing	Hydro test 1.5times of Max work pr for 30 min	MA	Measurement & Visual	100%	Appd. Dwg	No leakage	IR	√	P	V	V		
3.0	ROTATING COMPONENTS													
3.1	Machining of components	Dimensions Surface Defects(Rotor & Shaft)4	MA	Measurement MT/PT	100% 100%		Appd. Dwg.	IR		P	V	V		
3.2	Assembly	Dimensions Completeness	MA	Measurement Visual	100% 100%		Appd. Dwg.	IR		P P	-	-		
3.3	Rotor Assembly	Dynamic balance test	MA	Measurement Visual	100%	ISO 1940	G 2.5	IR	√	P	V	V		
4.0	Blower Inspection													
4.1	Assembly	Dimensions, Completeness	MA	Measurement Visual	100%	100%	Appd. Dwg.	IR	√	P	W	W	Inspection at manufacturer works. *1 No. for NTPC 100% for	
4.2	Performance Test	Volume, Power & Discharge Pressure	MA	Measurement	100%	100%	ASME PTC10	Approved data sheet / drawing	TR	√	P	W		W
4.3	Mechanical Run	Noise	MA	Measurement	100%	100%	ANSI S5.1:1971	-DO-	TR	√	P	W		W

LEGEND: * RECORD, IDENTIFIED WITH "TICK" (√) UNDER COLUMN 'D' SHALL BE SUBMITTED TO CUSTOMER AS A QA DOCUMENTATION PACKAGE.
M: MANUFACTURER / SUB SUPPLIER, **C:** MAIN CONTRACTOR(BHEL)/BHEL AIA
N: CUSTOMER/CONSULTANT **P:** PERFORM **W:** WITNESS **V:** REVIEW OF RECORDS
MA: MAJOR AND **MI:** MINOR

PREPARED BY

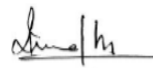

Rakesh Kumar Madhu,(SEr/QA)

REVIEWED & APPROVED BY



K C Gandhi Parimalam,(DGM/QA)



**PRODUCT STANDARD
TURBINES & COMPRESSORS
HYDERABAD**

TC-6-2743



Rev.No. 02

SHT 43 OF 67

 Ranipet	MANUFACTURER'S NAME AND ADDRESS	STANDARD QUALITY PLAN												
	M/S BHEL: BAP: RANIPET 632 406 TAMIL NADU	ITEM: OXIDATION BLOWER SYSTEM: FGD						QP NO	FGS:722					
							REV. NO:	00						
							DATE:	12.02.2019						
							PAGE NO:	Page 2 of 2						
SL. NO	COMPONENT & OPERATIONS	CHARACTERISTICS	CLASS	TYPE OF CHECK	QUANTUM OF CHECK		REFERENCE DOCUMENT	ACCEPTANCE NORMS	FORMAT OF RECORD		AGENCY			REMARKS
					M	B				D*	M	C	N	
1.	2.	3.	4.	5.	6.		7.	8.	9.	D*	** 10.			11.

	Test	Vibration Level	MA	Measurement	100%	100%	ISO 10816-7	-DO-	TR	✓	P	W	W	BHEL
		Bearing temperate rise,	MA	Measurement	100%	100%	Approved Drawing /Data Sheet		TR	✓	P	W	W	
5.0	BOUGHT-OUT PARTS (Gear Box)													
5.1	Heat Treatment of Gear Wheel	Hardness	MA	Measurement	100%		Approved Data Sheet/Drawing		TR	✓	P	V	V	
5.2	Assembly	Dimensions Completeness	MA	Measurement Visual	100%	100%	Appd.Dwg.		IR		P	-	-	
6.0	FINAL BLOWER PACKAGE INSPECTION													
6.1	Final Complete Assembly	Dimensions, Completeness	MA	Measurement Visual	100%	01 No	Appd. Dwg		IR	✓	P	W	V	
7.0	PAINTING													
7.1		Surface treatment and inspection	MI	Visual	100%		NTPC Approved Painting Schedule		IR	✓	P	V	-	
7.2		Paint Quality - Colour & DFT Check	MI	Visual Measurement	10%				IR	✓	P	V	-	
8.0	Review of QA Documents	Verification of QA Documents	MA	Verification	100%		As per Appd. MQP		IR	✓	P	V	-	
9.0	Inspection before Delivery													
9.1	Packing	Size, appearance & Firmness	MI	Measurement Visual	100%		As per Appd. "Packing Procedure"		IR		P	-	-	

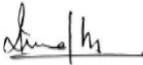
Note : Motor for Oxidation Blower is Separate MQP will be submitted for same.

LEGEND: * RECORD, IDENTIFIED WITH "TICK" (✓) UNDER COLUMN 'D' SHALL BE SUBMITTED TO CUSTOMER AS A QA DOCUMENTATION PACKAGE. M: MANUFACTURER / SUB SUPPLIER, C: MAIN CONTRACTOR(BHEL)/BHEL AIA N: CUSTOMER/CONSULTANT P: PERFORM W: WITNESS V: REVIEW OF RECORDS MA: MAJOR AND MI: MINOR	PREPARED BY  Rakesh Kumar Madhu,(SEr/QA)	REVIEWD & APPROVED BY  K C Gandhi Parimalam,(DGM/QA)
--	--	---

	PRODUCT STANDARD TURBINES & COMPRESSORS HYDERABAD	TC-6-2743
		Rev.No. 02
		SHT 44 OF 67

ANNEXURE-XI: Refer to enclosed instrument specification.

SIGNATURE OF BIDDER -----

NAME -----

DESIGNATION -----



**PRODUCT STANDARD
TURBINES & COMPRESSORS
HYDERABAD**

TC-6-2743

Rev.No. 02

SHT 45 OF 67

2.00.00	SPECIFICATION FOR ELECTRONIC TRANSMITTERS	
2.01.00	SPECIFICATION FOR ELECTRONIC TRANSMITTER FOR PRESSURE, DIFF PRESS AND DP BASED FLOW / LEVEL MEASUREMENTS	
	Sl.No.	Features
		Essential/Minimum Requirements
	1.	Type of Transmitter
		Microprocessor based 2 wire type (loop powered), Hart protocol compatible.
	2.	Accuracy
		± 0.1% of calibrated span (minimum)
	3.	Output signal range
		4-20 mA DC (Analog) along with superimposed digital signal (based on HART protocol)
	4.	Turn down ratio (minimum)
		10:1 for vacuum/very low pressure applications (i.e. pressure <= 200 mmWC)
		5:1 for very high pressure application (i.e. pressure >= 200 Kg/cm ²)
		30:1 for other applications
	5.	Stability
		± 0.1% of calibrated span for six months for Ranges up to and including 70 Kg/cm ²
		± 0.25% of calibrated span for six months for Ranges more than 70 Kg/cm ²
	6.	Zero and span drift
		+/- 0.015% per deg.C at max span
		+/- 0.11% per deg.C at min. Span
	7.	Load impedance
		500 ohm (minimum)
	8.	Housing
		Weather proof as per IP-65, metallic housing with durable corrosion resistant coating
	9.	Over Pressure
		150% of max. Operating pressure
	10.	Connection (Electrical)
		Plug and socket type
	11.	Process connection
		1/2 inch NPT (F)
	12.	Span and Zero
		Continuous, tamper proof, Remote as well as manual adjustability from instrument with zero suppression and elevation facility.
	13.	Accessories
		-Diaphragm seal, pulsation dampeners, syphon etc. as required by service and operating condition.
		-2 valve manifold for absolute & Gauge pressure transmitters, 3-valve and 5 valve manifold for DP/Level/Flow applications. The valve manifold shall be non integral type (except Fuel Oil area).



**PRODUCT STANDARD
TURBINES & COMPRESSORS
HYDERABAD**

TC-6-2743
Rev.No. 02
SHT 46 OF 67

2.02.00	<p align="right">-For hazardous area, explosions proof enclosure as described in NEC article 500</p> <p align="right">Mounting: 2 inch pipe mounting.</p> <p>14. Diagnostics & display Self-Indicating feature and digital display on transmitter</p> <p>15. Power supply 24V DC ± 10%.</p> <p>16. Adjustment/calibration/maintenance From hand held HART calibrator/ centralized PC based system (as applicable).</p> <p>Notes</p> <ul style="list-style-type: none"> - For primary air/ secondary air/flue gas applications, DP type transmitters shall be provided for pressure measurement. - LVDT type is not acceptable. - Where the process fluids are corrosive, viscous, solid bearing or slurry type, diaphragm seals shall be provided. Parts below the diaphragm shall be removable for cleaning. The entire volume above the diaphragm shall be completely filled with an inert liquid suitable for the application. 													
	<p align="center">GUIDED WAVE RADAR TYPE LEVEL TRANSMITTER</p> <table border="1"> <tr> <td>Type</td> <td>Microprocessor based 2 wire type (loop powered), HART protocol compatible Guided wave radar transmitter.</td> </tr> <tr> <td>Principle</td> <td>TDR (Time domain reflectometry)</td> </tr> <tr> <td>Probe Type & Material</td> <td>(i) Coaxial probe of SS316/316L. If required, probe shall be suitable for overflow prevention. (ii) Rod probe, cable probe of SS316/SS316L can be used for applications wherever coaxial probe is not suitable.</td> </tr> <tr> <td>Output signal</td> <td>4-20 mA DC along with superimposed digital signal (based on HART protocol), suitable for over fill prevention.</td> </tr> <tr> <td>Accuracy</td> <td>+/- 0.5% of calibrated span or minimum 5mm.</td> </tr> <tr> <td>Power supply</td> <td>24 VDC +/- 10%.</td> </tr> <tr> <td>Housing</td> <td>Weather proof as per IP-65, metallic housing with durable corrosion resistance coating.</td> </tr> </table>	Type	Microprocessor based 2 wire type (loop powered), HART protocol compatible Guided wave radar transmitter.	Principle	TDR (Time domain reflectometry)	Probe Type & Material	(i) Coaxial probe of SS316/316L. If required, probe shall be suitable for overflow prevention. (ii) Rod probe, cable probe of SS316/SS316L can be used for applications wherever coaxial probe is not suitable.	Output signal	4-20 mA DC along with superimposed digital signal (based on HART protocol), suitable for over fill prevention.	Accuracy	+/- 0.5% of calibrated span or minimum 5mm.	Power supply	24 VDC +/- 10%.	Housing
Type	Microprocessor based 2 wire type (loop powered), HART protocol compatible Guided wave radar transmitter.													
Principle	TDR (Time domain reflectometry)													
Probe Type & Material	(i) Coaxial probe of SS316/316L. If required, probe shall be suitable for overflow prevention. (ii) Rod probe, cable probe of SS316/SS316L can be used for applications wherever coaxial probe is not suitable.													
Output signal	4-20 mA DC along with superimposed digital signal (based on HART protocol), suitable for over fill prevention.													
Accuracy	+/- 0.5% of calibrated span or minimum 5mm.													
Power supply	24 VDC +/- 10%.													
Housing	Weather proof as per IP-65, metallic housing with durable corrosion resistance coating.													



**PRODUCT STANDARD
TURBINES & COMPRESSORS
HYDERABAD**

TC-6-2743

Rev.No. 02

SHT 47 OF 67

Adjustment/ calibration	Using hand held HART calibrator/ centralized PC based system (as applicable).
Zero & span adjustment	Continuous, temper proof, remote as well as manual adjustability from instrument. It should be possible to calibrate the instrument without any level in the tank/sump etc.
Display	Integral digital display.
Load Impedance	500 ohms (minimum).
Electromagnetic compatibility	Shall meet EN 61326-1 (1997) and AmdtA1, class A equipment/EN 50081-2 & EN 50082-2
Mounting	(i) External cage shall be provided where ever side mounting is required. External cage and other mounting accessories to be provided by the contractor. (ii) Where ever top mounting is required, all mounting accessories, stilling well (as required) etc., shall be provided by the contractor. (iii) All weather canopy shall be provided for protection from direct sunlight and direct rain for open locations.

Note: Four wire type transmitters can also be provided for applications where 2- wire transmitter has some technical limitations, subject to employer's approval during detailed engineering stage. However, in such cases isolated 4-20 mA DC (analog) output shall be provided. Power supply required for such transmitters shall be 240V AC / 24V DC.

2.03.00

Ultrasonic Type level Transmitter

S.No.	Features	Essential/Minimum requirement
1.	Type of Transmitter	Non-contact Microprocessor based 2 wire type (loop powered), HART protocol compatible Ultrasonic transmitter.
2.	Output signal	4-20 mA DC (Analog) along with superimposed digital signal (based on HART protocol).



PRODUCT STANDARD
TURBINES & COMPRESSORS
HYDERABAD

TC-6-2743

Rev.No. 02

SHT 48 OF 67

3.	Accuracy	+/- 0.5% of calibrated span or minimum 5mm.
4.	Power supply	24 V DC +/- 10%.
5.	Temperature compensation	To be provided within transducer.
6.	Housing	Weather proof as per IP-65, metallic housing with durable corrosion resistance coating.
7.	Adjustment/calibration/maintenance	Using hand held HART calibrator/ centralized PC based system (as applicable).
8.	Zero and Span adjustment	Continuous, tamper proof, remote as well as manual adjustability from instrument. It should be possible to calibrate the instrument without any level in the tank/sump etc.
9.	Sensor Material	Corrosion resistant material to suit individual application requirement.
10.	False signal tolerance	Transmitter shall be capable of ignoring false echoes from internal tank/sumps obstructions such as pipes, heating coils or agitator blades. Also transmitter shall have adjustable damping circuitry.
11.	Range	Range of transmitter shall be capable of covering the complete level span of tank taking care of blocking distance, frequency attenuation due to surface, obstructions, vapors etc.
12.	Display	Integral digital display
13.	Diagnostics	Loss of echo alarm etc.
14.	Load Impedance	500 ohms (minimum).
15.	Electrical Connection	Plug and socket



**PRODUCT STANDARD
TURBINES & COMPRESSORS
HYDERABAD**

TC-6-2743

Rev.No. 02

SHT 49 OF 67

16.	Accessories	<ul style="list-style-type: none">All weather canopy shall be provided for protection from direct sunlight and direct rain for open locations.All mounting accessories required for erection and commissioning shall be provided.For hazardous area, explosion proof enclosure as described in NEC article 500
-----	-------------	--

Note:

- Contractor can also provide Radar type transmitter as per above specification in place of ultrasonic transmitter subject to approval by Employer during detailed Engineering. Sonic frequency based transmitters can also be provided under "ultrasonic transmitters" category for fly ash silo level.
- Four wire type transmitters can also be provided for applications where 2- wire transmitter has some technical limitations, subject to employer's approval during detailed engineering stage. However, in such cases isolated 4-20 mA DC (analog) output shall be provided. Power supply required for such transmitters shall be 240V AC / 24V DC.
- For applications where transmitter location is not accessible, the transmitter shall have separate sensor unit and electronic unit for such applications. It shall be possible to mount the electronic unit at accessible location.

2.04.00

Specification for ULTRASONIC TYPE FLOW TRANSMITTER

S.No	Features	Essential/Minimum requirement
1.	Type of Transmitter	Non contact Microprocessor based 2 wire type, HART protocol compatible Ultrasonic transmitter. Insertion type.
2.	Output signal	4-20 mA DC (Analog) along with superimposed digital signal (based on HART protocol).
3.	Sensor Accuracy	+/- 2% of calibrated span.



PRODUCT STANDARD
TURBINES & COMPRESSORS
HYDERABAD

TC-6-2743

Rev.No. 02

SHT 50 OF 67

4.	Power supply	24 V DC +/-10%.
5.	Temperature compensation	To be provided within transducer.
6.	Housing	Weather proof as per IP-55 with durable corrosion resistance coating.
7.	Adjustment/calibration/maintenance	From hand held calibrators/centralized PC based system (as applicable).
8.	Zero and Span adjustment	Continuous, tamper proof, remote as well as manual to calibrate the instrument without any process flow.
9.	Sensor Material	Corrosion resistant material to suit individual application requirement.
10.	False signal tolerance	Transmitter shall be capable of ignoring false echoes from internal tank/sumps obstructions such as pipes, heating coils or agitator blades. Also transmitter shall have adjustable damping circuitry.
11.	Range	Should be suitable for the required process range.
12.	Display	LCD display with integral keypad to be provided.
13.	Diagnostics	Loss of echo alarm etc.
14.	Load Impedance	500 ohms minimum
15.	Electrical Connection	Plug and socket
16.	Accessories	<ul style="list-style-type: none">• All weather canopy for protection from direct sunlight and direct rain.• All mounting hardware and accessories required for erection and commissioning mounting fittings materials shall be SS 316.• For hazardous area, explosion proof enclosure as described in NEC article 500

	PRODUCT STANDARD	TC-6-2743
	TURBINES & COMPRESSORS	Rev.No. 02
	HYDERABAD	SHT 51 OF 67

2.05.00	HART Hand Held calibrator	
	Hand held calibrator shall be provided for adjustment/calibration/maintenance of the HART compatible transmitters. The hand held calibrator shall be suitable for all types of transmitters supplied in the package. If one type of hand held type calibrator is not suitable for communicating with all types of transmitters then separate hand held calibrator will be provided for that specific type of transmitter.	
3.00.00	Temperature Elements and accessories	
3.01.00	Thermocouple	
	Sr. No.	Features
		Essential/Minimum Requirements
	1	Type of Thermocouple.
		: 16 AWG wire of Chromel-Alumel (Type K) or 24 AWG wire Pt-Rhodium Pt (Type R) depending on operating temperature Range (ungrounded separate junction type).
	2	No. of element
		: Duplex
	3	Housing/Head
		: IP-65/Diecast Aluminium. Head of TE to be provided with sufficient space and arrangement to mount head mounted temperature transmitter (as applicable). Plug in connectors are to be provided for external signal cable connection. TE terminal head shall be spring loaded for positive contacts with the thermo well.
	4	Insulation and Sheathing of Thermocouple
		: Swaged type mineral (magnesium oxide) insulation and SS316 sheath.
	5	Calibration and accuracy
		: As per IEC-584/ ANSI-MC-96.1 (special limits of errors/ class1) for T/C.
	6	Accessories
		: Thermo well and associated fittings
	7	Standard
		: IEC-584/ ANSI MC 96.1 for Thermocouple and ASME PTC-19.3 for Thermo-well



PRODUCT STANDARD
TURBINES & COMPRESSORS
HYDERABAD

TC-6-2743

Rev.No. 02

SHT 52 OF 67

3.02.00

Resistance Temperature Detector (RTD)

Sr. No.	Features	Essential/Minimum Requirements
1	Type of RTD.	: Four wire, Pt-100 (100 Ohms resistance at zero degree Centigrade).
2	No. of element	: Duplex
3	Housing/Head	: IP-65/Diecast Aluminium. Head of TE to be provided with sufficient space and arrangement to mount head mounted temperature transmitter (as applicable). Plug in connectors are to be provided for external signal cable connection. TE terminal head shall be spring loaded for positive contacts with the thermo well
4	Insulation and sheathing of RTD	: Mineral (magnesium oxide) insulation and SS316 sheath,
5	Calibration and accuracy	: As per IEC-751/ DIN-43760 Class-A for RTD
6	Accessories	: Thermo well and associated fittings
7	Standard	: IEC-751/ DIN-43760 for RTD and ASME PTC-19.3 for Thermo-well.

NOTES :

- 1) The specifications for RTDs of winding/ bearings of motor/pump, can be as per their manufacturer standards. The manufacturer shall submit the adequate supporting documents for establishing their standard practice. However the type of RTD shall be Pt100.
- 2) The specifications of temp elements for air conditioning & ventilation system / process can be as per system manufacturer's standards. The manufacturer shall submit the adequate supporting documents for establishing their standard practice.

3.03.00

Metal Temperature Thermocouples

Measuring Medium	Metal Temperature
Material of Thermocouple.	Chromel Alumel Type K
Type of Thermocouple	Duplex with ungrounded separate hot junctions
Insulation	Mineral Insulation (Magnesium Oxide).



PRODUCT STANDARD
TURBINES & COMPRESSORS
HYDERABAD

TC-6-2743

Rev.No. 02

SHT 53 OF 67

	<p>Thermocouple wire gauge 16 AWG</p> <p>Protective sheath SS 321</p> <p>Protective sheath dia 8 mm OD</p> <p>Calibration & accuracy As per IEC-584/ ANSI-MC-96.1 (special limits of error) for T/C</p> <p>Mounting accessories 1/2" BSP SS sliding end connector, weld pad, clamps of heat resistant steel SS310. Adjustable gland fitting for connection at the junction box end as per manufacturer's standard.</p> <p>Cold end sealing SS pot seal with colour coded PTFE Insulated flexible tails. Sealing compound- Epoxy resin. Length of PTFE insulated flying leads shall be minimum 750 mm.</p> <p>Minimum bending radius 30 mm</p> <p>Length of T/C On as required basis considering location of measurement point and the JB/TTJB location.</p> <p>Notes :</p> <p>1) The specification for thermocouples of bearings metal temp measurements can be as per their manufacturer standards. The manufacturer shall submit the adequate supporting documents for establishing their standard practice. However type of thermocouples shall be K-type.</p>
3.04.00	<p>Thermo well (for all process temp. elements)</p> <p>(a) Shall be one piece solid bored type of 316 SS of step-less tapered design. (As per ASME PTC 19.3, 1974)</p> <p>(b) For Mill classifier outlet long life solid sintered tungsten carbide material of high abrasion resistance shall be provided.</p> <p>(c) For Air & Flue gas 316 SS protecting tube with welded cap. (However contractor shall provide better material for Flue gas service if required based on the specified boiler design parameters).</p> <p>(d) For furnace zone, impervious ceramic protecting tube of suitable material along with Incoloy supporting tubes and adjustable flanges.</p>
3.05.00	<p>TEMPERATURE TRANSMITTER (TT)</p> <p>Following types of 2-wire (loop powered) temperature transmitter (directly powered from 4-20mA input cards of DDCMIS/PLC) shall be provided. The temperature transmitter shall be fully compatible with thermocouples and RTDs being provided by the contractor. Temperature compensation of the thermocouples shall be performed in the temperature transmitter itself.</p>



PRODUCT STANDARD
TURBINES & COMPRESSORS
HYDERABAD

TC-6-2743

Rev.No. 02

SHT 54 OF 67

- a. Single Input Head mounted Temperature Transmitter
These shall be suitable for mounting in the head of temperature element itself. Temperature transmitter and associated temperature element shall be factory fitted.
- b. Single Input DIN-rail mounted Temperature Transmitter
These shall be suitable for mounting on DIN-rails in JB's. The specifications of the JB's shall be same as indicated in Subsection INST CABLE with additional DIN-rails and IP 65 Protection class. This temperature transmitter shall be the ones which are especially designed for DIN-rail mounting with IP 20 protection class. These shall have terminals for input/output provided on front side when mounted on DIN-rail. Head mounted temperature transmitter with clamps to make it suitable for DIN-rail mounting shall not be acceptable under this category.
- c. Dual-input Temperature Transmitter With **integral** Indicator:
These shall be suitable for mounting on pipes/ support. Both elements of the duplex thermocouple/ RTD shall be wired to a single transmitter. Integral indicator shall be provided with these transmitters. These transmitters shall have bump less change over facility to second sensor in case first sensor fails. This change-over is to be alarmed. Protection class shall be IP65 minimum.
- d. Common requirements for each of the above type of temperature transmitters.
- Output : 2-wire (power supply from input card of Control System) with 4-20mA output with superimposed HART protocol signal.
- Input : Same transmitter shall be capable to handle Pt-100 RTD, Thermocouples -K & R types (input type to be selectable at site through HART terminal).
- Isolation : Min. 500 V AC.
- EMC compatibility : As per EN 61326.
- Operating ambient temperature : 0 to 85 deg C (without indicator).
0 to 70 deg C (with indicator).
- Power supply : 24V DC +/- 10%.
- Accessories : Mounting arrangements including clamps etc.
- Composite Accuracy (Refer note 2) (i) For head mounted and DIN-rail mounted types:
RTD = <0.4% of 0-250 deg C span
T/C-K type = <0.4% of 0-600 deg C span
T/C-R type = <0.4% of 0-1000 deg C span
CJC accuracy (for thermocouples) shall be = < 1 deg C
- (ii) For dual-input type:
RTD = <0.25% of 0-250 deg C span
T/C-K type = <0.2% of 0-600 deg C span
CJC accuracy (for thermocouples) shall be = < 1 deg C



**PRODUCT STANDARD
TURBINES & COMPRESSORS
HYDERABAD**

TC-6-2743

Rev.No. 02

SHT 55 OF 67

Notes (Common for a) to d) above):-

1. In case of failure (open or burn-out) of RTD/thermocouple, temp. Transmitter shall provide low temperature output.
2. Composite Accuracy is to be calculated as summation of all applicable accuracies of temp transmitter, for converting sensor input to output in 4-20 mA (e.g., basic accuracy, digital accuracy, D/A accuracy, etc.) and temperature effect on these accuracies at ambient temperature of 50 deg C, based on the figure/ formula given in the standard product catalogue for span as specified above for various types of Temperature Elements specified. All such accuracy/ temp effect figures in catalogue shall be first converted to deg C, and then percentage of this converted accuracy in specified span shall be calculated to compare with the specified composite accuracy figures. All temperature transmitters are to be interchangeable (i.e. can be used for either RTD or thermocouple) and composite accuracy shall be met for each type of input specified in (i) & (ii).

4.00.00

SPECIFICATIONS FOR PR. GAUGE, D.P. GAUGE, TEMP. GAUGE AND LEVEL GAUGE.

SI. No	FEATURES	ESSENTIAL/MINIMUM REQUIREMENTS		
		Pr. Gauge/ DP Gauge/ Draught gauges	Temperature Gauge	Level Gauge
1	Sensing Element	Bourdon for high pressure, Diaphragm/ Bellow for low pr.	Inert gas actuated/ Liquid filled other than mercury	Tempered * toughened Borosilicate gauge glass steel armoured reflex or transparent type.
2	Material of sensing element	SS 316	SS 316	
3	Material of movement	SS 304	SS 304	
4	Body material	Die-cast aluminium	Die-cast aluminium	Forged carbon steel/304 SS
5	Dial size	150mm	150 mm	Tubular covering entire range
6	End connection	1/2 inch NPT (M)	1/2 inch or 3/4 inch NPT (M).	Process connection as per ASME PTC and drain/vent 15 NB



**PRODUCT STANDARD
TURBINES & COMPRESSORS
HYDERABAD**

**TC-6-2743
Rev.No. 02
SHT 56 OF 67**

7	Accuracy	±1% of span	± 1% of span	± 2%
8	Scale	Linear, 270° arc graduated in metric units	Linear, 270° arc graduated in °C	Linear vertical
9	Range selection	Shall cover 125% of max. operating press	Shall cover 125% of max. operating temp	Shall cover max. Operating level.
10	Over range	125% of FSD	125% of FSD	-
11	Housing	Weather and dust proof as per IP-55	Weather and dust proof as per IP-55	CS/304 SS leak proof
12	Zero/span adjustment	Provided	Provided	--
13	Identification	Engraved with service legend or laminated phenolic name plate		
14	Accessories	Blow out disc, siphon, snubber, pulsation dampener, chemical seal (if required by process) gauge isolation valve	SS Thermowell	Gasket for all KEL-F shield for transparent type vent and drain valves of Steel/SS as per CS/Alloy process Requirement.
Notes:-				
*Bicolour type level gauges will be provided for applications involving steam and water except for condensate and feed water services.				
Length of gauge glass shall not be more than 1400 mm. If the vessel is higher, multiple gauge glasses with 50 mm overlapping shall be provided.				
Where the process fluids are corrosive, viscous, solid bearing or slurry type, diaphragm seals shall be provided. Parts below the diaphragm shall be removable for cleaning. The entire volume above the diaphragm shall be completely filled with an inert liquid suitable for the application.				

SIGNATURE OF BIDDER -----

NAME -----

DESIGNATION -----

	PRODUCT STANDARD TURBINES & COMPRESSORS HYDERABAD	TC-6-2743
		Rev.No. 02
		SHT 57 OF 67

ANNEXURE-XII: Motor specification

MOTORS			
1.00.00	GENERAL REQUIREMENTS		
1.01.00	For the purpose of design of equipment/systems, an ambient temperature of 50 deg. Centigrade and relative humidity of 95% (at 40 deg C) shall be considered. The equipment shall operate in a highly polluted environment.		
1.02.00	All equipment's shall be suitable for rated frequency of 50 Hz with a variation of +3% & -5%, and 10% combined variation of voltage and frequency unless specifically brought out in the specification.		
1.03.00	Contactor shall provide fully compatible electrical system, equipment's, accessories and services.		
1.04.00	All the equipment, material and systems shall, in general, conform to the latest edition of relevant National and international Codes & Standards, especially the Indian Statutory Regulations.		
1.05.00	Paint shade shall be as per RAL 5012 (Blue) for indoor and outdoor equipment.		
1.06.00	The responsibility of coordination with electrical agencies and obtaining all necessary clearances for Contactors equipment and systems shall be under the Contactor scope.		
1.07.00	Degree of Protection Degree of protection for various enclosures as per IEC60034-05 shall be as follows :- i) Indoor motors - IP 54 ii) Outdoor motors - IP 55 iii) Cable box-indoor area - IP 54 iv) Cable box-Outdoor area - IP 55		
2.00.00	CODES AND STANDARDS		
	1) Three phase induction motors : IS/IEC:60034		
	2) Single phase AC motors : IS/ IEC:60034		
	3) Crane duty motors : IS:3177, IS/IEC:60034		
	4) DC motors/generators : IS:4722, IS/IEC:60034		
	5) Energy Efficient motors : IS 12615, IEC:60034-30		
LOT-IA PROJECTS FLUE GAS FLUE GAS DESULPHURISATION (FGD) SYSTEM PACKAGE	TECHNICAL SPECIFICATION SECTION - VI, PART-B BID DOC NO : CS-0011-109(1)-2	SUB SECTION-II-E2 MOTORS	PAGE 1 OF 9

	PRODUCT STANDARD TURBINES & COMPRESSORS HYDERABAD	TC-6-2743
		Rev.No. 02
		SHT 58 OF 67

3.00.00	TYPE
3.01.00	AC Motors: <ul style="list-style-type: none"> a) Squirrel cage induction motor suitable for direct-on-line starting. b) Continuous duty LT motors upto 200 KW Output rating (at 50 deg.C ambient temperature), shall be Premium Efficiency class-IE3, conforming to IS 12615, or IEC:60034-30. c) Crane duty motors shall be slip ring/ squirrel cage Induction motor as per the requirement. d) Motor operating through variable frequency drives shall be suitable for inverter duty. Also these motors shall comply the requirements stipulated in IEC: 60034-18-41 and IEC: 60034-18-42 as applicable.
3.02.00	DC Motors Shunt wound.
4.00.00	RATING
	<ul style="list-style-type: none"> (a) Continuously rated (S1). However, crane motors shall be rated for S4 duty, 40% cyclic duration factor. (b) Whenever the basis for motor or driven equipment ratings are not specified in the corresponding mechanical specification sub-sections, maximum continuous motor ratings shall be at least 10% above the maximum load demand of the driven equipment under entire operating range including voltage and frequency variations.
5.00.00	TEMPERATURE RISE
	Air cooled motors 70 deg. C by resistance method for both thermal class 130(B) & 155(F) insulation.
	Water cooled 80 deg. C over inlet cooling water temperature mentioned elsewhere, by resistance method for both thermal class 130(B) & 155(F) insulation.
6.00.00	OPERATIONAL REQUIREMENTS
6.01.00	Starting Time
6.01.01	For motors with starting time upto 20 secs. at minimum permissible voltage during starting, the locked rotor withstand time under hot condition at highest voltage limit shall be at least 2.5 secs. more than starting time.
6.01.02	For motors with starting time more than 20 secs. and upto 45 secs. at minimum permissible voltage during starting, the locked rotor withstand time under hot condition at highest voltage limit shall be at least 5 secs. more than starting time.



PRODUCT STANDARD
TURBINES & COMPRESSORS
HYDERABAD

TC-6-2743

Rev.No. 02

SHT 59 OF 67

6.01.03	For motors with starting time more than 45 secs. at minimum permissible voltage during starting, the locked rotor withstand time under hot condition at highest voltage limit shall be more than starting time by at least 10% of the starting time.
6.01.04	Speed switches mounted on the motor shaft shall be provided in cases where above requirements are not met.
6.02.00	Torque Requirements
6.02.01	Accelerating torque at any speed with the lowest permissible starting voltage shall be at least 10% motor full load torque.
6.02.02	Pull out torque at rated voltage shall not be less than 205% of full load torque. It shall be 275% for crane duty motors.
6.03.00	Starting voltage requirement
	(a) Up to 85% of rated voltage for ratings below 110 KW
	(b) Up to 80% of rated voltage for ratings from 110 KW to 200 KW
	(c) Up to 85% of rated voltage for ratings from 201 KW to 1000 KW
	(d) Up to 80% of rated voltage for ratings from 1001 KW to 4000 KW
	(e) Up to 75 % of rated voltage for ratings above 4000KW
7.00.00	DESIGN AND CONSTRUCTIONAL FEATURES
7.01.00	Suitable single phase space heaters shall be provided on motors rated 30KW and above to maintain windings in dry condition when motor is standstill. Separate terminal box for space heaters & RTDs shall be provided. However for flame proof motors, space heater terminals inside the main terminal box may be acceptable.
7.02.00	All motors shall be either Totally enclosed fan cooled (TEFC) or totally enclosed tube ventilated (TETV) or Closed air circuit air cooled (CACA) type. However, motors rated 3000KW or above can be Closed air circuit water cooled (CACW). The method of movement of primary and secondary coolant shall be self-circulated by fan or pump directly mounted on the rotor of the main motor as per IEC 60034-6. However VFD driven motors can be offered with forced cooling type with machine mounted fan or pump driven by separate electric motor. Motors and EPB located in hazardous areas shall have flame proof enclosures conforming to IS:2148 as detailed below
	(a) Fuel oil area : Group – IIB
	(b) Hydrogen generation : Group - IIC or (Group-I, Div-II as per plant area NEC) or (Class-1, Group-B, Div-II as per NEMA /IEC60034)



PRODUCT STANDARD
TURBINES & COMPRESSORS
HYDERABAD

TC-6-2743

Rev.No. 02

SHT 60 OF 67

7.03.00	<p>Winding and Insulation</p> <p>(a) Type : Non-hygroscopic, oil resistant, flame resistant</p> <p>(b) Starting duty : Two hot starts in succession, with motor initially at normal running temperature.</p> <p>(c) 11kV & 3.3 kV AC motors : Thermal class 155 (F) insulation. The winding insulation process shall be total Vacuum Pressure Impregnated i.e resin poor method. The lightning Impulse & interturn insulation surge withstand level shall be as per IEC-60034 part-15.</p> <p>(d) 240VAC, 415V AC & 220V DC motors : Thermal Class (B) or better</p>
7.04.00	<p>Motors rated above 1000KW shall have insulated bearings to prevent flow of shaft currents.</p>
7.05.00	<p>Motors with heat exchangers shall have dial type thermometer with adjustable alarm contacts to indicate inlet and outlet primary air temperature.</p>
7.06.00	<p>Noise level for all the motors shall be limited to 85 dB(A) except for BFP motor for which the maximum limit shall be 90dB(A). Vibration shall be limited within the limits prescribed in IS:12075 / IEC 60034-14 . Motors shall withstand vibrations produced by driven equipment. HT motor bearing housings shall have flat surfaces, in both X and Y directions, suitable for mounting 80mmX80mm vibration pads.</p>
7.07.00	<p>In HT motors, at least four numbers simplex / two numbers duplex platinum resistance type temperature detectors shall be provided in each phase stator winding. Each bearing of HT motor shall be provided with dial type thermometer with adjustable alarm contact and preferably 2 numbers duplex platinum resistance type temperature detectors.</p>
7.08.00	<p>Motor body shall have two earthing points on opposite sides.</p>
7.09.00	<p>11 KV motors shall be offered with Separable Insulated Connector (SIC) as per IEEE 386. The offered SIC terminations shall be provided with protective cover and trifurcating sleeves. SIC termination kit shall be suitable for fault level of 25 KA for 0.17 seconds.</p>
7.10.00	<p>3.3 KV motors shall be offered with dust tight phase separated double walled (metallic as well as insulated barrier) Terminal box. Employer shall provide termination kit for the offered Terminal box. The offered Terminal Box shall be suitable for fault level of 250 MVA for 0.12 sec. Removable gland plates of thickness 3 mm (hot/cold rolled sheet steel) or 4 mm (non magnetic material for single core cables) shall be provided.</p>



PRODUCT STANDARD
TURBINES & COMPRESSORS
HYDERABAD

TC-6-2743

Rev.No. 02

SHT 61 OF 67

7.11.00	The spacing between gland plate & centre of terminal stud shall be as per Table-I.
7.12.00	All motors shall be so designed that maximum inrush currents and locked rotor and pullout torque developed by them at extreme voltage and frequency variations do not endanger the motor and driven equipment.
7.13.00	The motors shall be suitable for bus transfer schemes provided on the 11kV, 3.3 kV /415V systems without any injurious effect on its life.
7.14.00	For motors rated 2000 KW & above, neutral current transformers of PS class shall be provided on each phase in a separate neutral terminal box.
7.15.00	The size and number of cables (for HT motors) to be intimated to the successful Contactor during detailed engineering and the Contactor shall provide terminal box suitable for the same.
8.00.00	The ratio of locked rotor KVA at rated voltage to rated KW shall not exceed the following (without any further tolerance): (a) From 50KW & upto 110KW : 11.0 (b) From 110 KW & upto 200 KW : 9.0 (c) Above 200 KW & upto 1000KW : 10.0 (d) From 1001KW & upto 4000KW : 9.0 (e) Above 4000KW : 6 to 6.5
10.00.00	TYPE TEST
10.01.00	HT MOTORS
10.01.01	The Contactor shall carry out the type tests as listed in this specification on the equipment to be supplied under this contract. The Contactor shall indicate the charges for each of these type tests separately in the relevant schedule of Section - VII- (BPS) and the same shall be considered for the evaluation of the bids. The type tests charges shall be paid only for the test(s) actually conducted successfully under this contract and upon certification by the Employer's engineer.
10.01.02	The type tests shall be carried out in presence of the Employer's representative, for which minimum 15 days notice shall be given by the Contactor. The Contactor shall obtain the Employer's approval for the type test procedure before conducting the type test. The type test procedure shall clearly specify the test set-up, instruments to be used, procedure, acceptance norms, recording of different parameters, interval of recording, precautions to be taken etc. for the type test(s) to be carried out.
10.01.03	In case the Contactor has conducted such specified type test(s) within last ten years as on the date of bid opening, he may submit during detailed engineering

	PRODUCT STANDARD TURBINES & COMPRESSORS HYDERABAD	TC-6-2743
		Rev.No. 02
		SHT 62 OF 67

10.01.04	<p>the type test reports to the Employer for waiver of conductance of such test(s). These reports should be for the tests conducted on the equipment similar to those proposed to be supplied under this contract and test(s) should have been either conducted at an independent laboratory or should have been witnessed by a client. The Employer reserves the right to waive conducting of any or all the specified type test(s) under this contract. In case type tests are waived, the type test charges shall not be payable to the Contactor.</p> <p>Further the Contactor shall only submit the reports of the type tests as listed in "LIST OF TESTS FOR WHICH REPORTS HAVE TO BE SUBMITTED" and carried out within last ten years from the date of bid opening. These reports should be for the test conducted on the equipment similar to those proposed to be supplied under this contract and the test(s) should have been either conducted at an independent laboratory or should have been witnessed by a client. However if the Contactor is not able to submit report of the type test(s) conducted within last ten years from the date of bid opening, or in the case of type test report(s) are not found to be meeting the specification requirements, the Contactor shall conduct all such tests under this contract at no additional cost to the Employer either at third party lab or in presence of client/Employers representative and submit the reports for approval.</p>
10.01.05	<p>LIST OF TYPE TESTS TO BE CONDUCTED</p> <p>The following type tests shall be conducted on each type and rating of HT motor</p> <ul style="list-style-type: none"> (a) No load saturation and loss curves upto approximately 115% of rated voltage (b) Measurement of noise at no load. (c) Momentary excess torque test (subject to test bed constraint). (d) Full load test(subject to test bed constraint) (e) Temperature rise test at rated conditions. During heat run test, bearing temp., winding temp.,coolant flow and its temp. shall also be measured. In case the temperature rise test is carried at load other than rated load, specific approval for the test method and procedure is required to be obtained. Wherever ETD's are provided, the temperature shall be measured by ETD's also for the record purpose.
10.01.06	<p>LIST OF TESTS FOR WHICH REPORTS HAVE TO BE SUBMITTED</p> <p>The following type test reports shall be submitted for each type and rating of HT motor</p> <ul style="list-style-type: none"> (a) Degree of protection test for the enclosure followed by IR, HV and no load run test.



**PRODUCT STANDARD
TURBINES & COMPRESSORS
HYDERABAD**

TC-6-2743

Rev.No. 02

SHT 63 OF 67

	<p>(b) Terminal box-fault level withstand test for each type of terminal box of HT motors only.</p> <p>(c) Lightning Impulse withstand test on the sample coil shall be as per clause no. 4.3 IEC-60034, part-15</p> <p>(d) Surge-withstand test on inter-turn insulation shall be as per clause no. 4.2 of IEC 60034, part-15</p>
10.02.00	LT Motors
10.02.01	<p>LT Motors supplied shall be of type tested design. During detailed engineering, the Contactor shall submit for Employer's approval the reports of all the type tests as listed in this specification and carried out within last <i>ten</i> years from the date of bid opening. These reports should be for the test conducted on the equipment similar to those proposed to be supplied under this contract and the test(s) should have been either conducted at an independent laboratory or should have been witnessed by a client.</p>
10.02.02	<p>However if the Contactor is not able to submit report of the type test(s) conducted within last ten years from the date of bid opening, or in the case of type test report(s) are not found to be meeting the specification requirements, the Contactor shall conduct all such tests under this contract at no additional cost to the Employer either at third party lab or in presence of client/Employers representative and submit the reports for approval.</p>
10.02.03	<p>LIST OF TESTS FOR WHICH REPORTS HAVE TO BE SUBMITTED</p> <p>The following type test reports shall be submitted for each type and rating of LT motor of above 50 KW only</p> <ol style="list-style-type: none">1. Measurement of resistance of windings of stator and wound rotor.2. No load test at rated voltage to determine input current power and speed3. Open circuit voltage ratio of wound rotor motors (in case of Slip ring motors)4. Full load test to determine efficiency power factor and slip5. Temperature rise test6. Momentary excess torque test.7. High voltage test8. Test for vibration severity of motor.9. Test for noise levels of motor(Shall be limited as per clause no 7.06.00 of this section)

	PRODUCT STANDARD TURBINES & COMPRESSORS HYDERABAD	TC-6-2743
		Rev.No. 02
		SHT 64 OF 67

	<p>10. Test for degree of protection and</p> <p>11. Overspeed test.</p> <p>12. Type test reports for motors located in fuel oil area having flame proof enclosures as per IS 2148 / IEC 60079-1</p>
10.03.00	<p>All acceptance and routine tests as per the specification and relevant standards shall be carried out. Charges for these shall be deemed to be included in the equipment price.</p>
10.04.00	<p>The type test reports once approved for any projects shall be treated as reference. For subsequent projects of NTPC, an endorsement sheet will be furnished by the manufacturer confirming similarity and "No design Change". Minor changes if any shall be highlighted on the endorsement sheet.</p>



**PRODUCT STANDARD
TURBINES & COMPRESSORS
HYDERABAD**

TC-6-2743

Rev.No. 02

SHT 65 OF 67

TABLE - I

DIMENSIONS OF TERMINAL BOXES FOR LV MOTORS

Motor MCR in KW of	Minimum distance between centre of stud and gland plate in mm As per manufacturer's practice.
UP to 3 KW	
Above 3 KW - upto 7 KW	85
Above 7 KW - upto 13 KW	115
Above 13 KW - upto 24 KW	167
Above 24 KW - upto 37 KW	196
Above 37 KW - upto 55 KW	249
Above 55 KW - upto 90 KW	277
Above 90 KW - upto 125 KW	331
Above 125 KW-upto 200 KW	203

For HT motors the distance between gland plate and the terminal studs shall not be less than 500 mm.

PHASE TO PHASE/ PHASE TO EARTH AIR CLEARANCE:

NOTE: Minimum inter-phase and phase-earth air clearances for LT motors with lugs installed shall be as follows:

Motor MCR in KW	Clearance
UP to 110 KW	10mm
Above 110 KW and upto 150 KW	12.5mm
Above 150 KW	19mm



**PRODUCT STANDARD
TURBINES & COMPRESSORS
HYDERABAD**

TC-6-2743
Rev.No. 02
SHT 66 OF 67

ANNEXURE-XIII: Reference P&ID drawing indicating the scope between BHEL and the vendor

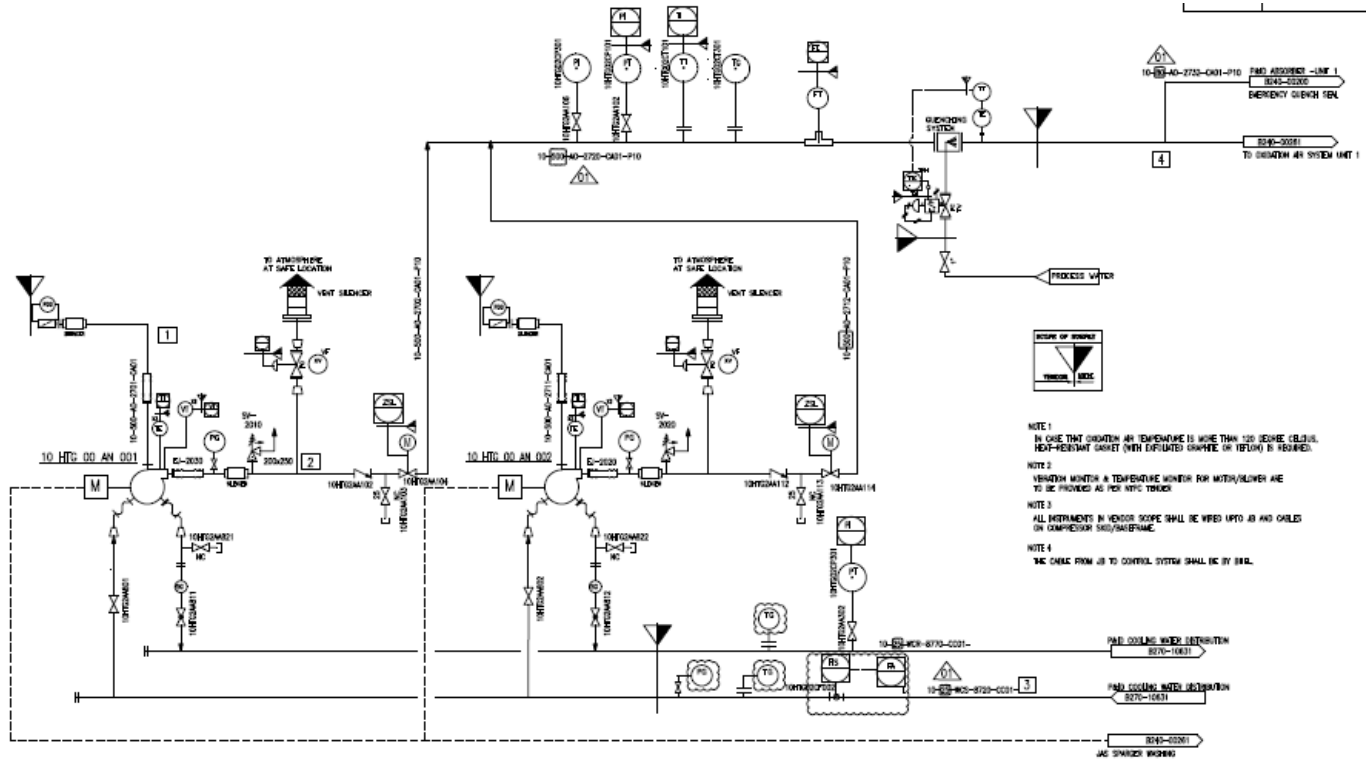

SIGNATURE OF BIDDER -----

NAME -----

DESIGNATION -----

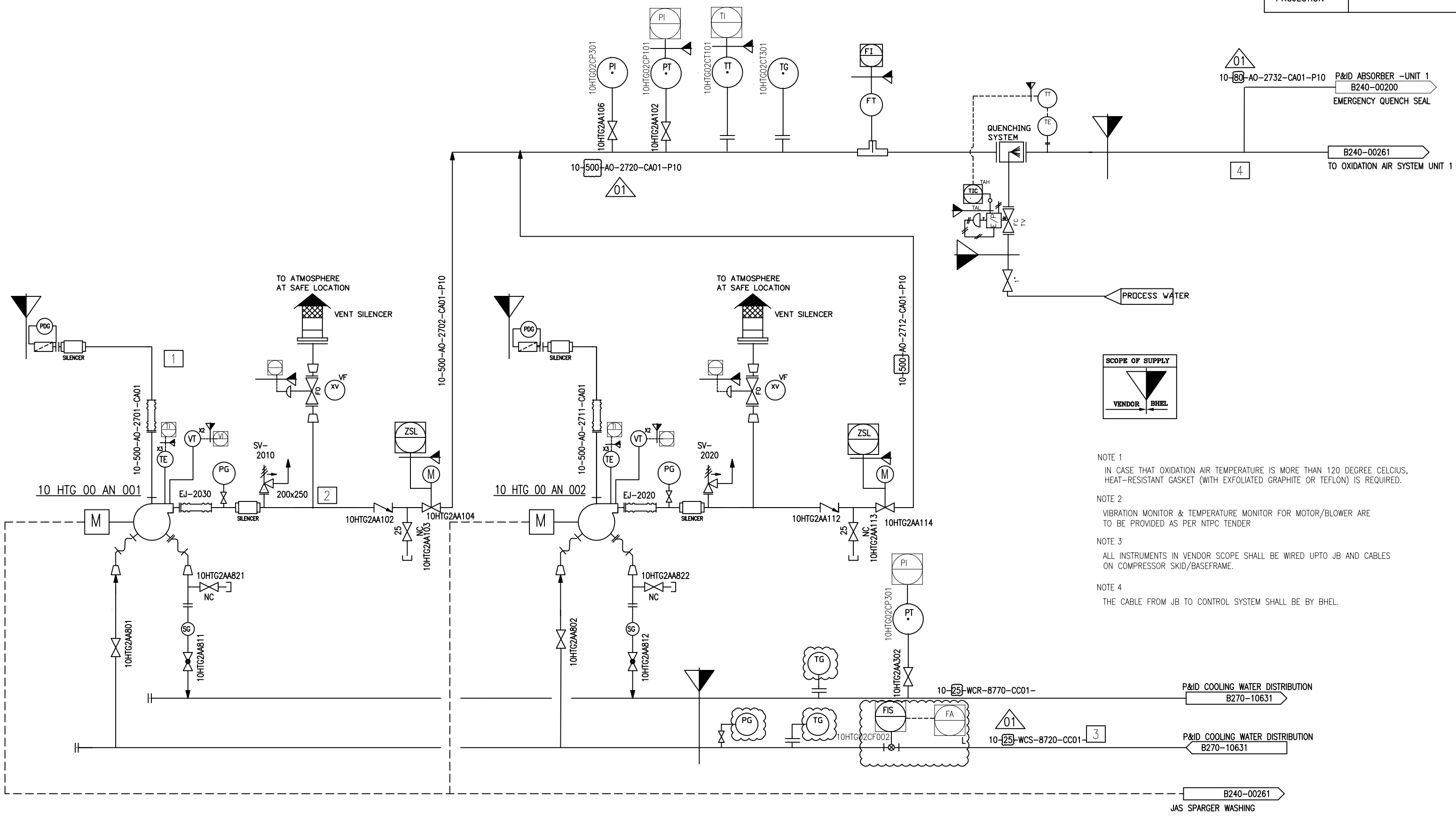

SCOPE OF SUPPLY

VENDOR ← BHEL

- NOTE 1
IN CASE THAT OXIDATION AIR TEMPERATURE IS MORE THAN 120 DEGREE CELCIUS, HEAT-RESISTANT GASKET (WITH EXFOLIATED GRAPHITE OR TEFLON) IS REQUIRED.
- NOTE 2
VIBRATION MONITOR & TEMPERATURE MONITOR FOR MOTOR/BLOWER ARE TO BE PROVIDED AS PER NTPC TENDER
- NOTE 3
ALL INSTRUMENTS IN VENDOR SCOPE SHALL BE WIRED UPTO JB AND CABLES ON COMPRESSOR SKID/BASEFRAME.
- NOTE 4
THE CABLE FROM JB TO CONTROL SYSTEM SHALL BE BY BHEL.

P&ID COOLING WATER DISTRIBUTION
B270-10631

P&ID COOLING WATER DISTRIBUTION
B270-10631

B240-00261
JAS SPARGER WASHING

