

Technical Specifications

SL. No	Description and Technical Specification of the item	QTY	UNIT	Delivery
1	Supply and installation of telescopic Supply and installation of telescopic cover as per Drawing NO: 3-M-01B12-16700	1.00	SET	180 DAYS
2	Supply and installation of telescopic Supply and installation of telescopic cover as per Drawing NO: 3-M-01B13-16692	1.00	SET	180 DAYS
3	Supply and installation of telescopic Supply and installation of telescopic cover as per Drawing NO: 3-M-01B14-16698	1.00	SET	180 DAYS
4	Supply and installation of telescopic Supply and installation of telescopic cover as per Drawing NO: 3-M-01B14-16699	1.00	SET	180 DAYS
5	Supply and installation of telescopic Supply and installation of telescopic cover as per Drawing NO: 3-M-01B21-16694	1.00	SET	180 DAYS
6	Supply and installation of telescopic Supply and installation of telescopic cover as per Drawing NO: 3-M-01B21-16695	1.00	SET	180 DAYS
7	Supply and installation of telescopic Supply and installation of telescopic cover as per Drawing NO: 3-M-01B23-16696	1.00	SET	180 DAYS
8	Supply and installation of telescopic Supply and installation of telescopic cover as per Drawing NO:3-M-01B23- 16697	1.00	SET	180 DAYS

9	Supply and installation of telescopic Supply and installation of telescopic cover as per Drawing NO: 3-M-01B26-15911	1.00	SET	180 DAYS
10	Supply and installation of telescopic Supply and installation of telescopic cover as per Drawing NO: 3-M-14A03-1670	1.00	SET	180 DAYS

Note: Cumulative L1 may be consider for Sl. No 10 to 100 since L1 vendor will depute the One installation technical team and complete the entire work in a single stretch. It will reduce the PO value drastically.

COMMON NOTE FOR SL.NO. 1 to 10

1)The drawings are given for reference only. However, the supplier may visit BHEL and take the complete dimensions including mounting arrangement before quoting.

2)The major dimensions are provided in the Drawings. After placement of Purchase order, the supplier shall visit the machine at BHEL and take the complete dimensions including mounting dimensions before manufacturing.

3)Lifting lugs to be provided.

Sign. of the AUTHORISED SIGNATORY
(With Name, Designation and Company seal)

Pre-Qualification Criteria for Supply and installation of telescopic cover at Bldg-6 machines

Sl. No	BHEL's Requirement	Vendor to Confirm
1	<p>Only those vendors who satisfy the following conditions will get qualified to participate in the tender:</p> <p>Previous purchase order (PO) details for supply and installation of similar kind of items to BHEL and/or any-other Organization should be submitted along with offer. Otherwise offer will be rejected. You may contact the following suppliers</p>	

Sign. of the AUTHORISED SIGNATORY
(With Name, Designation and Company seal)

ALL DIMENSIONS ARE IN MILLIMETRES

DRAWING NO: 3-M-01B12-16700

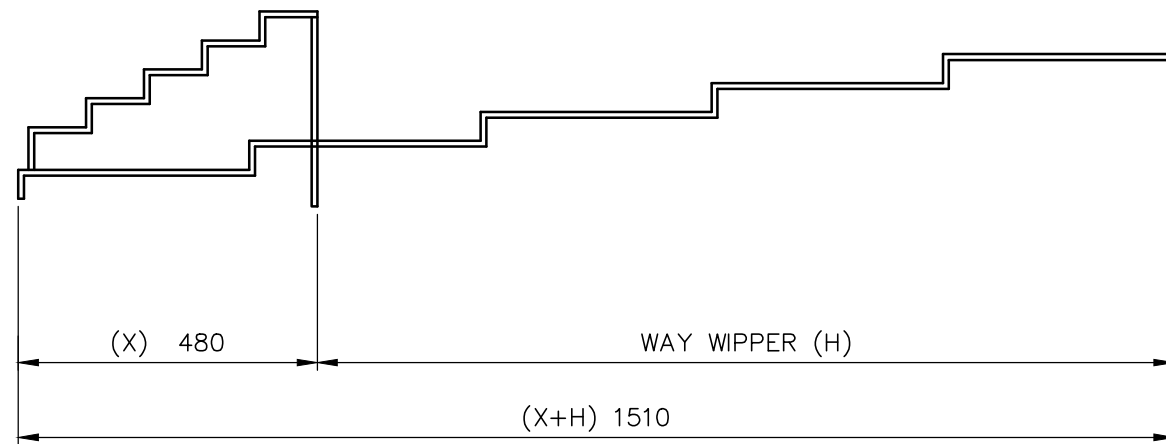
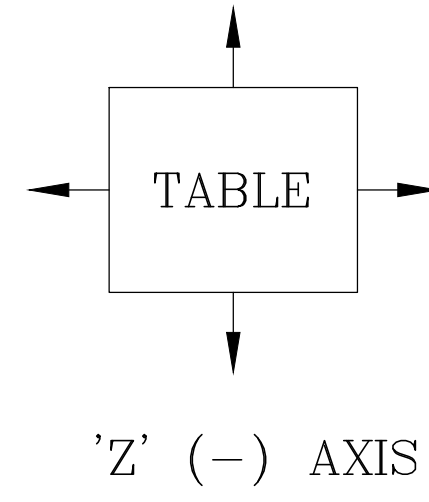
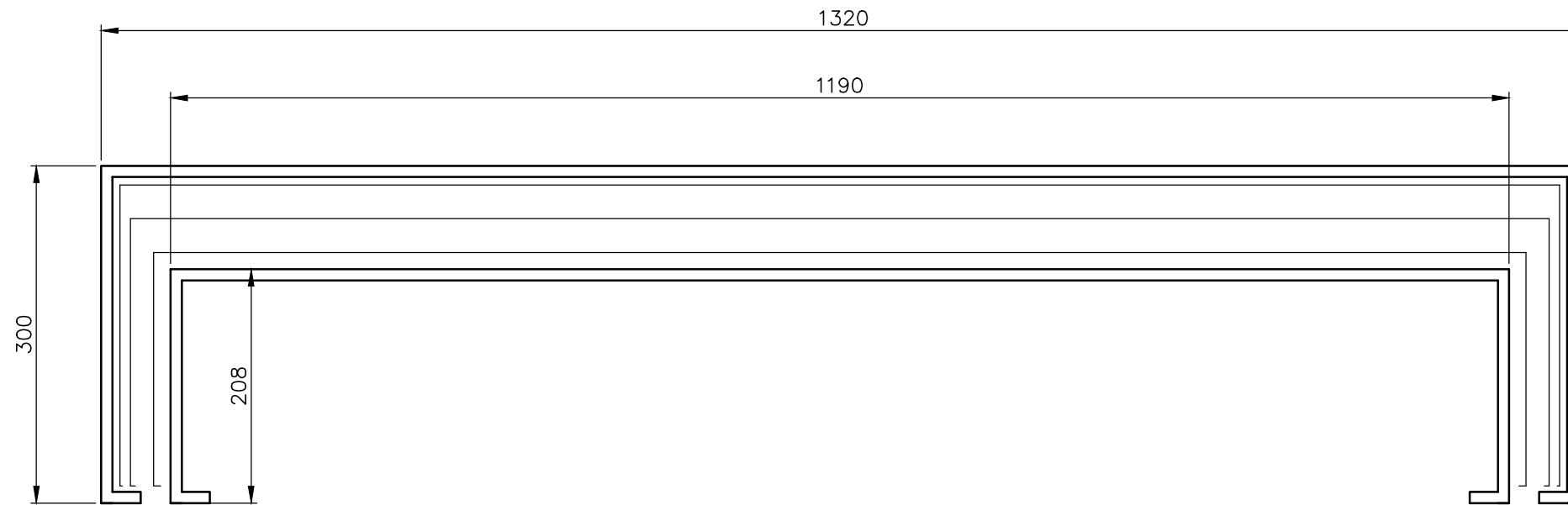

NOTE: -

1. SHEET THICKNESS AND FIXING ARRANGEMENT OF TELESCOPIC GUARD TO THE MACHINE TO BE ASCERTAINED BY THE SUPPLIER
2. MATERIAL: Fe 330 IS:1079

'Z' (-) AXIS

FOR TENDERING PURPOSE ONLY

REV	DATE	ALTERED
		CHECKED
		APPROVED
ZONE		

ITEM NO		DESCRIPTION	DRAWING NO	MATL CODE	UNIT WT
				MATL SPEC	QTY
EQPT: HORIZONTAL BORING /AZ11					
DEPT M&S		GRADE OF UNTOL. DIM	SCALE	WEIGHT (Kg)	REF TO ASSY DWG NO
CODE 2597		IS: 2102	1:5	-	REF TO OLD DWG NO -
TITLE			CARD CODE	DRAWING NO :	REV
TELESCOPIC GAURD			U 01	3-M-01B12-16700	00
(FACE PLATE SIDE / Z (-) AXIS)					

CAUTION: THE INFORMATION ON THIS DOCUMENT IS THE PROPERTY OF BHARAT HEAVY ELECTRICALS LIMITED. IT MUST NOT BE USED DIRECTLY OR INDIRECTLY IN ANY WAY DETRIMENTAL TO THE INTEREST OF THE COMPANY.

A3-SIZE



DRAWING NO: 3-M-01B14-16698

ALL DIMENSIONS ARE IN MILLIMETRES

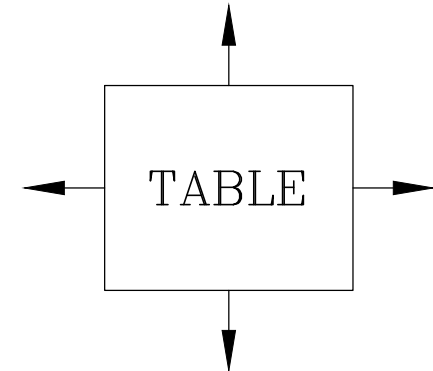
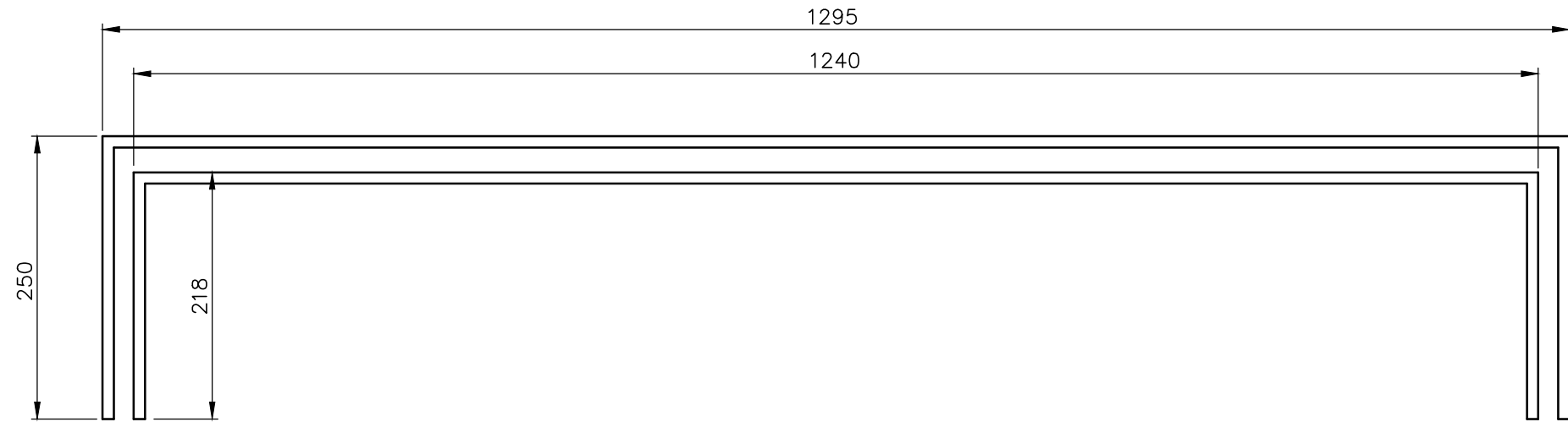

'Z' (-) AXIS

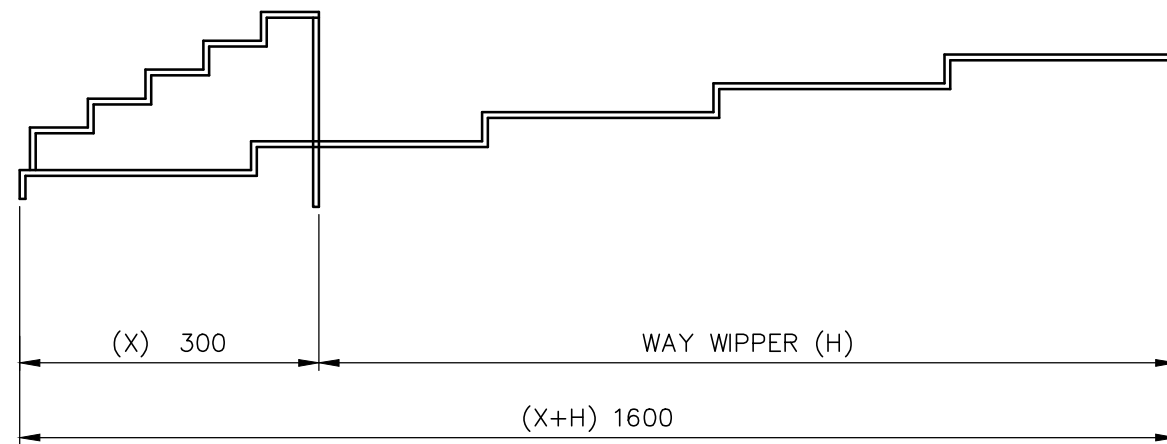

'Z' (-) AXIS

FOR TENDERING PURPOSE ONLY

NOTE: -

1. SHEET THICKNESS AND FIXING ARRANGEMENT OF TELESCOPIC GUARD TO THE MACHINE TO BE ASCERTAINED BY THE SUPPLIER
2. MATERIAL: Fe 330 IS:1079

REV	DATE	ALTERED
		CHECKED
		APPROVED
ZONE		

ITEM NO		DESCRIPTION	DRAWING NO	MATL CODE	UNIT WT
				MATL SPEC	QTY
EQPT: HORIZONTAL BORING/NOMURA CNC BNF / 130					
DEPT M&S		GRADE OF UNTOL. DIM	SCALE	WEIGHT (Kg)	REF TO ASSY DWG NO
CODE 2597		IS: 2102	1:5	-	REF TO OLD DWG NO -
TITLE			CARD CODE	DRAWING NO :	REV
TELESCOPIC GAURD			U 01	3-M-01B14-16698	00
(FACE PLATE SIDE / Z (-) AXIS)					

CAUTION: THE INFORMATION ON THIS DOCUMENT IS THE PROPERTY OF BHARAT HEAVY ELECTRICALS LIMITED. IT MUST NOT BE USED DIRECTLY OR INDIRECTLY IN ANY WAY DETRIMENTAL TO THE INTEREST OF THE COMPANY.

	Bharat Heavy Electricals Ltd		DRN	NAME	SIGNATURE	DATE
	HIGH PRESSURE BOILER PLANT		CHD	A.DANASEKAR	A. Danasekar	03.04.26
	TIRUCHIRAPALLI - 620014		APPD	A.DANASEKAR	A. Danasekar	04.04.26
						05.04.26

A3-SIZE



ALL DIMENSIONS ARE IN MILLIMETRES

DRAWING NO: 3-M-01B14-16699

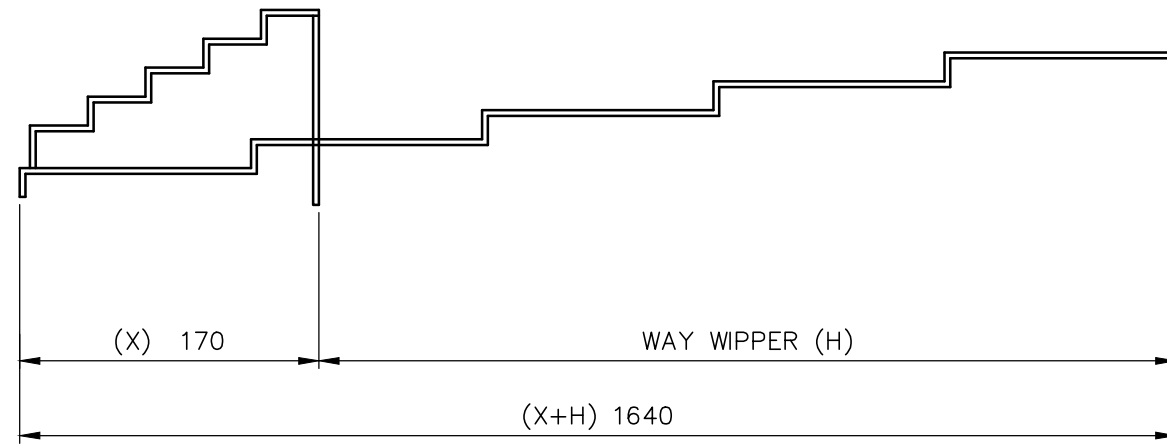
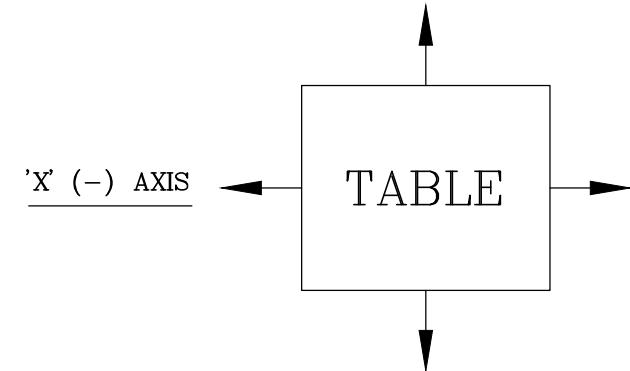
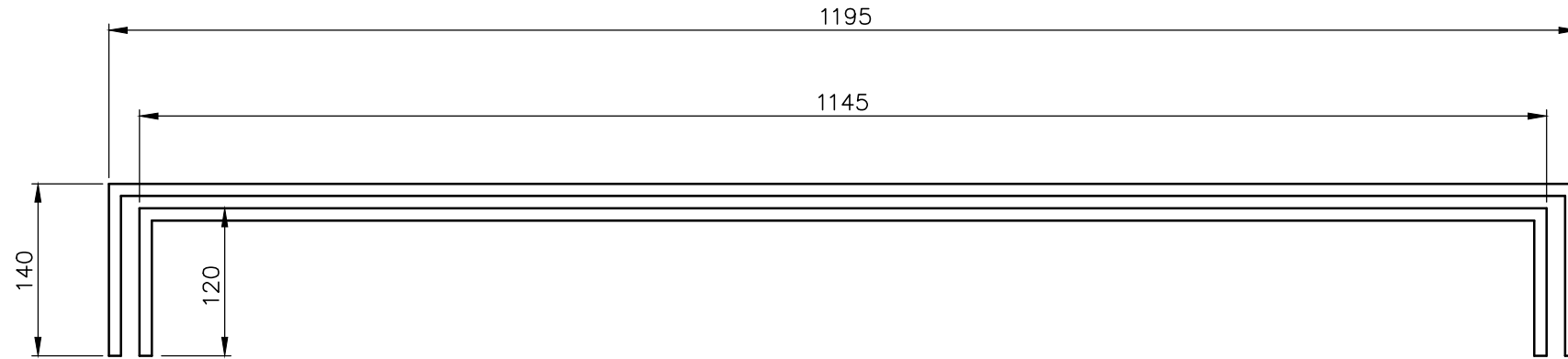

'X' (-) AXIS

FOR TENDERING PURPOSE ONLY

NOTE: -

1. SHEET THICKNESS AND FIXING ARRANGEMENT OF TELESCOPIC GUARD TO THE MACHINE TO BE ASCERTAINED BY THE SUPPLIER
2. MATERIAL: Fe 330 IS:1079

REV	DATE	ALTERED
		CHECKED
		APPROVED
ZONE		

ITEM NO		DESCRIPTION	DRAWING NO	MATL CODE	UNIT WT
				MATL SPEC	QTY
EQPT: HORIZONTAL BORING/NOMURA CNC BNF 130					
DEPT M&S		GRADE OF UNTOL. DIM	SCALE	WEIGHT (Kg)	REF TO ASSY DWG NO
CODE 2597		IS: 2102	1:5	-	REF TO OLD DWG NO -
TITLE			CARD CODE	DRAWING NO :	REV
TELESCOPIC GAURD			U 01	3-M-01B14-16699	00

CAUTION: THE INFORMATION ON THIS DOCUMENT IS THE PROPERTY OF BHARAT HEAVY ELECTRICALS LIMITED. IT MUST NOT BE USED DIRECTLY OR INDIRECTLY IN ANY WAY DETRIMENTAL TO THE INTEREST OF THE COMPANY.



Bharat Heavy Electricals Ltd
HIGH PRESSURE BOILER PLANT
TIRUCHIRAPALLI - 620014

DRN	NAME S.SELVAMANICKAM	SIGNATURE S. Selvamanickam	DATE 03.04.26
CHD	A.DANASEKAR	A. Danasekar	04.04.26
APPD	A.DANASEKAR	A. Danasekar	05.04.26

A3-SIZE



ALL DIMENSIONS ARE IN MILLIMETRES

DRAWING NO: 3-M-01B21-16694

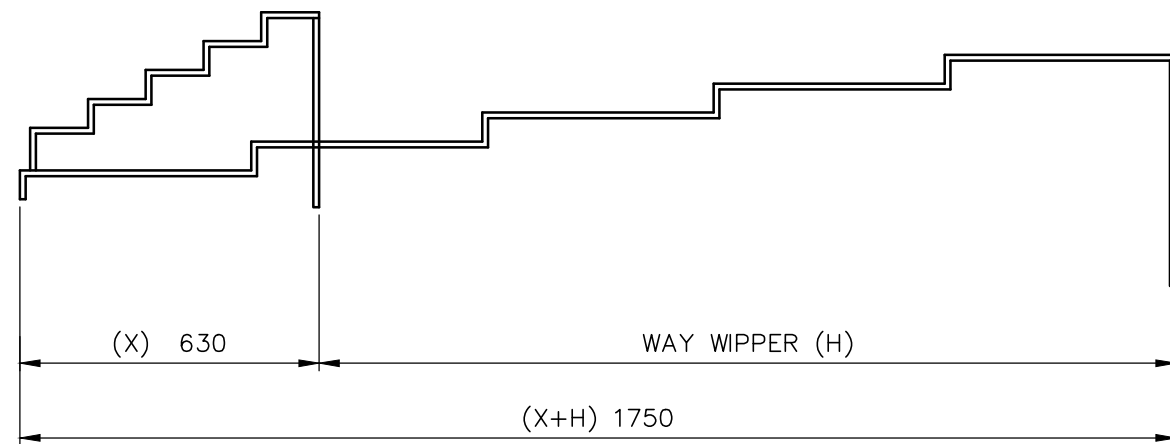
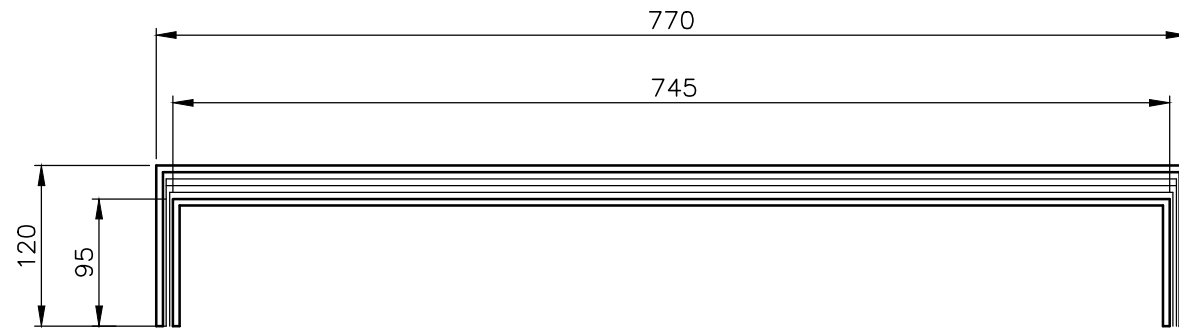

'X' (-) AXIS

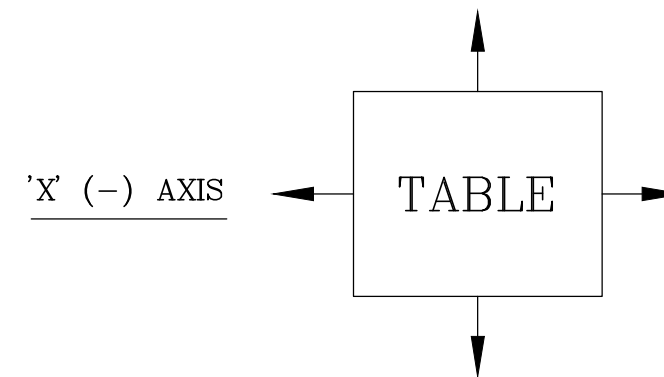

NOTE: -

1. SHEET THICKNESS AND FIXING ARRANGEMENT OF TELESCOPIC GUARD TO THE MACHINE TO BE ASCERTAINED BY THE SUPPLIER
2. MATERIAL: Fe 330 IS:1079

FOR TENDERING PURPOSE ONLY

REV	DATE	ALTERED
		CHECKED
		APPROVED
ZONE		

ITEM NO	DESCRIPTION	DRAWING NO	MATL CODE	UNIT WT
			MATL SPEC	QTY
EQPT: HORIZONTAL BORING /CBH-100				
 Bharat Heavy Electricals Ltd HIGH PRESSURE BOILER PLANT TIRUCHIRAPALLI - 620014		DRN	NAME S.SELVAMANICKAM	SIGNATURE <i>S. Selvamanickam</i>
		CHD	A.DANASEKAR	<i>A. Danasekar</i>
		APPD	A.DANASEKAR	<i>A. Danasekar</i>
DEPT M&S	GRADE OF UNTOL. DIM C/M/F IS: 2102	SCALE 1:5	WEIGHT (Kg) -	REF TO ASSY DWG NO -
CODE 2597				REF TO OLD DWG NO -
TITLE TELESCOPIC GAURD (X (-) AXIS)			CARD CODE U 01	DRAWING NO : 3-M-01B21-16694
				REV 00

CAUTION: THE INFORMATION ON THIS DOCUMENT IS THE PROPERTY OF BHARAT HEAVY ELECTRICALS LIMITED. IT MUST NOT BE USED DIRECTLY OR INDIRECTLY IN ANY WAY DETRIMENTAL TO THE INTEREST OF THE COMPANY.

A3-SIZE



ALL DIMENSIONS ARE IN MILLIMETRES

DRAWING NO: 3-M-01B23-16697

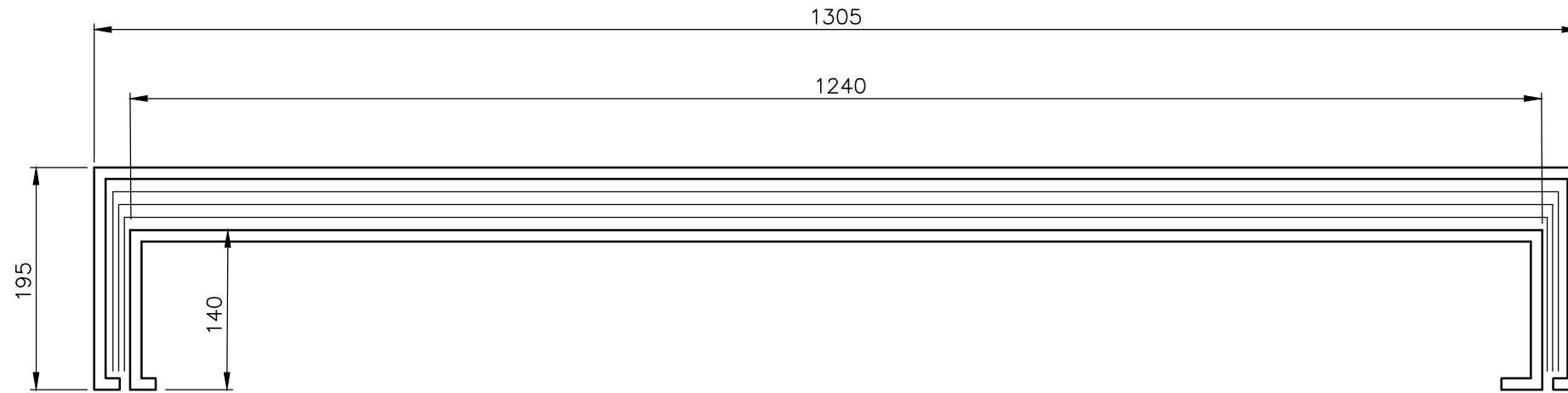

NOTE: -

1. SHEET THICKNESS AND FIXING ARRANGEMENT OF TELESCOPIC GUARD TO THE MACHINE TO BE ASCERTAINED BY THE SUPPLIER
2. MATERIAL: Fe 330 IS:1079

'X' (-) AXIS

FOR TENDERING PURPOSE ONLY

REV	DATE	ALTERED
		CHECKED
		APPROVED
ZONE		

ITEM NO		DESCRIPTION	DRAWING NO	MATL CODE	UNIT WT
				MATL SPEC	QTY
EQPT: AF 110-HMT HORIZONTAL BORING/AF110/HMT					
DEPT M&S		GRADE OF UNTOL. DIM	SCALE	WEIGHT (Kg)	REF TO ASSY DWG NO
CODE 2597		IS: 2102	1:5	-	REF TO OLD DWG NO -
TITLE			CARD CODE	DRAWING NO :	REV
TELESCOPIC GAURD (X (-) AXIS)			U 01	3-M-01B23-16697	00

CAUTION: THE INFORMATION ON THIS DOCUMENT IS THE PROPERTY OF BHARAT HEAVY ELECTRICALS LIMITED. IT MUST NOT BE USED DIRECTLY OR INDIRECTLY IN ANY WAY DETRIMENTAL TO THE INTEREST OF THE COMPANY.

A3-SIZE



ALL DIMENSIONS ARE IN MILLIMETRES

3-M-01B26-15911

DRAWING NO:

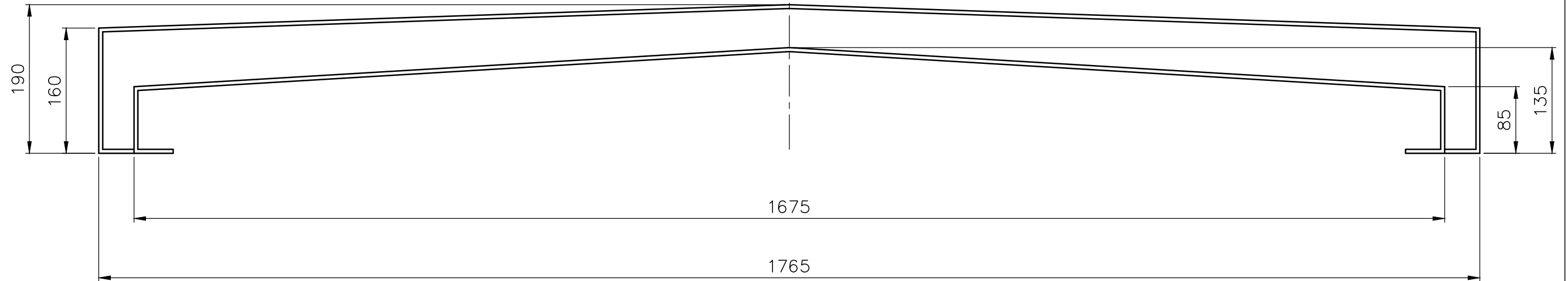

FOR TENDERING PURPOSE ONLY

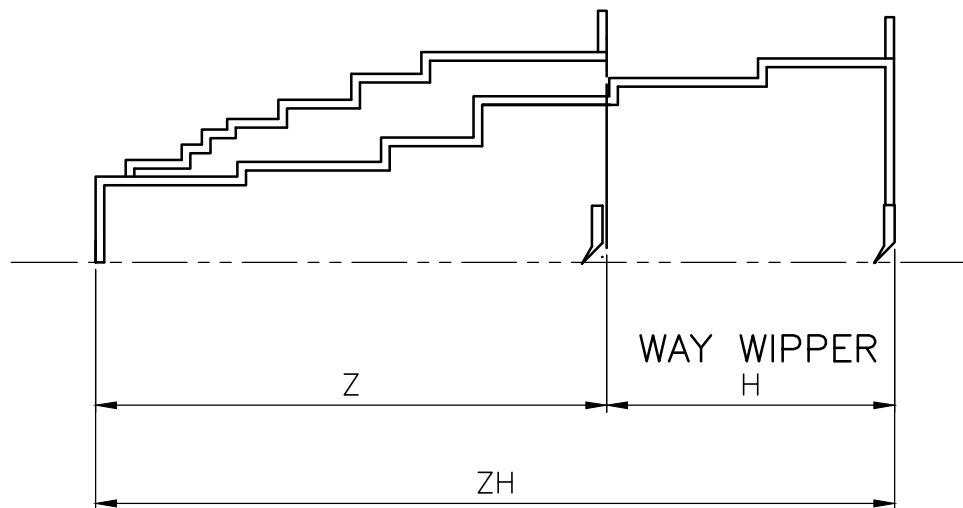

MIN.CLOSED LENGTH (Z) = 360MM

MAX.OPENING LENGTH (ZH) = 1830MM

REV	DATE	ALTERED
		CHECKED
		APPROVED
ZONE		

NOTE: -

SHEET THICKNESS AND FIXING ARRANGEMENT OF WALKON TYPE TELESCOPIC GUARD TO THE MACHINE TO BE ASCERTAINED BY THE SUPPLIER

MATERIAL : Fe330 IS:1079

ITEM NO		DESCRIPTION		DRAWING NO		MATL CODE		UNIT WT	
						MATL SPEC		QTY	
EQPT: HORIZONTAL BORING MACHINE / CNC / UTX 160 / 4802 4340									
DEPT M&S		GRADE OF UNTOL. DIM		SCALE		WEIGHT (Kg)		REF TO ASSY DWG NO	
2597		φ/M/£ IS: 2102		1:5				-	
TITLE		TELESCOPIC GUARD		CARD CODE		DRAWING NO :		REV	
		('W' AXIS / FRONT SIDE)		U 01		3-M-01B26-15911		00	

CAUTION: THE INFORMATION ON THIS DOCUMENT IS THE PROPERTY OF BHARAT HEAVY ELECTRICALS LIMITED. IT MUST NOT BE USED DIRECTLY OR INDIRECTLY IN ANY WAY DETRIMENTAL TO THE INTEREST OF THE COMPANY.



Bharat Heavy Electricals Ltd
HIGH PRESSURE BOILER PLANT
TIRUCHIRAPALLI - 620014

DRN	NAME	SIGNATURE	DATE
	N.MADURAVEERAN	<i>N. maduraveeran</i>	28.05.18
	G.GOVINDARAJ	<i>G. Govindaraj</i>	28.05.18
	S.MUTHURAJ	<i>S. Muthuraj</i>	28.05.18

DRAWING NO: 3-M-14A03-16701

ALL DIMENSIONS ARE IN MILLIMETRES

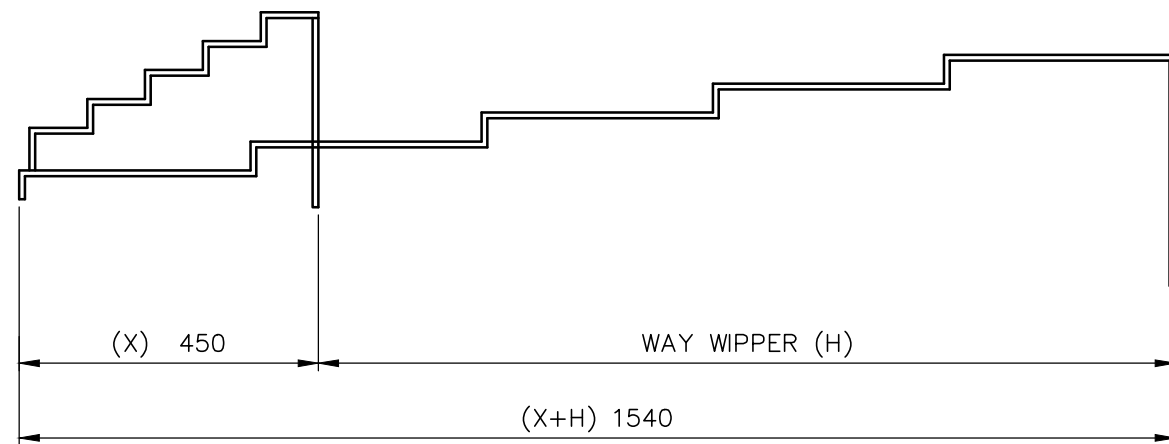
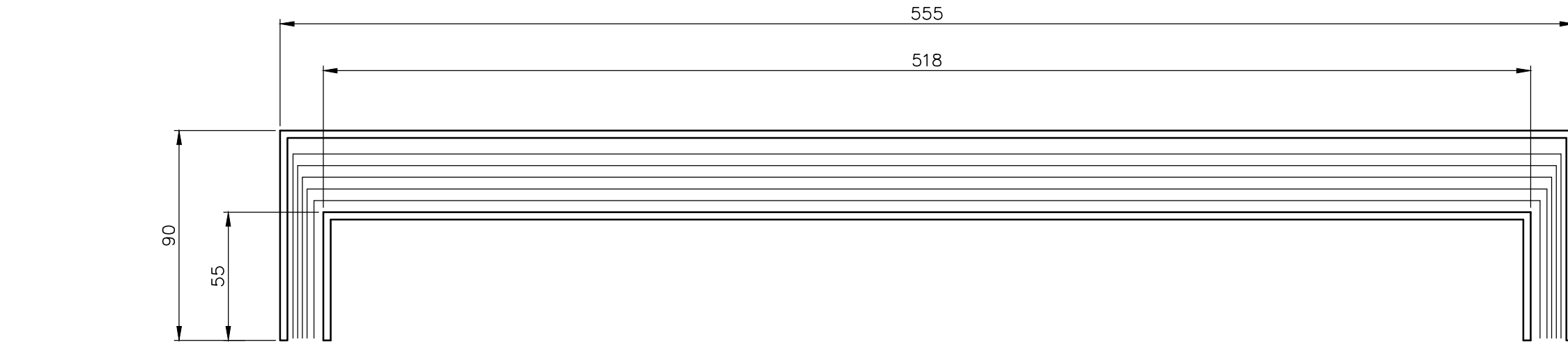

'X' (-) AXIS

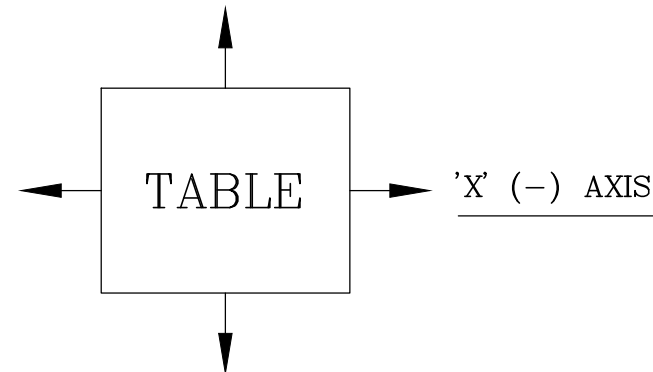

NOTE: -

1. SHEET THICKNESS AND FIXING ARRANGEMENT OF TELESCOPIC GUARD TO THE MACHINE TO BE ASCERTAINED BY THE SUPPLIER
2. MATERIAL: Fe 330 IS:1079

FOR TENDERING PURPOSE ONLY

REV	DATE	ALTERED
		CHECKED
		APPROVED
ZONE		

CAUTION: THE INFORMATION ON THIS DOCUMENT IS THE PROPERTY OF BHARAT HEAVY ELECTRICALS LIMITED. IT MUST NOT BE USED DIRECTLY OR INDIRECTLY IN ANY WAY DETRIMENTAL TO THE INTEREST OF THE COMPANY.

ITEM NO	DESCRIPTION	DRAWING NO	MATL CODE	UNIT WT	
			MATL SPEC	QTY	
EQPT: PAL-VA50 CNC VMC 840C-5S INTERMATE/VA50					
	Bharat Heavy Electricals Ltd HIGH PRESSURE BOILER PLANT TIRUCHIRAPALLI - 620014	DRN	NAME S.SELVAMANICKAM	SIGNATURE <i>S. Selvamanickam</i>	DATE 06.04.26
		CHD	A.DANASEKAR	<i>A. Danasekar</i>	06.04.26
		APPD	A.DANASEKAR	<i>A. Danasekar</i>	07.04.06
DEPT M&S	GRADE OF UNTOL. DIM C/M/F IS: 2102	SCALE 1:2	WEIGHT (Kg) -	REF TO ASSY DWG NO	ITEM
CODE 2597				REF TO OLD DWG NO -	
TITLE TELESCOPIC GAURD (X (-) AXIS)	CARD CODE U 01	DRAWING NO : 3-M-14A03-16701	REV 00		

A3-SIZE



Annexure – A- Special Conditions for GeM Enquiry

The terms and condition mentioned in this document are applicable in addition to the Buyer Added Bid Specific Additional Terms & Conditions and GeM General Terms and Conditions. Bidders shall furnish pointwise confirmation/details.

<i>To be filled by bidder</i>				
Description of the item/Equipment:				
GeM Tender No. & Date				
Name of the firm (Bidder)		:		
Address		:		
<u>Contact person 1</u>		<u>Contact person 2</u>		
Name:		Name:		
Designation:		Designation:		
Office Phone:		Office Phone:		
Mobile:		Mobile:		
e-mail:		e-mail:		
Sl	Terms and conditions/Details required			Vendor's confirmation
1.	Indicate the MSME status of the bidder. MICRO/SMALL/MEDIUM/Non-MSME (Udyam certificate is to be uploaded in proof of above).			
2.	Any Bidder falling under MSE category shall furnish the following details & submit documentary evidence/ Govt. Certificate etc. in support of the same along with their offer.			
	Type under MSE	SC/ST Owned	Women Owned	Others (excluding SC/ST & Women Owned)
	Micro			
	SMALL			
	Note: If the bidder does not furnish the above in the tender, offer shall be processed construing that the bidder is not falling under MSE category.			
3.	Payment terms shall be as per clause 9 of Buyer Added Bid Specific Additional Terms & Conditions for this tender. Confirm your acceptance for the payment terms relevance to your MSME status indicated above. Note: If it is indicated as "For availing benefits of Priority Sector Lending(PSL) ONLY" in Udyam certificate, then no MSME benefit will be considered for this tender.			
4.	Liquidated Damages shall be as per clause 18 of Buyer Added Bid Specific Additional Terms & Conditions. Confirm your acceptance.			

5.	Offers from Indigenous supplier will be considered only if they have a valid GST registration certificate. Please Indicate the GST registration number. If any specific exemption is available, a declaration with due supporting documents need to be furnished for considering the offer.	GST No. _____
6.	Performance Bank Guarantee: Not Applicable	
7.	HSN Code for the quoted items	HSN CODE : _____
8.	Rate quoted in GeM portal should be on FOR destination basis inclusive of all taxes, P&F, freight etc. Transit Insurance is under Supplier scope. Please indicate how much GST percentage is included in quoted price.	GST in %: _____
9.	Technical (Specification, brand, etc.) and commercial terms agreed against BHEL clarifications during the techno-commercial evaluation stage should also be honoured by the bidder, even if they aren't explicitly part of the final GeM contract. The rationale behind this is that such agreements influence the final decision and are not captured by GeM in to the GeM contract. Please confirm your acceptance.	
10.	All the terms and conditions in Buyer Added Bid Specific Additional Terms & Conditions of this tender are read, understood and agreed by the vendor without any deviation. Vendor to confirm.	
11.	Duly filled, signed and stamped copies of the annexures as indicated in clause 31 of Buyer Added Bid Specific Additional Terms & Conditions of the enquiry are to be provided in the letter head of the Supplier. Please fill the annexures with GeM enquiry number, Item description and your company name wherever required. Also please Tick the appropriate option wherever required.	
12.	There will not be any RA (Reverse Auction). Hence suppliers to quote their best price while submitting their offer itself.	

Vendor's Seal & Signature

CHECK LIST

NOTE: - Suppliers are required to fill in the following details in their Letterhead and no column should be left blank

A	Name and Address of the Supplier		
B	GSTN No. the Supplier (Place of Execution of Contract / Purchase Order)		
C	Details of Contact person for this Tender	Name: Mr./ Ms. Designation: Telephone No: Mobile No: Email ID:	
D	EMD DETAILS	Not applicable	
E	DESCRIPTION	APPLICABILITY (BY BHEL)	ENCLOSED BY BIDDER
i.	Whether Pre - Qualification Criteria is understood and provided proper supporting documents.	Applicable/ Not Applicable	YES / NO
ii.	Whether all pages of the Tender documents including annexures, appendices etc are read and understood	Applicable/ Not Applicable	YES / NO
iii.	Audited Balance Sheet and profit & Loss Account for the last three years	Applicable/ Not Applicable	YES / NO
iv.	Copy of PAN Card & GST registration	Applicable/ Not Applicable	YES / NO
v.	Submission of Udyam certificate as specified in Tender (applicable in case of MSME supplier)	Applicable/ Not Applicable	YES / NO
vi.	Offer forwarding letter / tender submission letter as per Annexure – 2	Applicable/ Not Applicable	YES / NO
vii.	Submission of Certificate of No Deviation as per Annexure – 3	Applicable/ Not Applicable	YES / NO
viii.	Declaration regarding Insolvency/ Liquidation/ Bankruptcy Proceedings as per Annexure – 4	Applicable/ Not Applicable	YES / NO
ix.	Declaration by Authorized Signatory as per Annexure – 5	Applicable/ Not Applicable	YES / NO
x.	Declaration by Authorized Signatory regarding Authenticity of submitted Documents Annexure – 6	Applicable/ Not Applicable	YES / NO
xi.	Submission of Non-Disclosure Certificate as per Annexure – 7	Applicable/ Not Applicable	YES / NO
xii.	Submission of Integrity Pact as specified in Tender as per Annexure – 8	Applicable/ Not Applicable	YES / NO
xiii.	Declaration confirming knowledge about Site Conditions as per Annexure – 9	Applicable/ Not Applicable	YES / NO

xiv.	Declaration reg. Related Firms & their areas of Activities as per Annexure – 10	Applicable/ Not Applicable	YES / NO
xv.	Declaration for relation in BHEL as per Annexure – 11	Applicable/ Not Applicable	YES / NO
xvi.	Declaration reg. minimum local content in line with revised public procurement as per Annexure – 12	Applicable/ Not Applicable	YES / NO
xvii.	Declaration regarding compliance to Restrictions under Rule 144 (xi) of GFR 2017 as per Annexure – 13	Applicable/ Not Applicable	YES / NO
xviii.	Bank Account Details for E-Payment as per Annexure – 14	Applicable/ Not Applicable	YES / NO
xix.	Power of Attorney for submission of tender as per Annexure – 15	Applicable/ Not Applicable	YES / NO
xx.	Proforma of Bank Guarantee for Earnest Money as per Annexure – 16	Applicable/ Not Applicable	YES / NO
xxi.	Treatment of cases regarding conflict of interest as per Annexure – 20	Applicable/ Not Applicable	YES / NO

NOTE: Strike off 'YES' or 'NO', as applicable. Tender not accompanied by the prescribed **above applicable documents** are liable to be summarily rejected.

DATE:

**Sign. of the AUTHORISED SIGNATORY
(With Name, Designation and Company seal)**

CERTIFICATE OF NO DEVIATION

(To be Typed & submitted in the Letter Head of the Company/Firm of Bidder)

To,

(Write Name & Address of Officer of BHEL inviting the Tender)

Dear Sir,

Subject: **No Deviation Certificate**

Ref: 1) GeM Bid No:

2) All other pertinent issues till date

We hereby confirm that we have not changed/ modified/materially altered any of the tender documents as downloaded from the website/ issued by BHEL and in case of such observance at any stage, it shall be treated as null and void.

We also hereby confirm that we have neither set any Terms and Conditions and nor have we taken any deviation from the Tender conditions together with other references applicable for the above referred GeM Bid.

We further confirm our unqualified acceptance to all Terms and Conditions, unqualified compliance to Tender Conditions.

We confirm to have submitted offer in accordance with tender instructions and as per aforesaid references.

Thanking you,

Yours faithfully,

**(Signature, date & seal of
authorized representative of the
bidder)**

Date:

Place:

UNDERTAKING

(To be typed and submitted in the Letter Head of the Company/Firm of Bidder)

To,

(Write Name & Address of Officer of BHEL inviting the Tender)

Dear Sir/Madam,

Sub: DECLARATION REGARDING INSOLVENCY/ LIQUIDATION/ BANKRUPTCY PROCEEDINGS

Ref: GeM Bid Specification No:

I/We, _____ declare that, I/We am/are not admitted under insolvency resolution process or liquidation under Insolvency and Bankruptcy Code, 2016, as amended from time to time or under any other law as on date, by NCLT or any adjudicating authority/authorities

**Sign. of the AUTHORISED SIGNATORY
(With Name, Designation and Company seal)**

Place:

Date:

DECLARATION BY AUTHORISED SIGNATORY OF BIDDER

(To be typed and submitted in the Letter Head of the Company/Firm of Bidder)

To,

(Write Name & Address of Officer of BHEL inviting the Tender)

Dear Sir,

Sub: **Declaration by Authorised Signatory regarding Authenticity of submitted documents.**

Ref: 1) GeM Bid No. & Date:

2) All other pertinent issues till date

I/We, hereby certify that all the documents submitted by us in support of possession of "Qualifying Requirements" are true copies of the original and are fully compliant required for qualifying / applying in the bid and shall produce the original of same as and when required by Bharat Heavy Electricals Limited.

I / We hereby further confirm that no tampering is done with documents submitted in support of our qualification as bidder. I / We understand that at any stage (during bidding process or while executing the awarded contract) if it is found that fake / false / forged bid qualifying / supporting documents / certificates were submitted, it would lead to summarily rejection of our bid / termination of contract. BHEL shall be at liberty to initiate other appropriate actions as per the terms of the Bid / Contract and other extant policies of Bharat Heavy Electricals Limited.

Yours faithfully,

(Signature, Date & Seal of Authorized Signatory of the Bidder)

Date:

NON-DISCLOSURE CERTIFICATE

(To be Typed & submitted in the Letter Head of the Company/Firm of Bidder)

I/We understand that BHEL, Trichy is committed to Information Security Management System as per their Information Security Policy.

Hence, I/We M/s who are submitting offer for providing Supply/services to BHEL, Trichy against GeM Bid No..... hereby undertake to comply with the following in line with Information Security Policy of BHEL, Trichy.

- To maintain confidentiality of documents & information which shall be used during the execution of the Contract.
- The documents & information shall not be revealed to or shared with third party which shall not be in the business interest of BHEL, Trichy.

(Signature, date & seal of Authorized Signatory of the bidder)

Date:

DECLARATION

Date: _____

To,

(Write Name & Address of Officer of BHEL inviting the Tender)

Dear Sir/ Madam,

Sub: Details of related firms and their area of activities

Please find below details of firms owned by our family members that are doing business/ registered for same item with BHEL, _____ (NA, if not applicable)

1	Material Category/ Work Description	
	Name of Firm	
	Address of Firm	
	Nature of Business	
	Name of Family Member	
	Relationship	
2	Material Category/ Work Description	
	Name of Firm	
	Address of Firm	
	Nature of Business	
	Name of Family Member	
	Relationship	
...		

Note: I certify that the above information is true and I agree for penal action from BHEL in case any of the above information furnished is found to be false.

Regards,

(_____)

From: M/s

Supplier

Code:

Address:

DECLARATION FOR RELATION IN BHEL

(To be typed and submitted in the Letter Head of the Company/Firm of Bidder failing which the offer of Bidder is liable to be summarily rejected)

To,

(Write Name & Address of Officer of BHEL inviting the Tender)

Dear Sir,

Sub: Declaration for relation in BHEL

Ref: 1) GeM Bid Specification No:

I/We hereby submit the following information pertaining to relation/relatives of Proprietor/Partner(s)/ Director(s) employed in BHEL

Tick (✓) any one as applicable:

1. The Proprietor, Partner(s), Director(s) of our Company/Firm DO NOT have any relation or relatives employed in BHEL

OR

2. The Proprietor, Partner(s), or Director(s) of our Company/Firm HAVE relation/relatives employed in BHEL and their particulars are as below:

i.

ii.

**(Signature, Date & Seal of
Authorized Signatory of the Bidder)**

Note:

1. Attach separate sheet, if necessary.
2. If BHEL Management comes to know at a later date that the information furnished by the Bidder is false, BHEL reserves the right to take suitable against the Bidder/Contractor.

**DECLARATION REGARDING MINIMUM LOCAL CONTENT IN LINE WITH
REVISED PUBLIC PROCUREMENT (PREFERENCE TO MAKE IN INDIA), ORDER
2017 DATED 04TH**

JUNE, 2020 AND SUBSEQUENT ORDER(S)

(To be typed and submitted in the Letter Head of the Entity/Firm providing certificate as applicable)

To,

(Write Name & Address of Officer of BHEL inviting the Tender)

Dear Sir,

Sub: Declaration reg. minimum local content in line with Public Procurement (Preference to Make in India), Order 2017-Revision, dated 04th June, 2020 and subsequent order(s).

Ref: 1) GeM Bid Specification No:

2) All other pertinent issues till date

We hereby certify that the items/works/services offered by.....
(specify the name of the organization here) has a local content of _____ % and this meets the local content requirement for '**Class-I local supplier**' / '**Class II local supplier**' ** as defined in Public Procurement (Preference to Make in India), Order 2017-Revision dated 04.06.2020 issued by DPIIT and subsequent order(s).

The details of the location(s) at which the local value addition is made are as follows:

- | | |
|----------|----------|
| 1. _____ | 2. _____ |
| 3. _____ | 4. _____ |

Thanking you,
Yours faithfully,

**(Signature, Date & Seal of
Authorized Signatory of the
Bidder)**

** - Strike out whichever is not applicable.

Note:

1. Bidders to note that above format, duly filled & signed by authorized signatory, shall be submitted along with the techno-commercial offer.
2. In case the bidder's quoted value is in excess of Rs. 10 crores, the authorized signatory for this declaration shall necessarily be the statutory auditor or cost auditor of the company (in the case of companies) or a practising cost accountant or practicing chartered accountant (in respect of suppliers other than companies).
3. In the event of false declaration, actions as per the above order and as per BHEL Guidelines shall be initiated against the bidder.

DECLARATION REGARDING COMPLIANCE TO RESTRICTIONS UNDER RULE 144 (xi) OF GFR 2017

(To be typed and submitted in the Letter Head of the Entity/ Firm providing certificate as applicable)

To,

(Write Name & Address of Officer of BHEL inviting the Tender)

Dear Sir,

Sub: Declaration regarding compliance to Restrictions under Rule 144 (xi) of GFR 2017

Ref: 1) GeM Bid Specification No:
2) All other pertinent issues till date

I have read the clause regarding restrictions on procurement from a bidder of a country which shares a land border with India. I certify that _____ (**SPECIFY THE NAME OF THE ORGANIZATION HERE**), is not from such a country/ has been registered with the Competent Authority (*attach valid registration by the Competent Authority, i.e., the Registration Committee constituted by the Dept. for Promotion of Industry and Internal Trade (DPIIT)*).

I hereby certify that we fulfil all requirements in this regard and is eligible to be considered.

Thanking you,

Yours faithfully,

**(Signature, Date & Seal of
Authorized Signatory of the Bidder)**

Note: Bidders to note that in case above certification given by a bidder, whose bid is accepted, is found to be false, then this would be a ground for immediate termination and for taking further action in accordance with law and as per BHEL guidelines.

TREATMENT OF CASES REGARDING CONFLICT OF INTEREST

The bidder notes that a conflict of interest would said to have occurred in the tender process and execution of the resultant contract, in case of any of the following situations:

i) If its personnel have a close personal, financial, or business relationship with any personnel of BHEL who are directly or indirectly related to the procurement or execution process of the contract, which can affect the decision of BHEL directly or indirectly;

ii) The bidder (or his allied firm) provided services for the need assessment/ procurement planning of the Tender process in which it is participating;

iii) Procurement of goods directly from the manufacturers/ suppliers shall be preferred. However, if the OEM/Principal insists on engaging the services of an agent, such agent shall not be allowed to represent more than one manufacturer/ supplier in the same tender. Moreover, either the agent could bid on behalf of the manufacturer/ supplier or the manufacturer/ supplier could bid directly but not both. In case bids are received from both the manufacturer/ supplier and the agent, bid received from the agent shall be ignored. However, this shall not debar more than one Authorised distributor (with/ or without the OEM) from quoting equipment manufactured by an Original Equipment Manufacturer (OEM) in procurements under a Proprietary Article Certificate.

iv) A bidder participates in more than one bid in this tender process. Participation in any capacity by a Bidder (including the participation of a Bidder as a partner/ JV member or sub-contractor in another bid or vice-versa) in more than one bid shall result in the disqualification of all bids in which he is a party. However, this does not limit the participation of an entity as a sub-contractor in more than one bid if he is not bidding independently in his own name or as a member of a JV.

The Bidder declares that they have read and understood the above aspects, and the bidder confirms that such conflict of interest does not exist and undertakes that they will not enter into any illegal or undisclosed agreement or understanding, whether formal or informal with other Bidder(s), in this regard. This applies in particular to prices, specifications, certifications, subsidiary contracts, submission or non-submission of bids or any other actions to restrict competitiveness or to introduce cartelization in the bidding process. **In case, the Bidder is found having indulged in above activities, the same will be considered as a violation of the tender conditions, and suitable action shall be taken by BHEL as per extant policies/ guidelines.**

(Signature, Date & Seal of Authorized
Signatory of the Bidder)