	<b>SOLAR BUSINESS DIVISION</b>	<b>NOTICE INVITING TENDER (NIT)</b>	<b>MATERIAL: Monocrystalline DCR PV Module</b>
<b>TENDER REFERENCE: SPKSCP074</b>			

Dear Sir,

**Subject: Tender for "Monocrystalline DCR PV Module".**

BHEL invites offers from reputed Vendors {Refer Pre-qualifying (PQR) requirements and other requirements given in tender enquiry letter uploaded on our websites) for supply including packing & transportation to as per incoterms, satisfactory completion of Supply of "**Monocrystalline DCR PV Module**" as per Tender **Ref: SPKSCP074**".

Your offer shall be submitted in two parts strictly as per "Instructions to Bidders" of GCC, Rev R0 in sealed covers.

Your best quotation / offer for the above requirement, in line with our terms and conditions, should either be delivered in person or sent by COURIER/REGISTERED POST, to the following address only:

**BHEL- EPD/SBD Tender box (Reception of SBD)**

C/o. **AGM/MM**

M/s BHARAT HEAVY ELECTRICALS LTD. (SOLAR BUSINESS DIVISION (SBD)),  
 Prof CNR Rao Circle, IISc Post, Malleswaram, Bangalore- 560 012  
 Ph. No. +91-080-22182430, 080-22182269, +91-080-22182286.

**Offer can also be submitted thru email to email ids specified below only:-**

PART-A (I) BID i.e. TECHNICAL BID on [technicalbid-epd@bhel.in](mailto:technicalbid-epd@bhel.in)

PART-B (II) BID i.e. PRICE BID on [pricebid-epd@bhel.in](mailto:pricebid-epd@bhel.in)

**NOTE:-**

1. Tender reference & due date to be mentioned in subject of mail.
2. Bidders may adopt this mode at their own risk. The Purchaser does not own any responsibility /liability for delays in receipt / loss of secrecy of such offers.

It shall be the responsibility of the bidder to ensure that the tender is delivered on or before the due date by **02:00 P.M.** **The offer has to be deposited in tender box only.** Part-I bids shall be opened at **02:30 P.M.** on the due date in the presence of authorized representatives of the bidders, who may like to be present.

The bidder is required to clearly mention

1. Tender Ref., RFQ/Tender Due Date & Name of the item in BOLD LETTERS on the top of each envelope submitted.
2. Name and contact details (including mobile no. and email address) of minimum one contact person along with date of submission of offer in a cover letter.

**ENQUIRY TERMS AND CONDITIONS**

The prices offered shall be firm till the completion of project.

1. Tender Ref No., due date etc. must be legibly super scribed on the sealed envelopes as per clause no. 2.0 of "Instructions to Bidders of GCC, Rev. R0".
2. Offers should be submitted in two parts in two separate sealed covers as follows:  
 Part-I: **TECHNO-COMMERCIAL BID** Part-II: **PRICE BID.**  
**For detailed instructions. Please see "Instructions to Bidders of GCC Rev. R0".**
3. Bidders shall submit their offers meeting the requirements of the following tender documents (enclosed) included in this Enquiry Letter :

	<b>SOLAR BUSINESS DIVISION</b>	<b>NOTICE INVITING TENDER (NIT)</b>	<b>MATERIAL: Monocrystalline DCR PV Module</b>
<b>TENDER REFERENCE: SPKSCPV074</b>			

General Conditions of Contract (GCC) Rev R0 comprising of: Instructions to Bidders and General Commercial Terms & Conditions. Technical Specification, Price format & Special Conditions of Contract (SCC).

4. Tenders shall be submitted strictly in accordance with the requirements of the above tender documents. In case of deviations (Technical/ Commercial), the same shall be highlighted separately giving clause references along with the **Cost of withdrawal of Deviations as per Annexure-II to GCC Rev. R0 of "DEVIATION SHEET (COST OF WITHDRAWAL)"** along with reasons for taking such deviations.

Cost of withdrawal for the deviations, for which, the "Cost of withdrawal" is not specified, shall be taken as NIL. **Bidder to note all the points mentioned in "Notes" of Annexure-II to GCC Rev.R0.**

5. All the above Tender Documents shall automatically become a part of the Order / Contract after its finalisation.
6. Bidder has to submit "NO DEVIATION CERTIFICATE FOR COMMERCIAL TERMS AND CONDITIONS as per General Conditions of Contracts (GCC, Rev.R0), Special Conditions of Contracts and Notice Inviting Tender (NIT)" **in case of no deviations.**
7. Purchaser shall be under no obligation to accept the lowest or any other tender and shall be entitled to accept or reject any/all tender(s) in part or full without assigning any reason whatsoever.
8. Late tenders are liable to be rejected.
9. All correspondence thereof, shall be addressed to the undersigned by name & designation and sent at the following address:

<p><b>Commercial</b> S Pankaj Kumar- Dy Manager-MM Manjunath Rao- Engineer-MM. BHEL-SBD, Prof CNR Rao Circle, IISc Post, Malleswaram, Bangalore- 560 012 E-MAIL: <a href="mailto:spankaj@bhel.in">spankaj@bhel.in</a> ; Ph. No. +91-080-22182269, 8126333426</p>	<p><b>Technical</b> Muhammed Shakir-Sr. Engineer BHEL-SBD, Prof CNR Rao Circle, IISc Post, Malleswaram, Bangalore- 560 012 E-MAIL: <a href="mailto:muhammedshakir@bhel.in">muhammedshakir@bhel.in</a> ; Ph. No. +91-080-22182357, +91 9620879978</p>
--	--

10. Bidders, who are not registered with BHEL-SBD, are requested to get registered through online supplier registration portal available on <https://supplier.bhel.in/>
11. BHEL shall be resorting to Reverse Auction (RA) (Guidelines as available on ([www.bhel.com](http://www.bhel.com))) for this tender. RA shall be conducted among the techno commercially qualified bidders. Price bids of all techno-commercially qualified bidders shall be opened and same shall be considered for RA. In case any bidder(s) do(es) not participate in online Reverse Auction, their sealed envelope price bid along with applicable loading, if any, shall be considered for ranking."  
Bidders are required to submit their acceptance to the terms/ conditions/ modalities before participating in the Reverse Auction in the process compliance form as enclosed. Without this, the bidder will not be eligible to participate in the event.
12. The evaluation of the offer shall be done on the basis of delivered cost (i.e. Total F.O.R. BHEL SBD stores, Bangalore price for supply with necessary loadings as applicable) as per GCC Rev. R0.
13. Please note that detailed offers are to be submitted including the following documents duly stamped & signed on each page:
14. Acceptance of GCC, Rev.R0.
15. Acceptance of Special Conditions of Contract (SCC).
16. Pre-qualifying Requirements (PQRs) documents including Technical Bid Format with supporting documents.

	<b>SOLAR BUSINESS DIVISION</b>	<b>NOTICE INVITING TENDER (NIT)</b>	<b>MATERIAL: Monocrystalline DCR PV Module</b>
<b>TENDER REFERENCE: SPKSCP074</b>			

17. Technical Deviations and commercial deviations, if any as per format enclosed at Annexure-II of GCC, Rev.R0.
18. Annexure – I, III, VII, XIII, XIV, XVIII & XIX of GCC Rev R0.
19. Along with your offer, please submit a copy of this letter duly signed & stamped on each page as token of acceptance of all terms & instructions conveyed.
20. Un-Priced price schedules (format) duly filled in 'Quoted' or 'Q' in each column/row.
21. Separate sealed price-bid envelope mentioning Tender/Enquiry No., RFQ due date & Name of the item in BOLD LETTERS on the top of envelope.

**Note: Bidder must submit UN-PRICED Price format duly filled mentioning the word "QUOTED" in place of actual price. The actual price is to be filled in separately and submitted in sealed price bid.**

22. Bidders to keep visiting BHEL website i.e [www.bhel.com](http://www.bhel.com) for any Amendments/Clarifications/Corrigenda/Errata etc issued in respect of the tender documents by BHEL. Same shall be uploaded on above BHEL website.
23. Order of Precedence.

In the event of any ambiguity or conflict between the Tender Documents, the order of precedence shall be in the order below:

1. Amendments/Clarifications/Corrigenda/Errata etc. issued in respect of the tender documents by BHEL.
2. Notice Inviting Tender (NIT)
3. Price Schedule (either option A or option B)
4. Special Conditions of Contract (SCC)
5. Technical specification & scope of work
6. General Conditions of Contract (GCC)

Thanking You.  
Yours faithfully,

For and on behalf of BHEL

(S Pankaj Kumar)  
**Dy.Manager-MM**

**Enclosures:**

1. Enquiry Letter with Terms & Conditions (This letter)  
RFQ, PQR, QAP's & Technical Specifications No. **PS-439-420 Rev 01**
2. Special Conditions of Contracts (SCC)
3. Price formats/schedules (Prices should be quoted strictly in this format only)
4. General Conditions of Contracts (GCC Rev R0)
5. Conciliation Scheme
6. Integrity Pact

 A4-11	<b>PURCHASE SPECIFICATION GROUP: PHOTOVOLTAICS</b>	Spec. No	PS-439-420
		Rev. No	01
		Page 1 of 10	

## COPYRIGHT AND CONFIDENTIAL

The information on this document is the property of Bharat Heavy Electricals Limited.  
It must not be used directly or indirectly in anyway detrimental to the interest to the company

### TECHNICAL SPECIFICATION FOR SUPPLY OF MONOCRYSTALLINE SILICON PV MODULES Henrietta (Phase - II), MAURITIUS

<b>Revision details: (01)</b>  <b>Clause No 9, benefits for higher wattage rated PV modules is added</b>	Prepared By MS	Reviewed By RGV	<b>DATE</b>  <b>09.12.2021</b>
	Approved By PSP	ISSUED SPV ENGG	

 <p>बि. एच. ई. लि. A4-11</p>	<b>PURCHASE SPECIFICATION GROUP: PHOTOVOLTAICS</b>	Spec. No	PS-439-420
		Rev. No	01
		Page 2 of 10	

### 1. PRE-QUALIFICATION CRITERIA (PQC) :

Sl. No	Particulars	Bidder's confirmation
1.	The offer shall be quoted only by the original PV module manufacturer with module manufacturing capacity of 50 MW / annum.	PV module supplier name: Manufacturing Plant Location: Manufacturing capacity / annum : Website: (Please mention name of PV module manufacturer, capacity, complete address & contact details with email address. Please enclose documentary evidence for PV module manufacturing capacity)
2.	PV modules offered shall be of DCR type (Solar cells and PV Modules of Indian make).	Yes / No Solar cell make that will be used :  Pl. enclose tie-up letter with Indian Solar cell manufacturer for supply of solar cells
3.	During technical evaluation, Credentials of vendors will be submitted to BHEL's customer for approval. Only those vendors, who are technically qualified and approved by BHEL's customer before price bid opening /RA, will be considered for further procurement processing.	Accepted / Not accepted

#### **Note A :**

- i. Pre-qualification will be carried out based on the details furnished by the vendor / purchase orders, documents from their customers/ inspection of the company/product, if required by BHEL and at its sole discretion.
- ii. The pre-qualification criteria are mandatory requirements and the technical bids will be considered only if all the above Pre-Qualification Criteria are met.

#### **COPYRIGHT AND CONFIDENTIAL**

**The information on this document is the property of Bharat Heavy Electricals Limited.  
It must not be used directly or indirectly in anyway detrimental to the interest of the company**

 <p>बि. एच. ई. लि. A4-11</p>	<b>PURCHASE SPECIFICATION GROUP: PHOTOVOLTAICS</b>	Spec. No	PS-439-420
		Rev. No	01
		Page 3 of 10	

## 2. TECHNICAL REQUIRMENTS:

Sl. No	Item	Remarks
1	PV Module Configuration	Monocrystalline (PERC) photovoltaic module with 72 nos of cells in 12X6 series configuration or 144 cells in 24X6 configuration. The module construction and bill of material shall be as per vendor's approved IEC certification. <b>Please enclose:</b> <b>i. Module overall assembly drawing with mounting holes</b> <b>ii. Data sheet with typical electrical characteristics, I-V curves, temperature coefficients etc.</b>
1.a	DCR PV Module	The modules for this project are of DCR type. Hence, only Solar cells of Indian make to be used in the module and modules to be manufactured and supplied by Indian PV module manufacturer.
2	Power Output	360 to 545 Watts, in 5 Watt band only. No negative power tolerance will be accepted.
3	System Voltage	Modules shall be suitable for 1500V DC System Voltage application.
4	Efficiency	Cell efficiency 21% (min) under STC
5	Fill Factor	70 % (min)
6	Temp coefficient of Power Pmax (%)	-0.39% / °C or better
7	Operating Conditions	SPV module shall perform satisfactorily in humidity up to 85% with ambient temperatures between 0° C & + 55° C, shall capable of resisting damage when subject to hailstorms of a maximum diameter of 28mm with impact speed of 86KM/h. Also, SPV module shall withstand adverse climatic conditions, such as gust speed of 280 kmph.
8	IEC Certifications	The PV modules supplied shall follow IEC standards as below. 1. IEC 61215-1:2016 (Design Qualification and Type Approval-Part 1) 2. IEC 61215-1-1:2016 (Design Qualification and Type Approval-Part 1-1) 3. IEC 61215-2:2016 (Design Qualification and Type Approval-Part 2) 4. IEC 61730-1:2016 (Safety Qualification – Part 1) 5. IEC 61730-2:2016 (Safety Qualification – Part 2) 6. IEC 62804-1:2015- (Test methods for the detection of PID - Part 1) 7. IEC 61701:2011 (Salt Mist Corrosion testing) 8. EN 50380 – Data sheet and name plate information of photovoltaic module. 9. IEC61853 -1 ( PV module performance testing and energy testing Part-1 : Irradiance and temperature performance measurements and power rating.) 10. IEC 60364-4-41 (Protection against electric shock)

### COPYRIGHT AND CONFIDENTIAL

The information on this document is the property of Bharat Heavy Electricals Limited.  
It must not be used directly or indirectly in anyway detrimental to the interest of the company

 <p>बि. एच. ई. लि. A4-11</p>	<b>PURCHASE SPECIFICATION GROUP: PHOTOVOLTAICS</b>	Spec. No	PS-439-420
		Rev. No	01
		Page 4 of 10	

		Vendors shall use Bill of materials for manufacture of PV modules as per subset of approved CDF of IEC Certificates. <b>All IEC Certificates to be submitted with tender.</b>
9	Module Safety Class	Safety Class – II
10	BILL OF MATERIALS	
10.1	Solar cells	<b>Type : Mono Crystalline solar cells</b> Pl. indicate <b>Cell Source :</b> <b>Size of Cells :</b> <b>Cell efficiency :</b> <b>No. of busbars</b> <b>Enclose a copy of Solar cell data sheet with electrical parameters.</b>
10.2	EVA	Fast cure type, UV resistant, Gel content > 70 %.
10.3	Glass	High transmission (> 90 %), low iron, toughened glass with minimum thickness of 3.2 mm and bending less than 0.3%. The modules shall be capable of resisting damage when subjected to hailstorms of a maximum diameter of 28 mm with impact speed of 86 km/h. The bidder shall have to furnish a certificate to ensure that the front glass surface is capable of withstanding such impact.
10.4	Back Sheet	The back sheet used in the crystalline silicon based modules shall be of 3 layered structure. The thickness of back sheet should be of minimum 300 microns with water vapour transmission rate less than 2.0 g/ m <sup>2</sup> /day (38°C at 90% RH). The Back sheet can be fluoro polymer based or of any other well proven technology. The backsheet shall have globally benchmarked durability properties on Moisture barrier, Tensile Strength (Machine Direction & Transverse Direction), Elongation retention and UV stability and shall be able to withstand system voltage of 1500 V.
10.5	PV Module Frame	Corrosion resistant, anodized Aluminum. The anodizing thickness shall be 15 microns or better. The frame shall be designed to withstand a gust speed of 280 kmph. Detailed installation manual including special clamping arrangement, If any, to be submitted.
10.6	Junction box	IP67 grade with 3 nos. of bypass diodes, UV resistant & weather-proof. The module junction box shall have hinged, weather proof lid with captive screws and cable gland entry points or may be of sealed type. The module junction boxes shall in compliance with IEC 60670 and be of class II insulation & IEC 62790:2014, of material able to withstand abnormal heat and fire up to 960°C, in compliance with IEC 60695-2-11 and rated insulation 1500 Vdc. Moreover, since module side of the DC PV system remains alive during the day, a clear

**COPYRIGHT AND CONFIDENTIAL**

**The information on this document is the property of Bharat Heavy Electricals Limited.  
It must not be used directly or indirectly in anyway detrimental to the interest of the company**

 <p>बि. एच. ई. लि. A4-11</p>	<b>PURCHASE SPECIFICATION GROUP: PHOTOVOLTAICS</b>	Spec. No	PS-439-420
		Rev. No	01
		Page 5 of 10	

		<p>visible warning sign should be provided to inform anyone working on the junction box.</p> <p>Junction box shall have two 4 sq mm UV resistant cables of minimum 1.2 metre length and plug-in connectors (male and female). Cables shall be of solar grade and shall conform to specification EN 50618.</p>
10.7	Adhesive for framing, junction-box fixing and potting	As per manufacturer's IEC test report
10.8	RFID	<p>Each PV module deployed must use a Radio Frequency identification (RFID) tag for traceability. RFID shall either be placed inside the laminate or behind name plate sticker or behind bar code label pasted on the back glass of PV module and must be able to withstand harsh environmental conditions during the module lifetime.</p> <p>RFID tag shall contain the following information:</p> <ol style="list-style-type: none"> <li>Name of module manufacturer with country of origin</li> <li>Month &amp; year of manufacture of modules</li> <li>Name of cell manufacturer with country of origin</li> <li>Month &amp; year of manufacture of cells</li> <li>IV curve</li> <li>Wattage, <math>I_{max}</math>, <math>V_{max}</math>, <math>V_{oc}</math>, <math>I_{sc}</math>, &amp; fill factor</li> <li>Module model number</li> <li>Unique serial number</li> <li>Date of obtaining IEC qualification certificates</li> <li>Name of test lab issuing IEC certificates</li> <li>Other relevant information etc. on traceability of solar cells and module as per IOS 9000 series</li> </ol>
10.9	Nameplate	<p>Each module shall be provided with a name plate label (sticker) containing the following information:</p> <ol style="list-style-type: none"> <li>Name of module manufacturer</li> <li>Module model number</li> <li>Serial number</li> <li>Polarity Terminal Leads</li> <li>Safety Class</li> <li>Application Class</li> <li>Overall Dimension (W x L x D)</li> <li>Weight in Kg</li> <li><math>P_{max}</math>, <math>V_{oc}</math>, <math>I_{sc}</math>, <math>I_{max}</math> &amp; <math>V_{max}</math></li> <li>System Voltage</li> </ol>

**COPYRIGHT AND CONFIDENTIAL**

The information on this document is the property of Bharat Heavy Electricals Limited.  
It must not be used directly or indirectly in anyway detrimental to the interest of the company

 <p>बि. एच. ई. लि. A4-11</p>	<b>PURCHASE SPECIFICATION GROUP: PHOTOVOLTAICS</b>	Spec. No	PS-439-420
		Rev. No	01
		Page 6 of 10	

		k. Relevant standards and certifying lab name l. Date of obtaining IEC qualification certificates m. Warnings, if any n. Other relevant information, etc  Nameplate shall be clearly visible and shall not be hidden by equipment wiring. It shall be durable for the entire life of panel.
10.10	BOM as per CDF of IEC Certificate	Solar cells and module materials shall be used as per approved CDF as per IEC Certificate. <b>Enclose copy of approved CDF as per IEC Certificate.</b>
10.11	RFID Reader	One number RFID reader (gun type) has to be supplied free of cost by the bidder which has to be compatible to read the module I-V data from the RFID Tag & download the data to Computer. All necessary associated Software, Cables and accessories are to be provided free of cost along with the RFID reader.
10.12	.PAN File	Third Party verified .PAN file for each module wattage offered shall be provided for carrying out PVSYS calculations at our end.
10.13	Mounting hole Pitch	<b>Pl. provide mounting hole pitch details.</b> <b>Horizontal :</b> <b>Vertical :</b> <b>Mounting hole size :</b>
10.14	Earthing holes	Earthing holes to be provided on both the shorter arms of PV module frames.
10.15	I-V curves and temperature coefficients	The bidder shall provide the sample solar PV module electrical characteristics including current-voltage (I-V) performance curves and temperature coefficients of power, voltage and current. <b>Enclose Sample I-V performance curve of for highest wattage of modules offered.</b> <b>Temperature coefficient of Power (Pmax) :</b> <b>Temperature coefficient of Voltage (Voc) :</b> <b>Temperature coefficient of Current (Isc) :</b>

### 3. QUALITY ASSURANCE

Module Quality Plan, Data Sheet and GTP shall be subject to customer's approval. Each lot of modules shall be subject to Pre Shipment Inspection (PSI) by BHEL and BHEL customer or any third party.

Quality plan will include the following:

- I. Incoming Quality Checks on bought out item
- II. In-process Quality Checks
- III. Sample tests on final product by the customer

### 4. WARRANTY

**Product Warranty shall be for 10 years and Performance Warranty shall be for 25 years.**

### COPYRIGHT AND CONFIDENTIAL

**The information on this document is the property of Bharat Heavy Electricals Limited. It must not be used directly or indirectly in anyway detrimental to the interest of the company**

 A4-11	<b>PURCHASE SPECIFICATION GROUP: PHOTOVOLTAICS</b>	<b>Spec. No</b>	<b>PS-439-420</b>
		<b>Rev. No</b>	<b>01</b>
		<b>Page 7 of 10</b>	

Solar PV modules used in solar power plants/ systems must be warranted for the product Workmanship for a period of minimum 10 years. Further, they shall also be warranted for their output peak watt capacity, which should not be less than 90% at the end of 10 years and 80% at the end of 25 years from the completion of the trial run. Modules that do not meet the above criteria shall be replaced free of cost at BHEL's/customer's sole discretion.

## 5. INSURANCE or BANK GUARANTEE FOR POWER OUTPUT WARRANTY

The PV module power output warranty as per the technical specification shall be insured and backed up through an insurance policy by a reputed insurance company which will cover against the PV module power output warranty in case of insolvency or bankruptcy of the PV module manufacturer. The Bidder shall submit a suitable insurance from Third Party.

The Successful Bidder who is not able to provide insurance of PV modules as above, shall submit a Bank Guarantee for 10% of the contract value through BHEL consortium bank and shall be valid for a period of Ten (10) years and 90 days. The minimum validity of the Bank guarantee shall be Two (2) years and shall be renewed by the bidder of their own subsequently every Two (2) years prior to thirty (30) days of its expiry. In case the PV module fails to provide power output as per its performance warranty, and if the bidder fails to rectify, replace or repair the PV module, then BHEL shall carry out the necessary rectification, repair or replacement at its own discretion at the risk and cost of the supplier. The cost of such rectification, repair or replacement shall be encashed from the Bank Guarantee against PV Module Warranty. The same shall be replenished by the supplier within thirty (30) days, failing which the entire Bank Guarantee amount shall be encashed and all pending payment shall be withheld by BHEL till such amount is replenished by the supplier. In another instance, if the supplier becomes bankrupt or insolvent, then BHEL shall immediately encash the entire amount of the Bank Guarantee against PV Module Warranty.

## 6. PACKING & IDENTIFICATION OF PV MODULE

The modules shall be packed in export seaworthy carton boxes made from triple-strength corrugated cardboard and resting on a wooden or plywood base. The PV modules packed in a carton box shall be of same power rating band only (360 Wp to 545Wp with 5Wp band). Carton box and Pallets shall be adequately designed to prevent damage or deterioration during transportation to site in remote road conditions, handling and storage in site till the time of its installation. The carton box should display the manufacturer's name, number of modules, type, serial numbers, module wattage etc. Modules found damaged at the time of opening of the cartons in the project site shall be replaced free of cost by the module manufacturer.

## 7. GENERAL CONDITIONS

- a. PV Modules shall be manufactured at the vendor's works only.
- b. Manufacturing clearance shall be given only after approval of Data Sheet, Bill of Material, manufacturing quality plan, Pre-Shipment inspection plan by BHEL's customer. inspection plan and approval of drawings and datasheet by BHEL's customer.

### COPYRIGHT AND CONFIDENTIAL

**The information on this document is the property of Bharat Heavy Electricals Limited.  
It must not be used directly or indirectly in anyway detrimental to the interest of the company**

 A4-11	<b>PURCHASE SPECIFICATION GROUP: PHOTOVOLTAICS</b>	Spec. No	PS-439-420
		Rev. No	01
		Page 8 of 10	

### 8. MODULE RATINGS OFFERED

Pl. fill the table as below for the module wattage ratings offered.

Module Type (model No):

Module rating	Wattage	Quantity in MWp

Note :

1) Bidders can offer a maximum of 3 Power rating bands.

### 9. BENEFITS FOR HIGHER WATTAGE RATED PV MODULES:

Vendors offering higher wattage PV modules will get the benefit of negative loading in their prices offered for comparison of costs and arriving at L1 (Lowest bidder) as below.

Module Wattage Offered	Loading factor on account of Power rating (LFP)	Module Wattage Offered	Loading factor on account of Power rating (LFP)
360	-	455	-78,00,000
365	-4,00,000	460	-83,00,000
370	-12,00,000	465	-86,00,000
375	-16,00,000	470	-89,00,000
380	-21,00,000	475	-92,00,000
385	-23,00,000	480	-97,00,000
390	-30,00,000	485	-1,00,00,000
395	-34,00,000	490	-1,01,00,000
400	-38,00,000	495	-1,03,00,000
405	-42,00,000	500	-1,06,00,000
410	-48,00,000	505	-1,09,00,000
415	-52,00,000	510	-1,14,00,000
420	-55,00,000	515	-1,16,00,000
425	-57,00,000	520	-1,16,00,000
430	-61,00,000	525	-1,18,00,000
435	-66,00,000	530	-1,21,00,000
440	-70,00,000	535	-1,23,00,000
445	-73,00,000	540	-1,25,00,000
450	-74,00,000	545	-1,25,00,000

Note :

1) If a mix of module ratings are offered, negative loading will be given for respective ratings of PV modules in the pro rata basis.

### COPYRIGHT AND CONFIDENTIAL

The information on this document is the property of Bharat Heavy Electricals Limited.  
It must not be used directly or indirectly in anyway detrimental to the interest of the company

 <p><b>A4-11</b></p>	<b>PURCHASE SPECIFICATION GROUP: PHOTOVOLTAICS</b>	<b>Spec. No</b>	<b>PS-439-420</b>
		<b>Rev. No</b>	<b>01</b>
		<b>Page 9 of 10</b>	

**10. ENCLOSURES :**

Sl. No.	Document
1.	Documentary evidence for PV module manufacturing capacity 50MW per annum
2.	Signed copy of BHEL Specification PS-439-420 Rev. 01 for confirming to supply as per BHEL Specification.
3.	Tie-up letter with Indian Solar cell manufacturer for supply of solar cells
4.	IEC 61215-1, IEC 61215-1-1, IEC 61215-2 , IEC 61730-1 & 2, IEC61701, IEC61853 -1, IEC 60364-4-41, IEC 62804 and EN 50380 test certificates.
5.	Approved CDF (Bill of Materials) of PV modules as per IEC certificates.
7.	Over all PV module assembly drawing indicating mounting hole pitch & data sheet for PV modules.
8.	Third party verified .PAN files for each wattage of Monocrystalline PV modules (360 to 545Wp with 5Wp band )
9.	Data sheet for Solar cells used for manufacturing PV modules.
10.	Bill of Material for PV Modules that shall be used for this contract
11.	PV module installation and O&M manual
12.	Hard copy of above documents shall be enclosed along with the technical bid. Soft copy of all above documents and IEC test reports to be sent by e-mail to the email id as mentioned in tender documents.

**COPYRIGHT AND CONFIDENTIAL**

**The information on this document is the property of Bharat Heavy Electricals Limited.  
It must not be used directly or indirectly in anyway detrimental to the interest of the company**

 <b>A4-11</b>	<b>PURCHASE SPECIFICATION  GROUP: PHOTOVOLTAICS</b>	Spec. No	PS-439-420
		Rev. No	01
		Page 10 of 10	

**11. Confirmation by the vendor :**

Sl. No.	Item	Acceptance by the Module manufacturer (Yes / No)
1.	PV Module model number and overall dimension:	
2.	Mono Crystalline PV Modules with power output 360Wp to 545 Wp in 5 watts bands.	
3.	Mono Crystalline PV Modules suitable for 1500V System Voltage application	
4.	Availability of IEC 61215-1, IEC 61215-1-1, IEC 61215-2, IEC 61730-1 & 2 , IEC61701, IEC61853 -1, IEC 60364-4-41 and IEC 62804 test certificates and IEC Test reports with CDF.	
5.	Junction box cable length : 1.2 Metres minimum	
6.	RFID Tag inside or outside the laminate	
7.	Supply of 1 no. of hand held RFID reader with accessories	
8.	Adherence to Manufacturing Quality Plan and Pre-Shipment Inspection as per customer	
9.	Bill of materials as per subset of the CDF of the IEC Certificates	
10.	Submission of Bank Guarantee for Power Performance warranty of PV modules	

**12. DEVIATION SHEET**

Sl. No.	Particulars	Bidder's Confirmation
1.	Confirmation to BHEL Specification PS- 439- 420 Rev. 01	<b>Yes / No</b>  <i>Please indicate deviations, if any.</i>

\_\_\_\_\_  
Signature of Tenderer with stamp

**COPYRIGHT AND CONFIDENTIAL**

The information on this document is the property of Bharat Heavy Electricals Limited.  
It must not be used directly or indirectly in anyway detrimental to the interest of the company

**OPTION A****'UNPRICE FORMAT- FOR INDIAN SUPPLIERS FOR Monocrystalline DCR PV Module  
(To be submitted with Part-1 Bid)**

Rev 00

17.12.2021

**Kindly mention "QUOTED" or "Q" in place of actual price where ever applicable).**

<b>TENDER REF: SPKSCP074</b>				SUPPLIER'S NAME:								
				Currency : INR								
<b>For Indigenous supplies</b>												
Sl.No	Item Description:	Unit of Measurement	Qty (1)	Ex-works price INR	FOB Indian Seaport price INR	Sea freight price INR	Unit CFR Port Louis Seaport, Mauritius PRICE (2) INR INCL PACKING, Freight	Total CFR Mauritius Seaport PRICE [1X2] = [3] INR	CGST @ %=(4)INR	SGST @ %=(5)INR	IGST @ %=(5) INR	TOTAL PRICE = (6)=(3)+(4)+(5) (Currency)
1a	Monocrystalline DCR PV Module	KW	9,300									
1b	PV Module - Mandatory spares	Nos.	100									

**The PV modules offered for mandatory spares (Item No 20), shall have highest wattage rating offered for main supply (Item No 10)**

Vendor to submit their quotation for either option A or option B However evaluation shall be done on Cost to BHEL basis- Mauritius PV site.

TOTAL PRICE =(6)=Sum of Two line items

HSN CODE: \_\_\_\_\_

Name of Indian Seaport:

TOTAL PRICE IN WORDS (6) :

Price shall be firm till the completion of order execution.

DATE:  
PLACE:

BIDDER'S SIGN &amp; SEAL



OPTION B

'UNPRICE FORMAT- FOR INDIAN SUPPLIERS FOR Monocrystalline DCR PV Module

(To be submitted with Part-1 Bid)

Rev 00

17.12.2021

Kindly mention "QUOTED" or "Q" in place of actual price where ever applicable).

TENDER REF: SPKSCP074				SUPPLIER's NAME:							
				Currency : INR							

For Indigenous supplies											
Sl.No	Item Description:	Unit of Measurement	Qty (1)	Ex-works price INR	Inland freight upto Mumbai seaport (BHEL ROD warehouse)	Unit FOR Mumbai seaport (BHEL ROD warehouse) PRICE (2) INR INCL PACKING, Freight	Total FOR Mumbai seaport PRICE [1X2] = [3] INR	CGST @ $\frac{\quad}{4}$ INR	SGST @ $\frac{\quad}{5}$ INR	IGST @ $\frac{\quad}{5}$ INR	TOTAL PRICE = (6)=(3)+(4)+(5) (Currency)
1a	Monocrystalline DCR PV Module	KW	9,300								
1b	PV Module - Mandatory spares	Nos.	100								

**The PV modules offered for mandatory spares (Item No 20), shall have highest wattage rating offered for main supply (Item No 10)**

Vendor to submit their quotation for either option A or option B However evaluation shall be done on Cost to BHEL basis- Mauritius PV site.

TOTAL PRICE =(6)=Sum of Two line items

HSN CODE: \_\_\_\_\_

TOTAL PRICE IN WORDS (6) :

Price shall be firm till the completion of order execution.

DATE:  
PLACE:

BIDDER's SIGN & SEAL



**OPTION A**  
**'PRICE FORMAT- FOR INDIAN SUPPLIERS FOR Monocrystalline DCR PV Module**

Rev 00

17.12.2021

**TENDER REF: SPKSCP074** SUPPLIER's NAME: \_\_\_\_\_  
Currency : INR

Sl.No	Item Description:	Unit of Measurement	Qty (1)	Ex-works price INR	FOB Indian Seaport price INR	Sea freight price INR	For Indigenous supplies					TOTAL PRICE = (6)=(3)+(4)+(5) (Currency)
							Unit CFR Port Louis Seaport, Mauritius PRICE (2) INR INCL PACKING, Freight	Total CFR Mauritius Seaport PRICE [1X2] = [3] INR	CGST @ %=(4)INR	SGST @ %=(5)INR	IGST @ %=(5) INR	
1a	Monocrystalline DCR PV Module	KW	9,300									
1b	PV Module - Mandatory spares	Nos.	100									

**The PV modules offered for mandatory spares (Item No 20), shall have highest wattage rating offered for main supply (Item No 10)**

Vendor to submit their quotation for either option A or option B However evaluation shall be done on Cost to BHEL basis- Mauritius PV site.	TOTAL PRICE =(6)=Sum of Two line items
HSN CODE: _____	
Name of Indian Seaport:	
TOTAL PRICE IN WORDS (6) :	

Price shall be firm till the completion of order execution.

DATE: \_\_\_\_\_ BIDDER's SIGN & SEAL  
PLACE: \_\_\_\_\_



**OPTION B**  
**PRICE FORMAT- FOR INDIAN SUPPLIERS FOR Monocrystalline DCR PV Module**

Rev 00

17.12.2021

TENDER REF: SPKSCP074				SUPPLIER's NAME:							
				Currency : INR							
<b>For Indigenous supplies</b>											
Sl.No	Item Description:	Unit of Measurement	Qty (1)	Ex-works price INR	Inland freight upto Mumbai seaport (BHEL ROD warehouse)	Unit FOR Mumbai seaport (BHEL ROD warehouse) PRICE (2) INR INCL PACKING, Freight	Total FOR Mumbai seaport PRICE [1X2] = [3] INR	CGST @ $\frac{\quad}{4}$ INR	SGST @ $\frac{\quad}{5}$ INR	IGST @ $\frac{\quad}{5}$ INR	TOTAL PRICE = (6)=(3)+(4)+(5) (Currency)
1a	Monocrystalline DCR PV Module	KW	9,300								
1b	PV Module - Mandatory spares	Nos.	100								

**The PV modules offered for mandatory spares (Item No 20), shall have highest wattage rating offered for main supply (Item No 10)**

Vendor to submit their quotation for either option A or option B However evaluation shall be done on Cost to BHEL basis- Mauritius PV site.

TOTAL PRICE =(6)=Sum of Two line items

HSN CODE: \_\_\_\_\_

TOTAL PRICE IN WORDS (6) :

Price shall be firm till the completion of order execution.

DATE:  
PLACE:

BIDDER's SIGN & SEAL

	<b>SOLAR BUSINESS DIVISION (SBD)</b>	<b>SPECIAL CONDITIONS OF CONTRACT (SCC)</b> <b>Rev. No. 00</b>	<b>Item Description: :</b> <b>Monocrystalline DCR PV Module</b> <b>Tender Ref:</b> <b>SPKSCPV074</b>
---	--------------------------------------	---	---



These Conditions shall be read in conjunction with General Condition of Contract (GCC Rev R0) enclosed along with the tender enquiry. In case of any conflict or inconsistency, the requirement of SCC shall prevail over the GCC.		
The name of our Plant/ Unit may please be read as SOLAR BUSINESS DIVISION (SBD) as it was changed from ELECTRIC & PHOTOVOLTAIC DIVISION (EPD)		
1.	Type of Contract	Supply
2.	Item Details	Solar Photovoltaic Modules as per following documents : 1. Technical Specifications DOC NO: PS-439-420 Rev 01
3.	Consignee address	BHEL Site Office 8 MWac Solar PV Farm Central Electricity Board (CEB) Rue Du Savoir, Cyber City, Ebene, Mauritius.  Delivery : (Option A) - CFR Port Louis Seaport, Mauritius  (Option B) - FOR Mumbai seaport (BHEL ROD warehouse)
4.	Buyer and Paying Authority	BHARAT HEAVY ELECTRICALS LIMITED - SOLAR BUSINESS DIVISION (SBD), (Formerly known as ELECTRIC & PHOTOVOLTAIC DIVISION) PROF. CNR RAO CIRCLE, SCIENCE INSTITUTE POST, MALLESWARAM, BANGALORE-560012.
5.	Buyer IEC CODE/ GST No.	IEC CODE: 0588138690 / GST No: 29AAACB4146P1ZB
6.	Buyer Email ID	For Commercial Clarifications: <a href="mailto:spankaj@bhel.in">spankaj@bhel.in</a> ; <a href="mailto:aknived@bhel.in">aknived@bhel.in</a> For Technical Clarifications: <a href="mailto:muhammedshakir@bhel.in">muhammedshakir@bhel.in</a> ; <a href="mailto:raghavendrababu.qv@bhel.in">raghavendrababu.qv@bhel.in</a>
7.	Mode of Dispatch	By Road/Rail/Air/Sea Note: It is Vendor's responsibility to ensure availability of Trucks/Train/Flight/Ship schedule etc. well in advance for dispatch of material to meet contractual delivery requirement. <ul style="list-style-type: none"> <li>• Part shipment is allowed.</li> <li>• Transshipment is not allowed.</li> </ul> It is also the vendor's responsibility to ensure material is dispatched through shortest possible route. By ROAD/RAIL/ AIR/ SEA.
8.	Price basis	Price shall be firm till the completion of order execution.  Option A – CFR Port Louis Seaport, Mauritius inclusive of packing & forwarding charges. Taxes and duties to be paid in line with GCC. Material to be dispatched on freight pre-paid basis. Insurance is in the scope of BHEL.  In the Bill of Lading " BHEL International Operation Division" shall be mentioned as Main Exporter.  Option B – FOR Mumbai seaport (BHEL ROD warehouse) inclusive of packing & forwarding charges. Taxes and duties to be paid in line with GCC. Material to be dispatched on freight pre-paid basis. Insurance is in the scope of BHEL.  All the other applicable taxes including Income taxes (TDS) as per prevailing Indian law shall be deducted from the payables & paid to Govt. by BHEL.
9.	Evaluation of Offer	On overall package L1 basis consisting of both line items (main and spares) as per Cl. No. 19.0 of GCC (Instructions to bidders).  The evaluation currency for this tender shall be INR.  Vendor to submit their quotation for either option A or option B. However evaluation shall be done on Total Cost to BHEL basis- Mauritius PV site.  In case offer is received from the vendor for both the options, "Option A" shall be considered.

	<b>SOLAR BUSINESS DIVISION (SBD)</b>	<b>SPECIAL CONDITIONS OF CONTRACT (SCC)</b> <b>Rev. No. 00</b>	<b>Item Description: :</b> <b>Monocrystalline DCR PV Module</b> <b>Tender Ref:</b> <b>SPKSCP074</b>
---	--------------------------------------	---	--

10.	Change of Scope	<p>In case of changes in scope of the tender and / or technical specifications and /or commercial terms &amp; conditions by BHEL during techno commercial evaluation and before Price bid Opening, the same will be communicated only to the bidders who have participated in the tender.</p> <p>The techno-commercially qualified bidders shall be asked to submit Impact Price bid, if applicable.</p>
11.	Quantity Splitting	Not applicable
12.	Reverse Auction	<p>BHEL shall be resorting to Reverse Auction (RA) (Guidelines as available on (www.bhel.com) for this tender. RA shall be conducted among the techno commercially qualified bidders. Price bids of all techno-commercially qualified bidders shall be opened and same shall be considered for RA. In case any bidder(s) do(es) not participate in online Reverse Auction, their sealed envelope price bid along with applicable loading, if any, shall be considered for ranking.”</p> <p>Bidders are required to submit their acceptance to the terms/ conditions/ modalities before participating in the Reverse Auction in the process compliance form as enclosed. Without this, the bidder will not be eligible to participate in the event.</p>
13.	Delivery Period	<p>Data sheet/ drawing/QAP shall be submitted by the vendor within 2 weeks from the date of PO and any resubmission shall be within 1 week from the date of comments issued by BHEL.</p> <p>Supply completion by <b>30<sup>th</sup> May 2022</b></p>
14.	Transit Insurance	<p>In BHEL Scope.</p> <p>Insurance details shall be informed along with the NIT / Purchase Order.</p> <p>Prior Dispatch, intimation shall be issued to Insurance agency by the supplier about the value of consignment, dispatch details, along with one set of documents consisting of LR /BL copy, Packing List, Challan indicating the items dispatched (with their weights). A copy of above should be sent by email to General.Claims@tataaig.com; Prabhutav.Dadhich@tataaig.com;Saurabh1.Agrawal@tataaig.com; Samir.Paul@tataaig.com and copy to the following BHEL Email IDs <a href="mailto:spankaj@bhel.in">spankaj@bhel.in</a> &amp; <a href="mailto:aknived@bhel.in">aknived@bhel.in</a></p> <p><b>Insurance Details:</b>  <b>For export/import:</b>  Insurer: Tata AIG General Insurance Company Limited  Policy no: 0865092106 Period: 01/06/2021 – 31/05/2022  ADDRESS: 301, 3rd floor, RG City Center, LSC Block-B, Lawrence Road, New Delhi, 110035. Tel: 011-27196505; Fax: 011-27196516</p> <p><b>For Indigenous</b>  Insurer: Tata AIG General Insurance Company Limited  Policy no: 0865092085  Period: 01/06/2021 – 31/05/2022  ADDRESS: 301, 3rd floor, RG City Center, LSC Block-B, Lawrence Road, New Delhi, 110035. Tel: 011-27196505; Fax: 011-27196516</p>
15.	Unloading at project site / transportation from Indian port to consignee address in	In the scope of BHEL.

 	<b>SOLAR BUSINESS DIVISION (SBD)</b>	<b>SPECIAL CONDITIONS OF CONTRACT (SCC)</b> <b>Rev. No. 00</b>	<b>Item Description: :</b> <b>Monocrystalline DCR PV Module</b> <b>Tender Ref:</b> <b>SPKSCP074</b>
---	--------------------------------------	---	--

	case of exports (Option B only)	
16.	Payment terms	<p>Clause no: 9.1 of GCC R0 to be read as follows:-</p> <p><b>9.1 FOR INDIGENOUS PURCHASE:-</b>          FOR SUPPLY OF ITEMS ( SI No. 1 of Price format)</p> <p><b>9.1.1</b> Milestone payment of five percent (5%) of basic price of total supplies, as per PO, shall be paid against submission of invoice along with BHEL approved data sheet, drawing &amp; QAP along with bank guarantee (as per attached format) of equivalent value valid till completion of supplies, initially valid up to delivery period.</p> <p><b>9.1.2</b> Milestone payment of five percent (5%) of basic price of total supplies, as per PO, shall be paid against submission of invoice along with unpriced copies of purchase orders of at least twenty percent (20%) of total quantity of solar cells, aluminum frame, ARC glass and EVA sheet required for manufacture of PV Modules as per the PO (as certified by the BHEL Officer) along with bank guarantee (as per attached format) of equivalent value valid till completion of supplies, initially valid up to delivery period.</p> <p><b>9.1.3</b> Seventy Eight percent (78%) of basic price of material supplied, as per PO, along with 100% taxes &amp; duties (as applicable) &amp; freight charges, shall be paid on pro-rata basis within 45 days from the date of B/L (for Option A)/ date of receipt of goods (for Option B) &amp; receipt of complete documents as per list at sl.no.21 of SCC subject to acceptance of materials. Two (2%) of basic value shall be deducted from payment as TDS &amp; TDS Certificate shall be issued by BHEL, as per amendment in GST Law. GOI has amended GST Law - Section 51 of the CGST Act 2017 wherein Government Agencies (PSU) has to deduct 2% GST TDS w.e.f. 01.10.2018. Kindly go thru the latest amendment in GST Law.</p> <p><b>9.1.4</b> Balance Ten Percent (10%) of basic price of the materials supplied shall be paid pro-rata within 45 days from the date of receipt of complete documents as specified in Clause No. 21 of SCC / PO.</p>
17.	Documents to be Submitted by Seller / Contractor for Claiming Payment	<p>List of documents in Clause no. 9.2.2 of GCC R0 to be read as</p> <p><b>FOR INDIGENOUS PURCHASE</b>  <b>Under clause 9.1.3 :</b></p> <ol style="list-style-type: none"> <li>GST compliant Invoice (Original for Buyer + 1 Copy).</li> <li>Original clean BL (for option A) or Original Copy of receipted LR / RR (for option B)</li> <li>Packing List - Shall Be in Line with PO Material Code and Clearly Showing Number of Packages, Gross Weight and Net Weight-(Original+3 Copies).</li> <li>E waybill</li> <li>Copy of Transit Insurance Intimation [Sent by the Supplier to Insurer]</li> <li>Material Dispatch Clearance Certificate (MDCC) issued by BHEL.</li> <li>Inspection call to BHEL for Inspection of goods.</li> </ol> <p><b>Under Clause 9.1.4 :</b></p> <ol style="list-style-type: none"> <li>GST compliant Invoice (Original for Buyer + 1 Copy).</li> <li>Bank guarantee / Insurance policy (in original) to cover PV module power output warranty from reputed third party insurance company as per PO.</li> <li>Material Receipt Certificate issued by BHEL (Copy)</li> </ol>
18.	Guarantee period	As per technical specification
19.	Submission of Contract Performance Bank Guarantee	Not Applicable
20.	Integrity Pact	<p><b>APPLICABLE (AS PER ATTACHED FORMAT)</b></p> <p>IP is a tool to ensure that activities and transactions between the Company and its Bidders/ Contractors are handled in a fair, transparent and corruption free manner. A panel of Independent External Monitors (IEMs) have been appointed to oversee implementation of IP in BHEL.</p> <p>The IP as enclosed with the tender is to be submitted (duly signed by authorized signatory who signs in the offer) along with techno-commercial bid. Only those bidders who have entered into such an IP with BHEL would be competent to participate in the bidding. In other words, entering into this Pact would be a preliminary qualification.</p> <p>Details of Independent External Monitor (IEM):</p>

 	<b>SOLAR BUSINESS DIVISION (SBD)</b>	<b>SPECIAL CONDITIONS OF CONTRACT (SCC)</b> <b>Rev. No. 00</b>	<b>Item Description: :</b> <b>Monocrystalline DCR PV Module</b> <b>Tender Ref:</b> <b>SPKSCPV074</b>
---	--------------------------------------	---	---

		Sh. Arun Chandra Verma, IPS (Retd.) Email: acverma1@gmail.com	Sh. Shri Virendra Bahadur Singh, IPS (Retd.) Email: vbsinghips@gmail.com
		<p><b>Note:</b>          No routine correspondence shall be addressed to the IEM (phone/ post/ email) regarding the clarifications, time extensions or any other administrative queries, etc. on the tender issued. All such clarification/ issues shall be addressed directly to the tender issuing (procurement) department.          For all clarifications/ issues related to the tender, Please contact:          Name : S.Pankaj Kumar/ A K Nived          Address: SBD, Bangalore.          Ph. No. +91-080-2218-2269</p>	
21.	Organization Chart	The bidder shall submit the overall organization chart along with contact details/mobile no. of officials dealing with this contract package for engineering, supply, Quality, etc immediately after receipt of PO.	
22.	Delivery Failure and Termination/ Liquidated Damages	Applicable as per Cl. No. 16 (Page 17 of 28) of GCC R0.  Clause No. 16.2.1 of GCC to be read as: Purchaser reserves the right to recover from the Seller/Contractor, as agreed, liquidated damages and not by way of penalty, a sum equivalent to half (½) percent of undelivered portion per week or part thereof, subject to a maximum of ten (10) percent of the total contract price (including elements of taxes, duties and freight, if the Seller/ Contractor fails to deliver any part of the ordered stores within the period stipulated in the Order/Contract.  <b>NOTE:</b> 1. The Date of BL for option A and LR/RR date + 7 days for option B shall be treated as the date of delivery for levying LD as per Clause 16. 2. In case of any amendment/revision, LD shall be linked to the amended/revised contract value and delivery date(s). 3. If Order/ Contract involves two or more Units/ Sets/ Lots, then Liquidated Damages shall be for order/ contract value of the delayed Unit/ Set/ Lot, provided delivery stipulated in the Order/ Contract is Unit/ Set/ Lot wise, however total LD amount shall be limited to 10% of total order value. (including taxes, duties and freight)	
23.	Preference to Make in India	This Tender is governed by Circular No. P-45021/2/2017-B.E.-II dated <a href="#">15.06.2017</a> , <a href="#">28.05.2018</a> , 29.05.2019 & 04.06.2020 issued by Govt. of India (copy enclosed). "For this procurement, Public Procurement (Preference to Make in India), Order 2017 dated <a href="#">15.06.2017</a> , <a href="#">28.05.2018</a> , 29.05.2019 , 04.06.2020 , 16.09.2020 and subsequent Orders issued by the respective Nodal Ministry shall be applicable even if issued after issue of this NIT but before finalization of contract/ POI WO against this NIT. In the event of any Nodal Ministry prescribing higher or lower percentage of purchase preference and/ or local content in respect of this procurement, same shall be applicable." Preference to Make in India including counter offering will be as per the Public Procurement (Preference to Make in India), Order 2017 available in the following links: <a href="https://dipp.gov.in/sites/default/files/publicProcurement_MakeinIndia_15June2017.pdf">https://dipp.gov.in/sites/default/files/publicProcurement_MakeinIndia_15June2017.pdf</a> <a href="https://dipp.gov.in/sites/default/files/Revised-PPP-MII-Order-2017_28052018.pdf">https://dipp.gov.in/sites/default/files/Revised-PPP-MII-Order-2017_28052018.pdf</a> <a href="https://dipp.gov.in/sites/default/files/PPP-MII%20Order%20dt%2029th%20May%2019_0.pdf">https://dipp.gov.in/sites/default/files/PPP-MII%20Order%20dt%2029th%20May%2019_0.pdf</a> <a href="https://dipp.gov.in/sites/default/files/PPP%20MII%20Order%20dated%204th%20June%202020.pdf">https://dipp.gov.in/sites/default/files/PPP%20MII%20Order%20dated%204th%20June%202020.pdf</a> <a href="https://dipp.gov.in/sites/default/files/PPP%20MII%20Order%20dated%2016%2009%202020.pdf">https://dipp.gov.in/sites/default/files/PPP%20MII%20Order%20dated%2016%2009%202020.pdf</a>  Certification (as applicable) giving the percentage of local content, in line with PPP-MII order, to be submitted as per attached Annexure-1(A) for procurement value from Rs. 5.00 Lac to Rs. 10.00 Crore or Annexure-1(B) for procurement value more than Rs. 10.00 Crore.	
24.	Purchase from SEZ in India	Purchase from SEZ in India shall be considered as Indigenous purchase for the purpose of Purchase Preference to Make in India Policy, Price Basis, Payment term & delivery terms. However, additional taxes, duties including Safe Guard Duty if any shall be considered while evaluating the bid.	
25.	TAXES AND DUTIES (Clause No. 4.1, 4.2 & 4.3) (Applicable only for Indian Bidders)	Clause No. 4.1, 4.2 & 4.3 of GCC to be read as: 4.1 CGST/SGST/UTGST/IGST 4.1.1 Seller/ Contractor is required to ensure that CGST/SGST/UTGST/IGST (whichever is applicable) is quoted as per the existing tariff on the date of the offer and all benefits as per existing laws have been considered.	

	<b>SOLAR BUSINESS DIVISION (SBD)</b>	<b>SPECIAL CONDITIONS OF CONTRACT (SCC)</b> <b>Rev. No. 00</b>	<b>Item Description: :</b> <b>Monocrystalline DCR PV Module</b> <b>Tender Ref:</b> <b>SPKSCP074</b>
---	--------------------------------------	---	--

		<p>4.1.2 It is the responsibility of the seller/contractor to issue the Tax Invoice strictly as per the format prescribed under the relevant applicable GST law (CGST Act/SGST Act/UTGST Act/IGST Act). Vendor to indicate the proper GSTN Registration/ HSN code in their tax invoice.</p> <p>4.1.3 The purchaser is registered in the State of Karnataka vide following GST registration number: 29AAACB4146P1ZB.</p> <p>4.1.4 Seller/contractor is required to mention the above registration number in their tax invoice unless stated otherwise in NIT/SCC.</p> <p>4.1.5 CGST/SGST/UTGST/IGST shall be paid at actuals against Tax Invoice but restricted to the amount and percentage in the order/contract.</p>
26.	<b>OTHER TAXES &amp; LEVIES</b> (Clause No. 4.4) (Applicable only for Indian Bidders)	Clause No. 4.4 of GCC to be read as: <b>4.2 OTHER TAXES &amp; LEVIES</b> 4.2.1 All taxes/duties/Cess other than CGST/SGST/UTGST/IGST shall be deemed to be included in the Ex-Works prices unless specified otherwise by the bidder in the price bid. No variation in other taxes and duties shall be payable by Purchaser.
27.	<b>CUSTOMS DUTY</b> (Clause No. 4.5 of GCC) (Applicable only for Indian Bidders)	Clause No. 4.5 of GCC to be read as: <b>4.3 CUSTOMS DUTY</b> 4.3.1 Customs Duty/IGST/Goods and Services compensation cess under Goods and Services Tax (Compensation to States) Act, 2017 element for imported items as per Special Conditions of Contract shall be included in the Ex-Works prices. 4.3.2 Seller/ Contractor shall arrange for his own import license, if required, since Purchaser will not provide any import license. Therefore, Seller/ Contractor alone shall be responsible for any delay in getting import license or non-availability of the same or completion of other related formalities. Purchaser shall not be responsible for any financial liability, whatsoever, on this account. 4.3.3 Essentiality Certificate or Project Authority Certificate (PAC) as per Import Policy, if required to avail concessional customs duty, shall be clearly specified in the offer. Import content (CIF value in rupees) with list of items, quantity, foreign currency, Country of origin etc., shall be submitted by the bidder as part of Price bid.
28.	<b>DIRECT TAXES</b> (Clause No. 4.6 of GCC) (Applicable only for Indian Bidders)	Clause No. 4.6 of GCC to be read as: <b>4.4 DIRECT TAXES</b> 4.4.1 Purchaser shall not be liable towards income tax of whatever nature including variations thereof, arising out of this Order/ Contract, as well as tax liability of the Seller/ Contractor and his personnel. 4.4.2 Deductions of Tax at source at the prevailing rates shall be effected by the Purchaser before release of payment, as a statutory obligation, if applicable. TDS certificate will be issued by the Purchaser as per statutory provisions.
29.	<b>STATUTORY VARIATION</b> (Clause No. 5.0 of GCC) (Applicable only for Indian Bidders)	Clause No. 5.0 of GCC to be read as: <b>5.0 STATUTORY VARIATION</b> 5.1 If any rates of Tax or duty are increased or decreased, a new Tax or duty is Introduced, an existing Tax or duty is abolished, or any change in interpretation or application of any Tax or duty occurs in the course of the execution of Contract including Delivery period extensions (if any), which was or will be assessed on the bidder in connection with performance of the Contract, an equitable adjustment of the Contract Price shall be made to fully take into account any such change by addition to the Contract Price or deduction there from, as the case may be. However, these adjustments would be restricted to direct transactions between BHEL and the bidder/ agent of foreign bidder (if applicable). These adjustments shall not be applicable on procurement of raw materials, intermediary components etc. by the bidder /agent. 5.2 For variation after the agreed completion periods, the seller/contractor alone shall bear the impact for the upwards revisions and adjust the price in their basic price in such a manner that total price with tax or duties matches with the ex- works with taxes of Purchase Order/Contract. For downward revisions, purchaser shall be given the benefit of reduction in CGST/SGST/UGST/IGST. This will be without prejudice to the levy of penalty for delay in delivery/completion schedule.
30.	<b>New Clause of GCC</b> (Applicable only for Indian Bidders)	<b>9.7 Other clauses</b> 1. Vendor/Supplier will intimate & upload the Tax invoice along with LR/RR (as applicable) on web portal & intimate BHEL immediately on removal of goods from vendor/supplier works. In case of Services, Vendor is required to upload the Tax invoice on Web Portal immediately after raising the invoice. BHEL will issue the delivery order/instruction to dispatch the material to the customer as indicated in

	<b>SOLAR BUSINESS DIVISION (SBD)</b>	<b>SPECIAL CONDITIONS OF CONTRACT (SCC)</b> <b>Rev. No. 00</b>	<b>Item Description: :</b> <b>Monocrystalline DCR PV Module</b> <b>Tender Ref:</b> <b>SPKSCP074</b>
---	--------------------------------------	---	--

		<p>SCC.</p> <p>2. All payments against Tax Invoice to vendors/contractors shall be released only after:</p> <p>a) Vendor/contractor declaring such invoice in GSTR-1 within the prescribed timeline as per the relevant Act.</p> <p>b) The tax component charged by the vendor in the invoice should be matched with the details uploaded by vendor in GSTR-1.</p> <p>c) Confirmation of payment of GST thereon by vendor on GSTN portal</p> <p>3. In case, any GST credit is delayed/denied to BHEL due to non/delayed receipt of goods and/or tax invoice or expiry to timeline prescribed in the relevant Act for availing such ITC, or any other reasons not attributable to BHEL, tax amount shall be recoverable from the vendor/contractor along with interest levied/leviable on BHEL.</p> <p>Wherein GST liability arises on BHEL under reverse charge, any interest levied/leviable due to any reasons not attributable to BHEL shall be recovered from the vendor/contractor.</p>
<p>31.</p>	<p>New Clauses of GCC</p>	<p>a) In case of discrepancy in CGST/SGST/UTGST/IGST rate corresponding to HSN ;code and quotes rates, the evaluation shall be done on quoted price and correct CGST/SGST/UTGST/IGST rate shall be considered for ordering ( limited to quoted FOR Site Price)</p> <p>b) The bidder should have been registered with the appropriate authority under relevant GST laws.</p> <p>c) The bidder to specify in their offer ( part 1 bid) the category of registration under GST i.e. registered dealer and composite dealer</p> <p>d) No CGST/SGST/UTGST/IGST will be reimbursed to composite dealer. In the event of any GST quoted by composite dealer, the same shall be considered for evaluation purpose. However, the ordering will be done without considering the tax.</p> <p>In the event of any change in the status of vendor from composite to regular dealer after the submission of the bid but before the supply, no reimbursement of CGST/SGST/UTGST/IGST will be made. However, the vendor has to raise the invoice strictly, as per the law, by adjusting their ex-works price.</p>
<p>32.</p>	<p>RISK &amp; COST CLAUSE</p>	<p>Risk &amp; Cost Clause, in line with Conditions of Contract may be invoked in any of the following cases:</p> <p>Contractor/ supplier's poor progress of the work vis-à-vis execution timeline as stipulated in the Contract, backlog attributable to contractor/ supplier including unexecuted portion of work/ supply does not appear to be executable within balance available period (#) considering its performance of execution.</p> <p>Withdrawal from or abandonment of the work by contractor before completion of the work as per contract.</p> <p>Non completion of work/ Non-supply by the Contractor/ supplier within scheduled completion/delivery period as per Contract or as extended from time to time, for the reasons attributable to the contractor/ supplier.</p> <p>Termination of Contract on account of any other reason (s) attributable to Contractor/ Supplier.</p> <p>Assignment, transfer, subletting of Contract without BHEL's written permission resulting in termination of Contract or part thereof by BHEL.</p> <p>Non-compliance to any contractual condition or any other default attributable to Contractor/ Supplier.</p> <p><b>RISK &amp; COST</b>  Risk and Cost against Balance Work:</p> <p>Risk &amp; Cost Amount= [(A-B) + (A x H/100)]  Where,  A= Value of Balance scope of Work/ Supply (*) as per rates of new contract  B= Value of Balance scope of Work/ Supply (*) as per rates of old contract being paid to the contractor/ supplier at the time of termination of contract i.e. inclusive of PVC &amp; ORC, if any.  H = Overhead Factor to be taken as 5  In case (A-B) is less than 0 (zero), value of (A-B) shall be taken as 0 (zero).  *(Balance scope of work/ supply)</p> <p>Difference of Contract Quantities and Executed Quantities as on the date of issue of Letter for 'Termination of Contract', shall be taken as balance scope of Work/ Supply for calculating risk &amp; cost amount.</p>

	<b>SOLAR BUSINESS DIVISION (SBD)</b>	<b>SPECIAL CONDITIONS OF CONTRACT (SCC)</b> <b>Rev. No. 00</b>	<b>Item Description: :</b> <b>Monocrystalline DCR PV Module</b> <b>Tender Ref:</b> <b>SPKSCP074</b>
---	--------------------------------------	---	--

		<p>Contract quantities are the quantities as per original contract. If, Contract has been amended, quantities as per amended Contract shall be considered as Contract Quantities. Items for which total quantities to be executed have exceeded the Contract Quantities based on drawings issued to contractor from time to time till issue of Termination letter, then for these items total Quantities as per issued drawings would be deemed to be contract quantities.</p> <p>Substitute/ extra items whose rates have already been approved would form part of contract quantities for this purpose. Substitute/ extra items which have been executed but rates have not been approved, would also form part of contract quantities for this purpose and rates of such items shall be determined in line with contractual provisions.</p> <p>However, increase in quantities on account of additional scope in new tender shall not be considered for this purpose.</p> <p>NOTE: Incase portion of work is being withdrawn, contract quantities pertaining to portion of work withdrawn shall be considered as 'Balance scope of work/supply' for calculating Risk &amp; Cost amount.</p> <p>LD against delay in executed work/supply in case of Termination of Contract  LD against delay in executed work/supply shall be calculated in line with LD clause of the contract for the delay attributable to contractor/ supplier. For this purpose, contract value shall be taken as Executed Value of 30work/supply for the purpose of limiting maximum LD value.</p> <p>Method for calculation of "LD against delay in executed work/supply" is given below.</p> <ol style="list-style-type: none"> <li>1. Let the time period from scheduled date of start of work till termination of contract excluding the period of Hold (if any) not attributable to contractor/ supplier= T1</li> <li>2. Let the value of executed work/supply till the time of termination of contract= X</li> <li>3. Let the Total Executable Value of work/supply for which inputs/fronts were made available to contractor/ supplier and were planned for execution till termination of contract = Y</li> <li>4. Delay in executed work/supply attributable to contractor/supplier i.e. T2=(1-X/Y) x T1</li> <li>5. LD shall be calculated in line with LD clause of the Contract for the delay attributable to contractor/ supplier taking "X" as Contract Value and "T2" as delay attributable to contractor/ supplier.</li> </ol> <p>e) Note: Incase portion of work/supply is withdrawn; no LD shall be applicable for portion of work/supply withdrawn.</p>
33.	NOTE	<p>Delivery Challans &amp; Invoices /Service Entry Sheet in the format as specified under GST laws mentioning your GSTIN No, item HSN/SAC No should accompany supply.</p> <ol style="list-style-type: none"> <li>1. GST portion of invoice shall be released only upon vendor declaring such invoice in his GSTR-1 return and receipt of goods/services and tax and confirmation of payment of GST thereon by vendor on GSTN Portal.</li> <li>2. Bank Guarantee of appropriate value may be obtained from vendor which shall be valid at least one month after the confirmation of payment date by vendor on GST portal and receipt of Tax invoice and receipt of goods, whichever is later. [if (a) above could not be complied].</li> <li>3. In case GST credit is delayed/denied to BHEL due to non/delayed receipt of goods and/or tax invoice or expiry of timeline prescribed in GST law for availing such ITC, or any other reasons not attributable to BHEL, GST amount shall be recoverable from vendor along with interest levied/BG of appropriate value may be obtained from vendor alternatively payment covering GST portion including interest thereon shall be release to vendor only upon completion of these requirements.</li> </ol> <p>In case vendor delays declaring such invoice in his return &amp; GST credit by BHEL is denied or reversed subsequently as per GST law, GST amount paid by BHEL towards such ITC reversal as per GST Law shall be recoverable from vendor/contractor along with interest levied/leviable.be obtained from vendor alternatively payment covering GST portion including interest thereon shall be released to vendor only upon completion of these requirements.</p>
34.	Arbitration & Conciliation Clause	<p>The Conciliation Scheme 2018 attached as <u>Annexure-A</u> shall be applicable. The Signed &amp; Stamped copy of the same to be attached along with the offer as a mark of acceptance.</p> <p>Arbitration &amp; Conciliation Clause:</p> <p>a) In case of contractors/vendors /consultants other than Public Sector Enterprise (PSE) or a Government Department: The parties shall attempt to settle any disputes or difference</p>

 	<b>SOLAR BUSINESS DIVISION (SBD)</b>	<b>SPECIAL CONDITIONS OF CONTRACT (SCC)</b> <b>Rev. No. 00</b>	<b>Item Description: :</b> <b>Monocrystalline DCR PV Module</b> <b>Tender Ref:</b> <b>SPKSCP074</b>
---	--------------------------------------	---	--

		<p>arising out of the formation, breach, termination, validity or execution of the Contract; or, the respective rights and liabilities of the parties; or, in relation to interpretation of any provision of the Contract; or, in any manner touching upon the Contract, or in connection with this contract through friendly discussions. In case no amicable settlement can be reached between the parties through such discussions, in respect of any dispute; then, either Party may, by a notice in writing to the other Party refer such dispute or difference to the sole arbitration of an arbitrator appointed by Head of the BHEL –EDN/SBD. Such Sole Arbitrator appointed, shall conduct the arbitration in English language.</p> <p>The Arbitrator shall pass a reasoned award and the award of the Arbitration shall be final and binding upon the Parties.</p> <p>Subject as aforesaid, the provisions of Arbitration and Conciliation Act 1996 (India) or statutory modifications or re-enactments thereof and the rules made thereunder and for the time being in force shall apply to the arbitration proceedings under this clause. The seat of arbitration shall be Bangalore.</p> <p>The cost of arbitration shall be borne as decided by the Arbitrator upon him entering the reference. Subject to the Arbitration Clause as above, the Courts at Bangalore alone shall have exclusive jurisdiction over any matter arising out of or in connection with this Contract. Notwithstanding the existence or any dispute or differences and/or reference for the arbitration, the parties shall proceed with and continue without hindrance the performance of its obligations under this Contract with due diligence and efficiency in a professional manner except where the Contract has been terminated by either Party in terms of this Contract.</p> <p>b) in case of Contract with contractors/vendors /consultants when they are a Public Sector Enterprise (PSE) or a Government Department: In the event of any dispute or difference relating to the interpretation and application of the provisions of the Contract, such dispute or difference shall be referred by either party for Arbitration to the Sole Arbitrator in the Department of Public Enterprises to be nominated by the Secretary to the Government of India in-charge of the Department of Public Enterprises. The Arbitration and Conciliation Act, 1996 shall not be applicable to arbitration under this clause. The award of the Arbitrator shall be binding upon the parties to the dispute, provided, however, any Party aggrieved by such Award may make further reference for setting aside or revision of the Award to the Law Secretary, Department of Legal Affairs, Ministry of Law and Justice, Government of India. Upon such reference the dispute shall be decided by the Law Secretary or the Special Secretary or Additional Secretary when so authorized by the Law Secretary, whose decision shall bind the Parties hereto finally and conclusively. The Parties to the dispute will share equally the cost of arbitration as intimated by the Arbitrator.”</p>
35.	Provisions for MSE vendors	<p><b>PROVISIONS APPLICABLE FOR MSE VENDORS (MICRO AND SMALL ENTERPRISES)</b></p> <p>Benefits/facilities as applicable for Micro and Small Enterprises (MSEs) shall be available to MSE vendors registered with Government Designated Authorities as per the Purchase &amp; Price Preference Policy of the Government subject to them becoming eligible otherwise.</p> <p>Vendors who qualify as MSE vendors are requested to submit applicable certificates (as specified by the Ministry of Micro, Small and Medium Enterprises) at the time of vendor registration.</p> <p>Vendors have to submit the Udyog Aadhaar Memorandum (UAM)/UDYAM Registration Certificate along with attested copy of a CA certificate [Annexure-2(A) / Annexure-2(B)] applicable for the relevant financial year (latest audited) along with the tender documents in the Part-I Bid to avail the applicable benefits.</p> <p>Date to be reckoned for determining the deemed validity will be the date of bid opening (Part-I in case of two-part bid and three-part bid).</p> <p>Documents have to be notarized/attested by a Gazetted officer and must be valid as on the date of Part-I Bid opening for the vendors to be eligible for the benefits applicable for MSE vendors. Please note that no benefit shall be applicable if any deficiency in the above required documents are not submitted before the Price Bid Opening / Reverse Auction.</p> <p>If the tender is to be submitted through e-procurement portal, then the above required documents are to be uploaded on the portal.</p> <p>Bidders to however note the documents that shall be furnished in order to establish credentials as MSE vendor should be as per the extant statutory requirements specified by the Ministry of Micro, Small and Medium Enterprises (MSME).</p> <p><b>PURCHASE PREFERENCE FOR MSE VENDORS:</b>  <b>(For Items which are divisible in nature)</b></p>

	<b>SOLAR BUSINESS DIVISION (SBD)</b>	<b>SPECIAL CONDITIONS OF CONTRACT (SCC)</b> <b>Rev. No. 00</b>	<b>Item Description: :</b> <b>Monocrystalline DCR PV Module</b> <b>Tender Ref:</b> <b>SPKSCP074</b>
---	--------------------------------------	---	--

		<p>MSE vendors quoting within a price band of L1 + 15% shall be allowed to supply up to 25% of the requirement against this tender provided:</p> <ol style="list-style-type: none"> <li>1. The MSE vendor matches the L1 price.</li> <li>2. L1 price is from a non MSE vendor.</li> <li>3. L1 price will be offered to the vendor nearest to L1 in terms of price ranking (L2 – nearest to L1). In case of non-acceptance by the MSE vendor (L2), next ranking MSE vendor will be offered who is within the L1 + 15% band (if L3 is also within 15% band).</li> <li>4. 3% of the 25% will be earmarked for women owned MSE's.</li> <li>5. 25% of the 25% (i.e., 6.25% of the total enquired quantity) will be earmarked for SC/ST owned MSE firms provided conditions as mentioned in (1) &amp; (2) are fulfilled.</li> <li>6. In case where no SC/ST category firms are meeting the conditions mentioned in (1) and (2) or have not participated in the tender, the 6.25% of earmarked quantity for SC/ST owned MSE firms will be distributed among the other eligible MSE vendors who have participated in the tender.</li> </ol> <p><b>(For Items which are not divisible in nature)</b></p> <p>MSE vendors quoting within a price band of L1 + 15% shall be allowed to supply up to 100% of the requirement against this tender provided:</p> <ol style="list-style-type: none"> <li>1. The MSE vendor matches the L1 price.</li> <li>2. L1 price is from a non MSE vendor.</li> <li>3. L1 price will be offered to the vendor nearest to L1 in terms of price ranking (L2 – nearest to L1). In case of non-acceptance by the MSE vendor (L2), next ranking MSE vendor will be offered who is within the L1 + 15% band (if L3 is also within 15% band).</li> <li>4. No distribution shall be done specifically to women owned MSEs or SC/ST owned MSEs in such cases.</li> </ol> <p><b>Documents to be submitted for claiming MSE status and intended benefits:</b></p> <p>Option 1 (valid till 31.12.2021): Submission of Udyog Aadhar Memorandum along with CA certificate as per Annexure-2(A).</p> <p>Option 2: Submission of Udyam Registration Certificate along with CA certificate as per Annexure-2(B).</p> <p>MSME suppliers can also receive payment through TReDS platform operated by RXIL (Receivables Exchange of India Ltd). As BHEL has entered in to contract with RXIL, our vendors can now avail the facility in TReDS platform.</p>
36.	<p>Compliance to Government of India order OM No.6/18/2019-PPD dated 23.07.2020 &amp; 24.7.2020 regarding restrictions under Rule 144 (XI) of the General Financial Rules (GFRs), 2017</p>	<ol style="list-style-type: none"> <li>I. Any bidder from a country which shares a land border with India will be eligible to bid in this tender only if the bidder is registered with the Competent Authority.</li> <li>II. "Bidder" (including the term 'tenderer', 'consultant' or 'service provider' in certain contexts) means any person or firm or company including any member of a consortium or joint venture (that is an association of several persons, or firms or companies), every artificial juridical person not failing in any of the descriptions of bidders stated hereinbefore, including any agency branch or office controlled by such person, participating in a procurement process.</li> <li>III. "Bidder from a country which shares a land border with India" for the purpose of this Order means: <ol style="list-style-type: none"> <li>1. An entity Incorporated, established or registered in such a country; or</li> <li>2. A subsidiary of an entity Incorporated, established or registered in such a country; or</li> <li>3. An entity substantially controlled through entitles incorporated, established or registered in such a country; or</li> <li>4. An entity whose beneficial owner is situated in such a country, or</li> <li>5. An Indian (or other) agent of such an entity; or</li> <li>6. A natural person who is a citizen of such a country; or</li> <li>7. A consortium or joint venture where any member of the consortium or joint venture falls under any of the above</li> </ol> </li> <li>IV. The beneficial <i>owner</i> for the purpose of (iii) above will be as under: <ol style="list-style-type: none"> <li>1. In case of a company or Limited Liability Partnership, the beneficial owner is the natural person(s), who, whether acting alone or together, or through one or more juridical person, has a controlling ownership interest or who exercises control through other means. Explanation- <ol style="list-style-type: none"> <li>a. "Controlling ownership interest" means ownership of or entitlement to more than twenty-five per cent. Of shares or capital or profits of the company;</li> <li>b. "Control" shall include the right to appoint majority of the directors or to control the management or policy decisions including by virtue of their shareholding or management rights or shareholder's agreements or voting agreements;</li> </ol> </li> </ol> </li> </ol>



**SOLAR BUSINESS  
DIVISION (SBD)**

**SPECIAL  
CONDITIONS OF  
CONTRACT (SCC)  
Rev. No. 00**

**Item Description: :  
Monocrystalline DCR PV Module  
Tender Ref:  
SPKSCP074**

		<p>2. In case of a partnership firm, the beneficial owner is the natural person(s) who, whether acting alone or together, or through one or more juridical person, has ownership of entitlement to more than fifteen percent of capital or profits of the partnership;</p> <p>3. In case of an unincorporated association or body of individuals, the beneficial owner is the natural person(s), who, whether acting alone or together, or through one or more juridical person, has ownership of or entitlement to more than fifteen percent of the property or capital or profits of such association or body of Individuals;</p> <p>4. Where no natural person is Identified under (1) or (2) or (3) above the beneficial owner is the relevant natural person who holds the position of senior managing official;</p> <p>5. In case of a trust, the identification of beneficial owner(s) shall include identification of the author of the trust, the trustee, the beneficiaries with fifteen percent or more interest in the trust and any other natural person exercising ultimate effective control over the trust through a chain of control or ownership.</p> <p>V. An Agent is a person employed to do any act for another or to represent another in dealings with third person.</p> <p>VI. The successful bidder shall not be allowed to sub-contract works to any contractor from a country which shares a land border with India unless such contractor is registered with the Competent Authority.</p> <p>* The above clause is not applicable to the bidders from those countries (even if sharing a land border with India) to which the GoI has extended lines of credit or in which the GoI is engaged in development projects.</p> <p>* List of countries to which lines of credit have been extended or in which development projects are undertaken are available on the Ministry of External affairs website (<a href="https://www.mea.gov.in/">https://www.mea.gov.in/</a>)</p> <p>Compliance to Government of India order OM No.6/18/2019-PPD dated 23.07.2020 &amp; 24.7.2020 regarding restrictions under Rule 144 (XI) of the General Financial Rules (GFRs), 2017 to be submitted on the bidder's letterhead as per Annexure-3(A) or Annexure-3(B) – as applicable.</p>
37.	Compliance to order No. 25-111612018-PG, Dated 02.07.2020 of Ministry of Power, GOI	Compliance to order No. 25-111612018-PG, Dated 02.07.2020 of Ministry of Power, GOI to be submitted in the bidder's letter head as per attached Annexure-4 Note: Non-compliance of MoP Order and its subsequent amendment(s), (if any), by vendor shall lead to rejection of their offer or cancellation of contract, which is awarded by BHEL.
38.	e-Invoicing under GST	<p>1. E-Invoicing under GST is being implemented w.e.f. 1<sup>st</sup> October 2020 for all the taxable person having turnover more than ₹ 50 Crore. It has been specified by the Government of India that it is mandatory to mention a valid unique invoice reference number (IRN) and QR code as generated from Government portal on a Tax Invoice. Based on such information, GST ITC as claimed by BHEL in GST returns shall be matched with the corresponding details uploaded by the supplier in e-Invoicing system.</p> <p>In case the vendor delays or fails to provide all the documents as per the Purchase Order at the time of submitting Tax invoice to BHEL, any subsequent financial loss to BHEL attributable to vendor shall be on Vendor's account. BHEL has further right to take necessary steps to protect its interest at the time of release of payment.</p>
39.	Declaration by bidder regarding protection of commercial interests of BHEL	The Bidder declares that they will not enter into any illegal or undisclosed agreement or understanding, whether formal or informal with other Bidder(s). This applies in particular to prices, specifications, certifications, subsidiary contracts, submission or non-submission of bids or any other actions to restrict competitiveness or to introduce cartelization in the bidding process. In case, the Bidder is found having indulged in above activities, suitable action shall be taken by BHEL as per extant policies/ guidelines.
40.	Note	Vendor who has been banned by BHEL or against whom action due to non-performance has been initiated by BHEL shall not be eligible for participation. Such offers will not be considered for evaluation and will be rejected.
41.	Vendor registration with BHEL-SBD	Bidders, who are not registered with BHEL-SBD, are requested to get registered through online supplier registration portal available on <a href="http://www.supplier.bhel.in">http://www.supplier.bhel.in</a>
42.	Acceptance	Bidders shall confirm acceptance of technical specification which is part of the tender document. Any deviation from technical specification can be rejected at BHEL's discretion.
43.	Tax Deducted at Source (TCS)	This has reference to the newly inserted Section 194Q under Income Tax Act 1961 (applicable w.e.f. 01.07.2021) for deduction of tax at source by a buyer of goods at the time of amount paid or credited for purchase of goods exceeding Rs. 50 lacs.

	<b>SOLAR BUSINESS DIVISION (SBD)</b>	<b>SPECIAL CONDITIONS OF CONTRACT (SCC)</b> <b>Rev. No. 00</b>	<b>Item Description: :</b> <b>Monocrystalline DCR PV Module</b> <b>Tender Ref:</b> <b>SPKSCPV074</b>
---	--------------------------------------	---	---

		<p>The gist of the provisions of Section 194Q are as follows:</p> <p>Tax is required to be deducted at source by a purchaser of goods whose turnover for previous FY has exceeded Rs. 10 Crs. The seller should be a resident of India. TDS @ 0.1% shall be applicable on the amount paid /credited in case purchases from a seller exceeds Rs. 50 Lacs during a financial year. In case PAN of seller is not available or seller is a Specified person (Non-filer), TDS shall be deducted @ 5%. This provision shall not be applicable where tax is deductible under any other provision of I.T Act, 1961. Also, in case a particular transaction qualifies for deduction of TDS u/s 194-Q and the purchaser has deducted the TDS then the same transaction shall not attract TCS u/s 206C(1H).</p> <p>W.e.f. 01.07.2021, as per the above-stated provisions of I. Tax Act, 1961, BHEL HAVING PAN : AAACB4146P IS LIABLE TO DEDUCT TAX AT SOURCE UNDER SECTION 194Q OF THE INCOME TAX ACT AND ACCORDINGLY TDS AT APPLICABLE RATE ON THE PRESCRIBED VALUE UNDER SECTION 194Q WOULD BE DEDUCTED UNDER TAN : BLRB04342C BEFORE MAKING PAYMENT FOR PURCHASE OF GOODS.</p> <p>Thus, all the BHEL Partners are requested not to levy TCS w.e.f. 01.07.2021</p>
44.	Packing Instructions	<p>Packing to be as per standards attached AA0490004- Seaworthy Packing &amp; AA0490009- Export Packing since it is an export project</p> <p>Also Wrapping with Polythene film (&gt; 50 Micron) shall be provided on module pallet with <b>double</b> wrap.</p>
45.	GeM Seller ID	<p>GeM Seller ID shall be mandatory before placement of order on the successful bidder.</p>
46.	Wattage rating for spares requirement	<p>The PV modules offered for mandatory spares (Item No 20), shall have highest wattage rating offered for main supply (Item No 10)</p>
47.	Taxes and duties for export tenders	<p>1 Applicable for Indian bidders for the items shipped from India: This being a physical Export Project, as per Govt. of India's prevailing export policy, custom duty is exempted. However, as per the present GST act, exemption / refund of GST is available only to the exporter. In this case BHEL being the principle exporter, the GST as applicable, paid by our seller / contractors' / sub-vendor / sub-contractors' in India will be paid extra by BHEL against evidence, therefore should not be included in the basic equipment price. However seller / contractors to support BHEL with requisite documents for BHEL to take credit / refund of such GST. As credit / refund is applicable to BHEL for the GST paid, same is not a cost, to BHEL, therefore will not be accounted for price evaluation.</p> <p>Bidder, however, must ensure that the reduced/ concessional rate of GST as applicable for penultimate exporter vide Notification No. 41/2017-Integrated Tax (Rate) dtd. 23-10-2017, Notification No. 40/2017-Central Tax (Rate) dtd. 23-10-2017 or similar Notification issued by any State / Union Territory GST Authority is levied along with all the necessary compliances. The documents/ undertaking required for availing concessional rate of GST shall be made available by BHEL to the bidder before, during or after export of goods from India.</p> <p>The bidder shall also issue suitable instruction to their C&amp;F agent to comply with relevant conditions for compliance of Notification as issued by the tax authorities from time to time. The statutory changes in Taxes/Duties and levies, if any imposed by state/ Central Govt. during the contract delivery period is to BHEL's account and any upward increase in tax implication beyond the contractual delivery period (on account of the delay attributable to seller / contractor) is to respective seller / contractor's account.</p> <p>Benefits on abolition / change / introduction of new tax system in lieu of any existing taxes during the execution of contract, must be passed on to BHEL .</p> <p><b>BHEL intends to claim rewards under 'Merchandise Exports from India Scheme (MEIS)' also intends to claim Duty Drawback under the Customs Act, 1962. The supplier should instruct their C&amp;F agent to ensure availability of these benefits to BHEL.</b></p>

	<b>SOLAR BUSINESS DIVISION (SBD)</b>	<b>SPECIAL CONDITIONS OF CONTRACT (SCC)</b> <b>Rev. No. 00</b>	<b>Item Description: :</b> <b>Monocrystalline DCR PV Module</b> <b>Tender Ref:</b> <b>SPKSCPV074</b>
---	--------------------------------------	---	---

		<p><b>The successful bidder shall instruct C&amp;F agent engaged by them to ensure mentioning of GSTN of the Bidder in the "Shipping Bill" to be filed by them. Bharat Heavy Electricals Ltd is registered with "Engineering Export Promotion Council of India (EEPC India). The copy of valid Registration Cum Membership Certificate shall be provided to the successful bidder.</b></p> <p><b>The C&amp;F Agent engaged by the successful bidder shall be suitably instructed by the bidder to send a copy of the " Shipping Bill ( which shall contain the GSTN of Bidder and Invoice No. of Bidder) and Export General Manifest( EGM)</b></p>
48	Inspection Agency	<p>In case of BHEL/Customer inspection at vendor's works, Inspection call should be furnished in online portal <a href="http://cqir.bhel.in/Cqir/jsp/Masters/login.jsp">http://cqir.bhel.in/Cqir/jsp/Masters/login.jsp</a> (mandatory). It is responsibility of the vendor to inform BHEL at least 15 days prior for carrying out inspection, along with all the relevant test certificates and internal test reports. Such inspection, examination and testing by itself shall not relieve the Seller/Contractor from any obligation under the Order/Contract. Penalty for items not ready after inspection call / failure during inspection: The expenses incurred by BHEL/Representative for travel, stay etc. shall be in vendor's account.</p>



# CORPORATE STANDARD

AA0490004

Rev. No. 02

PAGE 1 of 11

## SEAWORTHY PACKING (PACKING INSTRUCTIONS FOR GENERAL COMPONENTS / ASSEMBLIES / EQUIPMENT)

### 1 GENERAL

This standard lays down packing instructions for seaworthy packing of Components /Assemblies/ Equipment to be dispatched against Customer's contracts, for which there are no special instructions issued by the Engineering Departments.

The Components/Assemblies need to be packed suitably to avoid physical damage & corrosion during transit for storage. For specific applications the concerned engineering department shall issue a product standard. Reference of this standard, must appear in the Shipping list/Packing List.

### 2 SCOPE

This procedure gives minimum guidelines for seaworthy packing to be complied with for packing of Components /Assemblies / Equipment. This packing shall be suitable for different handling operations and for the adverse conditions during transportation and during indoor / outdoor storage for periods more than one year.

### 3 CROSS REFERRED SPECIFICATION

- Multi-layered cross laminated plastic film : AA51420
- Packing Wood : AA51401
- Silica gel : AA55619
- Thermocole : AA51416
- Packing slip holders : AA7240901
- Corrugated Fibre Board : AA51414
- Rubber sheet : AA59001
- VCI paper : AA51406
- High quality full glossy out door finishing paint : AA56126
- Polyethylene air bubble film : IS 12787
- Structural steel - standard quality (plates, sections, strips flats & bars) : AA10108
- International Standards For Phytosanitary Measures No. 15 : ISPM-15:2009

### 4 WOOD SPECIFICATION FOR PACKING

The wood shall conform to specification AA51401.

For export packing wood in addition to the above the following has to be met:

The standard requires the use of debarked wood in the construction of compliant wood packaging material. Debarked wood is defined in the ISPM 5.

### 5 TYPE OF PACKING

The following 5 types of packings have been standardized for packing of General Components /Assemblies.

Revisions:			<b>APPROVED:</b> PROCEDURAL GUIDELINES COMMITTEE – PGC (Packing)		
Rev. No. 02	Amd. No.	Reaffirmed	Prepared	Issued	Dt. of 1 <sup>st</sup> Issue
Dt: 27-07-2018	Dt:	Year:	HPEP, Hyderabad	Corp. R&D	17-08-2013

COPYRIGHT AND CONFIDENTIAL  
The information on this document is the property of BHARAT HEAVY ELECTRICALS LIMITED.  
It must not be used directly or indirectly in any way detrimental to the interest of the company.

DRC-5195



- 'OP' - Open Type
- 'PP' - Partially Packed
- 'CP' - Crate Packing - Components/Equipment requiring physical protection
- 'CQ' - Case Packing - Small medium Components/ Assemblies/ Equipment which require corrosion & physical protection
- 'CR' - Case Packing - Electrical Components/Assemblies which require special packing viz. Water Proof, Shock Proof, etc.

## 6 DESCRIPTION OF TYPES OF PACKING

The various types of packing, as standardized above, are described below.

### 6.1 'OP' - Open Type

In case, of components which are not affected by water & dust & do not require special protection &, are generally not machined, shall be sent as open packages. However these components may be sent in crates, wherever necessary.

### 6.2 'PP' - Partially Packed

Components which need special protection, at selected portions only, shall be dispatched partially packed. Machined surfaces should not be allowed to come directly in contact with the wood. Such surfaces after application of TRP should be protected with Multi-layered cross laminated plastic film to AA51420.

### 6.3 'CP' - Crate Packing – General

Assemblies/Components which need only physical protection from the point of view of handling shall be dispatched duly packed in crates.

### 6.4 'CQ' - Case Packing - Machined Components/Assemblies/Equipment

- a) Small & Medium sized components/assemblies/equipment due to size/weight & to avoid handling, and pilferage, problems shall be packed in Case/Containers.
- b) Wherever required adequate quantity of silica gel to AA55619 or VCI Powder/ Tablets, packed in thin muslin cloth cotton bags shall be suitably placed.
- c) Small machines/components of less weight shall be provided with suitable cushioning. Wood Wool/Expanded Polyethylene Foam Sheet, if used, shall be sandwiched between polyethylene sheets and sealed.
- d) The components inside the case shall be entirely covered with Multi-layered cross laminated plastic film to AA51420, where-ever required.

### 6.5 'CR' - Case Packing - Electrical & Electronic Components/Assemblies

Delicate components likely to be damaged e.g. Gauges, Instruments etc. are to be wrapped in waxed paper or polyethylene air bubble film and packed in cartons.

- a) Adequate quantity of Silica gel to AA55619 packed in cotton bags, of 100 grams each are to be suitably placed in the cartons. The cartons shall be entirely covered with Multi-layered cross laminated plastic film to AA51420, before being packed in the cases.
- b) VCI Powder/Tablets can be used as an alternative to Silica Gel to AA55619.
- c) Empty space in the cartons shall be filled with small chips of Expanded Polystyrene (Thermocole), Wood Wool etc. Polyethylene air bubble film shall conform to IS 12787/AA51420 Expanded polystyrene (Thermocole) shall conform to AA51416.
- d) The cartons shall be manufactured from corrugated Fibre Board, meeting requirements of AA51414.

### 6.6 Special Packing

Components requiring special packing (as per customer/contractual/ engineering requirements) not included in this specification shall be covered by product standards.



## CORPORATE STANDARD

AA0490004

Rev. No. 02

PAGE 3 of 11

### 7 PREPARATION OF PACKING CASE

- 1) Cases and crates with gross weight up to 1,000 kgs. shall be provided with bottom cleats of min. 40 mm thicknesses to ensure clearance for handling by forklift. Cases and crates exceeding gross weight of 1,000 kgs. shall be provided with skid runners, number and size according to weight of package.
- 2) The base of the case shall be made of wooden batons for planks giving necessary reinforcement, such that the bottom of the equipment is at a height of 100 to 200 mm from the ground level depending upon size & weight of equipment. However for packing cases of smaller size equipment can be at a height of 40 mm from the ground level.
- 3) In case of 'CR1 - Packing Viz. Electrical & Electronic components for instruments/assemblies, a rubber sheet, Self-expanded polyethylene foam sheet, preferably 10 mm thick, shall be fixed on to the base to act as cushioning to the equipment.
- 4) The four sides, shall be lined, from inside with multi-layered cross-laminated polyethylene sheet of 90GSM as per AA51420 and tacked at suitable places.  
Whenever specified the top cover will have a layer of multi-layered cross laminated polyethylene sheet of 90 GSM over the cover. This should project about 100 - 250mm on all sides.  
It is preferable to have a single piece of the above Multi-layered cross laminated polyethylene sheet fixed on the four sides. In case jointing is unavoidable, it should be done by overlapping of approximately 100mm.
- 5) Place the Components/cartons with corrosion inhibitors duly applied wherever necessary for place suitably, thin muslin cloths bags containing 100 grams (approx.) of activated Blue Silica Gel to AA55619, wherever necessary. Alternatively VCI Powder or Tablet may be used.
- 6) In case, depression is formed, at the top, after the equipment is lowered, provide ply board/wooden batons.
- 7) Cover the whole equipment with polyethylene sheet of at least 100 micron thickness, on all sides preferably by a single piece.
- 8) For indoor panels/equipment, provide suitable packing batons with covering of Thermocole/expanded soft polyethylene foam/polyethylene air bubble film wrapped with suitable cords, to avoid cutting of the polyethylene sheet so that finished surface is not damaged.
- 9) Empty space in the box shall be filled with adequate cushioning material e.g. Thermocole Chips, Wood Wool etc. to avoid movement for shocks. Alternatively put wooden blocks/batons wherever necessary.
- 10) The inner side of the top cover shall be lined with polyethylene sheet, of at least
- 11) 100 micron thickness, which shall project approximately 25 to 150 mm depending upon the size of the case on all sides of the top cover shall be provided below the top cover. This projection, after nailing the top cover, shall be folded over, on the sides of the crates & tacked, to, prevent ingress of water from the top.
- 12) For specific requirement of packing the cases are to be provided with Tongue and Groove joints.

### 8 STEEL CONTAINERS

Steel containers for packing can be used in case of repeated supplies of the same equipment. Empty steel containers are to be returned back from customer's end and to be reused for the next supplies.

The containers are to be made of structural steel as per AA10108 with proper reinforcement with I, C and T Sections.

#### Following precautions are to be taken during packing:

- Put the Components/Assemblies/Equipment in the steel container properly. Cover the Components/Assemblies/Equipment with polythene.
- To arrest the movement in the steel container necessary wooden Blocks/Batons may be put.
- Put cover on steel, container and Bolt Properly.



## 9 SEALED PACKING

Components sub-assemblies and assemblies sensitive to climatic conditions shall be packed seal tight. All the openings of the sensitive components, sub-assemblies and assemblies shall be blanketed to prevent the ingress of dust and moisture.

The components sub-assemblies and assemblies are completely covered with 2 layers of polyethylene sheet. All sharp corners and edges are to be protected by rubber mats to prevent the polyethylene sheet from damage. Top surface of the case shall be free from dents to prevent rain water pockets.

## 10 SLING PLATE

Sling plate shall be provided to prevent damage to the packing box during lifting. Size of the sling plate shall be selected depending upon the net weight of the consignment.

## 11 PACKING SLIP HOLDERS

Two nos. steel packing slip holders, specification no. AA7240901 containing the packing list, sealed in thick polyethylene film, shall be fixed one inside and the other outside the packing box.

## 12 Volatile Corrosion Inhibitor (VCI) Paper

- a) Un-protected surfaces of steel and cast iron components, tools bearing, shaft seals etc. are covered with VCI paper. VCI paper has been impregnated with corrosion inhibitors which by evaporation and chemical conversion protect metals in an enclosed area against corrosion.
- b) 7 m<sup>3</sup> VCI paper is necessary for 1 m<sup>3</sup> of packed item approximately as per AA51406.

### Application Limitation:

VCI paper shall not be used for components made of aluminium, aluminium alloys as well as Zinc, copper, brass, cadmium and silver.

VCI powder is sprinkled inside the piping components ends shall be protected with end cover as specified in plant standards, drawings.

## 13 Moisture Absorber

Silica gel is used for this purpose to protect the contents over sufficiently long time from corrosion. At the time of use, silica gel should be so dried that its colour becomes dark blue. These shall be filled in small cotton bags. Before sealing the equipment, the silica gel bags should be kept inside the polyethylene film cover at different locations. The quantity of silica gel should not be less than 1.0 kg per cubic metre volume of the packing box



## CORPORATE STANDARD

AA0490004

Rev. No. 02

PAGE 5 of 11

### 14 GENERAL PRECAUTIONS

- a) While fixing nails during packing, necessary care shall be taken to ensure that materials used for protection inside the case e.g. paper, polyethylene sheet, coir etc. do not get damaged.
- b) Sling protection brackets to be provided on cases wherever required.
- c) It shall be ensured that all stencil marks external, front & rear sides of the casing shall be of water proof Material to prevent obliteration in transit.
- d) The various caution signs shall be marked with stencil on both sides of the packing box.
- e) Do not pack any other Mechanical items with this case (do not use any other non-permitted packing materials).

### THE FOLLOWING DETAILS ARE TO BE MARKED ON THE PACKING CASES.

- a) Address of consignee.
- b) Purchase Order No./ SO No/WO No.
- c) Description of item or title of packing list.
- d) Case identification Number/ Packing List No.
- e) Net Weight.
- f) Gross Weight.
- g) Dimensions of box
- h) Marking showing upright position.
- i) Marking showing sling position.
- j) Marking showing umbrella (i.e. for machines/components to be stored under covered storage.
- k) Loading and unloading precautions

### MARKINGS ON PACKING CASE S

1. THIS PLANT STANDARD PRESCRIBES THE VARIOUS CAUTION SIGNS AND OTHER MARKINGS ON PACKING CASES.
2. DIMENSIONS IN THE TABLE 1 SHALL BE USED FOR MAKING STENCILS ONLY.

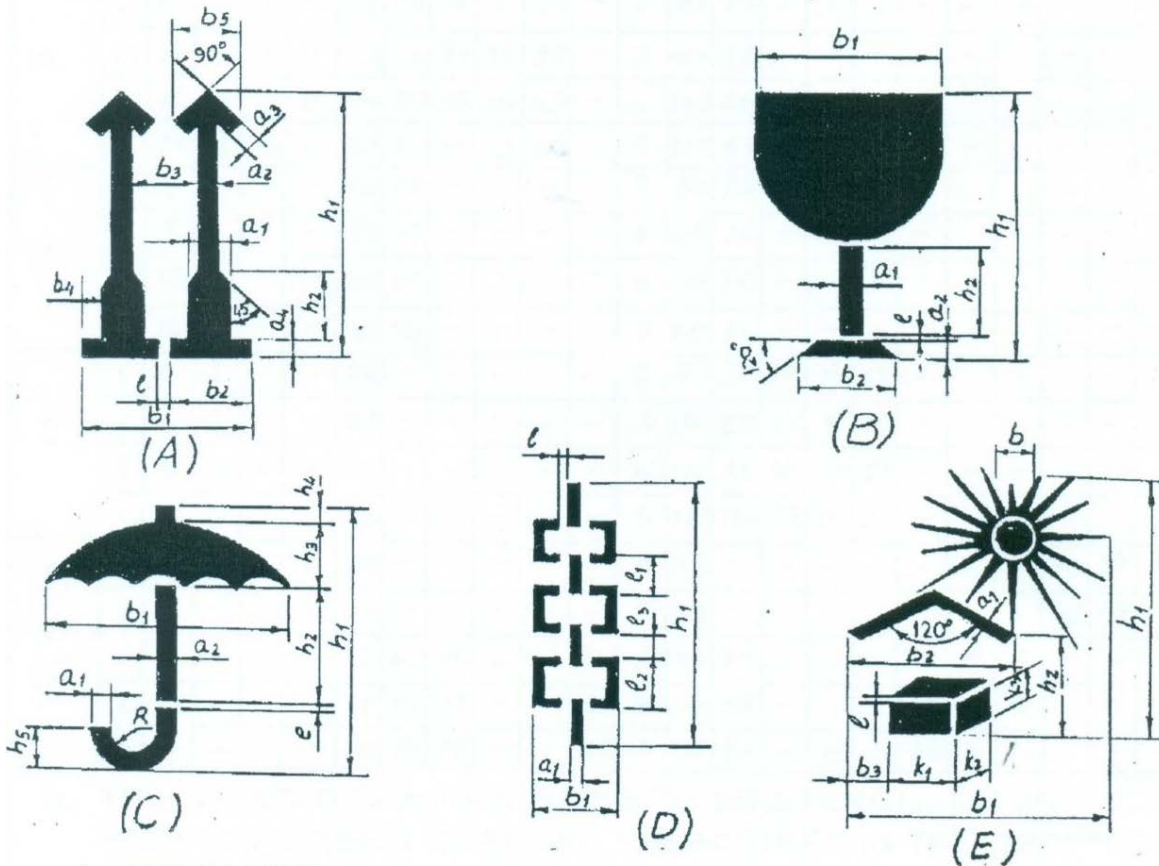

- UPRIGHT
- FRAGILE
- PROTECTION FROM FALLING OR CONDENSING MOISTURE.
- SLINGING POSITION
- PROTECTION FROM DIRECT RADIATIONS.

Figure 1



Figure 2

**Table 1**

DESIGN- ATION	DIMENSIONS IN mm.																								
	a <sub>1</sub>	a <sub>2</sub>	a <sub>3</sub>	a <sub>4</sub>	b <sub>1</sub>	b <sub>2</sub>	b <sub>3</sub>	b <sub>4</sub>	b <sub>5</sub>	b	ℓ	h <sub>1</sub>	h <sub>2</sub>	h <sub>3</sub>	h <sub>4</sub>	h <sub>5</sub>	K <sub>1</sub>	K <sub>2</sub>	K <sub>3</sub>	ℓ <sub>1</sub>	ℓ <sub>2</sub>	ℓ <sub>3</sub>	R		
A	1	12	5	5	4	52	25	19	8	21	-	2	84	23	-	-	-	-	-	-	-	-	-	-	
	2	17	7	7	6	75	36	29	11	30	-	3	119	33	-	-	-	-	-	-	-	-	-	-	
	3	24	10	10	8	104	50	38	16	42	-	4	168	46	-	-	-	-	-	-	-	-	-	-	
	4	34	14	14	11	147	71	59	23	60	-	5	239	65	-	-	-	-	-	-	-	-	-	-	-
B	1	5	5	-	-	50	33	-	-	-	-	2	84	25	-	-	-	-	-	-	-	-	-	-	
	2	7	7	-	-	71	47	-	-	-	-	3	119	36	-	-	-	-	-	-	-	-	-	-	
	3	10	10	-	-	100	66	-	-	-	-	4	168	50	-	-	-	-	-	-	-	-	-	-	
	4	14	14	-	-	142	94	-	-	-	-	5	239	71	-	-	-	-	-	-	-	-	-	-	
C	1	4	3	-	-	66	-	-	-	-	-	2	80	39	19	5	11	-	-	-	-	-	-	6	
	2	6	4	-	-	85	-	-	-	-	-	3	114	55	27	7	16	-	-	-	-	-	-	9	
	3	8	6	-	-	120	-	-	-	-	-	4	160	78	38	10	22	-	-	-	-	-	-	12	
	4	11	9	-	-	170	-	-	-	-	-	5	227	110	54	14	31	-	-	-	-	-	-	17	
D	1	6	-	-	-	30	-	-	-	-	-	4	148	-	-	-	-	-	-	-	-	30	30	10	-
	2	9	-	-	-	42	-	-	-	-	-	5	209	-	-	-	-	-	-	-	-	42	42	14	-
E	1	3	-	-	-	69	47	10	-	-	16	2	91	26	-	-	-	17	8	11	-	-	-	-	
	2	4	-	-	-	98	67	15	-	-	23	3	128	33	-	-	-	24	11	16	-	-	-	-	
	3	6	-	-	-	138	94	20	-	-	32	4	182	62	-	-	-	34	16	22	-	-	-	-	

Black and Red Marking Ink to IS: 1234 "Ink, Stencil, Oil Base, For Marking Porous Surfaces" or duplicating ink stencilling, oil base for marking porous surfaces.

All cases containing fragile items are to be stencilled with red marking and stencilling paint/ink.

**"HANDLE WITH CARE", "FRAGILE DO NOT TURN OVER".**

Besides the caution signs the product information shall be stencilled of letters with 13mm to 50mm height.

In case of consignment consists of more than one package, each package shall carry its Package No. as given in shipping list. All caution signs shall be stencilled in higher quality full glossy out door finishing paint red in colour (AA56126). All other markings shall be carried out in black enamel (AA56126).

Caution signs & other markings shall be stencilled on both the end shooks & the side shooks. Caution sign (for slinging) shall be stencilled only on side shooks at the appropriate place.

Note: In case the size of package is small for using the stencils, then hand written letters/figures shall be allowed.



## 15 PROCEDURE FOR HANDLING OF COMPONENTS

The purpose of this procedure is to protect the quality of the components/equipment while handling in various stages of manufacturing packing & despatching.

- 15.1 Adequate care shall be taken in handling the material, and components to avoid damage during receipts, storage issue manufacture & despatch operations.
- 15.2 Appropriate material handling equipment like fork lifters, cranes etc. Shall be used where needed.
- 15.3 Lifting by crane and transportation by trolley of critical items and large components like rotors castings etc. Shall be done carefully.
- 15.4 For critical items, where specified, special handling fixtures shall be used for lifting.
- 15.5 Slings and shackles used for lifting the components/equipment shall be checked for fitness and suitability before use.
- 15.6 Slings used on machined surfaces shall be suitably padded. No slings shall be used on journal surfaces.
- 15.7 Precision machined components like blades, catches, rollers etc. Shall be lifted using suitable wooden pallets.

### 15.8 HANDLING OF COMPONENTS ON RECEIPT/DESPATCH:

Before loading/unloading a packing case from the carrier look for the following shipping instructions painted on the packing case.

- The markings showing the upright position.
- The markings showing the sling position
- Markings showing the fragile contents.
- Other required markings as per Clause No. 12

- 15.8.1 Appropriate cranes and slings should be used for different components/ cases. Slings should normally make an angle as minimum as possible (width wise) but in no case more than 15°.
- 15.8.2 Handling and lifting should be done without jerks or impacts.
- 15.8.3 Immediately after receipt of the goods, the packing should be examined all-round for any sign of damage. If necessary, lift the cover or a number of boards of the case so as to make the contents visible. In the event of sealed packing being used the plastic sheeting should not be damaged. It is imperative that the packing material is restored in original condition after the inspection.
- 15.8.4 On receipt of the equipment it should be checked with the shipping list and missing or damage if any should be reported immediately. It is important to arrange for immediate examination to determine the extent of the damage, the cause of the damage and where applicable the person or persons responsible for the damage. According to general practice when transporting by railway or by road vehicle the carrier concerned should be immediately called upon (within specified periods) for jointly establishing a statement of the damage. This is essential as a basis for a subsequent claim and possible damage report to the insurance company.
- 15.8.5 Protective coating applied on machined surfaces should not be disturbed. The plastic covering should be put back carefully so that it prevents ingress of dust and moisture. Some packing may have vapour phase inhibitor (VPI) paper enclosed inside the packing cases. This should be restored to its original place as far as possible.
- 15.8.6 Silica gel and such other chemicals kept in the box as desiccants and indicators should also be left in the box itself.

## 16 GI SHEET

The packing cases are covered with GI sheet on outside for sides and top; inside for bottom as per the Figure-3 (GI sheet covering is applicable for all closed type of wooden packing).



## CORPORATE STANDARD

AA0490004

Rev. No. 02

PAGE 9 of 11

### 17 Treatment of Wood & Application and use of the mark

For seaworthy export packing, treatment of wood has to be carried out as below subject to BHEL Engg & QC approval.

As per customer requirement for export packing, wood to be treated as applicable should be done as per International Standards for Phytosanitary Measures ISPM: 15 to control the growth stages viz. egg to adult of structural insects (beetles, borers, bugs, fleas, flies, lice, moths, roaches, termites) and other pests (mice, rats, spiders) etc. in stored products.

The specified marks applied to wood packaging material treated in accordance with ISPM 15 must conform to the requirements described in Annex 2 of ISPM 15.

#### 17.1 Heat treatment using a conventional steam or dry kiln heat chamber (treatment code for the mark: HT)

When using conventional heat chamber technology, the fundamental requirement is to achieve a minimum temperature of 56 °C for a minimum duration of 30 continuous minutes throughout the entire profile of the wood (including its core).

This temperature can be measured by inserting temperature sensors in the core of the wood. Alternatively, when using kiln-drying heat chambers or other heat treatment chambers, treatment schedules may be developed based on a series of test treatments during which the core temperature of the wood at various locations inside the heat chamber has been measured and correlated with chamber air temperature, taking into account the moisture content of the wood and other substantial parameters (such as species and thickness of the wood, air flow rate and humidity). The test series must demonstrate that a minimum temperature of 56 °C is maintained for a minimum duration of 30 continuous minutes throughout the entire profile of the wood.

Treatment schedules should be specified or approved by the National Plant Protection Organisation (NPPO). Treatment providers should be approved by the NPPO.

#### 17.2 Heat treatment using dielectric heating (treatment code for the mark: DH)

Where dielectric heating is used (e.g. microwave), wood packaging material composed of wood not exceeding 20 cm when measured across the smallest dimension of the piece or the stack must be heated to achieve a minimum temperature of 60 °C for 1 continuous minute throughout the entire profile of the wood (including its surface). The prescribed temperature must be reached within 30 minutes from the start of the treatment.

Treatment schedules should be specified or approved by the NPPO.

#### 17.3 Methyl bromide treatment (treatment code for the mark: MB)

Wood packaging material containing a piece of wood exceeding 20 cm in cross-section at its smallest dimension must not be treated with methyl bromide.

The fumigation of wood packaging material with methyl bromide must be in accordance with a schedule specified or approved by the NPPO (National Plant Protection Organisation) that achieves the minimum concentration-time product (CT) over 24 hours at the temperature and final residual concentration specified in Table 1. This CT must be achieved throughout the profile of the wood, including its core, although the concentrations would be measured in the ambient atmosphere. The minimum temperature of the wood and its surrounding atmosphere must not be less than 10 °C and the minimum exposure time must not be less than 24 hours. Monitoring of gas concentrations must be carried out at a minimum at 2, 4 and 24 hours from the beginning of the treatment. In the case of longer exposure times and weaker concentrations, additional measurement of the gas concentrations should be recorded at the end of fumigation.

If the CT is not achieved over 24 hours, corrective action needs to be taken to ensure the CT is reached; for example, the treatment is restarted or the treatment time extended for a maximum of 2 hours without adding more methyl bromide to achieve the required CT (see the footnote to Table 2).

**Table 2 – Minimum CT over 24 hours for wood packaging material fumigated with methyl bromide**

Temperature (°C)	CT (g·h/m <sup>3</sup> ) over 24 h	Minimum final concentration (g/m <sup>3</sup> ) after 24 h#
21.0 or above	650	24
16.0 – 20.9	800	28
10.0 – 15.9	900	32

# In circumstances when the minimum final concentration is not achieved after 24 hours, a deviation in the concentration of ~5% is permitted provided additional treatment time is added to the end of the treatment to achieve the prescribed CT.

One example of a schedule that may be used for achieving the specified requirements is shown in Table 3.

**Table 3 – Example of a treatment schedule that achieves the minimum required CT for wood packaging material treated with methyl bromide (initial doses may need to be higher in conditions of high sorption or leakage)**

Temperature (°C)	Dosage (g/m <sup>3</sup> )	Minimum concentration (g/m <sup>3</sup> ) at:		
		2 h	4 h	24 h
21.0 or above	48	36	31	24
16.0 – 20.9	56	42	36	28
10.0 – 15.9	64	48	42	32

Treatment providers should be approved by the NPPO.

#### 17.4 Marking

The specified marks applied to wood packaging material treated in accordance with ISPM 15 must conform to the requirements described in ISPM 15.

#### 18 PROVISION FOR INSPECTION

This clause is applicable only where contractual requirement of customer is there. For other packings this is not applicable.

Each transportable packing's shall have provision for inspection by customer authority etc. during transport from origin of dispatched till destination. This inspection may require opening of the package and subsequently closing it again. For this purpose suitable designed opening with bolted cover shall be provided. Such an opening shall be clearly marked as "OPENING" with clear instruction for opening & closing written on this cover. For large consignment the size of the opening shall be suitable to facilitate entry of personnel.

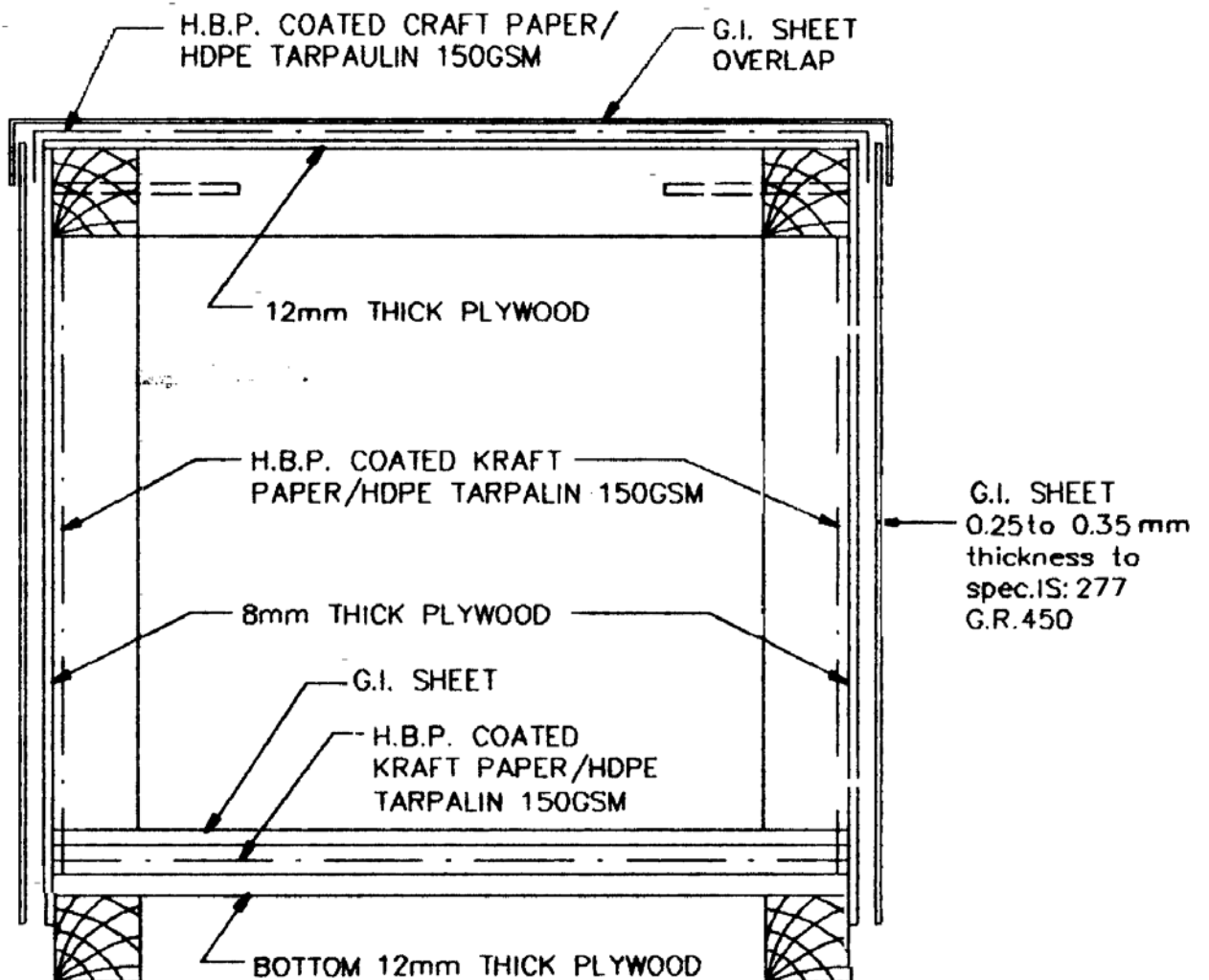

CLOSED PACKING CASE WITH  
G.I.SHEET SHOWING LAYERS  
OF PACKING MATERIALS

Figure 3



# CORPORATE STANDARD

AA0490009

Rev. No. 02

PAGE 1 of 10

## EXPORT PACKING

(PACKING INSTRUCTIONS FOR GENERAL COMPONENTS / ASSEMBLIES / EQUIPMENT)

### 1 GENERAL

This standard lays down packing instructions for export packing of components/assemblies/equipment to be dispatched against Customer's contracts, for which there are no special instructions issued by the Engineering Departments. For Seaworthy Packing refer standard AA0490004 wherever applicable.

The components/assemblies need to be packed suitably to avoid physical damage & corrosion during transit for storage. For specific applications, the concerned engineering department shall issue a product standard. Reference of this standard, must appear in the Shipping list/Packing List.

### 2 SCOPE

This procedure gives minimum guidelines for export packing to be complied with for packing of components/assemblies/equipment. This packing shall be suitable for different handling operations and for the adverse conditions during transportation and during indoor / outdoor storage for periods more than one year.

### 3 WOOD SPECIFICATION FOR PACKING:

a) The wood shall conform to specification AA51401.

In addition to the above the following has to be met:

The standard requires the use of debarked wood in the construction of compliant wood packaging material. Debarked wood is defined in the ISPM 15

b) Ply Wood planks as per specification IS:303 Gr. "MR" Type A,B are used for the sides, top & bottom of the packing cases.

c) Ply Wood of marine grade as per IS:710 for packing of control equipment and for support batten pinewood to be used as per specification AA51401.

### 4 TYPE OF PACKING:

The following types of packing have been standardized for packing of general components/assemblies.

- 'OP' - Open Type
- 'PP' - Partially Packed
- 'CP' - Crate Packing - Components/Equipment requiring physical protection
- 'CQ' - Case Packing - Small medium Components/ Assemblies/ Equipment which require corrosion & physical protection
- 'CR' - Case Packing - Electrical Components/Assemblies which require special packing viz. Water Proof, Shock Proof, etc.

### DESCRIPTION OF TYPES OF PACKING

The various types of packing, as standardized above, are described below.

Revisions:

**APPROVED:**

PROCEDURAL GUIDELINES COMMITTEE –  
PGC (Packing)

Rev. No. 02

Amd. No.

Reaffirmed

Prepared

Issued

Dt. of 1<sup>st</sup> Issue

Dt: 28-08-2018

Dt:

Year:

HEP, Bhopal

Corp. R&D

31-05-2018

COPYRIGHT AND CONFIDENTIAL  
The Information on this document is the property of BHARAT HEAVY ELECTRICALS LIMITED.  
It must not be used directly or indirectly in any way detrimental to the Interest of the company.

**4.1 'OP' - Open Type**

In case, of components which are not affected by water & dust & do not require special protection &, are generally not machined, shall be sent as open packages. However these components may be sent in crates, wherever necessary.

**4.2 PP' - Partially Packed**

Components which need special protection, at selected portions only, shall be dispatched partially packed. Machined surfaces should not be allowed to come directly in contact with the wood. Such surfaces after application of TRP should be protected with Multi-layered cross laminated plastic film to AA51420.

**4.3 'CP' - Crate Packing – General**

Assemblies/Components which need only physical protection from the point of view of handling shall be dispatched duly packed in crates.

**4.4 'CQ' - Case Packing - Machined Components/Assemblies/Equipment**

- a) Small & Medium sized components/assemblies/equipment due to size/weight & to avoid handling, and pilferage, problems shall be packed in Case/Containers.
- b) Wherever required adequate quantity of silica gel to AA55619 or VCI Powder/ Tablets, packed in thin muslin cloth cotton bags shall be suitably placed.
- c) Small machines/components of less weight shall be provided with suitable cushioning. Wood Wool/Expanded Polyethylene Foam Sheet, if used, shall be sandwiched between polyethylene sheets and sealed.
- d) The components inside the case shall be entirely covered with Multi-layered cross laminated plastic film to AA51420, where-ever required.

**4.5 'CR' - Case Packing - Electrical & Electronic Components/Assemblies**

Delicate components likely to be damaged e.g. Gauges, Instruments etc. are to be wrapped in waxed paper or polyethylene air bubble film and packed in cartons.

- a) Adequate quantity of Silica gel to AA55619 packed in cotton bags, of 100 grams each are to be suitably placed in the cartons. The cartons shall be entirely covered with Multi-layered cross laminated plastic film to AA51420, before being packed in the cases.
- b) VCI Powder/Tablets can be used as an alternative to Silica Gel to AA55619.
- c) Empty space in the cartons shall be filled with small chips of Expanded Polystyrene (Thermocole), Wood Wool etc. Polyethylene air bubble film shall conform to IS 12787/AA51420 Expanded polystyrene (Thermocole) shall conform to AA51416.
- d) The cartons shall be manufactured from corrugated Fibre Board, meeting requirements of AA51414.

**4.6 Special Packing**

Components requiring special packing (as per customer/contractual/ engineering requirements) not included in this specification shall be covered by product standards.

**5 PREPARATION OF PACKING CASE:**

- 1) Export items are to be packed in sea-worthy wooden/Ply board cases.
- 2) The base of the case shall be made of wooden battens for planks giving necessary reinforcement, such that the bottom of the equipment is at a height of 100 to 200mm from the ground level depending upon size & weight of equipment. However for packing cases of smaller size equipment can be at a height of 40mm from the ground level.
- 3) The four sides & top cover shall be lined, from inside with multi-layered cross-laminated polyethylene sheet of 90GSM as per AA51420 and tacked at suitable places.

Whenever specified the top cover will have a layer of multi-layered cross laminated polyethylene sheet of 90 GSM over the cover. This should project about 100 - 250mm on all sides.



## CORPORATE STANDARD

AA0490009

Rev. No. 02

PAGE 3 of 10

It is preferable to have a single piece of the above Multi-layered cross laminated polyethylene sheet fixed on the four sides. In case jointing is unavoidable, it should be done by overlapping of approximately 100mm.

- 4) Put the job on the base and wherever necessary may be screwed / fastened.
- 5) In case of delicate component Packing Viz. Electrical & Electronic components for instruments/assemblies, a rubber sheet, Self-expanded polyethene foam sheet as per AA51423, preferably 10mm thick, shall be fixed on to the base to act as cushioning to the equipment.
- 6) Place the Components/cartons with corrosion inhibitors duly applied wherever necessary for place suitably, thin muslin cloths bags containing 100grams (approx.) of activated Blue Silica Gel to AA55619, wherever necessary. Alternatively VCI Powder or Tablet may be used.
- 7) In case, depression is formed, at the top, after the equipment is lowered, provide ply board/wooden batons.
- 8) Whole Equipment shall be covered and sealed with Multi-layered cross-laminated Polyethylene sheet to AA51420.
- 9) For indoor panels/equipment, provide suitable packing batons with covering of Thermocole/ expanded soft polyethylene foam/polyethylene air bubble film wrapped with suitable cords, to avoid cutting of the polyethylene sheet so that finished surface is not damaged.
- 10) Empty space in the box shall be filled with adequate cushioning material e.g. Thermocole Chips, Wood Wool etc. to avoid movement for shocks. Alternatively put wooden blocks/batons wherever necessary.
- 11) The inner side of the top cover shall be lined with M.L.C. laminated polyethylene sheet of at least 90GSM, which shall project approximately 25 to 150mm depending upon the size of the case on all sides of the top cover shall be provided below the top cover. This projection, after nailing the top cover, shall be folded over, on the sides of the crates & tacked, to, prevent ingress of water from the top.
- 12) For specific applications requiring additional protection the packing cases are covered with GI sheet on outside for sides and top; inside for bottom as per specification AA10166, thickness of G.I. sheet shall be 0.25mm.
- 13) For specific applications requiring inspection, additional inspection window has to be provided for custom clearance for export jobs.

### 6 SEALED PACKING:

Components sub-assemblies and assemblies sensitive to climatic conditions shall be packed seal tight. All the openings of the sensitive components, sub-assemblies and assemblies shall be blanketed to prevent the ingress of dust and moisture.

The components sub-assemblies and assemblies are completely covered with 2 layers of M.L.C. laminated poly film. All sharp corners and edges are to be protected by rubber mats to prevent the polyethylene sheet from damage. Top surface of the case shall be free from dents to prevent rain water pockets.

Certain special precautions are required for seal tight packing of specific item have to be covered by product standard.

### 7 OTHER PACKING MATERIAL

#### 7.1 Volatile Corrosion Inhibitor (VCI) Paper as per AA51406:

- a) Un-protected surfaces of steel and cast iron components, tools bearing, shaft seals etc. are covered with VCI paper. VCI paper has been impregnated with corrosion inhibitors which by evaporation and chemical conversion protect metals in an enclosed area against corrosion.
- b) 7m<sup>3</sup> VCI paper is necessary for 1 m<sup>3</sup> of packed item approximately as per AA51406.

#### Application Limitation:

VCI paper shall not be used for components made of aluminium, aluminium alloys as well as Zinc, copper, brass, cadmium and silver. VCI powder is sprinkled inside the piping components ends shall be protected with end cover as specified in plant standards, drawings.

**7.2 Moisture Absorber:**

Silica gel is used for this purpose to protect the contents over sufficiently long time from corrosion. At the time of use, silica gel should be so dried that its colour becomes dark blue. These shall be filled in small cotton bags. Before sealing the equipment, the silica gel bags should be kept inside the polyethylene film cover at different locations. The quantity of silica gel depends on the dimension of the polyethylene sheet as well as transit and storage time.

**7.3 Sling Plate:**

Sling plate shall be provided to prevent damage to the packing box during lifting. Size of the sling plate shall be selected depending upon the net weight of the consignment.

**7.4 Packing Slip Holders:**

Two nos. of packing list with suitable protecting cover shall be fixed one inside and the other outside of the packing box as per specification AA7240901.

**7.5 Nails**

The length and diameter of the nails depends upon the size of planks

**7.6 Strapping Strips:**

These are used for strapping the boxes. Suitable size of box strapping strip can be used as per size and weight of consignment. The material shall be free from rust.

**7.7 Brackets:**

These brackets are used for nailing to the corners of cubicle boxes. The brackets shall be of "L" shape, suitable holes shall be provided towards the end of each side for screwing /nailing.

**7.8 Fasteners:**

Bolts, double nuts, spring washers of suitable size will have to be used for packing of some special items like transformers, reactors, breakers, etc., to hold the job to the bottom plank of the box.

**7.9 Polyethylene Sheet:**

The polyethylene sheets are used to make covers to the jobs individually. multi-layered cross laminated polyethylene sheet as per AA 51420 can be used for packing of jobs.

**7.10 Expanded Poly Foam Sheet and Air Bubble Film:**

This item is used for covering the delicate items, Expanded Polyethylene Foam Sheet as per specification AA51423 and air bubble film as per specification AA51426

**7.11 Thermocol (Expanded Polystyrene) Sheets:**

This is used for covering delicate items. This material shall be as per spec. no AA51416

**7.12 Cotton Bags:**

These are used for holding silica gel.

**7.13 Marking Ink:**

The ink used normally is black in color. In some special cases other color also will have to be used. The ink shall be non-fading/indelible and non-washable by water

**7.14 Polyethylene Bags:**

These are to be used for keeping the, Packing slips. The bag shall be of size 70 mm X 100 mm (minimum).

**7.15 Mechanical Latching Clamps:**

For specific items self locking clamps can also be used on need basis in conjunction with or apart from regular bolt and nut fixing arrangement, if needed.



## CORPORATE STANDARD

AA0490009

Rev. No. 02

PAGE 5 of 10

### 8 DESIGN OF PACKING BOXES

Design/drawing of packing boxes shall be prepared based on actual weight and size of the equipment and shall be covered by concern product standards.

### 9 GENERAL PRECAUTIONS:

- 1) While fixing nails during packing, necessary care shall be taken to ensure that materials used for protection inside the case e.g. paper, polyethylene sheet, coir etc. do not get damaged.
- 2) Sling protection brackets to be provided on cases wherever required.
- 3) It shall be ensured that all stencil marks external, front & rear sides of the casing shall be of water proof Material to prevent obliteration in transit.
- 4) For packing of small/delicate items - Item may be wrapped properly with M.L.C. laminated polyethylene and wrapped item may be further wrapped with air bubble film as per spec. AA51426, these curtains will be subsequently packed in wooden/ply boxes as at clause 7.
- 5) The various caution signs shall be marked with stencil on both sides of the packing box.
- 6) Instructions on handling, storage, preservation, re-preservation and transport of export order components at works and site shall be covered by product standards.

### 10 MARKING

The following details are to be marked on the packing cases.

- a) Address of consignee.
- b) Purchase Order No.
- c) Description of item or title of packing list.
- d) Case identification Number.
- e) Net Weight.
- f) Gross Weight.
- g) Dimensions of box
- h) Marking showing upright position.
- i) Marking showing sling position.
- j) Marking showing umbrella (i.e. for machines/components to be stored under covered storage).

## MARKINGS ON PACKING CASE S

1. THIS PLANT STANDARD PRESCRIBES THE VARIOUS CAUTION SIGNS AND OTHER MARKINGS ON PACKING CASES.
2. DIMENSIONS IN THE TABLE 1 SHALL BE USED FOR MAKING STENCILS ONLY.

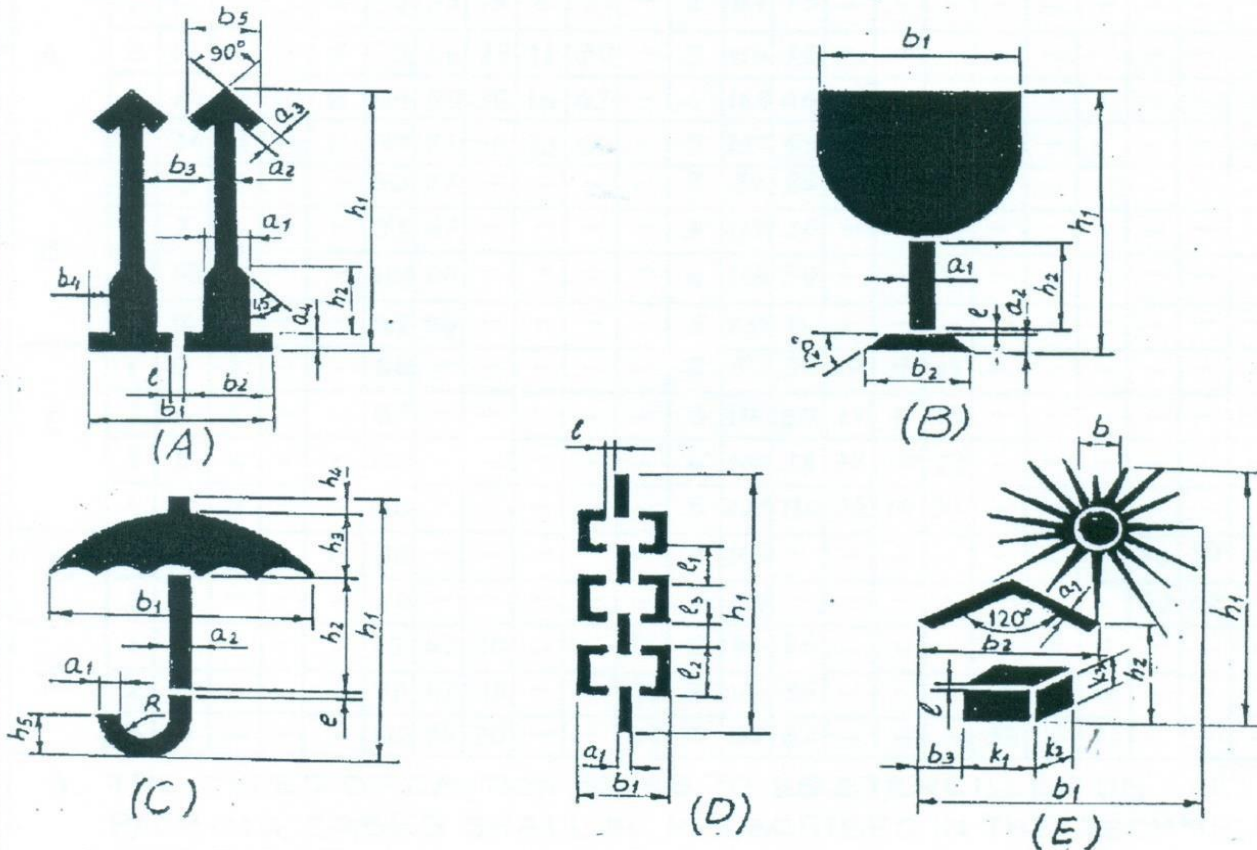

A. UPRIGHT

B. FRAGILE

C. PROTECTION FROM FALLING OR CONDENSING MOISTURE.

D. SLINGING POSITION

E. PROTECTION FROM DIRECT RADIATIONS.

## CENTER OF GRAVITY



Figure 1 - Markings



# CORPORATE STANDARD

AA0490009

Rev. No. 02

PAGE 7 of 10

DESIGN- ATION	DIMENSIONS IN mm.																								
	a <sub>1</sub>	a <sub>2</sub>	a <sub>3</sub>	a <sub>4</sub>	b <sub>1</sub>	b <sub>2</sub>	b <sub>3</sub>	b <sub>4</sub>	b <sub>5</sub>	b	ℓ	h <sub>1</sub>	h <sub>2</sub>	h <sub>3</sub>	h <sub>4</sub>	h <sub>5</sub>	K <sub>1</sub>	K <sub>2</sub>	K <sub>3</sub>	ℓ <sub>1</sub>	ℓ <sub>2</sub>	ℓ <sub>3</sub>	R		
A	1	12	5	5	4	52	25	19	8	21	-	2	84	23	-	-	-	-	-	-	-	-	-	-	
	2	17	7	7	6	75	36	29	11	30	-	3	119	33	-	-	-	-	-	-	-	-	-	-	
	3	24	10	10	8	104	50	38	16	42	-	4	168	46	-	-	-	-	-	-	-	-	-	-	
	4	34	14	14	11	147	71	59	23	60	-	5	239	65	-	-	-	-	-	-	-	-	-	-	-
B	1	5	5	-	-	50	33	-	-	-	-	2	84	25	-	-	-	-	-	-	-	-	-	-	
	2	7	7	-	-	71	47	-	-	-	-	3	119	36	-	-	-	-	-	-	-	-	-	-	
	3	10	10	-	-	100	66	-	-	-	-	4	168	50	-	-	-	-	-	-	-	-	-	-	
	4	14	14	-	-	142	94	-	-	-	-	5	239	71	-	-	-	-	-	-	-	-	-	-	
C	1	4	3	-	-	66	-	-	-	-	-	2	80	39	19	5	11	-	-	-	-	-	-	6	
	2	6	4	-	-	85	-	-	-	-	-	3	114	55	27	7	16	-	-	-	-	-	-	9	
	3	8	6	-	-	120	-	-	-	-	-	4	160	78	38	10	22	-	-	-	-	-	-	12	
	4	11	9	-	-	170	-	-	-	-	-	5	227	110	54	14	31	-	-	-	-	-	-	17	
D	1	6	-	-	-	30	-	-	-	-	-	4	148	-	-	-	-	-	-	-	-	30	30	10	-
	2	9	-	-	-	42	-	-	-	-	-	5	209	-	-	-	-	-	-	-	-	42	42	14	-
E	1	3	-	-	-	69	47	10	-	-	16	2	91	26	-	-	-	17	8	11	-	-	-	-	
	2	4	-	-	-	98	67	15	-	-	23	3	128	33	-	-	-	24	11	16	-	-	-	-	
	3	6	-	-	-	138	94	20	-	-	32	4	182	62	-	-	-	34	16	22	-	-	-	-	

Black and Red Marking Ink to IS:1234 "Ink, Stencil, Oil Base, For Marking Porous Surfaces" or duplicating ink stencilling, oil base for marking porous surfaces.

All cases containing fragile items are to be stencilled with red marking and stencilling paint/ink

**"HANDLE WITH CARE", "FRAGILE DO NOT TURN OVER".**

Besides the caution signs the product information's shall be stencilled of letters with 13mm to 50mm height.

Incase of consignment consists of more than one package; each package shall carry its package no as given in shipping list. All caution signs shall be stencilled in higher quality full glossy out door finishing paint red in colour (AA56126). All other markings shall be carried out in black enamel (AA56126).

Caution signs & other markings shall be stencilled on both the end shooks & the side shooks. Caution sign (for slinging) shall be stencilled only on side shooks at the appropriate place.

Note: Incase the size of package is small for using the stencils, and then hand written letters/figures shall be allowed.

## 11 PROCEDURE FOR HANDLING OF COMPONENTS

The purpose of this procedure is to protect the quality of the components/equipment while handling in various stages of manufacturing packing & despatching.

- 1) Adequate care shall be taken in handling the material, and components to avoid damage during receipts, storage issue manufacture & despatch operations.
- 2) Appropriate material handling equipment like fork lifters, cranes etc. Shall be used where needed.
- 3) Lifting by crane and transportation by trolley of critical items and large components like rotors castings etc. Shall be done carefully.

- 4) For critical items, where specified, special handling fixtures shall be used for lifting.
- 5) Slings and shackles used for lifting the components/equipment shall be checked for fitness and suitability before use.
- 6) Slings used on machined surfaces shall be suitably padded. No slings shall be used on journal surfaces.
- 7) Precision machined components like blades, catches, rollers etc. Shall be lifted using suitable wooden pallets.

**8) HANDLING OF COMPONENTS ON RECEIPT/DESPATCH:**

Before loading/unloading a packing case from the carrier look for the following shipping instructions painted on the packing case.

- The markings showing the upright position.
  - The markings showing the sling position
  - Markings showing the fragile contents.
  - Other required markings as per Cl.No:10
- a) Appropriate cranes and slings should be used for different components/ cases. Slings should normally make an angle as minimum as possible (width wise) but in no case more than 15°.
  - b) Handling and lifting should be done without jerks or impacts.
  - c) Immediately after receipt of the goods, the packing should be examined all-round for any sign of damage. If necessary, lift the cover or a number of boards of the case so as to make the contents visible. In the event of sealed packing being used the plastic sheeting should not be damaged. It is imperative that the packing material is restored in original condition after the inspection.
  - d) On receipt of the equipment it should be checked with the shipping list and missing or damage if any should be reported immediately. It is important to arrange for immediate examination to determine the extent of the damage, the cause of the damage and where applicable the person or persons responsible for the damage. According to general practice when transporting by railway or by road vehicle the carrier concerned should be immediately called upon (within specified periods) for jointly establishing a statement of the damage. This is essential as a basis for a subsequent claim and possible damage report to the insurance company.
  - e) Protective coating applied on machined surfaces should not be disturbed. The plastic covering should be put back carefully so that it prevents ingress of dust and moisture. Some packing may have vapour phase inhibitor (VPI) paper enclosed inside the packing cases. This should be restored to its original place as far as possible.
  - f) Silica gel and such other chemicals kept in the box as desiccants and indicators should also be left in the box itself.

**12 Treatment of Wood & Application and use of the mark**

For seaworthy export packing, treatment of wood has to be carried out as below subject to BHEL Engg & QC approval.

As per customer requirement for export packing, wood to be treated as applicable should be done as per International Standards for Phytosanitary Measures ISPM: 15 to control the growth stages viz. egg to adult of structural insects (beetles, borers, bugs, fleas, flies, lice, moths, roaches, termites) and other pests (mice, rats, spiders) etc. in stored products.

The specified marks applied to wood packaging material treated in accordance with ISPM 15 must conform to the requirements described in Annex 2 of ISPM 15.

**12.1 Heat treatment using a conventional steam or dry kiln heat chamber (treatment code for the mark: HT)**

When using conventional heat chamber technology, the fundamental requirement is to achieve a minimum temperature of 56 °C for a minimum duration of 30 continuous minutes throughout the entire profile of the wood (including its core).



## CORPORATE STANDARD

AA0490009

Rev. No. 02

PAGE 9 of 10

This temperature can be measured by inserting temperature sensors in the core of the wood. Alternatively, when using kiln-drying heat chambers or other heat treatment chambers, treatment schedules may be developed based on a series of test treatments during which the core temperature of the wood at various locations inside the heat chamber has been measured and correlated with chamber air temperature, taking into account the moisture content of the wood and other substantial parameters (such as species and thickness of the wood, air flow rate and humidity). The test series must demonstrate that a minimum temperature of 56 °C is maintained for a minimum duration of 30 continuous minutes throughout the entire profile of the wood.

Treatment schedules should be specified or approved by the National Plant Protection Organisation (NPPO). Treatment providers should be approved by the NPPO.

### 12.2 Heat treatment using dielectric heating (treatment code for the mark: DH)

Where dielectric heating is used (e.g. microwave), wood packaging material composed of wood not exceeding 20 cm when measured across the smallest dimension of the piece or the stack must be heated to achieve a minimum temperature of 60 °C for 1 continuous minute throughout the entire profile of the wood (including its surface). The prescribed temperature must be reached within 30 minutes from the start of the treatment.

Treatment schedules should be specified or approved by the NPPO.

### 12.3 Methyl bromide treatment (treatment code for the mark: MB)

Wood packaging material containing a piece of wood exceeding 20 cm in cross-section at its smallest dimension must not be treated with methyl bromide.

The fumigation of wood packaging material with methyl bromide must be in accordance with a schedule specified or approved by the NPPO (National Plant Protection Organisation) that achieves the minimum concentration-time product (CT) over 24 hours at the temperature and final residual concentration specified in Table 1. This CT must be achieved throughout the profile of the wood, including its core, although the concentrations would be measured in the ambient atmosphere. The minimum temperature of the wood and its surrounding atmosphere must not be less than 10 °C and the minimum exposure time must not be less than 24 hours. Monitoring of gas concentrations must be carried out at a minimum at 2, 4 and 24 hours from the beginning of the treatment. In the case of longer exposure times and weaker concentrations, additional measurement of the gas concentrations should be recorded at the end of fumigation.

If the CT is not achieved over 24 hours, corrective action needs to be taken to ensure the CT is reached; for example, the treatment is restarted or the treatment time extended for a maximum of 2 hours without adding more methyl bromide to achieve the required CT (see the footnote to Table 2).

**Table 1 – Minimum CT over 24 hours for wood packaging material fumigated with methyl bromide**

Temperature (°C)	CT (g·h/m <sup>3</sup> ) over 24 h	Minimum final concentration (g/m <sup>3</sup> ) after 24 h#
21.0 or above	650	24
16.0 – 20.9	800	28
10.0 – 15.9	900	32

# In circumstances when the minimum final concentration is not achieved after 24 hours, a deviation in the concentration of ~5% is permitted provided additional treatment time is added to the end of the treatment to achieve the prescribed CT.

One example of a schedule that may be used for achieving the specified requirements is shown in Table 3.

**Table 2 – Example of a treatment schedule that achieves the minimum required CT for wood packaging material treated with methyl bromide (initial doses may need to be higher in conditions of high sorption or leakage)**

Temperature (°C)	Dosage (g/m <sup>3</sup> )	Minimum concentration (g/m <sup>3</sup> ) at:		
		2 h	4 h	24 h
21.0 or above	48	36	31	24
16.0 – 20.9	56	42	36	28
10.0 – 15.9	64	48	42	32

Treatment providers should be approved by the NPPO.

#### 12.4 Marking

The specified marks applied to wood packaging material treated in accordance with ISPM 15 must conform to the requirements described in ISPM 15.

#### 13 PROVISION FOR INSPECTION:

This clause is applicable only where contractual requirement of customer is there. For other packings this is not applicable.

Each transportable packing's shall have provision for inspection by customer authority etc. during transport from origin of dispatched until destination. This inspection may require opening of the package and subsequently closing it again. For this purpose, suitable designed opening with bolted cover shall be provided. Such an opening shall be clearly marked as "OPENING" with clear instruction for opening & closing written on this cover. For large consignment, the size of the opening shall be suitable to facilitate entry of personnel.

#### 14 REFERRED STANDARDS (Latest publications including amendments):

- |            |             |             |             |
|------------|-------------|-------------|-------------|
| 1) AA51401 | 2) IS:303   | 3) IS:710   | 4) AA10166  |
| 5) ISPM:15 | 6) AA51420  | 7) AA51423  | 8) 55619    |
| 9) AA51406 | 10) AA51416 | 11) AA51426 | 12) AA56126 |

**ANNEXURE-II: DEVIATION SHEET (COST OF WITHDRAWAL)**



**Item: Monocrystalline DCR PV Module**

**Tender Ref: SPKSCP074**

**NAME OF VENDOR:-**

SL NO	VOULME/ SECTION	PAGE NO.	CLAUSE NO.	TECHNICAL SPECIFICATION/ TENDER DOCUMENT	COMPLETE DESCRIPTION OF DEVIATION	COST OF WITHDRAWL OF DEVIATION	PORTION OF PRICE SCHEDULE ON WHICH COST OF WITHDRAWL OF DEVIATION IS APPLICABLE	NATURE OF COST OF WITHDRAWL OF DEVIATION (POSITIVE/ NEGATIVE)	REASON FOR QUOTING DEVIATION	REMARKS
-------	-----------------	----------	------------	--	-----------------------------------	--------------------------------	---	---	------------------------------	---------

**TECHNICAL DEVIATIONS**

**COMMERCIAL DEVIATIONS**

**PARTICULARS OF BIDDERS/ AUTHORISED REPRESENTATIVE**

NAME	DESIGNATIONS	SIGN & DATE

**NOTES:**

- For self manufactured items of bidder, cost of withdrawl of deviation will be applicable on the basic price (i.e. excluding taxes, duties & freight) only.
- For directly dispatchable items, cost of withdrawl of deviation will be applicable on the FOR site price including taxes, duties & freight.
- All the bidders have to list out all their Technical & Commercial Deviations in detail in the above format only on cost basis (if any). Cost of withdrawal for the deviations, for which, the "Cost of withdrawal" is not specified, shall be taken as NIL.
- Any deviation not mentioned above and shown separately will not be taken cognizance of.
- Bidder shall submit duly filled unpriced copy of above format indicating "quoted" in "cost of withdrawl of deviation" column of the schedule above along with their Techno-commercial offer, wherever applicable.
- Bidder shall furnish price copy of above format along with price bid.
- The final decision of acceptance/ rejection of the deviations quoted by the bidder shall be at discretion of the Purchaser.
- Bidders to note that any deviation (technical/commercial) not listed in above and asked after Part-I opening shall not be considered.
- For deviations w.r.t. Payment terms, Liquidated damages, Firm prices and submission of E1/ E2 forms before claiming 10% payment, if a bidder chooses not to give any cost of withdrawl of deviation loading as per Annexure-VIII of GCC, Rev-06 will apply. For any other deviation mentioned in un-priced copy of this format submitted with Part-I bid but not mentioned in priced copy of this format submitted with Priced bid, the cost of withdrawl of deviation shall be taken as NIL.
- Any deviation mentioned in priced copy of this format, but not mentioned in the un-priced copy, shall not at all be accepted.
- All techno-commercial terms and conditions of NIT shall be deemed to have been accepted by the bidder, other than those listed in unpriced copy of this format.
- Cost of withdrawl is to be given seperately for each deviation. In no event, bidder should club cost of withdrawl of more than one deviation else cost of withdrawl of each deviation which have been clubbed together shall be considered as NIL.
- In case nature of cost of withdrawl (positive/negative) is not specified, it shall be assumed as positive.
- In case of discrepancy in the nature of impact (positive/negative), positive will be considered for evaluation and negative for ordering.

## Declaration Under Cartel Formation

### **RFQ NO:SPKSCPV073: SUPPLY OF Monocrystalline DCR PV Module**

I \_\_\_\_\_, authorized representative of M/s \_\_\_\_\_(bidder to enter company name)hereby declares that the company will not enter into any illegal or undisclosed agreement or understanding, whether formal or informal with other Bidder(s). This applies in particular to prices, specifications, certifications, subsidiary contracts, submission or non-submission of bids or any other actions to restrict competitiveness or to introduce cartelization in the bidding process. In case, the company is found having indulged in above activities, suitable action can be taken by BHEL as per extant policies/ guidelines.

Authorized signatory with date

 	<b>SOLAR BUSINESS DIVISION (SBD)</b>	<b>FINANCIAL PRE-QUALIFICATION REQUIREMENT (PQR)</b>
---	--------------------------------------	--

FINANCIAL PRE-QUALIFICATION REQUIREMENT			
TENDER REFERENCE NO.: SPKSCPV074			
TENDER DESCRIPTION: Supply of " Monocrystalline DCR PV Module"			
FINANCIAL PQR:			
<b>For Registration:</b> <b>1. Indian Bidder:</b> Should have GST registration (Copy of same to be submitted) <b>2. Foreign Bidder :</b> Should have <b>Export Licence</b> (Copy of same to be submitted)			
<b>For qualification, bidder should have average minimum Annual Turnover as per following details:</b>			
Sr. No.	Details of requirement	Turnover FY	Turnover Value (currency)
1.	<b>AVERAGE ANNUAL TURNOVER DURING THE LAST THREE FINANCIAL YEARS (2019-20, 2018-19, 2017-18) (QUALIFYING VALUE : Rs. 6.3 Crores )</b>	1. 2019-20	
		2. 2018-19	
		3. 2017-18	
		<b>Average of 3 years</b> <b>= <math>\frac{(1) + (2) + (3)}{3}</math></b>	
Supporting documents like <b>Financial standing through latest ITCC</b> , Annual Report (Audited Balance Sheet and Profit & Loss Account) of past three years to be submitted by vendors.			

- MINIMUM AVERAGE ANNUAL FINANCIAL TURNOVER OF THE BIDDER, DURING LAST 3 (THREE) YEARS, ENDING ON 31-03-2020 SHOULD BE **Rs. 6.3 Crores. (Rupees Six Crores and Thirty Lakhs Only)**
- AUDITED BALANCE SHEET AND PROFIT & LOSS ACCOUNT FOR LAST 3 (THREE) YEARS, ENDING ON 31-03-2020 NEED TO BE SUBMITTED IN SUPPORT OF ABOVE REQUIREMENT.
- FINANCIAL PRE-QUALIFICATION OF THE FOREIGN BIDDER (OTHER THAN INDIAN BIDDERS) MAY ALSO BE EVALUATED ON THE BASIS OF THE REPORT FROM A REPUTED THIRD PARTY BUSINESS RATING AGENCY LIKE DUN & BRADSTREET, CREDIT REFORM ETC.
- THE EVALUATION OF FOREIGN BIDDER, **EXCHANGE RATE (TT SELLING RATE OF SBI)** AS ON SCHEDULED DATE OF THE TENDER OPENING (PART-1 BID IN CASE OF TWO PART BID) SHALL BE CONSIDERED.
- ALL FOREIGN LANGUAGE DOCUMENTS SHALL BE **TRANSLATED TO ENGLISH** LANGUAGE EITHER BY A **CERTIFIED AGENCY** OR TRANSLATED VERIFICATION BY A VALID AUTHORIZED AGENCY.
- IN CASE AUDITED FINANCIAL STATEMENTS HAVE NOT BEEN SUBMITTED FOR ALL THE THREE YEARS AS INDICATED ABOVE, **THEN THE APPLICABLE AUDITED STATEMENTS SUBMITTED BY THE BIDDERS AGAINST THE REQUISITE THREE YEAR, WILL BE AVERAGED FOR THREE YEARS.**
- IF FINANCIAL STATEMENTS ARE NOT REQUIRED TO BE AUDITED STATUTORILY, THEN INSTEAD OF AUDITED FINANCIAL STATEMENTS, FINANCIAL STATEMENTS ARE REQUIRED TO BE CERTIFIED BY CHARTERED ACCOUNTANT OR EQUIVALENT.
- BHEL RESERVES THE RIGHT FOR INDEPENDENT VERIFICATION OF THE CLAIMS MADE FOR CONFORMANCE TO THE PRE-QUALIFICATION CRITERION. BIDDERS TO ENSURE PROVIDING AUTHENTIC CERTIFICATES / DOCUMENTATION AND CREDENTIALS IN ORDER TO QUALIFY FOR BHEL TENDER PROCESS.

\_\_\_\_\_ Seal and signature of the Bidder

# Guidelines for Reverse Auction – 2021

Doc. No. AA:SSP:RA:05  
Dated: 08.03.2021

## 1.0 Scope

This document describes the guidelines to be followed by BHEL for conducting Reverse Auction (RA) for procurement of material/ works/ services. The RA shall follow the philosophy of English Reverse (No ties).

English Reverse (No ties) is a type of auction where the starting price and bid decrement are announced before start of online reverse auction. The interested bidders can thereupon start bidding in an iterative process wherein the lowest bidder at any given moment can be displaced by an even lower bid of a competing bidder, within a given time frame. The bidding is with reference to the current lowest bid in the reverse auction. All bidders will see the current lowest quoted price and their rank. The term 'No ties' is used since more than one bidder cannot give an identical price, at a given instant, during the reverse auction. In other words, there shall never be a tie in the bids.

## 3.0 Upfront declaration in NIT

Decision to go for RA would be taken before floating of the tender. In case it is decided to go for RA, same shall be declared upfront in NIT by inserting the following **clause**:

*"BHEL shall be resorting to Reverse Auction (RA) (Guidelines as available on [www.bhel.com](http://www.bhel.com)) for this tender. RA shall be conducted among the techno-commercially qualified bidders.*

*Price bids of all techno-commercially qualified bidders shall be opened and same shall be considered for RA. In case any bidder(s) do(es) not participate in online Reverse Auction, their sealed envelope price bid along with applicable loading, if any, shall be considered for ranking."*

## 6.0 Business rules for RA

Model Annexure-I is attached.

## 7.0 Role of Service Provider

- Acknowledge the receipt of mandate from BHEL.
- Contact the bidders, provide business rules and train them, as required.
- Get the process compliance form signed by all the participating bidders before RA event.

# Guidelines for Reverse Auction – 2021

Doc. No. AA:SSP:RA:05  
Dated: 08.03.2021

- Conduct the event as per the contract and business rules.
- Submit the Login Reports, Results, History sheet and authorized final bid from the bidders.
- To obtain price breakup from successful bidder and submit the same to BHEL.

## 10.0 Reverse Auction Process

10.1 Reverse Auction will be conducted if two or more bidders are techno-commercially qualified. In case of two or three qualified bidders, there shall be no elimination of H1 bidder (whose quote is highest in sealed envelope price bid). In case of four qualified bidders, the H1 bidder shall be eliminated whereas in case of five qualified bidders, H1 & H2 bidders shall be eliminated. However, in case of six or more qualified bidders are available, RA would be conducted amongst first 50% of the bidders arranged in the order of prices from lowest to highest. Number of bidders eligible for participating in RA would be rounded off to next higher integer value if number of qualified bidders is odd (e.g. if 7 bids are qualified, then RA will be conducted amongst lowest four bidders). However, there will be no elimination of qualified bidders who are MSE or qualifying under PPP-MII, Order 2017, irrespective of the number of bidders qualifying techno-commercially.

In case of multiple H1 bidders, all H1 bidders (excluding MSEs and bidders qualifying under PPP-MII, Order 2017) shall be removed provided minimum two bidders remain in fray, else no H1 removal.

10.2 During RA, all bidders will see their rank and current L1 price on the screen. Once the RA is done, the ranking status would be based on the last quoted price of the bidder(s) irrespective of the quote received in RA or sealed envelope price bid.

10.3 No bidder shall be allowed to lower its bid below the current L1 by more than 5 decrements at one go.

## 11.0 Processing of case after RA

11.2 In case of splitting requirement, bidders who were removed from participation in RA may also be considered for counter offer if the pre-stated (NIT) numbers of suppliers do not accept the counter offer.

## Guidelines for Reverse Auction – 2021

Doc. No. AA:SSP:RA:05  
Dated: 08.03.2021

---

### 13.0 Others

- 13.2 In case of enquiry through e-Procurement, the sealed electronic price bid (e-bid) is to be treated as sealed envelope price bid.
- 13.3 BHEL will inform bidders the details of service provider who will provide business rules, all necessary training and assistance before commencement of online bidding.
- 13.4 Bidders will be advised to read the 'Business Rules' indicating details of RA event carefully, before reverse auction event.

---XXX---

ABRIDGED VERSION

# Guidelines for Reverse Auction – 2021

Doc. No. AA:SSP:RA:05  
Dated: 08.03.2021

## Business Rules for Reverse Auction

### Annexure – I

This has reference to tender no **{tender number....date...}**. BHEL shall finalise the Rates for the supply of *{item name}* through Reverse Auction mode. BHEL has made arrangement with M/s. *{Service provider}*, who shall be BHEL's authorized service provider for the same. Bidders should go through the instructions given below and submit acceptance of the same.

The technical & commercial terms are as per (a) BHEL Tender Enq. No. {...} dated {...}, (b) Bidders' technical & commercial bid (in case of two part bid) and (c) subsequent correspondences between BHEL and the bidders, if any.

#### 1. Procedure of Reverse Auctioning

- i. Price bids of all techno-commercially qualified bidders shall be opened.
- ii. **Reverse Auction:** The 'bid decrement' will be decided by BHEL.
- iv. Bidders by offering a minimum bid decrement or the multiples thereof can displace a standing lowest bid and become "L1" and this continues as an iterative process. However, no bidder shall be allowed to lower its bid below the current L1 by more than 5 decrements at one go.
- v. After the completion of the reverse auction, the Closing Price shall be available for further processing.
- vi. Wherever the evaluation is done on total cost basis, after Reverse Auction, prices of individual line items shall be reduced on pro-rata basis.

**2. Schedule for reverse auction:** The Reverse Auction is tentatively scheduled on *{date}*: *{start time}*: *{Close Time}*: *}*.

**3. Auction extension time:** If a bidder places a bid in the last {...} minutes of closing of the Reverse Auction and if that bid gets accepted, then the auction's duration shall get extended automatically for another {...} minutes, for the entire auction (i.e. for all the items in the auction), from the time that bid comes in. Please note that the auto-extension will take place only if a bid comes in those last {...} minutes and if that bid gets accepted as the lowest bid. If the bid does not get accepted as the lowest bid, the auto-extension will not take place even if that bid might have come in the last {...}

# Guidelines for Reverse Auction – 2021

Doc. No. AA:SSP:RA:05

Dated: 08.03.2021

## Business Rules for Reverse Auction

### Annexure – I

minutes. In case, there is no bid in the last {...} minutes of closing of Reverse Auction, the auction shall get closed automatically without any extension. However, bidders are advised not to wait till the last minute or last few seconds to enter their bid during the auto-extension period to avoid complications related with internet connectivity, network problems, system crash down, power failure, etc.

The above process will continue till completion of Reverse Auction.

Complaints/ Grievances, if any, regarding denial of service or any related issue should be given in writing thru e-mail/ fax to M/s. {Service provider} with a copy to BHEL within 15 minutes prior to initial closing time of Reverse Auction.

4. **Bid price:** The Bidder has to quote the {...} Price inclusive of Packing & Forwarding charges, all the routine & type tests as per tender scope, taxes, duties, freight and insurance as specified in tender document, including loading (if indicated by BHEL due to deviations in technical/ commercial terms) for the Items specified. Details are as shown in Excel Sheet for calculation of total cost to BHEL (To be specified by Unit as per NIT conditions).
5. **Bidding currency and unit of measurement:** Bidding will be conducted in *Indian Rupees per Unit* of the material as per the specifications {...}  
  
In case of foreign currency bids, exchange rate (TT selling rate of State Bank of India) as on scheduled date of tender opening (Part-I bid) shall be considered for conversion in Indian Rupees. If the relevant day happens to be a Bank holiday, then the forex rate as on the previous bank (SBI) working day shall be taken.
6. **Validity of bids:** Price shall be valid for {... days} from the date of reverse auction. These shall not be subjected to any change whatsoever.
7. **Lowest bid of a bidder:** In case the bidder submits more than one bid, the lowest bid at the end of Reverse Auction will be considered as the bidder's final offer to execute the work.
8. Unique user IDs shall be used by bidders during bidding process. All bids

# Guidelines for Reverse Auction – 2021

Doc. No. AA:SSP:RA:05

Dated: 08.03.2021

## Business Rules for Reverse Auction

### Annexure – I

---

made from the Login ID given to the bidders will be deemed to have been made by the bidders/ bidders' company.

- 9. Post auction procedure:** BHEL will proceed with the Lowest Bid in the Reverse Auction for further processing.
- 11.** Reverse auction shall be conducted by BHEL (through M/s {Service Provider}), on pre-specified date, while the bidders shall be quoting from their own offices/ place of their choice. Internet connectivity shall have to be ensured by bidders themselves.

During the RA process if a bidder is not able to bid and requests for extension of time by FAX/ email/ phone then time extension of additional 15 minutes will be given by the service provider provided such requests come before 5 minutes of auction closing time. However, only one such request per bidder can be entertained.

In order to ward-off contingent situation of connectivity failure bidders are requested to make all the necessary arrangements/ alternatives whatever required so that they are able to circumvent such situation and still be able to participate in the reverse auction successfully. Failure of power or loss of connectivity at the premises of bidders during the Reverse auction cannot be the cause for not participating in the reverse auction. On account of this, the time for the auction cannot be extended and neither BHEL nor M/s. {Service provider} is responsible for such eventualities.

- 12.** Proxy bids: Proxy bidding feature is a pro-bidder feature to safe guard the bidder's interest of any internet failure or to avoid last minute rush. The proxy feature allows bidders to place an automated bid in the system directly in an auction and bid without having to enter a new amount each time a competing bidder submits a new offer. The bid amount that a bidder enters is the minimum that the bidder is willing to offer. Here the software bids on behalf of the bidder. This obviates the need for the bidder participating in the bidding process until the proxy bid amount is decrementally reached by other bidders. When proxy bid amount is reached, the bidder (who has submitted the proxy bid) has an option to start participating in the bidding process.

The proxy amount is the minimum amount that the bidder is willing to offer.

---

# Guidelines for Reverse Auction – 2021

Doc. No. AA:SSP:RA:05

Dated: 08.03.2021

## Business Rules for Reverse Auction

### Annexure – I

---

During the course of bidding, the bidder cannot delete or change the amount of a proxy bid.

Bids are submitted in decrements (decreasing bid amounts). The application automates proxy bidding by processing proxy bids automatically, according to the decrement that the auction originator originally established when creating the auction, submitting offers to the next bid decrement each time a competing bidder bids, regardless of the fact whether the competing bids are submitted as proxy or standard bids. However, it may please be noted that if a manual bid and proxy bid are submitted at the same instant manual bid will be recognized as the L1 at that instant.

In case of more than one proxy bid, the system shall bid till it crosses the threshold value of 'each lowest proxy bid' and thereafter allow the competition to decide the final L1 price.

Proxy bids are fed into the system directly by the respective bidders. As such this information is privy only to the respective bidder(s).

13. Bidders are advised to get fully trained and clear all their doubts such as refreshing of Screen, quantity being auctioned, tender value being auctioned etc from M/s {Service provider}.
14. M/s. {Service provider}, shall arrange to demonstrate/ train the bidder or bidder's nominated person(s), without any cost to bidders. M/s. {Service provider}, shall also explain the bidders, all the business rules related to the Reverse Auction. Bidders are required to submit their acceptance to the terms/ conditions/ modalities before participating in the Reverse Auction in the process compliance form as enclosed. Without this, the bidder will not be eligible to participate in the event.
15. Successful bidder shall be required to submit the final prices (L1) in prescribed format (Annexure – VI) for price breakup, quoted during the Reverse Auction, duly signed and stamped as token of acceptance without any new condition (other than those already agreed to before start of auction), after the completion of auction to M/s. {Service provider} besides BHEL within two working days of Auction without fail.
16. Any variation between the final bid value and that in the confirmatory

# Guidelines for Reverse Auction – 2021

Doc. No. AA:SSP:RA:05  
Dated: 08.03.2021

## Business Rules for Reverse Auction

### Annexure – I

---

signed price breakup document will be considered as tampering the tender process and will invite action by BHEL as per extant guidelines for suspension of business dealings (as available on [www.bhel.com](http://www.bhel.com)).

17. Bidders' bid will be taken as an offer to execute the work/ supplies the item as per enquiry no. {...} dt. {...}. Bids once made by the bidder, cannot be cancelled/ withdrawn and bidder shall be bound to execute the work as mentioned above at bidder's final bid price. Should bidder back out and not execute the contract as per the rates quoted, BHEL shall take action as per extant guidelines for suspension of business dealings (as available on [www.bhel.com](http://www.bhel.com)).
18. Bidders shall be able to view the following on their screen along with the necessary fields during Reverse Auction:
  - a. Leading (Running Lowest) Bid in the Auction (only total price of package)
  - b. Bid Placed by the bidder
  - c. Start Price
  - d. Decrement value
  - e. Rank of their own bid during bidding as well as at the close of auction.
19. BHEL's decision on award of contract shall be final and binding on all the Bidders.
20. BHEL reserves the right to extend, reschedule or cancel the Reverse Auction process at any time, before ordering, without assigning any reason, with intimation to bidders.
21. BHEL shall not have any liability to bidders for any interruption or delay in access to the site irrespective of the cause. In such cases, the decision of BHEL shall be binding on the bidders.
22. Other terms and conditions shall be as per bidder's techno-commercial offers and other correspondences, if any, till date.
23. If there is any clash between this business document and the FAQ available, if any, in the website of M/s. {*Service provider*}, the terms & conditions given in this business document will supersede the information contained in the FAQs. Any changes made by BHEL/ service provider (due to unforeseen

## Guidelines for Reverse Auction – 2021

Doc. No. AA:SSP:RA:05  
Dated: 08.03.2021

### Business Rules for Reverse Auction

### Annexure – I

---

contingencies) after the first posting shall be deemed to have been accepted if the bidder continues to access the portal after that time.

- 24.** Bidder shall not divulge either his Bids or any other exclusive details of BHEL to any other party. If the Bidder or any of his representatives are found to be involved in Price manipulation/ cartel formation of any kind, directly or indirectly by communicating with other bidders, action as per extant BHEL guidelines for suspension of business dealings (as available on [www.bhel.com](http://www.bhel.com)), shall be initiated by BHEL.

ABRIDGED VERSION

## INTEGRITY PACT

### Between

Bharat Heavy Electricals Ltd. (BHEL), a company registered under the Companies Act 1956 and having its registered office at "BHEL House", Siri Fort, New Delhi - 110049 (India) hereinafter referred to as "The Principal", which expression unless repugnant to the context or meaning hereof shall include its successors or assigns of the ONE PART

### and

\_\_\_\_\_, (description of the party along with address), hereinafter referred to as "The Bidder/ Contractor" which expression unless repugnant to the context or meaning hereof shall include its successors or assigns of the OTHER PART

### Preamble

The Principal intends to award, under laid-down organizational procedures, contract/s for

\_\_\_\_\_  
\_\_\_\_\_  
\_\_\_\_\_. The Principal values full compliance with all relevant laws of the land, rules and regulations, and the principles of economic use of resources, and of fairness and transparency in its relations with its Bidder(s)/ Contractor(s).

In order to achieve these goals, the Principal will appoint Independent External Monitor(s), who will monitor the tender process and the execution of the contract for compliance with the principles mentioned above.

### **Section 1- Commitments of the Principal**

1.1 The Principal commits itself to take all measures necessary to prevent corruption and to observe the following principles:-

1.1.1 No employee of the Principal, personally or through family members, will in connection with the tender for, or the execution of a contract, demand, take a promise for or accept, for self or third person, any material or immaterial benefit which the person is not legally entitled to.

1.1.2 The Principal will, during the tender process treat all Bidder(s) with equity and reason. The Principal will in particular, before and during the tender process, provide to all Bidder(s) the same information and will not provide to any Bidder(s) confidential/ additional information through which the Bidder(s) could obtain an advantage in relation to the tender process or the contract execution.

1.1.3 The Principal will exclude from the process all known prejudiced persons.

1.2 If the Principal obtains information on the conduct of any of its employees which is a penal offence under the Indian Penal Code 1860 and Prevention of Corruption Act 1988 or any other statutory penal enactment, or if there be a substantive suspicion in this regard, the Principal will inform its Vigilance Office and in addition can initiate disciplinary actions:

## **Section 2 - Commitments of the Bidder(s)/ Contractor(s)**

- 2.1 The Bidder(s)/ Contractor(s) commit himself to take all measures necessary to prevent corruption. He commits himself to observe the following principles during his participation in the tender process and during the contract execution.
- 2.1.1 The Bidder(s)/ Contractor(s) will not, directly or through any other person or firm, offer, promise or give to the Principal or to any of the Principal's employees involved in the tender process or the execution of the contract or to any third person any material, immaterial or any other benefit which he/ she is not legally entitled to, in order to obtain in exchange any advantage of any kind whatsoever during the tender process or during the execution of the contract.
- 2.1.2 The Bidder(s)/ Contractor(s) will not enter with other Bidder(s) into any illegal or undisclosed agreement or understanding, whether formal or informal. This applies in particular to prices, specifications, certifications, subsidiary contracts, submission or non-submission of bids or any other actions to restrict competitiveness or to introduce cartelization in the bidding process.
- 2.1.3 The Bidder(s)/ Contractor(s) will not commit any penal offence under the relevant Indian Penal Code (IPC) and Prevention of Corruption Act; further the Bidder(s)/ Contractor(s) will not use improperly, for purposes of competition or personal gain, or pass on to others, any information or document provided by the Principal as part of the business relationship, regarding plans, technical proposals and business details, including information contained or transmitted electronically.
- 2.1.4 Foreign Bidder(s)/ Contractor(s) shall disclose the name and address of agents and representatives in India and Indian Bidder(s)/ Contractor(s) to disclose their foreign principals or associates. The Bidder(s)/ Contractor(s) will, when presenting his bid, disclose any and all payments he has made, and is committed to or intends to make to agents, brokers or any other intermediaries in connection with the award of the contract.
- 2.2 The Bidder(s)/ Contractor(s) will not instigate third persons to commit offences outlined above or be an accessory to such offences.
- 2.3 The Bidder(s)/ Contractor(s) shall not approach the Courts while representing the matters to IEMs and will await their decision in the matter.

## **Section 3 - Disqualification from tender process and exclusion from future contracts**

If the Bidder(s)/ Contractor(s), before award or during execution has committed a transgression through a violation of Section 2 above, or acts in any other manner such as to put his reliability or credibility in question, the Principal is entitled to disqualify the Bidder(s)/ Contractor(s) from the tender process or take action as per the separate "Guidelines on Banning of Business dealings with Suppliers/ Contractors", framed by the Principal.

## **Section 4 - Compensation for Damages**

- 4.1 If the Principal has disqualified the Bidder from the tender process prior to the award according to Section 3, the Principal is entitled to demand and recover the damages equivalent Earnest Money Deposit/ Bid Security.
- 4.2 If the Principal has terminated the contract according to Section 3, or if the Principal is entitled to terminate the contract according to section 3, the Principal shall be entitled to

demand and recover from the Contractor liquidated damages equivalent to 5% of the contract value or the amount equivalent to Security Deposit/ Performance Bank Guarantee, whichever is higher.

### **Section 5 - Previous Transgression**

- 5.1 The Bidder declares that no previous transgressions occurred in the last 3 years with any other company in any country conforming to the anti-corruption approach or with any other Public Sector Enterprise in India that could justify his exclusion from the tender process.
- 5.2 If the Bidder makes incorrect statement on this subject, he can be disqualified from the tender process or the contract, if already awarded, can be terminated for such reason.

### **Section 6 - Equal treatment of all Bidders/ Contractors / Sub-contractors**

- 6.1 The Principal will enter into agreements with identical conditions as this one with all Bidders and Contractors. In case of sub-contracting, the Principal contractor shall be responsible for the adoption of IP by his sub-contractors and shall continue to remain responsible for any default by his sub-contractors.
- 6.2 The Principal will disqualify from the tender process all bidders who do not sign this pact or violate its provisions.

### **Section 7 - Criminal Charges against violating Bidders/ Contractors /Subcontractors**

If the Principal obtains knowledge of conduct of a Bidder, Contractor or Subcontractor, or of an employee or a representative or an associate of a Bidder, Contractor or Subcontractor which constitutes corruption, or if the Principal has substantive suspicion in this regard, the Principal will inform the Vigilance Office.

### **Section 8 - Independent External Monitor(s)**

- 8.1 The Principal appoints competent and credible Independent External Monitor for this Pact. The task of the Monitor is to review independently and objectively, whether and to what extent the parties comply with the obligations under this agreement.
- 8.2 The Monitor is not subject to instructions by the representatives of the parties and performs his functions neutrally and independently. He reports to the CMD, BHEL.
- 8.3 The Bidder(s)/ Contractor(s) accepts that the Monitor has the right to access without restriction to all contract documentation of the Principal including that provided by the Bidder(s)/ Contractor(s). The Bidder(s)/ Contractor(s) will grant the monitor, upon his request and demonstration of a valid interest, unrestricted and unconditional access to his contract documentation. The same is applicable to Sub-contractor(s). The Monitor is under contractual obligation to treat the information and documents of the Bidder(s)/ Contractor(s) / Sub-contractor(s) with confidentiality in line with Non- disclosure agreement.
- 8.4 The Principal will provide to the Monitor sufficient information about all meetings among the parties related to the contract provided such meetings could have an impact on the contractual relations between the Principal and the Contractor. The parties offer to the Monitor the option to participate in such meetings.

- 8.5 The role of IEMs is advisory, would not be legally binding and it is restricted to resolving issues raised by an intending bidder regarding any aspect of the tender which allegedly restricts competition or bias towards some bidders. At the same time, it must be understood that IEMs are not consultants to the Management. Their role is independent in nature and the advice once tendered would not be subject to review at the request of the organization.
- 8.6 For ensuring the desired transparency and objectivity in dealing with the complaints arising out of any tendering process, the matter should be examined by the full panel of IEMs jointly as far as possible, who would look into the records, conduct an investigation, and submit their joint recommendations to the Management.
- 8.7 The IEMs would examine all complaints received by them and give their recommendations/ views to CMD, BHEL, at the earliest. They may also send their report directly to the CVO and the Commission, in case of suspicion of serious irregularities requiring legal/ administrative action. IEMs will tender their advice on the complaints within 10 days as far as possible.
- 8.8 The CMD, BHEL shall decide the compensation to be paid to the Monitor and its terms and conditions.
- 8.9 IEM should examine the process integrity, they are not expected to concern themselves with fixing of responsibility of officers. Complaints alleging mala fide on the part of any officer of the organization should be looked into by the CVO of the concerned organisation.
- 8.10 If the Monitor has reported to the CMD, BHEL, a substantiated suspicion of an offence under relevant Indian Penal Code/ Prevention of Corruption Act, and the CMD, BHEL has not, within reasonable time, taken visible action to proceed against such offence or reported it to the Vigilance Office, the Monitor may also transmit this information directly to the Central Vigilance Commissioner, Government of India.
- 8.11 The number of Independent External Monitor(s) shall be decided by the CMD, BHEL.
- 8.12 The word 'Monitor' would include both singular and plural.

### **Section 9 - Pact Duration**

- 9.1 This Pact shall be operative from the date IP is signed by both the parties till the final completion of contract for successful bidder and for all other bidders 6 months after the contract has been awarded. Issues like warranty / guarantee etc. should be outside the purview of IEMs.
- 9.2 If any claim is made/ lodged during currency of IP, the same shall be binding and continue to be valid despite the lapse of this pact as specified above, unless it is discharged/ determined by the CMD, BHEL.

### **Section 10 - Other Provisions**

- 10.1 This agreement is subject to Indian Laws and jurisdiction shall be registered office of the Principal, i.e. New Delhi.

- 10.2 Changes and supplements as well as termination notices need to be made in writing. Side agreements have not been made.
- 10.3 If the Contractor is a partnership or a consortium, this agreement must be signed by all partners or consortium members.
- 10.4 Should one or several provisions of this agreement turn out to be invalid, the remainder of this agreement remains valid. In this case, the parties will strive to come to an agreement to their original intentions.
- 10.5 Only those bidders / contractors who have entered into this agreement with the Principal would be competent to participate in the bidding. In other words, entering into this agreement would be a preliminary qualification.

-----

-----

For & On behalf of the Principal

For & On behalf of the Bidder/  
Contractor

(Office Seal) **HIMANSHU  
KUMAR  
NAIK**

Digitally signed by HIMANSHU KUMAR NAIK  
DN: c=IN, o=BHARAT HEAVY ELECTRICALS LTD,  
ou=EPD BLR, postalCode=560012,  
st=Karnataka,  
2.5.4.20=803b57f74da9ba15900fa60b2913485  
7894705f68ae3ad7ccc3004d795bd1bc,  
serialNumber=44068f540edd5306c0daae39660  
13b4bd9435dbalc0412cd2b337599eab88ae,  
cn=HIMANSHU KUMAR NAIK  
Date: 2021.03.22 18:45:12 +05'30'

(Office Seal)

Place-----

Date-----

Witness:\_\_\_\_\_

Witness:\_\_\_\_\_

(Name & Address) \_\_\_\_\_

(Name & Address) \_\_\_\_\_

**Manjunath  
Rao Katkar**

Digitally signed by Manjunath Rao  
Katkar  
DN: c=IN, o=BHARAT HEAVY  
ELECTRICALS LIMITED, ou=EPD,  
postalCode=560012, st=Karnataka,  
2.5.4.20=1b512fab70ebe00e43261cf  
0fbb1b7edfb600c7803ec45f87d48a4  
df57a81fe5, cn=Manjunath Rao  
Katkar  
Date: 2021.03.22 15:04:48 +05'30'

 <p>The logo features the BHEL logo on the left, a large '50' in the center, and a gear on the right. Text includes 'BHEL', 'Maharaja Company', and '50th Anniversary'.</p>	<p><b>ELECTROPORCELAINS DIVISION</b></p>	<p><b>GENERAL CONDITIONS OF CONTRACT (GCC)</b></p> <p><b>Revision No. R0 (For supply and services)</b></p> <p>Issued on 01.04.2017</p>
--	--	--

## **GENERAL CONDITIONS OF CONTRACTS (GCC)**

DEFINITIONS OF TERMS

ABBREVIATIONS

INSTRUCTIONS TO BIDDERS

GENERAL COMMERCIAL TERMS & CONDITIONS

ANNEXURES

**ELECTROPORCELAINS DIVISION  
BHARAT HEAVY ELECTRICALS LIMITED**  
(A Govt. of India Undertaking)  
PROF. CNR RAO CIRCLE, IISc POST  
MALLESHWARAM  
BANGALORE - 560012

	<p align="center"><b>ELECTRO-PORCELAINS DIVISION</b></p>	<p align="center"><b>GENERAL CONDITIONS OF CONTRACT (GCC)</b> <b>Revision No. R0</b> <b>(For supply and services)</b></p>	<p align="center"><b>DEFINITION OF TERMS</b></p>
---	--	---	--

Not for Publication

For Official Use

### DEFINITION OF TERMS

Throughout the Tender Documents including the Enquiry Letter, the following words shall have the meanings assigned to them herein, unless the subject matter or the context requires otherwise.

- 1 **Purchaser / BHEL** shall mean **M/s Bharat Heavy Electricals Limited** (A Govt. of India Undertaking) incorporated under the Companies Act 1956 acting through its **Electroporcelains Division (EPD)**, IISc Post, Prof. CNR Rao Circle, Malleswaram, Bangalore - 560012 (Karnataka) which expression shall include its successors and assigns.
- 2 **EXECUTIVE DIRECTOR**" or 'GROUP GENERAL MANAGER or "GENERAL MANAGER (In-charge)" or "GENERAL MANAGER" shall mean the Officer in Administrative charge of EPD, Bangalore.
- 3 **"COMPETENT AUTHORITY"** shall mean Executive Director or Group General Manager or General Manager (In -charge) or General Manager or BHEL Officers who are empowered to act on behalf of the Executive Director or General Manager (In-charge) or General Manager of BHEL.
- 4 **Owner** shall mean the **Customer or Client** for whose project the enquiry is issued by Purchaser and shall include its successors and assigns as well as authorized officer(s)/ representative(s).
- 5 **Consultant** shall mean the agency appointed by Owner or Purchaser to provide consultancy services for the project and shall include its successors and assigns as well as authorized officer(s)/ representative(s).
- 6 **Tenderer** shall mean the Firm/ Company/ Organization which quotes against the Tender Enquiry issued by Purchaser. It may also be referred as **Bidder or Vendor**.
- 7 **"CONTRACT"** or "CONTRACT DOCUMENT" shall mean and include the Agreement of Purchase order / Work Order, the accepted appendices of Rates, Schedules, Quantities if any, General Conditions of Contract, Special Conditions of Contract, Instructions to the Bidders, Drawings, Technical Specifications, the

	<p align="center"><b>ELECTRO- PORCELAINS DIVISION</b></p>	<p align="center"><b>GENERAL CONDITIONS OF CONTRACT (GCC)</b></p> <p align="center"><b>Revision No. R0 (For supply and services)</b></p>	<p align="center"><b>DEFINITION OF TERMS</b></p>
---	---	--	--

Special Specifications, if any, Integrity Pact (if applicable), the Tender documents, subsequent amendments mutually agreed upon and the Letter of Intent/Acceptance issued by BHEL. Any conditions or terms stipulated by the contractor in the tender documents or subsequent letters shall not form part of the contract unless, specifically accepted in writing by BHEL in the Letter of Intent/ Award and incorporated in the agreement.

- 8 Seller/Contractor** shall mean the Firm/ Company/ Organization with whom the Order/Contract is made and shall be deemed to include its successors, representatives, heirs, executors, administrators and permitted assigns, as the case may be. It may also be referred as **Supplier**.
- 9 Sub-Contractor** shall mean the person/ firm/ company/ organization to whom any part of the work has been sub-contracted by Seller/ Contractor, with the written consent of Purchaser, and shall include sub-contractor's heirs, executors, administrators, representatives and assigns.
- 10 "ENGINEER"** or "ENGINEER IN CHARGE" shall mean an Officer of BHEL as may be duly appointed and authorized by BHEL to act as "Engineer" on his behalf for the purpose of the Contract, to perform the duty set forth in this General Conditions of Contract and other Contract documents. The term also includes 'RESIDENT MANAGER1 or 'SITE INCHARGE1 as well as Officers at Site or at the Headquarters at Bangalore.
- 11 "GENERAL CONDITIONS OF CONTRACT"** shall mean the 'Instructions to Bidders1 and 'General Conditions of Contract pertaining to the work for which above tenders have been called for.
- 12 "TENDER SPECIFICATION"** or "TENDER" or "TENDER DOCUMENTS" shall mean General Conditions, Common Conditions, Special Conditions, Price Bid, Rate Schedule, Technical Specifications, Appendices, Annexure, Corrigenda, Amendments, Forms, procedures, Site information, etc and drawings/ documents pertaining to the work for which the bidders are required to submit their offers or any other document(s) as mentioned in NIT. Individual specification number will be assigned to each Tender Specification.
- 13 LETTER OF AWARD / INTENT"** shall mean the intimation by a Letter/Fax/email to the bidder that the tender has been accepted in accordance with provisions contained in the letter. The responsibility of the contractor

	<p align="center"><b>ELECTRO-PORCELAINS DIVISION</b></p>	<p align="center"><b>GENERAL CONDITIONS OF CONTRACT (GCC)</b> <b>Revision No. R0</b> <b>(For supply and services)</b></p>	<p align="center"><b>DEFINITION OF TERMS</b></p>
---	--	---	--

commences from the date of issue of this letter and all terms and conditions of the contract are applicable from this date

- 14 **COMPLETION TIME**" shall mean the period by 'date/month' specified in the 'Letter of Intent/Award' or date mutually agreed upon for handing over of the intended scope of work, the erected equipment/plant which are found acceptable by the Engineer, being of required standard and conforming to the specifications of the Contract.
- 15 **"PLANT"** shall mean and connote the entire assembly of the plant and equipments covered by the contract.
- 16 **"EQUIPMENT"** shall mean equipment, machineries, materials, structural, electrical and other components of the plant covered by the contract.
- 17 **"TESTS"** shall mean and include such test or tests to be carried out on the part of the contractor as are prescribed in the contract or considered necessary by BHEL, in order to ascertain the quality, workmanship, performance and efficiency of the contractor or part thereof.
- 18 **"APPROVED", "DIRECTED" or "INSTRUCTED"** shall mean approved, directed or instructed by BHEL.
- 19 **"WORK or CONTRACT WORK"** shall mean and include supply of all categories of labour, specified consumables, tools and tackles and Plants required for complete and satisfactory site transportation, handling, stacking, storing, erecting, testing and commissioning of the equipments to the entire satisfaction of BHEL.
- 20 **"HEADING"** - The heading in these General Conditions are solely for the purpose of facilitating reference and shall not be deemed to be part thereof or be taken as instructions thereof or of the contract.
- 21 **"WRITING"** shall include any manuscript type written or hand written or printed statement or electronically transmitted messages, under the signature or seal or transmittal of BHEL.

	<p align="center"><b>ELECTRO-PORCELAINS DIVISION</b></p>	<p align="center"><b>GENERAL CONDITIONS OF CONTRACT (GCC)</b> <b>Revision No. R0</b> <b>(For supply and services)</b></p>	<p align="center"><b>DEFINITION OF TERMS</b></p>
---	--	---	--

- 22** "TEMPORARY WORK" shall mean all temporary works for every kind required in or for the execution, completion, maintenance of the work.
- 23** 'CONTRACT PRICE or 'CONTRACT VALUE shall mean the sum mentioned in the LOI/LOA/Contract Agreement subject to such additions thereto or deductions there from as may be made under provisions hereinafter contained
- 24** "COMMENCEMENT DATE" or "START DATE" shall mean the commencement/start of work at Site as per terms defined in the Tender.
- 25** "SHORT CLOSING" or "FORE CLOSING" of Contract shall mean the premature closing of Contract, for reasons not attributable to the contractor and mutually agreed between BHEL and the contractor
- 26** "TERMINATION" of Contract shall mean the premature closing of contract due to reasons as mentioned in the contract.
- 27** "DE MOBILISATION" shall mean the temporary winding up of Site establishment by Contractor leading to suspension of works temporarily for reasons not attributable to the contractor
- 28** "RE MOBILISATION" shall mean the resumption of work with all resources required for the work after demobilization.
- 29** **Site** shall mean and include the land and place on which the power station and related facilities are to be constructed and any adjacent land which may be allocated or used by Owner or Seller/ Contractor in performance of the Order/ Contract.
- 30** **Tests on completion** shall mean such tests as prescribed in specifications and/ or tests mutually agreed upon by Purchaser and Seller/ Contractor, to be performed by Seller/ Contractor after erection of equipment to establish its satisfactory operation as per specifications.
- 31** "COMMISSIONING" shall mean the synchronization testing and achieving functional operation of the Equipment with associated system after all initial adjustments, trials, cleaning, re-assembly required at site if any, have been

	<p style="text-align: center;"><b>ELECTRO-PORCELAINS DIVISION</b></p>	<p style="text-align: center;"><b>GENERAL CONDITIONS OF CONTRACT (GCC)</b> <b>Revision No. R0</b> <b>(For supply and services)</b></p>	<p style="text-align: center;"><b>DEFINITION OF TERMS</b></p>
---	---	--	---

completed and Equipment with associated system is ready for taking into service.

- 32 Initial Operation or Trial Operation or Reliability Run** shall mean continuous integrated operation of the contracted/ ordered plant and materials under varying loads as proof of satisfactory operation for a specified period.
- 33 Inspection Agency (IA)** shall mean person(s) authorized by Purchaser / Owner to inspect the stores as per Order/ Contract at Contractor's/ Sub-Contractor's works. Vendors to raise inspection call on BHEL EPD.
- 34 Month** shall mean calendar month. Day' or 'Days' unless herein otherwise expressly defined shall mean calendar day or days of twenty four (24) hours each. A week shall mean continuous period of seven (7) days.
- 35 Consignee** shall mean the official(s)/ person(s) to whom the stores are required to be delivered in the manner indicated in the Order/ Contract.
- 36 Plant/ Equipment/ Stores** shall mean the goods, machinery, components, parts, spares etc. required to be supplied by Seller/ Contractor as per Order/ Contract.
- 37 Contract Engineer (CE)** shall mean the official who signs the Order/ Contract on behalf of Purchaser.
- 38 Site Engineer** shall mean officer of Purchaser/ Owner authorized to receive and verify the in-coming stores, and issue Material Receipt Certificate (MRC)/ Stores Receipt Voucher (SRV).
- 39 Site Inspection Agency (Site IA)** shall mean person(s) authorized by Purchaser/ Owner to inspect the stores/ works included in Order/ Contract at the Project Site.
- 40 GENERAL**

The words incorporating singular shall include plural and vice-versa, the words incorporating masculine gender shall include feminine gender and vice-versa, and the words incorporating persons shall include bodies, corporate, limited liability companies, partnership and other legal entities.

	<p align="center"><b>ELECTRO- PORCELAINS DIVISION</b></p>	<p align="center"><b>GENERAL CONDITIONS OF CONTRACT (GCC)</b>  Revision No. R0 (For supply and services)</p>	<p align="center"><b>ABBREVIATIONS</b>  Issued on 01.04.2017</p>
---	---	--	--

### ABBREVIATIONS

AWB	Airway Bill
BL	Bill of Lading
BOQ	Bill of Quantity
CAD	Cash Against Documents
CENVAT	Central Value Added Tax
CFR	Cost & Freight
CIF	Cost, Insurance and Freight
CIP	Carriage & Insurance Paid (up to destination)
CPT	Cost Freight Paid
CQ	Corporate Quality
CVD	Countervailing Duty
DMS	Document Management System
EMD	Earnest Money Deposit
E&C	Erection and Commissioning
FOB	Free on Board
GR	Goods Receipt
GRN	Goods Receipt Number
H1 bidder	Bidder quoting highest landed cost to BHEL
IP	Integrity Pact
IEM	Independent External Monitor
L1 Bidder	Bidder quoting lowest landed cost to BHEL
LC	Letter of Credit
LOI	Letter of Intent
LOA	Letter of Award

---

	<p align="center"><b>ELECTRO- PORCELAINS DIVISION</b></p>	<p align="center"><b>GENERAL CONDITIONS OF CONTRACT (GCC)</b>   <b>Revision No. R0</b>  <b>(For supply and services)</b></p>	<p align="center"><b>ABBREVIATIONS</b>   Issued on 01.04.2017</p>
---	---	--	---

LR	Lorry Receipt
MDCC	Material Despatch Clearance Certificate
MRC	Material Receipt Certificate
MSMED	Micro Small and Medium Enterprises Development
NIT	Notice Inviting Tender
O&M	Operation & Maintenance
PBG	Performance Bank Guarantee
P&ID	Process & Instrumentation Diagram
PO	Purchase order
PQR	Pre-Qualification Requirement
PVC	Price Variation Clause/compensation
QS	Quality Surveillance
RA	Reverse Auction
RAB	Running Account Bill
RBI	Reserve Bank of India
RFQ	Request for Quotation
RR	Railway Receipt
SAD	Special Additional Duty
SCC	Special Conditions of Contract

	<p align="center"><b>ELECTRO-PORCELAINS DIVISION</b></p>	<p align="center"><b>GENERAL CONDITIONS OF CONTRACT (GCC)</b>  Revision No. R0 (For supply &amp; services)</p>	<p align="center"><b>INSTRUCTIONS TO BIDDERS</b>  Issued on 01.04.2017</p>
---	--	--	--

**INSTRUCTIONS TO BIDDERS**  
**TABLE OF CONTENTS**

Sl. No.	DESCRIPTION
1.0	GENERAL INSTRUCTIONS
2.0	PROCEDURE FOR SUBMISSION & OPENING OF TENDERS
3.0	MINIMUM E&C CHARGES
4.0	AUTHORITY FOR TENDER SIGNING
5.0	CLARIFICATIONS REQUIRED BY BIDDERS
6.0	DEVIATIONS - LISTING
7.0	VALIDITY OF OFFER
8.0	LANGUAGE & CORRECTIONS
9.0	PRICE DISCREPANCY
10.0	TENDERER TO INFORM HIMSELF FULLY
11.0	ETHICS IN BUSINESS DEALINGS & FRAUD PREVENTION POLICY
12.0	INTEGRITY PACT
13.0	REVERSE AUCTION
14.0	REJECTION OF TENDER AND OTHER CONDITIONS
15.0	DEVIATIONS FROM NIT
16.0	LOADING FOR COMMERCIAL DEVIATION (WHERE COST OF WITHDRAWL NOT GIVEN)
17.0	INTEREST RATE FOR LOADING
18.0	DISCOUNT
19.0	EVALUATION CRITERIA
20.0	FOREIGN SUPPLIERS & INDIAN AGENTS OF FOREIGN SUPPLIERS
21.0	MICRO & SMALL ENTERPRISES

	<b>ELECTRO-PORCELAINS DIVISION</b>	<b>GENERAL CONDITIONS OF CONTRACT (GCC)</b>  <b>Revision No. R0</b> <b>(For supply &amp; services)</b>	<b>INSTRUCTIONS TO BIDDERS</b>  Issued on 01.04.2017
---	------------------------------------	---	--

## GENERAL

These general terms & conditions shall apply to all enquiries, notice inviting tenders, request for quotations concerning the supply of goods and / or rendering of services to Bharat Heavy Electricals Ltd., - Electroporcelains Division (hereinafter referred to as BHEL or the Purchaser) or its Projects / Customers.

### **1.0 GENERAL INSTRUCTIONS**

- 1.1 Tenderers are advised to study all the tender documents carefully. Any submission of tender by the tenderer shall be deemed to have been done after careful study and examination of the tender documents and with full understanding of the implications thereof. The specifications and terms & conditions shall be deemed to have been accepted unless otherwise specifically commented upon in 'Deviation sheets by the tenderer in his offer. Noncompliance with any of the requirements and instructions in the Tender Enquiry may result in rejection of the tender.

Integrity Pact (IP) will be applicable for all tenders/ contracts valuing more than a specific value or if specified in NIT/ RFQ. Integrity Pact document shall be issued as part of tender and shall be returned by bidders along with their technocommercial bids, duly signed by authorized signatories. Only those vendors/ bidders who enter into Integrity Pact with BHEL would be qualified to participate in the bidding process.

- 1.2 All commercial terms and conditions, except prices, should be submitted as part of techno-commercial offer (Part-I) along with unpriced copy of Annexure-II, which may be opened first. The price part (Part-II) along with price copy of Annexure-II is to be submitted in a separate sealed cover (or to be uploaded in website in case of e-procurement) along with techno-commercial offer. Purchaser reserves the right to open both the Parts at the same time.

- 1.3 A declaration as per Annexure-III must be sent before opening of Price Bids.

### **2.0 PROCEDURE FOR SUBMISSION & OPENING OF TENDERS**

- 2.1 Tenders shall be submitted in **Two parts** on or before the Due Date and time indicated in the NIT/ RFQ.

#### **PART - I : Techno-Commercial Bid**

comprising of Technical Offer, Annexure-I, Commercial Terms & Conditions, Unpriced copy of Price Bid& Annexure II, PQR documents (if applicable) in two

	<b>ELECTRO-PORCELAINS DIVISION</b>	<b>GENERAL CONDITIONS OF CONTRACT (GCC)</b>  <b>Revision No. R0</b> <b>(For supply &amp; services)</b>	<b>INSTRUCTIONS TO BIDDERS</b>  Issued on 01.04.2017
---	------------------------------------	---	--

(2) sets.

### **PART - II: Price Bid**

Containing Prices, cost of withdrawal of deviation as per Annexure-II, to be submitted in original, strictly, as per Price Schedule of BHEL for complete scope of Tender Enquiry.

**NOTE:** Offers are liable to be rejected for changes made by vendors in the Price Schedule, except those specified in the unpriced bid and accepted by Purchaser.

- 2.1.1 PART-I (Techno-Commercial bid) may be opened on Due Date and time specified in the NIT/ RFQ, or extension thereof, in presence of tenderers who may like to attend. Incomplete offers are liable to be rejected. Purchaser reserves the right to open both Part-I and Part-II together.
- 2.1.2 PART-II containing prices shall be submitted along with Part-I but in a separate sealed cover. Corrections/amendments shall be properly authenticated, else the offer is liable to be rejected.
- 2.1.3 Any discount/revised offer submitted by a bidder on its own shall be accepted provided it is received on or before the due date and time of offer submission. The discount shall be applied on pro-rata basis to all items unless specified otherwise by the bidder.

Unsolicited discounts/revised offers given after due date and time of offer submission shall not be accepted.

In case there is no change in the technical scope and/or specifications and/or commercial terms & conditions, the bidder/s shall not be allowed to change his/their price bids after the due date, within the validity period.

In case of changes in scope and/or technical specification and/or commercial terms & conditions, having price implications, techno-commercially acceptable bidders shall be asked by BHEL (after freezing the scope, technical specifications and commercial terms & conditions) to submit the impact of such changes on their price bid. A cut-off date and time shall be given to all the techno-commercially acceptable bidders to submit the impact on their price bids.

In the event of any bidder, after finalizing the technical specification & scope of supply, opting to revise and submit their latest price bid instead of submitting impact on their price bid asked by BHEL, then their original price (i.e. the previous bid) shall also be opened.

	<b>ELECTRO-PORCELAINS DIVISION</b>	<b>GENERAL CONDITIONS OF CONTRACT (GCC)</b>  <b>Revision No. R0</b> <b>(For supply &amp; services)</b>	<b>INSTRUCTIONS TO BIDDERS</b>  Issued on 01.04.2017
---	------------------------------------	---	--

Price Impact/ Discount/ Revised Price Bid shall be duly superscribed as:

“Price Impact / Discount/ Revised Price Bid (Part-II) (delete whichever is not applicable), Revision No. \_\_\_ against Tender Enquiry No. \_\_\_\_\_ dated \_\_\_\_”

- 2.2 After technical & commercial examination of the offers received and clarifications obtained (if required), Part-II (Revised Price Bid/ Original Price Bid along with Price Impact and Discount, if any) shall be opened, for which the date and time shall be intimated to technically and commercially acceptable bidders in case of public opening. BHEL may opt to finalise the prices through Reverse Auction amongst technically and commercially acceptable bidders. BHEL reserves the right to open the earlier price bids, if any, submitted by the bidder(s), if required.
- 2.3 No correspondence shall be entertained from the tenderers after opening of Part-II (Price bid), except clarifications (if any) asked by BHEL in writing.
- 2.4 **Instructions regarding centralised tender room and tender opening:**
- a) Vendors are advised to submit the tenders in the tender box, containing Part-I & II offers in separate covers, preferably cloth lined envelopes should be used, properly marked before due date and time.
  - b) BHEL-EPD shall not accept any tender in torn condition and return the same to the courier immediately with the Stamping "Returned to Sender-Package Damaged". Offers in damaged condition will not be considered and no request for extension on this account will be considered.
  - c) Bidder's representative shall deposit the offer in tender box only.
  - d) Bidders shall be allowed in the tender room in area identified for bidders and only one/two authorized representative(s) from each bidder shall be allowed.
  - e) Bidder shall not be allowed to carry mobile/camera /laptop in the tender room. The same shall have to be deposited at security in advance and taken back after tender opening.
  - f) In case of two part bid system, bidder's representative(s), witnessing the tender opening shall have to sign on all the envelopes containing the price bids. Thereafter, all the price bid envelopes shall be put in a bigger envelope / box and the same shall be properly sealed. The sealed envelope / box shall have to be signed by the tender opening official(s) / committee of Purchaser and bidder's representatives.

	<b>ELECTRO-PORCELAINS DIVISION</b>	<b>GENERAL CONDITIONS OF CONTRACT (GCC)</b>  <b>Revision No. R0</b> <b>(For supply &amp; services)</b>	<b>INSTRUCTIONS TO BIDDERS</b>  Issued on 01.04.2017
---	------------------------------------	---	--

- g) Details of offers shall be read out to bidders and in no case the offers shall be handed over to any of the bidders for noting down.
- h) Please ensure tender submission, minimum 1 hour before scheduled tender opening time.

Late tenders shall not be accepted.

2.5 Purchaser may negotiate the tender with L1 bidder after RA/ price bid opening.

## 2.6 MARKING ON ENVELOPES

2.6.1 Following shall be superscribed on the envelopes which shall be addressed by name and designation to the official inviting tender:

PART-I :     1. TENDER ENQUIRY No. AND ITEM DESCRIPTION  
                   2. DUE DATE FOR OPENING  
                   3. "TECHNO-COMMERCIAL BID".

PART-II :    1. TENDER ENQUIRY NO AND ITEM DESCRIPTION  
                   2. DUE DATE FOR OPENING  
                   3. "PRICE BID".

2.6.2 Both Parts - I & II shall be submitted in separate sealed covers duly superscribed as indicated above and shall be enclosed further in a main cover duly sealed and superscribed as:

"TENDER FOR \_\_\_\_\_ AGAINST TENDER ENQUIRY NO. \_\_\_\_\_ DUE ON \_\_\_\_\_ CONTAINING PART-I & PART-II BIDS"

2.6.3 Envelope not marked with tender enquiry number is liable to be ignored and may not be opened.

## 2.7 BID SUBMISSION

2.7.1 Tenders shall be addressed to BHEL officials by name & designation and sent to the following address:

Tender Box at the reception of EPD,  
 Bharat Heavy Electricals Ltd.  
 ELECTROPORCELAINS DIVISION  
 Opp. IISc, PROF. C N R RAO CIRCLE ,  
 MALLESWARAM , BANGALORE - 560 012  
 Attention: 1) Mr.

	<b>ELECTRO-PORCELAINS DIVISION</b>	<b>GENERAL CONDITIONS OF CONTRACT (GCC)</b>  <b>Revision No. R0</b> <b>(For supply &amp; services)</b>	<b>INSTRUCTIONS TO BIDDERS</b>  Issued on 01.04.2017
---	------------------------------------	---	--

2) Mr.

- 2.7.2 Tenders can either be deposited in tender room in person or sent by Courier/Registered or Speed Post to the above mentioned address. It shall be bidders' responsibility to ensure that tenders are delivered latest by 14:00 hours (IST) of the enquiry due date.
- 2.7.3 Bidder can also submit offer through email, if called for in the enquiry, at the email address indicated in the enquiry. Such email offers shall be sent only on designated email-id to reach before 14.00 hrs of the tender due date. BHEL will not be responsible for incomplete offers and the ones delivered late through e-mail.
- 2.8 Tenders received after the Due Date and Time of submission as mentioned at 2.7.2 shall be rejected.
- 2.9 Name of vendor's dealing person with Contact No(s), Email ID and Address of correspondence shall be provided in the bid as per ANNEXURE XVIII.
- 2.10 Unsolicited tenders will not be entertained.
- 2.11 **OFFER SUBMISSION IN E-PROCUREMENT**

Tenders shall be submitted in Two parts on or before the Due Date and time indicated on the portal as per the following instructions:

PART - I : Technical & Commercial bid

Comprising of following:

1. PQ qualification documents (Mandatory, if shown on portal)
2. Annexure-I to GCC (Mandatory)
3. General conditions of contract, GCC (Mandatory)
4. Special conditions of contract, SCC (Mandatory)
5. Technical offer, comprising of technical specification and other documents as asked in technical specifications e.g. drawings, test report etc. (Mandatory)
6. Annexure-III to GCC (Declaration about completeness of price) - (Mandatory)
7. Annexure-XII to GCC (Optional)

"NO DEVIATION CERTIFICATE" FOR COMMERCIAL TERMS AND

	<p style="text-align: center;"><b>ELECTRO-PORCELAINS DIVISION</b></p>	<p style="text-align: center;"><b>GENERAL CONDITIONS OF CONTRACT (GCC)</b></p> <p style="text-align: center;"><b>Revision No. R0</b> <b>(For supply &amp; services)</b></p>	<p style="text-align: center;"><b>INSTRUCTIONS TO BIDDERS</b></p> <p style="text-align: center;">Issued on 01.04.2017</p>
---	---	---	---

CONDITIONS as per General Conditions of Contracts (GCC, Rev.01), Special Conditions of Contracts and RFQ in case of no deviations

8. Integrity Pact Agreement (Mandatory if shown on portal, not applicable otherwise)
9. Unpriced copy of Annexure-II, cost of withdrawal of deviation (Mandatory)
10. Supplier details as per detail annexure.

Any deviation not mentioned in un-priced copy of this format, but mentioned in the priced copy, shall not at all be accepted.

*Bidder to note all the points mentioned in "Notes" of Annexure-II to GCC Rev.01.*

Cost of withdrawal for the deviations, for which, the "Cost of withdrawal" is not specified, shall be taken as NIL.

The vendors shall be forced by the system to upload the above documents which are marked mandatory. The Annexure mentioned at Sl no 2, 6 & 7 (if applicable), above should be duly filled by the bidder and should be printed on their letter head before uploading.

**PART - II: Price bid**

Containing

1. Prices as per price format,
2. Cost of withdrawal of deviation as per Annexure-II, to be uploaded strictly as per Price Schedule of BHEL for complete scope of Tender Enquiry.

NOTE: Offers are liable to be rejected for changes made by vendors in the Price Schedule, except those specified in the unpriced bid and accepted by Purchaser.

**The clause nos 2.6 & 2.7 above of this GCC shall not be applicable in case of eprocurement**

- 3.0 In case of TURNKEY PACKAGES total **erection & commissioning charges** including service tax should be minimum 15% (or as specified in NIT) of the total quoted package price (excluding mandatory spares but including all taxes and freight), failing which the break-up of prices shall be adjusted accordingly for ordering.

	<b>ELECTRO-PORCELAINS DIVISION</b>	<b>GENERAL CONDITIONS OF CONTRACT (GCC)</b>  <b>Revision No. R0</b> <b>(For supply &amp; services)</b>	<b>INSTRUCTIONS TO BIDDERS</b>  Issued on 01.04.2017
---	------------------------------------	---	--

**4.0 Authority of the person signing the tender on behalf of the tenderer:**

A person signing the tender or any other document in respect of Order/Contract on behalf of the tenderer, without disclosing his authority to do so shall be deemed to warrant that he has the authority to bind the tenderer. If it is discovered at any time that the person so signing had no authority to do so, the Purchaser may, without prejudice to any other right or remedy, cancel the Order/Contract and make or authorize the purchase of the stores at the risk and cost of such tenderer and hold such tenderer liable to Purchaser for all costs and damages arising from cancellation of the Order/Contract including any loss which Purchaser may sustain on account of such purchase.

**Notes:**

- a) Bids of Indian supplier shall be in Indian Rupee only.
- b) Bids of foreign suppliers shall preferably be in currency of the country of origin and on CPT/ CFR basis. In case of supplies from Indian origin, it shall be in INR on F.O.R BHEL EPD BANGALORE - 12.
- c) An authorized representative/ agent can represent only one bidder for the given package.

**5.0 CLARIFICATIONS REQUIRED BY BIDDERS**

Technical and commercial clarifications required before submission of the tender should be addressed to the official(s) inviting the tender. The bidders are requested to submit all their queries/clarifications by the date specified in the NIT after which it will be presumed that there are no queries/clarifications and BHEL will be under no obligation to reply queries/clarifications raised after the date.

**6.0 DEVIATIONS - LISTING**

- 6.1 Tenders shall be submitted strictly in accordance with the requirements of tender documents. In case of deviations from NIT, the tenderer shall give cost of withdrawal of such deviation in Sealed Cover as per Annexure-II.
- 6.2 If bidder insists for price variation clause (PVC) where NIT specifies Firm price, the offer should contain:-
  - a) PVC Formula
  - b) Ceiling for PVC
  - c) Base date and applicable indices for the base date.

	<b>ELECTRO-PORCELAINS DIVISION</b>	<b>GENERAL CONDITIONS OF CONTRACT (GCC)</b>  <b>Revision No. R0</b> <b>(For supply &amp; services)</b>	<b>INSTRUCTIONS TO BIDDERS</b>  Issued on 01.04.2017
---	------------------------------------	---	--

Open ended PVC formula is not acceptable. Indices shall be based on Government of India/ RBI publications/ IEEMA/ LME etc. However, BHEL reserves the right to accept/ reject the offer with PVC.

## 7.0 VALIDITY OF OFFER

Vendors' offers shall be submitted with the following validity periods:

- i) Original offer shall be valid for 90 days from Part-I opening.
- ii) If revised price bid/ price impact is asked by BHEL, the validity of the same shall be 60 days from the date of revised price bid/ price impact or 120 days from Part-I opening, whichever is later.
- iii) Prices of Recommended Spares, O&M Spares and Mandatory Spares (wherever these are Optional items) shall be valid till two years from the date of PO.
- iv) Unit prices for scope addition/ deletion shall be valid till two years from the date of PO.
- v) Prices of optional items shall be valid till the contract period for placement of order.
- vi) Offers with shorter validity are liable to be rejected.

## 8.0 LANGUAGE & CORRECTIONS

- a) Tenderer shall quote the rates in Hindi/English language and international numerals only. Total Price shall be entered in figures as well as in words. For the purpose of tender, metric system of units shall be used.
- b) All entries in the tender shall either be typed or written legibly in ink. Cancellations, corrections, insertions, erasements, over-writing (if unavoidable) shall be authenticated with signature and seal by the bidder.

## 9.0 PRICE DISCREPANCY

Following shall be considered for evaluation and ordering for non-conformities/ errors/ discrepancies in price bid:

- (a) If, in the price structure quoted for the required goods/ services/ works, there is discrepancy between the unit price and the total price (which is obtained by multiplying the unit price by the quantity), the unit price shall prevail and the total price corrected accordingly, unless in the opinion of the Purchaser there is an

	<b>ELECTRO-PORCELAINS DIVISION</b>	<b>GENERAL CONDITIONS OF CONTRACT (GCC)</b>  <b>Revision No. R0</b> <b>(For supply &amp; services)</b>	<b>INSTRUCTIONS TO BIDDERS</b>  Issued on 01.04.2017
---	------------------------------------	---	--

obvious misplacement of the decimal point in the unit price, in which case the total price as quoted shall govern and the unit price corrected accordingly.

(b) If there is an error in a total corresponding to the addition or subtraction of subtotals, the subtotals shall prevail and the total shall be corrected.

(c) If there is a discrepancy between words and figures, the amount in words shall prevail, unless the amount expressed in words is related to an arithmetic error, in which case the amount in figures shall prevail subject of (a) and (b) above.

(d) If there is such discrepancy in an offer, the same shall be conveyed to the bidder with target date upto which the bidder has to send his acceptance on the above lines and if the bidder does not agree to the decision of the Purchaser, the bid is liable to be ignored.

(e) Taxes and duties if not specified clearly as extra shall be considered as included in the basic price and, therefore, shall not be reimbursed.

#### **10.0 TENDERER TO INFORM HIMSELF FULLY**

10.1 Tenderer shall closely peruse all clauses, specifications & drawings etc. indicated in tender documents before quoting. In case of any doubt about meaning of any portion of tender specifications or discrepancies or omissions in drawings/tender document or clarifications regarding scope of work etc., tenderer shall contact the official(s) inviting the tender for clarifications, before submitting the offer.

10.2 Tenderer shall make independent enquiries as to conditions and circumstances affecting cost estimates, and possibility of executing supplies/works as described. Tenderer shall be deemed to have inspected and examined the site and its surroundings and to have satisfied himself as to the form and nature of the site, the quantities and materials necessary for completion of the work and means of transport and access to the site, the accommodation required, general labour position at site and to have quoted prices taking into consideration the risks, contingencies and other circumstances which may influence or affect execution of the Order/Contract.

10.3 It is the responsibility of tenderer to keep himself informed about all taxes & duties applicable on materials/services as prevailing at the time of tendering. If the rates assumed by tenderer are less than the tariff rates prevailing at the time of tendering, the tenderer will be himself responsible for such under quotations.

	<b>ELECTRO-PORCELAINS DIVISION</b>	<b>GENERAL CONDITIONS OF CONTRACT (GCC)</b>  <b>Revision No. R0</b> <b>(For supply &amp; services)</b>	<b>INSTRUCTIONS TO BIDDERS</b>  Issued on 01.04.2017
---	------------------------------------	---	--

## **11.0 ETHICS IN BUSINESS DEALINGS & FRAUD PREVENTION POLICY**

11.1 The Bidder along with its associate/collaborators/sub-contractors/sub vendors/ Consultants/ service providers shall strictly adhere to BHEL Fraud Prevention Policy displayed on BHEL website <http://www.bhel.com> and shall immediately

bring to the notice of BHEL Management about any fraud or suspected fraud as soon as it comes to their notice."

11.2 Integrity commitment, performance of the contract and punitive action thereof:

11.2.1 Commitment by BHEL:

BHEL commits to take all measures necessary to prevent corruption in connection with the tender process and execution of the contract. BHEL will during the tender process treat all Bidder(s) in a transparent and fair manner, and with equity.

11.2.2 Commitment by Bidder/ Supplier/ Contractor:

(a) The bidder/ supplier/ contractor commit to take all measures to prevent corruption and will not directly or indirectly influence any decision or benefit which he is not legally entitled to nor will act or omit in any manner which tantamount to an offence punishable under any provision of the Indian Penal Code, 1860 or any other law in force in India.

(b) The bidder/ supplier/ contractor will, when presenting his bid, disclose any and all payments he has made, and is committed to or intends to make to agents, brokers or any other intermediaries in connection with the award of the contract and shall adhere to relevant guidelines issued from time to time by Govt. of India/ BHEL.

© The bidder/ supplier/ contractor will perform/ execute the contract as per the contract terms & conditions and will not default without any reasonable cause, which causes loss of business/ money/ reputation, to BHEL.

If any bidder/ supplier/ contractor during pre-tendering/ tendering/ post tendering/ award/ execution/ post-execution stage indulges in mal-practices, cheating, bribery, fraud or and other misconduct or formation of cartel so as to influence the bidding process or influence the price or acts or omits in any manner which tantamount to an offence punishable under any provision of the Indian Penal Code, 1860 or any other law in force in India, then, action may be taken against such bidder/ supplier/ contractor as per extant guidelines of the company available on [www.bhel.com](http://www.bhel.com) and/or under applicable legal provisions".

	<b>ELECTRO-PORCELAINS DIVISION</b>	<b>GENERAL CONDITIONS OF CONTRACT (GCC)</b>  <b>Revision No. R0</b> <b>(For supply &amp; services)</b>	<b>INSTRUCTIONS TO BIDDERS</b>  Issued on 01.04.2017
---	------------------------------------	---	--

## 12.0 INTEGRITY PACT

Vendors shall have to enter into Integrity Pact with BHEL if specified in NIT/ RFQ, failing which vendor's offer will be rejected (Refer Annexure-IX).

## 13.0 REVERSE AUCTION

BHEL reserves the right to go for Reverse Auction (RA) (Guidelines as available on [www.bhel.com](http://www.bhel.com)) instead of opening the sealed envelope price bid (priced format submitted along with the offer in case of e-procurement), submitted by the bidder. This will be decided after techno-commercial evaluation. Bidders to give their acceptance with the offer for participation in RA. Non-acceptance to participate in RA may result in non-consideration of their bids, in case BHEL decides to go for RA.

Those bidders who have given their acceptance to participate in Reverse Auction will have to necessarily submit 'Process compliance form' (to the designated service provider) as well as 'Online sealed bid' in the Reverse Auction. Nonsubmission of 'Process compliance form' or 'Online sealed bid' by the agreed bidder(s) will be considered as tampering of the tender process and will invite action by BHEL as per extant guidelines for suspension of business dealings with suppliers/ contractors (as available on [www.bhel.com](http://www.bhel.com)).

The bidders have to necessarily submit online sealed bid less than or equal to their envelope sealed price bid (priced format submitted along with the offer in case of e-procurement) already submitted to BHEL along with the offer. The envelope sealed price bid of successful L1 bidder in RA, if conducted, shall also be opened after RA and the order will be placed on lower of the two bids (RA closing price & envelope sealed price) thus obtained. The bidder having submitted this offer specifically agrees to this condition and undertakes to execute the contract on thus awarded rates.

If it is found that L1 bidder has quoted higher in online sealed bid in comparison to envelope sealed bid (priced format submitted along with the offer in case of e-procurement) for any item(s), the bidder will be issued a warning letter to this effect. However, if the same bidder again defaults on this count in any subsequent tender in the unit, it will be considered as fraud and will invite action by BHEL as per extant guidelines for suspension of business dealings with suppliers/ contractors (as available on [www.bhel.com](http://www.bhel.com))."

	<b>ELECTRO-PORCELAINS DIVISION</b>	<b>GENERAL CONDITIONS OF CONTRACT (GCC)</b>  <b>Revision No. R0</b> <b>(For supply &amp; services)</b>	<b>INSTRUCTIONS TO BIDDERS</b>  Issued on 01.04.2017
---	------------------------------------	---	--

#### **14.0 REJECTION OF TENDER AND OTHER CONDITIONS**

14.1 Acceptance of tender will rest with Purchaser and does not bind him to accept the lowest or any tender and reserves to itself full rights for the following without assigning any reasons whatsoever:

- a) To reject any or all the tenders.
- b) To split the work amongst two or more tenderers (where E&C is not in tenderer's scope).
- c) To award the work in part. (where E&C is not in tenderer's scope).
- d) To increase or decrease the quantities.
- e) To reject any commercial or technical deviation given in offer.

14.2 Standard pre-printed conditions of tenderer attached to offer will not be accepted and only those mentioned in the body of offer will be considered.

14.3 Purchaser will not be bound by any power of attorney granted by tenderer or by changes in composition of the firm made subsequent to award of Order/Contract. Purchaser may, however, recognize such power of attorney and changes after obtaining proper legal advice, the cost of which will be chargeable to the Seller/Contractor concerned.

14.4 If tenderer deliberately gives wrong information, Purchaser reserves the right to reject such an offer at any stage or cancel the Order/Contract, if awarded, and forfeit the security deposit and bank guarantee.

#### **15.0 DEVIATIONS FROM NIT**

15.1 Deviations (Commercial as well as Technical) from NIT are generally not acceptable. In case of deviations from NIT, the tenderer shall give cost of withdrawal of such deviation in Sealed Cover as per Annexure-II.

#### **16.0 Loading For Commercial Deviations (where cost of withdrawal not given)**

16.1 For deviations w.r.t. Payment terms, Liquidated damages, Firm prices and submission of E1/ E2 forms before claiming 10% payment, if a bidder chooses not to give any cost of withdrawal of deviation loading as per Annexure-VIII will apply.

17.0 Interest Rate for loading will be taken as Base rate of SBI (as applicable on the date of bid opening, Techno-commercial bid, in case of 2 part bids) + 6% for the period of relaxation sought by the bidders.

	<b>ELECTRO-PORCELAINS DIVISION</b>	<b>GENERAL CONDITIONS OF CONTRACT (GCC)</b>  <b>Revision No. R0</b> <b>(For supply &amp; services)</b>	<b>INSTRUCTIONS TO BIDDERS</b>  Issued on 01.04.2017
---	------------------------------------	---	--

## 18.0 DISCOUNT

Discount offered by any bidder in the original price bid, against the present Tender Enquiry, which is also indicated to be applicable to any other Enquiry, shall be considered against the present Tender Enquiry only. In case only percentage discount is indicated, the same shall be applicable to optional prices also.

Discount offered shall be valid for full duration of offer validity.

Any conditional discount shall not be considered for evaluation.

## 19.0 EVALUATION CRITERIA

- 19.1 Evaluation of the tender shall be on the basis of delivered cost, i.e. 'total cost to BHEL' w.r.t the finalized technical scope and commercial conditions (after considering, inter alia, Customs Duty and CENVAT/ VAT/ Service Tax/Entry Tax as applicable) and taking into consideration loadings, if any, and all available financial advantages.
- 19.2 Exchange rate (TT selling rate of State Bank of India) applicable on the date of Part-I bid opening shall be considered for evaluation of foreign bids. If the relevant day happens to be a bank holiday in India, then the FOREX rate as on the previous bank working day shall be taken for evaluation.
- 19.3 Foreign suppliers shall ensure that the benefits as applicable under Comprehensive Economic Partnership Agreement (CEPA) with Government of India are disclosed in the bid & relevant documents such as Certificate of Country of Origin, issued by the appropriate authority in the country of Export, is provided by the vendor along with dispatch documents. Bids shall be evaluated with such applicable benefits. In the event of Seller failing to provide appropriate documents for Purchaser to avail disclosed concessional duty benefits in India, financial loss, so incurred, will be to the Seller's account.
- 19.4 The quoted CFR price shall be loaded by the following to arrive at the Delivered Cost:
- Import duty as applicable at the time of Part-II (Price) bid opening.
  - Terminal handing charges at destination & other charges & Inland freight will be loaded at 1% of CFR value.

## 20.0 FOREIGN SUPPLIERS & INDIAN AGENTS OF FOREIGN SUPPLIERS

Please refer 'Annexure-V' for guidelines.

	<p align="center"><b>ELECTRO-PORCELAINS DIVISION</b></p>	<p align="center"><b>GENERAL CONDITIONS OF CONTRACT (GCC)</b></p> <p align="center">Revision No. R0 (For supply &amp; services)</p>	<p align="center"><b>INSTRUCTIONS TO BIDDERS</b></p> <p align="center">Issued on 01.04.2017</p>
---	--	---	---

## 21.0 MICRO & SMALL & MEDIUM ENTERPRISES

Extant regulations of Govt. of India titled “Public Procurement Policy for Micro & Small Enterprises (MSE’s) Order dated 23.03.2012” will be applicable.

## 22.0 Authorisation for participation in EPS portal through DSC

### E-Tender Participation requirements

Either Principal or authorised agent shall register their Digital Signature Certificate (DSC) (Class 3- SHA2- 2048 BIT- SIGNING & ENCRYPTION). You are advised to pls go through the FAQ available in the web portal (<https://bheleps.buyjunction.in>). DSC shall be registered for the authorised person and all transaction done using that DSC against our tenders shall be taken as valid communication and shall be binding on principal/ agent and is valid legally.

### For foreign Principal



In case of Principal (being foreigner) they may apply for DSC through Indian embassy at their country and can register with us for participating in E-tenders. Details of the applicable procedure is available in the webpage <http://www.cca.gov.in/cca/>

### For Indian agent

In case of agents participating/registering their DSC (of authorised person), it will be at the sole authorisation of principal to their agents to participate on their behalf and all transactions done using that DSC against our tenders shall be known as valid communication and shall binding on principal and is legally valid.

### DSC Authorisation

Pls intimate the authorised person name, Mail ID for registering DSC with us to participate in E-Tenders

 	<p align="center"><b>ELECTRO- PORCELAINS DIVISION</b></p>	<p align="center"><b>GENERAL CONDITIONS OF CONTRACT (GCC)</b>  Revision No. R0 (For supply and services)</p>	<p align="center"><b>GENERAL COMMERCIAL TERMS &amp; CONDITIONS</b>  Issued on 11.05.2017</p>
---	---	--	--

## GENERAL COMMERCIAL TERMS & CONDITIONS

### TABLE OF CONTENTS

Sl. No.	DESCRIPTION
1.0	ACCEPTANCE OF ORDER
2.0	CONTRACT
3.0	PRICES
4.0	TAXES AND DUTIES
5.0	STATUTORY VARIATION
6.0	VARIATION OF CONTRACT VALUE
7.0	DRAWING SUBMISSION & APPROVAL
8.0	TRANSPORTATION & FREIGHT CHARGES
9.0	TERMS OF PAYMENT
10.0	RECOVERY OF OUTSTANDING AMOUNT
11.0	CONTRACT PERFORMANCE BANK GUARANTEE
12.0	GUARANTEE FOR PLANT/EQUIPMENT/STORES
13.0	DELIVERY/COMPLETION SCHEDULE
14.0	INSPECTION AND TESTING AT CONTRACTOR'S PREMISES
15.0	MATERIAL DESPATCH CLEARANCE CERTIFICATE (MDCC)
16.0	DELIVERY FAILURE AND TERMINATION / LIQUIDATED DAMAGES
17.0	INSURANCE
18.0	INTER CHANGEABILITY AND CHANGES
19.0	PACKING
20.0	STORAGE INSTRUCTIONS
21.0	MATERIAL/GOODS RECEIPT CERTIFICATE

	<p align="center"><b>ELECTRO-PORCELAINS DIVISION</b></p>	<p align="center"><b>GENERAL CONDITIONS OF CONTRACT (GCC)</b> Revision No. R0 (For supply and services)</p>	<p align="center"><b>GENERAL COMMERCIAL TERMS &amp; CONDITIONS</b>  Issued on 11.05.2017</p>
--	--	---	--

22.0	CONSIGNEE'S RIGHT OF REJECTION
23.0	RISK IN STORES (FOR E&C CONTRACTS)
24.0	SHORTAGES/DAMAGES
25.0	CONFIDENTIALITY
26.0	DEFAULT/ BREACH OF CONTRACT, INSOLVENCY & RISK PURCHASE
27.0	TERMINATION OF THE CONTRACT
28.0	TRANSFER, SUB-LETTING/ ASIGNMENT/ SUB-CONTRACTING
29.0	FORCE MAJEURE
30.0	INDEMNIFICATION
31.0	SETTLEMENT OF DISPUTES
32.0	ARBITRATION
33.0	LAWS GOVERNING THE CONTRACT
34.0	JURISDICTION OF COURT
35.0	ORDER OF PRECEDENCE
36.0	SUPPLIER PERFORMANCE MONITORING AND RATING SYSTEM
37.0	DEALING WITH BANNED SUPPLIERS/ CONTRACTORS IN BHEL
39.0	CLAUSES APPLICABLE FOR E&C PACKAGES

	<p align="center"><b>ELECTRO- PORCELAINS DIVISION</b></p>	<p align="center"><b>GENERAL CONDITIONS OF CONTRACT (GCC)</b>  Revision No. R0 (For supply and services)</p>	<p align="center"><b>GENERAL COMMERCIAL TERMS &amp; CONDITIONS</b>  Issued on 11.05.2017</p>
--	---	--	--

## 1.0 ACCEPTANCE OF ORDER

Seller/Contractor should acknowledge and accept the LOI/ Purchase Order issued by BHEL within 7 days of its receipt. Seller/Contractor should examine the LOI/ Purchase Order immediately upon receipt and bring to the notice of BHEL, within 7 days of receipt, any discrepancy with regard to scope of work, rates, taxes & duties, agreed terms & conditions etc. for due rectification. If the Seller/Contractor fails to give such intimation / acceptance within seven days, the Seller/Contractor shall be deemed to have agreed to supply the stores as per LOI/ Purchase Order.

## 2.0 CONTRACT

Contract between Purchaser and Seller/Contractor is merely a contract and shall not be treated as partnership between the parties to the contract.

## 3.0 PRICES

Prices shall be for the entire scope of work in line with the tender documents and subsequent clarifications/confirmations.

## 4.0 TAXES AND DUTIES

### 4.1 EXCISE DUTY for Indigenous purchase

4.1.1 Seller/Contractor is required to ensure that excise duty including cess, if any, is quoted as per the existing tariff on the date of the offer and all benefits as per existing rules have been considered.

4.1.2 Excise duty actually incurred by Seller/Contractor on self-manufactured items shall be reimbursed against documentary evidence.

Excise duty paid by bidder on inputs, bought out items, raw materials and components consigned directly from sources other than Seller/Contractor's factory/works shall be included by the bidder in the quoted ceiling amount of excise duty and the same shall be payable extra at actuals limited to the ceiling amount.

4.1.3 If excise duty is paid under protest or dispute, it shall not be reimbursed till the dispute is settled. If the Seller/Contractor claims/obtains any refund of the excise duty paid, the same shall be refunded to the Purchaser immediately

4.1.4 Invoice cum Excise duty gate pass (Excise Invoice) should contain the name of the ultimate consignee as per Order/Contract/ Special Conditions of Contract.

	<p align="center"><b>ELECTRO-PORCELAINS DIVISION</b></p>	<p align="center"><b>GENERAL CONDITIONS OF CONTRACT (GCC)</b> <b>Revision No. R0 (For supply and services)</b></p>	<p align="center"><b>GENERAL COMMERCIAL TERMS &amp; CONDITIONS</b>  Issued on 11.05.2017</p>
--	--	--	--

4.1.5 If required by Purchaser, the Seller / Contractor will provide a certificate stating that CENVAT benefit has been availed of on the inputs and the same has been passed on to the Purchaser.

4.1.6 Excise duty shall be paid at actuals against documentary evidence but restricted to the amount and percentage indicated in the Order/Contract.

**4.2 SALES TAX/VALUE ADDED TAX (VAT) for Indigenous purchase**

4.2.1 Central Sales Tax / Value Added Tax shall be reimbursed only if the same is paid by the Seller / Contractor to the respective Govt. authorities on direct sales by the Seller/ Contractor to the Purchaser, meeting all statutory requirements and availing all exemptions/concessions under the respective Central Sales Tax / Value Added Tax Acts. The offer should clearly indicate CST/VAT percentage and the total amount along with concessional form(s), if any.

4.2.2 Purchaser is registered in Bangalore, Karnataka vide following Registration Numbers:

Central Sales Tax Registration No. : 00850070 w.e.f. 06-03-1999.

Karnataka TIN. : 29470052861

4.2.3 Central Sales Tax/Value Added Tax shall be reimbursed, as per tariff applicable, but restricted to the percentage and amount shown in the Order/Contract. If it is shown as included in the quoted price/ not applicable, it will not be reimbursed by the Purchaser.

4.2.4 For the purchase re-sold items, purchaser proposes to make sale-in-transit under section 6 (2) (b) of Central Sales Tax Act where goods movement is inter-state. Form-C shall be issued and exchanged against Form-E1/E2 based on quarterly transactions. Seller/Contractor is required to submit his request in the format enclosed at Annexure-VI within 30 days from end of the Quarter, giving State-wise invoice details. In compliance with the notification No. CCW/CR-44-2013-14 dt. 29/04/2014 issued by Commercial Tax Dept., Govt. of Karnataka, vendors shall submit all the requisite documents within 10 days of dispatch for the purpose of issuance of 'C' forms. Timely issuance of 'C' form will depend on the compliance of this condition.

**Note:** In case of non-receipt of E1/E2 forms amount of differential tax payable by BHEL shall be to vendors' account. Submission of E1/E2 forms shall be ensured by Vendor within the time specified in sales tax act.

	<b>ELECTRO-PORCELAINS DIVISION</b>	<b>GENERAL CONDITIONS OF CONTRACT (GCC)</b> <b>Revision No. R0 (For supply and services)</b>	<b>GENERAL COMMERCIAL TERMS &amp; CONDITIONS</b> Issued on 11.05.2017
--	------------------------------------	---	--

4.2.5 For the purchase re-sold items, VAT invoices, in format prescribed by the respective State Sales Tax Act, have to be submitted in the name of Nodal Agency, if specified in Special Conditions of Contract.

**4.3 SERVICE TAX for Indigenous purchase**

4.3.1 Service Tax and Cess leviable on taxable services for the time being in force paid by the Service Provider /contractor to the Government authorities directly shall only be paid at actuals against documentary evidence of Service tax payment (Service Tax remittance challan) made to concerned Service tax authorities corresponding to the tax claimed in the previous invoice / RAB, but restricted to the rate and amount mentioned in the order/contract. The offer should clearly indicate the percentage and the total amount of service tax as well cess. Cess to be indicated as separate line item in invoice.

4.3.2 Service provider/Contractor to ensure their registration for “Intended Service” to be provided, before claiming Service tax under the “intended category”. Decision of BHEL shall be final w.r.t. the “Intended category” in which the service will be falling.

4.3.3 If required by the Purchaser, the Service Provider/Contractor will provide a certificate stating that “CENVAT Benefit has been availed of on the input and the same has been passed on to the purchaser” or “CENVAT Benefit has not been availed of on the inputs”.

4.3.4 Vendor shall comply with the Point of Taxation Rules, as contemplated under the Service Tax Rules. In case, the CENVAT credit could not be availed by BHEL within the time limit (statutory), due to delay in submission of invoice(s) or for any other reason(s) attributable to vendor(s)/contractor(s), liability towards the loss of such CENVAT credit shall be to the vendor(s)/contractor(s) account. TDS shall be made for IT as per Income Tax act.

**4.4 OTHER TAXES & LEVIES for Indigenous purchase**

All taxes and duties other than Excise Duty, Sales Tax/ VAT, Service Tax shall be deemed to be included in the Ex-Works prices unless specified otherwise by the bidder in the price bid. No variation in other taxes and duties shall be payable by Purchaser. However, statutory variation in Octroi will be payable extra against documentary evidence. Anti-dumping duty, if any, shall be in the account of bidder and shall be included in their price. No separate payment shall be made by BHEL for the same.

	<p align="center"><b>ELECTRO-PORCELAINS DIVISION</b></p>	<p align="center"><b>GENERAL CONDITIONS OF CONTRACT (GCC)</b> <b>Revision No. R0</b> <b>(For supply and services)</b></p>	<p align="center"><b>GENERAL COMMERCIAL TERMS &amp; CONDITIONS</b>  Issued on 11.05.2017</p>
--	--	---	--

**4.5 CUSTOMS DUTY for Indigenous purchase**

- 4.5.1 Customs Duty element for imported items as per Special Conditions of Contract shall be included in the Ex-Works prices. No variation in customs duty and exchange rate for imported items shall be payable by Purchaser.
- 4.5.2 Seller/Contractor shall arrange for his own import license, if required, since Purchaser will not provide any import license. Therefore, Seller/Contractor alone shall be responsible for any delay in getting import license or non-availability of the same or completion of other related formalities. Purchaser shall not be responsible for any financial liability, whatsoever, on this account.
- 4.5.3 Essentiality Certificate or Project Authority Certificate (PAC) as per Import Policy, if required to avail concessional customs duty, shall be clearly specified in the offer. Import content (CIF value in rupees) with list of items, quantity, foreign currency, country of origin etc., shall be submitted by the bidder as part of Price bid.

**4.6 DIRECT TAX for Indigenous purchase**

- 4.6.1 Purchaser shall not be liable towards income tax of whatever nature including variations thereof, arising out of this Order/Contract, as well as tax liability of the Seller/Contractor and his personnel.
- 4.6.2 Deductions of Tax at source at the prevailing rates shall be effected by the Purchaser before release of payment, as a statutory obligation, if applicable. TDS certificate will be issued by the Purchaser as per statutory provisions.

**4.7 FOREIGN PURCHASE - Imports**

The offered prices shall be inclusive of all the Taxes and duties as applicable in the country of bidder / country of dispatch for the quoted price as per incoterms (FOB/CFR/CIF/CPT etc.). Any variation in the same will be in sellers account.

**5.0 STATUTORY VARIATION for Indigenous purchase**

- 5.1 If the rates for taxes and duties in respect of the quoted materials and/or services assumed by the Seller/Contractor are less than the tariff prevailing at the time of tendering, Seller/Contractor will be responsible for such under quotations. However, if the rates assumed are higher than the correct rates prevailing at the time of tendering, the difference will be to the credit of the Purchaser.

	<p align="center"><b>ELECTRO-PORCELAINS DIVISION</b></p>	<p align="center"><b>GENERAL CONDITIONS OF CONTRACT (GCC)</b> <b>Revision No. R0 (For supply and services)</b></p>	<p align="center"><b>GENERAL COMMERCIAL TERMS &amp; CONDITIONS</b>  Issued on 11.05.2017</p>
--	--	--	--

- 5.2 Statutory Variations in Excise Duty, Service Tax and Central Sales Tax/Value Added Tax only on self-manufactured items/services rendered by vendor himself on the rates prevailing at the time of delivery/ completion in comparison to the date of offer, will be to the account of the Purchaser. No other variations such as on customs duty, exchange rate, minimum wages, prices of controlled commodities, any other input etc. shall be payable by the Purchaser.
- 5.3 Notwithstanding the above, where the actual completion of the supply occurs beyond the period stipulated in the Order/Contract or any extension thereof, variations referred to above, will be limited to the rates prevailing on the dates of such agreed completion periods only. For variations after the agreed completion periods, the Seller/Contractor alone shall bear the impact for the upward revisions and for downward revisions, purchaser shall be given the benefit of reduction in taxes/duties. This will be without prejudice to the levy of penalty for delay in delivery/completion schedule.
- 5.4 Any new tax structure (like Goods & Services Tax) as and when implemented by the Government shall become applicable in addition to or in lieu of existing tax structure.
- 6.0 PRICE BASIS:**
- 6.1 For Supply:**
- 6.1.1 Indigenous purchase** – Firm, till the completion of contract (or with PVC if specified in NIT). Ex-works, inclusive of packing & forwarding charges. Taxes, duties and freight to be paid in line clause no 4 above.
- 6.1.2 Foreign purchase:** Firm, till the completion of contract (or with PVC if specified in NIT). CFR/CPT/CIF/CIP Indian (air) port basis inclusive of testing, inspection, sea worthy packing & forwarding charges to be paid in line with GCC.
- 6.2 For E&C:**
- Firm till completion of the contract (or with PVC if specified in NIT). WCT if any, to be included in price. Service tax along with cess to be indicated separately and will be reimbursed at actuals. TDS shall be made for IT as per Income Tax act.
- 6.3 Prices shall remain Firm (or with PVC if specified in NIT) for any increase or decrease in the Order/Contract value (Ex-works) upto plus or minus 30% within contract period unless specified otherwise in NIT. The Purchaser shall have the right to increase or decrease quantities and scope upto the above extent of value and

	<p align="center"><b>ELECTRO-PORCELAINS DIVISION</b></p>	<p align="center"><b>GENERAL CONDITIONS OF CONTRACT (GCC)</b> <b>Revision No. R0 (For supply and services)</b></p>	<p align="center"><b>GENERAL COMMERCIAL TERMS &amp; CONDITIONS</b> Issued on 11.05.2017</p>
--	--	--	---

Seller/Contractor shall be bound to accept the same at the contracted prices without any escalation.

**7.0 DRAWING SUBMISSION & APPROVAL:**

Drawing submission & Approvals as per technical specification is the responsibility of the vendor.

**8.0 DELIVERY TERMS**

**8.1 Indigenous Purchase**

Goods shall be delivered on 'FOR Destination' basis to the named destination unless otherwise called for in the enquiry.

**8.2 Foreign Purchase - Imports**

8.2.1. Goods shall be dispatched by sea, unless stated otherwise in the enquiry or purchase order.

8.2.2. The goods shall be delivered on CFR basis to the ICD-BANGALORE unless specified otherwise in enquiry or Purchase order.

8.2.3 The quote should be inclusive of all charges, including testing, packing, inspection etc. Additionally ocean freight (LILO basis) for CFR, ICD BANGALORE shall also be quoted separately as per price format.

8.2.4. Goods shall be handled for ocean freight / air freight by BHEL's freight forwarder only, under FOB contracts and OBL / HAWB issued by BHEL appointed forwarder or his authorized agent(s) shall only be accepted for negotiation.

8.2.5 For CFR terms, shipped in Break Bulk/ Container, supplier shall quote the freight charges on LILO (LINER IN LINER OUT) basis. Alternately shipment by container is also acceptable and In such cases B/L should bear the endorsement that "14 free days for Container Detention is applicable" and it would be presumed by BHEL that the freight charges quoted is on LILO (LINER IN LINER OUT) basis including extra charges, if any, like Container Imbalance Charges, Trade Imbalance charges, Port congestion charges or any other charges payable to the Liner. No other charges other than the quoted Freight rate will be paid by BHEL excepting applicable Terminal Handling Charges, Container cleaning Charges, DO charges to Shipping Liner at Discharge Port.

8.2.6 In the event there is a delay by the Supplier in negotiating / submitting the document, any demurrage / wharfage arising out of the same shall be to the account of the Supplier and shall be deducted from the final payment. Also, in such cases, the Supplier shall authorize the Steamer / Shipping agent / transporter to freely release the consignment to BHEL by providing a "Surrender Bill of Lading". Over-seas Suppliers have to give a No-Objection Certificate to BHEL,

	<b>ELECTRO-PORCELAINS DIVISION</b>	<b>GENERAL CONDITIONS OF CONTRACT (GCC)</b> <b>Revision No. R0 (For supply and services)</b>	<b>GENERAL COMMERCIAL TERMS &amp; CONDITIONS</b>  Issued on 11.05.2017
--	------------------------------------	---	--

authorizing BHEL to get the Delivery Order from the Steamer Agent without producing the Original Bill of Lading. This is required to ensure avoidance of incidence of demurrage that may arise in case of delayed presentation of documents by the Seller.

8.3 Delivery shall be staggered in the manner as indicated in the tender for each item. Vendors shall submit their offer accordingly.

**9.0 TERMS OF PAYMENT**

**9.1 SUPPLY PACKAGES (Main Supply and Mandatory Spares)**

**9.1.1 For indigenous purchase**

Hundred percent (100%) of basic price of materials supplied, as per PO, along with 100% taxes and duties (as applicable) & freight charges, shall be paid on pro-rata basis after 45 days from the date of receipt of goods & receipt of complete documents as per order/ contract subject to acceptance of materials.

**9.1.2 For Foreign Purchase – Imports**

Hundred percent (100%) payment on CAD basis after 45 days from the date of receipt of documents specified in PO at BHEL BANK. Respective bank charges to respective account.

**9.1.3 PG TEST, INSTALLATION CHECK, SUPERVISION OF ERECTION / COMMISSIONING CHARGES**

100% payment shall be released after successful completion of the activity.

Vendors shall submit documents for payment directly to BHEL. Payment will be released within 45 days after receipt of complete documents as per order/ contract.

**Note:**

- 1) For indigenous suppliers, if the documents are routed through Bank, then all bank charges will be to vendor’s account.
- 2) Foreign bidders can opt for payment (less agency commission, if applicable) through irrevocable and unconfirmed letter of credit. In that case for evaluation purpose, prices of foreign bidders will be loaded on account of payment through LC, equal to loading specified against ‘Payment through Bank’ in Annexure-VIII. No loading will be done if foreign vendors agree for 75 days issuance LC or submit the documents on collection basis for payment within 75 days of submission of complete documents.

	<p align="center"><b>ELECTRO-PORCELAINS DIVISION</b></p>	<p align="center"><b>GENERAL CONDITIONS OF CONTRACT (GCC)</b> <b>Revision No. R0 (For supply and services)</b></p>	<p align="center"><b>GENERAL COMMERCIAL TERMS &amp; CONDITIONS</b>  Issued on 11.05.2017</p>
--	--	--	--

- 3) LC opening/ negotiation/ confirmation charges will be to vendor's account.
- 4) Any negative PVC, if not adjusted in earlier payments, will be adjusted at the time of subsequent payment.

## 9.2 DOCUMENTS TO BE SUBMITTED BY VENDOR

### 9.2.1 For Recognition of Dispatch

Copy of the following documents by e-mail/ fax immediately on despatch:

- a. Invoice
- b. LR /BL/AWB
- c. Packing List
- d. Insurance Intimation
- e. Dispatch Clearance

### 9.2.2 For Claiming Payments (under clause 9.1.1, 9.2.1, 9.3.1): (under clause 9.1.1)

- a. Original Excise Invoice & Duplicate for transporter - original+3 copies
- b. Consignee Copy of LR
- c. Packing List - clearly showing number of packages, gross weight and net weight. - original+3 copies
- d. MDCC from BHEL/Customer - as per SCC - 4 copies
- e. Guarantee Certificate - Original + 3 copies
- f. Insurance Intimation - 4 copies
- g. PVC Calculation and copy of all applicable indices, if PVC applicable. - 4 copies
- h. Duty drawback documents (original excise invoice, original disclaimer certificate, original certificate from excise authority for payment of excise duty), if applicable. - original + 3 copies

It is the responsibility of the vendor to submit invoices along with documents required for effecting payment within the stipulated period mentioned in the applicable statute for this tender. Non-submission of invoices due to delay/reasons attributable to vendor resulting in / leading to loss of tax credit for BHEL will be into vendor's account.

### (Under clause 9.1.2)

- a. Commercial Invoice - original+3 copies
- b. Original clean on board Bill of Lading or clean copy of OBL in case of Telex.
- c. Packing List - clearly showing number of packages, gross weight and net weight container wise also. - original+3 copies
- d. Delivery/ship/airplane schedule mentioning the estimated date of Arrival (ETA) at port & destination in case of CFR/CPT.

	<p align="center"><b>ELECTRO- PORCELAINS DIVISION</b></p>	<p align="center"><b>GENERAL CONDITIONS OF CONTRACT (GCC)</b>  <b>Revision No. R0 (For supply and services)</b></p>	<p align="center"><b>GENERAL COMMERCIAL TERMS &amp; CONDITIONS</b>  Issued on 11.05.2017</p>
--	---	---	--

- e. MDCC from BHEL/Customer – as per SCC – 4 copies
- f. Guarantee Certificate – Original + 3 copies
- g. Insurance Intimation - 4 copies
- h. PVC Calculation and copy of all applicable indices, if PVC applicable. – 4 copies
- i. Original Certificate of country of Origin issued by chamber of commerce.
- j. One set of original test certificates & O&M manual where called for.
- k. Fumigation certificate wherever cargo is packed in wooden packing or packing of plant origin material is used wherever called for.
- l. TUV/UL certificates where ever called for.

In case the Seller decides to negotiate all 3 originals of BL through negotiating Bank, non-negotiable documents (NND) consisting of copy of BL / HAWB & all originals at sl.no. 9.2.2 (Except OBL) will be couriered to Purchaser. Soft Copy of same documents at sl. 9.2.2 will also be sent by e-mail to the Purchaser at his e-mail address given in the PO with one copy to be mailed at [ketan@bhelepd.com](mailto:ketan@bhelepd.com) & [rb@bhelepd.com](mailto:rb@bhelepd.com). Other documents, as required, will be separately indicated in the Purchase Order.

Additional expenditure, if any, incurred by the Purchaser by way of detention / demurrage, resulting out of delay attributable to the Seller in providing negotiable documents, will be recovered from the Seller.

Note for 9.2.2            Additionally, vendor may furnish mfg clearance/drg/docs approval date etc. for the purpose of determining contractual delivery for expeditious processing of Invoices.

### 9.2.3 For Claiming Payment for Services involving Service Tax

- a. Invoice as per rule 4A of Service Tax Act – Original + 1 copy
- b. Copy of Service Tax registration certificate
- c. Copy of challan for Service Tax payment corresponding to service tax claimed in the previous invoice
- d. Certification for having carried out the work as applicable.

9.2.4 All your invoices against our order shall reach BHEL –EPD addressed to:  
HEAD OF DEPARTMENT/MATERIAL MANAGEMENT,  
BHEL – ELECTROPORCELAINS DIVISION,  
Opp. IISc, PROF. C N R RAO CIRCLE,  
MALLESWARAM, BANGALORE - 560 012

	<p align="center"><b>ELECTRO-PORCELAINS DIVISION</b></p>	<p align="center"><b>GENERAL CONDITIONS OF CONTRACT (GCC)</b> <b>Revision No. R0</b> <b>(For supply and services)</b></p>	<p align="center"><b>GENERAL COMMERCIAL TERMS &amp; CONDITIONS</b>  Issued on 11.05.2017</p>
--	--	---	--

- a. The envelope shall be super-scribed with P.O No. / W.O No., and the Bill / Invoice numbers & Contact person.
- b. Bills / invoices which are brought personally by vendors to EPD are to be dropped in the "BHEL-EPD vendor bills Box" kept near Tender Box at the Reception Office.
- c. Any additional tax implication to BHEL due to delay in submission of bills by Vendor beyond one month shall be to vendor's account.

**9.8 LOADING DETAILS IN CASE OF DEVIATIONS:-**

Loading details in respect to deviations in Payment Terms, LD, PVC indicated in Annexure - VIII.

**9.9 BHEL'S BANKERS**

List of the consortium bankers of BHEL-EPD is as per Annexure-X.

**9.10 MODE OF PAYMENT**

Payments shall be made directly to the Seller/Contractor by E-transfer. Seller/Contractor to provide necessary information for the same as per Annexure-VII.

- 9.11 No interest shall be payable by the Purchaser on the security amount, bank guarantee amount or balance payment or any money which may become due owing to difference or misunderstanding or any dispute between the Purchaser and the Contractor, or any delay on the part of Purchaser in making periodical or final payment or any other aspects incidental thereto.

**10.0 RECOVERY OF OUTSTANDING AMOUNT**

In event of any amount of money being outstanding at any point of time against the Seller/Contractor due to excess payment or any other reason whatsoever, in the present order/contract or any other order/contract from any BHEL Unit, the outstanding amount shall be recovered from the payments due to the Seller/Contractor or at any other appropriate time and manner/mode as deemed fit by the Purchaser at its sole discretion.

**11.0 CONTRACT PERFORMANCE BANK GUARANTEE**

- 11.1 No Bank Guarantee is required where original Order/ Contract value is up to Rs. 25 Lakhs (excluding taxes, duties and freight).
- 11.2 For original order / contract values above Rs. 25 Lakhs (excluding taxes, duties and freight), only if specified in SCC, the vendor shall submit Contract Performance

	<b>ELECTRO-PORCELAINS DIVISION</b>	<b>GENERAL CONDITIONS OF CONTRACT (GCC)</b> <b>Revision No. R0 (For supply and services)</b>	<b>GENERAL COMMERCIAL TERMS &amp; CONDITIONS</b> Issued on 11.05.2017
--	------------------------------------	---	--

Bank Guarantee within 10 days from the date of LOI/LOA (as per Annexure-IV) for 10% of Order/ Contract value (excluding taxes, duties & freight) to cover the due performance of Order/ Contract and to fulfill the guarantee conditions stipulated in the Order/ Contract. However, BG value can be proportionality reduced after completion of Guarantee period Unit-wise/ Lot-wise/ Set-wise, as applicable.

- 11.3 In case the order is to be placed in foreign currency, the BG must also be in foreign currency, so specified by the Purchaser. Foreign vendors seeking payment through Letter of Credit (LC) should submit the Bank Guarantee before LC opening.
- 11.4 Value of the Bank Guarantee (at the time of submission) shall remain unchanged for any subsequent variations in order/ contract value up to 20%. Beyond this, the Seller/ Contractor shall arrange to enhance or reduce the value of the Bank Guarantee accordingly.
- 11.5 Validity of the Bank Guarantee shall be for the entire Guarantee period + 3 months claim period. Initially, it should be at least 18 months + 3 months claim period, later extended to cover the entire guarantee period, two months before its expiry.
- 11.6 Purchaser reserves the right to encash the bank guarantee and forfeit the amount in the event of any default, failure or neglect on part of the Seller/ Contractor in fulfillment of performance of the Order/ Contract.
- 11.7 Equivalent amount shall be recovered from payment due to the Seller/ Contractor, before releasing any payment, in absence of a valid bank guarantee.
- 11.8 Bank Guarantees shall be from Consortium Bank as per Annexure-X. Bank guarantees from cooperative banks/ non-scheduled banks are not acceptable.
- 11.9 In case of private sector banks, a clause to be incorporated in the text of bank guarantee that it can be enforced by being presented at any branch of the bank located in Bangalore.
- 11.10 Two witness signatures from bank officials, other than the bank official who has already signed is a must. BG is to be submitted directly by the issuing bank to concerned purchase officer, under registered post (A/D).
- 11.11 The Bank Guarantee to be provided in the hard and not in the SFMS format". Our bank details are as follows:

**Name of Site/division:** BHEL EPD

**Name of Bank:** IDBI BANK, SPECIALIZED CORPORATE BRANCH

	<b>ELECTRO- PORCELAINS DIVISION</b>	<b>GENERAL CONDITIONS OF CONTRACT (GCC)</b>  <b>Revision No. R0 (For supply and services)</b>	<b>GENERAL COMMERCIAL TERMS &amp; CONDITIONS</b>  Issued on 11.05.2017
--	---	---	--

**Branch Address:** 102, SHAKTHI COMFORT TOWER,  
KH ROAD, BANGALORE- 560027

PH NO 67121025

KIND ATTN: Mr. MANMOHAN SOMA

ALT: Mrs. VP SHIVA SHAKTI

PH NO 67121059.

**Branch IFSC Code:** IBKL0000377

**Account No:** 008103000003605

11.12 Wherever the contract is for supply of Goods processed on labour basis from BHEL supplied materials, the materials shall be issued against a suitable Bank guarantee as specified in the Enquiry.

## **12.0 GUARANTEE FOR PLANT/EQUIPMENT/ STORES**

12.1 Seller/ Contractor shall warrant that the stores supplied shall be free from all defects and faults in design & engineering, material, workmanship & manufacture and shall be of the highest grade and consistent with the established and generally accepted standards and in full conformity with the Order/ Contract specifications, drawing or samples, if any.

12.2 Guarantee period for **Supply** shall be eighteen (18) months from the date of last dispatch or as per SCC whichever is later.

12.3 All replacements and repairs during the guarantee period shall be delivered and completed promptly and satisfactorily within a period of one months from the time of reporting the defect/ loss/ rejection etc or any mutually agreed period without prejudice to purchaser's other legal rights. If the Seller/ Contractor so desires and the Purchaser agrees, subject to import control regulations, the replaced parts can be taken over by Seller/ Contractor or his representative or can be dispatched at Seller/ Contractor's cost. No claim, whatsoever shall be entertained by Purchaser on account of such replaced parts.

12.4 All the replaced and replenished stores shall also be guaranteed as per above clauses.

12.5 Decision of Purchaser with regard to Seller/ Contractor's liability and the amount involved, if any, payable by Seller/ Contractor under the guarantee shall be final, conclusive and binding. However, vendor's maximum liability will be limited to the total contract value including taxes, duties and freight.

## **13.0 DELIVERY / COMPLETION SCHEDULE**

	<b>ELECTRO-PORCELAINS DIVISION</b>	<b>GENERAL CONDITIONS OF CONTRACT (GCC)</b> <b>Revision No. R0 (For supply and services)</b>	<b>GENERAL COMMERCIAL TERMS &amp; CONDITIONS</b> Issued on 11.05.2017
--	------------------------------------	---	--

13.1 Supply of plant/equipment/stores shall not be considered complete until they have been inspected and accepted at the place and destination specified for delivery by the time stipulated under the terms & conditions of the Order/Contract. Mere payment by itself shall not constitute acceptance of the goods or materials in any manner, whatsoever.

13.2 Vendor shall strictly adhere to delivery schedule. In case of non compliance to agreed schedules / milestones, then it would be presumed that vendor / contractor is not fulfilling contractual obligations. BHEL reserves the right to take suitable action like operating "Risk & cost clause".

**14.0 INSPECTION AND TESTING AT CONTRACTOR'S PREMISES**

14.1 Purchaser's nominated Inspection Agency shall have at all reasonable times access to Seller/ Contractor's premises or works and shall have the power at all reasonable times to inspect drawings of any portion of the work or examine the materials and workmanship of the stores during their manufacture, and if part of the stores is manufactured at other premises, the Seller/Contractor shall arrange for inspection, examination and testing by the Inspection Agency as if the store is manufactured on the Seller/Contractor's premises.

Inspection calls should be given adequate notice of one week or as mutually agreed period in advance in writing to the purchaser about the date & place where goods will be ready for inspection & testing, as provided for in the contract.

Such inspection, examination and testing by itself shall not relieve the Seller/Contractor from any obligation under the Order/Contract.

14.2 Seller/Contractor shall give Inspection Agency reasonable notice of any material being ready for testing and the Inspection Agency shall (unless the inspection of tests is voluntarily waived) attend at the Seller/Contractor's premises within fifteen (15) days of the date on which the material is notified as being ready. All standard shop tests, physical and chemical tests required by the standards or as may be prescribed or approved as per Order/ Contract shall be conducted by the Seller/Contractor. Purchaser/Inspection Agency reserves the right to waive any of the above tests requirements and to prescribe new tests, if found necessary, to complete the work so as to conform to the best practices. Seller/Contractor shall forthwith forward to the Inspection Agency, duly certified copies of the test certificates in quadruplicate, for approval. Further copies of the shop test certificates shall be bound with the instruction manuals referred to in "Seller/Contractor's documents, drawings and instruction manuals".

	<b>ELECTRO-PORCELAINS DIVISION</b>	<b>GENERAL CONDITIONS OF CONTRACT (GCC)</b> <b>Revision No. R0</b> <b>(For supply and services)</b>	<b>GENERAL COMMERCIAL TERMS &amp; CONDITIONS</b>  Issued on 11.05.2017
--	------------------------------------	---	--

14.3 Where the Order/Contract provides for tests/inspections at the premises or works of the Seller/Contractor or any sub-contractor, the Seller/Contractor, except specified otherwise, shall provide free of charge such assistance, labour, materials, electricity, fuel, water, stores, apparatus, measuring instruments and test equipment including any other facilities as may be reasonably required to carry out such tests efficiently. In case of inspection by BHEL or BHEL CUSTOMER, the cost of to & fro passage and boarding & lodging shall be borne by purchaser/customer, unless otherwise specifically agreed. In case of foreign vendors the cost of third party inspection, where called for shall be deemed to be included in the quoted price.

14.4 Inspection calls shall be addressed to BHEL-EPD Purchase Department irrespective of inspection categories.

**14.5 INSPECTION MEASURING AND TEST EQUIPMENTS**

14.5.1 Inspection Measuring and Test Equipments (IMTE) whether used by the Seller/Contractor or sub-contractor shall be calibrated, maintained and controlled. Calibration shall be valid and IMTE maintained in sound condition during usage.

14.5.2 In addition to above, Seller/ Contractor shall ensure the following :

- a) Measurement uncertainty is known and consistent with required measurement capability of the IMTE.
- b) Selection of IMTEs is compatible with the necessary accuracy and precision of required measurement.
- c) IMTEs are calibrated at the required intervals against certified equipments having known valid relationship to nationally recognized standards, at recognized calibration labs.
- d) Calibration records are available and traceable to the particular IMTE.
- e) In case, during recalibration, the IMTE is found out of calibration, report on action taken to validate the previous results along with both calibration records of the IMTE to be furnished to Inspection Agency.
- f) IMTEs are stored, handled and preserved such that accuracy and fitness are maintained and safeguarded from adjustments.

NOTE: Purchaser's decision on acceptability of the product in such cases shall be binding.

14.5.3 Responsibility of usage of valid and calibrated IMTEs by his sub-contractor(s) shall be of the Seller/ Contractor.

	<p align="center"><b>ELECTRO- PORCELAINS DIVISION</b></p>	<p align="center"><b>GENERAL CONDITIONS OF CONTRACT (GCC)</b>  Revision No. R0 (For supply and services)</p>	<p align="center"><b>GENERAL COMMERCIAL TERMS &amp; CONDITIONS</b>  Issued on 11.05.2017</p>
--	---	--	--

14.5.4 In case, calibration records are required by purchaser, copies of the same shall be furnished.

14.6 Seller/Contractor shall be fully responsible for the Quality of products supplied by sub-contractors.

**15.0 MATERIAL DESPATCH CLEARANCE CERTIFICATE (MDCC)**

15.1 When the tests have been satisfactorily completed at Seller/Contractor's works, the Inspection Agency shall issue a certificate to that effect within fifteen (15) days after completion of the tests, but if the tests were not witnessed by the Inspection Agency or his representative, the certificate would be issued within fifteen (15) days after receipt of the test certificates by the Purchaser.

15.2 Purchaser/Owner will issue MDCC to the Seller/Contractor based on inspection report/ test certificates.

15.3 No item / equipments shall be dispatched without obtaining Material Dispatch clearance certificate from BHEL-EPD Purchase Department irrespective of inspection categories.

15.4 Satisfactory completion of tests or issue of MDCC shall not bind the Purchaser/Owner to accept the supply/ equipment should it, on further tests after erection, be found not to comply with the contract provisions.

**16.0 DELIVERY FAILURE AND TERMINATION/LIQUIDATED DAMAGES**

16.1 Timely dispatch/delivery and completion of other schedules as stipulated in Order/Contract shall be the essence of Order/Contract. If the Seller/Contractor fails to complete the dispatch/delivery and other schedules within the time period stipulated in Order/Contract, or within any extension of time granted by Purchaser, it shall be lawful for Purchaser to recover damages for breach of Order/Contract without prejudice to any other rights and/or remedies provided for, in the Order/Contract and hereunder. For any delay not attributable to the Seller/Contractor, the Seller/Contractor must report the same to Purchaser immediately.

**16.2 DELAYED DELIVERY**

16.2.1 Purchaser reserves the right to recover from the Seller/Contractor, as agreed liquidated damages and not by way of penalty, a sum equivalent to half (½) percent of the total contract price per week or part thereof, subject to a maximum of ten (10) percent of the total contract price excluding elements of taxes, duties and freight, if

	<p align="center"><b>ELECTRO-PORCELAINS DIVISION</b></p>	<p align="center"><b>GENERAL CONDITIONS OF CONTRACT (GCC)</b> <b>Revision No. R0 (For supply and services)</b></p>	<p align="center"><b>GENERAL COMMERCIAL TERMS &amp; CONDITIONS</b>  Issued on 11.05.2017</p>
--	--	--	--

the Seller/ Contractor fails to deliver ordered stores within the period stipulated in the Order/Contract.

However, In case of staggered delivery schedule, the LD shall be half (1/2) percent of the undelivered portion per week or part thereof, subject to a maximum of ten (10) percent of the contract price **excluding** elements of taxes, duties and freight, if the Seller/ Contractor fails to deliver any part of the ordered stores within the period stipulated in the Order/Contract.

NOTE:

1. LR/ RR date for indigenous supplies and AWB/ BL date for FOB/CIF/CIP/CFR/CPT contracts shall be treated as the date of dispatch for levying LD as per Clause 16.
2. In case of any amendment/revision, LD shall be linked to the amended/ revised contract value and delivery date(s).
3. If Order/ Contract involves two or more Units/ Sets/ Lots, then Liquidated Damages shall be for order/ contract value of the delayed Unit/ Set/ Lot, provided delivery stipulated in the Order/ Contract is Unit/ Set/ Lot wise, however total LD amount shall be limited to 10% of total order value. (excluding taxes, duties and freight)

16.2.2 Purchaser reserves the right to purchase from elsewhere on account of and at the risk and cost of Seller/Contractor, with notice to Seller/Contractor, the stores due for delivery but not so delivered, or their equivalent without cancelling the Order/Contract in respect of stores not yet due for delivery. The manner and method of such purchase shall be at the discretion of the Purchaser. The actual excess cost incurred for such purchases will be recovered from the bidder.

16.2.3 Purchaser reserves the right to cancel the Order/Contract or a portion thereof for the stores not so delivered at the risk and cost of the Seller/Contractor and the Seller/Contractor shall be liable to the Purchaser for any excess cost thereof. The actual excess cost incurred for such purchases will be recovered from the bidder.

16.2.4 Seller/Contractor shall continue performance of the Order/Contract, under all circumstances, to the extent not cancelled.

**17.0 INSURANCE**

17.1 Insurance shall be arranged by BHEL.

	<p align="center"><b>ELECTRO-PORCELAINS DIVISION</b></p>	<p align="center"><b>GENERAL CONDITIONS OF CONTRACT (GCC)</b> <b>Revision No. R0 (For supply and services)</b></p>	<p align="center"><b>GENERAL COMMERCIAL TERMS &amp; CONDITIONS</b>  Issued on 11.05.2017</p>
--	--	--	--

17.2 Vendors shall inform the Underwriters, appointed/ nominated by BHEL/ Purchaser, the details of dispatches under intimation to BHEL such as LR No./BL/AWB and date, Truck No./vessel details/flight details, P.O. No. and value.

17.3 Insurance as applicable for field work such as third party liability, workmen compensation, Seller/Contractor's own Tools & Plants and automobile shall be arranged by the Seller/ Contractor.

**18.0 INTER-CHANGEABILITY AND CHANGES**

18.1 All similar components or parts of similar equipment supplied by Seller/Contractor shall be interchangeable with one another.

18.2 Even though all the work and materials necessary for satisfactory completion of the works may not be detailed in the specifications and schedules, the cost will be considered to be within the contract price and no extra charges shall be payable. However, if there are substantial changes in the specifications of the stores/plant, consequential changes in prices shall be mutually agreed between Purchaser and Seller/Contractor.

**19.0 PACKING AND DISPATCH MARKING**

19.1 Packing shall be in conformity with specifications and shall be such as to ensure prevention of damages, corrosion, deterioration, shortages, pilferage and loss in transit or storage.

19.2 In case of shipment by sea, the packing shall be sea-worthy and of international standards.

19.3 Packing List shall be submitted as per standard format along with advance set of documents for claiming payment which shall also indicate:-

- a) Packing size.
- b) Gross weight and net weight of each package.
- c) Contents of the package with quantity of each item separately.

19.4 The number of each package in a shipment shall be shown in fraction, numerator showing number of the package and the denominator showing total number of packages in a lot I consignment. The packages number shall be generally prepared in the sequence in which they will be required for erection.

19.5 Each package delivered under the Contract shall be marked by and at the expense of the supplier and such marking must be distinct and in English language (all previous irrelevant markings being carefully obliterated). Such marking shall

	<b>ELECTRO-PORCELAINS DIVISION</b>	<b>GENERAL CONDITIONS OF CONTRACT (GCC)</b> <b>Revision No. R0</b> <b>(For supply and services)</b>	<b>GENERAL COMMERCIAL TERMS &amp; CONDITIONS</b>  Issued on 11.05.2017
--	------------------------------------	---	--

show the description and quantity of contents, the name and address of consignee. the gross weight and net weight of the package, the name of the Contractor with a distinctive number of mark sufficient for purposes of identification. All markings shall be carried out with such materials as to ensure quickness of drying. fastness and indelibility. Each equipment or parts of equipment shall, when shipped or railed or otherwise dispatched be tagged with reference to the assembly drawings and corresponding part numbers. Each bale or package shall contain a packing note quoting specifically the name of the Contractor, the number and date of contract and the name of the office placing the contract, nomenclature of the stores and include a schedule of parts for each complete equipment giving the part numbers with reference to the assembly drawing and the quantity of each part, drawings nos. and tag numbers.

- 19.6 Besides wherever necessary, packing shall bear a special marking " TOP", " BOTTOM", "DO NOT TURN OVER", "KEEP DRY", "HANDLE WITH CARE".etc.
  - 19.7 All packing cases, containers (excluding marine container), packing and other similar materials shall be new.
  - 19.8 Notwithstanding anything stated in this clause, the Contractor shall be entirely responsible for loss, damage or depreciation or deterioration to the materials & supplies due to faulty and/or insecure packing.
  - 19.9 Each and every package box shall be marked with the following, as a minimum:
    - (i). Name and address of Consignee:
    - (ii). Project reference:
    - (iii). Contract No.:
    - (iv). Packing No.: (1110. 2110, 3110 ..... when there are 10 packages For one consignment)
    - (v). Net Weight/Gross Weight:
    - (vi). Port of Loading:
    - (vii). Destination Port
    - (viii). Packing Mark: [symbols indicating "TOP" and other special markings as indicated above.
    - (ix). Type of Equipment:
- "E" (for Equipment supply)

	<b>ELECTRO-PORCELAINS DIVISION</b>	<b>GENERAL CONDITIONS OF CONTRACT (GCC)</b> <b>Revision No. R0</b> <b>(For supply and services)</b>	<b>GENERAL COMMERCIAL TERMS &amp; CONDITIONS</b>  Issued on 11.05.2017
--	------------------------------------	---	--

"T" (for Tools & Tackles)

"S" (for Mandatory Spares)

#### 19.10 PACKING FOR SPARES

19.10.1 The commissioning spares shall be properly packed separately in separate box and each spare shall be properly tagged giving details (to match the description given in the packing slip) to facilitate their proper identification. Three copies of packing list is to be kept inside the box and one copy in a special packet at the outer side of the Box.

19.10.2 The Mandatory spares shall be properly packed separately in separate box indicating Mandatory Spares in bold letters and each spare shall be properly tagged giving details i.e. item number of the equipment in line with the Ultimate Customer/Owner Contract & Number per item (to match the description given in the packing slip) to facilitate their proper identification by ultimate Customer/Owner. Three copies of packing list along with Manufacturing drawing no. Reference. Catalogue reference etc. is to be kept inside the box and one copy in a special packet at the outer side of the Box.

#### 20.0 STORAGE INSTRUCTIONS

Successful tenderer shall be required to submit detailed instructions for storage of supplies within two weeks of date of issue of LOI/ Order/ Contract.

#### 21.0 MATERIAL/GOODS RECEIPT CERTIFICATE

Seller/Contractor shall arrange Material/Goods Receipt Certificate from the consignee, duly signed by Purchaser/Owner Site Engineer after receipt & physical verification of the material, wherever E&C is in the scope of Seller/ Contractor.

For Supplies, Material/Goods Receipt Certificate shall be arranged by BHEL. Vendor to provide copy of receipted LRs to enable BHEL to obtain MRC from site.

#### 22.0 CONSIGNEE'S RIGHT OF REJECTION

22.1 Notwithstanding any approval of Purchaser or Engineer in respect of stores or materials or other particulars or work or workmanship involved in performance of order/contract (with or without any test carried out by Seller/Contractor or Inspection Agency or under direction of Contract Engineer), and notwithstanding delivery of the stores where so provided to the consignee, it shall be lawful for the consignee, on behalf of the Purchaser, to reject the stores or any part/ portion of consignment thereof, within 30 days after actual delivery at the stipulated place or

	<p align="center"><b>ELECTRO-PORCELAINS DIVISION</b></p>	<p align="center"><b>GENERAL CONDITIONS OF CONTRACT (GCC)</b> <b>Revision No. R0 (For supply and services)</b></p>	<p align="center"><b>GENERAL COMMERCIAL TERMS &amp; CONDITIONS</b>  Issued on 11.05.2017</p>
--	--	--	--

destination, if such stores or part/ portion of consignment thereof is not in conformity with terms and conditions of order/contract whether on account of any loss, storage, deterioration or damage before despatch or otherwise, whatsoever.

22.2 Rejected goods or materials shall be removed by Seller/Contractor within a period of 15 days from the date of receipt of notice of such rejection. The expenses to be incurred in respect thereof shall be borne entirely by the Seller/Contractor.

**23.0 RISK IN STORES (FOR E&C CONTRACTS)**

Seller/ Contractor shall perform the order/ contract in all respects in accordance with terms and conditions thereof. Stores and every constituent part thereof, whether in possession or control of the Seller/Contractor, his agents or servants, or a carrier, or in joint possession of Seller/ Contractor, his agent or servants and Purchaser, his agents or servants, shall remain in every respect at the risk of Seller/Contractor until their actual delivery to consignee at the stipulated place or destination or where so provided in acceptance of offer, until their delivery to a person specified by Purchaser as interim consignee for the purpose of despatch to the consignee. Seller/Contractor shall be solely responsible for all losses, destructions, damages or deterioration to the stores from any cause whatsoever, while the stores await dispatch after approval by the Inspection Agency.

**24.0 SHORTAGES/DAMAGES**

**24.1 FOR SUPPLY PACKAGES**

- a) Shortages in sound cases shall be replenished free of cost by the vendor, as early as possible.
- b) For shortages/damages during transit/ handling at site, vendor shall supply replacements, as early as possible, at the old contractual rates upon intimation to vendor within one months of receipted LR.

**24.2 FOR E&C PACKAGES**

Any shortages or damages during unloading and handling at site, including at the time of erection and commissioning, shall be made good by the Seller/ Contractor at his risk and cost, to meet the project schedule. In case of faults/ discrepancies in any material, component, sub-assembly, assembly, etc., the same shall be supplied/replenished free of cost to enable the equipment to be put to service.

**25.0 CONFIDENTIALITY**

Seller/Contractor shall, at all times, undertake to maintain complete confidentiality of all data, information, software, drawings & documents, etc. belonging to the

	<p align="center"><b>ELECTRO-PORCELAINS DIVISION</b></p>	<p align="center"><b>GENERAL CONDITIONS OF CONTRACT (GCC)</b> <b>Revision No. R0 (For supply and services)</b></p>	<p align="center"><b>GENERAL COMMERCIAL TERMS &amp; CONDITIONS</b> Issued on 11.05.2017</p>
--	--	--	---

Purchaser and also of systems, procedures, reports, input documents, manuals, results and any other company documents discussed and/or finalised during the course of execution of order/contract.

**26.0 DEFAULT/BREACH OF CONTRACT, INSOLVENCY AND RISK PURCHASE**

26.1 If Seller/Contractor fails to deliver goods or materials or any installment thereof within the period(s) fixed for such delivery or delivers goods or materials not of the contracted quality and failing to adhere to the contract specifications or at any time repudiates or otherwise abandons the contract before expiry of such period or refuses or is unable to supply goods or materials covered by the Order/Contract either in whole or in part or otherwise fails to perform the Order/Contract or commits any breach of Order/Contract not herein specifically provided for or in the event of the death or insanity or if the Seller/Contractor being an individual or if a firm on a partnership thereof, shall at any time, be adjudged insolvent or shall have a receiving order for administration of his estate made against him or shall take any proceeding for composition under any Insolvency Act for the time being in force or make any assignment of the Order/Contract or enter into any arrangement or composition with his creditors or suspend payment or if the firm is dissolved under the Partnership Act or if the Seller/Contractor being a company is wound up voluntarily or by order of a Court or a Receiver, Liquidator or Manager on behalf of the debenture holders and creditors is appointed or circumstances shall have arisen which entitles the Court of debenture holder and creditors to appoint a receiver, liquidator or manager, the purchaser without prejudice to his right to recover any expenses, losses or damages to which the Purchaser may be put to incur or sustain by reason of Seller/Contractor's default or breach of Order/Contract, Purchaser shall be entitled to cancel the Order/Contract either in whole or portion thereof without compensation to Seller/Contractor and if the Purchaser so desires, may procure upon such terms and in such manner as deemed appropriate, stores not so delivered or others of similar description where stores exactly complying with particulars are not, in the opinion of the Purchaser, which shall be final, readily procurable, at the risk and cost of the Seller/Contractor and the Seller/Contractor shall be liable to the Purchaser for any excess costs provided that the Seller/Contractor shall continue the performance of the Order/Contract to the extent not cancelled under the provisions of this clause. The Seller/Contractor shall on no account be entitled to any gain on such repurchases.

Except for Clause 26.2, vendor's maximum liability will be limited to the total contract value including taxes, duties and freight.

	<p align="center"><b>ELECTRO-PORCELAINS DIVISION</b></p>	<p align="center"><b>GENERAL CONDITIONS OF CONTRACT (GCC)</b> <b>Revision No. R0 (For supply and services)</b></p>	<p align="center"><b>GENERAL COMMERCIAL TERMS &amp; CONDITIONS</b>  Issued on 11.05.2017</p>
--	--	--	--

26.2 Recovery on account of purchases made by Purchaser at the risk and cost of Seller/ Contractor shall be worked out as follows:

Excess of new purchase cost over old purchase cost, where the total value of new PO is more than total value of old PO.

**27.0 TERMINATION OF CONTRACT**

27.1 Purchaser shall have the right to cancel Order/Contract, wholly or in part, in case they are obliged to do soon account of any decline, diminution, curtailment or stoppage of their business and in that event, the Seller/Contractor compensation claim shall be settled mutually.

27.2 Purchaser shall have the right to cancel order/contract at the risk and cost of Seller/Contractor in case either the Seller/Contractor himself or any of his representative or agent is found to have been a previous employee of the Purchaser immediately before retirement and has within a period of two years of such retirement accepted the employment of the Seller/Contractor either as a Seller/Contractor or as an employee without having obtained prior permission of Purchaser.

27.3 In case of cancellation of main supply order/ contract, all other associated orders/ contracts like mandatory spares/ recommended spares/ E&C/ supervision of E&C would also get cancelled.

**28.0 TRANSFER, SUB-LETTING/ASSIGNMENT/SUB-CONTRACTING**

28.1 Seller/Contractor shall not sublet, transfer or assign order/contract or any part thereof or interest therein or benefit or advantage thereof save without the prior consent in writing of Purchaser. In the event of Seller/Contractor sub-letting, transferring or assigning order/contract or any part thereof or interest therein or benefit or advantage thereof without such permission, the Purchaser shall be entitled to cancel the Order/Contract and to purchase the stores from elsewhere at risk and costs of Seller/Contractor and the Seller/Contractor shall be liable for any loss or damage which Purchaser may sustain in consequence of or arising out of such risk purchase.

28.2 If Seller/Contractor is an individual or proprietary concern and the individual or the proprietor dies or the partnership is dissolved or substantially affected, then unless the Purchaser is satisfied that legal representative of individual seller/contractor or proprietor of proprietary concern and surviving partners of partnership firm are capable of carrying out and completing the order/contract, the Purchaser shall be entitled to cancel the order/ contract as to its incomplete portion

	<p align="center"><b>ELECTRO-PORCELAINS DIVISION</b></p>	<p align="center"><b>GENERAL CONDITIONS OF CONTRACT (GCC)</b> <b>Revision No. R0 (For supply and services)</b></p>	<p align="center"><b>GENERAL COMMERCIAL TERMS &amp; CONDITIONS</b>  Issued on 11.05.2017</p>
--	--	--	--

and without being in any way liable to payment of any compensation to estate of seller/contractor and/or to surviving partners of seller's/contractor's firm on account of cancellation of the order/contract.

- 28.3 Decision of Purchaser that legal representatives of deceased seller/contractor or surviving partners of the seller's/contractor's firm can not carry out and complete the order/contract shall be final and binding on the parties hereto.
- 28.4 Terms and Conditions shall not get affected in case of merger/amalgamation/takeover/re-arrangement etc.

**29.0 FORCE MAJEURE**

- 29.1 Notwithstanding anything contained in Clause 13.0, if at any time during the continuance of the Order/Contract, the performance in whole or in part by either party of any obligations under the Order/Contract shall be prevented or delayed by reason of any war hostilities, acts of the public enemy, restrictions by Govt. of India, civil commotion, sabotage, fires, floods, explosion, epidemics, quarantine restrictions, strike, lock-outs, or acts of God (hereinafter referred to as 'event'), then, provided notice of the happening of such event is given by either party to the other within fifteen (15) days from the date of occurrence thereof, neither party shall by reason of such event be entitled to terminate the Order/Contract nor shall have any claim for damages against each other in respect of such non-performance and delay in performance. Performance under the Order/Contract shall be resumed immediately after such event has come to an end or ceased to exist and decision of Purchaser as to whether the deliveries have to be resumed or not shall be final, conclusive and binding on the parties hereto.
- 29.2 In the event of the parties hereto not able to agree that a force majeure event has occurred, the parties shall submit the disputes for resolution pursuant to the provisions hereunder, provided that the burden of proof as to whether a force majeure event has occurred shall be upon the party claiming such an event.
- 29.3 Notwithstanding the above provisions, Purchaser shall reserve the right to cancel the Order/Contract, wholly or partly, in order to meet the overall schedule and make alternative arrangements for completion of delivery and other schedules.

**30.0 INDEMNIFICATION**

Seller/Contractor shall fully indemnify and keep indemnified the Purchaser against all claims of whatsoever nature arising during the course and out of the execution of this Order/Contract.

	<p align="center"><b>ELECTRO- PORCELAINS DIVISION</b></p>	<p align="center"><b>GENERAL CONDITIONS OF CONTRACT (GCC)</b>  Revision No. R0 (For supply and services)</p>	<p align="center"><b>GENERAL COMMERCIAL TERMS &amp; CONDITIONS</b>  Issued on 11.05.2017</p>
--	---	--	--

### **31.0 SETTLEMENT OF DISPUTES**

- 31.1 Except as otherwise specifically provided in the Order/Contract, all disputes concerning questions of the facts arising under the Order/Contract, shall be decided by Purchaser, subject to written appeal by the Seller/Contractor to the Purchaser, whose decision shall be final.
- 31.2 Any dispute or difference shall be, to the extent possible, settled amicably between the parties hereto, failing which the disputed issues shall be settled through arbitration.
- 31.3 Seller/Contractor shall continue to perform the order/contract, pending settlement of dispute(s).

### **32.0 ARBITRATION & CONCILIATION**

- 32.1 Except as provided elsewhere in this Contract, in case amicable settlement is not reached between the parties, in respect of any dispute or difference; arising out of the formation, breach, termination, validity or execution of the Contract; or, the respective rights and liabilities of the parties; or, in relation to interpretation of any provision of the contract; or, in any manner touching upon the Contract, then, either party may, by a notice in writing to the other party refer such dispute or difference to the sole arbitration of an arbitrator appointed by head of the BHEL Unit/Region/Division issuing the Contract.
- 32.2 The Arbitrator shall pass a reasoned award and the award of the Arbitrator shall be final and binding upon the parties.
- 32.3 Subject as aforesaid, the provisions of arbitration and conciliation act 1996 (India) or statutory modifications or re-enactments thereof and the rules made thereunder and for the time being in force shall apply to the arbitration proceedings under this clause. The seat of arbitration shall be **Bangalore**. The cost of arbitration shall be borne as per the award of the Arbitrator.
- 32.4 Subject to the arbitration in terms of Clause 32.0 above, the Courts at **Bangalore** shall have exclusive jurisdiction over any matter arising out of or in connection with this Contract.
- 32.5 Notwithstanding the existence or any dispute or differences and/or reference for the arbitration, the Contractor shall proceed with and continue without hindrance the performance of its obligations under this contract with due diligence and expedition in a professional manner except where the contract has been terminated by either party in terms of this Contract.

	<p align="center"><b>ELECTRO- PORCELAINS DIVISION</b></p>	<p align="center"><b>GENERAL CONDITIONS OF CONTRACT (GCC)</b>  Revision No. R0 (For supply and services)</p>	<p align="center"><b>GENERAL COMMERCIAL TERMS &amp; CONDITIONS</b>  Issued on 11.05.2017</p>
--	---	--	--

**32.6 In case of contract with public sector enterprise (PSE) or a government Department, the following shall be applicable:**

In the event of any dispute or difference relating to the interpretation and application of the provisions of the Contract, such dispute or difference shall be referred by either party for arbitration to the sole arbitrator in the Department of public Enterprises to be nominated by the secretary to the government of India in-charge of the Department of public enterprises. The arbitration and Conciliation act, 1996 shall not be applicable to arbitration under this clause the award of the arbitrator shall be binding upon the parties to the dispute, provided, however, any party aggrieved by such award may make further reference for setting aside or revision of the award to the law secretary, department of legal affairs, Ministry of law and justice, Government of India. Upon such reference the dispute shall be decided by the law secretary or the special secretary or Additional secretary when so authorized by the law secretary, whose decision shall bind the parties hereto finally and conclusively. The parties to the dispute will share equally the cost of arbitration as intimated by the Arbitrator.”

**33.0 LAWS GOVERNING THE CONTRACT**

Contract, including all matters connected with contract, shall be governed by the Indian Law, both substantive and procedural, for the time being in force including modification thereto, and shall be subject to the exclusive jurisdiction of the Indian courts at Bangalore.

**34.0 JURISDICTION OF COURT**

Courts at Bangalore shall have exclusive jurisdiction to decide the dispute, if any, arising out of or in respect of the contract(s) to which these conditions are applicable.

**35.0 ORDER OF PRECEDENCE**

In the event of any ambiguity or conflict between the Tender Documents, the order of precedence shall be in the order below:

1. Amendments/Clarifications/Corrigenda/Errata etc issued in respect of the tender documents by BHEL.
2. Notice Inviting Tender (NIT)
3. Price Schedule

	<p align="center"><b>ELECTRO- PORCELAINS DIVISION</b></p>	<p align="center"><b>GENERAL CONDITIONS OF CONTRACT (GCC)</b>  Revision No. R0 (For supply and services)</p>	<p align="center"><b>GENERAL COMMERCIAL TERMS &amp; CONDITIONS</b>  Issued on 11.05.2017</p>
--	---	--	--

4. Special Conditions of Contract (SCC)
5. Technical specification & scope of work
6. General Conditions of Contract (GCC)

**36.0 SUPPLIER PERFORMANCE MONITORING AND RATING SYSTEM**

Seller/Contractor's performance will be evaluated as per Supplier Performance Monitoring and Rating System of BHEL. Please refer BHEL website [www.bhel.com](http://www.bhel.com) for details.

**37.0 DEALING WITH BANNED SUPPLIERS/ CONTRACTORS IN BHEL**

Offers of the bidders who are on the banned list, as also the offers of the bidders who engage the services of the banned firms, shall be rejected. The list of banned firms is available on BHEL website [www.bhel.com](http://www.bhel.com).

ANNEXURE No.	DESCRIPTION
I	OFFER SUBMISSION AS PER NIT
II	DEVIATION SHEET COST OF WITHDRAWAL)
III	DECLARATION
IV	CONTRACT PERFORMANCE BANK GUARANTEE
V	GUIDELINES FOR FOREIGN SUPPLIERS AND INDIAN AGENTS OF FOREIGN SUPPLIERS
VI	REQUEST FOR ISSUE OF FORM-C
VII	NEFT DETAILS
VIII	LOADING CRITERA
IX	INTEGRITY PACT
X	LIST OF CONSORTIUM BANKS
XI	REVERSE AUCTION GUIDLINES
XII	NO DEVIATION FORMAT
XIII	AUTHORISED SIGNATORY
XIV	FORMAT FOR POWER OF ATTORNEY
XV	RAB FORMAT FOR E&C
XVI	INDEMNITY BOND
XVII	CONSORTIUM AGREEMENT
XVIII	VENDOR PARTICULARS & LOGISTICS INFORMATION
XIX	NON DISCLOSURE AGREEMENT
XX	

**ANNEXURE-I**

(To be filled up by the Bidder)

Ref. No.:  
M/s Bharat Heavy Electricals Ltd.,  
Electroporcelains Division  
Prof. CNR Rao Circle  
Malleshwaram  
Bangalore - 560012

Date :

Attention : Shri

Dear Sir,

- 1 Having examined the tender documents against your tender Enquiry No \_\_\_\_\_ dated \_\_\_\_\_ and having understood the provisions of the said tender documents and having thoroughly studied the requirements of BHEL related to the work tendered for, in connection with \_\_\_\_\_ (name of work & project site), we hereby submit our offer for the proposed work in accordance with terms and conditions mentioned in the tender documents, at the prices quoted by us in your price schedule format and as per the indicated delivery schedule.
2. If the work or any part thereof is awarded to us, we undertake to submit security-cumcontract performance bank guarantee as per your requirement.
3. We have annexed to this tender the following documents:-  
**Part-I (Techno Commercial Bid)** - in a properly sealed cover (uploaded in website in case of e-procurement).
  - a) Complete Techno-Commercial Offer.
  - b) Un-priced copy of deviation sheet (cost of withdrawal) – Annexure-II
  - c) Un-priced copy of Price Schedule using format given by BHEL.
  - d) Any other documents (please specify).

**Part-II (Price Bid along with Priced Annexure-II)** - in a separate, properly sealed cover, in the format given by BHEL (uploaded in website in case of e-procurement).

Thanking you,

Yours faithfully,

(Signature of the bidder with Name, Designation and Company's Seal)

**ANNEXURE - III**

**DECLARATION**

It is hereby declared that the original/ revised\* price bid for \_\_\_\_\_

\_\_\_\_\_ (Name of Package) for \_\_\_\_\_ project is complete in all respects and contains prices for complete scope of supply, including tests etc., as per BHEL's requirement. If in the original/ revised\* price bids where itemized price is not available for any part of scope of supply, including tests etc. for completion of the package, the same should be treated to have been included in our original/ revised\* price bid.

It is also agreed that no further chance for seeking clarification/ confirmation to any missing point will be necessary.

Absence of itemized prices against some items does not mean that they are not included. Even though itemized prices are given for major items, those items which are not specially shown, are also included to meet the entire system as per BHEL requirements.

Signature of authorized Representative Name  
and Designation:

Name & Address of the Bidder

Date

Forwarded to:

BHARAT HEAVY ELECTRICALS LTD

Electroporcelains Division

Prof. CNR Rao Circle

Malleswaram

Bangalore - 560012

\* (Please delete whichever is not applicable)

ANNEXURE - IV

PROFORMA OF PERFORMANCE BANK GUARANTEE  
(FOR INDIEGNOUS PURCHASE ORDERS)

- Note: 1) To be executed in Rs 100/- Non-Judicial stamp paper.  
2) To be submitted to Purchase Dept. directly by the Banker

PERFORMANCE GUARANTEE  
( PROFORMA OF BANK GUARANTEE )

THIS DEED OF GUARANTEE made and executed on the \_\_\_\_\_ day of \_\_\_\_\_(month) \_\_\_\_\_(year), by the \_\_\_\_\_ (Bank), registered under the Companies Act 1956/Nationalised Bank constituted under the Banking Companies (acquisition and transfer of undertakings) Act/ constituted under the State Bank of India Act / Subsidiary Banks Act, having its registered / head office at \_\_\_\_\_ (Hereinafter called 'guarantor ' which term shall mean and include its successors and assigns)

IN FAVOUR OF BHARAT HEAVY ELECTRICALS LIMITED

a company registered under the companies Act, 1956 having its registered office at BHEL House at Siri Fort , New Delhi-100 049 and its Electroporcelains Division at Malleswaram, Bangalore-12 (hereinafter referred to as the 'Company' Which term shall include its successors and assigns):

Whereas the company has placed an order on \_\_\_\_\_ (State the name of the Seller- company / firm and its address) (hereinafter referred to as the 'Supplier' which term shall mean and include its liquidators, successors and assign) for the supply of system under Purchase Order No \_\_\_\_\_ Dt \_\_\_\_\_.

AND WHEREAS the supplier has agreed to supply the materials and carryout the works as detailed and in accordance with the terms set out in the said order.

AND WHEREAS the Contract inter-alia provides that the SUPPLIER shall furnish to the Company a sum of Rs..... (Rupees.....) towards security deposit for due and faithful performance of the CONTRACT in the form and manner specified therein.

AND WHEREAS the SUPPLIER has approached the GUARANTOR and in consideration of the arrangement arrived at between the SUPPLIER and the GUARANTOR, the GUARANTOR has agreed to give the Guarantee as hereinafter mentioned in favour of the

COMPANY.

NOW THIS DEED WITNESSES THAT in pursuance of the above said agreement, the guarantor hereby agrees and covenants with company is as follows :-

- 1) That during the period this contract of Guarantee remains effectual, the guarantor shall be liable in respect of the amount due and owing to the company in respect of the payments to the extent of Rs \_\_\_\_\_ (in words) \_\_\_\_\_ against any loss or damage caused to or suffered by the company by reasons of any breach of the terms of the said Purchase order by the supplier.
- 2) The Guarantor hereby undertakes to pay the amounts due and payable under this guarantee without any demur, merely on demand from the company intimating that the amount claimed is due by way of loss or damage caused to or suffered or would be caused or suffered by the supplier of any terms contained in the said Purchase order. Any such demand made on the guarantor shall be conclusive as regards the amount due and payable by the Guarantor irrespective of the fact whether the Supplier admits or denies.
- 3) The Guarantor further agrees that the agreement herein contained shall remain in force and effect till all the supplies to be made / Works to be performed / Services to be rendered under the said Purchase order are completed to the entire satisfaction of the company or till company certifies that the terms and conditions of the said order have been fully and properly carried out by the said supplier and accordingly discharges the Guarantee. Unless a demand or claim under this guarantee is made on the guarantor in writing on or before the expiry of claim period indicated in clause 6 below , the guarantor shall be discharged from all the liability under this guarantee thereafter.
- 4) The guarantor further agrees with the company that the company shall have the fullest liberty without the consent of the guarantor and without effecting in any manner the obligations of the guarantor hereunder to vary any of the terms of the said order or extend the time of performance by the said supplier from time to time or refrain from exercising the power exercisable by the company against the said supplier or to forebear or omit to enforce any of the terms and conditions relating to the said order, and the guarantor shall not be relieved of its liability in whole or in part , by reason of any act, commission or forbearance on the part of the company or by reason of any such variation, or extension being granted to the said supplier or by reason of any such matter or thing whatsoever which under the law relating to sureties would but for this provision have effect of so relieving the guarantor.
- 5) The guarantor undertakes not to revoke this guarantee during the period it is in force except with the previous consent of the COMPANY in writing, and agree that any liquidation or winding up or dissolution or any change in the constitution of the

SUPPLIER or the GUARANTOR shall not discharge the GUARANTOR's liability hereunder.

- 6) Notwithstanding anything herein above contained, the liability of the guarantor under these presents is restricted to Rs\_\_\_\_\_. The guarantee shall be in force till its expiry on \_\_\_\_\_. Unless a demand is made on the guarantor within THREE months from the date of expiry, all the liability of the guarantor under this guarantee shall stand fully discharged. The decision of the claimant in regard to breach of contract is final and binding on the Bank.

(Seal of the Bank to be affixed)

NOTES: (NOT TO BE TYPED)

1. A minimum of TWO Bank Official Signatories
2. Signatories to sign on all pages of the Bank Guarantee
3. Any correction to be validated by the Banker Signatories
4. One common e-mail ID of issuing branch and e-mail & contact no of at least one issuing official should be provided on PBG forwarding letter.

FOREIGN SUPPLIERS & INDIAN AGENTS OF FOREIGN SUPPLIERS

1. BHEL shall deal directly with foreign vendors, wherever required, for procurement of goods/ services. However, if the foreign Principal desires to avail the services of an Indian Agent, then the foreign Principal should ensure compliance to regulatory guidelines – which require mandatory submission of an Agency Agreement.
2. It shall be incumbent on the Indian Agent and the foreign Principal to adhere to the relevant guidelines of Government of India, issued from time to time.
3. An Indian Agent of foreign Origin Equipment Manufacturer (OEM)/ Principal is an individual, a partnership, an association of persons, a private or public company, that carries out specific obligation(s) towards processing of BHEL tender or finalization or execution of BHEL's contract on behalf of the foreign supplier.
4. The Agency Agreement should specify the precise relationship between the foreign OEM/ Principal and their Indian Agent, and their mutual interest in the business. All services to be rendered by the Agent/ Associate, whether of general nature or in relation to the particular contract, must be clearly stated by the foreign Supplier/ Indian Agent. Any payment which the Agent or Associate receives in India or abroad from the OEM/ Principal, whether as commission or as general retainer fee should be brought on record in the Agreement and be made explicit in order to ensure compliance to laws of the country.
5. Any agency commission to be paid by BHEL to the Indian Agent shall be in Indian currency only.
6. Tax deduction at source is applicable to the agency commission paid to the Indian Agent as per the prevailing rules.
7. In absence of any Agency Agreement, BHEL shall not deal with any Indian Agent (authorized representative/ associate/ consultant, or by whatever name called) and shall deal directly with the foreign OEM/ Principal only for all correspondence and business purposes.
8. In a tender, either the Indian Agent on behalf of the foreign OEM/ Principal or foreign OEM/ Principal itself can bid but both cannot bid simultaneously for the same item/ product in the same tender.
9. If an Agent submits bid on behalf of one OEM/ Principal, the same Agent shall not submit a bid on behalf of another OEM/ Principal in the same tender for the same item/ product.
10. The "Guidelines for Indian Agents of Foreign Suppliers" at Annexure-A shall apply in all such cases.
11. The supply and execution of Purchase Order/ Contract (including indigenous supplies/ services) shall be in the scope of foreign OEM/ Principal. The foreign OEM/ Principal should submit their offer inclusive of all indigenous supplies/ services and

evaluation will be based on the 'Total Cost to BHEL'. In case foreign OEM/ Principal recommends placement of order(s) towards indigenous portion of supplies/ services on Indian supplier(s)/ agent on their behalf, the credentials/ capacity/ capability of the Indian supplier(s)/ agent to make the supplies/ services shall be checked by BHEL as per its extant guidelines of Supplier Evaluation, Approval & Review Procedure (SEARP) before opening of price bids. In this regard, details may be checked as per Annexure-B. It will be responsibility of the foreign OEM/ Principal to get acquainted with the evaluation requirements of Indian supplier/ agent as per SEARP available on [www.bhel.com](http://www.bhel.com).

The responsibility for successful execution of the contract (including indigenous supplies/ services) lies with the foreign OEM/ Principal. All bank guarantees to this effect shall be in the scope of the foreign OEM/ Principal.

**Guidelines for Indian Agents of Foreign Suppliers**

- 1.0 There shall be compulsory registration of agents for all Global (Open) Tenders and Limited Tenders. An agent who is not registered with BHEL shall apply for registration in the registration form in line with SEARP.
  - 1.1 Registered agents will file an authenticated photocopy duly attested by a Notary Public/ Original certificate of the Principal confirming the Agency Agreement and giving the status being enjoyed by the Agent and the commission/ remuneration/ salary/ retainership being paid by the Principal to the Agent before placement of order by BHEL.
  - 1.2 Wherever the Indian representatives have communicated on behalf of their Principals and the foreign parties have stated that they are not paying any commission to the Indian agents, and the Indian representative is working on the basis of salary or as retainer, a written declaration to this effect should be submitted by the party (i.e. Principal) before finalizing the order.
- 2.0 Disclosure of particulars of agents/ representatives in India (if any)**
- 2.1 Tenderers of Foreign nationality shall furnish the following details in their offers:
    - 2.1.1 The Bidder(s)/ Contractor(s) of foreign origin shall disclose the name and address of the agents/ representatives in India, if any, and the extent of authorization and authority given to commit the Principals. In case the agent/ representative be a foreign Company, it shall be confirmed whether it is existing Company and details of the same shall be furnished.
    - 2.1.2 The amount of commission/ remuneration included in the quoted price(s) for such agents/ representatives in India.
    - 2.1.3 Confirmation of the Tenderer that the commission/ remuneration, if any, payable to his agents/ representatives in India, may be paid by BHEL in Indian Rupees only.
  - 2.2 Tenderers of Indian Nationality shall furnish the following details in their offers:
    - 2.2.1 The Bidder(s)/ Contractor(s) of Indian Nationality shall furnish the name and address of the foreign Principals, if any, indicating their nationality as well as their status, i.e. whether manufacturer or agents of manufacturer holding the Letter of Authority of the Principal specifically authorizing the agent to make an offer in India in response to tender either directly or through the agents/ representatives.
    - 2.2.2 The amount of commission/ remuneration included in the price (s) quoted by the Tenderer for himself.

2.2.3 Confirmation of the foreign principals of the Tenderer that the commission/ remuneration, if any, reserved for the Tenderer in the quoted price(s), may be paid by BHEL in India in equivalent Indian Rupees on satisfactory completion of the Project or supplies of Stores and Spares in case of operation items.

2.3 In either case, in the event of contract materializing, the terms of payment will provide for payment of the commission/ remuneration, if any payable to the agents/ representatives in India in Indian Rupees, on expiry of 90 days after the discharge of the obligations under the contract.

2.4 Failure to furnish correct and detailed information as called for in paragraph 2.0 above will render the concerned tender liable to rejection or in the event of a contract materializing, the same liable to termination by BHEL. Besides this, there would be a penalty of banning business dealings with BHEL or damage or payment of a named sum.

## Annexure-B

This format is applicable only to Indian Suppliers/ Agents supplying indigenous portion of Foreign Purchases.

In all other cases, extant guidelines of SEARP, 2010 are to be followed.

<b>SEARP (SRF) Clause No.</b>	<b>Detail</b>
	<b>Name &amp; address of the firm</b>
<b>1.0</b>	<b>Products/ Systems / Services being considered for</b>
<b>2.0</b>	<b>General Information</b>
2.2	Name of Chief Executive
2.3	Details of authorized signatory
<b>3.0</b>	<b>Ownership Information</b>
3.1	Type of Firm
3.2	Nature of Business  <i>Attach <b>authorization letter and agency agreement</b> from Principal (from whom capital equipment is procured)</i>  <i>Attach copy of declaration from Foreign Principal for <b>total guarantee/ warranty of indigenous supplies</b></i>
3.3	Year of establishment
3.4	Year of commencement of business
<b>4.0</b>	<b>Registration particulars</b>
4.1	Permanent Account No.
4.2 / 4.3	Sales Tax / TIN No.

4.6	Service Tax No. (in case of Erection & Commissioning)
<b>5.0</b>	<b>Organisational strength</b>
<b>6.0</b>	<b>Other particulars</b>
6.1	If the company is already registered with other BHEL Units
6.2	Directors/ Partners, if related to any BHEL employee
6.9	If any Ex-BHEL personnel employed by the Company
6.12	Details of pending legal issues with BHEL
6.13	Bank Account information
<b>9.0</b>	<b>Financial information</b>
9.6	Sales/ Turnover details of last 3 years (or from the date of incorporation, whichever is less)



	<p align="center"><b>ELECTRO-PORCELAINS DIVISION</b></p>	<p align="center"><b>GENERAL CONDITIONS OF CONTRACT (GCC)</b> Revision No. R0 (For supply and services)</p>	<p align="center"><b>ANNEXURES</b> Issued on 14.03.2017</p>
---	--	---	---

**ANNEXURE-VII**

**NEFT Application Form**

Vendors Name	
Vendor Address	
BANK NAME	
BANK BRANCH	
BANK ADDRESS	
BANK BRANCH CODE	
BANK 9 DIGIT MICR CODE	
BANK NEFT CODE(IFC)	
BANK SWIFT CODE	
BANK PHONE	
ACCOUNT NAME	
ACCOUNT TYPE	
ACCOUNT NO.	
PAN NO.	

	<p align="center"><b>ELECTRO- PORCELAINS DIVISION</b></p>	<p align="center"><b>GENERAL CONDITIONS OF CONTRACT (GCC)</b></p> <p align="center"><b>Revision No. R0 (For supply and services)</b></p>	<p align="center"><b>ANNEXURES</b></p> <p align="center">Issued on 14.03.2017</p>
---	---	--	---

SERVICE TAX NO.	
TIN NO.	
E-MAIL ID	

Authorised Signatory Seal

Above details are to be submitted on company's letterhead. The details may either be attested by vendor's bankers or accompanied by a cancelled cheque leaf with IFSC code & A/c no. Printed on it.

Undertaking to report immediately any changes in the above to be submitted in company's letterhead.

	<p align="center"><b>ELECTRO- PORCELAINS DIVISION</b></p>	<p align="center"><b>GENERAL CONDITIONS OF CONTRACT (GCC)</b></p> <p align="center">Revision No. R0 (For supply and services)</p>	<p align="center"><b>ANNEXURES</b></p> <p align="center">Issued on 14.03.2017</p>
---	---	---	---

**ANNEXURE-VIII**

**LOADING CRITERIA**

No deviations in GCC terms and conditions are generally acceptable, and bids with deviations are liable to be rejected. However, in exceptional circumstances, BHEL may accept deviations with Loading as given below:

**A) PAYMENT TERMS**

1. Payment will be released within 45 days after receipt of complete documents as per order/ contract.

Loading will be done for vendors seeking earlier payment w.r.t. above, for the value and the period of deviation, as per Clause 17.0 of 'Instructions to Bidders'.

Time periods assumed by BHEL for a few activities are as follows:

Payment through Bank	- 30 days from receipt of invoice + documents.
Received LR	- 30 days from despatch.
Material Receipt Certificate (MRC)	- 120 days from despatch.

**However, for Foreign Purchase, CAD at sight and Confirmed LCs are not permitted.**

**B) BANK GUARANTEE `**

Non submission of Bank Guarantee - No deviation is permitted, if applicable as per NIT.

**C) LIQUIDATED DAMAGES**

If maximum limit asked for is 10% or 5% of Undelivered Portion - 10% value of the total quoted price including taxes, duties & freight.

If maximum limit asked is less than 10 % of contract value loading shall be to the extent to which not agreed by bidder (at offered value) .

	<p><b>ELECTRO-PORCELAINS DIVISION</b></p>	<p><b>GENERAL CONDITIONS OF CONTRACT (GCC)</b> Revision No. R0 (For supply and services)</p>	<p><b>ANNEXURES</b> Issued on 14.03.2017</p>
---	---	--	--

**D) PRICE VARIATION CLAUSE (PVC)**

PVC Instead of Firm Price - Maximum ceiling of PVC as demanded by vendor.

**F) NO DEVIATION IS ALLOWED IN RISK PURCHASE/RISK & COST CLAUSE.**

	<b>ELECTRO-PORCELAINS DIVISION</b>	<b>GENERAL CONDITIONS OF CONTRACT (GCC)</b> <b>Revision No. R0</b> <b>(For supply and services)</b>	<b>ANNEXURES</b>  Issued on 14.03.2017
---	------------------------------------	---	---

ANNEXURE-X

<b>List of Consortium Banks</b>			
<b>Nationalised Banks</b>		<b>Public Sector Bank</b>	
1	Allahabad bank	20	IDBI
2	Andhra bank		
3	Bank of Baroda	<b>Foreign banks</b>	
4	Canara Bank	21	CITI Bank N.A
5	Corporation bank	22	Deutsche Bank AG
6	Central bank	23	HSBC
7	Indian Bank	24	Standard Chartered Bank
8	Indian Oversea Bank	25	J P Morgan
9	Oriental bank of Commerce		
10	Punjab National Bank		
11	Punjab & Sindh Bank	<b>Private banks</b>	
12	State Bank of India	26	Axis Bank
13	State Bank of Hyderabad	27	The Federal Bank Limited
14	Syndicate Bank	28	HDFC
15	State Bank of Travancore	29	Kotak Mahindra Bank
16	UCO Bank	30	ICICI
17	Union Bank of India	31	Indusind Bank
18	United Bank of India	32	Yes Bank
19	Vijaya Bank		

	<p align="center"><b>ELECTRO- PORCELAINS DIVISION</b></p>	<p align="center"><b>GENERAL CONDITIONS OF CONTRACT (GCC)</b></p> <p align="center"><b>Revision No. R0 (For supply and services)</b></p>	<p align="center"><b>ANNEXURES</b></p> <p align="center">Issued on 14.03.2017</p>
---	---	--	---

**ANNEXURE-XI**

**Terms & Conditions of Reverse Auction**

Against this enquiry for the subject item/ system with detailed scope of supply as per enquiry specifications, BHEL may resort to "REVERSE AUCTION PROCEDURE" i.e., ON LINE BIDDING (THROUGH A SERVICE PROVIDER). The philosophy followed for reverse auction shall be English Reverse (No ties).

- 1 For the proposed reverse auction, technically and commercially acceptable bidders only shall be eligible to participate.
- 2 Those bidders who have given their acceptance for Reverse Auction (quoted against this tender enquiry) will have to necessarily submit „online sealed bid" in the Reverse Auction. Non-submission of „online sealed bid" by the bidder for any of the eligible items for which techno-commercially qualified, will be considered as tampering of the tender process and will invite action by BHEL as per extant guidelines in vogue.
- 3 BHEL will engage the services of a service provider who will provide all necessary training and assistance before commencement of on line bidding on internet.
- 4 In case of reverse auction, BHEL will inform the bidders the details of Service Provider to enable them to contact & get trained.
- 5 Business rules like event date, time, bid decrement, extension etc. also will be communicated through service provider for compliance.
- 6 Bidders have to fax the Compliance form (annexure IV) before start of Reverse auction. Without this, the bidder will not be eligible to participate in the event.
- 7 In line with the NIT terms, BHEL will provide the calculation sheet (e.g., EXCEL sheet) which will help to arrive at "Total Cost to BHEL" like Packing & forwarding charges, Taxes and Duties, Freight charges, Insurance, Service Tax for Services and loading factors (for non-compliance to BHEL standard Commercial terms & conditions) etc. for each of the bidder to enable them to fill-in the price and keep it ready for keying in during the Auction.

	<p align="center"><b>ELECTRO- PORCELAINS DIVISION</b></p>	<p align="center"><b>GENERAL CONDITIONS OF CONTRACT (GCC)</b></p> <p align="center"><b>Revision No. R0 (For supply and services)</b></p>	<p align="center"><b>ANNEXURES</b></p> <p align="center">Issued on 14.03.2017</p>
---	---	--	---

- 8 Reverse auction will be conducted on scheduled date & time.
- 9 At the end of Reverse Auction event, the lowest bidder value will be known on auction portal.
- 10 The lowest bidder has to fax/e-mail the duly signed and filled-in prescribed format for price breakup including that of line items, if required, (Annexure VII) as provided on case-to-case basis to Service provider within two working days of Auction without fail.
11. In case BHEL decides not to go for Reverse Auction procedure for this tender enquiry, the Price bids and price impacts, if any, already submitted and available with BHEL shall be opened as per BHEL"s standard practice.
12. Bidders shall be required to read the "Terms and Conditions" section of the auctions site of Service provider, using the Login IDs and passwords given to them by the service provider before reverse auction event. Bidders should acquaint themselves of the „Business Rules of Reverse Auction", which will be communicated before the Reverse Auction.
13. If the Bidder or any of his representatives are found to be involved in Price manipulation/ cartel formation of any kind, directly or indirectly by communicating with other bidders, action *as per extant BHEL guidelines*, shall be initiated by BHEL and the results of the RA scrapped/ aborted.
14. The Bidder shall not divulge either his Bids or any other exclusive details of BHEL to any other party.
15. In case BHEL decides to go for reverse auction, the H1 bidder(s) (whose quote is highest in online sealed bid) may not be allowed to participate in further RA process.
16. Updates:-
  - 16.1 "BHEL reserves the right to go for Reverse Auction (RA) (GUIDELINES as available on [www.bhel.com](http://www.bhel.com)) instead of opening the sealed envelope price bid, submitted by the bidder. This will be decided after techno-commercial evaluation. Bidders to give their acceptance with the offer for participation in RA. Non-acceptance to participate in RA may result in non-consideration of their bids, in case BHEL decides to go for RA.

	<p align="center"><b>ELECTRO- PORCELAINS DIVISION</b></p>	<p align="center"><b>GENERAL CONDITIONS OF CONTRACT (GCC)</b>   <b>Revision No. R0 (For supply and services)</b></p>	<p align="center"><b>ANNEXURES</b>   Issued on 14.03.2017</p>
---	---	--	---

Those bidders who have given their acceptance to participate in Reverse Auction will have to necessarily submit “Process Compliance Form” (to the designated service provider) as well as ‘online sealed bid’ in the Reverse Auction. Non-submission of Process Compliance Form or Online Sealed Bid by the agreed bidders will be considered as tempering of the tender process & will invite action by BHEL as per the extent guidelines for suspension of business dealings with suppliers/contractors (as available on [www.bhel.com](http://www.bhel.com) ).

The bidders have to necessarily submit the online sealed bid less than or equal to their envelope sealed price bid already submitted to BHEL along with the offer. The envelope sealed price bid of successful L-1 bidder in RA, if conducted, shall also be opened after RA & the order will be placed on lower of the two bids (RA closing price & envelope sealed price) thus obtained. The bidder having submitted this offer specifically agrees to this condition & undertakes to execute the contract on thus awarded rates.

If it is found that L-1 bidder has quoted higher in online sealed bid in comparison to envelope sealed bid for any item, the bidder will be issued a warning letter to this effect. However, if the same bidder again defaults on this count in any subsequent tender in the unit, it will be consider as fraud & will invite action by BHEL as per the extent guidelines for suspension of business dealings with the suppliers/contractors (as available on [www.bhel.com](http://www.bhel.com) ).

As a reminder to bidders, system will flash the following message (in RED color) during the course of ‘online sealed bid’:

“Bidders to submit online sealed bid less than or equal to their envelope sealed bid already submitted to BHEL”

	<p align="center"><b>ELECTRO- PORCELAINS DIVISION</b></p>	<p align="center"><b>GENERAL CONDITIONS OF CONTRACT (GCC)</b></p> <p align="center">Revision No. R0 (For supply and services)</p>	<p align="center"><b>ANNEXURES</b></p> <p align="center">Issued on 14.03.2017</p>
---	---	---	---

**ANNEXURE-XII**

**FORMAT FOR NO DEVIATION CERTIFICATE**

(To be submitted in the bidder's letter head)

TO  
BHARAT HEAVY ELECTRICALS LIMITED,  
Electroporcelains Division  
Prof. CNR Rao Circle,  
Malleshwaram Bangalore - 560012

Sub :	No deviation certificate
Job :	----
Ref :	Your enquiry No - All the pertinent issues till date.

Dear Sirs,

With reference to above, this is to confirm that we have not changed/ modified the tender documents as appeared in the website/ issued by you and in case of such observance at any stage, it shall be treated as null and void.

We hereby confirm that we have not taken any deviation from tender clauses together with other references as enumerated in the above referred NIT. We hereby confirm our unqualified acceptance to all terms & conditions, unqualified compliance to technical specification, integrity pact (if applicable) and acceptance to reverse auctioning process.

In the event of observance of any deviation in any part of our offer at a later date whether implicit or explicit, the deviations shall stand null & void.

We confirm to have submitted offer in accordance with tender instructions and as per aforesaid references.

Thanking you,

Yours faithfully,

(Signature, date & seal of authorized representative of the bidder)

	<p align="center"><b>ELECTRO- PORCELAINS DIVISION</b></p>	<p align="center"><b>GENERAL CONDITIONS OF CONTRACT (GCC)</b></p> <p align="center">Revision No. R0 (For supply and services)</p>	<p align="center"><b>ANNEXURES</b></p> <p align="center">Issued on 14.03.2017</p>
---	---	---	---

**ANNEXURE-XIII**

**DECLARATION BY AUTHORISED SIGNATORY OF BIDDER**

(To be typed and submitted in the Letter Head of the Company/Firm of Bidder)

To,

(Write Name & Address of Officer of BHEL inviting the Tender)

Dear Sir,

Sub : Declaration by Authorised Signatory

Ref : 1) NIT/Tender Specification No: .....

2) All other pertinent issues till date

I /We, hereby certify that all the information and data furnished by me with regard to the above Tender Specification are true and complete to the best of my knowledge. I have gone through the specifications, conditions, stipulations and all other pertinent issues till date, and agree to comply with the requirements and Intent of the specification.

I further certify that I am authorised to represent on behalf of my Company/Firm for the above mentioned tender and a valid Power of Attorney to this effect is also enclosed.

Yours faithfully,

(Signature, Date & Seal of Authorized  
Signatory of the Bidder)

Date:

Enclosed : Power of Attorney

	<p align="center"><b>ELECTRO- PORCELAINS DIVISION</b></p>	<p align="center"><b>GENERAL CONDITIONS OF CONTRACT (GCC)</b></p> <p align="center">Revision No. R0 (For supply and services)</p>	<p align="center"><b>ANNEXURES</b></p> <p align="center">Issued on 14.03.2017</p>
---	---	---	---

ANNEXURE-XIV

POWER OF ATTORNEY for SUBMISSION OF TENDER/SIGNING CONTRACT  
**AGREEMENT**

**(To be typed on non judicial Stamp Papers of appropriate value as applicable and Notarised)**

KNOW ALL MEN BY THESE PRESENTS, that I/We do hereby make, nominate, constitute and appoint Mr , whose signature given below herewith to be true and lawful Attorney of M/s\_\_\_\_\_ hereinafter called 'Company', for submitting Tender/entering into Contract and inter alia, sign, execute all papers and to do necessary lawful acts on behalf of Company with M/s Bharat Heavy Electricals Ltd, Electroporcelains Division, Bangalore in connection with vide Tender Specification  
No \_\_\_\_\_ dated \_\_\_\_\_

And the Company do hereby agree to ratify and confirm all acts, deeds, things or proceedings as may be lawfully done by the said attorney and by or on behalf of the company and in the name of the company, by virtue of the powers conferred herein and the same shall be binding on the company and shall have full force and effect.

IN WITNESS WHEREOF the common seal of the company has been hereunto affixed in the manner hereinafter appearing on the document.

Dated at \_\_\_\_\_ , this \_\_\_\_\_ day of \_\_\_\_\_

Director/CMD/Partner/Proprietor

Signature of Mr \_\_\_\_\_ (Attorney)

Attested by:  
Director/CMD/Partner/Proprietor  
Witness

	<p align="center"><b>ELECTRO-PORCELAINS DIVISION</b></p>	<p align="center"><b>GENERAL CONDITIONS OF CONTRACT (GCC)</b> Revision No. R0 (For supply and services)</p>	<p align="center"><b>ANNEXURES</b>  Issued on 14.03.2017</p>
---	--	---	--

Notary Public

**ANNEXURE-XVI**

**INDEMNITY BOND**

(To be executed on a Non Judicial Stamp Paper of the requisite value as per Stamp Duty prevalent in the respective State)

This Indemnity Bond executed by <name of company> having their Registered Office at <xxxxxxxxxxx> in favour of M/s Bharat Heavy Electricals Limited, a Company incorporated under the Companies Act, 1956, having its Registered Office at BHEL House, Siri Fort, Asiad, New Delhi - 110049 through its Unit at Electroporcelains Division, Bangalore (Hereinafter referred to as the Company).

And whereas the Company has entered into a Contract with M/s xxxxxxxxx, the executants of this Deed (hereinafter referred to as the Contractor) as its contractor in respect of the work of "xxxxxxxxxxxxxxxxxxxxxxxxxxxxxxxx".

AND WHEREAS under the provisions of GCC further stipulates that the Contractor shall indemnify the Company against all claims of whatever nature arising during the course of execution of Contract including defects liability period of <xx Months > i.e till <xx xx xxxx>

Now this deed witness that in case the Company is made liable by any Authority including Court to pay any claim or compensation etc. in respect of all labourers or other matters at any stage under or relating to the Contract with the Contractor, the Contractor hereby covenants and agrees with the Company that they shall indemnify and reimburse the Company to the extent of such payments and for any fee, including litigation charges, lawyers' fees, etc, penalty or damages claimed against the Company by reason of the Contractor falling to comply with Central/States Laws, Rules etc, or his failure to comply with Contract (including all expenses and charges incurred by the Company).

The Contractor further indemnifies the Company for the amount which the Company may be liable to pay by way of penalty for not making deductions from the Bills of the Contractor towards such amount and depositing the same in the Government Treasury.

	<p align="center"><b>ELECTRO- PORCELAINS DIVISION</b></p>	<p align="center"><b>GENERAL CONDITIONS OF CONTRACT (GCC)</b></p> <p align="center"><b>Revision No. R0 (For supply and services)</b></p>	<p align="center"><b>ANNEXURES</b></p> <p align="center">Issued on 14.03.2017</p>
---	---	--	---

The Contractor further agree that the Company shall be entitled to with hold and adjust the Security Deposit and/or with hold and adjust payment of Bills of Contractor pertaining to this Contract against any payment which the Company has made or is required to make for which the Contractor is liable under the Contract and that such amount can be withheld, adjusted by the Company till satisfactory and final settlement of all pending matters and the Contractor hereby gives his consent for the same.

The Contractor further agrees that the terms of indemnity shall survive the termination or completion of this contract.

The contractor further agrees that the liability of the contractor shall be extended on actual basis notwithstanding the limitations of liability clause, in respect of:

1. breach of terms of contract by the contractor
2. breach of laws by the contractor
3. breach of Intellectual property rights by the contractor
4. breach of confidentiality by the contractor

Nothing contained in this deed, shall be construed as absolving or limiting the liability of the Contractor under said Contract between the Company and the Contractor. That this Indemnity Bond is irrevocable and the condition of the bond is that the Contractor shall duly and punctually comply with the terms and the conditions of this deed and contractual provisions to the satisfaction of the Company.

In witness where of M/s xxxxxxxxxxxxxx these presents on the day, month and year first, above written at xxxxxxxx by the hand of its signatory Mr. xxxxxxxxxxxx.

Signed for and on behalf of  
M/s  
xxxxxxxxxxxxxxxxxx

Witness:

	<p align="center"><b>ELECTRO- PORCELAINS DIVISION</b></p>	<p align="center"><b>GENERAL CONDITIONS OF CONTRACT (GCC)</b></p> <p align="center">Revision No. R0 (For supply and services)</p>	<p align="center"><b>ANNEXURES</b></p> <p align="center">Issued on 14.03.2017</p>
---	---	---	---

ANNEXURE-XVII

**Annexure- A**

**CONSORTIUM AGREEMENT**

(To be executed on Rs. 50/- Non - Judicial Stamp Paper)

THIS AGREEMENT is made and executed on \_\_\_\_ day of \_\_\_\_\_ by and between (1) M/s. \_\_\_\_\_, represented by Shri \_\_\_\_\_, designated as \_\_\_\_\_, having its registered office at \_\_\_\_\_, ( The First Party, i.e, the Bidder) Company incorporated under the Company's Act 1956 having its registered office at \_\_\_\_\_ (hereinafter referred to as the "Bidder" which expression shall include its successors, administrators, executors and permitted assigns) and (2) M/s. \_\_\_\_\_, (The Second Party, i.e, the associates), a company incorporated under \_\_\_\_\_( Company act), having its registered office at \_\_\_\_\_ (hereinafter called the "Associates", which expression shall include its successors, administrators, executors and permitted assigns).

WHEREAS, the Electroporcelains Division, one of the Units of M/s. Bharat Heavy Electricals, having its office at Prof. CNR Rao Circle, Opp. Indian Institute of Science, Malleswaram, Bangalore-560 012, A Government of India Undertaking (hereinafter called the "Employer", " which expression shall include its successors, administrators, executors and permitted assigns), proposes to issue / issued a Notice Inviting Tender ( hereinafter referred to as NIT), inviting bids from the individual bidders for undertaking the work of " \_\_\_\_\_(Package name) for \_\_\_\_\_( Project name) at \_\_\_\_\_(site location) (hereinafter referred to as the "Project") being set up by M/s. \_\_\_\_\_ (hereinafter referred to as the " Owner").

AND WHEREAS, the said NIT enables submission of a bid by a Party subject to fulfilment of the stipulations pre-qualification criteria specified in the said NIT.

	<p align="center"><b>ELECTRO- PORCELAINS DIVISION</b></p>	<p align="center"><b>GENERAL CONDITIONS OF CONTRACT (GCC)</b></p> <p align="center"><b>Revision No. R0 (For supply and services)</b></p>	<p align="center"><b>ANNEXURES</b></p> <p align="center">Issued on 14.03.2017</p>
---	---	--	---

AND WHEREAS, the Bidder desirous of submitting bid in response to the said NIT for the said Project, and by itself is not meeting all the qualifying the Pre-qualification Criteria specified in the said NIT and in order to fully meet the qualifying requirements of NIT, the Bidder entered into this Consortium Agreement with the Associates.

AND WHEREAS the Bidder and the Associates are contractors engaged in the business of carrying out various items of works. WHEREAS, the two parties have agreed to and constitute themselves into a consortium for the purpose of carrying out the said works relating to this Project, and that the consortium will be continued till the completion of the works in all respects including the performance guarantee period as may be specified in the NIT or Purchase Order/Work Order.

AND WHEREAS, with this consortium Agreement, the Bidder and Associates together meets all the pre-qualification criteria as mentioned in the NIT.

WHEREAS, the parties have agreed to certain terms and conditions which forms a part of this consortium agreement, as mentioned hereinbelow :

NOW therefore, this agreement witnesseth as follows :

1. The Bidder and Associates hereby constitute themselves into a Consortium for the purpose of submitting a Bid and undertaking the said works pursuant to the said NIT as hereinafter stated.
2. The Bidder will be the leader (Lead Partner) and will be responsible for the execution of the entire scope of works and its complete functioning as stated in the NIT.
3. The Bidder shall undertake the entire scope of work as detailed in the NIT jointly with the Associates.
4. The Associates shall undertake their part of work as detailed in the NIT jointly with the Bidder.
5. The Bidder and the Associates hereby declare and confirm that each of them jointly and severally will fulfil the required minimum qualifying requirements as prescribed in the said NIT for the works agreed to be undertaken by them as stated herein above.

	<p align="center"><b>ELECTRO- PORCELAINS DIVISION</b></p>	<p align="center"><b>GENERAL CONDITIONS OF CONTRACT (GCC)</b></p> <p align="center"><b>Revision No. R0 (For supply and services)</b></p>	<p align="center"><b>ANNEXURES</b></p> <p align="center">Issued on 14.03.2017</p>
---	---	--	---

6. The Bidder and the Associates also hereby agree that both of them shall be jointly and severally responsible for the completion of the said works as per the schedule. Further, if the Employer and or the Owner sustains any loss or damage on account of non-performance or any breach of contract, both the Bidder and Associates, as a consortium partners, individually and severally undertake to compensate and pay such losses / damages so caused to the Employer and or the Owner on its written demand without any demur, reservation, contest or protest in any manner whatsoever.
7. AND WHEREAS, the Bidder and the Associates, do hereby undertakes to indemnify both the Employer and the Owner to make good any losses/damages sustained by them due to the negligence or any acts of Bidder and or the Associates which results in loss / damages to the Employer / Owner.
8. AND WHEREAS Bidder and the Associates hereby agree that in case of any dispute arising in and out of this consortium agreement shall be dealt in accordance with the provisions of Indian Arbitration and Conciliation Act, 1996 and the place of Arbitration will be at India and the language of Arbitration will be English.
9. AND WHEREAS both the Bidder and the Associates hereby agree and undertake that they shall provide adequate finances, suitable Tools, Plants, equipments, tractors, trailers, other transportation equipment, other Tools and Plants, Measuring and Monitoring Equipments (MMEs), Men and Machinery etc., for the proper and effective execution of the works to be undertaken by them as specified herein above.
10. AND WHEREAS, it was agreed to interse, between the parties hereto that all the consequential liabilities ec., arising out of any default in the due execution of the said works shall be borne by the consortium leader and or party in default, that is by party in whose area of works default has occurred, provided however, so far as the Employer is concerned, both The bidder and the Associates shall be jointly and severally liable irrespective of their scope of work.

	<p align="center"><b>ELECTRO- PORCELAINS DIVISION</b></p>	<p align="center"><b>GENERAL CONDITIONS OF CONTRACT (GCC)</b></p> <p align="center"><b>Revision No. R0 (For supply and services)</b></p>	<p align="center"><b>ANNEXURES</b></p> <p align="center">Issued on 14.03.2017</p>
---	---	--	---

IN WITNESS WHEREOF, the parties above named have signed this agreement on the day month and year first above written at Faridabad.

For and on Behalf of The Bidder

AUTHORISED SIGNATORY ::

OFFICIAL ADDRESS :

COMPANY SEAL

WITNESSES :

1.

2.

For and on Behalf of the Associates

AUTHORISED SIGNATORY ::

OFFICIAL ADDRESS :

COMPANY SEAL

WITNESSES :

1

2

	<p align="center"><b>ELECTRO- PORCELAINS DIVISION</b></p>	<p align="center"><b>GENERAL CONDITIONS OF CONTRACT (GCC)</b></p> <p align="center">Revision No. R0 (For supply and services)</p>	<p align="center"><b>ANNEXURES</b></p> <p align="center">Issued on 14.03.2017</p>
---	---	---	---

**ANNEXURE XVIII**

**Vendor Particulars & Logistics Information**

Vendor's particulars & logistics information (Bidder to give details against each of the provisions)

1. Name of the vendor's executive to deal with this tender / project:-
2. E-mail address of the contact person
3. Telephone no. of the contact person
4. Name of location from where the goods shall be offered for inspection and dispatch
5. Additional logistics information for Imports
6. Bid currency
7. Name of the load port where the goods are offered for Delivery on FOB terms
8. Name of Airport in the country of dispatch for FCA delivery terms
9. Additional freight over FOB price, for delivery on CFR named port in the country of destination, if the Seller decides to bid on CFR / CIF / CPT basis

	<p align="center"><b>ELECTRO- PORCELAINS DIVISION</b></p>	<p align="center"><b>GENERAL CONDITIONS OF CONTRACT (GCC)</b></p> <p align="center"><b>Revision No. R0 (For supply and services)</b></p>	<p align="center"><b>ANNEXURES</b></p> <p align="center">Issued on 14.03.2017</p>
---	---	--	---

10. Numbers, Type & size of containers estimated for delivery of Tendered quantity (Applicable where the goods are to be sent in containers)
  
11. No. of Packages with cumulative gross weight and CBM volume (Applicable for break-bulk shipment)
  
12. Additional FOB cost for loading the cargo on-board in case of EX-Works or FAS delivery terms
  
13. Approx. distance in km. from Vendor's works to Port of loading
  - a Sea port
  
  - b Air port

	<p align="center"><b>ELECTRO-PORCELAINS DIVISION</b></p>	<p align="center"><b>GENERAL CONDITIONS OF CONTRACT (GCC)</b></p> <p align="center">Revision No. R0 (For supply and services)</p>	<p align="center"><b>ANNEXURES</b></p> <p align="center">Issued on 14.03.2017</p>
---	--	---	---

**ANNEXURE XIX**

**NON DISCLOSURE AGREEMENT**

I, \_\_\_\_\_, on behalf of the \_\_\_\_\_ (Name of Company), acknowledge that the information received or generated, directly or indirectly, while working with BHEL, EPD on contract is confidential and that the nature of the business of the BHEL, EPD is such that the following conditions are reasonable, and therefore:

I warrant and agree as follows:

I, or any other personnel employed or engaged by our company, agree not to disclose, directly or indirectly, any information related to the BHEL, EPD Without restricting the generality of the foregoing, it is agreed that we will not disclose such information consisting but not necessarily limited to:

- Technical information: Methods, drawings, processes, formulae, compositions, systems, techniques, inventions, computer programs/data/configuration and research projects.
- Business information: Customer lists, project schedules, pricing data, estimates, financial or marketing data,

On conclusion of contract, I, or any other personnel employed or engaged by our company shall return to BHEL, EPD all documents and property of BHEL, EPD, including: drawings, blueprints, reports, manuals, computer programs/data/configuration, and all other materials and all copies thereof relating in any way to BHEL, EPD's business, or in any way obtained by me during the course of contract. I further agree that I, or any others employed or engaged by our company shall not retain copies, notes or abstracts of the foregoing.

This obligation of confidence shall continue after the conclusion of the contract also.

I acknowledge that the aforesaid restrictions are necessary and fundamental to the business of the BHEL, EPD and are reasonable given the nature of the business carried on by the BHEL, EPD I agree that this agreement shall be governed by and construed in accordance with the laws of country.

I enter into this agreement totally voluntarily, with full knowledge of its meaning, and without duress.

Place:- \_\_\_\_\_

Date:- \_\_\_\_\_

Name

Company

 <p>The logo features the BHEL logo on the left, a large '50' in the center, and a gear icon on the right. Text includes 'BHEL', '50', and 'ANNIVERSARY'.</p>	<p><b>ELECTRO- PORCELAINS DIVISION</b></p>	<p><b>GENERAL CONDITIONS OF CONTRACT (GCC)</b> <b>Revision No. R0 (For supply and services)</b></p>	<p><b>ANNEXURES</b>  Issued on 14.03.2017</p>
--	--	---	---

Signature

	<p align="center"><b>ELECTRO- PORCELAINS DIVISION</b></p>	<p align="center"><b>GENERAL CONDITIONS OF CONTRACT (GCC)</b>  Revision No. R0 (For supply and services)</p>	<p align="center"><b>ANNEXURES</b>  Issued on 14.03.2017</p>
---	---	--	--

**ANNEXURE-VII**

**NEFT Application Form**

Vendors Name	
Vendor Address	
BANK NAME	
BANK BRANCH	
BANK ADDRESS	
BANK BRANCH CODE	
BANK 9 DIGIT MICR CODE	
BANK NEFT CODE(IFC)	
BANK SWIFT CODE	
BANK PHONE	
ACCOUNT NAME	
ACCOUNT TYPE	
ACCOUNT NO.	
PAN NO.	

	<p align="center"><b>ELECTRO- PORCELAINS DIVISION</b></p>	<p align="center"><b>GENERAL CONDITIONS OF CONTRACT (GCC)</b>  Revision No. R0 (For supply and services)</p>	<p align="center"><b>ANNEXURES</b>  Issued on 14.03.2017</p>
---	---	--	--

SERVICE TAX NO.	
TIN NO.	
E-MAIL ID	

Authorised Signatory Seal

Above details are to be submitted on company's letterhead. The details may either be attested by vendor's bankers or accompanied by a cancelled cheque leaf with IFSC code & A/c no. Printed on it.

Undertaking to report immediately any changes in the above to be submitted in company's letterhead.

	<p align="center"><b>ELECTRO- PORCELAINS DIVISION</b></p>	<p align="center"><b>GENERAL CONDITIONS OF CONTRACT (GCC)</b>  Revision No. R0 (For supply and services)</p>	<p align="center"><b>ANNEXURES</b>  Issued on 14.03.2017</p>
---	---	--	--

ANNEXURE-XIV

POWER OF ATTORNEY for SUBMISSION OF TENDER/SIGNING CONTRACT  
**AGREEMENT**

**(To be typed on non judicial Stamp Papers of appropriate value as applicable and  
Notarised)**

KNOW ALL MEN BY THESE PRESENTS, that I/We do hereby make, nominate, constitute and appoint Mr , whose signature given below herewith to be true and lawful Attorney of M/s\_\_\_\_\_ hereinafter called 'Company', for submitting Tender/entering into Contract and inter alia, sign, execute all papers and to do necessary lawful acts on behalf of Company with M/s Bharat Heavy Electricals Ltd, Electroporcelains Division, Bangalore in connection with vide Tender Specification No \_\_\_\_\_ dated \_\_\_\_\_

And the Company do hereby agree to ratify and confirm all acts, deeds, things or proceedings as may be lawfully done by the said attorney and by or on behalf of the company and in the name of the company, by virtue of the powers conferred herein and the same shall be binding on the company and shall have full force and effect.

IN WITNESS WHEREOF the common seal of the company has been hereunto affixed in the manner hereinafter appearing on the document.

Dated at \_\_\_\_\_ , this \_\_\_\_\_ day of \_\_\_\_\_

Director/CMD/Partner/Proprietor

Signature of Mr \_\_\_\_\_ (Attorney)

Attested by:  
Director/CMD/Partner/Proprietor  
Witness

**ANNEXURE-I**

(To be filled up by the Bidder)

Ref. No.:

Date :

M/s Bharat Heavy Electricals Ltd.,  
Electroporcelains Division  
Prof. CNR Rao Circle  
Malleshwaram  
Bangalore - 560012

Attention : Shri

Dear Sir,

1 Having examined the tender documents against your tender Enquiry No \_\_\_\_\_ dated \_\_\_\_\_ and having understood the provisions of the said tender documents and having thoroughly studied the requirements of BHEL related to the work tendered for, in connection with \_\_\_\_\_ (name of work & project site), we hereby submit our offer for the proposed work in accordance with terms and conditions mentioned in the tender documents, at the prices quoted by us in your price schedule format and as per the indicated delivery schedule.

2. If the work or any part thereof is awarded to us, we undertake to submit security-cumcontract performance bank guarantee as per your requirement.

3. We have annexed to this tender the following documents:-

**Part-I (Techno Commercial Bid)** - in a properly sealed cover (uploaded in website in case of e-procurement).

- a) Complete Techno-Commercial Offer.
- b) Un-priced copy of deviation sheet (cost of withdrawal) - Annexure-II
- c) Un-priced copy of Price Schedule using format given by BHEL.
- d) Any other documents (please specify).

**Part-II (Price Bid along with Priced Annexure-II)** - in a separate, properly sealed cover, in the format given by BHEL (uploaded in website in case of e-procurement).

Thanking you,

Yours faithfully,

(Signature of the bidder with Name, Designation and Company's Seal)

ANNEXURE - III

**DECLARATION**

It is hereby declared that the original/ revised\* price bid for \_\_\_\_\_

\_\_\_\_\_ (Name of Package) for \_\_\_\_\_ project is complete in all respects and contains prices for complete scope of supply, including tests etc., as per BHEL's requirement. If in the original/ revised\* price bids where itemized price is not available for any part of scope of supply, including tests etc. for completion of the package, the same should be treated to have been included in our original/ revised\* price bid.

It is also agreed that no further chance for seeking clarification/ confirmation to any missing point will be necessary.

Absence of itemized prices against some items does not mean that they are not included. Even though itemized prices are given for major items, those items which are not specially shown, are also included to meet the entire system as per BHEL requirements.

Signature of authorized Representative Name  
and Designation:

Name & Address of the Bidder

Date

Forwarded to:

BHARAT HEAVY ELECTRICALS LTD

Electroporcelains Division

Prof. CNR Rao Circle

Malleswaram

Bangalore - 560012

\* (Please delete whichever is not applicable)

**FORMAT FOR VERIFICATION OF LOCAL CONTENT UNDER PREFERENCE TO MAKE IN INDIA**

**ORDER**

*(To be submitted with the offer)*

**[Applicable for procurement value from Rs. 5.00 Lac to Rs. 10.00 Crore]**

**Self-certification giving the percentage of local content, in line with PPP-MII order, if applicable  
[to be submitted on the letterhead of the issuer].**

<b>Item Name</b>	:	
<b>Enquiry No.</b>	:	
<b>Project</b>	:	
<b>Applicable percentage of Local Content</b>	:	<b><i>(Bidder to indicate local content in percentage)</i></b>

We have read and understood the provisions of "Public Procurement (Preference to Make in India) Order, 2017" dated 15/06/2017, its revision dated 28/05/2018 and any subsequent modifications/Amendments, if any [hereinafter, "PPP-MII Order"] issued by Department of Industrial Policy and Promotion (DIPP), Ministry of Commerce and Industry, Government of India.

In line with the provisions of the PPP-MII Order, We, M/s. .... [Enter the name of the Bidder] [hereinafter, "Local Supplier"] submits self-certification to M/s. Bharat Heavy Electricals Limited [hereinafter, BHEL] regarding Local Content in Goods/Services/Works to be supplied by the Local Supplier for ..... (Enter the name of the Equipment/Item for Project), wherein we have agreed to abide by the terms and conditions of the PPP-MII Order.

Details of location at which local value addition will be made is as follows:

---

---

---

---

We also understand, false declarations will be in breach of the Code of Integrity under Rule 175(1)(i)(h) of the General Financial Rules for which a bidder or its successors can be debarred for up to two years as per Rule 151 (iii) of the General Financial Rules along with such other actions as may be permissible under law.

For and on behalf of,

Date:

Authorized Signatory  
(With Company Seal & Signature)

*Note: This is a guiding format. In case the bidder submits the certificate in a format different from the above, the same may be considered provided it meets the intent and purpose, as may be ascertained by BHEL.*

**Annexure-1(B)**

**FORMAT FOR VERIFICATION OF LOCAL CONTENT UNDER PREFERENCE TO MAKE IN INDIA  
ORDER**

*(To be submitted with the offer)*

***[Applicable for procurement value more than Rs. 10.00 Crore]***

**Certificate from statutory auditor or cost auditor of the company (in the case of companies) or from a practicing cost accountant or practicing chartered accountant (in respect of suppliers other than companies) giving the percentage of Local Content, in line with PPP-MII order, if applicable *[to be submitted on the letterhead of the issuer]*.**

<b>Item Name</b>	:	
<b>Enquiry No.</b>	:	
<b>Project</b>	:	
<b>Applicable percentage of Local Content</b>	:	<b><i>(Bidder to indicate local content in percentage)</i></b>

We have read and understood the provisions of "Public Procurement (Preference to Make in India) Order, 2017" dated 15/06/2017, its revision dated 28/05/2018 and any subsequent modifications/Amendments, if any [hereinafter, "PPP-MII Order"] issued by Department of Industrial Policy and Promotion (DIPP), Ministry of Commerce and Industry, Government of India.

In line with the provisions of the PPP-MII Order, We, M/s. .... *[Enter the name of the Bidder]* [hereinafter, "Local Supplier"] submits self-certification to M/s. Bharat Heavy Electricals Limited [hereinafter, BHEL] regarding Local Content in Goods/Services/Works to be supplied by the Local Supplier for ..... *(Enter the name of the Equipment/Item for Project)*, wherein we have agreed to abide by the terms and conditions of the PPP-MII Order.

Details of location at which local value addition will be made is as follows:

---

---

---

---

---

We also understand, false declarations will be in breach of the Code of Integrity under Rule 175(1)(i)(h) of the General Financial Rules for which a bidder or its successors can be debarred for up to two years as per Rule 151 (iii) of the General Financial Rules along with such other actions as may be permissible under law.

For and on behalf of,

Date:

भारत हेवी इलेक्ट्रिकल्स लिमिटेड  
Bharat Heavy Electricals Limited  
सोलर बिजनेस डिवीजन /सोलर बिजनेस डिवीजन / Solar Business Division.  
बंगलुरु/बंगलुरु/Bengaluru

Authorized Signatory  
(With Company Seal & Signature)

---

We, the Statutory Auditor(s) / Cost auditor (applicable in the case of companies) of the Local Supplier / a practicing cost accountant or practicing chartered accountant (applicable in respect of suppliers other than companies), certify that the Local Content as defined under the PPP-MII, in the Goods/Service/Works to be supplied by the Local Supplier for ..... (Enter the name of the Equipment/Item for Project) is ..... percentage [specify the percentage of Local content].

For and on behalf of,

Date:

Authorized Signatory  
(With Company Seal & Signature)  
Firm Reg No:  
Membership No.

*Note: This is a guiding format. In case the bidder submits the certificate in a format different from the above, the same may be considered provided it meets the intent and purpose, as may be ascertained by BHEL.*

**Annexure-2(A)**

**(Applicable only for MSE Suppliers)**  
**Certificate by Chartered Accountant on Letterhead**  
**(as applicable)**

This is to Certify that M/s \_\_\_\_\_, (hereinafter referred to as 'company') having its registered office at \_\_\_\_\_ is registered under MSMED Act 2006, (Entrepreneur Memorandum No (Part-II) \_\_\_\_\_ dtd: \_\_\_\_\_, Category: \_\_\_\_\_ (Micro/Small)). (Copy enclosed).

Further verified from the Books of Accounts that the investment of the company as on date \_\_\_\_\_ as per MSMED Act 2006 is as follows:

1. For Manufacturing Enterprises: Investment in plant and machinery (Le. original cost excluding land and building and the items specified by the Ministry of Small Scale Industries vide its notification No.S.O.1722(E) dated October 5,2006:  
Rs. \_\_\_\_\_ Lakhs
2. For Service Enterprises: Investment in equipment (original cost excluding land and building and furniture, fittings and other items not directly related to the service rendered or as may be notified under the MSMED Act, 2006: Rs \_\_\_\_\_ Lakhs The above investment of Rs \_\_\_\_\_ Lakhs is within permissible limit of Rs \_\_\_\_\_ Lakhs for \_\_\_\_\_ Micro / Small (Strike off which is not applicable) Category under MSMED Act 2006.

Date:

(Signature)

Name

Membership Number

Seal of Chartered Accountant with UDIN reference

भारत हेवी इलेक्ट्रिकल्स लिमिटेड  
Bharat Heavy Electricals Limited  
सोलार बिजनेस डिवीजन /सोलर बिजनेस डिवीजन / Solar Business Division.  
बंगलुरु/बंगलुरु/Bengaluru

**Annexure-2(B)**

**(Applicable only for MSE Suppliers)**  
**Certificate by Chartered Accountant on Letterhead**  
**(as applicable)**

This is to certify that M/s \_\_\_\_\_ (hereinafter referred to as 'enterprise') having PAN Number \_\_\_\_\_ and UDYAM Registration Number \_\_\_\_\_, registered office at \_\_\_\_\_ is falling under the category \_\_\_\_\_ (**Micro / Small / Medium**) under MSMED Act 2006. (Copy of UDYAM Registration Certificate to be enclosed).

The said classification of \_\_\_\_\_ (**Micro / Small / Medium**) is arrived at based on the Notifications / guidelines / clarifications issued under Micro, Small and Medium Enterprises Development Act, 2006 including the notification S.O.2119 (E) dated 26<sup>th</sup> June 2020.

The Investment of the enterprise in Plant and Machinery or Equipment as at 31<sup>st</sup> March' 20\_\_ as per Clause - 4 of the Notification is Rs. \_\_\_\_\_ (Rupees in Lakhs).

The turnover of the Enterprise for the period ending 31st March 2020 as per Clause - 5 of the Notification is Rs. \_\_\_\_\_ (Rupees in Lakhs).

Date:

(Signature)

Name

Membership Number

Seal of Chartered Accountant with UDIN reference

भारत हेवी इलेक्ट्रिकल्स लिमिटेड  
Bharat Heavy Electricals Limited  
सोलार बिजनेस डिवीजन /सोलर बिजनेस डिवीजन / Solar Business Division.  
बंगलुरु/बंगलुरु/Bengaluru

**Annexure-3(A)**

**(Compliance to be submitted on the Bidder's Letterhead)  
(as applicable)**

**Sub: Compliance to Government of India order OM No.6/18/2019-PPD dated 23.07.2020 & 24.7.2020 regarding restrictions under Rule 144 (XI) of the General Financial Rules (GFRs), 2017**

<b>Item Name</b>	:	
<b>Enquiry No.</b>	:	
<b>Project</b>	:	

We M/s \_\_\_\_\_ (name of the bidder company) have read the clauses pertaining to Department of Expenditure's (DoE) Public Procurement Division Order (Public procurement no 1,2 & 3 vide ref. F.No.6/18/2019-PPD dated 23.07.2020 & 24.7.2020) regarding restrictions on procurement from a bidder of a country which shares a land border with India.

We hereby certify that **we are not from such a country** and eligible to be considered for this tender.

(Note: Non-compliance of above said GoI Order and its subsequent amendment, (if any), by any bidder(s) shall lead for commercial rejection of their bids by BHEL)

For and behalf of \_\_\_\_\_ (Name of the bidder)

(Signature, date & seal of authorized representative of the bidder)

**Annexure-3(A)**

**(Compliance to be submitted on the Bidder's Letterhead)  
(as applicable)**

**Sub: Compliance to Government of India order OM No.6/18/2019-PPD dated 23.07.2020 & 24.7.2020 regarding restrictions under Rule 144 (XI) of the General Financial Rules (GFRs), 2017**

<b>Item Name</b>	:	
<b>Enquiry No.</b>	:	
<b>Project</b>	:	

We M/s \_\_\_\_\_ (name of the bidder company) have read the clauses pertaining to Department of Expenditure's (DoE) Public Procurement Division Order (Public procurement no 1,2 & 3 vide ref. F.No.6/18/2019-PPD dated 23.07.2020 & 24.7.2020) regarding restrictions on procurement from a bidder of a country which shares a land border with India.

**We are from such a country** which shares a land border with India & have been registered with the Competent Authority as specified in above said order. We hereby certify that we fulfil all requirements in this regard and are eligible to be considered.

**Evidence of valid registration by the Competent Authority is attached.**

(Note: Non-compliance of above said GoI Order and its subsequent amendment, (if any), by any bidder(s) shall lead for commercial rejection of their bids by BHEL).

For and behalf of \_\_\_\_\_ (Name of the bidder)

(Signature, date & seal of authorized representative of the bidder)

**Annexure-4**

**(Compliance to be submitted on the Bidder's Letterhead)  
(as applicable)**

**Sub: Compliance to order No. 25-111612018-PG, Dated 02.07.2020 of Ministry of Power, GOI**

<b>Item Name</b>	:	
<b>Enquiry No.</b>	:	
<b>Project</b>	:	

This is to certify that all equipment, components, and parts imported for use in the Power Supply System and Network are in strict compliance to directions issued by Ministry of Power, Govt. of India vide order No. 25-111612018-PG dated 02.07.2020. The imported component(s), part or assembly item(s) does not carry any malware/Trojan etc.

Note: Non-compliance of MoP Order and its subsequent amendment(s), (if any), by vendor shall lead to rejection of their offer or cancellation of contract, which is awarded by BHEL.

For and behalf of \_\_\_\_\_ (Name of the bidder)

(Signature, date & seal of authorized representative of the bidder)

	<p align="center"><b>ELECTRO- PORCELAINS DIVISION</b></p>	<p align="center"><b>GENERAL CONDITIONS OF CONTRACT (GCC)</b></p> <p align="center">Revision No. R0 (For supply and services)</p>	<p align="center"><b>ANNEXURES</b></p> <p align="center">Issued on 14.03.2017</p>
---	---	---	---

**ANNEXURE-XII**

**FORMAT FOR NO DEVIATION CERTIFICATE**

(To be submitted in the bidder's letter head)

TO  
BHARAT HEAVY ELECTRICALS LIMITED,  
Electroporcelains Division  
Prof. CNR Rao Circle,  
Malleshwaram Bangalore - 560012

Sub :	No deviation certificate
Job :	----
Ref :	Your enquiry No -
	All the pertinent issues till date.

Dear Sirs,

With reference to above, this is to confirm that we have not changed/ modified the tender documents as appeared in the website/ issued by you and in case of such observance at any stage, it shall be treated as null and void.

We hereby confirm that we have not taken any deviation from tender clauses together with other references as enumerated in the above referred NIT. We hereby confirm our unqualified acceptance to all terms & conditions, unqualified compliance to technical specification, integrity pact (if applicable) and acceptance to reverse auctioning process.

In the event of observance of any deviation in any part of our offer at a later date whether implicit or explicit, the deviations shall stand null & void.

We confirm to have submitted offer in accordance with tender instructions and as per aforesaid references.

Thanking you,

Yours faithfully,

(Signature, date & seal of authorized representative of the bidder)

	<p align="center"><b>ELECTRO- PORCELAINS DIVISION</b></p>	<p align="center"><b>GENERAL CONDITIONS OF CONTRACT (GCC)</b>  Revision No. R0 (For supply and services)</p>	<p align="center"><b>ANNEXURES</b>  Issued on 14.03.2017</p>
---	---	--	--

**ANNEXURE-XIII**

**DECLARATION BY AUTHORISED SIGNATORY OF BIDDER**

(To be typed and submitted in the Letter Head of the Company/Firm of Bidder)

To,  
(Write Name & Address of Officer of BHEL inviting the Tender)

Dear Sir,

Sub : Declaration by Authorised Signatory

Ref : 1) NIT/Tender Specification No: .....  
2) All other pertinent issues till date

I /We, hereby certify that all the information and data furnished by me with regard to the above Tender Specification are true and complete to the best of my knowledge. I have gone through the specifications, conditions, stipulations and all other pertinent issues till date, and agree to comply with the requirements and Intent of the specification.

I further certify that I am authorised to represent on behalf of my Company/Firm for the above mentioned tender and a valid Power of Attorney to this effect is also enclosed.

Yours faithfully,

(Signature, Date & Seal of Authorized  
Signatory of the Bidder)

Date:

Enclosed : Power of Attorney

	<p align="center"><b>ELECTRO- PORCELAINS DIVISION</b></p>	<p align="center"><b>GENERAL CONDITIONS OF CONTRACT (GCC)</b></p> <p align="center">Revision No. R0 (For supply and services)</p>	<p align="center"><b>ANNEXURES</b></p> <p align="center">Issued on 14.03.2017</p>
---	---	---	---

**ANNEXURE XIX**

**NON DISCLOSURE AGREEMENT**

I, \_\_\_\_\_, on behalf of the \_\_\_\_\_ (Name of Company), acknowledge that the information received or generated, directly or indirectly, while working with BHEL, EPD on contract is confidential and that the nature of the business of the BHEL, EPD is such that the following conditions are reasonable, and therefore:

I warrant and agree as follows:

I, or any other personnel employed or engaged by our company, agree not to disclose, directly or indirectly, any information related to the BHEL, EPD Without restricting the generality of the foregoing, it is agreed that we will not disclose such information consisting but not necessarily limited to:

- Technical information: Methods, drawings, processes, formulae, compositions, systems, techniques, inventions, computer programs/data/configuration and research projects.
- Business information: Customer lists, project schedules, pricing data, estimates, financial or marketing data,

On conclusion of contract, I, or any other personnel employed or engaged by our company shall return to BHEL, EPD all documents and property of BHEL, EPD, including: drawings, blueprints, reports, manuals, computer programs/data/configuration, and all other materials and all copies thereof relating in any way to BHEL, EPD's business, or in any way obtained by me during the course of contract. I further agree that I, or any others employed or engaged by our company shall not retain copies, notes or abstracts of the foregoing.

This obligation of confidence shall continue after the conclusion of the contract also.

I acknowledge that the aforesaid restrictions are necessary and fundamental to the business of the BHEL, EPD and are reasonable given the nature of the business carried on by the BHEL, EPD I agree that this agreement shall be governed by and construed in accordance with the laws of country.

I enter into this agreement totally voluntarily, with full knowledge of its meaning, and without duress.

Place:- \_\_\_\_\_

Date:- \_\_\_\_\_

Name

Company

( SIGNATURE )

	<p align="center"><b>ELECTRO- PORCELAINS DIVISION</b></p>	<p align="center"><b>GENERAL CONDITIONS OF CONTRACT (GCC)</b></p> <p align="center">Revision No. R0 (For supply and services)</p>	<p align="center"><b>ANNEXURES</b></p> <p align="center">Issued on 14.03.2017</p>
---	---	---	---

**ANNEXURE XVIII**

**Vendor Particulars & Logistics Information**

Vendor's particulars & logistics information (Bidder to give details against each of the provisions)

1. Name of the vendor's executive to deal with this tender / project:-
2. E-mail address of the contact person
3. Telephone no. of the contact person
4. Name of location from where the goods shall be offered for inspection and dispatch
5. Additional logistics information for Imports
6. Bid currency
7. Name of the load port where the goods are offered for Delivery on FOB terms
8. Name of Airport in the country of dispatch for FCA delivery terms
9. Additional freight over FOB price, for delivery on CFR named port in the country of destination, if the Seller decides to bid on CFR / CIF / CPT basis

	<p align="center"><b>ELECTRO- PORCELAINS DIVISION</b></p>	<p align="center"><b>GENERAL CONDITIONS OF CONTRACT (GCC)</b></p> <p align="center"><b>Revision No. R0 (For supply and services)</b></p>	<p align="center"><b>ANNEXURES</b></p> <p align="center">Issued on 14.03.2017</p>
---	---	--	---

10. Numbers, Type & size of containers estimated for delivery of Tendered quantity (Applicable where the goods are to be sent in containers)
  
11. No. of Packages with cumulative gross weight and CBM volume (Applicable for break-bulk shipment)
  
12. Additional FOB cost for loading the cargo on-board in case of EX-Works or FAS delivery terms
  
13. Approx. distance in km. from Vendor's works to Port of loading
  - a Sea port
  
  - b Air port

**ANNEXURE TO MODEL CONCILIATION CLAUSE FOR CONDUCT OF  
CONCILIATION UNDER THE BHEL CONCILIATION SCHEME, 2018**

**BRIEF PROCEDURE FOR CONDUCT OF CONCILIATION PROCEEDINGS**

1. The proceedings of Conciliation shall broadly be governed by Part-III of the Arbitration and Conciliation Act 1996 or any statutory modification thereof and as provided herein:
2. The party desirous of resorting to Conciliation shall send an invitation/notice in writing to the other party to conciliate specifying all points of Disputes with details of the amount claimed. The party concerned shall not raise any new issue thereafter. Parties shall also not claim any interest on claims/counter-claims from the date of notice invoking Conciliation till the conclusion of the Conciliation proceedings. If BHEL is to initiate Conciliation, then, the invitation to Conciliate shall be extended to the concerned Stakeholder in **Format 7** hereto. Where the stakeholder is to initiate the Conciliation, the notice for initiation of Conciliation shall be sent in **Format-8** hereto.
3. The party receiving the invitation/notice for Conciliation shall within 30 days of receipt of the notice of Conciliation intimate its consent for Conciliation along with its counter-claims, if any.
4. The Conciliation in a matter involving claim or counter-claim (whichever is higher) up to Rs 5 crores shall be carried out by sole Conciliator nominated by BHEL while in a matter involving claim or counter-claim (whichever is higher) of more than Rs 5 crores Conciliation shall be carried out by 3 Conciliators nominated by BHEL. The appointment of Conciliator(s) shall be completed and communicated by the concerned Department/Group of BHEL Unit/Division/Region/Business Group to the other party and the Conciliator(s) within 30 days from the date of acceptance of the invitation to conciliate by the concerned party in the **Format-9**. The details of the Claim, and counter-claim, if any, shall be intimated to the Conciliator(s) simultaneously in **Format-5**.
5. The Parties shall be represented by only their duly authorized in-house executives/officers and neither Party shall be represented by a Lawyer.
6. The first meeting of the IEC shall be convened by the IEC by sending appropriate communication/notice to both the parties as soon as possible but not later than 30 days from the date of his/their appointment. The hearings in the Conciliation proceeding shall ordinarily be concluded within two (2) months and, in exceptional cases where parties have expressed willingness to settle the matter or there exists possibility of settlement in the matter, the

*Amith K. Rao*

proceedings may be extended by the IEC by a maximum of further 2 months with the consent of the Parties subject to cogent reasons being recorded in writing.

7. The IEC shall thereafter formulate recommendations for settlement of the Disputes supported by reasons at the earliest but in any case within 15 days from the date of conclusion of the last hearing. The recommendations so formulated along with the reasons shall be furnished by the IEC to both the Parties at the earliest but in any case within 1 month from the date of conclusion of the last hearing.
8. Response/modifications/suggestions of the Parties on the recommendations of the IEC are to be submitted to the IEC within time limit stipulated by the IEC but not more than 15 days from the date of receipt of the recommendations from the IEC.
9. In the event, upon consideration, further review of the recommendations is considered necessary, whether by BHEL or by the other Party, then, the matter can be remitted back to the IEC with request to reconsider the same in light of the issues projected by either/both the Parties and to submit its recommendations thereon within the following 15 days from the date of remitting of the case by either of the Parties.
10. Upon the recommendations by the Parties, with or without modifications, as considered necessary, the IEC shall be called upon to draw up the Draft Settlement Agreement in terms of the recommendations.
11. When a consensus can be arrived at between the parties only in regard to any one or some of the issues referred for Conciliation the draft Settlement Agreement shall be accordingly formulated in regard to the said Issue(s), and the said Settlement Agreement, if signed, by the parties, shall be valid only for the said issues. As regards the balance issues not settled, the parties may seek to resolve them further as per terms and conditions provided in the contract.
12. In case no settlement can be reached between the parties, the IEC shall by a written declaration, pronounce that the Conciliation between the parties has failed and is accordingly terminated.
13. Unless the Conciliation proceedings are terminated in terms of para 22 (b), (c) & (d) herein below, the IEC shall forward his/its recommendations as to possible terms of settlement within one (1) month from the date of last hearing. The date of first hearing of Conciliation shall be the starting date for calculating the period of 2 months.

*Pradip K. Roy*

- 14.** In case of 3 members IEC, 2 members of IEC present will constitute a valid quorum for IEC and meeting can take place to proceed in the matter after seeking consent from the member who is not available. If necessary, videoconferencing may be arranged for facilitating participation of the members. However, the IEC recommendations will be signed by all members. Where there is more than one (1) Conciliator, as a general rule they shall act jointly. In the event of differences between the Members of IEC, the decision/recommendations of the majority of the Members of IEC shall prevail and be construed as the recommendation of the IEC.
- 15.** The Draft Settlement Agreement prepared by the IEC in terms of the consensus arrived at during the Conciliation proceedings between the Parties shall be given by the IEC to both the parties for putting up for approval of their respective Competent Authority.
- 16.** Before submitting the draft settlement agreement to BHEL's Competent Authority viz. the Board Level Committee on Alternative Dispute Resolution (BLCADR) for approval, concurrence of the other party's Competent Authority to the draft settlement agreement shall be obtained by the other party and informed to BHEL within 15 days of receipt of the final draft settlement agreement by it. Upon approval by the Competent Authority, the Settlement Agreement would thereafter be signed by the authorized representatives of both the Parties and authenticated by the members of the IEC.
- 17.** In case the Draft Settlement Agreement is rejected by the Competent Authority of BHEL or the other Party, the Conciliation proceedings would stand terminated.
- 18.** A Settlement Agreement shall contain a statement to the effect that each of the person(s) signing thereto (i) is fully authorized by the respective Party(ies) he/she represents, (ii) has fully understood the contents of the same and (iii) is signing on the same out of complete freewill and consent, without any pressure, undue influence.
- 19.** The Settlement Agreement shall thereafter have the same legal status and effect as an arbitration award on agreed terms on the substance of the dispute rendered by an arbitral tribunal passed under section 30 of the Arbitration and Conciliation Act, 1996.
- 20.** Acceptance of the Draft Settlement Agreement/recommendations of the Conciliator and/or signing of the Settlement Agreement by BHEL shall however, be subject to withdrawal/closure of any arbitral and/or judicial proceedings initiated by the concerned Party in regard to such settled issues.

*Ravi K. S.*

- 21.** Unless otherwise provided for in the agreement, contract or the Memorandum of Understanding, as the case may be, in the event of likelihood of prolonged absence of the Conciliator or any member of IEC, for any reason/incapacity, the Competent Authority/Head of Unit/Division/Region/Business Group of BHEL may substitute the Conciliator or such member at any stage of the proceedings. Upon appointment of the substitute Conciliator(s), such reconstituted IEC may, with the consent of the Parties, proceed with further Conciliation into the matter either de-novo or from the stage already reached by the previous IEC before the substitution.
- 22.** The proceedings of Conciliation under this Scheme may be terminated as follows:
- a. On the date of signing of the Settlement agreement by the Parties; or,
  - b. By a written declaration of the IEC, after consultation with the parties, to the effect that further efforts at conciliation are no longer justified, on the date of the declaration; or,
  - c. By a written declaration of the Parties addressed to the IEC to the effect that the Conciliation proceedings are terminated, on the date of the declaration; or,
  - d. By a written declaration of a Party to the other Party and the IEC, if appointed, to the effect that the Conciliation proceedings are terminated, on the date of the declaration; or,
  - e. On rejection of the Draft Settlement Agreement by the Competent Authority of BHEL or the other Party.
- 23.** The Conciliator(s) shall be entitled to following fees and facilities:

Sl No	Particulars	Amount
1	Sitting fees	Each Member shall be paid a Lump Sum fee of Rs 75,000/- for the whole case payable in terms of paragraph No. 27 herein below.
2	Towards drafting of settlement agreement	In cases involving claim and/or counter-claim of up to Rs 5crores. Rs 50,000/- (Sole Conciliator) In cases involving claim and/or counter-claim of exceeding Rs 5 crores but less than Rs 10 crores.

*[Handwritten signature]*

Sl No	Particulars	Amount
		<p style="text-align: center;">Rs 75,000 (per Conciliator)</p> <p>In cases involving claim and/or counter-claim of more than Rs 10 crores.</p> <p style="text-align: center;">Rs 1,00,000/- (per Conciliator)</p> <p>Note: The aforesaid fees for the drafting of the Settlement Agreement shall be paid on the, Signing of the Settlement Agreement after approval of the Competent Authority or Rejection of the proposed Settlement Agreement by the Competent Authority of BHEL.</p>
3	Secretarial expenses	<p>Rs 10,000/- (one time) for the whole case for Conciliation by a Sole Member IEC.</p> <p>Where Conciliation is by multi member Conciliators –Rs 30,000/- (one time)- to be paid to the IEC</p>
4	<p>Travel and transportation and stay at outstation Retired Senior Officials of other Public Sector Undertakings (pay scale wise equivalent to or more than E-8 level of BHEL)</p> <p>Others</p>	<p>As per entitlement of the equivalent officer (pay scale wise) in BHEL.</p> <p>As per the extant entitlement of whole time Functional Directors in BHEL.</p> <p>Ordinarily, the IEC Member(s) would be entitled to travel by air Economy Class.</p>
5	Venue for meeting	Unless otherwise agreed in the agreement, contract or the Memorandum of Understanding, as the case may be, the venue/seat of proceedings shall be the location of the

*Rudra S. B.*

Sl No	Particulars	Amount
		concerned Unit / Division / Region / Business Group of BHEL. Without prejudice to the seat/venue of the Conciliation being at the location of concerned BHEL Unit / Division / Region / Business Group, the IEC after consulting the Parties may decide to hold the proceedings at any other place/venue to facilitate the proceedings. Unless, Parties agree to conduct Conciliation at BHEL premises, the venue is to be arranged by either Party alternately.

24. The parties will bear their own costs including cost of presenting their cases/evidence/witness(es)/expert(s) on their behalf. The parties agree to rely upon documentary evidence in support of their claims and not to bring any oral evidence in IEC proceedings.
25. If any witness(es) or expert(s) is/are, with the consent of the parties, called upon to appear at the instance of the IEC in connection with the matter, then, the costs towards such witness(es)/expert(s) shall be determined by the IEC with the consent of the Parties and the cost so determined shall be borne equally by the Parties.
26. The other expenditures/costs in connection with the Conciliation proceedings as well as the IEC's fees and expenses shall be shared by the Parties equally.
27. Out of the lump sum fees of Rs 75,000/- for Sitting Fees, 50% shall be payable after the first meeting of the IEC and the remaining 50% of the Sitting Fees shall be payable only after termination of the conciliation proceedings in terms of para 22 hereinabove.
28. The travelling, transportation and stay at outstation shall be arranged by concerned Unit as per entitlements as per Serial No. 4 of the Table at para 23 above, and in case such arrangements are not made by the BHEL Unit, the same shall be reimbursed to the IEC on actuals limited to their entitlement as per Serial No. 4 of the Table at Para 23 above against supporting documents. The IEC Member(s) shall submit necessary invoice for claiming the fees/reimbursements.

*Handwritten signature*

- 29.** The Parties shall keep confidential all matters relating to the conciliation proceedings. Confidentiality shall extend also to the settlement agreement, except where its disclosure is necessary for purposes of its implementation and enforcement or as required by or under a law or as per directions of a Court/Governmental authority/ regulatory body, as the case may be.
- 30.** The Parties shall not rely upon or introduce as evidence in any further arbitral or judicial proceedings, whether or not such proceedings relate to the Disputes that is the subject of the Conciliation proceedings:
- a.** Views expressed or suggestions made by the other party in respect of a possible settlement of the Disputes;
  - b.** admissions made by the other party in the course of the Conciliator proceedings;
  - c.** proposals made by the Conciliator;
  - d.** The fact that the other Party had indicated his willingness to accept a proposal for settlement made by the Conciliator.
- 31.** The Parties shall not present the Conciliator(s) as witness in any Alternative Dispute Resolution or Judicial proceedings in respect of a Disputes that is/was the subject of that particular Conciliation proceeding.
- 32.** None of the Conciliators shall act as an arbitrator or as a representative or counsel of a Party in any arbitral or judicial proceeding in respect of a Disputes that is/was the subject of that particular Conciliation proceeding.
- 33.** The Parties shall not initiate, during the Conciliation proceedings, any arbitral or judicial proceedings in respect of a Disputes that is the subject matter of the Conciliation proceedings except that a Party may initiate arbitral or judicial proceedings where, in his opinion, such proceedings are necessary for preserving his rights including for preventing expiry of period of limitation. Unless terminated as per the provisions of this Scheme, the Conciliation proceedings shall continue notwithstanding the commencement of the arbitral or judicial proceedings and the arbitral or judicial proceedings shall be primarily for the purpose of preserving rights including preventing expiry of period of limitation.
- 34.** The official language of Conciliation proceedings under this Scheme shall be English unless the Parties agree to some other language.

*Pradeep K. Sharma*

**Format 5 to BHEL Conciliation Scheme, 2018**  
**STATEMENT OF CLAIMS/COUNTER CLAIMS TO BE SUBMITTED TO THE**  
**IEC BY BOTH THE PARTIES**

1. Chronology of the Disputes
2. Brief of the Contract/MoU/Agreement/LOI/LOA
3. Brief history of the Disputes:
4. Issues:
5. Details of Claim(s)/Counter Claim(s):

<b>SI. No.</b>	<b>Description of claim(s)/Counter Claim</b>	<b>Amount (in INR)Or currency applicable in the contract</b>	<b>Relevant contract clause</b>

6. Basis/Ground of claim(s)/counter claim(s) (along with relevant clause of contract)

**Note**– *The Statement of Claims/ Counter Claims may ideally be restricted to maximum limit of 20 pages. Relevant documents may be compiled and submitted along with the statement of Claims/Counter Claims. The statement of Claims/Counter Claims is to be submitted to all IEC members and to the other party by post as well as by email.*

**FORMAT FOR NOTICE INVOKING CONCILIATION CLAUSE BY BHEL FOR REFERRING THE DISPUTES TO CONCILIATION THROUGH IEC**

To,

M/s. (Stakeholder's name)

Subject: **NOTICE FOR INVOCATION OF THE CONCILIATION CLAUSE OF THE CONTRACT BY BHEL**

Ref: Contract No/ MoU/Agreement/LOI/LOA& date \_\_\_\_\_.

Dear Sir/Madam,

As you are aware, with reference to above referred Contract/MoU/Agreement/LOI/LOA, certain disputes have arisen, which, in spite of several rounds of mutual discussions and various correspondences have remained unresolved. The brief particulars of our claims which arise out of the above- referred Contract/MoU/Agreement/LOI/LOA are reproduced hereunder:

Sl. No.	Claim description	Amount involved

As you are aware, there is a provision in the captioned Contract/MoU/Agreement/LOI/ LOA for referring disputes to conciliation.

In terms of Clause -----of Procedure i.e., Annexure ----- to the Contract/MoU /Agreement / LOI / LOA, we hereby seek your consent to refer the matter to Conciliation by Independent Experts Committee to be appointed by BHEL. You are invited to provide your consent in writing to proceed with conciliation into the above mentioned disputes within a period of 30 days from the date of this letter along with details of counter-claims, if any, which you might have with regard to the subject Contract/ MoU/ Agreement/ LOI/ LOA.

Please note that upon receipt of your consent in writing within 30 days of the date of receipt of this letter by you, BHEL shall appoint suitable person(s) from the BHEL Panel of Conciliators.

This letter is being issued without prejudice to our rights and contentions available under the contract and law.

Thanking you  
Yours faithfully

**Representative of BHEL**

**Note:** The Format may be suitably modified, as required, based on facts and circumstances of the case.

**FORMAT FOR NOTICE INVOKING CONCILIATION CLAUSE BY A  
STAKEHOLDER FOR REFERRING THE DISPUTES TO CONCILIATION  
THROUGH IEC**

To,  
BHEL (Head of the Unit/Division/Region/Business Group)

Subject: **NOTICE FOR INVOCATION OF THE CONCILIATION CLAUSE OF THE  
CONTRACT BY A STAKEHOLDER**

Ref: Contract No/MoU/Agreement/LOI/LOA& date \_\_\_\_\_.

Dear Sir/Madam,

As you are aware, with reference to above referred Contract/MoU/Agreement/LOI/LOA, certain disputes have arisen, which, in spite of several rounds of mutual discussions and various correspondences have remained unresolved. The brief particulars of our claims which have arisen out of the above-referred Contract/MoU/Agreement/LOI/LOA are enumerated hereunder:

Sl. No.	Claim description	Amount involved

As you are aware, there is a provision in the captioned Contract/MoU/Agreement/LOI/ LOA for referring inter-se disputes of the Parties to conciliation.

We wish to refer the above-said disputes to Conciliation as per the said Clause of the captioned Contract/MoU/Agreement/LOI/ LOA. In terms of Clause -----of Procedure i.e., Annexure ----- to the Contract/MoU /Agreement / LOI / LOA, we hereby invite BHEL to provide its consent in writing to proceed with conciliation into the above mentioned disputes within a period of 30 days from the date of this letter along with details of counter-claims, if any, which it might have with regard to the subject Contract/ MoU/ Agreement/ LOI/ LOA and to appoint suitable person(s) as Conciliator(s) from the BHEL Panel of Conciliators.

This letter is being issued without prejudice to our rights and contentions available under the contract and law.

Thanking you  
Yours faithfully

**Representative of the Stakeholder**

**Note:** The Format may be suitably modified, as required, based on facts and circumstances of the case.

**FORMAT FOR INTIMATION TO THE STAKEHOLDER ABOUT APPOINTMENT OF CONCILIATOR/IEC**

To,

M/s. (Stakeholder's name)

Subject: **INTIMATION BY BHEL TO THE STAKEHOLDER AND CONCILIATOR(S) ABOUT APPOINTMENT OF CONCILIATOR/IEC**

Ref: Contract No/MoU/Agreement/LOI/LOA& date \_\_\_\_\_.

Sir,

This is with reference to letter dated ----- regarding reference of the disputes arising in connection with the subject Contract No /MoU/Agreement/LOI/LOA to conciliation and appointment of Conciliator(s).

In pursuance of the said letter, the said disputes are assigned to conciliation and the following persons are nominated as Conciliator(s) for conciliating and assisting the Parties to amicably resolve the disputes in terms of the Arbitration & Conciliation Act, 1996 and the Procedure ---- to the subject Contract ...../MoU/Agreement/LOI/LOA, if possible.

Name and contact details of Conciliator(s)

a) .....

b) .....

c) .....

You are requested to submit the Statement of Claims or Counter-Claims (strike off whichever is inapplicable) before the Conciliator(s) in Format 5 (enclosed herewith) as per the time limit as prescribed by the Conciliator(s).

Yours faithfully,

**Representative of BHEL**

CC: To Conciliator(s)... for Kind Information please.

Encl: As above

**Note:** The Format may be suitably modified, as required, based on facts and circumstances of the case.