

TECHNICAL PRE- QUALIFICATION REQUIREMENT

Name of customer: NTPC Limited

Name of consultant: ---

Name of Project: 400/220 kV Switchyard Package for North Karanpura Super Thermal Power Project (3 X 660 MW)

Name of Item: Air Conditioned Kiosk

PQR Sr. No	PQR Description	Supporting Document to be attached
1.	Bidder must have supplied & installed at least one (1) no. of AC Kiosk as on the date of techno-commercial bid opening.	a) Copy of Purchase Orders & LR / MDCC / DI b) Installation Certificate/ Performance Certificate issued by end Customer

Prepared By: Ranajit Dey (Manager/TBEM)	Checked By: Ranajit Dey (Manager/TBEM)	Approved By: Vivek Kapil (Sr. DGM/TBEM)
---	--	---



BHARAT HEAVY ELECTRICALS LIMITED

TRANSMISSION BUSINESS ENGINEERING MANAGEMENT

DOCUMENT No.	TB-369-510-009A	Rev 01	Prepared	Checked	Approved
TYPE OF DOC.	TECHNICAL SPECIFICATION	NAME	RD	RD	VK
TITLE AIR CONDITIONED KIOSK (AC KIOSK)		SIGN	Sd/-	Sd/-	Sd/-
		DATE	22/10/21	22/10/21	22/10/21
		GROUP	TBEM	W.O. No	83011
CUSTOMER	NTPC LIMITED				
CONSULTANT	----				
PROJECT	400/220kV Switch Yard for North Karanpura Super Thermal Power Project (3 X 660 MW)				

COPYRIGHT & CONFIDENTIAL
The information in this document is the property of BHARAT HEAVY ELECTRICALS LIMITED
This must not be used directly or indirectly in any way detrimental to the interest of the
Company.

CONTENTS

Sec. No.	Description	No. of Sheets
1.	Scope, Specific Technical Requirements and Quantities	06
2.	Equipment Specification	04
3.	Project Details & General Technical Requirements	30
4.	Guaranteed Technical Particulars <u>(TO BE FILLED AT CONTRACT STAGE)</u>	02
5.	Checklist <u>(TO BE FILLED AT TENDER STAGE)</u>	04
6.	Enclosure (Typical AC Kiosk AC Controller & Fire Alarm Panel Wiring Drawing)	04

01	06/11/21	RD	RD	VK	Exclusion Clause added in Section-1				
Rev No.	Date	Altered	Checked	Approved	REVISION DETAILS				
Distribution			To	TBTS	O/C	TBMM	TBQM	TBCM	Copies
			-	-	1	1	-	-	-

**Project: 400/220 kV Switchyard Package for
North Karanpura Super Thermal Power Project (3 X 660 MW)
Customer: NTPC Limited
Consultant: -----
Technical Specification: AIR CONDITIONED KIOSK**

**Bharat Heavy Electricals Limited
Document No. TB-369-510-009A**

SECTION 1

SCOPE, SPECIFIC TECHNICAL REQUIREMENTS AND QUANTITIES

1.0 SCOPE

This technical specification covers the requirements of design, manufacture, testing at works, packing, dispatch of Air Conditioned Kiosk and installation & erection of the same at site.

This section covers the specific technical requirements of AC KIOSK. In case of any discrepancies between the requirements mentioned in this section and those specified in the following sections of this specification, the specifications given herein shall prevail and shall be treated as binding requirements.

1.1 The equipment is required for the following project.

Name of customer : **NTPC Limited**

Name of consultant : -----

Name of Project : **400/220 kV Switchyard Package at North Karanpura Super Thermal Power Project (3 X 660 MW)**

Refer Section - 3 for Project Details and General Specifications.

1.2 SPECIFIC TECHNICAL REQUIREMENTS

1.2.1 As per attached Annexure-I (NTPC specification, 3 pages).

1.2.2 The dimension of A.C. Kiosk (Type-A) shall be 8.0m x 3.5m x 3m ~~and for A.C. Kiosk (Type-B) shall be 7.0m x 3.5m x 3m.~~

1.2.3 A.C. Kiosk (Type-A) shall be provided with Air-Conditioning Unit of capacity : 2x(2x2 TR) ~~and A.C. Kiosk (Type-B) shall be provided with Air Conditioning Unit of capacity 2x(2x2 TR).~~

(Please refer Section-6 enclosures for tentative location of air-conditioning unit in the A.C. Kiosk)

1.3 QUANTITY

Sl. No.	Description	Quantity
1	Air Conditioned Kiosk Size L x B x H (8.0m x 3.5m x 3m) without Air Conditioners	1 No.
2	Air Conditioning Unit of capacity 4TR with all the accessories *	2 Nos.
3	Installation & Erection of Air Conditioned Kiosk at site (including Air Conditioning Unit)	1 No.
4	Proto Testing of Air Conditioned Kiosk at Works	1 No.

Note:

1. The above quantities are subject to change by $\pm 50\%$ at contract stage.
2. Some of the items may not be ordered by BHEL at contract stage.
3. * The Air Conditioning Units are to be mounted inside the AC Kiosk along with all its accessories. The complete installation of Air Conditioners along with its accessories inside the AC Kiosk shall be in bidder's scope. Bidder to include the price of the same when quoting for Sl. No. 3 of the BOQ above.

1.4 TYPE TEST & ROUTINE TEST

All equipment being supplied shall conform to type tests and shall be subject to routine tests in accordance with requirements stipulated under respective sections. The reports for all type tests and additional type tests shall be furnished by the bidder alongwith equipment / material drawings.

1.5 MANUFACTURING QUALITY PLAN

Manufacturer shall follow Standard Manufacturing Quality Plan of Power Grid Corporation of India Ltd/customer.

1.6 TECHNICAL PRE QUALIFYING REQUIREMENTS

Bidder must have supplied & installed at least one (1) no. of AC Kiosk as on the date of techno-commercial bid opening.

**Project: 400/220 kV Switchyard Package for
North Karanpura Super Thermal Power Project (3 X 660 MW)
Customer: NTPC Limited
Consultant: -----
Technical Specification: AIR CONDITIONED KIOSK**

**Bharat Heavy Electricals Limited
Document No. TB-369-510-009A**

1.7 DOCUMENTS REQUIRED WITH OFFER

- a) "No Technical Deviation" Certificate
- b) Un-priced schedule
- c) Filled up Checklist

1.8 DRAWINGS / DOCUMENTS REQUIRED FOR ENGINEERING MANUFACTURING CLEARANCE

The minimum drawings/ documents, as follows shall be required for providing engineering manufacturing clearance of the equipment (AC Kiosk) and furthermore, it shall be used for delay analysis, if any, on account of the bidder. The schedule for submission and resubmission shall be in line with details provided in section-3.

1	OGA, BOM/ Component List with Wiring Diagrams
2	Quality Assurance Plan & Inspection Test Schedule

1.9 PACKING AND DISPATCH

The equipment shall be properly packed for selected mode of transportation i.e. sea, rail and road in such a manner that it is protected against the climatic conditions and for any damage during transportation, transit and storage. The equipments shall be wrapped in polyethylene sheets before being placed in wooden crates/cases to prevent damage to the finish. Crates/cases shall have skid bottoms for handling. Special notations such as 'Fragile', 'This side up', 'Weight', 'Owner's particulars\ 'PO nos.' etc., shall be clearly marked on the package together with other details as per purchase order.

The equipment may be stored outdoors for long periods before installation. The packing should also be suitable for outdoor storage areas with heavy rains/ high ambient temperature unless otherwise agreed and hence, packing shall be suitable for long duration storage (minimum 1 year).

1.10 EXCLUSIONS

Following activities at site are not included in the present scope of bidder:

- a) Unloading, Storage and handling between store & place of erection at site.
- b) Necessary Civil Foundation for installing the AC Kiosk.

ANNEXURE - I

CLAUSE NO.	TECHNICAL REQUIREMENTS																																										
	ANNEXURE-I Specification for Bay Kiosk																																										
	<p>1. Construction:</p> <p>The Bay Kiosk shall be made of "sandwich insulated panels" 80 mm thick with polyUrethane Foam (PUF) as filler material between polyester pre-coated cold rolled Steel. The insulation characteristics of PUF material shall conform to following requirement</p> <table border="1" style="width: 100%; border-collapse: collapse;"> <thead> <tr> <th style="width: 10%;">Sl. No.</th> <th style="width: 60%;">Particular</th> <th style="width: 30%;">Parameters</th> </tr> </thead> <tbody> <tr> <td>1.</td> <td>Thickness</td> <td>78.6 mm</td> </tr> <tr> <td>2.</td> <td>Density</td> <td>40 kg/m³</td> </tr> <tr> <td>3.</td> <td>Compressive Strength</td> <td>1.2 kg.cm³</td> </tr> <tr> <td>4.</td> <td>Tensile Strength</td> <td>3.6 kg/m²</td> </tr> <tr> <td>5.</td> <td>Bending Strength</td> <td>4.0 Kg/m²</td> </tr> <tr> <td>6.</td> <td>Adhesion Strength</td> <td>2.9 Kg/m²</td> </tr> <tr> <td>7.</td> <td>Dimension Stability</td> <td>At -25° C : 0.1% and at 38° C : 0.4%</td> </tr> <tr> <td>8.</td> <td>Temperature Range</td> <td>-15° C to 95° C</td> </tr> <tr> <td>9.</td> <td>Thermal Conductivity</td> <td>0.02 kcal/hr/m/oC</td> </tr> <tr> <td>10.</td> <td>Fire Resistance</td> <td>As per BS-4735 Horizontal Burn <125 mm</td> </tr> <tr> <td>11.</td> <td>Water absorption</td> <td>0.2% @ 100% RH</td> </tr> <tr> <td>12.</td> <td>Vapour Permeability</td> <td>0.08/0.12 g/hr/m²</td> </tr> <tr> <td>13.</td> <td>Self Extinguishing</td> <td>Yes</td> </tr> </tbody> </table> <p>The thickness of the inner-side and outer steel sheet except floor panel sheet shall be minimum 0.8 mm and 0.6 mm respectively. The outer bottom sheet shall be hot dip galvanised steel sheets of minimum 1.0 mm thickness to avoid rusting at bottom. The sandwich panels shall be manufactured by high pressure injection techniques. The floor of the kiosk shall be suitably designed for accommodating the control and relay IEDs in the panels. The adequate lighting shall be provided in the kiosk. The Kiosk shall have adequate space for working and maintain Clearances as per requirement of Indian Electricity Rules. The kiosk shall be provided with locking arrangement. The Kiosks shall have IP-55 degree of protection. The cable entries in the Kiosk shall be provided only from the side of the Kiosk. It shall be possible to lay additional cables in future for the panels without disturbing the existing facilities.</p> <p>2. Air-Conditioning:</p> <p>The air conditionings system shall be provided in the Kiosks to be used for housing panels having control and protection IEDs for performing sub-station automation and protection functions. generally comply with relevant IS codes-. These kiosks shall be placed in the switchyard area generally unmanned; therefore, the air-conditioning system shall be rugged, reliable, maintenance free and designed for long life.</p> <p>i. Operation:</p> <p>The air conditioning is required for critical application i.e. for maintaining the temperature for critical sub-station control and protection equipment. To provide redundancy for such</p>	Sl. No.	Particular	Parameters	1.	Thickness	78.6 mm	2.	Density	40 kg/m ³	3.	Compressive Strength	1.2 kg.cm ³	4.	Tensile Strength	3.6 kg/m ²	5.	Bending Strength	4.0 Kg/m ²	6.	Adhesion Strength	2.9 Kg/m ²	7.	Dimension Stability	At -25° C : 0.1% and at 38° C : 0.4%	8.	Temperature Range	-15° C to 95° C	9.	Thermal Conductivity	0.02 kcal/hr/m/oC	10.	Fire Resistance	As per BS-4735 Horizontal Burn <125 mm	11.	Water absorption	0.2% @ 100% RH	12.	Vapour Permeability	0.08/0.12 g/hr/m ²	13.	Self Extinguishing	Yes
Sl. No.	Particular	Parameters																																									
1.	Thickness	78.6 mm																																									
2.	Density	40 kg/m ³																																									
3.	Compressive Strength	1.2 kg.cm ³																																									
4.	Tensile Strength	3.6 kg/m ²																																									
5.	Bending Strength	4.0 Kg/m ²																																									
6.	Adhesion Strength	2.9 Kg/m ²																																									
7.	Dimension Stability	At -25° C : 0.1% and at 38° C : 0.4%																																									
8.	Temperature Range	-15° C to 95° C																																									
9.	Thermal Conductivity	0.02 kcal/hr/m/oC																																									
10.	Fire Resistance	As per BS-4735 Horizontal Burn <125 mm																																									
11.	Water absorption	0.2% @ 100% RH																																									
12.	Vapour Permeability	0.08/0.12 g/hr/m ²																																									
13.	Self Extinguishing	Yes																																									
NORTH KARANPURA STPP (3 X 660 MW) EPC PACKAGE	TECHNICAL SPECIFICATIONS SECTION VI, PART-B BID DOC. NO.:CS-4410-001-2	SUB SECTION B-14 SWITCHYARD	Page 48 of 102																																								

CLAUSE NO.	<p style="text-align: center;">TECHNICAL REQUIREMENTS</p> 		
	<p>critical applications, each kiosk shall be installed with environment control system comprising of two units of air conditioners working in conjunction through a micro processor based controller for desired operation. The system shall be designed for 24 Hours, 365 Days of the year to maintain the inside kiosk temperature for proper operation of the critical equipment. One of the air-conditioner shall be running at a time and on failure of the same or as described hereunder, the other unit shall start automatically. To ensure longer life of the system, the redundant units shall also be running in cyclic operation through the controller. However, during running of one air-conditioner unit, if inside temperature of the shelter reaches to a predefined (i.e. 35°C), the other unit shall start running to maintain the temperature to specified value (i.e.23+2°C) and gives alarm for such situation. After achieving this temperature, the other unit shall again shut off.</p> <p>ii. Sequence of Operation of the Unit:</p> <p>Suitable arrangement shall be made to operate the unit in the following order. However, the actual operation arrangement shall be finalised during detailed engineering.</p> <ol style="list-style-type: none"> 1. Evaporator Fan 2. Condenser Fan 3. Compressor <p>iii. Construction:</p> <p>The air conditioning unit shall be completely self-contained. All components of the units shall be enclosed in a powder coated cabinet and colour of same shall be matched with kiosk colour. The unit shall be assembled, wired, piped, charged with refrigerant and fully factory tested as a system to ensure trouble free installation and start up. Suitable isolation or other by passing arrangement shall be provided such that any unit/component could be maintained/ repaired without affecting the running standby unit. The maintenance of unit shall be possible from outside the kiosk.</p> <p>iv. Required Features of Various Components:</p> <p>The compressor shall be very reliable, trouble free and long life i.e. hermitically sealed Scroll type of reputed make suitable for operation. Compressor should be installed on vibration isolated mountings or manufacturer's recommended approved mounting. Valve shall be provided for charging/topping up of refrigerant. The bidder shall furnish details of their compressor indicating the MTBF, life of compressor and continuous run time of compressor without failure. The contractor shall also furnish details of all accessories i.e. refrigeration system, evaporator coil, condenser coil, evaporator blower filter, cabinet, indoor supply and return grill etc.</p> <p>v. The kiosk shall be erected at least 300 mm above the finished ground level with suitable pedestal to avoid any entry of water.</p> <p>3. Proto Testing:</p> <p>One kiosk meeting the specified requirement as described above, shall be fabricated at the factory and offered for proto inspection at the factory. This proto shall be equipped with all required accessories like air-conditioning system, fire and smoke detector, lighting, various cut outs etc. The offered kiosk shall be inspected for finish, all fittings and accessories, opening including doors and locks. The kiosk shall be tested for dust</p>		
<p style="text-align: center;">NORTH KARANPURA STPP (3 X 660 MW) EPC PACKAGE</p>	<p style="text-align: center;">TECHNICAL SPECIFICATIONS SECTION VI, PART-B BID DOC. NO.:CS-4410-001-2</p>	<p style="text-align: center;">SUB SECTION B-14 SWITCHYARD</p>	<p style="text-align: center;">Page 49 of 102</p>

CLAUSE NO.	<div style="text-align: center;">TECHNICAL REQUIREMENTS</div> 		
	<p>and rain protection to check out any leakage and air tightness. The following main tests shall be carried out:</p> <p>(a) Illumination inside the kiosk shall be switched off and it shall be checked that no light enters through panel joints, holes and other joints in the kiosk.</p> <p>(b) Water Leakage Test (with a water pipe with suitable pressure from all sides for one hour.)</p> <p>(c) Working and functional tests of all accessories like air-conditioning system, fire and smoke detector, lighting arrangements as per technical specification</p> <p>(d) Start up test for air conditioner</p> <p>(e) Satisfactory operation of air conditioner installed on Kiosk.</p> <p>(f) The total heat load for panels and devices to be placed inside the kiosk including PLCC, all IEDs etc. shall be calculated and equivalent calculated heating load (maximum value from among the calculated values for various kiosk) shall be placed inside the kiosk and the kiosk shall be made operational for four hours with all accessories and inside & outside temperature of kiosk shall be recorded.</p> <p>On successful completion of proto testing, all other system shall be manufactured after incorporation of all alteration/modifications observed/suggested during/after proto testing.</p> <p>The detail test procedure shall be submitted by the contractor and get it approved from the owner before commencement of proto testing.</p>		
9.00.00	INSTALLATION		
9.01.00	EARTHING		
	<p>The earthing shall be done in accordance with requirements given in Annexure-I of this section and drawing enclosed with the specifications. Earthing of panels shall be done in line with the requirements given in respective equipment section of this specification. The cost of welding laying etc. of earth flats and rods is deemed to be included in the cost of respective item.</p>		
9.02.00	CIVIL WORKS		
	<p>The civil works shall be done in accordance with requirements stipulated elsewhere in this specification.</p>		
9.03.00	STRUCTURAL STEEL WORKS		
	<p>The structural steel works shall be done in accordance with requirements stipulated elsewhere in this specification.</p>		
9.04.00	BAY EQUIPMENT		
9.04.01	<p>The disposition of equipment to be supplied are shown in enclosed single line diagrams and layout drawings.</p>		
<p style="text-align: center;">NORTH KARANPURA STPP (3 X 660 MW) EPC PACKAGE</p>	<p style="text-align: center;">TECHNICAL SPECIFICATIONS SECTION VI, PART-B BID DOC. NO.:CS-4410-001-2</p>	<p style="text-align: center;">SUB SECTION B-14 SWITCHYARD</p>	<p style="text-align: center;">Page 50 of 102</p>

B
B
B
B

SECTION-2

EQUIPMENT SPECIFICATION

2.0 SCOPE

This technical specification covers the requirements of design, manufacture, testing at works, packing and despatch of AC KIOSK and its accessories. No deviation from the requirements specified in various clauses of this specification shall be allowed.

2.1 APPLICABLE STANDARDS

STANDARD	TITLE
IS 13947(Part 1) IS 5039	Low voltage switchgear and control gear: General rules Distribution feeder pillars for voltages not exceeding 1000V ac / 1200V dc.
IS 8623	Specification for Low voltage Switchgear and Control gear Assemblies
IEC 60439	Factory built assemblies of low voltage switchgear and control gear
IS 13703 (All Parts):	Specification for Low-Voltage Fuses for Voltages not exceeding 1000V AC and 1500V DC - General Requirements

The equipment shall conform to the latest applicable Indian standard and their amendments. The equipment complying with any authorised international standard will also be considered if it ensures performance equivalent to or superior to Indian standards. In the event of supply of equipment conforming to any internationally recognised standard other than the Indian standards, the salient features of comparison shall be brought out.

2.2 TECHNICAL SPECIFICATION

2.2.1 Construction:

The Kiosk shall be made of "sandwich insulated panels" 80 mm thick with Poly Urethane Foam (PUF) as filler material between polyester pre-coated cold rolled steel. The insulation characteristics of PUF material shall conform to following requirement:

1. Thickness 78.6 mm
2. Density 40 kg/m³
3. Compressive Strength 1.2 kg.cm³
4. Tensile Strength 3.6 kg/m²
5. Bending Strength 4.0 Kg/m²
- 6 Adhesion Strength 2.9 Kg/m²
7. Dimension Stability At -25° C : 0.1%; at 38° C : 0.1% and above 38° C : 0.4%
8. Temperature Range -15° C to 95° C

9. *Thermal Conductivity 0.02 kcal/hr/m²°C*
10. *Fire Resistance as per BS-4735 Horizontal Burn <125 mm*
11. *Water absorption 0.2% @ 100% RH*
12. *Vapour Permeability 0.08/0.12 g/hr/m²*
13. *Self Extinguishing*

The thickness of the inner-side and outer steel sheet except floor panel sheet shall be minimum 0.8mm and 0.6mm respectively. The outer bottom sheet shall be hot dip galvanised steel sheets of minimum 1.0mm thickness to avoid rusting at bottom. The sandwich panels shall be manufactured by high pressure injection techniques. The floor of the kiosk shall be suitably designed for accommodating the control and relay IEDs in the panels. The adequate lighting (350 Lux at floor level) shall be provided in the kiosk complete with conduits, fixtures, luminaries, wires, earthing wires, switches & receptacles. One lighting fixture complete with luminaries and wiring shall also be provided just outside the kiosk on each exit doors. The Kiosk shall have adequate space for working and maintain clearances as per requirement of Indian Electricity Rules. The kiosk shall be provided with locking arrangement.

The kiosk shall be erected at least 300 mm above the finished ground level with suitable pedestal to avoid any entry of water. Suitable structural steel stairs shall be provided/fabricated for entry/exit from each door of the kiosk.

Bidder shall make provision of earthing the kiosk and its internal housings viz., control & protection panels, AC units, distribution boards. This shall include provision of earthing flats and necessary bolts.

Bidder shall give the required civil design inputs to BHEL to enable erection of these kiosks at site. The scope includes supply of base channel framework for erecting the kiosk & AC units on foundation built by BHEL. The scope also includes supply of base channel for erecting the AC units, control & protection panels and PLCC panels to be housed inside the kiosk.

2.2.2 Air-Conditioning:

The air conditioning system shall be provided in the kiosks to be used for housing panels having control and protection IEDs for performing sub-station automation and protection functions. These kiosks shall be placed in the switchyard area generally unmanned; therefore, the air-conditioning system shall be rugged, reliable, maintenance free and designed for long life.

(i) Operation:

The air conditioning is required for critical application i.e. for maintaining the temperature for critical sub-station control and protection equipment. To provide redundancy for such critical applications, each kiosk shall be installed with environment control system comprising of two units of air conditioners working in conjunction through a micro processor based controller for desired operation. The system shall be designed for 24 Hours, 365 Days of the year to maintain the inside kiosk temperature for proper operation of the critical equipment. One of the air-conditioner shall be running at a time and on failure of the same or as described hereunder, the other unit shall start automatically. To ensure longer life of the system, the redundant units shall also be running in cyclic operation through the controller. However, during running of one air-conditioner unit, if inside temperature of the shelter reaches to a predefined (i.e. 35° C), the other unit shall start running to maintain the temperature to

specified value (i.e. $23 \pm 2^\circ$ C) and gives alarm for such situation. After achieving this temperature, the other unit shall again shut off.

(ii) Sequence of Operation of the Unit:

Suitable arrangement shall be made to operate the unit in the following order. However, the actual operation arrangement shall be finalised during detailed engineering.

1. Evaporator Fan
2. Condenser Fan
3. Compressor

(iii) Construction:

The air conditioning unit shall be completely self-contained. All components of the units shall be enclosed in a powder coated cabinet and colour of same shall be matched with kiosk colour. The unit shall be assembled, wired, piped, charged with refrigerant and fully factory tested as a system to ensure trouble free installation and start up. Suitable isolation or other by passing arrangement shall be provided such that any unit/component could be maintained/ repaired without affecting the running standby unit. The maintenance of unit shall be possible from outside the kiosk.

(iv) Required Features of Various Components:

The compressor shall be very reliable, trouble free and long life i.e. hermitically sealed scroll type of reputed make suitable for operation. Compressor should be installed on vibration isolated mountings or manufacturer's recommended approved mounting. Valve shall be provided for charging/topping up of refrigerant. The bidder shall furnish details of their compressor indicating the MTBF, life of compressor and continuous run time of compressor without failure. The contractor shall also furnish details of all accessories i.e. refrigeration system, evaporator coil, condenser coil, evaporator blower filter, cabinet, indoor supply and return grill etc.

2.2.3 Fire Alarm Panel & Smoke Detectors

2.2.3.1 Each kiosk shall be provided with microprocessor based 2 Zone Fire alarm system complete with following essential features/ fitments

- Ionisation type Smoke detectors,
- Hooter,
- Wiring & conduits,
- Fixing & mounting hardware for fire alarm panel & smoke detectors
- Control scheme complete with heavy duty contactors, wiring etc for tripping the power supply to Air Conditioner units in case of fire.
- Potential free fire alarm contacts shall be made available for its wiring to SAS.

2.2.3.2 Aux supply available for the fire alarm panel in the kiosk shall be 230V AC / 220V DC.

2.2.4 Auxiliary Power Circuit Distribution

The wall mounted distribution board shall receive two incoming 415V, 3 phase AC supplies through 2 Nos TPN MCB with auto-changeover including timers, for its further use in air conditioning, lighting, fire alarm panel etc to be housed inside the kiosk. These MCBs shall have the aux contact (1 NO and 1 NC) for wiring "Aux Supply Fail alarm" signal to SAS

(BCU Panel). The terminal blocks used for above mentioned aux power incomer circuits shall be suitable for 3.5x35 sq mm cable.

Provision for remote control of AC units (i.e. making them ON and OFF) from SAS (BCU Panel) shall be made by offering control scheme complete with power contactors. The control DC from SAS shall be 220V DC.

2.2.5 Proto Testing:

One kiosk meeting the specified requirement as described above, shall be fabricated at the factory and offered for proto inspection at the factory. This proto shall be equipped with all required accessories like air-conditioning system, fire and smoke detector, lighting, various cut outs etc. The offered kiosk shall be inspected for finish, all fittings and accessories, opening including doors and locks. The kiosk shall be tested for dust and rain protection to check out any leakage and air tightness. The following main tests shall be carried out:

- (a) Illumination inside the kiosk shall be switched off and it shall be checked that no light enters through panel joints, holes and other joints in the kiosk.
- (b) Water Leakage Test (with a water pipe with suitable pressure from all sides for one hour.)
- (c) Working and functional tests of all accessories like air-conditioning system, fire and smoke detector, lighting arrangements as per technical specification
- (d) Start up test for air conditioner
- (e) Satisfactory operation of air conditioner installed on Kiosk.
- (f) The total heat load for panels and devices to be placed inside the kiosk including all IEDs etc. shall be calculated and equivalent calculated heating load (maximum value from among the calculated values for various kiosk) shall be placed inside the kiosk and the kiosk shall be made operational for four hours with all accessories and inside & outside temperature of kiosk shall be recorded.

On successful completion of proto testing, all other system shall be manufactured after incorporation of all alteration/modifications observed/suggested during/after proto testing. The detail test procedure shall be submitted by the contractor and get it approved from the owner before commencement of proto testing.

2.2.6 Cable Entry:

The cable entries in the Kiosk shall be provided only from the side of the Kiosk. It shall be possible to lay additional cable in the future for the panels without disturbing the existing cable facility.

PROJECT: 400/220kV Switchyard for North Karanpura Super TPP (3x660MW)
CUSTOMER: NTPC LTD.
Section-3: Project Details and General Specification REV.00

SECTION- 3

PROJECT DETAILS AND GENERAL SPECIFICATIONS

3.0 GENERAL

This section stipulates the General Technical Requirements under the Contract and will form an integral part of the Technical Specification.

The provisions under this section are intended to supplement general requirements for the materials, equipment and services covered under other sections of tender documents and are not exclusive. However in case of conflict between the requirements specified in this section and requirements specified under other sections, the requirements specified under respective sections shall prevail.

3.1 PROJECT DETAILS

S. No.	Particular	Details
a)	Customer	NTPC Ltd.
b)	Engineer/Consultant/ Inspector	NTPC Ltd.
c)	Project Title	North Karanpura Super Thermal Power Project (3x660 MW) : 400/220kV Switchyard at NKSTPP end & 220kV Sub-station at Mine end
d)	Project Location	Place: Near Tandwa town District: Hazaribagh & Chatra State: Jharkhand
e)	Latitude & Longitude	400/220kV S/s at NKSTPP: North: 23°50' to 23°52' and East: 84°59' to 85°2' 220kV S/s at Chatti Bariatu & Kerandari-A mine: North: 23°52'35" and East: 85°05'25"
f)	Nearest Railway Station	Khalari Railway Station Ranchi-Garhwa section of Eastern Railways
g)	Distance of project location from the Railway station	40 Km (approx.)
h)	Nearest Major Town	Hazaribagh city
i)	Distance of the town from the project site	50 Km.
j)	Nearest commercial airport	Ranchi
k)	Distance of airport from the project site	150 Km
<u>SITE CONDITIONS</u> (for design purposes)		
a)	Design ambient temperature	50°C
b)	Maximum Relative humidity	95 %
c)	Height above mean sea level	Less than 1000 meters
d)	Pollution Severity	Heavily polluted (With Coal dust & Fly ash) and Highly Corrosive environment.
e)	Criteria for Wind Resistant design of structures and equipment	Standard Applicable - IS 875 (Part 3) 1987
f)	Basic Wind speed "Vb" at ten	39 m/ sec

PROJECT: 400/220kV Switchyard for North Karanpura Super TPP (3x660MW)
CUSTOMER: NTPC LTD.

Section-3: Project Details and General Specification

REV.00

	meters above the mean ground level.	
g)	Category of terrain	Cat -2
h)	Risk Coefficient "K1"	1.06

3.1.1 SYSTEM PARAMETERS:

S. No.	Parameters	400 kV	220 kV
1	Highest system voltage	420 kV rms	245 kVrms
2	Lightning Impulse voltage	±1425kVp	± 1050kVp
3	Switching impulse voltage	±1050kVp	-
4	Power frequency withstand for 1 min (rms)	630 kV(rms)	460 kV(rms)
5	Max. fault level (1 sec.)	50 kA	40kA
6	Minimum creepage distance	10500 mm	6125mm

3.1.2 AUXILIARY POWER:

S. No.	Nominal Connection Voltage	Variations in Voltage	Frequency	Phase	Neutral
1	415V	±10%	50 (+3% -5%)	3Phase , 4 Wire	Solidly Earthed
2	240V	±10%	50 (+3% -5%)	1 phase	Solidly Earthed

Combined variation of voltage and frequency shall be + 10%. Design fault level of 415V system shall be restricted to 50kA rms for 1 second.

The operational limits for variation of DC voltage are (+) 10% to (-) 15%.

3.1.3 The various minimum heights of the switchyard shall be as given below from plinth level:

Voltage	Equipment /1st Level	2nd Level	3rd Level	Peak
220kV	6000mm	12000mm	17000mm	8500mm
400kV	8000mm	16000mm	23000mm	8500mm

The minimum vertical distance from the bottom of the lowest porcelain part of the bushing, porcelain enclosures or support insulators to the bottom of the equipment structure, where it rests on the foundation pad shall be 2550mm.

The minimum height of intermediate gantry tower for 400kV wherever required shall be 25 m and the peak (s) shall be of 8.5 m.

3.1.4 The minimum clearances for 400kV & 220 kV switchyards shall be as given below:

	400kV	220kV
Phase to earth clearance	3500 mm	2100mm
Phase to phase clearance	4000 mm	2100mm
Section clearance	6500 mm	5000mm

3.2 INSTRUCTION TO BIDDERS:

The bidders shall submit the technical requirements, data and information as per the technical data sheets, provided in Section-4.

The bidders shall furnish catalogues, engineering data, technical information, design documents, drawings etc fully in conformity with the technical specification.

It is recognized that the bidders may have standardized on the use of certain components, materials, processes or procedures different than those specified herein. Alternate proposals offering similar

equipment based on the manufacturer's standard practice will also be considered provided such proposals meet the specified designs, standard and performance requirements and are acceptable to the Purchaser. Unless brought out clearly, the Bidder shall be deemed to conform to this specification scrupulously. All deviations from the specification shall be clearly brought out in the respective schedule of deviations. Any discrepancy between the specification and the catalogues or the bid, if not clearly brought out in the schedule, will not be considered as valid deviation.

Except for lighting fixtures, wherever a material or article is specified or defined by the name of a particular brand, Manufacturer or Vendor, the specific name mentioned shall be understood as establishing type, function and quality and not as limiting competition. For lighting fixtures, makes shall be as defined in Section-Lighting System.

Equipment furnished shall be complete in every respect with all mountings, fittings, fixtures and standard accessories normally provided with such equipment and/ or needed for erection, completion and safe operation of the equipment as required by applicable codes, though they may not have been specifically detailed in the Technical Specifications unless included in the list of exclusions. Materials and components not specifically stated in the specification but which are necessary for commissioning and satisfactory operation of the switchyard unless specifically excluded shall be deemed to be included in the scope of the specification and shall be supplied without any extra cost. All similar standard components/parts of similar standard equipment under supply shall be inter-changeable with one another.

The bidder shall supply type tested (including special tests as per tech. specification) equipment and materials. The test reports shall be furnished by the bidder along with equipment/ material drawings. In the event of any discrepancy in the test reports, (i.e., if any test report is not acceptable due to any design/ manufacturing changes or due to non-compliance with the Technical Specification and/ or applicable standard), the tests shall be carried out without any additional cost implication to the BHEL. BHEL reserves the right to get any or all type/tests conducted/repeated.

3.3 CODES AND STANDARDS

The supplier is required to follow local statutory regulations stipulated in the latest amended Electricity Supply Act 1948 and Indian Electricity Rules 1956 (latest), and other local rules and regulations.

The equipment to be furnished under this specification shall conform to latest issue with all amendments of standards and/ or codes specified under respective section heads. The standards mentioned in the specification are not mutually exclusive or complete in them, but intended to complement each other. The supplier shall also note that list of standards presented in this specification is not complete. Whenever necessary the list standards shall be considered in conjunction with specific IS/IEC. When the specified requirements stipulated in the specifications exceed or differ than those required by the applicable standards, the stipulation of the specification shall take precedence.

Other internationally accepted standards which ensure equivalent or better performance that specified in the standards referred under section shall also be acceptable.

In case governing standards for the equivalent for the equipment is different from IS/ IEC, the salient points of difference shall be clearly brought out in additional information schedule along with English language version of standard of relevant extract of the same. The equipment conforming to standards other than IS/ IEC shall be subject to Purchaser's approval.

The full names of the codes and standards mentioned in abbreviations under various equipment heads are as follows:

BS British Standards
IEC/ CISPR International Electro-technical Commission

IS	Bureau of Indian Standards
ISO	International Organization for Standards
NEMA	National Electric Manufacturers Association

3.4 SERVICES TO BE PERFORMED BY THE EQUIPMENT BEING FURNISHED

The 400 kV system is being designed to limit the power frequency over voltage of 1.5 p.u. and the switching surge over voltage to 2.5 p.u. In 400 kV system the initial value of temporary over voltage could be 2.0 p.u. for 1-2 cycles. All the equipment/materials covered in this specification shall perform all its function satisfactorily without undue strain, restrike etc. under such over voltage conditions. All equipment shall also perform satisfactorily under various other electrical, electromechanical and meteorological conditions of the site of installation. All equipment shall be able to withstand all external and internal mechanical, thermal and electromechanical forces due to various factors like wind load, temperature variation, ice & snow, (not applicable for this project) short circuit etc for the equipment .

The equipment shall also comply with the following:

- a) All equipments shall be suitable for hot line washing.
- b) To facilitate erection of equipment, all items to be assembled at site shall be "match marked".
- c) Piping, if any, between equipment control cabinet or operating mechanism to marshalling box of the equipment shall bear proper identification to facilitate the connection at site.
- d) All equipment shall be supplied with necessary inter-pole cabling, and its cost shall be included in the cost of equipment.

3.5 ENGINEERING DATA

3.5.1 Drawings

All drawings submitted by the supplier including those submitted at the time of bid shall be in sufficient detail to indicate the type, size, arrangement, material description, Bill of Materials, weight of each component, break-up for packing and shipment, the external connections, fixing arrangement required. The dimensions required for installation and interconnections with other equipment and materials, clearances and spaces required for installation and interconnections between various portions of equipment and any other information specifically requested in the specifications.

Each drawing submitted by the Contractor (including those of sub-vendors) shall bear a title block at the right hand bottom corner with clear mention of the name of the Employer, the system designation, the specifications title, the specification number, the name of the Project, drawing number and revisions. If standard catalogue pages are submitted, the applicable items shall be indicated therein. All titles, noting, markings and writings on the drawing shall be in English. All the dimensions should be in metric units.

After the approval of the drawings, further work by the Contractor shall be in strict accordance with these drawings and no deviation shall be permitted without the written approval of the Purchaser, if so required.

The review of these data by the purchaser will cover only general conformance of the data to the specification and documents, interfaces with the equipment provided under specification, external connections and of the dimensions which might affect plan layout. This review by the purchaser may not indicate a thorough review of the dimensions, quantities and details of the equipment, material, any devices or items indicated or the accuracy of the information submitted. This review and/or approval by the purchaser shall not be considered by the contractor, as limiting any of his responsibilities and liabilities for mistakes and deviations from the requirements, specified under these specifications and documents.

All manufacturing and fabrication work in connection with the equipment prior to the approval of the drawings shall be at the Contractor's risk. The Contractor may make any changes in the design which are necessary to make the equipment conform to the provisions and intent of the Contract and such changes will again be subject to approval by the Purchaser. Approval of Contractor's drawing or work by the Purchaser shall not relieve the contractor of any of his responsibilities and liabilities under the Contract.

All engineering data submitted by the contractor after final process including review and approval by the purchaser shall form part of the contract document and the entire work performed under these specifications shall be performed in strict conformity, unless otherwise expressly requested by the purchaser in writing.

3.5.2 Approval Procedure

The following procedure for submission and review/approval of the drawings, data, reports, information, etc. shall be followed by Contractor:

- a. All data/information furnished by Vendor in the form of drawings, documents, Catalogues or in any other form for NTPC's information/interface and/or review and approval are referred by the general term "drawings".
- b. The 'Master drawings list' indicating titles, Drawing Number, Date of submission and approval etc. shall be finalised mutually between Contractor and Employer before the award of contract. This list shall be updated if required at suitable interval during detailed engineering.
- c. All drawings (including those of subvendor's) shall bear at the right hand bottom corner the 'title plate' with all relevant information duly filled in. The Contractor shall furnish this format to his subvendor along with his purchase order for subvendor's compliance.
- d. Contractor shall submit all the drawings in five (5) copies for review of Employer. Employer shall forward their comments within four (4) weeks of receipt of drawings.
- e. Upon review of each drawings, depending on the correctness and completeness of the drawings, the same will be categorised and approval accorded in one of the following categories:

CATEGORY I	Approved
CATEGORY II	Approved subject to incorporation of comments/modification as noted. Resubmit revised drawing incorporating the comments
CATEGORY III	Not approved. Resubmit revised drawings for Approval after incorporating comments/modifications as noted
CATEGORY IV	For information and records

- f. Contractor shall resubmit the drawings approved under Category II, III within one (1) week of receipt of comments on the drawings, incorporating all comments. Every revision of the drawing shall bear a revision index wherein such revisions shall be highlighted in the form of description or marked up in the drawing identifying the same with relevant revision number enclosed in a triangle (e.g 1.2.3. etc.).
- g. In case Contractor does not agree with any specific comment, he shall furnish the explanation for the same to Employer consideration. In all such cases Contractor shall necessarily enclose explanations along with the revised drawing (taking care of balance comments) to avoid any delay and/or duplication in review work.
- h. It is the responsibility of the Contractor to get all the drawings approved in the Category I or IV (as the case may be) and complete engineering activities within the agreed schedule. Any delay

arising out of submission and modification of drawings shall not alter the contract completion schedule.

- i. Contractor shall not make any changes in the portion of the drawing other than those commented. If changes are required to be made in the portions already approved, the Contractor shall resubmit the drawings identifying the changes (along with reasons for changes) for Employer's review and approval. **Drawings resubmitted shall show clearly the portions where the same are revised marking the relevant revision numbers and Employer shall review only such revised portion of documents.**
- j. Approval of drawings will not in any way relieve the Contractor of his obligations of furnishing the equipment in accordance with the specification and shall not prevent subsequent rejection if such equipment is later found to be defective.

3.5.3 Erection Drawings.

- a. Contractor shall furnish erection drawings for the guidance or commencement of erection or the first shipment, whichever is earlier. These shall generally comprise of fabrication/assembly drawings, various component/part details drawing, assembly, clearance data requirements, etc. The drawings shall contain details of components/ equipment with identification number, match marks, bill of materials, assembly procedures etc.
- b. For all major equipment apart from above details, assembly sequence and instructions with check-lists shall be furnished in the form of erection manuals.

3.5.4 Instruction Manual

- a. The Contractor shall submit to the Employer preliminary instruction manuals for all the equipments for review. The final instructions manuals incorporating Employer's comments and complete in all respect shall be submitted at least sixty (60) days before the first shipment of the equipment. The instruction manuals shall contain full details and drawings of all the equipments, the transportation, storage, installation, testing, operation and maintenance procedures, etc. separately for each component/equipment along with log record format. These instruction manuals shall be submitted in five (5) copies for approval.
- b. If after commissioning and initial operation of the plant, the instruction manuals require any modifications/additions/changes, the same shall be incorporated and the updated final instruction manuals shall be submitted.
- c. The operating and maintenance instructions together with drawings (other than shop drawings) of the equipment, as completed, shall have sufficient details to enable the Employer to maintain, dismantle, reassemble and adjust all parts of the equipment. They shall give a step by step procedure for all operations likely to be carried out during the life of the plant/equipment, including erection, testing, commissioning, operation, maintenance dismantling and repair. Each manual shall also include a complete set of approved drawings together with performance/rating curves of the equipment and test certificates, wherever applicable. The contract shall not be considered completed for purpose of taking over until such instructions and drawings have been supplied to the Employer.
- d. A separate section of the manual shall be for each size/type of equipment and shall contain a detailed description of construction and operation, together with all relevant pamphlets.
- e. The manuals shall include the following
 - a) List of spare parts along with their drawing and catalogues and procedure for ordering spares.
 - b) Lubrication Schedule including charts showing lubrication checking, testing and replacement procedure to be carried daily, weekly, monthly & at longer intervals to ensure trouble free operation.

- f. Where applicable, fault location charts shall be included to facilitate finding the cause of mal-operation or break down.
- g. A collection of the manufacturer's standard leaflets will not accepted to be taken as a compliance of this clause. The manual shall be specifically compiled for the concerned project.

3.5.5 Final Submission of drawings and documents:

The Contractor shall furnish the following after approval of all drawings /documents and test reports:

- a. List of drawings bearing the Employer's and Contractor's drawing number.
- b. Two (2) bound sets alongwith 4 CD-ROMs of all drawing.
- c. All documents/designs in two (2) copies as noted above.
- d. Contractor shall also furnish six (6) bound sets of all as-built drawings including the list of all as-built drawings bearing drawing numbers. The Contractor shall also furnish two (2) sets of CD-ROMs/ DVD/Portable hard disk of all as-built drawings as decided by the Employer.
- e. The Contractor shall also furnish four (4) copies of instruction/ operations & maintenance manuals (after approval) for all the equipments.

3.5.6 TEST REPORTS

Two (2) copies of all test reports shall be supplied for approval before shipment of Equipment. The report shall indicate clearly the standard value specified for each test to facilitate checking of the reports. After final approval six (6) bound copies of all type and routine test reports shall be submitted to Employer.

3.6 MATERIAL /WORKMANSHIP

Where the specification does not contain references to workmanship, equipment, materials and components of the covered equipment, it is essential that the same must be new, of highest grade of the best quality of their kind, conforming to best engineering practice and suitable for the purpose for which they are intended and shall ensure satisfactory performance throughout the service life.

In case where the equipment, materials or components are indicated in the specification as "similar" to any special standard the purchaser shall decide upon the question of similarity. When required by the specification or when required by the purchaser the contractor shall submit, for approval, all the information concerning the materials or components to be used in manufacture. Machinery, equipment, materials and components supplied, installed or used without such approval shall run the risk of subsequent rejection, it being understood that the cost as well as the time delay associated with the rejection shall be borne by the Contractor.

The design of the Works shall be such that installation, future expansions, replacements and general maintenance may be undertaken with a minimum of time and expenses. Each component shall be designed to be consistent with its duty and suitable factors of safety subject to mutual agreements. All joints and fastenings shall be devised, constructed and documented so that the component parts shall be accurately positioned and restrained to fulfill their required function. In general, screw threads shall be standard metric threads. The use of other thread forms will only be permitted when prior approval has been obtained from the Purchaser.

Whenever possible, all similar part of the works shall be made to gauge and shall also be made interchangeable with similar parts. All spare parts shall also be interchangeable and shall be made of the same materials and workmanship as the corresponding parts of the equipment supplied under the specification. Where feasible, common component units shall be employed in different pieces of equipment in order to minimize spare parts stocking requirements. All equipment of the same type and rating shall be physically and electrically interchangeable.

The equipment offered in the bid only shall be accepted for supply, with the minimum modifications as agreed/accepted.

3.7 PROVISIONS FOR EXPOSURE TO HOT AND HUMID CLIMATE

Outdoor equipment supplied under the specification shall be suitable for service and storage under tropical conditions of high temperature, high humidity' heavy rainfall and environment favorable to the growth of fungi and mildew. The indoor equipment located in non-air-conditioned areas shall also be of same type.

SPACE HEATERS

The heaters shall be suitable for continuous operation at 230 V as supply voltage. On –off switch and fuse shall be provided.

One or more adequately rated thermostatically connected heaters shall be supplied to prevent condensation in any compartment. The heaters shall be installed in the compartment and electrical connections shall be made sufficiently away from below the heaters to minimize deterioration of supply wire insulation. The heaters shall be suitable to maintain the compartment temperature to prevent condensation.

The heaters shall be suitably designed to prevent any contact between the heater wire and the air and shall consist of coiled resistance wire centered in a metal sheath and completely encased in a highly compacted powder of magnesium oxide or other material having equal heat conducting and electrical insulation properties or they shall consist of resistance wire wound on a ceramic and completely covered with a ceramic material to prevent any contact between the wire and the air. Alternatively, they shall consist of a resistance wire mounted into a tubular ceramic body built into an envelope of stainless steel or the resistance wire is wound on a tubular ceramic body and embedded in vitreous glaze. The surface temperature of the heaters shall be restricted to a value which will not shorten the life of the heater sheaths or that of insulated wire or other component in the compartments.

FUNGI STATIC VARNISH

Besides the space heaters, special moisture and fungus resistance varnish shall be applied on parts which may be subjected or predisposed to the formation of fungi due to the presence or deposit of nutrient substances. The varnish shall not be applied to any surface of part where the treatment will interfere with the operation or performance of the equipment. Such surfaces or parts shall be protected against the application of the varnish.

Ventilation opening

In order to ensure adequate ventilation, compartments shall have ventilation openings provided with fine wire mesh of brass to prevent the entry of insects and to reduce to a minimum the entry of dirt and dust. Outdoor compartment openings shall be provided with shutter type blinds.

Degree of Protection

The enclosure of the Control Cabinets, Junction boxes and Marshalling Boxes, panels etc. to be installed shall provide degree of protection as detailed here under:

- a. Installed outdoor: IP- 55
- b. Installed indoor in air conditioned area: IP-31
- c. Installed in covered area: IP-52
- d. Installed indoor in non air-conditioned area where possibility of entry of water is limited: IP-41.
- e. For LT Switchgear (AC & DC distribution Boards) : IP-52

The degree of protection shall be in accordance with IS: 13947 (Part –I) / IEC-947 (Part-I) / IS 12063/IEC 529. Type test report for degree of protection test, on each type of the box shall be submitted for approval.

PRESERVATIVE SHOP COATING

All exposed metallic surfaces subject to corrosion shall be protected by shop application of suitable coatings. All surfaces which will not be easily accessible after the shop assembly, shall be treated beforehand and protected for the life of the equipment. All surfaces shall be thoroughly cleaned of all mill scales, oxides and other coatings and prepared in the shop. The surfaces that are to be finish-painted after installation or require corrosion protection until installation, shall be shop painted as per the requirements covered in the relevant part of the Technical Specification.

Transformers and other electrical equipments, if included shall be shop finished with one or more coats of primer and two coats of high grade resistance enamel. The finished colors shall be as per manufacturer's standards, to be selected and specified by the Employer at a later date.

Shop primer for all steel surfaces which will be exposed to operating temperature below 95 degrees Celsius shall be selected by the Contractor after obtaining specific approval of the Employer regarding the quality of primer proposed to be applied. Special high temperature primer shall be used on surfaces exposed to temperature higher than 95 degrees Celsius and such primer shall also be subject to the approval of the Employer.

3.8 RATING PLATES, NAME PLATES AND LABELS

- 3.8.1 Each equipment shall have permanently attached to it in a conspicuous position, a rating plate of non-corrosive material upon which shall be engraved manufacturer's name, equipment, type or serial number together with details of the ratings, service conditions under which the item of plant in question has been designed to operate, and such diagram plates as may be required by the Employer.
- 3.8.2 Such nameplates or labels shall be of white nonhygroscopic material with engraved black lettering or alternately, in the case of indoor circuit breakers, starters, etc. of transparent plastic material with suitably coloured lettering engraved on the back.
- 3.8.3 The rated current, extended current rating and rated thermal current shall be clearly indicated in the name plate in case of current transformer.
- 3.8.4 Rated voltage, voltage factor and intermediate voltage shall be clearly indicated on the nameplate in case of capacitor voltage transformer.
- 3.8.5 Each switch shall have a clear inscription identifying its function. Switches shall also have a clear inscription of each position indication.
- 3.8.6 All segregated phases of conductors or bus ducts, indoor or outdoor, shall be provided with coloured phase plates to clearly identify the phase of the system.
- 3.8.7 All such plates, instruction plates, etc. shall be bilingual with Hindi inscription first, followed by English. Alternatively, two separate plates one with Hindi and the other with English inscriptions may be provided.

3.9 GALVANISING:

- 3.9.1 The galvanised surface shall consist of a continuous film adhering to the steel. The finished surface shall be clean and smooth, and shall be free from defects like dissolved patches, base, spot, unevenness of coating, spelter which is loosely attached to the steel globules, spiky deposits, blistered surfaces, flaking or peeling off, etc. The presence of any of these defects shall render the material liable to rejection.

3.9.2 All exposed ferrous parts shall be hot dip galvanised as per IS:2629 & IS:2633, Galvanising shall be uniform, smooth continuous and free from acid spots. Should the galvanising of the sample be found defective, the entire batch of steel shall have to be re-galvanised at Contractor's cost. The amount of zinc deposit shall be not less than 610 gms. per sq.m. of surface area and in addition, the thickness of zinc at any spot shall not be less than 85 microns. The Employer reserves the right to measure the thickness of zinc deposit by Elkometer or any other instrument acceptable to Employer and reject any component which shows thickness of zinc at any location less than 85 microns. The testing on the galvanised materials shall be carried out as per IS:2633.

3.9.3 The amount of zinc deposit over threaded portion of the bolts, nuts and screws shall not be less than 300 gms. per sq. meter of surface area. The amount of zinc deposit on washers shall not be less than 340 gms. per sq. meter of surface area. The threads having extra deposit of zinc shall be removed by die cutting after the completion of galvanising. The removal of extra zinc shall be carefully done so that threads shall have minimum deposits of zinc on them as specified.

3.10 PAINTING

Unless explicitly stated in relevant chapters of the specification, the painting of all electrical equipment shall be as follows:

Epoxy based with suitable additives. The thickness of finish coat shall be minimum 50 microns (minimum total DFT shall be 100 microns). However in case electrostatic process of painting is offered for any electrical equipment, minimum paint thickness of 50 microns shall be acceptable for finish coat. Paint shade shall be as per technical specification.

3.11 QUALITY ASSURANCE PROGRAMME

3.11.1 The Contractor shall adopt suitable quality assurance programme to ensure that the equipment and services under the scope of contract whether manufactured or performed within the Contractor's works or at his subcontractor's premises or at the Employer's site or at any other place of work are in accordance with the specifications. Such programmes shall be outlined by the Contractor and shall be finally accepted by the Employer/authorised representative after discussions before the award of the contract. The QA programme shall be generally in line with ISO-9001/IS- 14001.

A quality assurance programme of the contractor shall generally cover the following:

- i. His organisation structure for the management and implementation of the proposed quality assurance programme
- ii. Quality System Manual
- iii. Design Control System
- iv. Documentation Data Control System
- v. Qualification data for Bidder's key Personnel.
- vi. The procedure for purchase of materials, parts, components and selection of subcontractor's services including vendor analysis, source inspection, incoming raw-material inspection, verification of materials purchased etc.
- vii. System for shop manufacturing and site erection controls including process, fabrication and assembly.
- viii. Control of non-conforming items and system for corrective actions and resolution of deviations.
- ix. Inspection and test procedure both for manufacture and field activities.
- x. Control of calibration and testing of measuring testing equipments.
- xi. System for Quality Audits.
- xii. System for identification and appraisal of inspection status.
- xiii. System for authorising release of manufactured product to the Employer.
- xiv. System for handling storage and delivery.

- xv. System for maintenance of records, and
- xvi. Furnishing quality plans for manufacturing and field activities detailing out the specific quality control procedure adopted for controlling the quality characteristics relevant to each item of equipment/component as per format enclosed as Annexure-I.

3.12 GENERAL REQUIREMENTS - QUALITY ASSURANCE

- 3.12.1 All materials, components and equipment covered under this specification shall be procured, manufactured, erected, commissioned and tested at all the stages, as per a comprehensive Quality Assurance Programme. An indicative programme of inspection/tests to be carried out by the contractor for some of the major items is given in the respective technical specification. This is, however, not intended to form a comprehensive programme as it is the contractor's responsibility to draw up and implement such programme duly approved by the Employer. The detailed Quality Plans for manufacturing and field activities should be drawn up by the Bidder and will be submitted to Employer for approval. Schedule of finalisation of such quality plans will be finalised before award.
- 3.12.2 Manufacturing Quality Plan will detail out for all the components and equipment, various tests/inspection, to be carried out as per the requirements of this specification and standards mentioned therein and quality practices and procedures followed by Contractor's/ Sub-contractor's/ sub-supplier's Quality Control Organisation, the relevant reference documents and standards, acceptance norms, inspection documents raised etc., during all stages of materials procurement, manufacture, assembly and final testing/performance testing. The Quality Plan shall be submitted on electronic media e.g. floppy or E-mail in addition to hard copy, for review. Once the same is finalised, hard copies shall be submitted for approval. After approval the same shall be submitted in compiled form on CD ROM.
- 3.12.3 Field Quality Plans will detail out for all the equipment, the quality practices and procedures etc. to be followed by the Contractor's site Quality Control Organisation, during various stages of site activities starting from receipt of materials/equipment at site.
- 3.12.4 The Bidder shall also furnish copies of the reference documents/plant standards/acceptance norms/tests and inspection procedure etc., as referred in Quality Plans along with Quality Plans. These Quality Plans and reference documents/standards etc. will be subject to Employer's approval without which manufacturer shall not proceed.
- 3.12.5 These approved documents shall form a part of the contract. In these approved Quality Plans, Employer shall identify customer hold points (CHP), i.e. test/checks which shall be carried out in presence of the Employer's Project Manager or his authorised representative and beyond which the work will not proceed without consent of Employer/Authorised representative in writing. All deviations to this specification, approved quality plans and applicable standards must be documented and referred to Employer along with technical justification for approval and dispositioning.
- 3.12.6 No material shall be despatched from the manufacturer's works before the same is accepted subsequent to pre-despatch final inspection including verification of records of all previous tests/inspections by Employer's Project Manager/Authorised representative and duly authorised for despatch by issuance of MDCC.
- 3.12.7 All material used for equipment manufacture including casting and forging etc. shall be of tested quality as per relevant codes/standards. Details of results of the tests conducted to determine the mechanical properties, chemical analysis and details of heat treatment procedure recommended and actually followed shall be recorded on certificates and time temperature chart. Tests shall be carried out as per applicable material standards and/or agreed details.

- 3.12.8 All welding and brazing shall be carried out as per procedure drawn and qualified in accordance with requirements of ASME Section IX/BS-4870 or other International equivalent standard acceptable to the Employer.
- 3.12.9 All welding/brazing procedures shall be submitted to the Employer or its authorised representative for approval prior to carrying out the welding/brazing.
- 3.12.10 All brazers, welders and welding operators employed on any part of the contract either in Contractor's/his sub-contractor's works or at site or elsewhere shall be qualified as per ASME Section-IX or BS-4871 or other equivalent International Standards acceptable to the Employer.
- 3.12.11 Test results or qualification tests and specimen testing shall be furnished to the Employer for approval. However, where required by the Employer, tests shall be conducted in presence of Employer/authorised representative.
- 3.12.12 For all pressure parts and high pressure piping welding, the latest applicable requirements of the IBR (Indian Boiler Regulations) shall also be essentially complied with. Similarly, any other statutory requirements for the equipments/systems shall also be complied with. On all back-gauged welds MPI/LPI shall be carried before seal welding.
- 3.12.13 All the heat treatment results shall be recorded on time temperature charts and verified with recommended regimes.
- 3.12.14 No welding shall be carried out on cast iron components for repair.
- 3.12.15 Unless otherwise proven and specifically agreed with the Employer, welding of dissimilar materials and high alloy materials shall be carried out at shop only.
- 3.12.16 All non-destructive examination shall be performed in accordance with written procedures as per International Standards. The NDT operator shall be qualified as per SNT-TC-IA (of the American Society of non-destructive examination). NDT shall be recorded in a report which includes details of methods and equipment used, result/evaluation, job data and identification of personnel employed and details of co-relation of the test report with the job.

In general all plates of thickness greater than 40mm & for pressure parts plates of thickness equal to or greater than 25mm shall be ultrasonically tested otherwise as specified in respective equipment specification. All bar stock/Forging of diameter equal to or greater than 50mm shall be ultrasonically tested.

The Contractor shall list out all major items/ equipment/ components to be manufactured in house as well as procured from sub-contractors (BOI). All the subcontractor proposed by the Contractor for procurement of major bought out items including castings, forging, semi-finished and finished components/equipment etc., list of which shall be drawn up by the Contractor and finalised with the Employer, shall be subject to Employer's approval. The contractor's proposal shall include vendor's facilities established at the respective works, the process capability, process stabilization, QC systems followed, experience list, etc. along with his own technical evaluation for identified subcontractors enclosed and shall be submitted to the Employer for approval within the period agreed at the time of pre-awards discussion and identified in "DR" category prior to any procurement. Such vendor approval shall not relieve the contractor from any obligation, duty or responsibility under the contract.

- 3.12.17 For components/equipment procured by the contractors for the purpose of the contract, after obtaining the written approval of the Employer, the contractor's purchase specifications and inquiries shall call for quality plans to be submitted by the suppliers. The quality plans called for from the subcontractor shall set out, during the various stages of manufacture and installation, the quality practices and procedures followed by the vendor's quality control

organisation, the relevant reference documents/standards used, acceptance level, inspection of documentation raised, etc.

- 3.12.18 Employer reserves the right to carry out quality audit and quality surveillance of the systems and procedures of the Contractor's or their sub vendor's quality management and control activities. The contractor shall provide all necessary assistance to enable the Employer carry out such audit and surveillance.
- 3.12.19 The contractor shall carry out an inspection and testing programme during manufacture in his work and that of his sub-contractors and at site to ensure the mechanical accuracy of components, compliance with drawings, conformance to functional and performance requirements, identity and acceptability of all materials parts and equipment. Contractor shall carry out all tests/inspection required to establish that the items/equipments conform to requirements of the specification and the relevant codes/standards specified in the specification, in addition to carrying out tests as per the approved quality plan.
- 3.12.20 Quality audit/surveillance/approval of the results of the tests and inspection will not, however, prejudice the right of the Employer to reject the equipment if it does not comply with the specification when erected or does not give complete satisfaction in service and the above shall in no way limit the liabilities and responsibilities of the Contractor in ensuring complete conformance of the materials/equipment supplied to relevant specification, standard, data sheets, drawings, etc.
- 3.12.21 For all spares and replacement items, the quality requirements as agreed for the main equipment supply shall be applicable.
- 3.12.22 Repair/rectification procedures to be adopted to make the job acceptable shall be subject to the approval of the Employer/ authorised representative.

3.12.23 Environmental Stress Screening

All solid state electronic system / equipment / sub assembly shall be free from infant mortile components. For establishing the compliance to this requirement, the contractor / sub – contractor should meet the following.

1. The Contractor / Sub – contractor shall furnish the established procedure being followed for eliminating infant mortile components. The procedure followed by the Contractor / Sub – contractor should be substantiated along with the statistical figures to validate the procedure being followed. The necessary details as required under this clause shall be furnished at the stage of QP finalization.

Or

In case the Contractor / Sub – contractor do not have any established procedure to eliminate infant mortile components then two or 10% whichever is less, most densely populated Panels shall be tested for Elevated Temperature Cycle Test as per the following procedure.

Elevated Temperature Test Cycle

During the elevated temperature test which shall be for 48 hours, the ambient temperature shall be maintained at 50° C. The equipment shall be interconnected with devices and kept under energized conditions so as to repeatedly perform all operations it is expected to perform in actual service with load on various components being equal to those which will be experienced in actual service.

During the elevated temperature test the cubicle doors shall be closed (or shall be in the position same as they are supposed to be in the field) and inside temperature in the zone of highest heat dissipating components / modules shall be monitored. The temperature rise inside the cubicle should not exceed 10° C above the ambient temperature at 50° C.

In case of any failure during the test cycle, the further course of action should be mutually discussed for demonstrating the intent of the above requirement.

Burn In Test Cycle

The test shall be conducted on all the panels fully assembled and wired including the panels having undergone the above mentioned elevated temperature test.

The period of Burn in Test Cycle shall be 120 hrs and process shall be similar to the elevated temperature test as above except that the temperature shall be reduced to the ambient temperature prevalent at that time.

During the above tests, the process I/O and other load on the system shall be simulated by simulated inputs and in the case of control systems, the process which is to be controlled shall also be simulated. Testing of individual components or modules shall not be acceptable.

During the Burn in Test the cubicle doors shall be closed (or shall be in the position same as they are supposed to be in the field) and inside temperature in the zone of highest heat dissipating components / modules shall be monitored. The temperature rise inside the cubicle should not exceed 10° C above the ambient temperature.

The Contractor / Sub-contractor shall carry out routine test on 100% item at contractor / sub-contractor's works. The quantum of check / test for routine & acceptance test by employer shall be generally as per criteria / sampling plan defined in referred standards. Wherever standards have not been mentioned quantum of check / test for routine / acceptance test shall be as agreed during detailed engineering stage.

3.13 QUALITY ASSURANCE DOCUMENTS

The Contractor shall be required to submit two hard copies and two sets on CDROM of the following Quality Assurance Documents as identified in respective quality plan with tick (✓) mark.

Each QA Documentation shall have a project specific Cover Sheet bearing name & identification number of equipment and including an index of its contents with page control on each document.

The QA Documentation file shall be progressively completed by the Supplier's sub-supplier to allow regular reviews by all parties during the manufacturing.

The final quality document will be compiled and issued at the final assembly place of equipment before dispatch. However CD-Rom may be issued not later than three weeks.

3.13.1 Typical contents of Quality Assurance Document are as below:-

- i) Quality Plan,
- ii) Material mill test reports on components as specified by the specification and approved Quality Plans.
- iii) Manufacturer / works test reports/results for testing required as per applicable codes and standard referred in the specification and approved Quality Plans.

- iv) Non-destructive examination results /reports including radiography interpretation reports. Sketches/drawings used for indicating the method of traceability of the radiographs to the location on the equipment.
 - v) Heat Treatment Certificate/Record (Time- temperature Chart)
 - vi) All the accepted Non-conformance Reports (Major/Minor) / deviation, including complete technical details / repair procedure).
 - vii) CHP / Inspection reports duly signed by the Inspector of the Employer and Contractor for the agreed Customer Hold Points.
 - viii) Certificate of Conformance (COC) whoever applicable.
 - ix) MDCC
- 3.13.2 Similarly, the contractor shall be required to submit two hard copies and two sets on CD ROM of Quality Assurance Documents (in line with above) pertaining to field activities as per Approved Field Quality Plans and other agreed manuals/ procedures, prior to commissioning of individual system.
- 3.13.3 Before dispatch/ commissioning of any equipment, the Supplier shall make sure that the corresponding quality document or in the case of protracted phased deliveries, the applicable section of the quality document file is completed. The supplier will then notify the Inspector regarding the readiness of the quality document (or applicable section) for review.
- i) If the result of the review carried out by the Inspector of the Quality document (or applicable section) is satisfactory. The Inspector shall stamp the quality document (or applicable section) for release.
 - ii) If the quality document is unsatisfactory, the Supplier shall endeavour to correct the incompleteness, thus allowing finalizing the quality document (or applicable section) by time compatible with the requirements as per contract documents. When it is done, the quality document (or applicable section) is stamped by the Inspector.
 - i) If a decision is made for dispatch, whereas all outstanding actions cannot be readily cleared for the release of the quality document by that time, the supplier shall immediately, upon shipment of the equipment, send a copy of the quality document Review Status signed by the Supplier Representative to the Inspector and notify of the committed date for the completion of all outstanding actions & submission. The Inspector shall stamp the quality document for applicable section when it is effectively completed. The submission of QA documentation package shall not be later than 3 weeks after the dispatch of equipment.

3.14 TRANSMISSION OF QUALITY DOCUMENTS

As a general rule, two hard copies of the quality document and Two CD ROMs shall be issued to the Employer after the delivery date for the corresponding equipment. One set of quality document shall be forwarded to Corporate Quality Assurance Department and other set to respective Site.

For the particular case of phased deliveries, the complete quality document to the Employer shall be issued not later than 1 month after the date of the last delivery similarly as stated above.

3.15 INSPECTION, TESTING & INSPECTION CERTIFICATE

- 3.15.1 The word 'Inspector' shall mean the Project Manager and/or his authorised representative and/or an outside inspection agency acting on behalf of the Employer to inspect and examine the materials and workmanship of the works during its manufacture or erection.
- 3.15.2 The Project Manager or his duly authorised representative and/or an outside inspection agency acting on behalf of the Employer shall have access at all reasonable times to inspect

and examine the materials and workmanship of the works during its manufacture or erection and if part of the works is being manufactured or assembled on other premises or works, the Contractor shall obtain for the Project Manager and for his duly authorised representative permission to inspect as if the works were manufactured or assembled on the Contractor's own premises or works.

- 3.15.3 The Contractor shall give the Project Manager/Inspector fifteen (15) days written notice of any material being ready for testing. Such tests shall be to the Contractor's account except for the expenses of the Inspector's. The Project Manager/Inspector, unless the witnessing of the tests is virtually waived, will attend such tests within fifteen (15) days of the date on which the equipment is noticed as being ready for test/inspection failing which the contractor may proceed with test which shall be deemed to have been made in the inspector's presence and he shall forthwith forward to the inspector duly certified copies of test reports in two (2) copies.
- 3.15.4 The Project Manager or Inspector shall within fifteen (15) days from the date of inspection as defined herein give notice in writing to the Contractor, or any objection to any drawings and all or any equipment and workmanship which is in his opinion not in accordance with the contract. The Contractor shall give due consideration to such objections and shall either make modifications that may be necessary to meet the said objections or shall inform in writing to the Project Manager/Inspector giving reasons therein, that no modifications are necessary to comply with the contract.
- 3.15.5 When the factory tests have been completed at the Contractor's or subcontractor's works, the Project Manager /Inspector shall issue a certificate to this effect fifteen (15) days after completion of tests but if the tests are not witnessed by the Project Manager /Inspectors, the certificate shall be issued within fifteen (15) days of the receipt of the Contractor's test certificate by the Project Manager /Inspector. Project Manager /Inspector to issue such a certificate shall not prevent the Contractor from proceeding with the works. The completion of these tests or the issue of the certificates shall not bind the Employer to accept the equipment should it, on further tests after erection be found not to comply with the contract.
- 3.15.6 In all cases where the contract provides for tests whether at the premises or works of the Contractor or any sub-contractor, the Contractor, except where otherwise specified shall provide free of charge such items as labour, material, electricity, fuel, water, stores, apparatus and instruments as may be reasonably demanded by the Project Manager /Inspector or his authorised representatives to carry out effectively such tests on the equipment in accordance with the Contractor and shall give facilities to the Project Manager/Inspector or to his authorised representative to accomplish testing.
- 3.15.7 The inspection by Project Manager / Inspector and issue of Inspection Certificate thereon shall in no way limit the liabilities and responsibilities of the Contractor in respect of the agreed Quality Assurance Programme forming a part of the contract.
- 3.15.8 To facilitate advance planning of inspection in addition to giving inspection notice, the Contractor shall furnish quarterly inspection programme indicating schedule dates of inspection at Customer Hold Point and final inspection stages. Updated quarterly inspection plans will be made for each three consecutive months and shall be furnished before beginning of each calendar month.
- 3.15.9 All inspection, measuring and test equipments used by contractor shall be calibrated periodically depending on its use and criticality of the test/measurement to be done. The Contractor shall maintain all the relevant records of periodic calibration and instrument identification, and shall produce the same for inspection by NTPC. Wherever asked specifically, the contractor shall re-calibrate the measuring/test equipments in the presence of Project Manager / Inspector.

3.16 PACKAGING & TRANSPORTATION

Items shall be packed & dispatched separately to respective sites i.e. to 400/220kV S/s at NKSTPP end & to 220kV S/s at Chatti Bariatu & Kerandari-A mine end.

3.16.1 Packing, Marking and shipping

The packing and shipping shall be carried out in accordance with the standard practice of Contractor and with the following additional requirements:

- a) The equipment shall be prepared in such a manner as to protect the equipment from damage or deterioration during shipping or storage. The shipments can be exposed to heavy rains, hot sun, high humidity and sudden extreme changes of temperature. The equipment shall be packed and shipped so as to protect it from all such conditions and any other abnormal conditions, generally expected during shipping & storage.
- b) The metallic containers, if any, shall be considered as the property of the Contractor and he will be allowed to remove them from site once the contents are unpacked, inspected, documented and placed in temporary storage or in final position.
- c) The equipment shall be shipped in such a manner as to facilitate unloading, handling and storage enroute and at the site. The Contractor shall provide lifting lugs and special lifting devices for proper handling and erection.
- d) The Contractor shall be liable for any damage or loss resulting due to careless, improper, poor or insufficient packing and handling.
- e) Spare parts and spare equipment shall be packed separately in containers adequate for long term storage, plainly marked "Spare Parts Only". They shall be crated individually or in kits to be used in one single renewal or overhaul operation. Other spare part kits shall not be disturbed when using one set or kit.
- f) The Contractor shall at all times protect and preserve from damage, loss, corrosion and all other forms of damage, all parts of the works.

3.16.2 Transportation

- a) The Contractor shall make a careful examination of access rail/roadways to the site in order to confirm the practical maximum transport weight and dimensions as well as a careful examination of the ports of disembarkation particularly with respect to the capacity of the cranes installed and access roads.
- b) All instruments and computer/microprocessor based equipment imported into India from overseas for the purpose of this contract shall be air freighted to the nearest possible point and further by rail/road taking due precautions as per manufacturer's recommendations. Employer shall have the right to decide the items that should be air freighted and Employer's decision shall be binding on Contractor.

3.16.3 Insurance

- a) The Contractor shall insure all shipments and works at his own expense for not less than the full replacement cost plus any additional cost for accelerated manufacturing of the replacement parts.
- b) Loss or the damage to equipment during shipping or transportation to the site(s) or otherwise

shall not constitute groups for claims for extension in time or for extra payment.

3.17 CLAMPS AND CONNECTORS INCLUDING TERMINAL CONNECTORS

- 3.17.1 The material of clamps and connectors shall be Aluminium alloy casting conforming to designation A6 of IS:617 for connecting to equipment terminals and conductors of aluminium. In case the terminals are of copper, the same clamps/connectors shall be used with 2mm thick bimetallic liner.
- 3.17.2 The material of clamps and connectors shall be Galvanised mild steel for connecting to shield wire.
- 3.17.3 Bolts, nuts and plain washers shall be hot dip galvanised mild steel for sizes M12 and above. For sizes below M12, they shall be electro-galvanised mild steel. The spring washers shall be electro-galvanised mild steel.
- 3.17.4 All castings shall be free from blow holes, surface blisters, cracks and cavities. All sharp edges and corners shall be rounded off to meet specified corona and radio interference requirements.
- 3.17.5 They shall have same current rating as that of the connected equipment. All current carrying parts shall be at least 10 mm thick. The connectors shall be manufactured to have minimum contact resistance.
- 3.17.6 Flexible connectors, braids or laminated strips shall be made up of copper/aluminium.
- 3.17.7 Current rating and size of terminal/conductor for which connector is suitable shall be put on a suitable sticker on each component which should last atleast till erection time.

3.18 BUSHINGS, HOLLOW COLUMN INSULATORS, SUPPORT INSULATORS, AND DISC INSULATORS

- 3.18.1 Bushings shall be manufactured and tested in accordance with IS: 2099 & IEC: 137 while hollow column insulators shall be manufactured and tested in accordance with IEC 233/IS 5284. The support insulators shall be manufactured and tested as per IS: / IEC 168/IEC 273. The insulators shall also conform to IEC 815 as applicable. Support insulators/ bushings/ hollow column insulators shall be designed to have ample insulation, mechanical strength and rigidity for the conditions under which they will be used.
- 3.18.2 Porcelain used shall be homogenous, free from laminations, cavities and other flaws or imperfections that might affect the mechanical or dielectric quality and shall be thoroughly vitrified, tough and impervious to moisture. Hollow porcelain should be in one integral piece in green & fired stage.
- 3.18.3 Glazing of the porcelain shall be uniform brown in colour, free from blisters, burns and other similar defects.
- 3.18.4 When operating at normal rated voltage there shall be no electric discharge between conductor and insulators which would cause corrosion or injury to conductors or when operating at normal rated voltage.
- 3.18.5 The design of the insulator shall be such that stresses due to expansion and contraction in any part of the insulator shall be lead to deterioration. All ferrous parts shall be hot dip galvanised.

- 3.18.6 Bushing porcelain shall be robust and capable of withstanding the internal pressures likely to occur in service. The design and location of clamps, the shape and the strength of the porcelain flange securing the bushing to the tank shall be such that there is no risk of fracture. All portions of the assembled porcelain enclosures and supports other than gaskets, which may in any way be exposed to the atmosphere shall be composed of completely non hygroscopic material such as metal or glazed porcelain.
- 3.18.7 All iron parts shall be hot dip galvanised and all joints shall be air tight. Surface of joints shall be trued, porcelain parts by grinding and metal parts by machining. Insulator/ bushing design shall be such as to ensure a uniform compressive pressure on the joints.
- 3.18.8 Insulator shall also meet requirement of IEC - 815 as applicable, having alternate long & short sheds.

3.19 CONTROL CABINETS, JUNCTION BOXES, TERMINAL BOXES & MARSHALLING BOXES FOR OUTDOOR EQUIPMENT.

- 3.19.1 All types of control cabinets, junction boxes, marshaling boxes, lighting panels, terminal boxes, operating mechanism boxes, Kiosks etc. shall generally conform to IS:5039, IS:8623 and IEC:439 as applicable.
- 3.19.2 **Mechanism Box/ Control Cabinet/ Kiosks:** A sheet steel (atleast 2.5 mm thick), dust and vermin proof M.Box/CCC/CMB shall be provided with proper lighting and thermostatically controlled space heaters. The degree of protection shall be IP 55. One dummy terminal block in between each trip wire terminal shall be provided. At least 20% spare terminals shall be provided on each panel. The gasket used shall be of neoprene rubber.

Painting of boxes shall be as follows,

- External surface : Chemical resistant epoxy zinc phosphate primer, MIO (Micaceous iron oxide) as intermediate paint followed by polyurethane finish paint (**RAL 5012 Blue**)
- Internal surface : Chemical resistant epoxy zinc phosphate primer followed by chemical & heat resistant **epoxy enamel white paint**.

- 3.19.3 **Junction Boxes:** The junction boxes shall be made of minimum 2 mm thick sheet steel. Gland plates shall be removable type and made of 3 mm thick sheet steel. The boxes shall be provided with detachable cover or hinged door with captive screws. Top of the box shall be arranged to slope towards the rear of the box. The box shall be **hot dip galvanised** and shall be provided with suitable neoprene gaskets to achieve requisite degree of protection. Adequate spacing shall be provided to terminate the external cables. The boxes shall be suitable for mounting on various types of steel structures. The terminal blocks provided shall be of 650 V grade, rated for 10 A for control cables. Suitable numbering for terminal blocks shall be done. In case of junction box for power cable, the box shall be rated for maximum current carrying capacity. Terminal blocks shall be of one piece, Klippon RSF-1 or ELMEX CSLT-1 type with insulating barriers.
- 3.19.4 The cabinets/boxes/kiosks/panels shall be free standing or wall mounting or pedestal mounting type. They shall have hinged doors with padlocking arrangement. All doors, removable covers and plates shall be gasketed all around with neoprene gaskets.
- 3.19.5 The degree of protection of of all the outdoor boxes shall not be less than IP 55 as per IS 2147.
- 3.19.6 The cable entry shall be from bottom, for which removable gasketed cable gland plates shall be provided.

- 3.19.7 Suitable 240V, single phase, 50Hz ac heaters with thermostats controlled by switch and fuse shall be provided to maintain inside temperature 10deg. above the ambient.
- 3.19.8 The size of enclosure and the layout of equipment inside shall provide generous clearances. Each cabinet/box/kiosk/panel shall be provided with a 15A, 240V ac, 2 pole, 3 pin industrial grade receptacle with switch. For incoming supply, MCB of suitable rating shall be provided. Illumination of each compartment shall be with door operated incandescent lamp. All control switches shall be of rotary switch type.
- 3.19.9 Each cabinet/box/kiosk/panel shall be provided with two earthing pads to receive 75mmx12mm GS flat. The connection shall be bolted type with two bolts per pad. The hinged door shall be connected to body using flexible wire. The cabinets/boxes/kiosks/panels shall also be provided with danger plate, and internal wiring diagram pasted on inside of the door. The front label shall be on a 3mm thick plastic plate with white letters engraved on black background

3.20 TERMINAL BLOCKS

- 3.20.1 They shall be non-disconnecting stud type of extensible design equivalent to Elmex type CAT-M4.
- 3.20.2 The terminal blocks shall be of 650 V grade, and rated to continuously carry maximum expected current. The conducting part shall be tinned or silver plated.
- 3.20.3 They shall be of moulded, non-inflammable thermosetting plastic. The material shall not deteriorate with varied conditions of temperature and humidity. The terminal blocks shall be fully enclosed with removable covers of transparent, non deteriorating plastic material. Insulating barriers shall be provided between the terminal blocks so that the barriers do not hinder the wiring operation without removing the barriers.
- 3.20.4 The terminals shall be provided with marking tags for wiring identification.
- 3.20.5 Unless otherwise required (expected current rating) or specified, terminal blocks shall be suitable for connecting the following conductors on each side:
All CT & VT circuits - Min. four 2.5 sq.mm. copper flexible conductor
AC & DC power supply -Two 16 sq.mm. Aluminium conductor
Other control circuits - Min. two 2.5 sq.mm. copper flexible conductor.
- 3.20.6 The terminal blocks for CT and VT secondary leads shall be provided with test links and isolating facilities. CT secondary leads shall also be provided with short circuiting and earthing facilities.

3.21 Wiring

- 3.21.1 All wiring shall be carried out with 1100 V grade stranded copper wires. The minimum size of the stranded conductor used for internal wiring shall be as follows:
a) All circuits except CT circuits 2.5 sq.mm
b) CT circuits 4 sq. mm (minimum number of strands shall be 3 per conductor).
- 3.21.2 All internal wiring shall be securely supported, neatly arranged readily accessible and connected to equipment terminals and terminal blocks.
- 3.21.3 Wire terminations shall be made with solderless crimping type of tinned copper lugs which firmly grip the conductor and insulation. Insulated sleeves shall be provided at all the wire terminations. Engraved core identification plastic ferrules marked to correspond with the wiring diagram shall be fitted at both ends of each wire. Ferrules shall fit tightly on the wires

shall not fall off when the wires and shall not fall off when the wire is disconnected from terminal blocks.

- 3.21.4 All wires directly connected to trip circuit breaker shall be distinguished by the addition of a red coloured unlettered ferrule. Number 6 & 9 shall not be included for ferrules purposes.
- 3.21.5 All terminals including spare terminals of auxiliary equipment shall be wired upto terminal blocks. Each equipment shall have its own central control cabinet in which all contacts including spare contacts from all poles shall be wired out. Interpole cabling for all equipment's shall be carried out by the Contractor.

3.22 CABLE GLANDS AND LUGS

- 3.22.1 Cable glands shall be Double compression type, tinned/Nicked plated (coating thickness not less than 20 microns in case of tin and 10 to 15 microns in case of nickel) brass cable glands for all power and control cables. They shall provide dust and weather proof terminations. They shall comprise of heavy duty brass casting, machine finished and tinned to avoid corrosion and oxidation. Rubber components used in cable glands shall be neoprene and off tested quality. Required number of packing glands to close unused openings in gland plates shall also be provided.
- 3.22.2 The cable glands shall be tested as per BS:6121. The cable glands shall also be duly tested for dust proof and weather proof termination.
- 3.22.3 Cables lugs for power cables shall be tinned copper solder less crimping type conforming to IS:8309 and 8394 suitable for aluminum or copper conductor (as applicable). Cable lugs and ferrules for control cables shall be tinned copper type. The cable lugs for control cables shall be provided with insulating sleeve and shall suit the type of terminals provided on the equipments. The cable lugs shall suit the type of terminals provided. The cable lugs shall be of Dowell make or equivalent.

3.4 CONDUITS, PIPES AND ACCESSORIES

- 3.4.1 The bidder shall supply and install all rigid conduits, mild steel pipes, flexible conduits, hume pipes, etc. including all necessary sundry materials, such as tees, elbows, check nuts, bushing reduces, enlargers, wooden plugs, coupling caps, nipples, gland sealing fittings, pull boxes, etc.
- 3.4.2 Rigid conduits shall be flow-coat metal conduits of Nagarjuna Coated Tubes or equivalent make. The outer surface of the conduits shall be coated with hot-dip zinc and chromate conversion coatings. The inner surface shall have silicone epoxy ester coating for easy cable pulling. Mild steel pipes shall be hot-dip galvanised. All rigid conduits/ pipes shall be of a reputed make.
- 3.4.3 Flexible conduits shall be heat-resistant lead coated steel, water-leak, fire and rust proof, and be of PLICA make or equivalent.

3.5 MOTOR CONTROL CENTRE

- 3.5.1 The 415 Volt motor control centres (if provided separately) shall conform to the requirements for boxes/cabinets/kiosks. They shall be fixed type, shall be fully sectionalised and shall be equipped with load break switches. Motor feeders shall be provided with isolating switch fuse unit and Contractor with thermal overload relay and single phase protection. The motor Contractor shall have one normally open auxiliary contact for alarm purposes. The motor control circuit shall be independent from all other control circuits.

3.5.2 Isolating Switches

The incoming power supply isolating switch operation handle shall be interlocked with the control cabinet door as to prevent opening of door when main switch is closed. Device for by passing the door interlock shall also be provided. Switch handle shall have provision for locking in both fully open and fully closed positions.

3.5.3 Fuses

All fuses shall be of the HRC cartridge type, conforming to IS: 2208 and suitable to mount on plug-in type of fuse bases. Fuses shall be provided with visible operation indicators to show that they have operated. All accessible live connections shall be adequately shrouded, and it shall be possible to change fuses with the circuit alive, without danger of contact with live conductor. Insulated fuse pulling handle shall be supplied with each control cabinet.

3.6 MOTORS

3.6.1 Motors shall be “Squirrel Cage” three phase induction motors of sufficient size capable of satisfactory operation for the application and duty as required for the driven equipment and shall conform to type tests and shall be subjected to routine tests as per applicable standards.

3.6.2 Enclosures

- a) For motors to be installed outdoor, the motor enclosure shall have degree of protection IP: 55. For motors to be installed indoor, i.e. inside a box, the motor enclosure shall be dust proof equivalent to IP: 54.
- b) Two independent earthing points shall be provided on opposite sides of the motor for bolted connection of earthing conductor.
- c) Motors shall have drain plugs so located that they will drain water resulting condensation or other causes from all pockets in the motor casing.

3.6.3 Operational Features :

- a) Continuous motor ratings (name plate rating) shall be at least suitable for the driven equipment at design duty operating point of driven equipment that will arise in service.
- b) Motors shall be capable of giving rated output without reduction in the expected life span when operated continuously in the given system.

3.6.4 Starting Requirements

- a) All induction motors shall be suitable for full voltage direct on-line starting. These shall be capable of starting and accelerating to the rated speed alongwith the driven equipment without exceeding the acceptable winding temperature even when the supply voltage drops.
- b) Motors shall be capable of withstanding the electrodynamic stresses and heating imposed if it is started at a voltage of 110% of the rated value.
- c) The locked rotor current shall not exceed six(6) times the rated full load current for all motors subject to tolerance given in IS:325.
- d) Motors when started with driven equipment imposing full starting torque and supply voltage conditions specified shall be capable of withstanding at least two successive starts from cold condition at room temperature and one start from hot condition without injurious heating of winding. The motors shall also be suitable for three equally spread starts per hour under the above referred supply condition.
- e) The locked rotor withstand time under hot condition at 110% of rated voltage shall be more than starting time with the driven equipment of minimum permissible voltage by a least two seconds or 15% of the accelerating time whichever is greater. In case it is not possible to meet the above requirement, the Contractor shall offer centrifugal type speed switch mounted on the motor shaft which shall remain closed for speeds lower

than 20% and open for speeds above 20% of the rated. The speed switch shall be capable of withstanding 120% of the rated speed in either directions of rotation.

- 3.6.5 The maximum permissible temperature rise over the ambient temperature shall be within the limits specified in IS: 325 (for 3 phase induction motors) after adjustment due to increased ambient temperature specified.
- 3.6.6 The double amplitude of motor vibration shall be within the limits specified in IS:729. Vibration shall also be within the limits specified by the relevant standard for the driven equipment when measured at the motor bearings.
- 3.6.7 All the induction motors shall be capable of running at 80% of rated voltage for a period of 5 minutes.

3.7 AUXILIARY SWITCH

The auxiliary switch shall conform of following type tests:

- a) Electrical endurance test - A minimum of 1000 operations for 2A. D.C. with a time constant greater than or equal to 20 milliseconds with a subsequent examination of mV drop/ visual defects/ temperature rise test.
- b) Mechanical endurance test - A minimum of 5000 operations with a subsequent checking of contact pressure test/ visual examination
- c) Heat run test on contacts
- d) IR/HV test, etc.

3.8 LAMPS AND SOCKETS

3.8.1 Lamps:

All incandescent lamps shall use a socket base as per IS-1258, except in the case of signal lamps.

3.8.2 Sockets

All sockets (convenience outlets) shall be suitable to accept both 5 Amp & 15 Amp pin round Standard Indian plugs. They shall be switched sockets with shutters.

3.8.3 Hand Lamp:

A 240 Volts, single Phase, 50 Hz AC plug point shall be provided in the interior of each cubicle with ON-OFF Switch for connection of hand lamps.

3.9 SWITCHES & FUSES:

Each control panel shall be provided with necessary arrangements for receiving, distributing, isolating and fusing of DC and AC supplies for various control, signaling, lighting and space heater circuits. The incoming and sub-circuits shall be separately provided with switch-fuse units. Selection of the main and sub-circuit fuse ratings shall be such as to ensure selective clearance of sub-circuit faults. Potential circuits for relaying and metering shall be protected by HRC fuses.

All fuses shall be of HRC cartridge type conforming to IS 9228 mounted on plug-in type fuse bases. Miniature circuit breakers with thermal Protection and alarm contacts will also be accepted. All accessible live connection to fuse bases shall be adequately shrouded. Fuses shall have operation indicators for indicating blown fuse condition. Fuse carrier base shall have imprints of the fuse rating and voltage.

All control switches shall be of rotary type. Toggle/piano switches shall not be accepted.

3.10 TYPE, ROUTINE & ACCEPTANCE TESTS:

All equipments to be supplied shall be of type tested design. During contract stage, bidder shall submit for Owner's approval the reports of all the type tests listed in this specification and carried out within last ten years from the date **28.11.2013**. These reports should be for the test conducted on the equipment similar to those proposed to be supplied under this contract and the tests should have been either conducted at an independent laboratory or should have been witnessed by a client.

However if contractor is not able to submit report of the type tests conducted within ten years from the date **28.11.2013** or in the case of type test reports are not found to be meeting the specification requirements, the bidder shall conduct all such tests under this contract at no additional cost to the owner either at third party lab or in presence of client/ owners representative and submit the reports for approval.

All acceptance and routine tests as per the specification and relevant standards shall be carried out. Charges for these shall be deemed to be included in the equipment price.

3.11 CORONA AND RIV TESTS AND SEISMIC WITHSTAND TEST:

- a) The corona (for 400kV only) and RIV tests shall confirm to the requirements as per Annexure A.
- b) The seismic withstand test for 400kV shall conform to requirements as per Annexure B.

3.12 Enclosures:

1. ANNEXURE- A - CORONA AND RADIO INTERFERENCE VOLTAGE (RIV) TEST
2. ANNEXURE- B - SEISMIC WITHSTAND TEST
3. ANNEXURE- I – MQP (NTPC format)
4. ANNEXURE- II – Quality Assurance (NTPC format)

CLAUSE NO.	TECHNICAL REQUIREMENTS 		
	Annexure – A		
	<p style="text-align: center;">CORONA AND RADIO INTERFERENCE VOLTAGE (RIV) TEST</p>		
1.0	General	<p>Unless otherwise stipulated, all equipment together with its associated connectors where applicable shall be tested for external corona both by observing the voltage level for the extinction of visible corona under falling power frequency voltage and measurement of radio interference voltage (RIV).</p>	
2.0	Test Levels	<p>The test voltage levels for measurement of external RIV and for corona extinction voltage are listed under the relevant clauses of the specification.</p>	
3.0	Test Methods for RIV:		
3.1	<p>RIV tests shall be made according to measuring circuit as per International Special – committee on Radio Interference (CISPR) Publication 16 -1 (1993) Part – 1. The measuring circuit shall preferably be tuned to frequency with 10 % of 0.5 MHz but other frequencies in the range of 0.5 MHZ to 2 MHZ may be used, the measuring frequency being recorded. The result shall be in microvolts.</p>		
3.2	<p>Alternatively, RIV tests shall be in accordance with NEMA standard Publication No. 107 – 1964 except otherwise noted herein.</p>		
3.3	<p>In measurement of RIV temporary additional external corona shielding may be provided. In measurement of RIV only standard fittings of identical type supplied with the equipment and a simulation of the connections as used in the actual installation will be permitted in the vicinity within 3.5 meters of terminals.</p>		
3.4	<p>Ambient noise shall be measured before and after each series of tests to ensure that there is no variation in ambient noise level. If variation is present, the lowest ambient noise level will form basis for the measurements. RIV levels shall be measured at increasing and decreasing voltages of 85% , 100%, 115% and 130% for the specified RIV test voltage for all equipment unless otherwise specified. The specified RIV test voltage for 420 KV is listed in the detailed specification together with maximum permissible RIV level in microvolts.</p>		
3.5	<p>The metering instruments shall be as per CISPR recommendations or equivalent device so long as it has been used by other testing authorities.</p>		
3.6	<p>The RIV measurement may be made with a noise meter. A calibration procedure of the frequency to which noise meter shall be tuned shall establish the ratio of voltage at the high voltage terminal to the voltage read by the noise meter.</p>		
4.0	Test Methods for visible Corona	<p>The purpose of this test is to determine the corona extinction voltage of the apparatus, connectors etc. The test shall be carried out in the same manner as RIV test described above with the exception that RIV measurements are not required during test and a search technique shall be used near the onset and extinction voltage, when the test voltage is raised and lowered to determine their precise values. The test voltage shall be raised to</p>	
NORTH KARANPURA STPP (3 X 660 MW) EPC PACKAGE	TECHNICAL SPECIFICATIONS SECTION VI, PART-B BID DOC. NO.:CS-4410-001-2	SUB SECTION B-14 SWITCHYARD	Page 6 of 102

CLAUSE NO.	TECHNICAL REQUIREMENTS 		
	<p>130 % of RIV test voltage and maintained there for five minutes. In case corona inception does not take place at 130 %, the voltage level shall be raised till inception of corona or rated voltage whichever is lower. The voltage will then be decreased slowly until all visible corona disappears. The test procedure shall be repeated at least 4 times with corona inception and extinction voltage recorded each time. The corona extinction voltage for purposes of determining compliance with the specification shall be the lowest of the four values at which the visible corona (negative or positive polarity) disappears.</p>		
NORTH KARANPURA STPP (3 X 660 MW) EPC PACKAGE	TECHNICAL SPECIFICATIONS SECTION VI, PART-B BID DOC. NO.:CS-4410-001-2	SUB SECTION B-14 SWITCHYARD	Page 7 of 102

<p>CLAUSE NO.</p>	<p style="text-align: center;">TECHNICAL REQUIREMENTS</p> 		
	<p style="text-align: right;">Annexure – B</p> <p>SEISMIC WITHSTAND TEST</p> <p>The seismic withstand test on the complete equipment (except BPI) shall be carried out along with supporting structure.</p> <p>The bidder shall arrange to transport the structure from his contractor's premises / owner's sites for purpose of seismic withstand test only.</p> <p>The seismic level specified shall be applied at the base of the structure. The accelerometers shall be provided at the terminal pad of the equipment and at any other point as agreed by the owner. The seismic test shall be carried out in all possible combinations of the equipment. The seismic test procedure shall be furnished for approval of the purchaser.</p>		
<p style="text-align: center;">NORTH KARANPURA STPP (3 X 660 MW) EPC PACKAGE</p>	<p style="text-align: center;">TECHNICAL SPECIFICATIONS SECTION VI, PART-B BID DOC. NO.:CS-4410-001-2</p>	<p style="text-align: center;">SUB SECTION B-14 SWITCHYARD</p>	<p style="text-align: center;">Page 8 of 102</p>

MFR.'s LOGO	MANUFACTURER'S NAME AND ADDRESS	MANUFACTURING QUALITY PLAN	PROJECT : PACKAGE : CONTRACT NO. : MAIN-SUPPLIER:
ITEM : SUB-SYSTEM:		QP NO. : REV.NO. : DATE : PAGE: OF	

SL. NO	COMPONENT & OPERATIONS	CHARACTERISTICS	CLASS	TYPE OF CHECK	QUANTUM OF CHECK		REFERENCE DOCUMENT	ACCEPTANCE NORMS	FORMAT OF RECORD	AGENCY			REMARKS
					M	C/N				M	C	N	
1.	2.	3.	4.	5.	6.	7.	8.	9.	D*	**	10.	11.	
<p>LEGEND: * RECORDS, IDENTIFIED WITH "TICK" (✓) SHALL BE ESSENTIALLY INCLUDED BY SUPPLIER IN QA DOCUMENTATION. ** M: MANUFACTURER/SUB-SUPPLIER C: MAIN SUPPLIER, N: NTPC P: PERFORM W: WITNESS AND V: VERIFICATION, AS APPROPRIATE, CHP: NTPC SHALL IDENTIFY IN COLUMN "N" AS "W"</p>													
MANUFACTURER/ SUB-SUPPLIER		MAIN-SUPPLIER		SIGNATURE		 FOR NTPC USE							REV..... CAT.....
SIGNATURE		SIGNATURE		SIGNATURE		SIGNATURE		SIGNATURE		SIGNATURE		APPROVAL SEAL	

FORMAT NO.: QS-01-QAI-P-09/FI-R1 1/1 ENGG. DIV./QA&I

CLAUSE NO.

QUALITY ASSURANCE



SWITCHYARD

SQE 20

Attributes / Characteristics Items/Components Sub Systems	Make, model, Type & Rating, Test Certificate	Routine & Acceptance Test as per IS / IEC	Functional requirements as per NTPC Specification
Circuit Breaker (IEC:62271-100)	Y	Y	Y
Interruptor & hollow insulator (IEC:233/ IS:5284)	Y	Y	Y
Isolator (IEC:62271-102)	Y	Y	Y
Current Transformer (IEC:60044/BS:3938/IS2705)	Y	Y	Y
Capacitor Voltage Transformer (IEC:186A / 358/IS3156/IEC60044)	Y	Y	Y
Bus Post Insulator (IEC:168 / 815 / IS:2544)	Y	Y	Y
Disc, Pin & String Insulator (IEC:383 / IS:731)	Y	Y	Y
Long Rod Insulator (IEC:433)	Y	Y	Y
Surge Arrestor (IEC:99-4/IS:3070)	Y	Y	Y
Hardware fittings for Insulator (IS:2486 / BS:3288)	Y	Y	Y
Spacer Clamps & Connector (IS:10162 / 5561)	Y	Y	Y
Aluminium Tube (IS:5082 / 2673 / 2678)	Y	Y	Y
Wave Trap (IEC:353 / IS:8792 / 8793)	Y	Y	Y
Conductor (IS:398-P-II)(V)	Y	Y	Y
Galvanised Steel Structures (IS:2062/2629/4759/6745)	Y	Y	Y
Vibration Damper (IS:9708)	Y	Y	Y
Sag Compensating Spring DIN:2089/2096 IS:3195 / 7906	Y	Y	Y
Control & Relay Panel	Y	Y	Y
SF6 Gas filling & evacuating plant	Y	Y	Y
SF6 Gas Leak Detector	Y	Y	Y
Leakage Current Analyser	Y	Y	Y
Nitrogen Gas Filling Device	Y	Y	Y
Protection Relays	Y	Y	Y
Event Logger	Y	Y	Y
Operation Analyser	Y	Y	Y
Disturbance Recorder	Y	Y	Y
Tariff Metering System	Y	Y	Y
Synchronising Trolley	Y	Y	Y

**NORTH KARANPURA STPP
(3 X 660 MW)
EPC PACKAGE**

**TECHNICAL SPECIFICATION
SECTION-VI, PART-B
BID DOC NO.:CS-4410-001-2**

**SUB-SECTION-E-51
SWITCHYARD**

CLAUSE NO.

QUALITY ASSURANCE



Attributes / Characteristics Items/Components Sub Systems	Make, Type Rating, and Model, Test Certificates	Routine & Acceptance Test as per relevant IS/IEC	Functional requirements as per NTPC Specification
Relay Test Kit	Y	Y	Y
LT Switchgear /LT Panels (IEC:947 / IS:13947)	Y	Y	Y
Battery IS:1652	Y	Y	Y
Lighting Panels	Y	Y	Y
Surge Monitor	Y	Y	Y

Notes : 1) This is an indicative list of test/checks. The manufacture is to furnish a detailed Quality Plan indicating the practice and procedure along with relevant supporting documents during QP finalisation for all items.
 2) All major Bought Out Items will be subject to NTPC approval.

SECTION-4			
GUARANTEED TECHNICAL PARTICULARS			
SI No	Description		
1	Walls /Roof	Panel Thickness & Material	
2		Cladding	
3		Roof Slope	
4		Roof Design Load	
5	Floor	Panel Thickness	
6		Cladding	
7		Additional Floor	
8		Floor Design Load	
9		Reinforcement	
10	Doors	Type & Size	
11		Door Profile	
12		Opening	
13		Door Gasketting	
14	PUF Material Property	Thickness	
15		Density	
16		Compressive Strength	
17		Tensile Strength	
18		Bending Strength	
19		Adhesions Strength	
20		Diamesion Stability	
21		Temperature Range	
22		Thermal Conductivity	
23		Fire Resistance	
24		Vapour Permeability	
25	Self Extinguishing		

SECTION-4			
GUARANTEED TECHNICAL PARTICULARS			
SI No	Description		
26	Kiosk Dimension	Length	
27		Width	
28		Height	
29		Over all Dimensional	
30	Colour Shade of Kiosk	RAL	
31	Air Conditioner	Model	
32		Capacity	
33		Air Flow	
34		Power Supply	
35		Compressor Type	
36		Controller	
37		Cooling /Circuit	
38		Total Cooling /Circuit	
39	Illumination	Model	
40		Make	
41		Lamp Type	
42		Lamp Base	
43		Nominal Voltage	
44		Mains Current	
45		Capacitor	
46		Power Factor	
47		Weight	
48	Smoke Detector	Type	
49		Quantity	

SECTION-5

**CHECK LIST FOR INFORMATION TO BE FURNISHED WITH OFFER
 RETURN THIS CHECKLIST AS PART OF THE OFFER DULY SIGNED**

The offer may not be considered if the following information and this Checklist are not enclosed with the Offer.

BHEL ENQUIRY. NO:

BIDDER OFFER REFERENCE:

A)

(1)	(2)	(3)	(4)	(5)
S.No.	Parameters	Data	Yes / No	Remarks in case reply in Col (4) is NO
1.0	Applicable Standard	Latest IS 13947(Part 1), IS 5039, IS 8623, IEC 60439, IS 13703 (All Parts), IS 12436 (requirement of grade PUR1)		
2.0	Size (L x B x H)	8.0m x 3.5m x 3m – 1 Nos.		
3.0	Walls /Roof			
3.1	Panel Thickness & Material	80mm Polyurethane Foam (PUF)		
3.2	Cladding	i) Inner 0.8mm polyester Precoated cold rolled Steel Sheet ii) Outer 0.6mm polyester Precoated cold rolled Steel Sheet		
3.3	Roof Slope	1 in 50 one side with 100 mm overhung on all sides		
3.4	Roof Design Load	200 kg/m ²		
4.0	Floor			
4.1	Panel Thickness	80mm Polyurethane Foam (PUF)		
4.2	Cladding	i) Inner 0.8mm Precoated Steel Sheet ii) Outer 1.0mm hot dip Galvanised Steel Sheet		
4.3	Additional Floor	18mm. Particle Board with Anti-static PVC Flooring		
4.4	Floor Design Load	700 kg/m ²		
4.5	Reinforcement	ISCM Floor Grid below the PUF Floor Panels		
5.0	Doors			
5.1	Type & Size	i) Main Door - 1200mm (W) x 2200mm(H) – 1 No ii) Emergency Exit Door - 750mm (W) x 2200mm (H)-1 No		
5.2	Door Profile	Al Extrusions		
5.3	Opening	i) Main Door Openable from Outside (Door flap open outside) ii) Emergency Door Openable from Inside (Door flap open outside)		

(1)	(2)	(3)	(4)	(5)
S.No.	Parameters	Data	Yes / No	Remarks in case reply in Col (4) is NO
5.4	Door Gasketing	Neoprene based rubber gasket		
6.0	PUF Material Property			
6.1	Thickness	78.6mm		
6.2	Density	40kg.± 2kg/m ³ (CFC Free)		
6.3	Compressive Strength	1.2kg./cm ²		
6.4	Tensile Strength	3.6kg / m ²		
6.5	Bending Strength	4kg / m ²		
6.6	Adhesions Strength	2.9kg./m ²		
6.7	Dimension Stability	At - 25 ⁰ C : 0.1% ; at 38 ⁰ C : 0.1%, and at more than 38 ⁰ C : 0.4%		
6.8	Temperature Range	-15 ⁰ C to 95 ⁰ C		
6.9	Thermal Conductivity	0.02 kcal/hr/m ⁰ C		
6.10	Fire Resistance	As per BS - 4735, Horizontal Burn < 125mm		
6.11	Vapour Permeability	0.08/0.12g/hr/m ²		
6.12	Self Extinguishing	Yes		
6.13	Water absorption	0.2%@100%RH		
6.14	Over all Dimensional Tolerance	± 10mm		
7.0	Colour Shade of Kiosk	RAL - 9003 / 9002 <i>(* To be finalised during detailed engineering)</i>		
8.0	MS (Painted /Galvanised) Structural Staircase	Provided		
9.0	Air Conditioner			
9.1	Minimum Capacity**	2 x (2 x 2TR)		
9.2	Power Supply	415V, 3Ph , 50HZ		
9.3	Compressor Type	Scroll		
9.4	Controller	Micro Processor Control		
10.0	Illumination			
10.1	Nominal Voltage	240 Volts		
10.2	Power Factor	≥0.90		
10.3	Lux level inside kiosk	Minimum 350 Lux at floor level		
10.4	One lighting fixture complete with luminaries and wiring just outside the kiosk on each of main & emergency exit doors	Provided		

(1)	(2)	(3)	(4)	(5)
S.No.	Parameters	Data	Yes / No	Remarks in case reply in Col (4) is NO
11.0	Fire Alarm Panel & Smoke Detector system	2 zone microprocessor based fire alarm panel and Ionization Type Smoke Detectors.		
12.0	Portable Fire Extinguisher	4.5kG CO ₂ Type Portable Fire Extinguisher- 1 No.		
13.0	Alarm signals to be wired to SAS (BCU Panel)	1) AC-1 in trouble		
		2) AC-2 in trouble		
		3) Room Temp High alarm		
		4) Fire Alarm		
		5) Aux Supply-1 Fail alarm (MCB Trip/ Off)		
		6) Aux Supply-2 Fail alarm (MCB Trip/ Off)		
14.0	Necessary temperature transducer (along with all accessories)	Provided		
15.0	Degree of Protection	IP 55		
16.0	Proto Testing	To be performed on one kiosk as per procedure mentioned in Clause No. 3 of Annexure-I of Section-1		
17.0	Installation & Erection at site of the supplied AC Kiosk	Included in scope of this tender		
18.0	Provision of remote control of air conditioning system from SAS (BCU Panel)	Provided		
19.0	Auto-changeover arrangement including timers at Incomers of AC Kiosk	Provided		

**Project: 400/220 kV Switchyard Package for
North Karanpura Super Thermal Power Project (3 X 660 MW)
Customer: NTPC Limited
Consultant: -----
Technical Specification: AIR CONDITIONED KIOSK**

**Bharat Heavy Electricals Limited
Document No. TB-369-510-009A**

B)

(1)	(2)	(3)
S.No.	Description	Confirmation of Supplier
1.	Bidder to confirm that all drawings / data sheets/QP/ valid type tests reports/ all relevant information shall be submitted to BHEL for organising approval of ultimate customer.	

Date:

Signature of the authorized representative of Bidder

Company Seal

**Project: 400/220 kV Switchyard Package for
North Karanpura Super Thermal Power Project (3 X 660 MW)
Customer: NTPC Ltd
Technical Specification: Air Conditioned Kiosk**

**Bharat Heavy Electricals Limited
Document No. TB- 369- 510 -009
Rev 00**

SECTION-6

ENCLOSURE

1. Wiring Diagram for AC Controller, lighting and Fire Alarm Panel (2 pages)
2. Isometric view showing typical location of Air Conditioning Units in an AC Kiosk

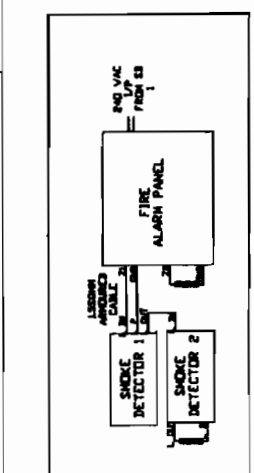
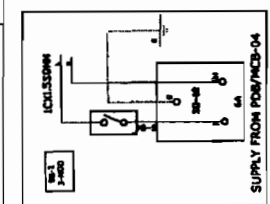
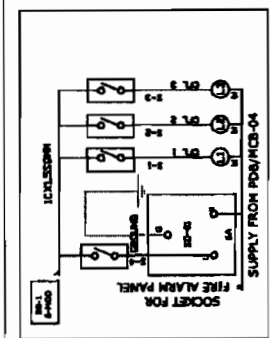
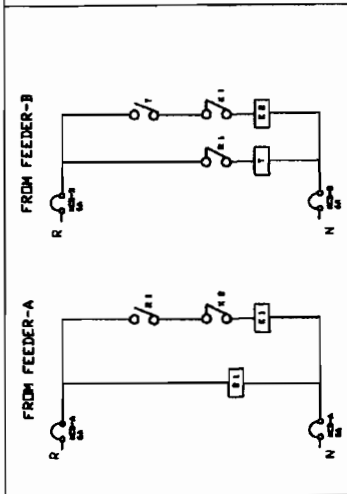
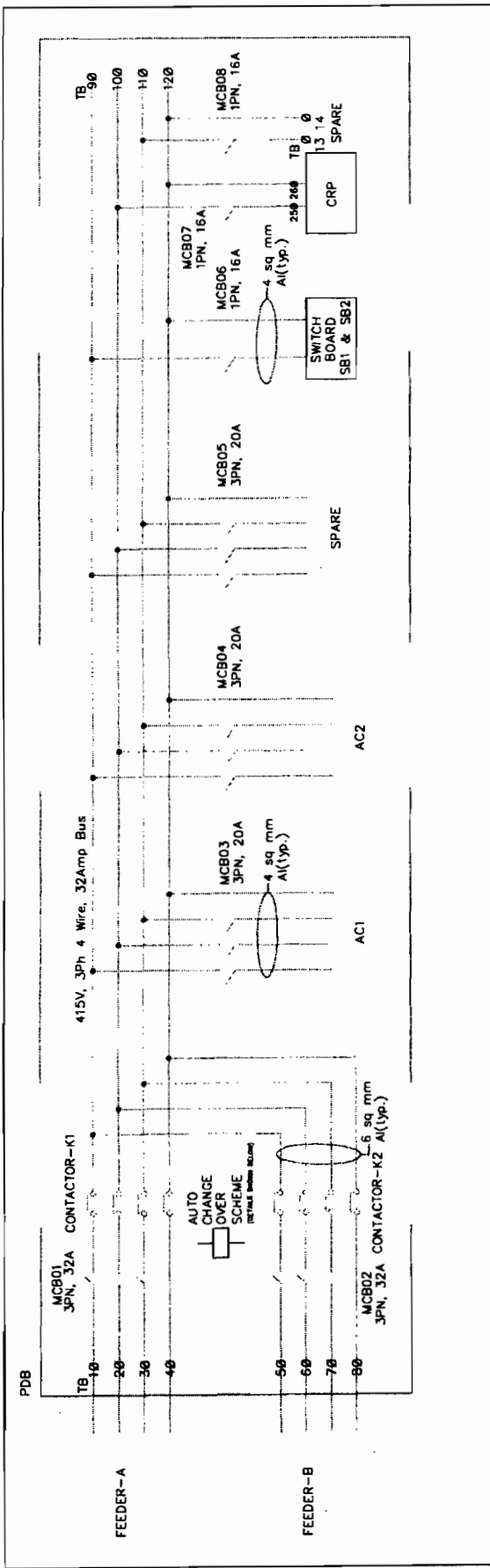

FOR TENDER PURPOSE ONLY

FOR TENDER PURPOSE ONLY

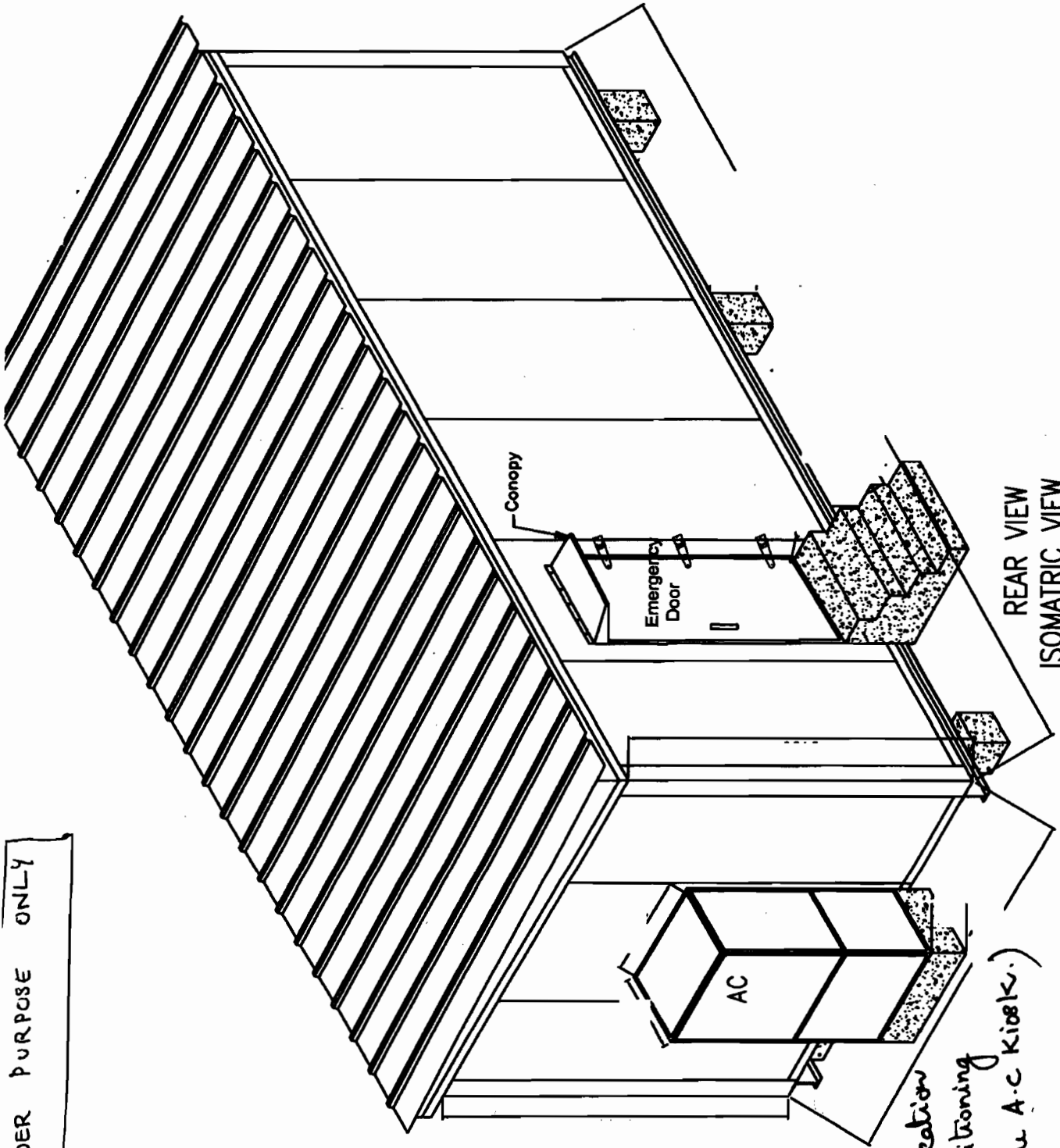

REAR VIEW
ISOMETRIC VIEW

(Typical location
of Air Conditioning
Unit on the A-C Kiosk.)



SUB-SUPPLIER QUESTIONNAIRE
(To be filled in by the Sub Supplier)

APPENDIX-Q1

Approval Desired for Process/item (Rating/Size/Type) :

1. Name of Company (Sub-Supplier):

2. Address of Regd. Office:

_____ Tel _____
_____ Mobile _____
_____ e-mail _____
_____ Fax _____

3. Address of Factory/Works

_____ Tel _____
_____ Mobile _____
_____ e-mail _____
_____ Fax _____

Weekly off day

4. Branch/Liaison Office in Delhi:

_____ Tel _____
_____ Mobile _____
_____ e-mail _____
_____ Fax _____

Weekly off day

[Handwritten signatures and marks]

**SUB-SUPPLIER QUESTIONNAIRE**

(To be filled in by the Sub Supplier)

5. Person(s) to be contacted

Place	Name(s)	Official Capacity	Telephone No(s)
-----	-----	-----	-----
Regd. Off.			
Factory			
Branch/ Liaison Off.			

6. Nature of Company : Proprietary/Partnership/Pvt. Ltd./Public Ltd.

Works Details:

7. Year of Factory Establishment :

8. Year of Commencement of Manufacture :

9. Total Area/Covered Area

10. Electric Power-Connected Load :
Electric Power-Standby Load & System11. Finance-Total Capital :
- Annual Turnover & profit
For past three years
- Limit of Credit Facility :
Available from the Banks

12. Do you have in-house Department for :

- | | |
|------------------------------------|--------|
| a) Design | Yes/No |
| b) Research & Development | Yes/No |
| c) Manufacturing/Production | Yes/No |
| d) Quality control/Inspection | Yes/No |
| e) Clearance from pollution deptt. | Yes/No |

13. Shift works per day One/Two/Three



SUB-SUPPLIER QUESTIONNAIRE
(To be filled in by the Sub Supplier)

14. Details regarding employees :

Division Status	Graduate		Diploma	Skilled	Un-Skilled	Remarks
	Technical	Non-Technical				
Production						
Quality Control						
Admn & other Supporting Activities						

15. Please enclose a copy of company's organisation chart (for the unit).

16. Trade Name of Product (if any) :

17. Manufacturing capacity details :

S. N.	Product	Licensed Capacity	Installed Capacity

18. Brief details of items manufactured :

Sl. No.	Item & Material	Description (Type/Size/Rating)	Annual Production for last Three years		
			I	II	III

(Handwritten signatures and marks)



SUB-SUPPLIER QUESTIONNAIRE
 (To be filled in by the Sub Supplier)

19. Details of foreign collaboration, if any :

Sl. No.	Product	Name & Address of Collaborator	Collaboration		
			Scope	Year	Valid upto

20. Have your product been type tested by any external agency? If so, give details

Sl. No.	Product	Test (Size, Type & Class)	Test Report No. & Date	Next Due Date

21. Indicate Approval/Certification by National/International standards/agencies applicable for the subject product.

Sl. No.	Product	Code/Standard	License No. & Date

(Handwritten signatures and marks)



SUB-SUPPLIER QUESTIONNAIRE
 (To be filled in by the Sub Supplier)

22. Have you been approved by any third party/statutory agency? If so, indicate details and enclose copies of approval letters.

Sl. No.	Item/ Material	Description (Size, Type & Class)	Agency	Date of Approval	Next Due Date

23. Reference list (Experience in the particular type of equipment) :

Sl. No.	Item/ Material	Type & Capacity	Customer (End User) with Address	Date of supply	Under Operation Since Year/ Month

[Handwritten signatures and marks]



SUB-SUPPLIER QUESTIONNAIRE
(To be filled in by the Sub Supplier)

24(a) Specific to process & product facilities :

Sl. No.	Description of machine	Capacity & Nos.	Location Shop	Make	Year of Manufg.



SUB-SUPPLIER QUESTIONNAIRE
(To be filled in by the Sub Supplier)

24(b) Other/General facilities .

Sl. No.	Description of machine	Capacity & Nos.	Location Shop	Make	Year of Mfg.
1)	Material Handling Mobile Crane Fork Lift Over Head Cranes				
2)	Metal Cutting & Bending				
3)	Casting				
4)	Forging				
5)	Fabrication				
6)	Welding				
7)	Machining				
8)	Heat Treatment				
9)	Sheet Metal				
10)	Fettling & Cleaning Sand Blasting Shot Blasting Pickling				
11)	Painting				
12)	Metal Coating				
13)	Protection before packing				
14)	Packing				
15)	Other				



SUB-SUPPLIER QUESTIONNAIRE
 (To be filled in by the Sub Supplier)

25 (a) Facilities for Testing & Inspection :

Sl. No.	Description	Capacity & Nos.	Make & year of Mfg.	Calibration Status	Approval Qualification

25 (b) If In-house testing facilities are not available, indicate source of testing with relevant details:

Sl. No.	Source of Testing	Description	Capacity & Nos.	Make & year of Mfg.	Calibration Status	Approval/Qualification

26 (a) Details of any Govt. laboratory facilities available in area :

26 (b) Product related testing facilities (Type/Performance/Routine/Acceptance Tests) :

26 (c) Storage of finish goods (covered / open)

Handwritten signatures and marks at the bottom of the page, including a circled '53' and various scribbles.



SUB-SUPPLIER QUESTIONNAIRE
(To be filled in by the Sub Supplier)

27. Source of Raw Materials (including imported raw materials) :
- a) Type Source
- b) Raw material storage & identification :
28. No. of PCs available with internet Connectivity at works:
- 29. Quality management**
- 29.1 General**
- 29.1.1. Organisation Chart of Quality Management: Attached: (Y/N)
- 29.1.2. Head of QC Department reports to :
- 29.1.3. Do you have a written Quality Control Instruction Manual? If yes, please furnish a copy of the same.
- 29.1.4. Have written Quality Control Instruction sheets been prepared and properly used ?
- 29.1.5. Are records generated during inspection maintained & available for review?
- 29.1.6. Are final inspection areas clean, adequately lighted & of suitable size?
- 29.1.7. Are written procedure defining stage wise operations and functions on shop floor established and followed?
- 29.1.8. Are quality control checks adequate to maintain desired quality right from incoming stage to final operation?
- 29.1.9. Whether 100% or adequate sampling inspection used?
- 29.1.10. Are statistical quality control techniques used?
- 29.2. Corrective Action**
- 29.2.1. Does the system provide for proper detection of inferior quality and correction of its assignable causes?
- 29.2.2. Is adequate action taken to correct the causes of defects in products?
- 29.2.3. Are analysis made to identify trends towards product deficiencies?
- 29.2.4. Does corrective action extend to products?



SUB-SUPPLIER QUESTIONNAIRE

(To be filled in by the Sub Supplier)

29.3 Documentation Control

- 29.3.1. Does a system for clear and precise stipulation of responsibilities for documentation issue & change control exists?
- 29.3.2. Are changes made in writing?

29.4. Control of Inspection, measuring & Testing equipments

- 29.4.1. Are necessary gauges, testing and measuring equipment's, available and used?
- 29.4.2. Are testing and measuring equipment properly maintained?
- 29.4.3. Is recorded control on calibration of equipment available?

29.5. Control of procured supplies & Services

- 29.5.1. Do the vendor/sub-Supplier's purchasing documents refer to specific design manufacturing and testing requirements?
- 29.5.2. Do purchasing documents also contain special requirements?
- 29.5.3. Are requirements for necessary tests and inspection of raw material specified in purchasing documents?

30. **CONSISTENCY IN SUPPLY**

- 30.1. Has the vendor/sub-Supplier produced items of similar nature in past?
- 30.2. Has the vendor/sub-Supplier maintained delivery commitments in past?
- 30.3. Has there been frequent labour trouble in past?
- 30.4. Has there been major upset due to faulty material management?
- 30.5. Whether the system of planning and scheduling resilient enough to overcome temporary setbacks and make up lost time?
- 30.6. Can the vendor/sub-Supplier quickly off load the work to other reliable subvendors:
If Yes, the name of sub-vendors :

31. Order booking position as on date in terms of:
- a) Value :
- b) Time :

32. Any special information

55

[Handwritten signatures and marks]

[Handwritten '55' in a circle]



SUB-SUPPLIER QUESTIONNAIRE
 (To be filled in by the Sub Supplier)

33. I CERTIFY THAT THE INFORMATION SUPPLIED HEREIN (INCLUDING ALL PAGES ATTACHED) IS CORRECT TO THE BEST OF MY KNOWLEDGE.

SEAL

SIGNATURE _____
 NAME _____
 DESIGNATION _____
 M/S. _____
 PLACE _____
 DATE _____

LIST OF ENCLOSURE

- 1.
- 2.
- 3.

Certification by Main Supplier: Above information have been verified and found in order / minor changes which have been marked and initialed on this form itself / observed the following discrepancies.

Name : _____ Designation : _____ Signature : _____ Date : _____

Certification by visiting team : Above information except as under have been verified and found in order.

Name : _____ Designation : _____ Signature : _____ Date : _____

- 1.
- 2.

56

(Handwritten signatures and initials)



MAIN SUPPLIES'S EVALUATION REPORT
(For Proposed Sub-Supplier)

APPENDIX-Q2

MAIN SUPPLIER M/S.....

PACKAGE & PROJECT :

EQUIPMENT / ITEM :

GENERAL INFORMATION

1. PROPOSED SUB-SUPPLIER'S :
NAME & WORKS ADDRESS

2. CONTACT PERSON :
TELEPHONE (LAND LINE/MOB.) :
FAX :
E-MAIL :

3. BRIEF SPEC. OF EQUIPMENT
ITEM/MODEL/TYPE /RANGE / CAPACITY:

4. REFERENCE LIST (EXTENSIVE EXPERIENCE IN THE PARTICULAR TYPE OF
EQUIPMENT / ITEM)

CUSTOMER/ LOCATION WITH ADDRESS AND CONTACT PERSON	TYPE, RATING & CAPACITY	DATE OF COMMISS- IONING.	NO. OF YRS. IN OPERA- TION	PERFORMANCE FEEDBACK

5. RECOMMENDATIONS :

NAME _____ DESIGN _____ SIGN.: _____

List of Encl. _____

Date : _____

[Handwritten signatures and initials]

APPENDIX-Q3

MFGR.'s LOGO		MANUFACTURER'S NAME AND ADDRESS		MANUFACTURING QUALITY PLAN				PROJECT :							
ITEM :		SUB-SYSTEM:		QP NO.:	PACKAGE :	REV. NO.:	CONTRACT NO.:	ACCEPTANCE NORMS	FORMAT OF RECORD	AGENCY			REMARKS		
DATE:		PAGE: OF		TYPE OF CHECK	CLASS	CHARACTERISTICS	3.	4.	5.	6.	7.	8.	9.	10.	11.
SL. NO	COMPONENT & OPERATIONS	1.	2.	3.	4.	5.	6.	7.	8.	9.	10.	11.	12.	13.	14.
QUANTUM OF CHECK		REFERENCE DOCUMENT		ACCEPTANCE NORMS		FORMAT OF RECORD		AGENCY		REMARKS					
M C/N		M C/N		M C/N		M C/N		M C/N		M C/N		M C/N		M C/N	
1.															

MANUFACTURER/ SUB-SUPPLIER		SIGNATURE		LEGEND: * RECORDS IDENTIFIED WITH "TICK" (✓) SHALL BE ESSENTIALLY INCLUDED BY SUPPLIER IN QA DOCUMENTATION. ** M: MANUFACTURER/SUB-SUPPLIER C: MAIN SUPPLIER, N: NTPC P: PERFORM W: WITNESS AND V: VERIFICATION AS APPROPRIATE, CHP: NTPC SHALL IDENTIFY IN COLUMN "N" AS "W"		FOR NTPC USE		REV. CAT.	
MAIN SUPPLIER		MAIN SUPPLIER		REVIEWED BY		APPROVED BY		APPROVAL SEAL	
SIGNATURE		SIGNATURE		REVIEWED BY		APPROVED BY		APPROVAL SEAL	

ENG. DIV./QA&I

1/1

FORMAT NO.: QS-01-QAL-P-09/F1-R1

Handwritten signature

Handwritten initials

58

Handwritten marks and signatures at the bottom of the page.

APPENDIX-05

SUPPLIER'S LOGO		SUPPLIER'S NAME AND ADDRESS		FIELD QUALITY PLAN					PROJECT PACKAGE CONTRACT NO.: MAIN-SUPPLIER:	
ITEM: SUB-SYSTEM:		CHARACTERISTICS/INSTRUMENTS		CLASS OF CHECK #	TYPE OF CHECK	QUANTUM OF CHECK	REFERENCE DOCUMENT	ACCEPTANCE NORMS	FORMAT OF RECORD	REMARKS
SL. NO	ACTIVITY AND OPERATION	3.	4.	5.	6.	7.	8.	9.	D*	10.
1.										

MANUFACTURER/ SUB-SUPPLIER		SIGNATURE		LEGEND: 4 RECORDS IDENTIFIED WITH "TICK" (✓) SHALL BE ESSENTIALLY INCLUDED BY SUPPLIER IN QA DOCUMENTATION. LEGEND TO BE USED: CLASS # : A - CRITICAL, B-MAJOR, C-MINOR; 'A' SHALL BE WITNESSED BY NTPC FOA, 'B' SHALL BE WITNESSED BY NTPC ERECTION / CONSTRUCTION DEPT. AND 'C' SHALL BE WITNESSED BY MAIN SUPPLIER (A & B CHECK SHALL BE NTPC CHP STAGE)		DOC. NO.:		REV.	
						FOR NTPC USE		APPROVED BY	
								APPROVAL SEAL	

ENG. DIV./QA&I
[Signature]

[Signature]

1/1

FORMAT NO.: QS-01-QA1-P-09/F2-R1

[Handwritten marks and signatures at the bottom of the page]