

TECHNICAL QUALIFICATION REQUIREMENT

Name of Project: 400/220 kV GIS SUB STATION AT ERSAMA, PARADEEP, ODISHA

Name of Customer: ODISHA POWER TRANSMISSION CORPORATION LIMITED

Name of Item: SMPS BASED FLOAT-CUM-BOOST CHARGERS FOR 48V MF-VRLA BATTERIES

TECHNICAL QUALIFICATION REQUIREMENT

The bidder should have designed, manufactured, tested and supplied at least TWO (2) Nos. of SMPS based BATTERY CHARGER of minimum 48 Volt and 50 Ampere rating, which should be in successful operation for a period of not less than 2 years as on original scheduled date of technical bid opening of this tender.

SUPPORTING DOCUMENTS TO BE SUBMITTED BY BIDDER ALONG WITH TECHNICAL BID

Sr	Required Criteria	Supporting Documents
1	Manufacturing	Approved Drawings / GTP / Approved Quality Plan / Factory Inspection Test Report etc. stabilising bidder as manufacturer of offered item in line with TQR
2	Supply	PO / Dispatch clearance / LR / Material Receipt certificate at site / installation or commissioning certificate etc. stabilising bidder as proven supplier of offered item in line with TQR
3	Type Test	TTR approval from customer / Type Test Report etc. stabilising successful type tested design in line with TQR
4	Commissioning	Pre commissioning report / commissioning report / Site Visit report issued by employer/end-customer or main contractor (along with chain of document from employer/end-customer) stating supervision of commissioning or pre-commissioning by bidder etc.
5	Successful operation	Successful operation means certificate issued by employer/end-customer or main contractor (along with chain of document from employer/end-customer) stating successful operation without any adverse remark.

Prepared by
5/7/23

Reviewed by
05/07/23

Approved by
6.7.23

PREPARED BY

REVIEWED BY

APPROVED BY



BHARAT HEAVY ELECTRICALS LIMITED
TRANSMISSION BUSINESS ENGINEERING MANAGEMENT
 NOIDA

DOCUMENT NO.	TB-420A-316-025B	REV 00	Prepared	Checked	Approved
TYPE OF DOC.	TECHNICAL SPECIFICATION	NAME	BY	DKS	YK
Title:		SIGN	<i>वेदनाय यादव</i> 7/7/23	<i>DKS</i>	<i>Mushap</i>
48V FLOAT CUM BOOST BATTERY CHARGER		DATE	05.07.23	05.07.23	05.07.23
		GROUP	TBEM		
		WO No.	-		
CUSTOMER	ODISHA POWER TRANSMISSION CORPORATION LIMITED				

PROJECT	400/220 KV GIS SUB STATION AT ERSAMA, PARADEEP, ODISHA
---------	--

<u>Contents</u>		
Section No.	Description	No of Pages
Section-1	Scope, Technical Requirements and Quantities	11
Section-2	Equipment Specification under scope of supplies and Electrical design basis of 400kV Pothead Yard REV04	20
Section-3	Project details and general technical requirements (For all equipment under the Project)	46
Section-4	Annexures Annexure-A: Compliance Certificate to Technical Specification Annexure-B: Deviation(s) to Technical Specification Annexure-C: Technical Checklist Annexure-D: Guaranteed Technical Particulars	7

Remarks: Bidder to note that data and details of Annexure-D (Guaranteed Technical Particulars) shall not be reviewed during technical evaluation/ scrutiny, hence compliance of guaranteed technical particulars in line with technical specification shall be bidder's responsibility.

COPYRIGHT & CONFIDENTIAL
 The information in this document is the property of BHARAT HEAVY ELECTRICALS LIMITED
 This must not be used directly or indirectly in anyway detrimental to the interest of the

Rev. No.	Date	Altered	Checked	Approved	
Distribution				To	
				Copies	

CHECKLIST FOR TECHNICAL EVALUATION

Along with the technical offer/ bids, the bidder should submit this checklist confirming the inclusion of the enclosures as listed below,

Sl. No.	Documents to be enclosed	Bidder to confirm (Please tick "Confirmed")
1.	Supporting documents for compliance of Technical Qualifying Requirement.	Confirmed
2.	Unpriced BOQ duly mentioning "Quoted" for all the items, signed and sealed.	Confirmed
3.	Annexure- A duly signed and sealed & Annexure- B duly filled, signed and sealed.	Confirmed

Note: Any bidder not meeting the above requirement shall be liable for non-evaluation. The above checklist is reviewed and verified for,

NIT Reference No.:

Name of Bidder:

Name of Project: 400/220 kV GIS SUB STATION AT ERSAMA, PARADEEP, ODISHA

Date:

Bidder's Stamp & Signature

Bharat Heavy Electricals Limited

Project: 400/220 kV GIS SUB STATION AT ERSAMA, PARADEEP, ODISHA
Technical Specification: 48V FLOAT CUM BOOST BATTERY CHARGER
Doc No. TB-420A-316-025B Rev 00

Contents

SECTION 1:	2
SCOPE, PROJECT SPECIFIC TECHNICAL REQUIREMENTS & BILL OF QUANTITIES	2
1. Scope	2
2. Codes & Standards	2
3. Specific Technical Requirements	4
4. Bill of Quantities	5
5. Training	5
6. Drawings / Documents required for Technical Clearance for Manufacturing	5
7. Type Testing	6
8. Quality Plan	6
9. Inspection & Testing	7
10. List of Documents/ Drawings	7

Bharat Heavy Electricals Limited

Project: 400/220 kV GIS SUB STATION AT ERSAMA, PARADEEP, ODISHA
Technical Specification: 48V FLOAT CUM BOOST BATTERY CHARGER
Doc No. TB-420A-316-025B Rev 00

SECTION 1:

SCOPE, PROJECT SPECIFIC TECHNICAL REQUIREMENTS & BILL OF QUANTITIES

1. Scope

This technical specification covers the requirements of design, manufacture, testing at works, packing and dispatch to site & supervision of Erection, testing & commissioning of **48V Float cum Boost Battery Charger** complete with rack assembly and other accessories as required for trouble free operation of batteries.

This section covers the specific technical requirements of **48V Float cum Boost Battery Charger**. In case of any discrepancies between the requirements mentioned in this section and those specified in other sections of the specification, the specifications given herein shall prevail and shall be treated as binding requirements.

No deviation from the requirements specified in various clauses of this specification shall be allowed. A certificate to this effect shall have to be furnished along with the offer.

The equipment is required for the following project:

Name of the Customer	:	ODISHA POWER TRANSMISSION CORPORATION LIMITED
Name of Main Contractor	:	BHARAT HEAVY ELECTRICALS LIMITED
Name of the Project	:	400/220 kV GIS SUB STATION AT ERSAMA, PARADEEP, ODISHA

The scope of supplies shall be as per commercial terms and conditions enclosed separately with the notice inviting tender/ enquiry.

2. Codes & Standards

All equipment and their accessories, covered by this specification shall be designed, manufactured and tested in compliance with the latest relevant standards, published by the Bureau of Indian Standards including those, listed below in order that specific aspects under Indian climatic conditions are taken care of.

The equipment and accessories for which Indian Standards are not available shall be designed, manufactured and tested in accordance with the latest standards, published by any other recognized National Standards Institution and latest publication of International Electro Technical commission [IEC].

The equipment manufactured according to any other authoritative national / international standard, which ensures an equal or better quality than the provisions of these specifications shall also be acceptable. Where the equipment, offered conform to any other standard, salient points of differences between the proposed standard and the provisions of these specification shall be clearly brought out in the tender. A copy of such standards [in English] shall be enclosed with the offer.

Bharat Heavy Electricals Limited

Project: 400/220 kV GIS SUB STATION AT ERSAMA, PARADEEP, ODISHA
Technical Specification: 48V FLOAT CUM BOOST BATTERY CHARGER
Doc No. TB-420A-316-025B Rev 00

The equipment shall conform to the Indian Electricity Rules, 1956 with latest amendments as regards safety earthing and other essential provisions specified therein for installation and operation of electrical plants.

All equipment shall also comply with the statutory requirements of the Government of Orissa where the equipment will be installed. Nothing shall be construed to relieve the supplier of his responsibility.

Governing Specifications:

The MF-VRLA batteries shall unless otherwise specified, conform to the following standards. The firms are requested to furnish the following specifications for our further reference.

i	IS-1651/1991	Specification for stationary cells batteries, leads acid type.
ii	IS-1885 [Part-8] / 1986	Electro technical vocabulary: Part- 8-Secondary cells & batteries.
iii	IS-266/1977	Sulphuric acid
iv	BS-46290 (Part-4) / 1997	British standard specification for lead acid type valve regulated sealed type batteries.
v	ANSI, IEEE STD 450/1987	IEEE recommended practice for maintenance, testing and replacement of large lead storage batteries for generating stations and sub-stations.
vi	IEC 896-2/1995	Stationary lead-acid batteries, general requirements and methods of test (part-2, valve regulated types)
vii	IS-(1146 / UI-94) / ASTM - d -29863	Plastic container for lead acid storage batteries.
viii	IS-3136-1965	Specification for polycrystalline semiconductor rectifier equipment
ix	IS-1248-1968	Specification for direct acting indicating analogue electrical measuring instruments and tier accessories. (Part - I)-1983-General Requirements. (Part - II)- 1983 - Ammeters & voltmeters. (Part-III)-1984-Accessories.
x	IS-2208-1962	Specification of HRC Cartridge fuse link up to 650V
xi	IS-2959-1966	Specification of contractors for voltages not exceeding 1000V AC or 1200V DC
xii	IS-3395-1966	Specification for monocrystalline semiconductor rectified cells and stacks.
xiii	IS-4540-1968	Monocrystalline semiconductor rectifier assemblies & equipment
xiv	IS-2147/1962	Degree of protection provided by enclosure for low voltage switchgear and control gear
xv	IS-5578/1984	Guide for marking of insulated conductors.
xvi	IS-8623/1993 [Part 1 to 3]	Low voltage switchgear and control gear assemblies.
xvii	IS-11171/1985	Dry type power transformers.

Bharat Heavy Electricals Limited

Project: 400/220 kV GIS SUB STATION AT ERSAMA, PARADEEP, ODISHA
Technical Specification: 48V FLOAT CUM BOOST BATTERY CHARGER
Doc No. TB-420A-316-025B Rev 00

xviii	IS-11353-1985	Guide for uniform system of marking and identification of conductors and apparatus
xix	IS-13947-1993 (Part 1 to 5)	Low voltage switchgear and control gear

3. Specific Technical Requirements

- The equipment (**48V Float cum Boost Battery Charger**) shall perform satisfactorily under various other electrical, electromechanical and meteorological conditions of the site of installation.
- Equipment shall be able to withstand all external and internal mechanical, thermal and electromechanical forces due to various factors like wind load, temperature variation, ice & snow, (wherever applicable) short circuit etc. for the equipment.
- In addition to this, the other specific technical requirements for the equipment (**48V Float cum Boost Battery Charger**) shall be as follows,

Sl. No.	Parameter	Specification
1	Nominal Voltage Rating (V)	48 V
2	Charger Rating (A)	125 A
3	Permissible ripple content at any DC load	1%
4	Design Ambient temp.	50 deg. C
5	Battery Data	
5.1	Rating	800 (AH)
5.2	Type of Battery	Valve Regulated Lead Acid (VRLA) Type Battery
5.3	Proposed method of working (Volts per Cell)	
	a. Trickle Charging	2.25 V/ Cell
	b. Boost Charging	2.7 V/ Cell
	c. End Cell Voltage	1.75V per cell
Note: 48 V DC system is +ve earthed.		
6	System Condition	
6.1	Short Circuit Level	
	a. 415V A.C. (for 1 Sec.)	63 kA
	b. D.C. (for 1 Sec.)	25 kA
6.2	3 phase A.C. supply	415 V (±10%) 50 Hz (±5%) 3 Phase, 4 Wire
6.3	1 phase A.C. supply	240 V (±10%) 50 Hz (±5%)
7	Min. Terminal size with lugs suitable for following cables#	
7.1	Cable between DCDB and charger	1C x 150 sq. mm (Al/ XLPE)
7.2	AC incomer for charger from ACDB (415 V)	1 run of 3.5Cx70 sq. mm (Al/ PVC)

Bharat Heavy Electricals Limited

Project: 400/220 kV GIS SUB STATION AT ERSAMA, PARADEEP, ODISHA
Technical Specification: 48V FLOAT CUM BOOST BATTERY CHARGER
Doc No. TB-420A-316-025B Rev 00

7.3	AC emergency incomer for charger from EPDB (415 V, 3 wire)	1 run of 3.5Cx70 sq. mm (Al/PVC)
Notes: 1. # - Terminals shall be suitable for a minimum size of cables as mentioned above. Actual requirement shall be informed during detailed engineering.		

4. Bill of Quantities

4.1. Quantities for the equipment shall be as mentioned below. However, any item not appearing herein but required for completeness of the work and mentioned elsewhere is deemed to be included in bidder's scope.

Sl. No.	Description	Unit	Quantity
A	Main Item		
1	SMPS based battery charger (along with accessories) of 125A suitable for 48V VRLA battery bank	Set	2
B	Mandatory Spares		
1	AC Contactor (if applicable) (1 Set= 1 No. per Charger)	Set	2
2	DC Contactor (if applicable) (1 Set= 1 No. per Charger)	Set	2
3	Required HRC Fuses of appropriate rating (1 Set= 4 No. per Charger)	Set	2
C	Service		
1	Supervision of installation, testing & commissioning of 48V, 125A SMPS based battery charger	Set	2

Notes:

1. Prices of following accessories or any other accessory required are deemed to be included in Prices of Main items,
a) Fixing bolts for mounting the chargers on the floor – 1 Lot.

5. Training

The bidder shall arrange for training of at least five Telecom. Engineering personnel of OPTCL on operation & maintenance of 50 V Float-Cum-Boost chargers free of cost. Every detail regarding repair of all probable defects need be imparted to the trainee engineers at works of the manufacturer. The bidder in their offer need intimate the duration of training. However, the training must be conducted prior to delivery of the Battery chargers.

6. Drawings / Documents required for Technical Clearance for Manufacturing

The engineering drawings/ documents, shall be used for providing technical clearance for manufacturing of the equipment, which shall be used for delay analysis, if applicable.

Bharat Heavy Electricals Limited

Project: 400/220 kV GIS SUB STATION AT ERSAMA, PARADEEP, ODISHA

Technical Specification: 48V FLOAT CUM BOOST BATTERY CHARGER

Doc No. TB-420A-316-025B Rev 00

1	48 V Battery Charger - Drawings & Guaranteed Technical Particulars
2	48 V Battery Charger - Type Test Reports
3	48 V Battery Charger - Quality Assurance Plan

Date of Submission of drawings/ documents shall be counted only from the date of submission of reasonably correct drawings/ documents. In case drawing/ document are not duly stamped in category-1/ category-2 by customer, BHEL stamp/ confirmation shall be treated final to proceed further.

The successful bidder shall have to extend all possible supports like timely submission/ resubmission of drawings, visit to end customer to facilitate documents approval without any commercial implications to BHEL. Acceptance of bidder's documents shall be subject to end customer/ OPTCL approval.

7. Type Testing

6.1 The **48V Float cum Boost Battery Charger** to be supplied shall be of type tested design. During detail engineering, the bidder shall submit for Owner's approval the reports of all the type tests as listed in this specification and carried out within last five years from the date of techno-commercial bid opening i.e. 11-Feb-2022. These reports should be for the test conducted on the equipment similar to those proposed to be supplied under this contract and the test(s) should have been either conducted at an independent laboratory or should have been witnessed by a client.

Please refer clause no. 2.28, Part-B of Section-II for customer specific requirement of Type Test reports. Bidder to submit duly signed & stamped Annexure: IV-B & Annexure: V-B enclosed with Section-2.

6.2 However, if the bidder is not able to submit reports of the type test(s) conducted within last five years from the date of techno-commercial bid opening, or in the case of type test report(s) are not found to be meeting the specification requirements, the bidder shall conduct all such tests under this contract at no additional cost to the BHEL either at third party lab or in presence of client/owners representative and submit the reports for approval.

6.3 All acceptance and routine tests as per the specification and relevant standards shall be carried out. Charges for these shall be deemed to be included in the equipment price.

8. Quality Plan

The successful bidder shall submit Quality Assurance Plan including in-process inspection methods, tests, records, etc. for BHEL/ OPTCL approval. Customer hold points will also be included in the plan, which shall be mutually agreed by the BHEL/ OPTCL. In case bidder has reference Quality Assurance Plan agreed with BHEL/ OPTCL, same shall be submitted for specific project to BHEL/ OPTCL approval. There shall be no commercial implication to BHEL/ OPTCL on account of Quality Plan approval.

Bharat Heavy Electricals Limited

Project: 400/220 kV GIS SUB STATION AT ERSAMA, PARADEEP, ODISHA

Technical Specification: 48V FLOAT CUM BOOST BATTERY CHARGER

Doc No. TB-420A-316-025B Rev 00

Bidder has to follow OPTCL approved Manufacturing Quality Plan, SAT/ FAT procedure at contract stage.

9. Inspection & Testing

1. Equipment shall be subject to inspection by BHEL/OPTCL or authorized representative at bidder/ manufacturers' works. Hence, Bidder shall furnish all necessary information concerning the supply to BHEL/ OPTCL.
2. Routine and acceptance tests as listed in relevant standard and section-2, technical specifications shall be complied.
3. Bidder shall also furnish factory acceptance test (FAT) from manufacturers for BHEL/ OPTCL approval in line with specific requirements mentioned in section-2, technical specification.

10. List of Documents/ Drawings

Following drawing/ documents are attached for information purpose,

1. TB-1-420-607-700/701/703: CONTROL ROOM BUILDING-FLOOR PLANS & SECTIONS

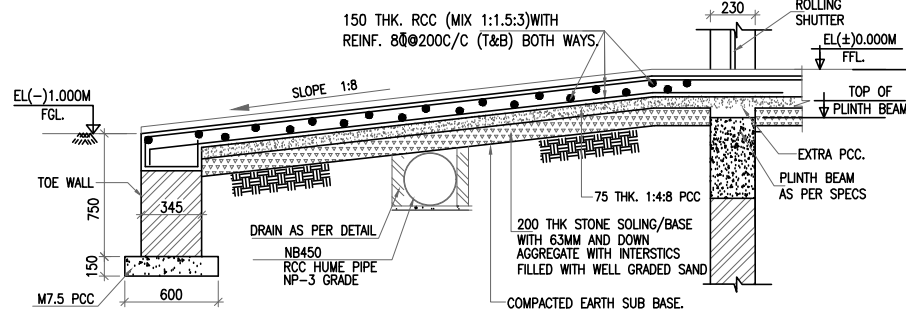

DETAIL OF RAMP

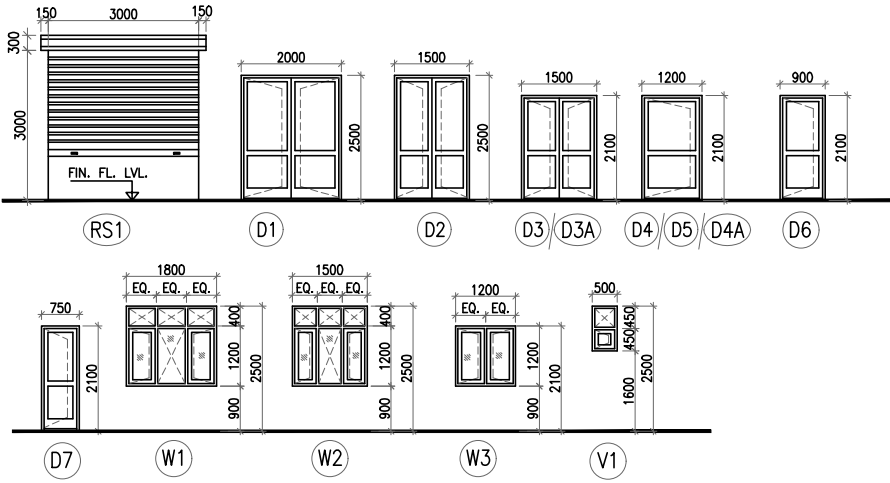

SCHEDULE OF DOORS & WINDOWS							
TYPE	OPENING SIZE	FRAME SIZE	CILL LEVEL	LINTEL LEVEL	NOS. (GR. FL.)	NOS. (FIRST+ TERRACE FL.)	DESCRIPTION
RS1	3000x3000	3000x3000	-	3000	1	-	
D1	2000x2500	1980x2490	-	2500	1	-	
D2	1500x2500	1480x2490	-	2500	2	1	
D3	1500x2100	1380x2090	-	2100	3	-	
D3A	1500x2100	1380x2090	-	2100	-	1	
D4	1200x2100	1180x2090	-	2100	-	6+1=7	
D4A	1200x2100	1180x2090	-	2100	-	1	
D5	1200x2100	1180x2090	-	2100	1	1	
D6	900x2100	880x2090	-	2100	4	4	
D7	750x2100	730x2090	-	2100	1	4	
W1	1800x1600	1780x1580	900	2500	11	6	
W2	1500x1600	1480x1580	900	2500	2	6	
W3	1200x1200	1180x1180	900	2100	-	2	
V1	500x900	480x880	1600	2500	4	7	
FG1	7400x1900	7380x1880	600	2500	-	1	
FG1	4900x1900	4880x1880	600	2500	-	1	
FG2	1590x1900	1570x1880	600	2500	-	1	

SEPARATE DRAWING SHALL BE REFERRED FOR DOOR/WINDOW DETAILS.

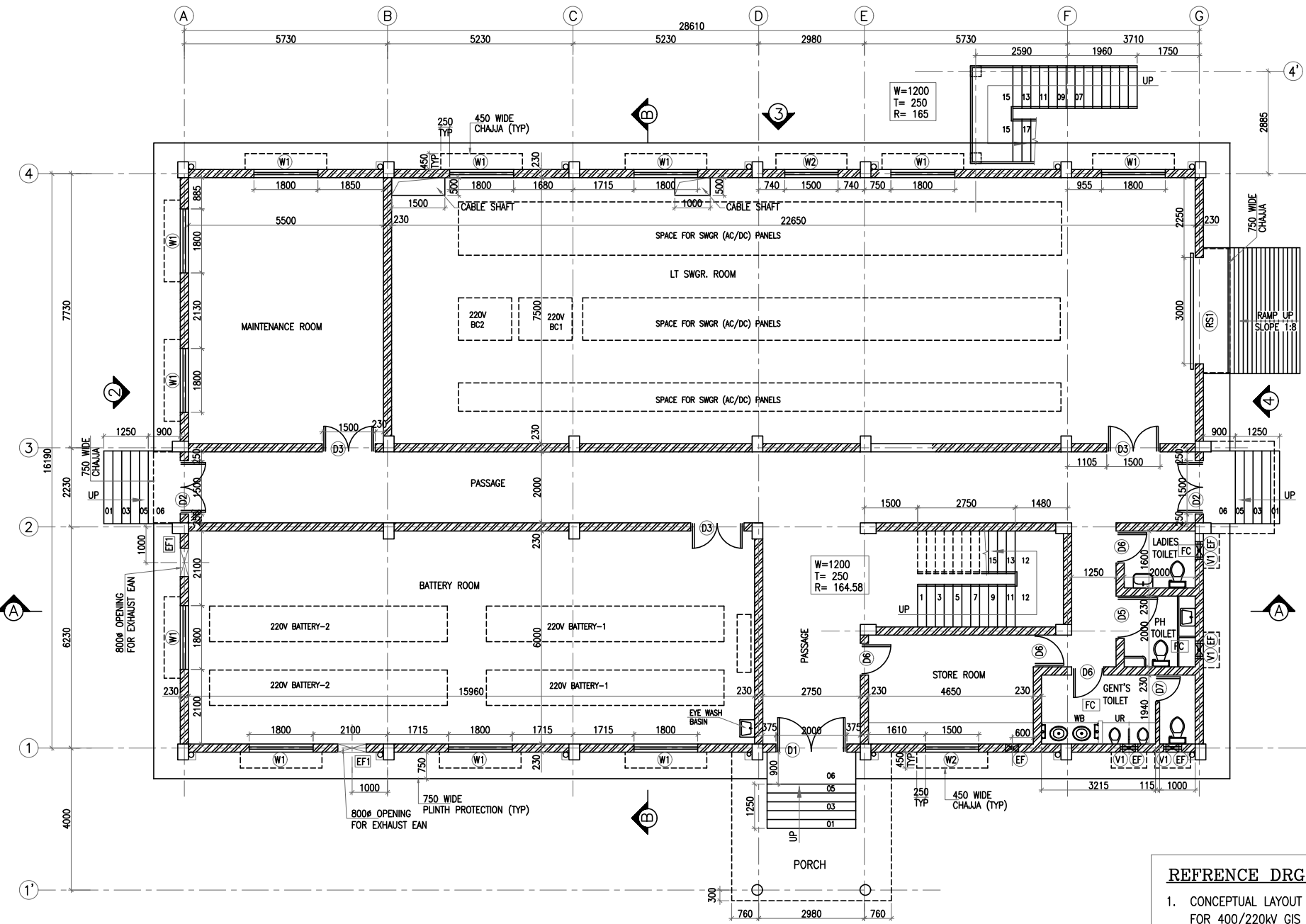

GROUND FLOOR PLAN

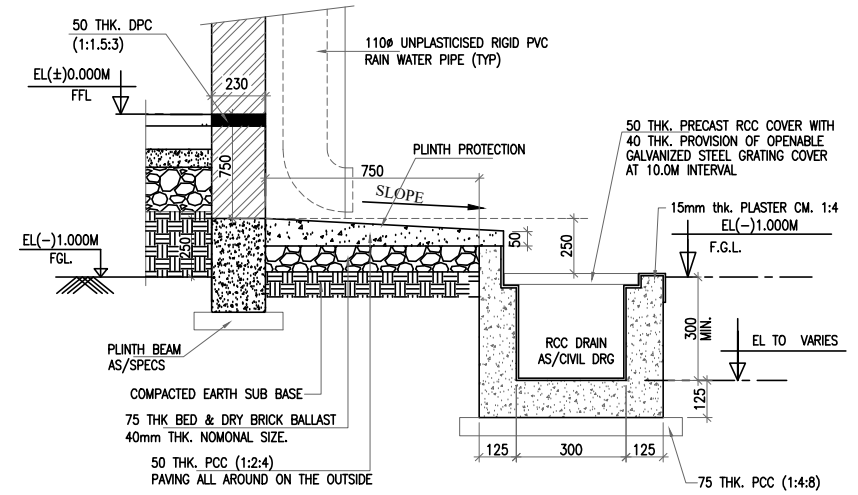

PLINTH PROTECTION ALONG BUILDING WITH DRAIN-TYPICAL

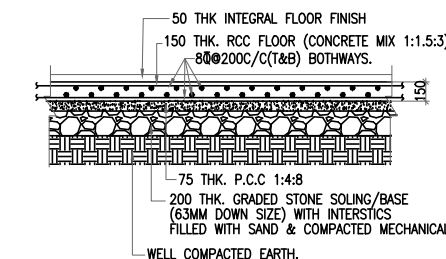

DETAIL OF GRADE SLAB

LEGEND:-

	SIDE HUNG OPENABLE PANEL
	FIXED GLASS PANEL
FFL	= FINISH FLOOR LEVEL
FGL	= FINISH GRADE LEVEL
H.P.	= HIGH POINT
L.P.	= LOWER POINT
E.F.	= EXHAUST FAN
E.L.	= ELEVATION LEVEL
T.O.C	= TOP OF CONCRETE
N.T.S	= NOT TO SCALE
TYP.	= TYPICAL
AC	= AIR CONDITIONED
FC	= FALSE CEILING
FF	= FALSE FLOOR

NOTES:-
 1 ALL DIMENSIONS ARE IN MILLIMETERS AND LEVELS ARE IN METERS UNLESS OTHERWISE SPECIFIED.
 2 ALL DOOR-WINDOW, ETC. HEIGHT SHALL BE CONSIDERED FROM FINISH FLOOR LEVEL.

REFRENE DRGS.
 1. CONCEPTUAL LAYOUT OF CONTROL ROOM BUILDING FOR 400/220KV GIS SUB STATION AT ERSAMA DRG. NO.: TB-3-420-316-002

PROJECT:	400/220kV GIS SUBSTATION AT ERSAMA, ODISHA & 400kV AIS FEEDER BAY EXTENSION AT DUBURI, ODISHA			
OWNER:	ODISHA POWER TRANSMISSION CORPORATION LIMITED			
 BHARAT HEAVY ELECTRICALS LTD. TRANSMISSION BUSINESS GROUP NOIDA	NAME	SIGN.	DATE	NO. OF VAR.
	DRN. RDA CIVIL	--sd--	01.05.2023	N.A.
	CHD. SV/AK	--sd--	02.05.2023	N.A.
APPD. PLK	--sd--	02.05.2023	N.A.	
DEPT. TBG CODE	UNTOL. DIMS. GR. 9/M/Y	SCALE N.T.S	WEIGHT (KG) N.A.	REF. TO ASSY. DRG. N.A.
TITLE	CONTROL ROOM BUILDING-GROUND FLOOR PLAN		DRG. NO. TB-1-420-607-700	REV. 01
SHT. No 01			NO. OF SHT. 04	

REV.	DATE	ALTERED	REV.	DATE	ALTERED	REV.	DATE	ALTERED	REV.	DATE	ALTERED
		CHD/APPD			CHD/APPD			CHD/APPD	01	05-06-23	RDA SV/AK
ZONE			ZONE			ZONE			ZONE		REVISED AS PER REVISED MECHANICAL DRAWING

THE INFORMATION ON THIS DOCUMENT IS THE PROPERTY OF BHARAT HEAVY ELECTRICALS LIMITED. IT MUST NOT BE USED DIRECTLY OR INDIRECTLY IN ANY WAY DETRIMENTAL TO THE INTEREST OF THE COMPANY

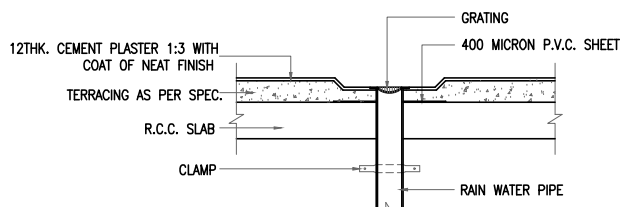

TYPICAL DETAIL OF KHURRA WITH RAIN WATER PIPE

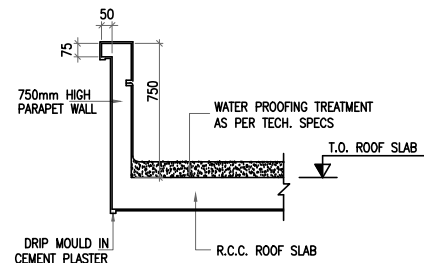

TYP. DETAIL OF PARAPET

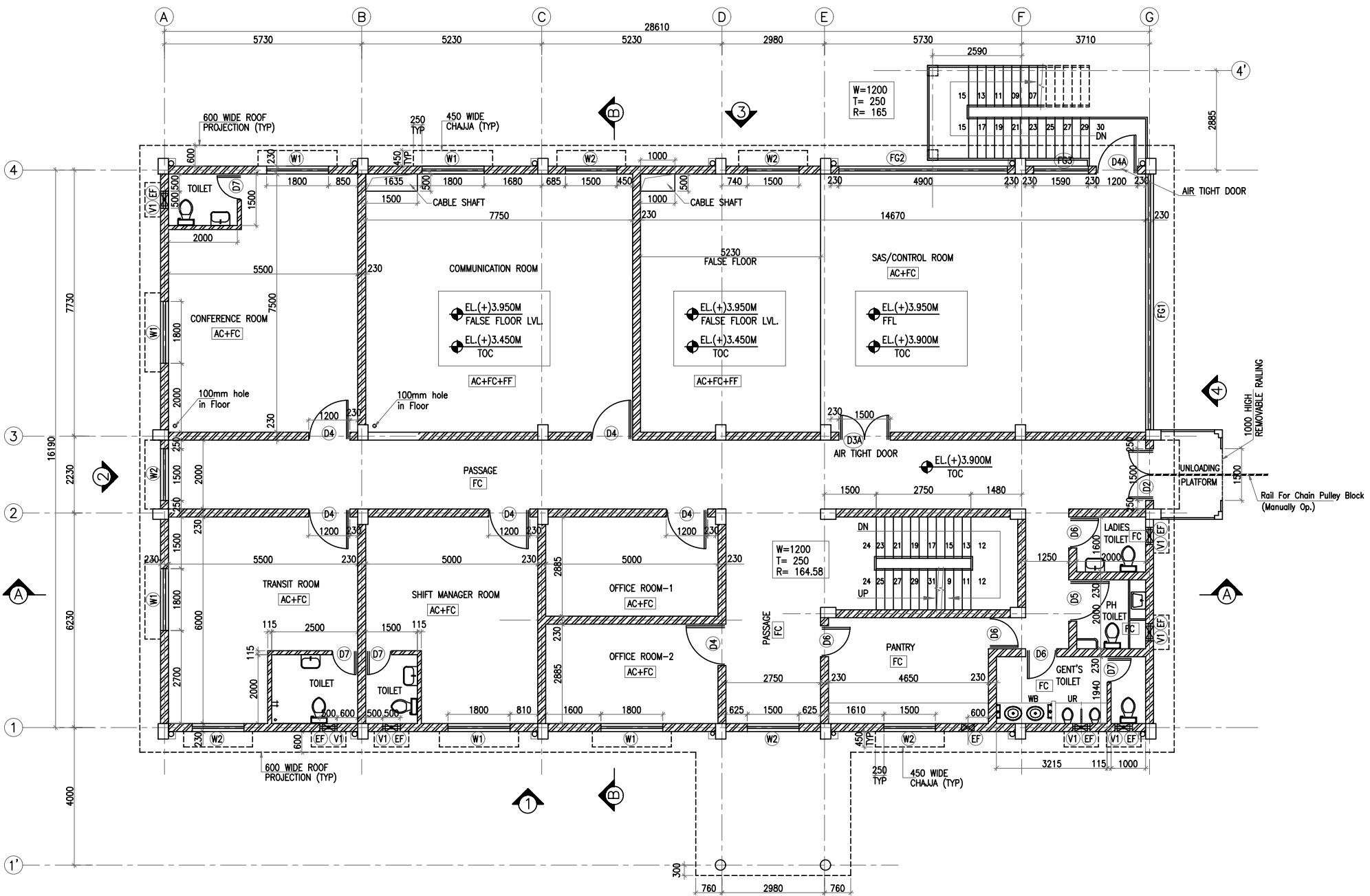

FIRST FLOOR PLAN

SCHEDULE OF FINISHES
(AS PER TECHNICAL SPECIFICATION)

- 1.0 BRICK WORK:
 - 1.1 230mm THK. BRICK MASONRY IN C.M. (1:5) USING FLY ASH BRICK AS PER OPTCL TS.
- 2.0 PLASTER:
 - 2.1 INTERNAL:
 - 12mm THK. PLASTER (1:6 CEMENT : SAND) MORTAR ON SMOOTH SIDE OF WALL.
 - 15mm THK. PLASTER (1:6 CEMENT : SAND) MORTAR ON ROUGH SIDE OF SINGLE OR HALF BRICK WALL.
 - 2.2 EXTERNAL:
 - 18mm THK. PLASTER IN TWO LAYER.
 - UNDER LAYER 12mm THK. (1:5 CEMENT : SAND) MORTAR AND TOP LAYER 6mm THK. (1:3 CEMENT : SAND) MORTAR
 - 2.3 CEILING EXCEPT WHERE FALSE CEILING WILL BE PROVIDED. 6mm THK. PLASTER (1:3 CEMENT : SAND)
- 3.0 FLOORING:
 - 3.1 OFFICE, PASSAGE, TRANSIT ROOM, CONFERENCE RM, SAS ROOM:- GLAZED VITRIFIED TILE FLOORING AS PER OPTCL TS.
 - 3.2 BATTERY ROOM:- ACID AND ALKALI RESISTANT TILES FLOORING. ACID AND ALKALI RESISTANT TILES UPTO 2100 HEIGHT AND ACID PROOF PAINT FOR BALANCE HEIGHT.
 - 3.3 LT SWITCH GEAR ROOM, MAINTENANCE ROOM, STORE ROOM:- CEMENT CONCRETE WITH METALLIC HARDENER TOPPING.
 - 3.4 SHIFT MANAGER ROOM, CHARGER ROOM, STORE ROOM:- VITRIFIED TILE FLOORING.
 - 3.5 TOILET, PANTRY:- CERAMIC TILES FLOORING AND DADO UPTO FALSE CEILING CERAMIC TILES.
 - 3.6 SKIRTING:- 150 HIGH SKIRTING MATCHING WITH THE FLOOR SHALL BE PROVIDED.
- 5.0 PAINTING.
 - 5.1 INSIDE FACES OF BRICK WALL WILL HAVE PLASTIC EMULSION/ACRYLIC EMULSION PAINT IN ALL AC AREA, DISTEMPER IN ALL OTHER AREA AND IN TOILET WILL HAVE ABOVE DADO WHITE WASH.
 - 5.2 OUTSIDE FACES OF WALL BE ACRYLIC SMOOTH EXTERIOR PAINT OVER PLASTER SURFACE.
 - 5.3 CEILING TO HAVE PLASTIC EMULSION PAINT, IN BATTERY ROOM HAVE ACID PROOF PAINT. FALSE CEILING IN PASSAGE AT FIRST FLOOR, CHARGER ROOM, TRANSIT ROOM, SAS ROOM, OFFICE ROOM, CONFERENCE ROOM, CHARGER ROOM, TOILET & PANTRY.

WATER PROOFING ON ROOF:

- CEMENT BASED WATER PROOFING TREATMENT OF ROOFS BALCONIES, TERRACES ETC SHALL BE PROVIDED WITH AVERAGE THICKNESS OF 120MM AND MINIMUM THICKNESS AT KHURRA AS 65 MM AND LAID CONSISTING OF FOLLOWING OPERATIONS:
- (A) A SLURRY COAT OF NEAT CEMENT USING 2.75 KG/SQM OF CEMENT ADMIXED WITH PROPRIETARY WATER PROOFING COMPOUNDS CONFORMING TO IS: 2645 SHALL BE APPLIED AND GROUDED OVER THE RCC SLAB INCLUDING CLEANING THE SURFACE BEFORE TREATMENT.
 - (B) PLAIN CEMENT CONCRETE 1:5:10 (1: CEMENT: 5 FINE SAND: 10 BURNT BRICK AGGREGATE OF 40 MM NOMINAL SIZE) ADMIXED WITH PROPRIETARY WATER PROOFING COMPOUND CONFORMING TO IS 2645 OVER 20 MM THICK LAYER OF CEMENT MORTAR OF MIN :5 (CEMENT 5 COARSE SAND) ADMIXED WITH PROPRIETARY WATER PROOFING COMPOUND CONFORMING TO IS: 2645 AND FINALLY THE SURFACE SHALL BE FINISHED WITH TROWEL WITH NEAT CEMENT SLURRY AND MAKING OF 300 X 300 MM SQUARE
 - (C) AFTER TWO DAY OF PROPER CURING A SECOND COAT OF CEMENT SLURRY ADMIXED WITH PROPRIETARY WATER PROOFING COMPOUND CONFORMING TO IS 2645 SHALL BE APPLIED.
 - (D) THE SURFACE SHALL BE FINISHED WITH 20 MM THICK JOINT LESS CEMENT MORTAR OF MIX 1:4 (1 CEMENT :4 COURSE SAND) ADMIXED WITH PROPRIETARY WATER PROOFING COMPOUND CONFORMING TO IS : 2645 AND FINALLY THE SURFACE SHALL BE FINISHED WITH TROWEL WITH NEAT CEMENT SLURRY AND MAKING OF 300 X 300 MM SQUARE
 - (E) THE WHOLE TERRACE SO FINISHED SHALL BE FLOODED WITH WATER FOR A MINIMUM PERIOD OF TWO WEEKS FOR CURING AND FOR FINAL TEST. ALL ABOVE OPERATIONS SHALL BE DONE IN ORDER AN AS DIRECTED AND SPECIFIED BY THE ENGINEER-IN CHARGE.

NOTES:-

- 1 ALL DIMENSIONS ARE IN MILLIMETERS AND LEVELS ARE IN METERS UNLESS OTHERWISE SPECIFIED.
- 2 ALL DOOR-WINDOW, ETC. HEIGHT SHALL BE CONSIDERED FROM FINISH FLOOR LEVEL.

PROJECT:	400/220kVGIS SUBSTION AT ERSAMA, ODISHA & 400kV AIS FEEDER BAY EXTENSION AT DUBURI, ODISHA
OWNER:	ODISHA POWER TRANSMISSION CORPORATION LIMITED

	BHARAT HEAVY ELECTRICALS LTD. TRANSMISSION BUSINESS GROUP NOIDA	NAME	RD/CIVIL	SIGN.	--sd--	DATE	01.05.2023	NO.OF VAR.
		CHD.	SV/AK		--sd--		02.05.2023	N.A.
		APPD.	PLK		--sd--		02.05.2023	N.A.

DEPT. TBG CODE	UNTOL. DIMS. GR. 9/M/Y	SCALE	N.T.S	WEIGHT (KG)	N.A.	REF. TO ASSY. DRG.	N.A.	ITEM NO.	N.A.	NO.OF ITEMS	N.A.
----------------	------------------------	-------	-------	-------------	------	--------------------	------	----------	------	-------------	------

TITLE	CONTROL ROOM BUILDING-FIRST FLOOR PLAN	DRG.NO.	TB-1-420-607-701	REV.	01
CARD CODE	NA	SHT. No	02	No. OF SHT.	04

REV.	DATE	ALTERED	REV.	DATE	ALTERED	REV.	DATE	ALTERED	REV.	DATE	ALTERED
		CHD/APPD			CHD/APPD			CHD/APPD			CHD/APPD
ZONE			ZONE			ZONE			ZONE		REVISD AS PER REVISED MECHANICAL DRAWING

THE INFORMATION ON THIS DOCUMENT IS THE PROPERTY OF BHARAT HEAVY ELECTRICALS LIMITED. IT MUST NOT BE USED DIRECTLY OR INDIRECTLY IN ANY WAY DETRIMENTAL TO THE INTEREST OF THE COMPANY

6 5 4 3 2 1

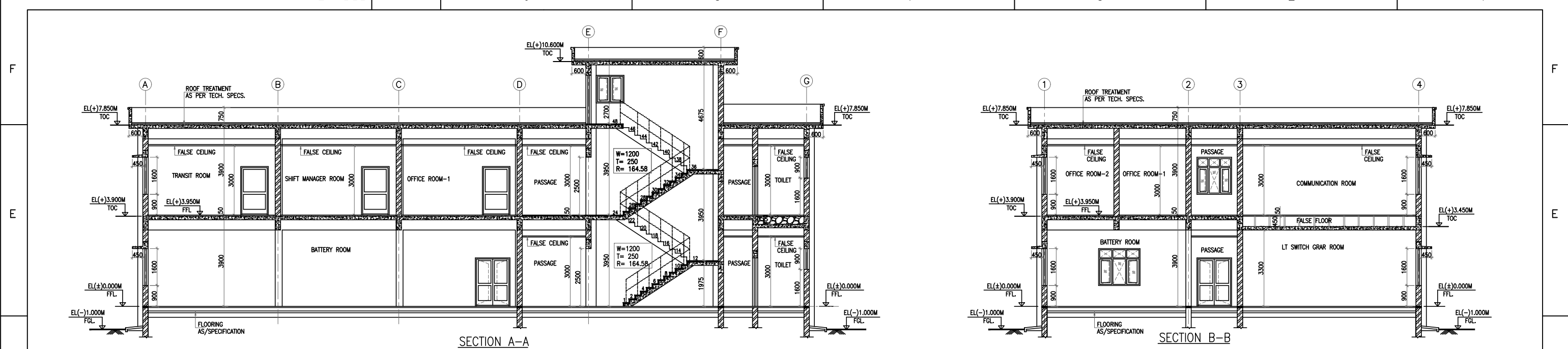

SECTION A-A SECTION B-B

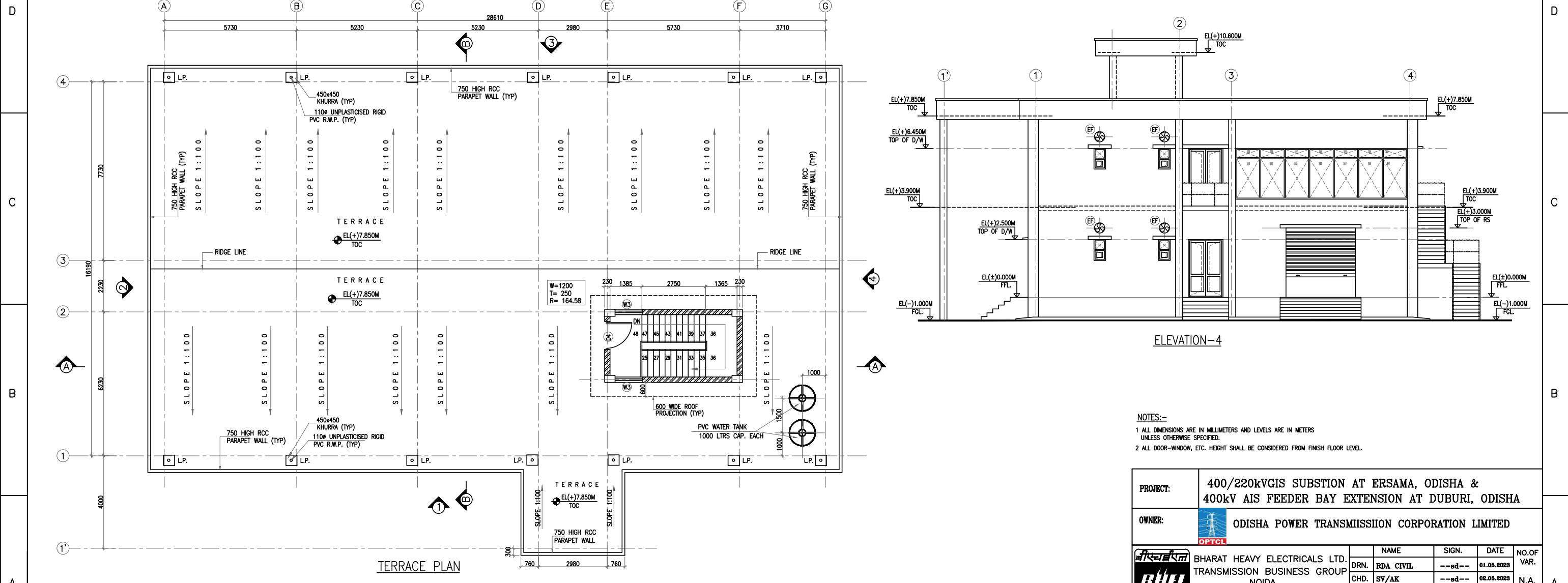

REV.	DATE	ALTERED	REV.	DATE	ALTERED	REV.	DATE	ALTERED	REV.	DATE	ALTERED	REV.	DATE	ALTERED
		CHD/APPD			CHD/APPD			CHD/APPD	01	05-06-23	CHD/APPD			SV/AK
ZONE			ZONE			ZONE			ZONE	REVISED AS PER	REVISED MECHANICAL DRAWING			

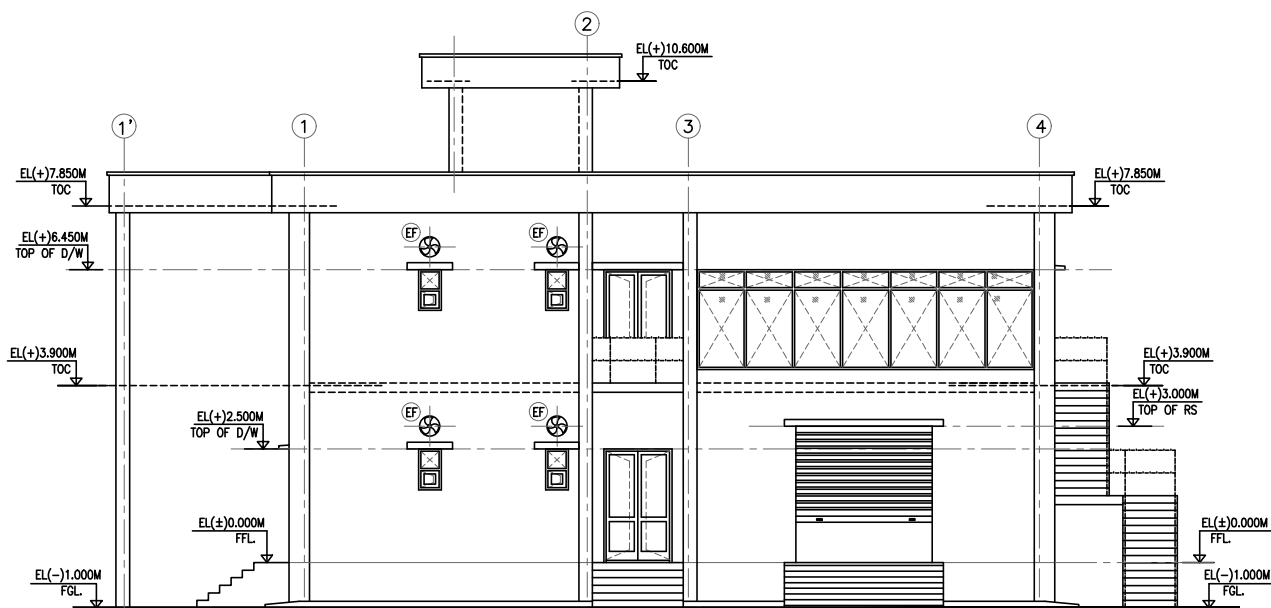

ELEVATION-4

- NOTES:-
 1 ALL DIMENSIONS ARE IN MILLIMETERS AND LEVELS ARE IN METERS UNLESS OTHERWISE SPECIFIED.
 2 ALL DOOR-WINDOW, ETC. HEIGHT SHALL BE CONSIDERED FROM FINISH FLOOR LEVEL.

PROJECT:		400/220kV GIS SUBSTATION AT ERSAMA, ODISHA & 400kV AIS FEEDER BAY EXTENSION AT DUBURI, ODISHA					
OWNER:		ODISHA POWER TRANSMISSION CORPORATION LIMITED					
BHTEL		BHARAT HEAVY ELECTRICALS LTD. TRANSMISSION BUSINESS GROUP NOIDA		NAME	SIGN.	DATE	NO. OF VAR.
DEPT. TBG CODE		DRN. RDA CIVIL	CHD. SV/AK	APPD. PLK	--sd--	01.05.2023	N.A.
UNTO. DIMS. GR. 9/M/Y	SCALE N.T.S	WEIGHT (KG) N.A.	REF. TO ASSY. DRG. N.A.	ITEM NO. N.A.	NO. OF ITEMS N.A.		
TITLE		CONTROL ROOM BUILDING-TERRACE PLAN & SECTIONS		DRG. NO. TB-1-420-607-702	REV. 01		
CARD CODE NA		SHT. No 03		NO. OF SHT. 04			

THE INFORMATION ON THIS DOCUMENT IS THE PROPERTY OF BHARAT HEAVY ELECTRICALS LIMITED. IT MUST NOT BE USED DIRECTLY OR INDIRECTLY IN ANY WAY DETRIMENTAL TO THE INTEREST OF THE COMPANY



ELEVATION-1

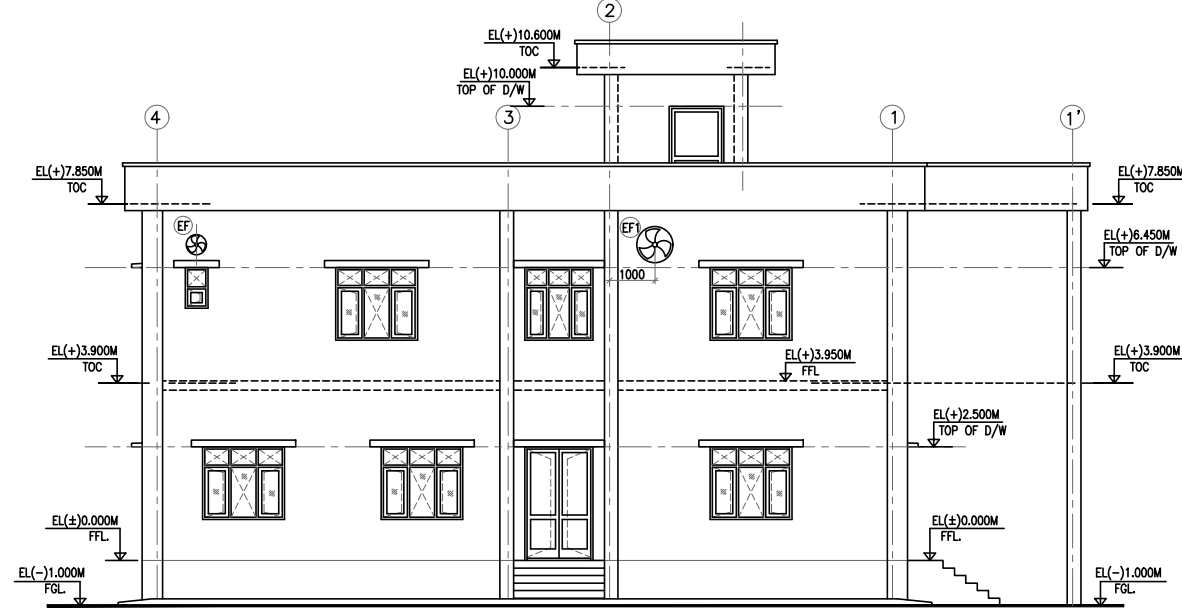

ELEVATION-2

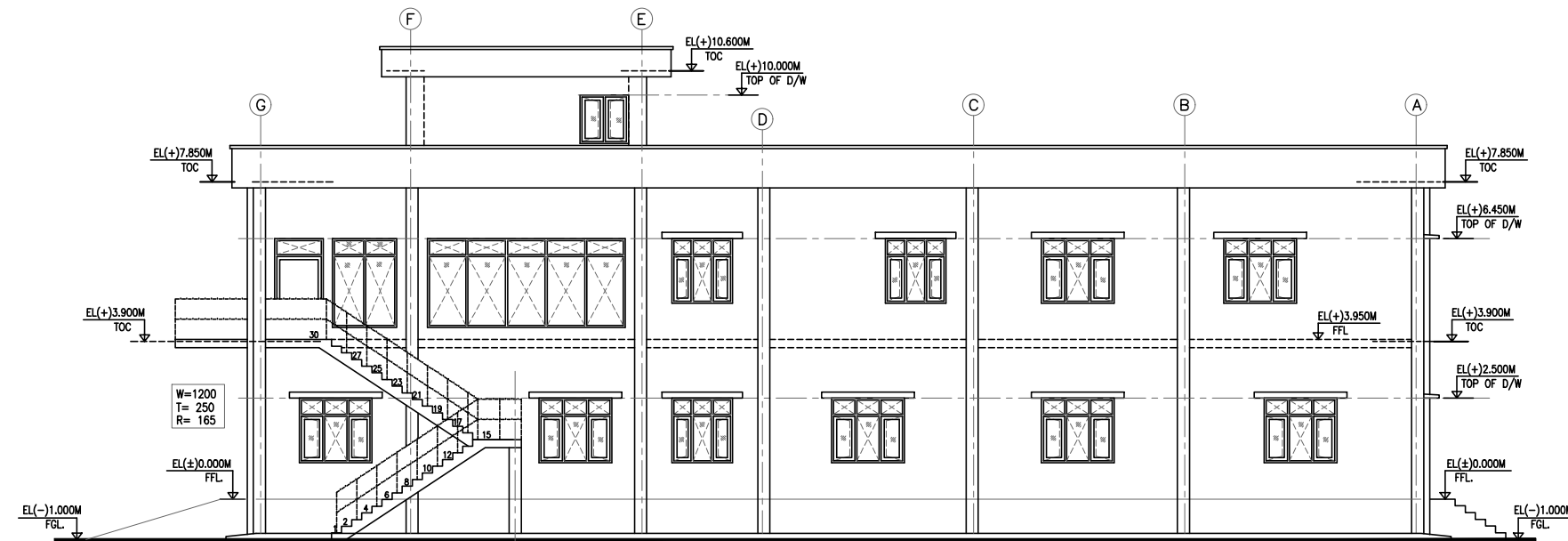



ELEVATION-3

- NOTES:-
- 1 ALL DIMENSIONS ARE IN MILLIMETERS AND LEVELS ARE IN METERS UNLESS OTHERWISE SPECIFIED.
 - 2 ALL DOOR-WINDOW, ETC. HEIGHT SHALL BE CONSIDERED FROM FINISH FLOOR LEVEL.

PROJECT: 400/220kV GIS SUBSTATION AT ERSAMA, ODISHA & 400kV AIS FEEDER BAY EXTENSION AT DUBURI, ODISHA

OWNER:  ODISHA POWER TRANSMISSION CORPORATION LIMITED

	BHARAT HEAVY ELECTRICALS LTD. TRANSMISSION BUSINESS GROUP NOIDA		NAME	SIGN.	DATE	NO. OF VAR.
	DRN.	RDA CIVIL	--sd--	01.05.2023		N.A.
	CHD.	SV/AK	--sd--	02.05.2023		N.A.
	APPD.	PLK	--sd--	02.05.2023		N.A.

DEPT. TBG CODE	UNTOL. DIMS. GR. 9/M/Y		SCALE N.T.S	WEIGHT (KG) N.A.	REF. TO ASSY. DRG. N.A.	ITEM NO. N.A.	NO. OF ITEMS N.A.
----------------	------------------------	---	-------------	------------------	-------------------------	---------------	-------------------

TITLE: CONTROL ROOM BUILDING-ELEVATIONS

DRG. NO. TB-1-420-607-703

REV. 01

REV.	DATE	ALTERED	REV.	DATE	ALTERED	REV.	DATE	ALTERED	REV.	DATE	ALTERED
		CHD/APPD			CHD/APPD			CHD/APPD	01	05-06-23	RDA SV/AK
ZONE			ZONE			ZONE			ZONE		REVISED AS PER REVISED MECHANICAL DRAWING

THE INFORMATION ON THIS DOCUMENT IS THE PROPERTY OF BHARAT HEAVY ELECTRICALS LIMITED. IT MUST NOT BE USED DIRECTLY OR INDIRECTLY IN ANY WAY DETRIMENTAL TO THE INTEREST OF THE COMPANY

Bharat Heavy Electricals Limited

Project: 400/220 kV GIS SUB STATION AT ERSAMA, PARADEEP, ODISHA

Technical Specification: 48V FLOAT CUM BOOST BATTERY CHARGER

Doc No. TB-420A-316-025B Rev 00

Contents

SECTION 2:

EQUIPMENT SPECIFICATION UNDER SCOPE OF SUPPLIES/
SERVICE

1. CUSTOMER TECHNICAL SPECIFICATION



ODISHA POWER TRANSMISSION CORPORATION LIMITED
JANPATH, BHUBANESWAR – 751022

SECTION – IV

TECHNICAL SPECIFICATION

FOR

SMPS BASED BATTERY CHARGERS

50 VOLT BATTERY CHARGER
(SUITABLE FOR 48V MF-VRLA
BATTERY)

125 Amp-



PART -- A
TECHNICAL SPECIFICATION

50 VOLT SMPS BASED BATTERY CHARGER

A 1 0 **SCOPE:-**

- A 1 1 This specification covers the design, manufacture, assembly, shop testing at manufacturer's works before dispatch, supply and delivery at site, erection, testing and commissioning of 50 volt 125A SMPS based float cum boost chargers.
- A.1.2 Comprehensive AMC of the said commissioned Chargers for a period of 5 years beyond successful completion of guarantee period.
- A 1 2 It is the intention of the purchaser to install the most up to date type of equipment conforming to modern practices
- A.1.3. The scope of supply shall include all parts and accessories etc, which are usual and necessary for erection, operation and maintenance of SMPS based chargers as specified above, though not individually and specifically stated or enumerated.**

A.2.0 **STANDARDS:-**

- A.2.1 All equipment and their accessories covered by this specification shall be designed, manufactured and tested in compliance with the latest relevant standards, published by the Bureau of Indian Standards including those, listed at Clause 2.6 in order that specific aspects under Indian climatic conditions are taken care of.
- A 2.2 The equipment and accessories for which Indian Standards are not available shall be designed, manufactured and tested in accordance with the latest standards, published by any other recognized National Standards Institution and latest publication of International Electro Technical commission [IEC].
- A2.3. The equipment manufactured according to any other authoritative national / international standard, which ensures an equal or better quality than the provisions of these specifications shall also be acceptable. Where the equipment, offered conform to any other standard, salient points of differences between the proposed standard and the provisions of these specification shall be clearly brought out in the tender. A copy of such standards [in English] shall be enclosed with the offer.**
- A.2.4 The equipment shall conform to the Indian Electricity Rules, 1956 with latest amendments as regards safety earthing and other essential provisions specified therein for installation and operation of electrical plants.
- A.2.5. All equipment shall also comply with the statutory requirements of the Government of Orissa where the equipment will be installed. Nothing shall be construed to relieve the supplier of his responsibility.**



A.2.6. GOVERNING SPECIFICATION:-

The MF-VRLA batteries and the associated chargers shall unless otherwise specified, conform to the following standards. The firms are requested to furnish the following specifications for our further reference.

i	IS-1651/1991	Specification for stationary cells batteries, leads acid type
ii	IS 1885 [Part-8] / 1986	Electro technical vocabulary: Part- 8-Secondary cells & batteries
iii	IS-266/1977	Sulphuric acid
iv	BS-46290 (Part-4) / 1997	British standard specification for lead acid type valve regulated sealed type batteries.
v	ANSI IEEE STD 450/1987	IEEE recommended practice for maintenance, testing and replacement of large lead storage batteries for generating stations
vi	IEC 896-2/1995	Stationary lead-acid batteries, general requirements and methods of test (part-2, valve regulated types)
vii	IS-(1146 / UI-94) / ASTM - d -29863	Plastic container for lead acid storage batteries
viii	IS-3136-1965	Specification for polycrystalline semiconductor rectifier equipment
ix	IS-1248-1968	Specification for direct acting indicating analogue electrical measuring instruments and tier accessories (Part - I)-1983-General Requirements (Part - II)- 1983 - Ammeters & voltmeters. (Part-III)-1984-Accessories.
x	IS-2208-1962	Specification of HRC Cartridge fuse link up to 650V
xi	IS 2959-1966	Specification of contractors for voltages not exceeding 1000V AC or 1200V DC
xii	IS-3395-1966	Specification for monocrystalline semiconductor rectified cells and stacks.
xiii	IS-4540-1968	Monocrystalline semiconductor rectifier assemblies & equipment
xiv	IS-2147/1962	Degree of protection provided by enclosure for low voltage switchgear and control gear
xv	IS-5578/1984	Guide for marking of insulated conductors
xvi	IS-8623/1993 [Part 1 to 3]	Low voltage switchgear and control gear assemblies.
xvii	IS-11171/1985	Dry type power transformers.
xviii	IS-11353-1985	Guide for uniform system of marking and identification of conductors and apparatus
xix	IS-13947-1993 (Part 1 to 5)	Low voltage switchgear and control gear

A.3.0. OTHER REQUIREMENTS:-

A.3.1 ACCESSIBILITY AND INTER CHANGEABILITY:-

CHARGER: All working parts, in so far as possible, shall be arranged for convenience of operation, inspection, lubrication and ease of replacement with minimum down time. All like parts of the equipment, furnished shall be inter changeable



A.3.2. QUALITY AND WORKMANSHIP:-

Workmanship and materials shall be of good commercial quality, suitable for the purpose, intended and in accordance with the highest standards and practices for equipment of the class, covered by this specification.

A.3.3. SAFETY

A3.3.1. All equipment shall be complete with approved safety devices wherever a potential hazard to personnel exists and with provision for safe access of personnel to and around the equipment for operational and maintenance functions. The design shall include all necessary precautions and provisions for the safety of operating and maintenance personnel.

A3.3.2. Special care shall be taken to make enclosed equipment proof against entry of rats, lizards and other creeping reptiles, which may create electrical short circuits inside. live equipment

A.3.3.3. Continuity of power supply is the first consideration and the design shall be such as to provide facilities to simplify inspection, testing maintenance, clearing and repair at site.

A.3.4. SPECIAL SITE CONDITIONS:-

A.3.4.4. The equipment with their accessories shall be designed for smooth, efficient and trouble free operation in tropical humid climate for maximum temperature of 50 degree C and maximum humidity of 98 percent. Maximum temperature and maximum humidity are however not likely to occur simultaneously. De-rating of equipment shall be done for an ambient temperature of 50 degree C.

A.3.5. PAINTING:-

All items of equipment and materials shall be thoroughly cleaned and painted in accordance with IS Specification. The clean surface shall be given two coats of epoxy polyamide resin based red-oxide zinc-phosphate primer, deposited either by immersion or powder spray. The phosphate coated surface shall have one coat of high build epoxy resin based intermediate paint coating and two coats of air drying epoxy polyamide enamel suitably pigmented finish paint. The colour shade for exterior parts of equipment located inside the sub-station control room building shall be as per shade No. 631. Clean and touch-up paint shall be applied at site as required.



PART-B

TECHNICAL SPECIFICATION FOR 50V- 125 Amp SMPS BASED AUTOMATIC FLOAT-CUM-BOOST CHARGERS SUITABLE FOR 48V MF-VRLA BATTERIES.

1. SCOPE:

This specification covers the design, manufacture testing before dispatch, delivery at site and erection, testing & commissioning at site of 50V Automatic Float-cum- Boost Charger of different capacities and comprehensive AMC thereof for 5(Five) years beyond successful completion of guarantee period

2. BASIC REQUIREMENT:

- 2.1 The charger shall preferably be modular type based on high frequency switching mode power supply(SMPS) technique using IGBT devices and the front mounted SMPS modules should be hot swappable.
- 2.2 The float -cum- boost charger shall be suitable for charging 48V battery in addition to trickle charging and feeding power to communication equipment whenever AC mains supply is available to the charger
- 2.3 In spite of the fluctuations in the voltage and the frequency variation of mains supply to the charger, there must be line regulated DC output voltage for feeding the communication equipment load. The DC output voltage shall also be load regulated.
- 2.4 In the event of mains supply failure, the batteries shall supply total load current as long as the battery is not discharged below 40V. A Low Voltage Disconnecter (LVD) should protect the battery from deep discharge. On restoration of main supply the float-cum-boost charger shall resume its normal function of charging the battery as well as feeding communication equipment load automatically
- 2.5 Depending on the status of battery i.e voltage per cell and previous discharge history there shall be need for automatic switching between float and boost charging. Separate outputs for battery and equipment should be available, otherwise dropping diode technique may be used to prevent boost voltage appearing across the load.
- 2.6 Digital Control: charger should employ digital control with DSP controller for providing predictive control of rectification & monitoring capability. The charger should have a multi line dot matrix display of suitable size on front panel to indicate control status and event log
- 2.7 The side and top panels of the equipments should be designed in such a way to allow sufficient ventilation for the components. The ON – OFF switch, input and output fuses, indication lamps, voltmeters, ammeters, filters, condensers, output voltage



control are to be provided on the front panel. Cable entry holes shall be provided at the bottom with suitable clamping arrangements

COMPONENTS:

- 2 8 Components used shall be of professional grade of reputed manufacturer. Iron and ferrite core transformer and chokes if used shall be wound with copper with adequate insulation provided
- 2 9 **The positive output of SMPS units must be connected to common ground.** Circuit breakers, output fuse, ammeter shunt etc should be provided on the negative path of the output. Sensing circuit, fuses or circuit breakers shall be provided wherever appropriate to protect the charger
- 2 10 Suitable mechanical front loading rack arrangement for holding modules in position shall be provided so that the modules are held firmly by sliding through it.
- 2 11 **Efficient earthing of the Charger shall be provided, taking care that in communication system 48V DC positive is always connected to earth.**

PROTECTION:

- 2 12 Protection circuit should be provided for the following cases
- i) Under voltage / Over voltage for both input and output
 - ii) Over load / short circuit.
 - iii) Battery earth Fault
 - iv) SMPS Unit failure.
 - v) Wrong battery connection/reverse polarity
 - vi) Power ON self test
 - vii) Supply wrong phase, phase failure.

VISUAL INDICATION:

- 2.13. Visual indication such as LED, Dot matrix LCD etc. shall be provided to indicate:
- (a) Mains available
 - (b) Phase failure / wrong phase
 - (c) Charge/ Discharge
 - (d) Charger over load



- (e) Float mode/ Boost mode
- (f) Output fail
- (g) Battery Low.

ALARM FACILITIES:

- 2.14. The equipment shall be provided with audio alarm facility for all the conditions as mentioned in 2.12 with suitable resetting facilities. The audio alarm in respect of the above conditions should automatically reset itself after a lapse of 30 seconds. The visual indication should persist till the fault is cleared. Potential free contact shall be provided for extension of alarm for centralised display.

COMPONENT MARKING:

- 2.15. Each electrical component should be located on the PCB by the layout / circuit diagram. The wiring shall be clearly and permanently identified with a designation or a colour code which must correspond to the equipment circuit diagram.

2.16. CABINET

- Free standing steel cabinet 1.6/2 0
Or above gauge sheet steel Degree of protection not less than IP42

NAME PLATE:

- 2.17. A name plate etched, engraved, anodized or any other better arrangement ensuring better life expectancy shall be suitably fixed on the cabinet of the charger and should contain following information.

- a) Specification No
- b) Type of the unit
- c) Manufacturers name
- d) Model No.
- e) Serial No.
- f) Input voltage and phase
- g) Output voltage and current
- h) Year of manufacture

HEAT – RUN:

- 2.18. All units shall be subjected to heat run test of 12hours at full load and temperature of component shall not be more than as mentioned below.

- a) Transformers and chokes - 70°C
- b) Transistors / diodes /FETs - 60°C or as per component spec.

INSULATION RESISTANCE:

- 2.19. The insulation resistance of the charger when tested with a 500V DC megger shall be as given below.

- a) AC input and earth - Greater than 2 Meg. Ohms.
- b) DC output and earth - Greater than 1 Meg Ohms

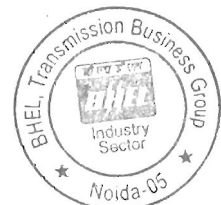

- c) AC input and DC output - Greater than 5 Meg ohm

LIGHTNING PROTECTION:

- 2.20 The system shall be adequately protected against lightning at the input.

RADIO FREQUENCY INTERFERENCE SUPPRESSION:

- 2.21 The equipment should be designed to minimize the level of electromagnetic interference both conductor and radiator detected in the vicinity of the equipment and generated by switch mode power conversion equipment inside the charger

TOTAL VOLTAGE HARMONIC DISTORTION:

- 2.22 The total line harmonic voltage distortion shall not be more than 10%.

TOTAL CURRENT HARMONIC DISTORTION:

- 2.23 The total current harmonic distortion contributed by the unit shall not exceed 20% for all input condition and load 50% to 100% of the rated capacity.

MANDATORY SET OF SPARES:

- 2.24 The suppliers shall provide the following mandatory spares for each of Charger supplied.

(a)	AC Contactor (if used in the charger)	-	1 no./ charger
(b)	DC Contactor (if used in the charger)	-	1 no./ charger
(c)	Required HRC Fuses of appropriate rating.	-	4 nos./ charger

INSTRUCTION AND MAINTENANCE MANUAL:

- 2.25 Two copies of the instruction manual shall be supplied along with each unit. The manual has to include dimensioned layout drawings, detailed circuit and schematic diagrams, PCB layout and detailed inter connecting drawings of modules and switching arrangements, Details on testing and adjustment procedure, initial check on receipt at site, detailed installation and commissioning procedure, maintenance procedure, proposed routine maintenance tests, actual test results obtained for the particular unit at the factory

- 2.26 detailed trouble shooting chart shall be outlined in the manual

Instruction manual is to be prepared using good quality paper. All drawings in Clear printing shall be attached to the manual along with the flow chart drawing necessary for trouble shooting



2.27. The bidder shall arrange for training of at least five Telecom. Engineering personnel of OPTCL on operation & maintenance of 50 V Float-Cum-Boost chargers free of cost. Every details regarding repair of all probable defects need be imparted to the trainee engineers at works of the manufacturer. The bidder in their offer need intimate the duration of training. However the training must be conducted prior to delivery of the Battery chargers.

TYPE TEST

2.28 The bidder shall submit the test reports along with his offer for the following type tests conducted on the offered samples as per relevant National Standard (s) within five years from the date of opening of the bid and test-witnessed by any Government Department /Government undertaking, failing which the offer is liable for rejection

- (a) Measurement of Power loss/ consumption in rectifier auxiliaries
- (b) Equipment reactance test
- (c) Measurement of voltage regulation / AVR regulation
- (d) Efficiency and power factor measurement test
- (e) Temperature rise test so as to determine the temperature rise of Semiconductor, Ferrite cores and cabinet etc.
- (f) Measurement of insulation resistance.
 - (i) AC input to earth.
 - (ii) AC input to DC output.
 - (iii) DC output to earth
- (g) DC voltage current characteristic
- (h) High Voltage Tests.
- (I) Determination of regulation
- (J) Measurement of ripple
- (k) Reverse leakage test
- (l). Test for confirmation of reduction in float voltage with increase of battery temperature and vice-versa



The bid offers in confirmation to the above tests as well as the tests certified by Telecom RDSO center and followed by REL-TEL shall be given due weight age.

ACCEPTANCE TESTS.

2 29 Followings shall constitute the acceptance tests which shall be tested by the purchaser's representative at the works of the manufacturer at the cost of the supplier for each charger. No sampling is allowed.

- (a) Measurement of voltage regulation
- (b) Efficiency and power factor measurement
- (c) Temperature rise test so as to determine the temperature rise of Semiconductor capacitor choke. Ferrite cores and cabinet etc.
- (d) Measurement of insulation resistance.
 - (I) AC input to earth
 - (ii) AC input to DC output
 - (iii) DC output to earth
- (e) DC voltage current characteristic
- (f) High voltage tests.
- (g) Determination of regulation.
- (h) Measurement of ripple
- (I) Tests for indications and alarms as per this specification
- (j) Tests for indicating instruments.
- (k) Determination of system set points.
- (I) Soft start test

N.B. The supplier shall provide arrangements for monitoring the temperature across the elements, as stipulated above, continuously during the temperature rise test without disconnection of any of the temperature measuring devices across the hottest spot of each of the above elements.



All other tests, as may be necessary to ensure that all equipments are satisfactory shall also be carried out. In addition to the above tests, manufacturer's test certificates, vendor's test certificates for different equipments accessories, instruments etc. shall be submitted, whenever required by the purchaser

DRAWINGS / DOCUMENTS

2.30 The bidders shall submit the following drawings / documents along with their offer failing which the offer is liable for rejection.

- (a) OGA of the battery chargers
- (b) General layout with overall dimensions
- (c) Electrical schematic diagram showing connections and controls
- (d) Leaflets and technical literature giving detailed information of the panels offered

The bidder shall submit the following drawings / documents in 3 (three) copies within 15 (fifteen) days from the date of issue of the purchase order for purchaser's approval.

- (a) OGA of the battery chargers
- (b) General layout with overall dimensions marked along with sectional views showing cable entry position etc
- (c) Rating calculations for power semiconductors, torridly transformers capacitors inductors etc
- (d) Detailed schematic and connection and control wiring diagram for all the equipments
- (e) Complete bill of materials
- (f) Technical excerpts on operation.

GUARANTEED TECHNICAL PARTICULARS

2.31 The guaranteed technical particulars of this specification shall be furnished along with the tender. Any tender, lacking complete information in this respect is likely to be rejected

DEVIATION FROM SPECIFICATION

2.32 All deviations from the specification shall be separately listed in the technical deviation sheet (As per Annexure-XIIB), in the absence of which it will be presumed that the provisions of these specifications are complied with by the tenderer. Any extra feature/equipment/ instrument as necessary for operation and performance of the



battery charger for the 48V MF-VRLA batter set as per this specification shall be provided without any extra cost to OPTCL. The **extent of up gradation facility shall be mentioned.**

TRANSPORT :

- 2.33 The chargers along with its accessories shall be suitably packed and transported to site in ready to use condition.

3. **BRIEF TECHNICAL SPECIFICATION:**

The required capacity of chargers may be 50V-150A/125A/100A/75A/50A/50A Chargers of 75 Amp. Rating and above shall be of 3 phase type

Charging Curve: Completely programmable .Can support batteries of any type, voltage, capacity.

- a) Input Voltage - 230 \pm 20% VAC single phase in case of 25A, 40A and 50A charger 30%
400 \pm 20% VAC three phase in case of 60A, 75A, 125A and 160A charger 30%

Frequency – 50Hz \pm 5%

Power factor – Single phase model- > 0.90 at full load

Three phase models >0.97 at full load .

Voltage withstand test – 1500V AC input to chassis for 1 minute.

- b) Float mode – Adjustable 48V – 52 V Trickle charging of battery and simultaneously supplying the load.

Boost mode – Adjustable 48V – 65V

Boost charging of battery and simultaneously supplying the load after suitable voltage dropping arrangement.

Static Regulation – Line \pm 0.5%

Load \pm 0.5%

Dynamic Regulation \pm 0.5% for 10% - 90% - 10% stop load change.

\pm 1 % within 1 m sec. Of stop change.

\pm 1 % for \pm 25% stop change in AC input voltage.

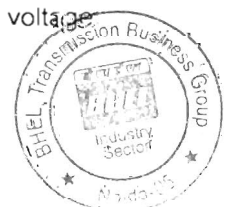

Phosphometric noise (emf weighted at 800 Hz)

< 2mV rms while delivering full rated load at normal input.

Out Ripple:- Less than 1% RMS at full load

EFFICIENCY:

a) Single Phase AC

i) At normal input, output and full rated load - Better than 85%.

ii) For other specified input output condition and load between 25% to 100% : - Better than 80%.

b) Three Phase AC

i) At normal input, output and full rated load - Better than 90%

ii) For other specified input, output conditions
and load between 25% to 100% - Better than 85%.



**GUARANTEED TECHNICAL PARTICULARS FOR
BATTERY CHARGER (48V D.C. SYSTEM) SUITABLE
FOR SPECIFIED MF-VRLA TYPE STORAGE BATTERY**

(To be filled in by the Bidder)

Values/ Others

1. MANUFACTURER'S NAME
2. RATED OUTPUT OF THE CHARGER
 - 2.1 Voltage (volts)
 - 2.2 Current (amps)
 - 2.3 Power factor
3. SHORT TIME RATING
4. TYPE OF COOLING
5. HOTTEST STACK TEMPERATURE (°C)
6. CHARGER DIMENSIONS
 - (a) Height (mm)
 - (b) Depth (mm)
 - (c) Width (mm)
 - (d) Sheet thickness (mm)
7. CHARGER WEIGHT
8. CHARGER RATED OUTPUT CURRENT
 - (a) Float charging mode
 - (b) Boost charging mode :
9. LOAD LIMITER CURRENT SETTING RANGE (Trickle mode)
10. AUTOMATIC VOLTAGE REGULATOR MODULE
 - 10.1 manufacturer's name
 - 10.2 Manufacturer's type
 - 10.3 Percentage stabilization of the rectifier with the help of AVR when

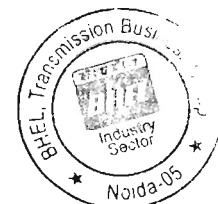

- (a) Input voltage changes with \pm of its nominal value.
- (b) DC output of the rectifier varies from no-load to full load.

- 11.4 Rated output voltage
- 11.5 Allowable AC frequency fluctuations
- 10.6 Voltage setting range
- 10.7 Response time of automatic voltage regulator
- 11.0 CONTACTORS / MOULDED CASE CIRCUIT BREAKERS
- 11.1 Type
- 11.2 Make
- 11.3 Rated voltage (V)
- 11.4 Rated continuous currents (A)
- 11.5 Contact material
- 11.6 Operating coil
- 11.7.1 Voltage (V)
- 11.7.2 Voltage range and power for closing and holding
- 11.7.3 Voltage range and power for drop off.
- 11.8 Details of CT if any
- 11.9 Auxiliary contacts.
- 11.9.1 Number
- 11.9.2 Current rating
- 11.10 Characteristics of back-up HRC fuse.

12.0 RELAYS :

- 12.1 Make and type of protective and alarm relays
 - (a) Thermal overload relay
 - (b) Input under voltage relay
- (a) Single phasing alarm relay
- (b) Phase reversal relay
- (c) D.C. output over-voltage relay
- (d) D.C. output under voltage relay
- (e) Charger failure relay
- (f) Battery earth fault relay
- (g) A.C. input failure relay (for connecting the D.C. load)
- (h) Fuse failure relay
- (i) Alarm accept relay

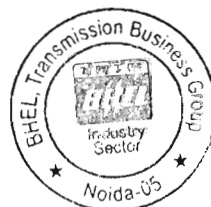

- 12.2 Rated voltage of each of the above
 - (a) AC/DC
 - (b) Permissible variation
 - (c) Frequency
- 12.3 VA burden of each of the above
- 12.4 Operating time of each of the above
- 12.5 Reset time
- 12.6 Accuracy
- 12.7 Setting range
- 12.8 Reset factor
- 12.9 Number of contacts
 - a. Normally open
 - b. Normally closed
- 12.10 Rating of contacts
 - (a) Rated Voltage (V)
 - (b) Rated making and breaking
 - (c) Continuous rating
- 12.11 Operation indicator
- 13. INDICATING LAMPS/ LCD DISPLAY**
- 13.1 Manufacturer's name
- 13.2 Type and designation
- 13.3 Permissible voltage variation
- 13.4 Rated power consumption (watts).
- 13.5 Series resistance, if any
- 14. SWITCHES:**
- 14.1 Manufacturer's name
- 14.2 Ratings
 - (a) Continuous current
 - (b) Short circuit – making capacity
 - (c) Breaking capacity
 - (d) Voltage
- 14.3 Operating mechanism details
- 14.4 Type of visual indication
 - (a) OFF and ON position
 - (b) Fuse blow out



15.0 FUSES/Circuit breaker

- (a) Make
- (b) Type
- (c) Rating (Amps)
- (d) Interrupting rating (KA)

16. INSTRUMENTS**16.1 Manufacturer's Name**

- (a) Ammeter
- (b) Voltmeter

16.2 Type

- (a) Ammeter
- (b) Voltmeter

16.3 Standard

- (a) Ammeter
- (b) Voltmeter

16.4 Scale range**16.4.1 Ammeter**

- (a) Float charger
- (b) Boost charger
- (c) Battery float
- (d) Battery boost

16.4.2 Volt meter

- (a) Input supply
- (b) Charger output
- (c) Load

16.5 Size of dial

- (a) Volt meter
- (b) Ammeter

16.6 Accuracy class

- (a) Volt meter
- (b) Ammeter

16.7 Temperature at which calibrated**16.8 Limit of errors****16.9 Out line dimensions****16.10 Type of mounting****16.11 Selector switch for volt meter (AC & DC)**

- (j) Make
- (k) Rating

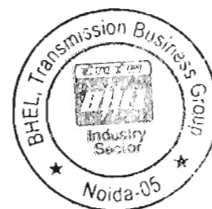
17 Reference float voltage at ambient temperature of 27°C

000686

18. Whether protection is given for float voltage to Avoid low battery voltage due to sensor or circuit Malfunction. (Yes/ No)
19. Whether the positive output of SMPS units is connected to common ground. Circuit breakers, output fuse, ammeter shunt etc are provided on the negative path of the output (Yes/No)



ANNEXURE – IV-B

(For Testing of Battery Charger)

(To be filled in by the bidder)

CALIBRATION STATUS OF TESTING EQUIPMENTS AND INSTRUMENTS/ METERS

1	2	3	4	5	6	7	8	9	10	11	12
Name of the Test	Meters & Equipments required for the corresponding test with range, accuracy, make & Sl. No.	Date of Calibration	Due date of Calibration	Name of the Calibrating Agency .	Whether Calibrating Agency is Govt. approved	Whether documents relating to Govt. approval of the calibrating Agency furnished	Whether the meters/ equipments fulfil the accuracy class as per calibration report.	Whether the calibrating agency has put any limitation towards the use of the particular meter/ equipment. If yes state the limitations	Whether the calibrating agency has put any limitation towards the use of the particular meter/ equipment/ meter/ State the colour of the affixed sticker	In spite of imposed limitations. Whether the particular meter / equipment can still be used ? Justify its use for corresponding test(s)	Remark

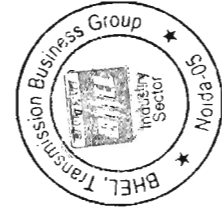

Signature of the tenderer with seal & date

ANNEXURE V – B

(To be filled in by the bidder)

CHECK LIST TOWARDS TYPE TEST REPORTS FOR BATTERY CHARGER

Name of the Type Test	Date of Test	Name of the Laboratory where the Test has been conducted	Whether the Laboratory is Government approved	Whether the Test report is valid as per Spn.	Whether the Test report in complete shape along with drawings etc. furnished or not ?	Whether the type tested battery charger fulfills the technical requirements as per TS	If the type tested battery charger does not fulfill the technical requirements as per this specification, whether the bidder agrees to conduct the particular type test again at their own cost without any financial liability to OPTCL in the presence of OPTCL's representative within the specified delivery period	Remarks
1	2	3	4	5	6	7	8	9



Signature of the tenderer with seal

PROJECT: 2X500 MVA, 400/220 KV GIS S/S AT ERSAMA & ASSOCIATED 2 NOS 400 KV BAY EXTN AT DUBURI	
CUSTOMER: ODISHA POWER TRANSMISSION CORPORATION LIMITED (OPTCL)	
Technical Specification	TB-4-420-316-xxx Rev 00
Section-3: Project Details and General Specification	

SECTION- 3

PROJECT DETAILS AND GENERAL SPECIFICATIONS

3.0 GENERAL

This section stipulates the General Technical Requirements under the Contract and will form an integral part of the Technical Specification.

The provisions under this section are intended to supplement general requirements for the materials, equipment and services covered under other sections of tender documents and are not exclusive. However, in case of conflict between the requirements specified in this section and requirements specified under other sections, the requirements specified under respective sections shall prevail.

3.1 PROJECT DETAILS

	Particular	Details
a)	Customer	ODISHA POWER TRANSMISSION CORPORATION LIMITED (OPTCL)
b)	Engineer/Consultant/ Inspector	-
c)	Project Title	2X500 MVA, 400/220 KV GIS S/S AT ERSAMA & ASSOCIATED 2 NOS 400 KV BAY EXTN AT DUBURI
d)	Project Location	<u>400/220kV GIS S/S</u> Place: Erasama, Paradeep District: Jagatsingha State: Odisha <u>400kV AIS S/S Bay Extn.</u> Place: Duburi District: Jajpur State: Odisha
e)	Latitude & Longitude	<u>400/220kV GIS S/S</u> North: 20°12'32" and East: 86°21'44" <u>400kV AIS S/S Bay Extn.</u> North: 20°56'14" and East: 86°00'23"
f)	Nearest Railway Station	Erasama – At a distance of about 32 km from Paradeep station Duburi – At a distance of about 14 km from Jajpur Road station
g)	Distance of project location from the Railway station	Erasama – At a distance of about 32 km from Paradeep station Duburi – At a distance of about 14 km from Jajpur Road station
h)	Nearest Major Town	Bhubaneswar
i)	Distance of the town from the project site	86 Km from Erasama & 120 Km from Duburi
j)	Nearest commercial airport	Biju Patnaik International Airport, Bhubaneswar

PROJECT: 2X500 MVA, 400/220 KV GIS S/S AT ERSAMA & ASSOCIATED 2 NOS 400 KV BAY EXTN AT DUBURI
CUSTOMER: ODISHA POWER TRANSMISSION CORPORATION LIMITED (OPTCL)
Technical Specification TB-4-420-316-xxx Rev 00
Section-3: Project Details and General Specification

k)	Distance of airport from the project site	86 Km from Erasama & 120 Km from Duburi
	SITE CONDITIONS (for design purposes)	
a)	Annual mean if maximum monthly average temperature	50°C
b)	Annual mean if minimum monthly temperature	5°C
c)	Design ambient temperature	50°C
d)	Average Rainfall in mm	1500 mm
e)	Average thunderstorm days per year	77 days
f)	Maximum Relative humidity	100 %
g)	Average Relative humidity	85 %
h)	Height above mean sea level	Less than 1000 meters
i)	Pollution Severity	Heavily polluted
j)	Criteria for Wind Resistant design of structures and equipment	Standard Applicable - IS 875 (Part 3)
k)	Basic Wind speed "Vb" at ten meters above the mean ground level.	55m/ sec for Erasama 50 m/ sec for Duburi
l)	Risk Coefficient "K1"	1
m)	Seismic Co-efficient	0.06g Horizontal 0.01g Vertical

3.1.1 SYSTEM PARAMETERS

Sl.No.	Parameters	400 kV	220 kV	33 kV
1	Highest system voltage	420 kV rms	245 kVrms	36
2	System Frequency	50 Hz		
3	Variation in Frequency	+ - 2.5 %		
5	Lightning Impulse voltage	±1425kVp	± 1050kVp	170
6	Switching impulse voltage	±1050kVp	-	
7	Power frequency withstand for 1 min (rms)	630 kV (rms)	460 kV (rms)	70 kV (rms)
8	Max. fault level (3/1 sec.)	63 kA	50kA	31.5kA
9	Minimum creepage distance	13020 mm (Erasama) 10500 mm (Duburi)	7595mm (Erasama) -	1116mm (Erasama) 900mm (Duburi)
10	System Neutral Earthing	Effectively Earthed		
11	Corona Extinction Voltage	320kV	156kV	-
12	Radio Interference Voltage	500µV at 266kV	500µV at 167kV	-

3.1.2 AUXILIARY POWER

Nominal Voltage V	Variation	Frequency Hz or DC	Phase	Wires	Neutral Connection
430	±10%	50±5%	3	4	Solidly earthed
240	±10%	50±5%	1	2	Solidly earthed
220	187V - 242V	DC	DC	2	Isolated 2 wires
50	45V - 55V	DC	DC	2	+ve earthed

PROJECT: 2X500 MVA, 400/220 KV GIS S/S AT ERSAMA & ASSOCIATED 2 NOS 400 KV BAY EXTN AT DUBURI	
CUSTOMER: ODISHA POWER TRANSMISSION CORPORATION LIMITED (OPTCL)	
Technical Specification	TB-4-420-316-xxx Rev 00
Section-3: Project Details and General Specification	

3.1.3 The minimum electrical clearances for 400/220/33kV switchyard shall be as given below:

	400kV	220kV	33kV
Phase to earth clearance	3400 mm	2160mm	320mm
Phase to phase clearance	3900 mm	2160mm	320mm
Section clearance	6500 mm	5000mm	3000mm
Ground Clearance	8000 mm	5500mm	4000mm

3.2 INSTRUCTION TO BIDDERS:

The bidders shall furnish technical data sheets, catalogues, engineering data, technical information, design documents, drawings etc. fully in conformity with the technical specification.

The supplier should be approved by Employer (OPTCL). If not, it is the responsibility of the vendor to be assessed and approved by Employer, before placement of order by BHEL. Any cost involved in vendor assessment/approval must be borne by the vendor himself.

The Bidder's proposal shall be based upon the use of equipment and material complying fully with the requirements specified herein. It is recognized that the Bidder may have standardized on the use of certain components, materials, processes or procedures different than those specified herein. Alternate proposals offering similar equipment based on the manufacturer's standard practice will also be considered, provided the base offer is in line with technical specifications and such proposals meet the specified design standards and performance requirement and are acceptable to the Purchaser. Sufficient amount of information for justifying such proposals shall be furnished to Purchaser along with the bid to enable the Purchaser to determine the acceptability of these proposals.

Wherever a material or article is specified or defined by the name of a particular brand, Manufacturer or Vendor, the specific name mentioned shall be understood to be indicative of the function and quality desired and not restrictive. Other manufacturer's products may be considered provided sufficient information is furnished to enable the Employer to determine that the products proposed are equivalent to those named.

Equipment furnished shall be complete in every respect with all mountings, fittings, fixtures and standard accessories normally provided with such equipment and/ or needed for erection, completion and safe operation of the equipment as required by applicable codes, though they may not have been specifically detailed in the Technical Specifications unless included in the list of exclusions. Materials and components not specifically stated in the specification but which are necessary for commissioning and satisfactory operation of the switchyard unless specifically excluded shall be deemed to be included in the scope of the specification and shall be supplied without any extra cost. All similar standard components/parts of similar standard equipment under supply shall be inter-changeable with one another.

The bidder shall supply type tested (including special tests as per tech. specification) equipment and materials. The test reports shall be furnished by the bidder along with equipment/ material drawings. In the event of any discrepancy in the test reports, (i.e., if any test report is not acceptable due to any design/ manufacturing changes or due to non-compliance with the Technical Specification and/ or applicable standard), the tests shall be carried out without any additional cost implication to the BHEL. BHEL reserves the right to get any or all type/tests conducted/repeated.

PROJECT: 2X500 MVA, 400/220 KV GIS S/S AT ERSAMA & ASSOCIATED 2 NOS 400 KV BAY EXTN AT DUBURI	
CUSTOMER: ODISHA POWER TRANSMISSION CORPORATION LIMITED (OPTCL)	
Technical Specification	TB-4-420-316-xxx Rev 00
Section-3: Project Details and General Specification	

3.3 CODES AND STANDARDS

In addition to the codes and standards specifically mentioned in the relevant technical specifications for the equipment / plant / system, all equipment parts, systems and works covered under this specification shall comply with all currently applicable statutory regulations and safety codes of the Republic of India as well as of the locality where they will be installed.

Except where otherwise specified or implied, the bidder shall comply with the latest edition of the relevant Indian Standards, International Electrotechnical Commission (IEC) standards and any other standards mentioned in this Specification. The Bidder may submit for approval, equipment or materials conforming to technically equivalent National Standards. In such cases copies of the relevant Standards or part thereof, in the English language shall be submitted with the Tender.

In case of conflict the order of precedence shall be (1) IEC, (2) IS and (3) other alternative standard.

Reference to a particular standard or recommendation in this Specification does not relieve the Bidder of the necessity of providing the Contract Works complying with other relevant standards or recommendations.

The list of standards provided in the schedules of this Specification is not to be considered exhaustive and the Bidder shall ensure that equipment supplied under this contract meets the requirements of the relevant standard whether or not it is mentioned therein.

Other International/ National standards such as DIN, VDI, BS, GOST etc. shall also be accepted for only material codes and manufacturing standards, subject to the Employer's approval, for which the Bidder shall furnish, adequate information to justify that these standards are equivalent or superior to the standards mentioned above. In all such cases the Bidder shall furnish specifically the variations and deviations from the standards mentioned elsewhere in the specification together with the complete word to word translation of the standard that is normally not published in English.

3.4 LANGUAGE AND SYSTEM OF UNITS

The English language shall be used in all written communications between the Employer, the BHEL/OPTCL and the Bidder with respect to the services to be rendered and with respect to all documents and drawings procured or prepared by the Bidder pertaining to the work, unless otherwise agreed by the Employer.

It is required that danger plates, equipment designation labels or plates, instruction notices on plant and general substation notices be written in English, Hindi and Oriya. Control switch and lamp labels, indicator lamp and annunciator inscriptions shall be in English only.

The Bidder must furnish a schedule giving the English, Hindi and Oriya version of all labels, notices, etc., for approval.

The design features of all equipment shall be based on the SI system of units.

3.5 SERVICES TO BE PERFORMED BY THE EQUIPMENT BEING FURNISHED

The 400 kV system is being designed to limit the power frequency over voltage of 1.5 p.u. and the switching surge over voltage to 2.5 p.u. In 400 kV system the initial value of temporary over voltage could be 2.0 p.u. for 1-2 cycles. All the equipment/materials covered in this specification shall perform all its function satisfactorily without undue strain, restrike etc. under such over voltage conditions.

PROJECT: 2X500 MVA, 400/220 KV GIS S/S AT ERSAMA & ASSOCIATED 2 NOS 400 KV BAY EXTN AT DUBURI	
CUSTOMER: ODISHA POWER TRANSMISSION CORPORATION LIMITED (OPTCL)	
Technical Specification	TB-4-420-316-xxx Rev 00
Section-3: Project Details and General Specification	

All equipment shall also perform satisfactorily under various other electrical, electromechanical and meteorological conditions of the site of installation. All equipment shall be able to withstand all external and internal mechanical, thermal and electromechanical forces due to various factors like wind load, temperature variation, ice & snow (not applicable for this project), short circuit etc for the equipment.

3.6 CORRESPONDENCE, DRAWINGS, APPROVAL PROCEDURE AND SAMPLES

3.6.1 Drawings & Document Submission

All drawings submitted by the supplier including those submitted at the time of bid shall be in sufficient detail to indicate the type, size, arrangement, material description, Bill of Materials, weight of each component, break-up for packing and shipment, the external connections, fixing arrangement required. The dimensions required for installation and interconnections with other equipment and materials, clearances and spaces required for installation and interconnections between various portions of equipment and any other information specifically requested in the specifications.

Each drawing submitted by the bidder (including those of sub-vendors) shall bear project specific title block at the right hand bottom corner with clear mention of the name of the Employer, the system designation, the specifications title, the specification number, the name of the Project, drawing number and revisions. If standard catalogue pages are submitted, the applicable items shall be indicated therein. All titles, noting, markings and writings on the drawing shall be in English. All the dimensions should be in metric units.

All dimensions marked on drawings shall be considered correct although measurement by scale may differ from general arrangement drawings. Detailed drawings shall be worked to where they differ from general arrangement drawings.

All drawings for approval shall have the OPTCL-LOGO and the name of the Employer.

For presentation of design drawings and circuit documents IEC Publication 617 or equivalent standards for graphical symbols are to be followed.

The review of these document/data/drawings by the purchaser will cover only general conformance of the document/data/drawings to the specification and contract, interfaces with the equipment provided under specification, external connections and of the dimensions which might affect plan layout. This review by the purchaser may not indicate a thorough review of the dimensions, quantities and details of the equipment, material, any devices or items indicated or the accuracy of the information submitted. The review and/or approval by the purchaser shall not be considered by the bidder, as limiting any of his responsibilities and liabilities for mistakes and deviations from the requirements, specified under these specifications and documents.

All manufacturing, fabrication and execution of work in connection with the equipment/system prior to the approval of the drawings shall be at the bidder's risk. The bidder is expected not to make any changes in the design of the equipment /system, once they are approved by the Purchaser. However, if some changes are necessitated in the design of the equipment/system at a later date, the bidder may do so, but such changes shall promptly be brought to the notice of the Purchaser indicating the reasons for the change and get the revised drawing approved again in strict conformance to the provisions of the Technical Specification. Approval of bidder's drawing or work by the Purchaser shall not relieve the bidder of any of his responsibilities and liabilities under the Contract.

3.6.2 Bidder's Drawing Submission and Approval Procedure

PROJECT: 2X500 MVA, 400/220 KV GIS S/S AT ERSAMA & ASSOCIATED 2 NOS 400 KV BAY EXTN AT DUBURI	
CUSTOMER: ODISHA POWER TRANSMISSION CORPORATION LIMITED (OPTCL)	
Technical Specification	TB-4-420-316-xxx Rev 00
Section-3: Project Details and General Specification	

The following procedure for submission and review/approval of the drawings, data reports, information, etc. shall be followed by the bidder:

- a. All data/information furnished by Vendor in the form of drawings, documents, Catalogues or in any other form for Employer's information/interface and/or review and approval are referred by the general term "drawings".
- b. The 'Master drawings list' indicating titles, Drawing Number, Date of submission and approval etc. shall be furnished by the bidder. This list shall be updated if required at suitable interval during detailed engineering.
- c. All drawings (including those of sub-vendor) shall bear at the right hand bottom corner the 'title plate' with all relevant information duly filled in. The bidder shall furnish this format to his sub-vendor along with his purchase order for sub-vendor's compliance.
- d. Three copies of all drawings shall be submitted for approval and three copies for any subsequent revision. Employer shall forward their comments within four (4) weeks of receipt of drawings.
- e. The OPTCL/BHEL reserves the right to request any additional information that may be considered necessary in order to fully review the drawings. Drawings for approval shall be submitted as paper prints and shall bear the approved contract references.
- f. Upon review of each drawings, depending on the correctness and completeness of the drawings, the same will be categorised and approval accorded in one of the following categories:

CATEGORY I	Approved
CATEGORY II	Approved, subject to incorporation of comments/modification as noted. Resubmit revised drawing incorporating the comments
CATEGORY III	Not approved. Resubmit revised drawings for Approval after incorporating comments/modifications as noted
CATEGORY IV	For information and records

- g. Bidder shall resubmit the drawings approved under Category II, III within one (1) week of receipt of comments on the drawings, incorporating all comments. Every revision of the drawing shall bear a revision index wherein such revisions shall be highlighted in the form of description or marked up in the drawing identifying the same with relevant revision number enclosed in a triangle (e.g 1.2.3. etc.).
- h. In case Bidder does not agree with any specific comment, he shall furnish the explanation for the same to Employer for consideration. In all such cases Bidder shall necessarily enclose explanations along with the revised drawing (taking care of balance comments) to avoid any delay and/or duplication in review work.
- i. It is the responsibility of the Bidder to get all the drawings approved in the Category I or IV (as the case may be) and complete engineering activities within the agreed schedule. Any delay arising out of submission and modification of drawings shall not alter the contract completion schedule.
- j. Bidder shall not make any changes in the portions of the drawing other than those commented. If changes are required to be made in the portions already approved, the Bidder shall resubmit the drawings identifying the changes (along with reasons for changes) for Employer's review and approval. **Drawings resubmitted shall show clearly the portions where the same are revised marking the relevant revision numbers and Employer shall review only such revised portion of documents.**

PROJECT: 2X500 MVA, 400/220 KV GIS S/S AT ERSAMA & ASSOCIATED 2 NOS 400 KV BAY EXTN AT DUBURI	
CUSTOMER: ODISHA POWER TRANSMISSION CORPORATION LIMITED (OPTCL)	
Technical Specification	TB-4-420-316-xxx Rev 00
Section-3: Project Details and General Specification	

3.6.3 As Built Drawings

After completion of work on site all drawings shall be revised where necessary to show the equipment as installed and three copies submitted duly signed by site-in-charge. Following approval, two reproducible transparencies and twenty prints shall then be provided as required by the OPTCL/BHEL and shall be of sufficient detail to enable all parts to be identified. The bidder shall also submit, where possible, digitally stored copies of all as-built drawings on disc or CD-ROM in a format compatible with the Employer's drawing system.

Approval of drawings will not in any way relieve the Bidder of his obligations of furnishing the equipment in accordance with the specification and shall not prevent subsequent rejection if such equipment is later found to be defective.

3.6.4 Operation and Maintenance Manual

- a. The Bidder shall submit to the Employer preliminary instruction manuals for all the equipment for review. The final instructions manuals incorporating Employer's comments and complete in all respect shall be submitted at least sixty (60) days before the first shipment of the equipment. The instruction manuals shall contain full details and drawings of all the equipment, the transportation, storage, installation, testing, commissioning, operation and maintenance procedures, etc. separately for each component/equipment along with log record format. After approval by the Engg. In charge the Bidder shall deliver ten (10) copies of the complete manual.
- b. If after commissioning and initial operation of the plant, the instruction manuals require any modifications/additions/changes, the same shall be incorporated and the updated final instruction manuals shall be submitted.
- c. The operating and maintenance instructions together with drawings (other than shop drawings) of the equipment, as completed, shall have sufficient details to enable the Employer to maintain, dismantle, reassemble and adjust all parts of the equipment. They shall give a step by step procedure for all operations likely to be carried out during the life of the plant/equipment, including erection, testing, commissioning, operation, maintenance dismantling and repair. Each manual shall also include a complete set of approved drawings together with performance/rating curves of the equipment and test certificates, wherever applicable. The contract shall not be considered completed for purpose of taking over until such instructions and drawings have been supplied to the Employer.
- d. A separate section of the manual shall be for each size/type of equipment and shall contain a detailed description of construction and operation, together with all relevant pamphlets.
- e. The manuals shall include the following
 - a) List of spare parts along with their drawing and catalogues and procedure for ordering spares.
 - b) Lubrication Schedule including charts showing lubrication checking, testing and replacement procedure to be carried daily, weekly, monthly & at longer intervals to ensure trouble free operation.

The Contract shall not be considered to be completed for purposes of taking over until the final Instructions manuals (both erection and O & M manuals) have been supplied to the Employer.

3.6.5 Final Submission of drawings and documents

The Bidder shall furnish the following after approval of all drawings /documents and test reports:

- a. List of drawings bearing the Employer's and Bidder's drawing number.

PROJECT: 2X500 MVA, 400/220 KV GIS S/S AT ERSAMA & ASSOCIATED 2 NOS 400 KV BAY EXTN AT DUBURI	
CUSTOMER: ODISHA POWER TRANSMISSION CORPORATION LIMITED (OPTCL)	
Technical Specification	TB-4-420-316-xxx Rev 00
Section-3: Project Details and General Specification	

- b. Six (6) bound sets along-with two (2) sets of CD-ROMs/ DVD/Portable hard disk of all final drawings/documents.
- c. Bidder shall also furnish six (6) bound sets of all as-built drawings including the list of all as-built drawings bearing drawing numbers. The Bidder shall also furnish two (2) sets of CD-ROMs/ DVD/Portable hard disk of all as-built drawings as decided by the Employer.
- d. The Bidder shall also furnish four (4) copies and two (2) sets of CD-ROMs/ DVD/Portable hard disk of instruction/ operations & maintenance manuals (after approval) for all the equipment.

3.6.6 Test Reports

Two (2) copies of all test reports shall be supplied for approval before shipment of Equipment. The report shall indicate clearly the standard value specified for each test to facilitate checking of the reports. After final approval six (6) bound copies and two (2) sets of CD-ROMs/ DVD/Portable hard disk of all type and routine test reports shall be submitted to Employer.

3.7 MATERIAL /WORKMANSHIP

Where the specification does not contain references to workmanship, equipment, materials and components of the covered equipment, it is essential that the same must be new, of highest grade of the best quality of their kind, conforming to best engineering practice and suitable for the purpose for which they are intended and shall ensure satisfactory performance throughout the service life.

In case where the equipment, materials or components are indicated in the specification as “similar” to any special standard the purchaser shall decide upon the question of similarity. When required by the specification or when required by the purchaser the bidder shall submit, for approval, all the information concerning the materials or components to be used in manufacture. Machinery, equipment, materials and components supplied, installed or used without such approval shall run the risk of subsequent rejection, it being understood that the cost as well as the time delay associated with the rejection shall be borne by the Bidder.

The design of the Works shall be such that installation, future expansions, replacements and general maintenance may be undertaken with a minimum of time and expenses. Each component shall be designed to be consistent with its duty and suitable factors of safety subject to mutual agreements. All joints and fastenings shall be devised, constructed and documented so that the component parts shall be accurately positioned and restrained to fulfill their required function. In general, screw threads shall be standard metric threads. The use of other thread forms will only be permitted when prior approval has been obtained from the Purchaser.

Whenever possible, all similar part of the works shall be made to gauge and shall also be made interchangeable with similar parts. All spare parts shall also be interchangeable and shall be made of the same materials and workmanship as the corresponding parts of the equipment supplied under the specification. Where feasible, common component units shall be employed in different pieces of equipment in order to minimize spare parts stocking requirements. All equipment of the same type and rating shall be physically and electrically interchangeable.

The equipment offered in the bid only shall be accepted for supply, with the minimum modifications as agreed/accepted.

3.8 PROVISIONS FOR EXPOSURE TO HOT AND HUMID CLIMATE

PROJECT: 2X500 MVA, 400/220 KV GIS S/S AT ERSAMA & ASSOCIATED 2 NOS 400 KV BAY EXTN AT DUBURI	
CUSTOMER: ODISHA POWER TRANSMISSION CORPORATION LIMITED (OPTCL)	
Technical Specification	TB-4-420-316-xxx Rev 00
Section-3: Project Details and General Specification	

Outdoor equipment supplied under the specification shall be suitable for service and storage under tropical conditions of high temperature, high humidity' heavy rainfall and environment favorable to the growth of fungi and mildew. The indoor equipment located in non-air-conditioned areas shall also be of same type.

3.8.1 Space Heaters

Space heaters where provided shall be suitable for continuous operation at 240V supply voltage. On-off switch and fuse shall be provided.

One or more adequately rated permanently or thermostatically connected heaters shall be supplied to prevent condensation in any compartment. The heaters shall be installed in the lower portion of the compartment and electrical connections shall be made from below the heaters to minimise deterioration of supply wire insulation. The heaters shall be suitable to maintain the compartment temperature at approximately 10C, above the outside air temperature to prevent condensation. This shall be demonstrated by tests.

3.8.2 Fungi Static Varnish

Besides the space heaters, special moisture and fungus resistance varnish shall be applied on parts which may be subjected or predisposed to the formation of fungi due to the presence or deposit of nutrient substances. The varnish shall not be applied to any surface of part where the treatment will interfere with the operation or performance of the equipment. Such surfaces or parts shall be protected against the application of the varnish.

3.8.3 Ventilation Openings

In order to ensure adequate ventilation, compartments shall have ventilation openings provided with fine wire mesh of brass to prevent the entry of insects and to reduce to a minimum the entry of dirt and dust. Outdoor compartment openings shall be provided with shutter type blinds.

3.9 CLEANING, PAINTING AND TROPICALASATION

3.9.2 General

All paints shall be applied in strict accordance with the paint manufacturer's instructions.

All painting shall be carried out on dry and clean surfaces and under suitable atmospheric and other conditions in accordance with the paint manufacturer's recommendations.

An alternative method of coating equipment such as with epoxy resin-based coating powders will be permitted, subject to the approval of the Engg. In charge (Divisional Engr.), and such powders shall comply with the requirements of IEC 455. The Bidder shall provide full details of the coating process to the Engg. In charge (Divisional Engr.) for approval.

It is the responsibility of the Bidder to ensure that the quality of paints used shall withstand the tropical heat and extremes of weather conditions specified in the schedules. The paint shall not peel off, wrinkle, be removed by wind, storm and handling on site and the surface finish shall neither rust nor fade during the service life of the equipment.

The colors of paints for external and internal surfaces shall be in accordance with the approved color schemes.

PROJECT: 2X500 MVA, 400/220 KV GIS S/S AT ERSAMA & ASSOCIATED 2 NOS 400 KV BAY EXTN AT DUBURI	
CUSTOMER: ODISHA POWER TRANSMISSION CORPORATION LIMITED (OPTCL)	
Technical Specification	TB-4-420-316-xxx Rev 00
Section-3: Project Details and General Specification	

3.9.3 Works Painting Process

All steelworks, plant supporting steelworks and metalwork, except galvanised surfaces or where otherwise specified, shall be shot blasted to BS 7079 or the equivalent ISO standard. All sheet steel work shall be degreased, pickled, phosphated in accordance with the IS 6005 "Code of Practice for phosphating iron and sheet steel". All surfaces shall then be painted with one coat of epoxy zinc rich primer, two pack type, to a film thickness of 50 microns. This primer shall be applied preferably by airless spray and within twenty minutes but not exceeding one hour of shot blasting.

All rough surfaces of coatings shall be filled with an approved two pack filler and rubbed down to a smooth surface.

The interior surfaces of all steel tanks and oil filled chambers shall be shot blasted in accordance with BS 7079 or the equivalent ISO, and painted within a period of preferably twenty minutes, but not exceeding one hour with an oil resisting coating of a type and make to the approval of the BHEL/OPTCL.

The interior surfaces of mechanism chambers, boxes and kiosks, after preparation, cleaning and priming as required above, shall be painted with one coat zinc chromate primer, one coat phenolic based undercoating, followed by one coat phenolic based finishing paint to a light or white colour. For equipment for outdoor use this shall be followed by a final coat of anti-condensation paint of a type and make to the approval of the BHEL/OPTCL, to a light or white colour. A minimum overall paint film thickness of 150 microns shall be maintained throughout.

All steelworks and metalwork, except where otherwise specified, after preparation and priming as required above shall be painted with one coat metallic zinc primer and two coats of micaceous iron oxide paint followed by two coats of either phenolic based or enamel hard gloss finished coloured paint to the approval to an overall minimum paint film thickness of 150 microns.

Galvanised surfaces shall not be painted in the works.

All nuts, bolts, washers etc., which may be fitted after fabrication of the plant shall be painted as described above after fabrication.

The painted metal works shall be subjected to paint qualification test as per draft ANSI/IEEE-Std 37.21 - 1985 clause 5.2.5.

3.9.4 Colour Schemes

The Bidder shall propose a colour scheme for the sub-station for the approval of BHEL/OPTCL. The decision of BHEL/OPTCL shall be final. The scheme shall include:

- Finishing colour of indoor equipment
- Finishing colour of outdoor equipment
- Finish colour of all cubicles
- Finishing colour of various auxiliary system equipment including piping.
- Finishing colour of various building items.

All steel structures, plates etc. shall be painted with non-corrosive paint on a suitable primer. It may be noted that normally all Employer's electrical equipment in Employer's switchyard are painted with shade 631 of IS: 5 and Employer will prefer to follow the same for this project also. All indoor cubicles shall be of same colour scheme and for other miscellaneous items colour scheme will be subject to the approval of the BHEL/OPTCL.

PROJECT: 2X500 MVA, 400/220 KV GIS S/S AT ERSAMA & ASSOCIATED 2 NOS 400 KV BAY EXTN AT DUBURI
CUSTOMER: ODISHA POWER TRANSMISSION CORPORATION LIMITED (OPTCL)
Technical Specification TB-4-420-316-xxx Rev 00
Section-3: Project Details and General Specification

Sl. No.	Equipment	Application Environment			
		Indoor		Outdoor	
		Colour	Code IS:5	Colour	Code IS:5
400kV/220kV/132kV Class Equipment					
1	Transformers	—	—	Light grey	631
2	Marshalling boxes, CTs, PT's, CVT's, surge counter casings, junction boxes etc.	Light Admiralty grey.	697	Light Admiralty grey.	697
3	Control and relay panels, PLCC cabinets etc.	Smoke grey	692	—	—
4	Porcelain parts i.e. insulators	Dark brown	412	Dark brown	412
5	All structures/ metallic parts exposed to atmosphere	Hot dip galvanised			
33kV Class equipment					
6	Switchgear cubicles	Smoke grey	692	Light grey	631
7	Control and relay panels	Smoke grey	692	—	—
	LT switchgear				
8	LT switchgear exterior	Smoke grey	692	Light grey	631
9	ACDB/ MCC	Smoke grey	692	Light grey	631
10	DCDB	Smoke grey	692	—	—
11	LT bus duct in side enclosure	Matt Paint		—	—
12	LT bus duct outside enclosure	Smoke grey	692	—	—
13	Motors	Smoke grey	692	Light grey	631
14	Diesel generator engine	Smoke grey	692	—	—
15	Diesel generator	Smoke grey	692	—	—
16	LT transformers	Smoke grey	692	Light grey	631
17	Battery charger	Smoke grey	692	—	—
18	Mimic diagram				
	400kV	Dark violet	796	—	—
	220kV	Golden yellow	356	—	—
	132kV	Sky blue	101	—	—
	33kV	Signal red	537	—	—
	11kV	Canary yellow	309	—	—
	415V	Middle brown	411	—	—
	Miscellaneous				
19	Control modules and console inserts	Smoke grey	692	Light grey	631
20	Lighting package equipment outside	Light grey	631	Light grey	631
21	Lighting package equipment inside	Glossy white		Glossy white	
22	Water pipes	sea green	217	sea green	217
23	Air pipes	Sky blue	101	Sky blue	101
24	Transformer oil pipes	Light brown	410	Light brown	410
25	Fire Installations	Fire red	536	Fire red	536
26	Insulating oil/ gas treatment plant	Gulf red	473	Gulf red	473

Table 10.3.4. Recommended color schemes

3.10 DEGREES OF PROTECTION

Degrees of protection shall be provided in accordance with IEC 144 and IEC 529 and be as follows:

- For outdoor applications, IP 55.
- For indoor applications where purpose built accommodation is provided, e.g. switch and control and relay rooms in auxiliary plant buildings, IP 41.
- Where dust can adversely affect equipment within the enclosure, this equipment should be separately housed with a degree of protection of IP 51.

PROJECT: 2X500 MVA, 400/220 KV GIS S/S AT ERSAMA & ASSOCIATED 2 NOS 400 KV BAY EXTN AT DUBURI	
CUSTOMER: ODISHA POWER TRANSMISSION CORPORATION LIMITED (OPTCL)	
Technical Specification	TB-4-420-316-xxx Rev 00
Section-3: Project Details and General Specification	

- For indoor applications where the equipment is housed in the same building as that enclosing water and steam operated equipment, the degrees of protection stated in the previous paragraph shall be up-rated to IP 44 and IP 54 respectively.

Where more severe environments exist, e.g. steam and oil vapour or other deleterious chemical environments, special measures will be necessary and the degree of protection required will be specified separately.

The Bidder shall submit a schedule for providing the degree protection to various control boxes, junction boxes etc. for the BHEL/OPTCL's approval.

3.11 RATING PLATES, NAME PLATES AND LABELS

- All apparatus shall be clearly labelled indicating, where necessary, its purpose and service positions. Each phase of alternating current and each pole of direct current equipment and connections shall be coloured in an approved manner to distinguish phase or polarity.
- The material of all labels and the dimensions, legend, and method of printing shall be to approval. The surface of indoor labels shall have a matt or satin finish to avoid dazzle from reflected light.
- Colours shall be permanent and free from fading. Labels mounted on black surfaces shall have white lettering. „Danger“ plates shall have red lettering on a white background.
- All labels and plates for outdoor use shall be of non-corroding material. Where the use of enamelled iron plates is approved, the whole surface including the back and edges, shall be properly covered and resistant to corrosion. Protective washers of suitable material shall be provided front and back on the securing screws.
- Labels shall be engraved in Hindi, English and Oriya. Name plates shall be white with black engraved lettering and shall carry all the applicable information specified in the applicable items of the Standards.
- Any other relevant information which may be required for groups of smaller items for which this is not possible e.g. switch bays etc. a common name plate in Oriya with the title and special instructions on it shall be provided.
- No scratching, corrections or changes will be allowed on name plates.
- All equipment mounted on front and rear sides as well as equipment mounted inside the panels shall be provided with individual name plates with equipment designation engraved.
- On the top of each panel on front as well as rear sides large name plates with bold size lettering shall be provided for circuit/ feeder/ cubicle box designation.
- All front mounted equipment shall be also provided, at the rear, with individual name plates engraved with tag numbers corresponding to the one shown in the panel internal wiring to facilitate tracing of the wiring. The name plates shall be mounted directly by the side of the respective equipment wiring.
- Name plates of cubicles and panels may be made of non rusting metal or 3 ply lamicaid. These name plates may be black with white engraved lettering.

PROJECT: 2X500 MVA, 400/220 KV GIS S/S AT ERSAMA & ASSOCIATED 2 NOS 400 KV BAY EXTN AT DUBURI	
CUSTOMER: ODISHA POWER TRANSMISSION CORPORATION LIMITED (OPTCL)	
Technical Specification	TB-4-420-316-xxx Rev 00
Section-3: Project Details and General Specification	

- l) The name plate inscription and size of name plates and letters shall be submitted to the BHEL/OPTCL/ Engineer for approval.
- m) The nameplates of the apparatus shall include, at least, the information listed below, together with any other relevant information specified in the applicable standards:
 - Concise descriptive title of the equipment
 - Rating and circuit diagrams
 - Manufacturer's name, trade-mark, model type, serial number
 - Instruction book number
 - Year of manufacture
 - Total weight (for capacitor racks indicate weight, for capacitors indicate quantity of liquid)
 - Special instructions, if any, about storage, transportation, handling etc.
- n) Each measuring instrument and meter shall be prominently marked with the quantity measured e.g. kV, A, MW etc. All relays and other devices shall be clearly marked with manufacturers name, manufacturer's type, serial number and electrical rating data.
- o) Danger plates and plates for phase colours shall be provided as per requirement. The Bidder shall devise a system to designate equipment and sub-systems. The nameplates/labels displaying these designations shall be installed at appropriate locations. Whenever motion or flow of fluids is involved, plates showing direction of motion or flow shall also be provided.

3.12 BOLTS AND NUTS

All bolts, studs, screw threads, pipe threads, bolt heads and nuts shall comply with the appropriate national standards for metric threads, or the technical equivalent.

Except for small wiring, current carrying terminal bolts or studs, for mechanical reasons, shall not be less than 6 mm in diameter.

All nuts and pins shall be adequately locked. Wherever possible bolts shall be fitted in such a manner that in the event of failure of locking resulting in the nuts working loose and falling off, the bolt will remain in position.

All bolts, nuts and washers placed in outdoor positions shall be treated to prevent corrosion, by hot dip galvanising or electro galvanising to service condition 4. Appropriate precautions shall be taken to prevent electrolytic action between dissimilar metals.

Where bolts are used on external horizontal surfaces where water can collect, methods of preventing the ingress of moisture to the threads shall be provided.

Each bolt or stud shall project at least one thread but not more than three threads through its nut, except when otherwise approved for terminal board studs or relay stems. If bolts and nuts are placed so that they are inaccessible by means of ordinary spanners, special spanners shall be provided.

The length of the screwed portion of the bolts shall be such that no screw thread may form part of a shear plane between members. Taper washers shall be provided where necessary.

Protective washers of suitable material shall be provided front and back on the securing screws.

PROJECT: 2X500 MVA, 400/220 KV GIS S/S AT ERSAMA & ASSOCIATED 2 NOS 400 KV BAY EXTN AT DUBURI	
CUSTOMER: ODISHA POWER TRANSMISSION CORPORATION LIMITED (OPTCL)	
Technical Specification	TB-4-420-316-xxx Rev 00
Section-3: Project Details and General Specification	

3.13 GALVANISING:

3.13.1 General

All machining, drilling, welding, engraving, scribing or other manufacturing activities which would damage the final surface treatment shall be completed before the specified surface treatment is carried out.

3.13.2 Galvanising

All metal surfaces shall be subjected to treatment for anti-corrosion protection. All ferrous surfaces for external use shall be hot dip galvanised. High tensile steel nuts, bolts and spring washers shall be electro galvanised to service condition 4. All steel conductors including those used for earthing and grounding (above ground level) shall also be galvanised according to IS 2629.

All galvanising shall be applied by the hot dip process and shall comply with IS 2629, IS 2633, IS 4759, IS 1367 or IS 6745.

All welds shall be de-scaled, all machining carried out and all parts shall be adequately cleaned prior to galvanising. The preparation for galvanising and the galvanising itself shall not adversely affect the mechanical properties of the coated material.

The threads of all galvanised bolts and screwed rods shall be cleared of spelter by spinning or brushing. A die shall not be used for cleaning the threads unless specially approved by the BHEL/OPTCL. All nuts shall be galvanised with the exception of the threads which shall be oiled. Surfaces which are in contact with oil shall not be galvanised or cadmium plated.

Partial immersion of the work will not be permitted and the galvanising tank must therefore be sufficiently large to permit galvanising to be carried out by one immersion.

Galvanising of wires shall be applied by the hot dip process and shall meet the requirements of IS 2141.

The minimum weight of the zinc coating and minimum thickness of coating for outdoor equipment shall be as follows:

a) For sections & plates above 5mm of thickness	910 gm/sq.m	127 microns
b) For sections & plates below 5mm of thickness	610 gm/sq.m	87 microns
c) For surfaces embedded in concrete	800 gm/sq.m.	

The galvanised surfaces shall consist of a continuous and uniform thick coating of zinc, firmly adhering to the surface of steel. The finished surface shall be clean and smooth and shall be free from defects such as discoloured patches, bare spots, unevenness of coating, spelter which is loosely attached to the steel globules, spiky deposits, blistered surface, flaking or peeling off, etc. The presence of any of these defects noticed on visual or microscopic inspection shall render the material liable to rejection.

After galvanising no drilling or welding shall be performed on the galvanised parts of the equipment excepting that nuts may be threaded after galvanising. Sodium dichromate treatment shall be provided to avoid formation of white rust after hot dip galvanisation.

The galvanised steel shall be subjected to six one minute dips in copper sulphate solution as per IS 2633.

PROJECT: 2X500 MVA, 400/220 KV GIS S/S AT ERSAMA & ASSOCIATED 2 NOS 400 KV BAY EXTN AT DUBURI	
CUSTOMER: ODISHA POWER TRANSMISSION CORPORATION LIMITED (OPTCL)	
Technical Specification	TB-4-420-316-xxx Rev 00
Section-3: Project Details and General Specification	

Sharp edges with radii less than 2.5 mm shall be able to withstand four immersions of the Standard Preece test. All other coatings shall withstand six immersions. The following galvanising tests should essentially be performed as per relevant Indian Standards.

- Coating thickness
- Uniformity of zinc
- Adhesion test
- Mass of zinc coating

Galvanised material must be transported properly to ensure that galvanised surfaces are not damaged during transit. Application of zinc rich paint at site shall not be allowed.

3.14 CLAMPS AND CONNECTORS INCLUDING TERMINAL CONNECTORS

The terminal connectors shall conform strictly to the requirements if the latest versions of following standards as amended up-to-date, except otherwise,

- | | | |
|------|----------|---|
| i) | IS: 5561 | Power Connectors |
| ii) | IS: 617 | Aluminium & Aluminium Alloy |
| iii) | IS: 2629 | Recommended Practice for HDG of iron & steel |
| iv) | IS: 2633 | Method of testing uniformity of coating of zinc coated articles |

The material of clamps and connectors shall be Aluminium alloy casting conforming to designation A6 of IS: 617 for connecting to equipment terminals and conductors of aluminium. In case the terminals are of copper, the same clamps/connectors shall be used with 4mm thick bimetallic liner.

The material of clamps and connectors shall be Galvanised mild steel for connecting to shield wire.

Bolts, nuts and plain washers shall be hot dip galvanised mild steel for sizes M12 and above. For sizes below M12, they shall be electro-galvanised mild steel. The spring washers shall be electro-galvanised mild steel.

All castings shall be free from blow holes, surface blisters, cracks and cavities. All sharp edges and corners shall be rounded off to meet specified corona and radio interference requirements.

They shall have same current rating as that of the connected equipment. All current carrying parts shall be at least 10 mm thick. The connectors shall be manufactured to have minimum contact resistance.

Flexible connectors, braids or laminated strips shall be made up of copper/aluminium.

Current rating and size of terminal/conductor for which connector is suitable shall be put on a suitable sticker on each component which should last at least till erection time.

3.15 CABLE GLANDS AND LUGS/FERRULES

Cable shall be terminated using double compression type cable glands. Testing requirements of Cable glands shall conform to BS:6121 and gland shall be of robust construction capable of clamping cable and cable armour (for armoured cables) firmly without injury to insulation. Cable glands shall be made of heavy duty brass machine finished and nickel chrome plated. Thickness of plating shall not be less than 10 micron. All washers and hardware shall also be made of brass with nickel chrome plating Rubber components shall be of neoprene or better synthetic material and of tested quality. Cable glands shall be suitable for the sizes of cable supplied/erected.

PROJECT: 2X500 MVA, 400/220 KV GIS S/S AT ERSAMA & ASSOCIATED 2 NOS 400 KV BAY EXTN AT DUBURI	
CUSTOMER: ODISHA POWER TRANSMISSION CORPORATION LIMITED (OPTCL)	
Technical Specification	TB-4-420-316-xxx Rev 00
Section-3: Project Details and General Specification	

Cable lugs/ferrules for power cables shall be tinned copper solderless crimping type suitable for aluminium compacted conductor cables. Cable lugs and ferrules for control cables shall be tinned copper type. The cable lugs for control cables shall be provided with insulating sleeve and shall suit the type of terminals provided on the equipment. Cable lugs and ferrule shall conform to DIN standards.

3.16 WIRING, CABLING AND CABLE INSTALLATION

3.16.1 Cubicle wiring

Panels shall be complete with interconnecting wiring between all electrical devices in the panels. External connections shall be achieved through terminal blocks. Where panels are required to be located adjacent to each other all inter panel wiring and connections between the panels shall be carried out internally. The Bidder shall furnish a detailed drawing of such inter panel wiring. The Bidder shall ensure the completeness and correctness of the internal wiring and the proper functioning of the connected equipment.

All wiring shall be carried out with 1.1 kV grade, PVC insulated, single core, stranded copper wires. The PVC shall have oxygen index not less than '29' and Temperature index not less than 250C. The wires shall have annealed copper conductors of adequate size comprise not less than three strands

The minimum cross sectional area of the stranded copper conductor used for internal wiring shall be as follows:

- All circuits excepting CT circuits and energy metering circuit of VT 2.5 sq.mm
- All CT circuits and metering circuit of VT 2.5 sq. mm

All internal wiring shall be supported, neatly arranged, readily accessible and connected to equipment terminals and terminal blocks. Wiring gutters and troughs shall be used for this purpose.

Cubicle connections shall be insulated with PVC to IEC 227. Wires shall not be jointed or teed between terminal points.

Bus wires shall be fully insulated and run separately from one another. Auxiliary bus wiring for AC and DC supplies, voltage transformer circuits, annunciation circuits and other common services shall be provided near the top of the panels running throughout the entire length of the panel suite. Longitudinal troughs extending throughout the full length of panel shall be preferred for inter panel wiring.

All inter connecting wires between adjacent panels shall be brought to a separate set of terminal blocks located near the slots of holes meant for the passage of the interconnecting wires. Interconnection of adjacent panels on site shall be straightforward and simple. The bus wires for this purposes shall be bunched properly inside each panel.

Wire termination shall be made with solderless crimping type and tinned copper lugs which firmly grip the conductor. Insulated sleeves shall be provided at all the wire terminations. Engraved core identification plastic ferrules marked to correspond with panel wiring diagram shall be fitted at both ends of each wire. Ferrules shall fit tightly on the wire and shall not fall off when the wire is disconnected from terminal blocks. Numbers 6 and 9 shall not be included for ferrules purposes unless the ferrules have numbers underscored to enable differentiation. (i.e. 6 and 9).

Fuses and links shall be provided to enable all circuits in a cubicle, except a lighting circuit, to be isolated from the bus wires.

The DC trip and AC voltage supplies and wiring to main protective gear shall be segregated from those for back-up protection and also from protective apparatus for special purposes. Each such group shall be fed through separate fuses from the bus wires. There shall not be more than one set of supplies to the apparatus comprising each group. All wires associated with the tripping circuits shall be provided with red ferrules marked "Trip".

It shall be possible to work on small wiring for maintenance or test purposes without making a switchboard dead.

The insulation material shall be suitably coloured in order to distinguish between the relevant phases of the circuit.

PROJECT: 2X500 MVA, 400/220 KV GIS S/S AT ERSAMA & ASSOCIATED 2 NOS 400 KV BAY EXTN AT DUBURI	
CUSTOMER: ODISHA POWER TRANSMISSION CORPORATION LIMITED (OPTCL)	
Technical Specification	TB-4-420-316-xxx Rev 00
Section-3: Project Details and General Specification	

When connections rated at 380 volt and above are taken through junction boxes they shall be adequately screened and "DANGER" notices shall be affixed to the outsides of junction boxes or marshalling kiosk. Where connections to other equipment and supervisory equipment are required the connections shall be grouped together.

3.16.2 LV power cabling

LVAC cable terminals shall be provided with adequately sized, hot pressed, cast or crimp type lugs. Where sweating sockets are provided they shall be without additional clamping or pinch bolts. Where crimp type lugs are provided they shall be applied with the correct tool and the crimping tool shall be checked regularly for correct calibration. Bi-metallic joints between the terminals and lugs shall be provided where necessary.

Terminals shall be marked with the phase colour in a clear and permanent manner.

A removable gland plate shall be provided by the Bidder. The Bidder shall be responsible for drilling the cable gland plate.

Armoured cables shall be provided with suitable glands for terminating the cable armour and shall be provided with an earthing ring and lug to facilitate connection of the gland to the earth bar.

3.17 PRODUCTION PROCESS REQUIREMENTS

3.17.1 CASTINGS

GENERAL

All castings shall be true to pattern, free from defects and of uniform quality and condition. The surfaces of castings which do not undergo machining, shall be free from foundry irregularities. The castings shall be subject to NDT, chemical, mechanical and metallographic tests. Details of the same shall be furnished to BHEL/OPTCL for review/approval. Magnetic particle inspection (MPI) test, wherever applicable, shall be carried out in longitudinal and transverse direction to detect radial and axial cracks.

IRON CASTINGS

Iron casting material shall be in accordance with ASTM A 126 Class B. A copy of the ladle analysis shall be sent to the BHEL/OPTCL. Each casting shall have a test bar from which tension test specimens may be taken. Test specimen shall be in accordance with ASTM A 370 and tested in accordance with ASTM E8. The Bidder shall submit his procedures for testing and acceptance for iron castings for approval by the BHEL/OPTCL.

STEEL CASTINGS

Steel castings shall be manufactured in accordance with ASTM A 27 and shall be subjected to appropriate tests and inspection as detailed herein.

Copies of mandatory documentation, such as ladle analyses and mechanical test results, shall be sent to the BHEL/OPTCL. (Non-ferrous casting material and castings shall be manufactured in accordance with the appropriate ASTM standards for the material concerned).

3.17.2 FORGINGS

When requested by the BHEL/OPTCL, forgings will be subjected to inspection in the regions of fillets and changes of section by suitable method. Magnetic particle, dye-penetration, radiographic or ultrasonic, or any combination of these methods may be used to suit material type and forging design.

The testing is to be carried out after the rough machining operation and is to be conducted according to the appropriate ASTM standards.

MPI test on forging shall be carried out to detect both radial and axial cracks. Ferrous forgings shall be demagnetised after such tests.

PROJECT: 2X500 MVA, 400/220 KV GIS S/S AT ERSAMA & ASSOCIATED 2 NOS 400 KV BAY EXTN AT DUBURI	
CUSTOMER: ODISHA POWER TRANSMISSION CORPORATION LIMITED (OPTCL)	
Technical Specification	TB-4-420-316-xxx Rev 00
Section-3: Project Details and General Specification	

Any indentations which prove to penetrate deeper than 2.5% of the finished thickness of the forging shall be reported to the BHEL/OPTCL giving location, length, width and depth. Any indentations which will not machine out during final machining shall be gouged out and repaired using an approved repair procedure. Repair of rotating elements by welding will only be accepted subject to detailed examination of the proposal by the BHEL/OPTCL prior to the repair being carried out. The forging shall be tested for mechanical and metallographic tests as per ASTM. The details shall be mutually discussed/agreed upon.

3.17.3 FABRICATED COMPONENTS

All components machined or fabricated from plate, sheet or bar stock shall meet the material requirements of ASTM or material specification approved by the BHEL/OPTCL.

Structural steel, rolled shapes, bars, etc. shall comply with the latest ASTM for A36.

Plate steel shall be of a designation and quality suitable for the function it is intended to perform. Insofar as it is compatible with its function, it shall comply with ASTM A283 structural quality.

All, or a representative number of such components, shall be subjected to one or more of the following tests: visual, dye penetration, magnetic particle (transverse and longitudinal), ultrasonic or radiographic. These tests shall be in accordance with the recommended practices of the ASTM. The terms of reference for acceptance shall be the applicable ASTM Specifications.

3.17.4 WELDING AND WELDERS QUALIFICATIONS

General

All welding shall be carried out by qualified welders only.

All welding shall be in accordance with the corresponding standards of the American Welding Society or the American Society of Mechanical Engineers.

Other standards to determine the quality of welding process and qualifications of welders may be considered, provided that sufficient information is first submitted for the approval of the BHEL/OPTCL.

Prior to the start of fabrication, the Bidder shall submit to the BHEL/OPTCL for approval, a description of each of the welding procedures which he proposes to adopt, together with certified copies of reports of the results from tests made in accordance with these procedures.

The Bidder shall be responsible for the quality of the work performed by his welding organisation. All welding operators, to be assigned work, including repair of casting, shall pass the required tests for qualification of welding procedures and operators. The BHEL/OPTCL reserves the right to witness the qualification tests for welding procedures and operators and the mechanical tests at the samples.

The Bidder shall bear all his own expenses in connection with the qualification tests. If the work of any operator at any time appears questionable, such operator will be required to pass appropriate prequalification tests as specified by the Inspector and at the expense of the Bidder.

Welding

All welding shall be performed in accordance with the appropriate standards. The design and construction of welded joints subject to hydraulic pressure shall conform to the applicable requirement of ASME "Boiler and Pressure Vessel Code" shall be qualified in accordance with Section IX of this Code. The design and construction of welded joints not subjected to hydraulic pressure shall, as a minimum, conform to the requirements of AWS "Specification for Welded Highway and Railway Bridge" D2.0. Except for minor parts and items specifically exempted from stress relieving, all shop welded joints shall be stress relieved in accordance with the requirements of the ASME "Boiler and Pressure Vessel Code" Section VIII. In addition to satisfying the procedural and quality requirements set forth in the applicable code and/or these Specifications, all welding shall meet the following requirements for workmanship and visual quality:

- Butt welds shall be slightly convex, of uniform height and shall have full penetration.
- Fillet welds shall be of the specified size, with full throat and legs of equal length.

PROJECT: 2X500 MVA, 400/220 KV GIS S/S AT ERSAMA & ASSOCIATED 2 NOS 400 KV BAY EXTN AT DUBURI	
CUSTOMER: ODISHA POWER TRANSMISSION CORPORATION LIMITED (OPTCL)	
Technical Specification	TB-4-420-316-xxx Rev 00
Section-3: Project Details and General Specification	

- Repairing, chipping and grinding of welds shall be done in a manner which will not gouge, groove or reduce the thickness of the base metal.
- The edges of the member to be joined shall expose sound metal, free from laminations, surface defects caused by shearing or flame-cutting operations or other injurious defects.

Welded joints subject to critical working stress shall be tested by approved methods of non-destructive testing, such as radiographic and ultrasonic examination, magnetic particle and liquid penetration inspection. All expenses in connection with these tests shall be borne by the Bidder. The extent of testing shall be as stipulated by the ASME „Boiler and Pressure Vessel Code”, Section VIII, but without prejudice to the rights of the Inspector or the BHEL/OPTCL to ask for additional tests,

The arc-welding process to be used and the welding qualifications of the welders employed on the work shall be used in accordance with AWS requirements and Section VIII and IX of the ASME (American Society of Mechanical Engineers) Code, latest edition, as they may apply. All welding rods shall conform to the requirements of the latest issue of Section It, part C of the ASME Code.

Gas shielded welding (TIG or MIG) used as appropriate for aluminium, stainless steel or other material shall be carried out in accordance with the best commercial practice and the following standard specifications:

- Specifications for copper and copper-alloy welding rods (AWS A5.7, ASTM B259)
- Specification for corrosion-resisting chromium and chromium-nickel steel welding rods and bare electrodes (AWS A5.9, ASTM A371)
- Specifications for aluminium and aluminium alloy rods and bare electrodes (AWS A5.10, ASTM B285).
- Specifications for nickel and nickel-base alloy bare welding filler metal (AWS A5.14, ASTM B304).

Gas welding will not normally be used in the equipment. When a particular equipment manufacture requires the use of gas welding, the proposed process and the welder’s qualification shall be in accordance with AWS B3.0.

Welding of galvanised components will not be allowed in the equipment.

Strict measures of quality control shall be exercised throughout the Equipment/ Works. The BHEL/OPTCL may call for an adequate NDT test of the work of any operator, who in his opinion is not maintaining the standard of workmanship. Should this NDT test prove defective, all work done by that operator, since his last test shall be tested at the Bidder’s expense. If three or more of these tests prove defective, the operator shall be removed from the project.

A procedure for the repair of defects shall be submitted to the BHEL/OPTCL for his approval prior to any repairs being made.

Welding of pipes

Before welding, the ends shall be cleaned by wire brushing, filing or machine grinding. Each weld-run shall be cleaned of slag before the next run is deposited.

Welding at any joint shall be completed uninterrupted. If this cannot be followed for some reason, the weld shall be insulated for slow and uniform cooling.

Welding shall be done by manual oxy-acetylene or manual shielded metal arc process. Automatic or semi-automatic welding processes may be done only with the specific approval of BHEL/OPTCL.

As far as possible welding shall be carried out in flat position. If not possible, welding shall be done in a position as close to flat position as possible.

Downward technique is not allowed while welding pipes in horizontal position, unless permitted by the BHEL/OPTCL.

Combination of welding processes or usage of electrodes of different classes or makes in a particular joint shall be allowed only after the welding procedure has been duly qualified and approved by the BHEL/OPTCL.

No backing ring shall be used for circumferential butt welds.

Welding carried out in ambient temperature of 5C or below shall be heat treated.

PROJECT: 2X500 MVA, 400/220 KV GIS S/S AT ERSAMA & ASSOCIATED 2 NOS 400 KV BAY EXTN AT DUBURI	
CUSTOMER: ODISHA POWER TRANSMISSION CORPORATION LIMITED (OPTCL)	
Technical Specification	TB-4-420-316-xxx Rev 00
Section-3: Project Details and General Specification	

A spacer wire of proper diameter may be used for weld root opening but must be removed after tack welding and before applying root run.

Tack welding for the alignment of pipe joints shall be done only by qualified welders. Since tack welds form part of final welding, they shall be executed carefully and shall be free from defects. Defective welds shall be removed prior to the welding of joints.

Electrodes size for tack welding shall be selected depending upon the root opening.

Tack welds should be equally spaced.

Root run shall be made with respective electrodes/filler wires. The size of the electrodes shall not be greater than 3.25 mm (10 SWG) and should preferably be 2.3 mm (12 SWG). Welding shall be done with direct current values recommended by the electrode manufacturers.

Upward technique shall be adopted for welding pipes in horizontally fixed position. For pipes with wall thickness less than 3 mm, oxyacetylene welding is recommended.

The root run of butt joints shall be such as to achieve full penetration with the complete fusion of root edges. The weld projection shall not exceed 3 mm inside the pipe.

On completion of each run craters, weld irregularities, slag etc. shall be removed by grinding or chipping. During the process of welding, all movements, shocks, vibration or stresses shall be carefully avoided in order to prevent weld cracks.

Fillet welds shall be made by shielded metal arc process regardless of thickness and class of piping. Electrode size shall not exceed 10 SWG. (3.25 mm). At least two runs shall be made on socket weld joints.

3.18 QUALITY ASSURANCE

3.18.1 GENERAL

To ensure that the supply and services under the scope of this Contract, whether manufactured or performed within the Bidder's works or at his Sub-Bidder's premises or at Site or at any other place of work are in accordance with the Specification, with the Regulations and with relevant Indian or otherwise Authorized Standards the Bidder shall adopt suitable Quality Assurance Programs and Procedures to ensure that all activities are being controlled as necessary.

The quality assurance arrangements shall conform to the relevant requirements of ISO 9001 or ISO 9002 as appropriate.

Manufacturing Quality Plan will detail out for all the components and equipment, various tests/inspection, to be carried out as per the requirements of this specification and standards mentioned therein and quality practices and procedures followed by Bidder's/ Sub-bidder's/ sub-supplier's Quality Control Organisation, the relevant reference documents and standards, acceptance norms, inspection documents raised etc., during all stages of materials procurement, manufacture, assembly and final testing/performance testing. The Quality Plan shall be submitted on electronic media e.g. E-mail in addition to hard copy, for review. Once the same is finalised, hard copies shall be submitted for approval. After approval the same shall be submitted in compiled form on CD ROM.

The Bidder shall also furnish copies of the reference documents/plant standards/acceptance norms/tests and inspection procedure etc., as referred in Quality Plans along with Quality Plans. These Quality Plans and reference documents/standards etc. will be subject to Employer's approval without which manufacturer shall not proceed.

These approved documents shall form a part of the contract. In these approved Quality Plans, Employer shall identify customer hold points (CHP), i.e. test/checks which shall be carried out in presence of the Employer's Project Manager or his authorised representative and beyond which the work will not proceed without consent of Employer/Authorised representative in writing. All deviations to this specification,

PROJECT: 2X500 MVA, 400/220 KV GIS S/S AT ERSAMA & ASSOCIATED 2 NOS 400 KV BAY EXTN AT DUBURI	
CUSTOMER: ODISHA POWER TRANSMISSION CORPORATION LIMITED (OPTCL)	
Technical Specification	TB-4-420-316-xxx Rev 00
Section-3: Project Details and General Specification	

approved quality plans and applicable standards must be documented and referred to Employer along with technical justification for approval and dispositioning.

No material shall be despatched from the manufacturer's works before the same is accepted subsequent to pre-despatch final inspection including verification of records of all previous tests/inspections by Employer's Project Manager/Authorised representative and duly authorised for despatch by issuance of Material Dispatch Clearance Certificate (MDCC).

All material used for equipment manufacture including casting and forging etc. shall be of tested quality as per relevant codes/standards. Details of results of the tests conducted to determine the mechanical properties, chemical analysis and details of heat treatment procedure recommended and actually followed shall be recorded on certificates and time temperature chart. Tests shall be carried out as per applicable material standards and/or agreed details.

For all spares and replacement items, the quality requirements as agreed for the main equipment supply shall be applicable.

Repair/rectification procedures to be adopted to make the job acceptable shall be subject to the approval of the Employer/ authorised representative.

3.18.2 SUB-VENDOR

The Bidder shall ensure that the Quality Assurance requirements of this Specification are followed by any sub-vendor appointed by him under the Contract.

The Bidder shall assess the sub-vendor's Quality Assurance arrangements prior to his appointment to ensure its compliance with the appropriate ISO 9000 standard and the Specification.

Auditing of the sub-vendor's Quality Assurance arrangements shall be carried out by the Bidder and recorded in such a manner that demonstrates to the OPTCL/BHEL the extent of the audits and their effectiveness.

3.18.3 QUALITY ASSURANCE DOCUMENTS

The Bidder shall be required to submit two hard copies and two sets on CDROM of the following Quality Assurance Documents as identified in respective quality plan with tick (v) mark.

Each QA Documentation shall have a project specific Cover Sheet bearing name & identification number of equipment and including an index of its contents with page control on each document.

The QA Documentation file shall be progressively completed by the Supplier's sub-supplier to allow regular reviews by all parties during the manufacturing.

The final quality document will be compiled and issued at the final assembly place of equipment before dispatch. However CD-Rom may be issued not later than three weeks.

Typical contents of Quality Assurance Document are as below:-

- i) Quality Plan,
- ii) Material mill test reports on components as specified by the specification and approved Quality Plans.
- iii) Manufacturer / works test reports/results for testing required as per applicable codes and standard referred in the specification and approved Quality Plans.

PROJECT: 2X500 MVA, 400/220 KV GIS S/S AT ERSAMA & ASSOCIATED 2 NOS 400 KV BAY EXTN AT DUBURI	
CUSTOMER: ODISHA POWER TRANSMISSION CORPORATION LIMITED (OPTCL)	
Technical Specification	TB-4-420-316-xxx Rev 00
Section-3: Project Details and General Specification	

- iv) Non-destructive examination results /reports including radiography interpretation reports. Sketches/drawings used for indicating the method of traceability of the radiographs to the location on the equipment.
- v) Heat Treatment Certificate/Record (Time- temperature Chart)
- vi) All the accepted Non-conformance Reports (Major/Minor) / deviation, including complete technical details / repair procedure).
- vii) CHP / Inspection reports duly signed by the Inspector of the Employer and Bidder for the agreed Customer Hold Points.
- viii) Certificate of Conformance (COC) whoever applicable.
- ix) MDCC

Before dispatch/ commissioning of any equipment, the Supplier shall make sure that the corresponding quality document or in the case of protracted phased deliveries, the applicable section of the quality document file is completed. The supplier will then notify the Inspector regarding the readiness of the quality document (or applicable section) for review.

- i) If the result of the review carried out by the Inspector of the Quality document (or applicable section) is satisfactory, the Inspector shall stamp the quality document (or applicable section) for release.
- ii) If the quality document is unsatisfactory, the Supplier shall endeavour to correct the incompleteness, thus allowing to finalize the quality document (or applicable section) by time compatible with the requirements as per contract documents. When it is done, the quality document (or applicable section) is stamped by the Inspector.
- iii) If a decision is made for dispatch, whereas all outstanding actions cannot be readily cleared for the release of the quality document by that time, the supplier shall immediately, upon shipment of the equipment, send a copy of the quality document Review Status signed by the Supplier Representative to the Inspector and notify of the committed date for the completion of all outstanding actions & submission. The Inspector shall stamp the quality document for applicable section when it is effectively completed. The submission of QA documentation package shall not be later than 3 weeks after the dispatch of equipment.

3.18.4 TRANSMISSION OF QUALITY DOCUMENTS

As a general rule, two hard copies of the quality document and Two CD ROMs shall be issued to the Employer on release of QA Documentation by Inspector. One set of quality document shall be forwarded to Corporate Quality Assurance Department and other set to respective Site.

For the particular case of phased deliveries, the complete quality document to the Employer shall be issued not later than 3 weeks after the date of the last delivery similarly as stated above.

3.18.5 INSPECTION, TESTING & INSPECTION CERTIFICATE

- i. The word 'Inspector' shall mean the Project Manager and/or his authorised representative and/or an outside inspection agency acting on behalf of the Employer to inspect and examine the materials and workmanship of the works during its manufacture or erection.
- ii. The Project Manager or his duly authorised representative and/or an outside inspection agency acting on behalf of the Employer shall have access at all reasonable times to inspect and examine the materials and workmanship of the works during its manufacture or erection and if part of the works is being manufactured or assembled on other premises or works, the Bidder shall obtain for the Project Manager and for his duly authorised representative permission to inspect as if the works were manufactured or assembled on the Bidder's own premises or works.

PROJECT: 2X500 MVA, 400/220 KV GIS S/S AT ERSAMA & ASSOCIATED 2 NOS 400 KV BAY EXTN AT DUBURI	
CUSTOMER: ODISHA POWER TRANSMISSION CORPORATION LIMITED (OPTCL)	
Technical Specification	TB-4-420-316-xxx Rev 00
Section-3: Project Details and General Specification	

- iii. The Bidder shall give the Project Manager/Inspector fifteen (15) days written notice of any material being ready for testing. Such tests shall be to the Bidder's account except for the expenses of the Inspector's. The Project Manager/Inspector, unless the witnessing of the tests is virtually waived and confirmed in writing, will attend such tests within fifteen (15) days of the date on which the equipment is noticed as being ready for test/inspection failing which the Bidder may proceed with test which shall be deemed to have been made in the inspector's presence and he shall forthwith forward to the inspector duly certified copies of test reports in two (2) copies.
- iv. The Project Manager or Inspector shall within fifteen (15) days from the date of inspection as defined herein give notice in writing to the Bidder, or any objection to any drawings and all or any equipment and workmanship which is in his opinion not in accordance with the contract. The Bidder shall give due consideration to such objections and shall either make modifications that may be necessary to meet the said objections or shall inform in writing to the Project Manager/Inspector giving reasons therein, that no modifications are necessary to comply with the contract.
- v. When the factory tests have been completed at the Bidder's or sub-bidder's works, the Project Manager /Inspector shall issue a certificate to this effect fifteen (15) days after completion of tests but if the tests are not witnessed by the Project Manager /Inspectors, the certificate shall be issued within fifteen (15) days of the receipt of the Bidder's test certificate by the Project Manager /Inspector. Project Manager /Inspector to issue such a certificate shall not prevent the Bidder from proceeding with the works. The completion of these tests or the issue of the certificates shall not bind the Employer to accept the equipment should it, on further tests after erection be found not to comply with the contract.
- vi. In all cases where the contract provides for tests whether at the premises or works of the Bidder or any sub-bidder, the Bidder, except where otherwise specified shall provide free of charge such items as labour, material, electricity, fuel, water, stores, apparatus and instruments as may be reasonably demanded by the Project Manager /Inspector or his authorised representatives to carry out effectively such tests on the equipment in accordance with the Bidder and shall give facilities to the Project Manager/Inspector or to his authorised representative to accomplish testing.
- vii. The inspection by Project Manager / Inspector and issue of Inspection Certificate thereon shall in no way limit the liabilities and responsibilities of the Bidder in respect of the agreed Quality Assurance Programme forming a part of the contract.
- viii. To facilitate advance planning of inspection in addition to giving inspection notice, the Bidder shall furnish quarterly inspection programme indicating schedule dates of inspection at Customer Hold Point and final inspection stages. Updated quarterly inspection plans will be made for each three consecutive months and shall be furnished before beginning of each calendar month.
- ix. All inspection, measuring and test equipment used by bidder shall be calibrated periodically depending on its use and criticality of the test/measurement to be done. The Bidder shall maintain all the relevant records of periodic calibration and instrument identification, and shall produce the same for inspection by NTPC. Wherever asked specifically, the bidder shall re-calibrate the measuring/test equipment in the presence of Project Manager / Inspector.

3.19 TYPE, ROUTINE & ACCEPTANCE TESTS:

The Bidder shall carry out the tests stated in accordance with the conditions of this Specification, without extra charge for such additional tests as in the opinion of the BHEL/OPTCL are necessary to determine that the Contract Works comply with this Specification. The tests shall be carried out generally in accordance

PROJECT: 2X500 MVA, 400/220 KV GIS S/S AT ERSAMA & ASSOCIATED 2 NOS 400 KV BAY EXTN AT DUBURI	
CUSTOMER: ODISHA POWER TRANSMISSION CORPORATION LIMITED (OPTCL)	
Technical Specification	TB-4-420-316-xxx Rev 00
Section-3: Project Details and General Specification	

with the relevant IEC"s or IS or equivalent standards. The specific details of testing and inspection are given in the appropriate section of this Specification.

The Bidder shall submit Type Test Reports for all equipment being supplied by him for the BHEL/OPTCL"s approval. The BHEL/OPTCL may also give instruction to carry out Type Tests, routine tests or acceptance tests. Type Test Charges shall be paid as per the rates indicated in the Price Schedules.

All materials used shall be subjected to such routine tests as are customary in the manufacture of the types of plant included in the Contract Works. These materials shall withstand satisfactorily all such tests.

All tests shall be carried out to the satisfaction of the BHEL/OPTCL, in his presence, at such reasonable times as he may require, unless agreed otherwise. Not less than three weeks' notice of all tests shall be given to the BHEL/OPTCL in order that he may be represented if he so desires. As many tests as possible shall be arranged together. Six copies of the Bidder"s test reports and test sheets shall be supplied to the BHEL/OPTCL for approval.

Measuring apparatus shall be approved by the OPTCL/BHEL (Divisional Engr) and if required shall be calibrated at the expense of the Bidder at an approved laboratory.

The Bidder shall be responsible for the proper testing of the work completed or plant or materials supplied by a sub-bidder to the same extent as if the work, plant or materials were completed or supplied by the Bidder himself.

All apparatus, instruments and connections required for the above tests shall be provided by the Bidder, but the BHEL/OPTCL may permit the use for the tests on site, any instruments and apparatus which may be provided permanently on site as part of the contract works conditional upon the Bidder accepting liability for any damage which may be sustained by such equipment during the test.

The bidder shall supply suitable test pieces of all materials as required by the BHEL/OPTCL. If required by the BHEL/OPTCL, test specimens shall be prepared for check testing and forwarded at the expense of the Bidder to an independent testing authority selected by the BHEL/OPTCL.

Any costs incurred by the Employer in connection with inspection and re-testing as a result of a failure of the subject under test, or damage during transport, or erection on site before take-over by the Employer, shall be to the account of the Bidder.

No inspection or lack of inspection or passing by the BHEL/OPTCL of work, plant or materials, whether carried out or supplied by the Bidder or sub-bidder, shall relieve the Bidder from his liability to complete the Contract Works in accordance with the Contract or exonerate him from any of his guarantees.

3.20.1 TYPE TEST REQUIREMENTS FOR EQUIPMENTS OTHER THAN GIS

- a) All equipment to be supplied shall be of type tested design. During detail engineering, the bidder shall submit for Owner's approval the reports of all the type tests as listed in this specification and carried out not earlier than ten years prior to the date of techno-commercial bid opening (03-March-2017). These reports should be for the test conducted on the equipment similar to those proposed to be supplied under this contract and the test(s) should have been either conducted at an independent laboratory or should have been witnessed by a Client.
- b) However if bidder is not able to submit report of the type test(s) conducted not earlier than ten years prior to the date of techno-commercial bid opening (**11-February-2022**), or in the case of type test report(s) are not found to be meeting the specification requirements, the bidder shall conduct all such

PROJECT: 2X500 MVA, 400/220 KV GIS S/S AT ERSAMA & ASSOCIATED 2 NOS 400 KV BAY EXTN AT DUBURI	
CUSTOMER: ODISHA POWER TRANSMISSION CORPORATION LIMITED (OPTCL)	
Technical Specification	TB-4-420-316-xxx Rev 00
Section-3: Project Details and General Specification	

- tests under this contract at no additional cost to the owner either at third party lab or in presence of client/ owners representative and submit the reports for approval.
- c) All acceptance and routine tests as per the specification and relevant standards shall be carried out. Charges for these shall be deemed to be included in the equipment price.

3.20 PACKAGING & TRANSPORTATION

The Bidder shall be responsible for the packing, loading and transport of the plant and equipment from the place of manufacture, whether this is at his own works or those of any Bidder, to Site, and for off-loading at site.

All apparatus and equipment shall be carefully packed for transport by air, sea, rail and road as necessary and in such a manner that it is protected against tropical climate conditions and transport in rough terrain and cross country road conditions. The method of packing shall provide complete protection to all apparatus and equipment during transport and storage at site in heavy rain. The method of packing shall provide adequate protection to main items of plant and those parts contained within and attached without, for transportation.

Precautions shall be taken to protect parts containing electrical insulation against the ingress of moisture. All bright parts liable to rust shall receive a coat of anti-rusting composition and shall be suitably protected. The machined face of all flanges shall be protected by means of a blank disc bolted to each face.

Where appropriate all parts shall be boxed in substantial crates or containers to facilitate handling in a safe and secure manner. Each crate or container shall be marked clearly on the outside of the case to show "TOP" and "BOTTOM" positions with appropriate signs, and where the mass is bearing and the correct position for slings. Each crate or container shall also be marked with the notation of the part or parts contained therein, contract number and port of destination. It shall be the Bidder's responsibility to dispose of all such packing.

Any damage due to defective or insufficient packing shall be made good by the Bidder at his own expense and within reasonable time when called upon by the BHEL/OPTCL to do so. Four (4) copies of complete packing lists showing the number, size, marks, mass and contents of each package shall be delivered to the BHEL/OPTCL immediately the material is despatched.

The Bidder shall inform himself fully as to all relevant transport facilities and requirements and loading gauges and ensure that the equipment as packed for transport shall conform to these limitations. The Bidder shall also be responsible for verifying the access facilities specified.

The Bidder shall be responsible for all costs of repair or replacement of the equipment, including those incurred by the Employer, arising from damage during transport, off-loading or erection on site, until take-over by the Employer.

The Bidder shall be responsible for the transportation of all loads associated with the contract works and shall take all reasonable steps to prevent any highways or bridges from being damaged by his traffic and shall select routes, choose and use vehicles and restrict and distribute loads so that the risk of damage shall be avoided. The Bidder shall immediately report to the BHEL/OPTCL any claims made against the Bidder arising out of alleged damage to a highway or bridge.

3.21 ENCLOSURES:

1. ANNEXURE – A: SPECIFICATION FOR ELECTRICAL COMPONENTS

NOTE:

Contractor is to be replaced with subcontractor/vendor.

1. MOTORS

1.1 General

All motors shall comply with IEC 34 / IS 335 and dimensions with IEC 72, however they shall be capable of operating continuously under actual service conditions without exceeding the specified temperature rises, determined by resistance, at any frequency between 48 and 51.5 Hertz together with any voltage between ± 10 per cent of the nominal value.

All motors shall be totally enclosed, and if situated in the open they shall be weatherproof and suitable for outdoor working. They shall be provided with a suitable means of drainage to prevent accumulation of water due to condensation and with suitable means of breathing.

Motors operating in an ambient temperature not exceeding 40°C shall have insulation to at least Class B and preferably Class F standards. The temperature rise shall be restricted to that associated with Class B insulation. Where the motor may be appreciably affected by conducted heat the class of insulation shall be to approval.

All motors shall be suitable for direct starting at full voltage.

Motors shall have sealed ball or roller bearings.

The three line connections of AC motors shall be brought out to a terminal box. The terminal arrangement shall be suitable for the reception of aluminium cable. Terminal markings shall be made in a clear and permanent manner and shall comply with IEC 34. A permanently attached diagram or instruction sheet shall be provided giving the connections for the required direction of rotation. All terminal boxes shall be of the totally enclosed type designed to exclude the entry of dust and moisture and sealed from the internal air circuit of the motor. All joints shall be flanged with gaskets of neoprene or other approved material. Natural rubber insulation shall not be used.

Motors rated above 1 kW shall be three phase motors. Where single phase motors are employed the motors shall be grouped so as to form an approximately balanced three phase load.

1.2 Motor control gear

Control gear shall comply with the requirements of IEC 292, the control gear being rated according to the duty imposed by the particular application.

Motor contactors shall comply with IEC 158 class of intermittent duty 0-3 with type 52 enclosure protection. Apparatus shall be capable of switching the stalled current, and shall have a continuous current rating of at least 50 per cent greater than the full load current of the motors they control.

The operating currents of overload trips fitted to motor contactors shall be substantially independent of ambient temperature conditions, including the effect of direct sunlight on the enclosure in which the contactors are installed.

Where small motors are connected in groups, the group protection shall be arranged so that it will operate satisfactorily in the event of a fault occurring on a single motor. The control and protection equipment shall be accommodated in the control cabinet or marshalling kiosk.

Each motor or group of motors shall be provided with control gear for starting and stopping by hand and automatically. Overload and single-phasing protection shall be provided.

2.0 CABLE BOXES

Cable boxes shall be suitable for cables entering from above or below as may be required. They shall be weatherproof, rodent and insect-proof and be complete with all gaskets, compression glands, wiping glands and all associated fittings as may be required to make-off the cables.

Gland plates shall be insulated from the cable boxes and, in the case of single core cables, shall be of non-magnetic or insulating material. If metallic gland plates are used, single core cable glands shall be insulated from the gland plate. Gland plate insulation shall be capable of withstanding a dry high voltage test of 2000volts ac for one minute.

Where cable boxes are provided for three core cables, the sockets on the outer phases shall be inclined towards the centre to minimise opening of the cable cores. Cable sockets shall be supplied under this Contract.

Cable boxes for voltages up to and including 11kV shall be suitable for PVC or XLPE insulated steel wire-armoured PVC served cables. The boxes shall be air insulated and designed to accommodate all the fittings required by the cable manufacturer. Front covers and gland plates shall be removable and a 12mm diameter breathing hole covered with a wire gauze shall be provided.

Cable boxes shall be capable of withstanding on site the cable high voltage test level in accordance with IEC 502.

The drilling of gland plates, supply and fitting of compression glands and connecting up of power cables not included in the Contract scope of work shall be carried out under a separate contract.

Connection of the power cables included in the Contract scope of works shall be carried out under this Contract.

3.0 TERMINAL BOARDS AND TERMINAL BLOCKS

Terminal boards shall be of good quality non-flammable insulating material with a comparative tracking index (CTI) of not less than 500 to IEC112.

Terminal boards shall be spaced not less than 150 mm apart. For relay panels, they shall be mounted at the sides of the cubicle, and set obliquely towards the rear doors to give easy access to termination and to enable ferrule numbers to be read without difficulty.

Studs of stud type terminal boards shall be locked in the base to prevent turning and all connections shall be made on the front of the terminal board using lock nuts or lock washers. Where crimped type termination are provided at least two sets of crimping tools for each size of crimp must be supplied for each installation.

Terminals shall be of the insertion clamp type incorporating captive pressure screws which do not bear directly on the wire but on a serrated clamping plate. The pressure screws shall have an inherent locking feature.

Where connections are to be made between multi-core cables and telephone type multi-pair cables, the terminal blocks shall be of the insulation displacement type and shall have a withdrawable insulated link in order to facilitate isolation (or busy out in the case of the apparatus associated with the telephone system) of the individual circuits. These terminals shall also be provided with facilities for the insertion of test probes on both sides of the link.

All terminations shall be numbered for identification and grouped according to function. Engraved white on black labels shall be provided on the terminal blocks.

Terminals for connections which exceed 110 Volts shall be separated from those of other circuits and shall be fitted with insulating screens and "DANGER" notices.

The use of terminal blocks as junction points for wires which are not required in the associated cubicle shall be avoided wherever practicable.

All termination racks shall have a minimum of 20 per cent spare terminals blocks. At least 20% spare terminals shall be provided on each panel and these spare terminals shall be uniformly distributed on all terminal blocks.

All internal wiring to be connected to external equipments shall terminate on terminal blocks, preferably vertically mounted on the side of each panel. Terminal blocks shall be 650 V grade and have

10A continuous rating. Terminal blocks shall be moulded in one piece, complete with insulated barriers, stud type terminals, washers, nuts and lock nuts. Terminal blocks shall include a white fibre marking strip with clear plastic, slip-on/clip-on terminal covers. Markings on the terminal strips shall correspond to terminal numbers on the wiring diagrams.

Terminal blocks for current transformer and voltage transformer secondary leads shall be provided with test links and isolating facilities. Current transformer secondary leads shall be provided with short circuiting and earthing facilities.

All terminal blocks shall be suitable for terminating on each side, two by 2.5 mm² standard copper conductors.

Wherever duplication of a terminal block is necessary it shall be achieved by solid bonding links.

Unless otherwise specified, terminal blocks shall be suitable for connecting the following conductors on each side :

- All CT and VT circuits : Minimum of two 2.5 mm² copper stranded.
- AC/DC power supply circuits : One 16 mm² aluminium.
- All other circuits : Minimum of one of 2.5 mm² copper stranded

There shall be a minimum clearance of 250 mm between the first row of terminal blocks and the associated cable gland plate or panel side wall, as per the terminal block mounting arrangement adopted. Also the clearance between the edges of two rows of terminal blocks shall be minimum of 150 mm.

Arrangement of the terminal block assemblies and the wiring channel within the enclosure shall be such that a row of terminal blocks is run in parallel and close proximity along each side of the wiring duct to provide for convenient attachment of internal panel wiring. The side of the terminal blocks opposite the wiring duct shall be reserved for external cable connections. All adjacent terminal blocks shall also share this field wiring corridor. All wiring shall be provided with adequate support inside the panels to hold it firmly and to enable free and flexible termination without causing strain on terminals.

All necessary cable terminating accessories such as gland plates, supporting clamps and brackets, wiring troughs and gutters etc. including glands and lugs for cable shall be in bidders scope of supply.

4.0 FUSES AND LINKS

Carriers and bases for fuses and links shall be in accordance with IEC 269 and colour coded to permit identification of the circuit rating.

The fuses and links mounted in cubicles for tripping circuits and protective gear test links shall be mounted on the front of the panel. Other links and fuses shall be accommodated within the cubicle or above the cubicle doors. Fuses and links shall be grouped and spaced according to their function in order to facilitate identification.

All incoming circuits in which the voltage exceeds 125V shall be fed through insulated fuses and/or links, the supplies being connected to the bottom terminal. The contacts of the fixed portion of the fuse or link shall be shrouded so that accidental contact with live metal cannot be made when the moving portion is withdrawn.

Main supply fuse links shall be of the high rupturing capacity cartridge type.

Where fuse carriers are mounted vertically the incoming (supply) side shall be the bottom terminal.

Where either fuses or circuit breakers are used it should be ensured that proper discrimination between main and sub-circuits is maintained.

5.0 COMMUNICATIONS CABLES

All cables and wiring shall have copper conductors and PVC insulation and shall comply with IEC 227. Telephone type cables shall comply with IEC 96 and IEC 189.

Cabling and wiring installations shall be arranged to minimise the risk of fire and damage which may be caused in the event of fire.

For telephone type cables conductor wires with a cross sectional area of less than 0.2 mm² shall not be used. Where twin or quad make up is required in any cable the cores shall be uniformly twisted and the lays arranged such that crosstalk is reduced to a minimum.

No conductor smaller than 32/0.2mm (1mm²), or having less than three strands shall be used for interconnecting cabling except in the case of telephone cables. All cables shall have insulation which will withstand the highest temperature to be experienced in service.

Each conductor of a multi-core cable shall be readily identified by a numbered marker tape or, in the case of telephone type cables, colour coded insulation.

The Bidder shall submit full details of all loading on cables and in the case of interposing current transformer connections, the loop resistance of each circuit.

Apparatus cubicles, cabinets, racks and panels shall be provided with gland plates and all necessary equipment for the termination of cables. The Contract Works shall include for the checking, termination and ferruling of the cable cores and their lacing into cable forms and connection to the equipment terminal boards or tag blocks using claw washers. Crimping ferrules shall be used for each conductor.

6.0 MARSHALLING KIOSKS AND CONTROL CABINETS

The bidder shall provide within every bay of the switch yard a bay marshalling kiosk to which all incoming and outgoing connections to and from the associated bay equipment will be run. The terminal blocks within the kiosks shall be grouped together by function and shall be properly labelled and segregated. Transformer and circuit breaker control/marshalling kiosks will be provided under a separate contract, but it shall be the contractor's responsibility to cable up to the control/marshalling kiosks as provided by the transformer and circuit breaker suppliers. The Contractor shall provide a separate stand alone kiosk for busbar protection CT marshalling and the kiosk shall house the CT shorting and switching relays required for the correct function of the busbar protection scheme.

All outdoor cabinets and kiosks shall be protected in accordance with Class IP55 of IEC 947-1 and shall be insect and rodent proof. The minimum sheet steel thickness for all cubicles, kiosks and panels shall be not less than 2 mm cold rolled or 2.5 mm hot rolled sheet steel. The top of the outdoor boxes/kiosks shall be provided with Aluminium alloy sheets having 2 mm thick with proper sloping for easy discharge of water.

Anti-condensation heaters, 240V AC single phase, shall be provided and shall be controlled by a watertight switch mounted externally. Ventilation louvres shall be provided, suitably lined internally with a mesh screen, and divisions between compartments shall be perforated.

Control cabinets shall be illuminated with a switch operated and fused 240V CFL tube. Control cabinets shall be provided with a switch operated single phase 240V 15A power socket.

All cables shall enter cabinets and kiosks at the base.

Each compartment of all kiosks and cabinets shall be provided with access doors at the front and rear. Doors and access covers shall not be secured by nuts and bolts but shall be fastened with integral handles with provision for locking with a padlock.

Doors for kiosks shall be of the lift off and hinged type and shall be provided with glazed windows of adequate size to facilitate reading of indicators from outside the kiosk. Facilities shall be provided to permit removal of the temperature indicators without the need to pass the capillary tubing and bulb through the various compartments.

Doors and covers under 15kg mass may be of the slide on pattern, but above this mass hinged doors shall be used. Door shall be provided with padlocking facilities.

When three phase connections rated at 380V and above are taken through cabinets or kiosks, the terminal blocks shall be adequately screened, insulated and suitably marked with the phase colour; "DANGER" notices shall be affixed to the terminal blocks and a DANGER notice stating the voltage shall be fixed on the inside and outside of the kiosk or cabinet. Exterior DANGER notices shall be stove enamelled and shall be written in English and Oriya and shall be of an approved class/grade.

A durable copy of the circuit wiring diagram shall be affixed to the back of the kiosk door and labels shall be provided inside each kiosk or box to describe the functions of the various items of equipment.

When the marshalling kiosks are positioned in side the switchyard , flood water shall not ingress in to the marshalling kisok. The contractor/bidder may achieve the same either positioning the marshalling kiosk appropriately or providing adequate water proof arrangement.

CT, CVT & IVT outdoor kiosks shall be of Aluminium alloy sheets having 3mm thickness. It shall have proper slop canopy for easy drainage of water.

7.0 AUXILIARY SWITCHES

With each disconnecter, contactor and earthing device, there shall be supplied all necessary auxiliary switches and mechanisms for indication, protection, control, interlocking, supervisory and other services as specified. Not less than four spare auxiliary switches of each type shall be provided.

All auxiliary switches shall be wired up to a suitable terminal board on the fixed portion of the switchgear whether they are in use or not in the first instance, and shall be arranged in the same sequence on all similar items of equipment. Switches shall be provided to interrupt the supply of current to the tripping mechanism of the circuit breakers and latched contactors. All such switches and mechanisms shall be mounted in accessible positions clear of the operating mechanism, and shall be adequately protected.

The contacts of all auxiliary switches shall be strong and be capable of adjustment in relation to the movement of the circuit breaker or other item of equipment. Auxiliary switches and auxiliary circuits shall be capable of carrying a continuous current of 10 Amps.

8.0 MINIATURE OR MOULDED CASE CIRCUIT BREAKERS

Miniature or moulded case circuit breakers (MCB's or MCCB's) shall be designed and tested in accordance with IEC 157 and supplementary requirements of this specification. They shall be suitable for use over the full range of expected voltage variation as specified in the Schedules.

MCB's and MCCB's shall be suitably rated for both the continuous and short circuit loading of the circuits they are protecting under all service and atmospheric conditions stated in the specification. The bidder shall ensure that correct discrimination is maintained between main and sub-circuits.

For three phase circuits, the miniature circuit breakers shall be of the three pole type; for single phase circuits they shall be of the single pole type and for dc circuits they shall be of the double pole type.

Where miniature circuit breakers are used in circuits containing inductive loads, e.g. operating coils, it is essential that they are suitable for satisfactory operation in the circuit in which they are used, i.e. account is taken of the circuit time constant.

All miniature circuit breakers shall be provided with an auxiliary contact for remote indication of circuit breaker operation.

Means shall be provided to prevent the miniature circuit breakers being inadvertently switched to the „OFF“ position.

Miniature circuit breakers shall be mounted in such a manner so as to give easily visible indication of breaker position and shall be grouped and spaced according to their function in order to facilitate identification and easy replacement.

9.0 SPACE HEATERS

Heaters shall be suitably designed to prevent any contact between the heater wire and the air. They shall consist of coiled resistance wire centred in a metal sheath and completely encased in a highly compacted powder of magnesium oxide or other material having equal heat conducting and electrical insulation properties, or they shall consist of resistance wire wound on a ceramic and completely covered with a ceramic material to prevent any contact between the wire and the air.

Alternatively, they may consist of a resistance wire mounted into a tubular ceramic body built into an envelop of stainless steel or the resistance wire wound on a tubular ceramic body and embedded in vitreous glaze. The surface temperature of the heaters shall be restricted to a value which will not shorten the life of the heater sheaths or that of insulated wire or other component in the compartments.

10.0 LVAC CABLES (NOT APPLICABLE)

10.1 General

LVAC power cables shall have aluminium conductors with XLPE insulation, galvanised steel wire armour and PVC oversheath and shall comply with the requirements of IEC 227, 228 and 502 as applicable. Cables shall be sized to carry the highest anticipated load under the worst case ambient conditions. Where a three, three and a half or four core power cable is provided, the cores shall be coloured to distinguish the relevant phases.

All sheaths shall be free from defects and impervious to water.

10.2 1.1kV grade power and control cables

10.2.1 Codes and Standards

The design, manufacture, testing and performance of cables covered under this specification shall comply with latest edition of the standards including amendments as indicated in the relevant schedules attached to this specification.

10.2.2 Technical requirements

The cables shall be suitable for laying in racks, ducts, trenches, conduits and underground buried installation with uncontrolled backfill and chances of flooding by water.

They shall be designed to withstand all mechanical, electrical and thermal stresses under steady state and transient operating conditions. The XLPE insulated LV power cables shall withstand without damage a three phase fault current of at least 45 kA for a minimum of 0.12 seconds, with an initial peak of 105 kA in one of the phases. The armour for XLPE insulated power cables shall be capable of carrying 45 kA for at least 0.12 seconds without exceeding the maximum allowable temperature of PVC outer sheath.

Progressive sequential marking of the length of cable in metres at every one metre shall be provided on the outer sheath of all cables.

Strip wire armouring following method (a) of the relevant IS shall not be accepted for any of the cables. For control cables round wire armouring only shall be used.

Cables shall have outer sheath of a material with an oxygen index of not less than 29 and a temperature index of not less than 250°C.

All the cables shall pass fire resistance test as per IS 1554 (Part-I)

The normal current rating of all PVC insulated cables shall be as per IS 3961.

Repaired cables shall not be accepted.

10.3 LV XLPE power cables

XLPE insulated cables shall conform to IS 7098 (Part-I) and its amendments read along with this Specification. The conductor shall be stranded aluminium circular/sector shaped and compacted. In multi-core cables, the core shall be identified by red, yellow, blue and black coloured strips or colouring of insulation. A distinct inner sheath shall be provided in all multi-core cables even if they are unarmoured. For armoured or unarmoured cables, the inner sheath shall be of extruded PVC to type ST-2 of IS 5831. When armouring is specified for single core cables, the same shall consist of aluminium wires/strips.

10.4 LV XLPE power cables

PVC (70C) insulated 1100V grade power cables shall conform to IS 1554 (Part-I) and its amendments, read along with this Specification and shall be suitable for a steady conductor temperature of 70°C. The conductor shall be stranded aluminium. Insulation shall be extruded PVC to type-A of IS 5831. A distinct inner sheath shall be provided in all multi-core cables. For multi-core armoured cables, the inner sheath shall be of extruded PVC. The outer sheath shall be extruded PVC to Type ST-1 of IS 5831 for all cables.

10.5 LV PVC control cables

The 1100V grade control cables shall conform to IS 1554 (Part-1) and its amendments, read along with this specification. The conductor shall be stranded copper. The insulation shall be extruded PVC to type A of IS 5831. A distinct inner sheath shall be provided in all cables whether armoured or not. The oversheath shall be extruded PVC to type ST-1 of IS 5831 and shall be grey in colour except where specifically advised by the Project Manager to be black.

Cores shall be identified as per IS 1554 (Part-1) for cables up to five cores and for cables with more than five cores the identification of cores shall additionally be done by printing legible alphabets on all cores. The alphabets shall be white and shall be printed at approximately 100 mm intervals along the cable length. Cables without such core identifications will not be accepted.

10.6 Cable drums

Cables shall be supplied non-returnable wooden or steel drums of heavy construction. Wooden drums shall be properly seasoned sound and free from defects. Wood preservative shall be applied to the entire drum.

Standard lengths for each size of power and control cables shall be 500/1000 meters. The cable length per drum shall be subject to a tolerance of plus or minus 5% of the standard drum length. The Project Manager shall have the option of rejecting cable drums with shorter lengths. However, the total quantity of cables after taking into consideration of all cable drums for each size shall be within the tolerance of $\pm 2\%$.

A layer of water proof paper shall be applied to the surface of the drums and over the outer most cable layer.

10.7 Tests

All cables shall conform to all type, routine and acceptance tests listed in the relevant IS.

The temperature index tests shall be carried out as per ASTM-D-2863.

All cables shall meet the fire-resistance test as per IS 1554 (Part-I)

10.8 Cable sizes

Following standard sizes of cables shall be considered by Bidder for various power distribution and protection, control and metering purposes in the system:

- XLPE power cables: 1c 630 mm², 1c 300 mm², 3 1/2c 300 mm². (armoured)
- LV XLPE power cables: (armoured) 1c 150 mm², 3 1/2c 70 mm², 3 1/2c 35 mm², 4c 16 mm², 4c 6 mm², 2c 6 mm².
- PVC control cables: 2c 2.5 mm², 3c 2.5 mm², 5c 2.5 mm², 7c 2.5 mm², 10c 2.5 mm², 14c 2.5 mm², 19c 2.5 mm², 27c 2.5 mm²

11.0 BUSHINGS

All bushings shall comply with the requirements of IEC 137 and the associated barrel porcelains shall comply with IEC 233 together with the requirements of this Specification. Provision shall be made for the fitting of arcing horns.

Transformer bushings rated at 66 kV and above shall be either of the oil impregnated paper or resin impregnated type. When filled with transformer oil there shall be no connection with the oil in the transformer and an oil gauge shall be provided. The visible oil levels in the gauge shall correspond to the range of average oil temperatures, from the minimum ambient stated in the Schedules to plus 70C. The oil level at 15C shall be marked. Connections from the main windings to bushings shall be flexible and shall be such that undue mechanical stresses are not imposed on them during assembly on site.

Terminal clamps shall be supplied with each bushing for flexible or rigid busbars as may be required. The material of the clamps shall be as stated in the Schedules.

12.0 BUSHINGS, HOLLOW COLUMN INSULATORS, SUPPORT INSULATORS

Bushings shall be manufactured and tested in accordance with IS 2099 and IEC 137 while hollow column insulators shall be manufactured and tested in accordance with IEC 233/IS 5621. The support insulators shall be manufactured and tested as per IS 2544/IEC 168 and IS 2099/IEC 273. The insulators shall also conform to IEC 815 as applicable.

The bidder may also offer composite silicon insulators conforming to IEC 36.

Support insulators, bushings and hollow column insulators shall be manufactured from high quality porcelain. Porcelain used shall be homogeneous, free from laminations, cavities and other flaws or imperfections that might affect the mechanical or dielectric quality and shall be thoroughly vitrified tough and impervious to moisture.

Glazing of the porcelain shall be uniform brown in colour, free from blisters, burrs and other similar defects.

Support insulators, bushings and hollow column insulators shall be designed to have ample insulation, mechanical strength and rigidity for the conditions under which they will be used.

When operating at normal rated voltage there shall be no electric discharge between the conductors and bushing which would cause corrosion or injury to conductors, insulators or supports by the formation of substances produced by chemical action. No radio interference shall be caused by the insulators or bushings when operating at the normal rated voltage.

Bushing porcelain shall be robust and capable of withstanding the internal pressures likely to occur in service. The design and location of clamps and the shape and the strength of the porcelain flange securing the bushing to the tank shall be such that there is no risk of fracture. All portions of the assembled porcelain enclosures and supports other than gaskets, which may in any way be exposed to the atmosphere shall be composed of completely non hygroscopic material such as metal or glazed porcelain.

All iron parts shall be hot dip galvanised and all joints shall be air tight. Surface of joints shall be trued up, porcelain parts by grinding and metal parts by machining. Insulator and bushing design shall be such as to ensure a uniform compressive pressure on the joints.

12.1 Tests

In accordance with the requirements stipulated above bushing, hollow column insulators and support insulators shall conform to type tests and shall be subjected to routine tests in accordance with IS 2099 and IS 2544.

All routine tests shall be conducted on hollow column insulators as per IEC 233. In addition the following tests shall also be conducted

1. Ultrasonic test as a routine test.
2. Pressure test as a routine test.
3. Bending load test in four directions at 50% specified bending load, as a routine test.
4. Bending load test in four directions at 100% specified bending load, as a sample test on each lot.
5. Burst pressure test as a sample test on each lot.
6. Hollow porcelain insulators should be in one integral piece in green and fired stage. No jointed porcelain will be acceptable.

12.2 Technical parameters of bushings, hollow column insulators and support insulators:

Parameter	420kV	245kV	145kV	36kV
Rated voltage kV	420	245	145	36
Impulse withstand (wet and dry) kVp	±1425	±1050	±650	±170
Switching surge withstand (wet and dry) kVp	±1050			
Power frequency withstand (wet and dry) kVrms	630	460	275	70
Total creepage distance mm	10500	6125	3625	900

Pollution level shall be Class III Heavy as per IEC 71, and as specified in Schedules for all classes of equipment.

Insulators shall also meet the requirements of IEC 815 for 420kV, 245kV and 145kV systems as applicable having alternate long and short sheds.

13.0 CIRCUIT BREAKERS

13.1 General

Circuit breakers shall be of three pole air break design, horizontal draw out type in accordance with IEC 947-2. In particular, evidence shall be provided of the performance when switching currents in the critical current range. They shall be capable of the ratings specified in the Schedules, when mounted in the switchboard.

Circuit breakers shall be fitted with trip-free, spring-operated mechanisms of the independent manually operated type and be provided with making and over current release facilities. A push-button shall be provided to trip the breaker electrically.

The breaker shall be provided with '**OPEN**', '**CLOSE**', '**SERVICE**', '**TEST**' and '**SPRING CHARGED**' position indicators and shall be provided with the necessary number of auxiliary contacts for interlocking, indication and tripping purposes plus two spare.

Each incoming circuit shall be provided with thermal overload relays and short circuit protection relays; they shall also be provided with an undervoltage relay to trip breaker in the event of a supply failure.

There shall be 'SERVICE', 'TEST' and fully withdrawn positions for the breakers. It shall be possible to close the door in „TEST' position.

Movement of a circuit breaker between „SERVICE' and „TEST' positions shall not be possible unless it is in „OPEN' position. Attempted withdrawal of a closed circuit breaker shall not trip the circuit breaker.

Closing of a circuit breaker shall not be possible unless it is in „SERVICE', „TEST' or fully withdrawn positions.

A breaker of particular rating shall be prevented from insertion in a cubicle of a different rating.

Circuit breakers shall be provided with electrical anti-pumping and trip free feature.

Means shall be provided to slowly close the circuit breaker in withdrawn position if required for inspection and setting of contacts. In service position slow closing shall not be possible.

Circuit breakers shall be provided with the following mechanism as specified in the Bill of Material.

13.2 Power operated mechanism

Power operated mechanism shall be provided with a universal motor suitable for operation 220V DC control supply with voltage variation from 90% to 110% rated voltage. Motor insulation shall be class 'E' or better.

The motor shall be such that it requires not more than 30 seconds for fully charging the closing spring.

Once the closing springs are discharged, after the one closing operation of circuit breaker, it shall automatically initiate, recharging of the spring.

The mechanism shall be such that as long as power is available to the motor, a continuous sequence of closing and opening operations shall be possible. After failure of power supply at least one open-close-open operation shall be possible.

Provision shall be made for emergency manual charging and as soon as this manual charging handle is coupled, the motor shall automatically be mechanically decoupled.

All circuit breakers shall be provided with closing and tripping coils. The closing coils shall operate correctly at all values of voltage between 85% to 110% at rated control voltage. Tripping coils shall operate satisfactorily under all values of supply voltage between 70% to 110% of rated control voltage.

Provision for mechanical closing of the breaker only in 'TEST' and withdrawn positions shall be made.

14.0 RELAYS

All relays and timers in protective circuits shall be flush mounted on panel front with connections from the inside. They shall have transparent dust tight covers removable from the front. All protective relays shall have a drawout construction for easy replacement from the front. They shall either have built-in test facilities, or shall be provided with necessary test blocks and test switches located immediately below each relay. Auxiliary relays and timers may be furnished in non-drawout cases.

All AC relays shall be suitable for operation at 50 Hz with 110 volts VT secondary and 1A or 5A CT secondary.

All protective relays and timers shall have at least two potential free output contacts. Relays shall have contacts as required for protection schemes. Contacts of relays and timers shall be silver faced and shall have a spring action. Adequate numbers of terminals shall be available on the relay cases for applicable relaying schemes.

All protective relays, auxiliary relays and timers shall be provided with hand reset operation indicators (flags) for analysing the cause of operation.

All relays shall withstand a test voltage of 2kV (rms) for one minute.

Motor starters shall be provided with three element, ambient temperature compensated, time lagged, hand reset type terminal overload relays with adjustable settings. The setting ranges shall be properly selected to suit the motor ratings. These relays shall have a separate black coloured hand reset push button mounted on compartment door and shall have at least one changeover contact.

All fuse protected, contactor controlled motors shall have single phasing protection, either as a distinct feature in the overload relays (by differential movement of bi-metallic strips), or as a separate device. The single phasing protection shall operate with 80% of the set current flowing in two of the phases.

15.0 CONTACTORS

Motor starter contactors shall be of air break, electromagnetic type rated for uninterrupted duty as per IS 2959.

Contactors shall be double break, non-gravity type and their main contacts shall be silver faced.

Direct line starter contactors shall be of utilisation category AC2. These contactors shall be as per IS 1822.

Each contactor shall be provided with two normally open (NO) and two normally close (NC) auxiliary contacts.

Operating coils of contactors shall be of 240V AC unless otherwise specified elsewhere. The Contactors shall operate satisfactorily between 85% to 110% of the rated voltage. Contactors shall drop out at 70% of the rated voltage.

16.0 INSTRUMENT TRANSFORMERS

All current and voltage transformers shall be completely encapsulated cast resin insulated type suitable for continuous operation at the temperature prevailing inside the switchgear enclosure, when the switchboard is operating at its rated condition and the outside ambient temperature is 50°C.

All instrument transformers shall be able to withstand the thermal and mechanical stresses resulting from the maximum short circuit and momentary current ratings of the associated switchgear.

All instrument transformer shall have clear indelible polarity markings. All secondary terminals shall be wired to a separate terminal on an accessible terminal block where star-point formation and earthing shall be done.

Current transformers may be multi or single core type. All voltage transformers shall be single phase type. Busbar VT's shall be housed in a separate compartment.

All VT's shall have readily accessible HRC current limiting fuses on both primary and secondary sides.

17.0 INDICATING INSTRUMENTS

All indicating and integrating meters shall be flush mounted on panel front. The instruments shall be of at least 96 mm square size with 90 degree scales, and shall have an accuracy class of 2.5 or better. The covers and cases of instruments and meters shall provide a dust and vermin proof construction.

All instruments shall be compensated for temperature errors and factory calibrated to directly read the primary quantities. Means shall be provided for zero adjustment without removing or dismantling the instruments.

All instruments shall have white dials with black numerals and lettering. Black knife edge pointer with parallax free dials will be preferred.

Ammeters provided on motor feeders shall have a compressed scale at the upper current region to cover the starting current.

Watt-hour meters shall be of three phase, three element type. Maximum demand indicators need not be provided.

18.0 CONTROL AND SELECTOR SWITCHES

Control and instrument switches shall be rotary operated type with escutcheon plates clearly marked to show the function and positions. Switches shall be suitable for flush mounting with only switch front plate and operating handle projecting from the panel front. Switches shall be of sturdy construction suitable for mounting on panel front. Switches with shrouding of live parts and sealing of contacts against dust ingress shall be preferred. Handles of different shapes along with suitable inscriptions on switches shall be provided as an aid to switch identification. The selection of operating handles for the different types of switches shall be as follows :

Switch Type	Application	Specification
Switchgear control switches	For closing and opening of breakers and isolators.	Pistol grip, black, three position type.
Synchronising switches	For synchronising check bypass facilities	Oval, black, keyed (common removable handle, or with locking facility and common key).
Selector switches	Auto, manual, local, remote and test facilities	Oval or knob, black
Instrument switches	Phase or meter selection	Round, knurled, black
Protection transfer switch	Transfer of protection.	Pistol grip, lockable and black.

TABLE 18.1 Switch operating handles

The control switches of breakers and isolators shall be of spring return to neutral type. The control springs shall be strong and robust enough to prevent inadvertent operation due to light touch. The spring return type switch shall have spring return from close and trip positions to “after close” and “after trip” positions respectively. They shall have at least two (2) contacts closing in close positions, and two (2) contacts closing in Trip positions unless specified otherwise.

Circuit breaker selector switches for breaker controlled motors shall have three stay put positions marked „**AUTO**’, „**MANUAL**’ and „**TEST**’ respectively. They shall have two contacts each of three positions and shall have black, pistol grip handles.

Instrument selection switches shall be of maintained contact stayput type. Ammeter selection switches shall have make-before-break type contacts so as to prevent open circuiting of CT secondaries when changing the position of the switch. Voltmeter transfer switches for AC shall be suitable for reading all line-to-line and line-to-neutral voltages for non effectively earthed systems, and for reading all line to line voltages for effectively earthed systems. Ammeter and voltmeter selector switches shall have four stayput positions with an adequate number of contacts for three phase four wire systems. These shall have black oval handles

Synchronising switches shall be of maintained contact stayput type having a common removable handle for a group of switches. The handle shall be removable only in the „**OFF**’ position and it shall be co-ordinated to fit in to all the synchronising switches. These switches shall be arranged to connect the synchronising equipment when turned to the „**ON**” position. One contact of each switch shall be connected in the closing circuit of the respective breaker so that the breaker cannot be closed until the switch is turned to the „**ON**” position.

Lockable type switches which can be locked in particular positions shall be provided when specified. The key locks shall be fitted on the operating handles.

The contacts of all switches shall preferably open and close with snap action to minimise arcing. Contacts of switches shall be spring assisted and contact faces shall be with rivets of pure silver or silver alloy. Springs shall not be used as current carrying parts.

The contact combination and their operation shall be such as to give completeness to the interlocking and function of the scheme. The contact rating of the switches shall be as follows :

Description	Contact rating in Amps		
	220V DC	50V DC	240V AC
Make and carry continuously	10A	10A	10A
Make and carry Make and carry for 0.5 sec.	30A	30A	30A
Break			
Resistive load	3A	20A	7A
Inductive Load with L/R=40ms	0.2A	—	—

TABLE 18.2 Contact ratings of switches

19.0 AIR BREAK SWITCHES

Air breaker switches shall be of the heavy duty, single throw group operated, load break, fault make type complying with IS 4064.

The Bidder shall ensure that all switches are adequately rated so as to be fully protected by the associated fuses during all abnormal operating conditions such as overload, locked motor, short circuit etc.

Switch operating handles shall be provided with padlocking facilities to lock them in 'OFF' position.

Interlocks shall be provided such that it is possible to open the cubicle door only when the switch is in 'OFF' position and to close the switch only when the door is closed. However suitable means shall be provided to intentionally defeat the interlocks explained above.

Switches and fuses for AC/DC control supply and heater supply wherever required shall be mounted inside and cubicles.

20.0 PUSH BUTTONS

Push-buttons shall be of spring return, push to actuate type. Their contacts shall be rated to make, continuously carry and break 10A at 240V and 0.5A (inductive) at 220V DC.

All push-buttons shall have one normally open and one normally closed contact, unless specified otherwise. The contact faces shall be of silver or silver alloy.

All push-buttons shall be provided with integral escutcheon plates marked with the appropriate function.

The colour of the button shall be as follows :

- GREEN** : For motor **START**, breaker **CLOSE**, valve /damper **OPEN**
- RED** : For motor **TRIP**, breaker **OPEN**, valve /damper **CLOSE**
- BLACK** : For overload reset, all annunciator and miscellaneous functions.

All push-buttons on panels shall be located in such a way that red push buttons shall always be to the left of green push buttons.

21.0 INDICATING LAMPS

Indicating lamps shall be of the panel mounting filament type and low watt consumption. Lamps shall be provided with series resistors, preferably built-in the lamps assembly. The lamps shall have

escutcheon plates marked with its function, wherever necessary. Lamps shall have translucent lamp covers of colours appropriate to the application as indicated in Table 21.1

Colour	Indication
RED	For motor ON , breaker/isolator CLOSED , valve/damper OPEN
GREEN	For motor OFF , breaker /isolator OPEN , valve/damper CLOSE
WHITE	For motor Auto-Trip
BLUE	For all healthy conditions (e.g. control supply) and also for ' SPRING CHARGED '
AMBER	For all alarm conditions (e.g. overload) Also for ' SERVICE ' and ' TEST ' positions indicators.

TABLE 21.1 Indicating lamp colours

Indication lamps should be located just above the associated push buttons/control switches. Red lamps shall invariably be located to the right of green lamps. In case a white lamp is also provided, it shall be placed between the red and green lamps along with the centre line of control switch/push button pair. Blue and amber lamps should normally be located above the red and green lamps.

When associated with push-buttons, red lamps shall be directly above the green push button, and green lamps shall be directly above the red push-button.

The wattage and resistance of the lamps shall be as follows:

- 220/250V 5 - 10W 4000 - 8000 ohms
- 110V 5 - 10W 1000 - 2000 ohms

Neon indicating lamps or LED's shall be provided when specified. The wattage of the neon lamp shall be 0.25 to 0.5W.

Bulbs and lenses shall be interchangeable and easily replaceable from the front of the panel. Tools, if required for replacing the bulbs and lenses shall also be included in the scope of supply.

All indicating lamps shall be suitable for continuous operation at 90 to 110% of their rated voltage.

22.0 FUSES

All fuses shall be of HRC cartridge fuse link type. Screw type fuses shall not be accepted. Fuses for AC circuits shall be of Class 2 type, 20kA (RMS) breaking current at 415V AC, and for DC circuits Class 1 type 4kA breaking current.

Fuses shall have visible operation indicators.

Fuses shall be mounted on fuse carriers, which are mounted on fuse bases. Wherever it is not possible to mount fuses on carriers, they shall be directly mounted on plug in type bases. In such cases one set of insulated fuse pulling handles shall be supplied with each switchgear.

Fuse ratings shall be chosen by the bidder depending upon the circuit requirements and these shall be subject to approval of Project Manager.

23.0 NAME PLATES AND LABELS

All switchgears and ACDC distribution boards etc. shall be provided with prominent, engraved identification plates. The module identification plate shall clearly give the feeder number and feeder designation. For single front switchboards, similar panel and board identification labels shall be provided at the rear also. Language shall conform to the requirements stipulated elsewhere in the technical specification..

All name plates shall be of non-rusting metal or 3-ply lamincoid with white engraved lettering on black back ground. Inscriptions and lettering sizes shall be subject to Project Manager's approval.

Suitable plastic sticker labels shall be provided for easy identification of all equipment, located inside the panel or module. These labels shall be positioned so as to be clearly visible and shall give the device number as mentioned in the module wiring drawings.

24.0 ELECTRIC MOTORS (LV)

24.1 Codes and Standards

All motors shall conform to the latest revisions of the relevant IEC, Indian Standards, British Standards given in the schedules, except where modified or supplemented by this Specification.

The design, manufacture, installation and performance of motors shall conform to the provisions of latest Indian Electricity Act and Indian Electricity Rules. Nothing in these specifications shall be construed to relieve the bidder of his responsibility in this regard.

In case of contradiction between this specification and IS or BS or IEC, the stipulations on this specification shall prevail.

National Electrical Code for Hazardous locations and relevant NEMA standard shall also be applicable for motors located in hazardous location.

24.2 Service conditions and temperature rise

Unless otherwise specified, machines shall be designed for a maximum ambient air temperature of 50C. Accordingly the temperature rise of the stator winding by resistance method over the ambient air temperature shall not exceed 70C.

For applications where the motor temperatures may be appreciably affected by conducted or radiated heat, the amount of heat must be specified by the bidder and the appropriate temperature rises agreed.

24.3 AC Motors

24.3.1 General

All AC motors shall be of squirrel cage type, unless otherwise specified and shall be suitable for direct on line starting.

Each motor shall be assigned a maximum continuous rating (MCR) corresponding to 70C temperature. Maximum continuous motor rating shall be at least ten percent above the maximum load demand of the driven equipment at designed capacity.

Rated voltage for AC motors shall be as given below for various MCR's of the motor, unless specified otherwise:

- From 0.2 kW to 220 kW 415 V, three phase, 50 Hz
- Below 0.2 kW 240 V, single phase, 50 Hz

Voltage and frequency variations shall be as per clause 3.3 of IS 325.

The lowest voltage at the motor terminals throughout the starting period, with which the driven equipment shall satisfactorily start up even under the most arduous conditions specified, shall be 85% for motors rated up to 110 kW, and 80% for motors rated above.

The accelerating torque at any speed with the lowest starting voltage shall be at least ten (10) percent of rated full load torque of the motor.

The motors shall be suitable for two starts in succession under the specified conditions of load, torque and inertia, with the motor initially at its normal running temperature.

The ratio of locked rotor kVA at rated voltage to rated kW (MCR corresponding to 70C temperature rises) shall not exceed the following (without any further tolerance):

Motor MCR kW	Start kVA/Rated kW
Up to 110kW	1.0
Above 110kW	10.0

When tests to determine the breakaway starting current of cage induction motors are taken at reduced voltage, due allowance shall be made for the effect of saturation. The estimated value of breakaway starting current at rated voltage shall be given on all test certificates.

All motors shall be so designed that the maximum inrush currents and locked rotor and pull out torque, developed by them at 110% of the rated voltage, do not endanger the motor or the driven equipment.

The pull out torque at rated voltage shall not be less than 200 percent of the full load torque.

Motors for reciprocating compressors etc. shall be specially designed/rated to withstand the torque pulsation produced by the driven equipment.

24.3.2 Transient recovery

The motors shall be capable of resuming normal operation after a system disturbance causing temporary loss of supply voltage for periods of up to 0.2 second (fault clearance time), followed by sudden restoration to 70 percent rated voltage. From this voltage the motors shall be capable of acceleration and ultimate recovery under the most arduous load conditions.

24.4 DC Motors

DC motors shall comply with IS 4722 and shall be shunt wound type rated for 220V. Motor MCR kW rating at 50C ambient shall be at least ten percent higher than the power requirement of the driven equipment under the most onerous operating conditions foreseen during the plant's life.

DC motors which are to operate from batteries shall be capable of operating continuously under actual service conditions at any voltage between 190V and 240V.

DC motors supplied from rectifier equipment connected to AC power supplies shall meet the voltage and frequency variations specified for AC motors.

Rectifier equipment shall be capable of meeting the condition of transient recovery given above for AC motors and shall be provided with the necessary current limiting devices.

The pull-out torque of DC motors at the rated voltage shall not be less than 200 percent of the full load torque.

24.5 Enclosure and method of cooling

The following types of enclosure may be supplied:

- Totally enclosed, fan ventilated.
- Totally enclosed, closed air circuit, integral heat exchanger.
- Totally enclosed, closed air circuit, machine mounted heat exchanger.

In all cases protective enclosure and method of cooling of motors shall be IP 54 and IC 0141 in accordance with IS 4691 and IS 6362 respectively.

Cooling fans shall be directly driven from the motor shaft.

Motors situated outdoors or exposed to the weather shall be weather protected (IPW-55).

All totally enclosed type of motors shall have a dust tight construction with suitable means of breathing and of drainage to prevent accumulation of water from condensation. Drain holes shall exclude bodies greater than 6 mm diameter.

24.6 Constructional features

All components shall be of adequate mechanical strength and robustness and shall be constructed of metal unless otherwise approved. Glass fibre or plastic components, where employed, shall be of adequate design and robustness taking into account the conditions of service required and the effects of operating temperatures, ageing and thermal stability of the material. The material shall be resistant to flame propagation.

Rotors shall be so designed as to keep the combined critical speeds with the driven equipment away from the running speed by at least 20%.

Motors and their major components such as stators, rotors, terminal boxes, bearings and heat exchangers shall be designed to be readily interchangeable as integral units.

All motor rotors shall be dynamically balanced.

The enclosures shall be designed to provide an effective sealing between the primary and secondary air circuits.

The radial air gap between stator and rotor shall have an adequate margin to minimise the possibility of rubbing between the stator and rotor due to eccentric positioning, play and wear, shaft deflection due to rotor weight and unbalanced magnetic pull etc. The minimum radial air gap for all motors shall be in accordance with Clause 5.1.5 of IS 6381.

All requirements of clause 5.1.4 of IS 6381 shall also be complied with.

All the induction motors shall be capable of running at 75% of rated voltage for a period of 5 minutes.

Induction motors shall be designed to be capable of withstanding the voltage and torque stresses developed due to the difference between motor residual voltage and incoming supply voltage equal to 150% of the rated motor voltage during fast changeover of buses. The necessary features incorporated in the design to comply with this requirement shall be clearly indicated in this proposal.

24.7 Variable speed motors

Variable speed motors shall be such that the speed can be continuously adjusted over the required range. The speed control gear shall be provided with an interlock to ensure that the motor can only be started when its control sequence is at the correct setting. When the motor is switched off, the speed control sequence shall automatically return to this position.

24.8 Brush gear, commutators and slip-rings

Brush gear, commutators and slip-rings shall be designed to operate without injurious sparking and to run for at least three months without the need for adjustment or replacement of brushes.

Brushes shall be of electro graphite or metal graphite type. Adequate precautions shall be taken to protect the windings, commutators, slip-rings and brush gear against deposits of entrained carbon dust.

Removable covers shall be fitted to provide access to the brush gear, commutators and slip-rings. For totally enclosed type motors, windows shall be provided to permit observation of the brush gear whilst the motor is running.

Brush holders shall be of non-ferrous materials and located securely to accurately position the brushes on the commutator. Means for adjusting brush pressure and brush assembly shall be provided.

24.9 Internal electric heaters

Internal electric heaters shall be provided on motors rated above 30 kW, to maintain the windings in a dry condition during periods of standstill. The heater shall be suitable for use on a 240V, 50 Hz, AC supply.

24.10 Lifting facilities

All heavy parts of the motors shall be provided with adequate arrangements for lifting or handling during erection or overhaul.

All material used for equipment construction including castings and forging etc. shall be of tested quality as per relevant codes and standards. No welding shall be carried out on cast iron components for repair or any other purpose.

24.11 Winding and insulation

Winding insulation shall be of class B or better and of proven high quality and reliability.

All winding insulation shall be non-hygroscopic, oil resistant and of materials resistant to flame propagation. All windings shall be impregnated and suitably processed to effectively seal them to prevent deterioration from adverse environmental conditions at site during the installation period and also during normal operation.

All winding overhangs and leads shall be adequately supported, braced and blocked to provide sufficient rigidity during all normal conditions of service.

Cage windings and all joints shall be designed to give an adequate safety factor on fatigue due to thermal and mechanical stresses, taking into account the specified starting and running conditions. The short-circuiting and rings shall be of joint less construction. All electrical joints and connections shall be of brazed or welded construction.

Motors shall be designed to give a life endurance of at least 18000 starts.

24.12 Bearings

Bearings shall be of rolling type. Vertical motors shall normally have rolling type guide and thrust bearings.

Bearings shall be designed to prevent ingress of dust and water and shall be sealed against leakage of lubricant along the shaft.

When the motor shaft is not located axially by its own bearings, it shall be permanently marked to indicate its normal running position and the extent of float in either direction.

Bearings shall comply with the relevant Indian or International Standards. The bearing housing shall be correctly packed with lithium based grease at the time of assembly. Construction shall be such that the bearings can be dismantled without risk of damage.

For direct drives, bearings shall have an expected life of at least 40,000 running hours. For motors with significant external radial or axial loads, e.g. belt drives, bearing shall have a life of at least 15000 running hours. The bearing assembly shall be provided with a grease relief device to eject any surplus grease in to a separate container.

Lubrication shall be possible without removal of the guarding. All grease nipples, oil cups and dip sticks shall be readily accessible.

24.13 Heat exchangers

An adequate margin shall be included in the design of heat exchangers to allow for fouling of cooling tubes or ducts under service conditions. Provision shall be made for the easy cleaning of the cooling tubes or ducts, preferably on load.

The cooling tubes or ducts shall be adequately braced and supported to prevent vibration and premature fatigue or fracture.

24.14 Noise level

Noise levels shall comply with BS 4999, Part-51.

24.15 Vibration level

The double amplitude of vibrations as measured at motor bearings shall be within the limits specified in IS 4729, and the limits specified for the driven equipment.

24.16 Earthing terminals

Two independent earthing points shall be provided in accordance with IS 3043(1966), on opposite sides of the motor for bolted connection of Employer's earthing conductor.

24.17 Terminal boxes and associated fittings

Terminal boxes for motors rated above 110 kW shall be capable of withstanding a system fault level of 31 MVA for 0.12 seconds.

Unless otherwise approved, the terminal box shall be capable of being turned through 360 degrees in steps of 90 degrees.

415 volt terminals shall be suitable for receiving 1.1 kV grade PVC or XLPE, unarmoured or armoured power cables.

Only three line terminals need be brought out from each three phase primary winding. All inter phase connections whether star or delta shall be made inside the machine.

Marking of all terminals shall be in accordance with IS 4728.

Leads from terminals to the windings shall be adequately sized and braced to withstand heating and forces produced by maximum fault current.

Cable boxes and terminations shall be designed to enable easy disconnection and replacement of cables.

All joints other than those on cable glands shall be gasketed with neoprene, neoprene bonded cork or other approved material.

For single core cables, gland plates shall be effectively non-magnetic.

The following shall be supplied along with each motor :

1. Crimping type tinned copper lugs for power cables, with all necessary hardware.
2. Compression type tinned brass cable glands for power cables (to be supplied loose).
3. Removable type undrilled gland plate.
4. Terminal boxes shall be of weather proof construction with a degree of protection of IP-55. At least one motor of each batch shall be type tested to comply with the following : the terminal boxes shall be subject to an internal air pressure of 0.207 bar g for 12 hours. After this period the pressure shall not be less than 0.104 bar g (after correcting for any change in temperature).

24.18 Rating plate

In addition to the requirements as called for in General Technical Clauses and relevant IS, the rating plate shall indicate the following:

- Maximum continuous rating in kW for 70C temperature rise.
- Bearing identification numbers (in case of ball or roller bearings) and recommended lubricant.

24.19 Paint and finish

All external parts shall be finished and painted to produce a neat and durable surface which would prevent rusting and corrosion. The equipment shall be thoroughly degreased, and sharp edges and scales removed and treated with one coat of primer and two coats of grey enamel paint. Motor colour codes shall comply with the requirements indicated elsewhere in this Specification.

All fasteners used in the construction of the equipment shall be either of corrosion resistant material or electro galvanised to service condition 4. Current carrying fasteners shall be either of stainless steel or high tensile brass or copper.

24.20 Tests

Induction motors shall be subjected to the following routine and type tests.

24.20.1 Routine Tests

Visual Checks of the following:

- Marking on rating plates
- Appearance and painting
- Location and details of terminal boxes and accessories.
- In order to observe compliance to degree of protection, following test will be performed. It shall not be possible to insert a feeler gauge of 1 mm thick in the enclosure or flange faces.

Dimensional checks

Measurement of Insulation Resistance (IR) of windings, and space heaters.

Measurement of winding resistance, and space heater resistance at ambient temperature.

High voltage test on main windings, and space heaters.

IR measurement after HV test in main windings, and space heaters.

No load running test (reading of current, voltage input and speed measurement).

Measurement of bearing temperature during steady state conditions.

Vibration measurement at rated speed and rated voltage, also measurement of vibration during coasting down.

Reduced voltage running test at no load

Locked rotor test.

Phase sequence polarity check and check for terminal markings.

Over speed test

Measurement of air gap

Functional check on auxiliaries

24.20.2 Type Tests

All tests as listed under routine tests

Measurement of noise at no load

Locked rotor test - measurement of VA power input

Momentary overload test

Temperature rise test at rated conditions as well as at maximum input conditions (during heat run test, measurement of bearing temperature, winding temperature, core temperature, coolant flow and coolant temperature). In case the temperature rise test is carried at other load than rated load, specified approval for the test method and procedure shall be obtained from the Project Manager.

Degree of protection test for the enclosure followed by IR, HV and no load run test.

Terminal box - fault level withstand test and pressure test.

Pull out torque measurement

Measurement of no-load starting time.

24.20.3 DC motors

DC motors shall be subjected to all routine and type tests as per IS 4722. In addition, following tests shall be carried out:

- Noise level measurement as type test.
- Vibration measurement as routine test
- Degree of protection test as per IS 4691 as type test.

24.21 Junction boxes and cables

Design and selection of all the components shall be made with a good margin of safety factor.

The equipment shall be installed indoor.

The reference ambient temperature outside the equipment shall be taken as 50C and relative humidity as 100%.

25.0 JUNCTION BOXES

25.1 Construction

Bidder shall supply and install junction boxes complete with terminals as required.

Junction boxes shall be suitable for mounting on walls, columns, structures etc. The brackets, bolts, nuts, cable-glands, screws and all other accessories required for the erection shall be included in the Bidders scope.

Junction boxes shall be of square or rectangular type of 2.0 mm CRCA sheet steel and shall have bolted cover with good quality gasket lining.

Junction box and covers shall be hot dip galvanised.

All the terminals blocks of ESSEN make or equivalent shall be rated for 1100V and shall be of stud type. Each terminal shall be suitable for connecting two 2.5 mm² copper conductor.

All terminals shall be complete with insulated barriers, terminals studs, washers, nuts, locknuts, identification strips etc.

Junction boxes located inside shall have IP-54 protection as per IS 2147. Junction boxes located outside shall have IP-55 protection as per IS 2147.

Junction boxes shall be provided with one earthing terminal suitable for galvanised steel conductor.

The general arrangement, cross sectional details and other technical details are to be submitted in the form of drawing for Project Manager's approval.

25.2 Interconnecting cables

All cables between junction box and field devices shall be stranded copper conductor, PVC insulated, extruded PVC inner sheathed, single galvanised steel wire armoured and overall PVC sheathed 1.1 kV grade and shall conform to IS 1554. The minimum size of cable used shall be 2.5 mm² copper conductor. All cables shall be supplied by the Contractor.

26.0 CONDUIT AND CONDUIT ACCESSORIES

The bidder shall supply and install all rigid steel conduit, flexible conduits, Hume pipes etc. complete with accessories such as tees, bends, adaptors and couplings as required for cabling work between various field devices to junction boxes.

Bharat Heavy Electricals Limited

Project: 400/220 kV GIS SUB STATION AT ERSAMA, PARADEEP, ODISHA

Technical Specification: 48V FLOAT CUM BOOST BATTERY CHARGER

Doc No. TB-420A-316-025B Rev 00

Contents

SECTION 4: ANNEXURES

ANNEXURE-A: Compliance Certificate of Technical Specification 2

ANNEXURE-B: Deviation/ Change Request of Technical Specification 3

ANNEXURE-C: Guaranteed Technical Particulars..... 4

ANNEXURE-D: Technical Checklist..... 6

Bharat Heavy Electricals Limited

Project: 400/220 kV GIS SUB STATION AT ERSAMA, PARADEEP, ODISHA

Technical Specification: 48V FLOAT CUM BOOST BATTERY CHARGER

Doc No. TB-420A-316-025B Rev 00

ANNEXURE-A: Compliance Certificate of Technical Specification

The bidder shall confirm compliance to the following by signing and stamping this compliance certificate and furnishing same with the offer.

1. The scope of supply, technical details, construction features, design parameters etc. shall be as per technical specification & there are no exclusion/ deviation with regard to same.
2. There are no deviation(s) with respect to specification other than those furnished in the schedule of deviations.
3. Only those technical submittals which are specifically asked for in Notice Inviting Tender (NIT) to be submitted at tender stage shall be considered as part of offer. Any other submission, even if made, shall not be considered as part of technical offer.
4. Any comments/ clarifications on technical/ inspection requirements furnished as part of bidder's covering letter shall not be considered by BHEL, and bidder's offer shall be construed to be in conformance with the specification.
5. Any changes made by the bidder in the price schedule with respect to the description/ quantities from those given in 'BOQ' of the specification shall not be considered (i.e., technical description & quantities as per the specification shall prevail).

Date:

Bidder's Stamp & Signature

Bharat Heavy Electricals Limited

Project: 400/220 kV GIS SUB STATION AT ERSAMA, PARADEEP, ODISHA

Technical Specification: 48V FLOAT CUM BOOST BATTERY CHARGER

Doc No. TB-420A-316-025B Rev 00

ANNEXURE-B: Deviation/ Change Request of Technical Specification

Bidder shall list out all technical potential deviation/ change request (s) along with clause with respect to technical specifications.

Sl. No.	Page No.	Clause No.	Deviation	Reason/ Justification(s)
---------	----------	------------	-----------	--------------------------

Any deviation not specifically brought out in this section shall not be admissible for any commercial implication at later stage. Except to the technical deviations listed in this schedule, bidder's offer shall be considered in full compliance to the tender specifications irrespective of any such deviation indicated / taken elsewhere in the submitted offer.

Date:

Bidder's Stamp & Signature

Bharat Heavy Electricals Limited

Project: 400/220 kV GIS SUB STATION AT ERSAMA, PARADEEP, ODISHA

Technical Specification: 48V FLOAT CUM BOOST BATTERY CHARGER

Doc No. TB-420A-316-025B Rev 00

ANNEXURE-C: Guaranteed Technical Particulars

Sl. No.	Description	Requirements	Particulars to be filled by Bidder
1.	General		
i)	Name of the project		
ii)	Name of manufacturer (OEM)		
iii)	Country of origin		
iv)	Manufacturer works		
2.	Type & Designation		
i)	Type tested at name of laboratory		
ii)	Address of laboratory		
iii)	Application		
iv)	Standards applicable		
3.	Technical Requirements		
i)	Type of Charger	48V, 125A Float cum Boost Charger	
ii)	Design Ambient Temperature	50°C	
iii)	Altitude (Above MSL)	<1000 Meters	
iv)	Ac Input Voltage	400 ±20% VAC three phase	
v)	AC Input Frequency	50 ± 5% Hz	
vi)	Power factor	Single phase model- > 0.90 at full load Three phase models >0.97 at full load	
vii)	Voltage withstand test	1500V AC input to chassis for 1 minute	
viii)	Float mode	Adjustable 48V – 52 V Trickle charging of battery and simultaneously supplying the load	
ix)	Boost mode	Adjustable 48V – 65V Boost charging of battery and simultaneously supplying the load after suitable voltage dropping arrangement.	
x)	Static Regulation	Line : ± 0.5% Load : ± 0.5%	
xi)	Dynamic Regulation	± 0.5% for 10% - 90% - 10% stop load change	

Bharat Heavy Electricals Limited**Project: 400/220 kV GIS SUB STATION AT ERSAMA, PARADEEP, ODISHA****Technical Specification: 48V FLOAT CUM BOOST BATTERY CHARGER****Doc No. TB-420A-316-025B Rev 00**

		$\pm 1\%$ within 1 m sec. of stop change. $\pm 1\%$ for $\pm 25\%$ stop change in AC input voltage	
xii)	Phosphometric noise (emf weighted at 800 Hz)	< 2mV rms while delivering full rated load at normal input.	
xiii)	Out Ripple	Less than 1% RMS at full load	
xiv)	DC Output Voltage Settings	Nominal: 48V Float: 52V (adj.) Boost: 65V (adj.)	
xv)	Continuous Output Current Rating	125A	
xvi)	Output Voltage Regulation	$\pm 1\%$ for $\pm 10\%$ input voltage variations, $\pm 5\%$ frequency variations and 0-100% load variations.	
xvii)	Efficiency A) Single Phase AC i) At normal input, output and full rated load ii). For other specified input output condition and load between 25% to 100% B) Three Phase AC I). At normal input, output and full rated load ii). For other specified input, output conditions and load between 25% to 100%	Better than 85%. Better than 80%.	
xviii)	Total Harmonic content	Not to exceed 1%	
xix)	Ripple Voltage	1% RMS	

Date:

Bidder's Stamp & Signature

Bharat Heavy Electricals Limited

Project: 400/220 kV GIS SUB STATION AT ERSAMA, PARADEEP, ODISHA

Technical Specification: 48V FLOAT CUM BOOST BATTERY CHARGER

Doc No. TB-420A-316-025B Rev 00

ANNEXURE-D: Technical Checklist

(Mark a tick mark on 'YES' if the specified requirement is met, or put a tick mark on 'NO' if the Specified requirement is not met and give comments in the remark column. OR Write '(NA)' if the information/ query/ schedule is not relevant.)

Sl. No.	Parameters/ Particulars	Requirement	Bidder's confirmation
1	Technical Qualifying Requirement		
1.1	The bidder to furnish relevant documents for meeting the qualifying requirement.	Confirmed	Yes/No/NA
1.2	The technical bid shall be submitted by the Manufacturer.	Confirmed	Yes/No/NA
1.3	All the documents shall be submitted in English.	Confirmed	Yes/No/NA
2	Un-priced BOQ		
2.1	Confirm that all items have been quoted separately. Non-quoting of any item shall lead to non-evaluation of technical bid.	Confirmed	Yes/No/NA
2.2	Any other accessories for the completeness of supply is deemed to be included in the offer, whether specifically mentioned in the specification or not.	Confirmed	Yes/No/NA
3	Type Tests		
3.1	Whether valid type test reports of all the tests as per relevant IS/IEC & Customer specification enclosed in this specification, conducted earlier on identical material/ equipment are available (test reports shall be of the tests conducted not earlier than five (5) years from original scheduled date of bid opening.	Confirmed	Yes/No/NA
3.2	If the valid type test reports are not available with the bidder, then the mentioned tests shall be conducted by the bidder without any cost/ delivery implication to BHEL/Customer/ Consultant.	Confirmed	Yes/No/NA
4	General Requirements		
4.1	Bidder to confirm that at all drawings / data sheets/calculations/ QP/ valid type tests reports/ all relevant information shall be submitted to BHEL for organizing approval of ultimate	Confirmed	Yes/No/NA

Bharat Heavy Electricals Limited**Project: 400/220 kV GIS SUB STATION AT ERSAMA, PARADEEP, ODISHA****Technical Specification: 48V FLOAT CUM BOOST BATTERY CHARGER****Doc No. TB-420A-316-025B Rev 00**

	customer.		
4.2	Bidder to confirm that it will offer approved Make of the components and fitments at contract stage. In case the offered make is not approved by the customer, then alternate make shall be supplied without any commercial implications to BHEL.	Confirmed	Yes/No/NA
5	Technical requirements		
5.1	Type of rectifier	SMPS based using IGBT device	Yes/No/NA
5.2	AC Input Voltage (415V)	415 V±20% 50 Hz±5% 3 Phase , 4 Wire	Yes/No/NA
5.3	a. Continuous Output Current Rating	125A for 48V	Yes/No/NA
	b. Nominal Voltage Rating	48V DC	Yes/No/NA
5.4	a. DC Output Voltage	Float mode: 48V -52V Boost Mode: 48V-65V	Yes/No/NA
5.5	Power Factor	Three Phase model>0.97 at full load	Yes/No/NA
5.6	Voltage withstand test	1500V AC input to chassis for 1 minute	Yes/No/NA
5.5	Efficiency	(i) Three phase AC, At normal, output and full rated load- Better 90% (ii) (For other specified input, output conditions and load between 25% to 100%- Better than 85%	Yes/No/NA
5.6	Total harmonic content	Not to exceed 20% for all input condition and load 50% to 100% of rated capacity	Yes/No/NA
5.7	Ripple content	1% rms at full load	Yes/No/NA
5.8	Mode of operation	float cum boost charger	Yes/No/NA

Date:

Bidder's Stamp & Signature