



BHARAT HEAVY ELECTRICALS LIMITED

HEEP HARIDWAR INDIA-PIN 249403

FAX NO: 0091 1334 226462

PHONE NO: 0091 1334 281275

BHEL OPEN TENDER ENQUIRY No: T/3990/22/2070K/1

M/s.....

Sub: BHEL-HEEP/OPEN-TENDER (Turbine) / 2022

The Heavy Electricals Equipment Plant (HEEP) located in Haridwar, India is one of the major manufacturing plants of Bharat Heavy Electricals Ltd. The core business of HEEP includes design and manufacture of large steam and gas turbines, turbo generators and so on.

The tender is invited on the E-Procurement Portal (<https://eprocurebhel.co.in/nicgep/app>) from the manufacturers (registered as well as unregistered) for the items **BAR MATERIAL FOR TURBINE BLADES NICR20TIAL (NIMONIC 80A) Annexure- (Item Details)**.

Note: The Offer shall be submitted on the NIC E-Procurement portal only.

SPECIAL INSTRUCTIONS OF ENQUIRY-

1. Liquidated Damages (LD) for Late Deliveries shall be applicable @0.5% per week or part thereof on the value of respective delayed supplies subject to maximum of 10% of the value of respective delayed supplies. If vendor do not mention anything about LD clause in their offer, then it shall be presumed to be acceptable. No further clarification shall be asked in this regard after opening of techno-commercial bid part-1.
2. Vendors to confirm and endorse enclosed BHEL QP "QA/CF/QP/358, rev03" (**Annexure-QP**).
3. Vendors to confirm Inspection shall be done by BHEL/BHEL nominated inspection agency (TUV) & NTPC as per finally NTPC approved QP. Inspection by customer at vendor works may be done as per customer approval letter. Test certificates shall be submitted by the vendor with clear marking of QP clause number at the top of each page. Also, test certificates shall be arranged QP clause wise.
4. All vendors to provide point wise reply/confirmation along with relevant supporting documents to each and every point of **Annexure (Pre-Qualification Requirement/PQR)** for all enquiry items. Non-compliance of these may lead to rejection of offer as these are essential condition for participating in tender enquiry.
5. Vendor to offer best delivery schedule. Delivery is not sacrosanct.
6. **Price bid shall be opened of customer approved vendors only.**
7. Credentials as per **Annexure- Sub-vendor questionnaire format** is to be submitted by bidders (who are not customer approved) along with the offer for customer approval. Offers will not be considered if customer does not approve any bidder. Further, Bidder shall confirm any additional customer specific bidder approval requirements as per customer approval letter (if any) without any financial implication else their offer shall not be considered.
8. End of bars should be squared and sawed off properly.

9. There should be proper stamping of cross section, Heat number, material grade, vendor code/vendor name on each bar at the pitch of one meter.
10. Quantity tolerance should be $\pm 10\%$.
11. The evaluation currency for this tender shall be INR.
12. BHEL Standard payment term is "Payment after receipt and acceptance of material/item at HEEP, BHEL-store" as per **General Instruction and Standard Terms & Condition (GISTC), Version June-2021, Rev: 06**.
13. The quotation shall be valid for a **minimum period of 120 days**, effective from the date of tender opening.
14. Vendor to ensure that their quoted rates are not more than those quoted for any other customer including other BHEL units.
15. The total quantity may undergo change at the time of ordering.
16. Test certificate and Guarantee certificate to be provided by vendor as per specification.
17. Vendor to submit duly signed & sealed Integrity Pact in BHEL format along with offer.
18. IEM's details are following:

SI	IEM	Email
1.	Shri Otem Dai, IAS (Retd.)	iem1@bhel.in
2.	Shri Bishwamitra Pandey, IRAS (Retd.)	iem2@bhel.in
3.	Shri Mukesh Mittal, IRS (Retd.)	iem3@bhel.in

19. Clause on IP in the tender
 - (a) IP is a tool to ensure that activities and transactions between the company and its Bidder/Contractors are handled in a fair, transparent and corruption free manner. The above said Independent External Monitors (IEMs) on the present panel have been appointed by BHEL with the approval of CVC to oversee implementation of IP in BHEL
 - (b) The IP as enclosed with the tender is to be submitted (duly signed by authorized signatory) along with techno-commercial bid (Part-I, in case of two/ three part bid). Only those bidders who have entered into such an IP with BHEL would be competent to participate in the bidding. In other words, entering into this Pact would be a preliminary qualification.
 - (c) Please refer Section-8 of IP for Role and Responsibilities of IEMs. In case of any complaint arising out of the tendering process, the matter may be referred to any of the above IEM(s). All correspondence with the IEMs shall be done through email only.

Note:

No routine correspondence shall be addressed to the IEM (phone/ post/ email) regarding the clarifications, time extensions or any other administrative queries, etc on the tender issued. All such clarification/ issues shall be addressed directly to the tender issuing (procurement) department's officials whose contact details are provided below

20. Contact Details of Purchase officer of BHEL are following.
 - a) Ravi Kumar, Manager (PPX-T), PH. No.-01334281275
E-mail-ravikumar.r@bhel.in
 - b) Ankur Meghani, DGM (PPX-T), PH. No.-01334281274
E-mail- ankur.meghani@bhel.in

21. **BHEL shall be resorting to Reverse Auction (RA) (Guidelines as available on <https://www.bhel.com/>) for this tender. RA shall be conducted among the techno-commercially qualified bidders.**

Price bids of all techno-commercially qualified bidders shall be opened and same shall be considered as initial bids of bidders in RA. In case any bidder(s) do(es) not participate in online Reverse Auction, their sealed envelope price bid along with applicable loading, if any, shall be considered for ranking

22. Vendor Contract clause regarding GST ITC and provision for E-Invoices w.e.f. 01.10.2020

- (i) W.e.f. 01.04.2022, vendor to ensure submission of E-Invoice who is having turnover of more than Rs. 10 Crs. in any preceding financial year from 2017-18 onwards.
- (ii) It has been specified by the Govt. that it is mandatory to mention a valid unique invoice Reference No. (IRN) and QR code as generated from Govt. portal on a Tax Invoice. Based on such information, GST ITC as claimed by BHEL in GST Returns shall be matched with the corresponding details uploaded by supplier in E-invoicing System.
- (iii) In case the vendor /contractor delays or fails to provide all the documents as per the Purchase order / Work Order at the time of submitting Tax invoice to BHEL, any subsequent financial loss to BHEL on account of vendor/contractor shall be to vendor's / contractor's account. BHEL has further right to take necessary steps to protect its interest at the time of release of payment. This further requires inclusion of IRN and QR code on tax invoice as announced by Govt. of India w.e.f. 01.10.2020.

23. For this tender, only Class-I and Class-II Local suppliers as per MII order dated 4.6.2020 will be eligible to bid. Non - Local suppliers as per MII order dated 04.06.2020 are not eligible to participate. Bid of non-local suppliers (if any) shall be out rightly rejected.

24. *“A Bidder is permitted to procure raw materials, components, sub-assemblies, etc. from the vendors from countries which share a land border with India. Such vendors will not be required to registered with the competent authority i.e. DPIIT*

In case a bidder has proposed to supply finished goods directly/indirectly from vendors from the countries sharing land border with India, such vendor will be required to be registered with the competent authority

However, a bidder from a country which shares a land border with India, if falling under clause 8 of DoE OM dated 23.07.2020 will be eligible to bid only if the bidder is registered with competent authority as specified in Annex I of DoE OM No. 6/18/2019-PPD dated 23.07.2020”.

25. Procurement directly from Manufacturers/ suppliers shall be preferred. However, in case of submission of offer through agents including dealers/ traders/ distributors/ stockiest/ Channel partners etc. on behalf of manufacturer or the manufacturer themselves insists for making suppliers through their such agents only, following guidelines will be followed.

- a. Either the agent could bid on behalf of the manufacturer / supplier or the manufacturer / supplier could bid directly but not both.
- b. In case bids are received from both the manufacturer / supplier and the agent, the bid received from agent shall be ignored.
- c. The agent shall not allow to represent more than one manufacturer / supplier in the same tender.
- d. Agent should submit the authorization letter from the manufacturer clearly indicating details like Name, e-mail and address of manufacturer and relationship with agent and its validity to be submitted with bid. The authorization letter should be tender specific.
- e. In case order is to be placed and executed by agent following aspects are to be ensured:
 - Manufacturer of the agent should meet the PQR as defined in tender.

- Agent should have annual turnover of at least equal to Rs. 200 Lacs of year ended as 31.03.2022 or Year ended as 31.12.2021 where calendar year is in practice. The net worth of the agent should be positive. Agent to submit Audited Balance sheet and Profit & Loss Statement in support of it.
 - Manufacturer and bidder / agent should jointly confirm Guarantee for the quality of product and timely delivery as stipulated in the NIT.
26. Please submit your offer only for the above requirement subject to our **GENERAL INSTRUCTIONS AND STANDARD TERMS & CONDITIONS (GISTC: Version June-2021, Rev: 06)**. Please visit our site <https://hwr.bhel.com/bhelweb/Home.jsp> for General Instructions and Standard Terms & Conditions (GISTC) for Tender Enquiries. All the bidders/vendors must ensure compliance of these GISTC. GISTC can also be referred by login to B2B Portal for Registered Vendors.

The tender documents can be downloaded from our web site <https://eprocurebhel.co.in/nicgep/app/www.bhel.com/> or <https://hwr.bhel.com/bhelweb/Home.jsp>. After downloading the tender documents from web site, while submitting the tender as detailed in “Instruction to Bidders”, intending vendors must submit Tender Fee of Rs. 2,000/- (Rupees two thousand only) in the form of Pay Order /e-payment/ Demand Draft (drawn in favour of ‘BHEL HARIDWAR’) only. It may be noted that if hard copy of any tender documents are required, then the same may be collected against copy of Pay Order / e-payment/Demand Draft of requisite tender fee (while original to be submitted with Part-I). **However, if no hard copy of any tender documents are required from BHEL, no tender fee is required to be submitted.**

Vendors must also remit the **requisite EMD (Earnest Money Deposit) of Rs. 2,00,000/- (Rupees Two lakh only)** in the form of Pay Order/ E-payment / Demand draft (drawn in favor of ‘BHEL HARIDWAR’). **If EMD is not submitted along with the offer (Part-I) then the offer shall be out rightly rejected.**

In case of pay order/demand draft, soft copy of transaction slip is to be uploaded along with Part 1 on portal while hard copy of the same shall be submitted to BHEL HEEP Haridwar.

“As per the OM No. F.No. 1(2)(1)/2016-MA dtd. 09.02.2017 issued from the Office of Development Commissioner (Micro, Small & Medium Enterprises), “Traders and agents should not be allowed to avail the benefits extended under the PP Policy.”

In view of this, it is clarified that benefits of MSE (such as EMD Waiver, Tender fee exemption, Price preference, Payment preference etc.) will be given only to those MSE Vendors who are manufacturers of offered items against the NIT. No MSE benefits shall be provided to Agents / Stockists / Dealers / Traders etc. for the items offered but not manufactured by themselves.”

For E-Payment, the RTGS details are mentioned as below:

Bank Details	SWIFT Details of bank
STATE BANK OF INDIA RANIPUR BRANCH, OPP: BHEL MAIN GATE, SECTOR-5, RANIPUR, HARIDWAR, UTTRAKHAND, INDIA PIN CODE : 249403	SWIFT NO: SBININBB225 CC ACCOUNT NO :10667995458 IFSC CODE : SBIN0000586

As per notification reference no. NSIC/HO/GP/15(4)/2013-14 dated 07.07.2013 Micro & Small Enterprises (MSEs) are not required to submit Tender fees. A Valid MSE certificate such as Udyam Certificate/NSIC/EM (Part-II) as per GISTC shall be submitted in support of Micro & Small Enterprises (MSEs).

Central / State – PSUs / Government departments are exempted from submission of EMD subject to approval by BHEL management.

Micro & Small Enterprises (MSEs) are exempted from submission of EMD and/or Tender fees. Documents as detailed in **GENERAL INSTRUCTIONS AND STANDARD TERMS & CONDITIONS (GISTC), Version June-2021, Rev: 06** hoisted on our website <https://hwr.bhel.com/bhelweb/Home.jsp> in are to be submitted for availing exemption from submission of Tender Fees & EMDs.

BHEL will forfeit the EMD if, the successful bidder / vendor refuses to honor the order after award of the same on him and / or withdraws his bid and / or unilaterally changes the offer and / or any of its terms & conditions within the validity period.

INSTRUCTIONS TO BIDDERS FOR SUBMITTING OFFER

DEFINITION

Registered Vendors - Are those who are registered with BHEL, Haridwar for Megawatt rating/ Size/ Weight of tendered components in respective steel grade or machining of such items.

Un-registered Vendors - Are those who are not registered with BHEL, Haridwar for Megawatt rating/ Size/ Weight of tendered components in respective steel grade or machining of such items.

TECHNICAL QUALIFICATION: Technical Requirement, Pre-Qualifying Requirements/PQR & Drawings to be submitted. It is the mandatory requirement. Offer of vendors not meeting these requirements may not be considered.

ESSENTIAL INSTRUCTIONS

Un-registered vendors may be approved by BHEL, if found suitable, on the basis of data furnished by them in Supplier Registration Form (SRF) for Foreign Vendors or Indigenous Vendors (as applicable). Vendor Registration Form shall be filled only by unregistered vendors on our website www.bhel.com.

BHEL team may visit the vendor(s) works for verification of capability and capacity claimed in tender documents/offer(s).

The tender shall be **submitted in two parts** in separate cover as described below on or before the due date:

Part I (Cover-1) - Containing the following:

1. Pre-Qualifying Requirements/PQR as per **Annexure (PQR)**
2. EMD (Earnest Money Deposit) **Or** Valid certificate/Document towards exemption of Tender fee and/or EMD (applicable for Micro and small Enterprises, Central / State – PSUs / Government departments, PMD vendors etc.)
3. **Techno -Commercial Bid/Offer**
4. **Techno-commercial terms and conditions as per Annexure (Techno-commercial terms and conditions).**
5. **Annexure (Self-Certification Certificate (MII))**
6. **Annexure (Signed BHEL QP 'QA/CF/QP/358, rev03')**
7. **Annexure (Integrity Pact)**
8. **Annexure (Vendor credentials, Sub-vendor questionnaire format)**

Part II (Cover-2) - Containing the following

1. **Price Bid as per attached Annexure (Price Bid Format)**

Salient Details of Notice Inviting Tender (NIT)		
Sl. No.	Issue	Description
1	Item details	As per Annexure- Item details
2	Issue of Tender Documents	From BHEL eProcurement website https://eprocurebhel.co.in/nicgep/app (Tender documents will be available for downloading from BHEL e-Procurement website till due date of submission)
3	Due Date of Offer Submission	Date: 18.01.2023 Time: 13:45 hrs https://eprocurebhel.co.in/nicgep/app Offer to be submitted in online only through e-procurement Portal.(Bidders are requested to visit website to view corrigendum/ addenda/amendments/ extension/ modification etc. before submitting offer).

4	Opening of Tender (Techno-Commercial Bid, Part-1)	Date: 18.01.2023 Time: 14.00 Hrs Notes: This tender being an e-tender, it shall be opened online only through the E-Procurement Portal. Participating bidders may witness the Opening online only.
5	Latest Updates	Latest updates on the important dates, Amendments, Correspondences, Corrigenda, Clarifications, Changes, Errata, Modifications, Revisions, etc to Tender Specifications will be hosted in BHEL e-tender portal https://eprocurebhel.co.in/nicgep/app and not in the newspapers. Bidders to keep themselves updated with all such information.

E-Procurement Portal Inputs

Procedure for Submission of Offer for E – Tender-Procedure for Submission of Tender is available in the “Bidder Manual for BHEL Bidders” at E-tender portal <https://eprocurebhel.co.in/nicgep/app> . Terms and conditions mentioned therein shall form integral part of the NIT and bidders shall abide by the same.

Hardware and Software requirements for participating in e-tender

Please refer the website for the minimum system requirements and setting document for Bidders under the link: <https://eprocurebhel.co.in/nicgep/app>

Digital Signature

To know the procedure for obtaining Digital Signature Certificate (DSC), suppliers who are not having the DSC are advised to visit our website <https://www.bhel.com>

NIC portal Helpdesk Contacts

For any technical related queries please call at 24 x 7 Help Desk Number
0120-4001 002
0120-4200 462
0120-4001 005
0120-6277 787

Email Support

Address: A) For any Issues or Clarifications relating to the published tenders, bidders are requested to contact the respective Tender Inviting Authority
Technical - support-eproc@nic.in

Note

Offers/tenders submitted in the E-tender portal shall only be considered for further evaluation. Offers sent by FAX / E-mail / any mode other than E-tender would not be entertained and shall be out rightly rejected.

SPECIAL NOTE: All documents to be submitted should be uploaded in respective places in the E-Tender portal as per the list mentioned given in this NIT. BHEL shall not be responsible for in-complete documents.

ANNEXURE-ITEM DETAILS

M/S. OPEN TENDER

DUEDATE

18-01-2023

BHEL

HARIDWAR249403

Vendor Code

00001

INDIA

-

SL	MATERIAL CODE ITEM DESCRIPTION	QUANTITY	UNIT	LOTNO	LOT DELIVERY QTY SCHEDULE
1	HW1270384015 BAR MATERIAL FOR TURBINE BLADES NICR20TIAL(NIMONIC 80A) SPEC: HW12784 REV: 03 SIZE: 64X29 DIM.: WXT	1022	KG	1	1022 02/03/24
2	HW1270384023 BAR MATERIAL FOR TURBINE BLADE S NICR20TIAL(NIMONIC 80 A) SPEC: HW12784 REV: 03 SIZE: 60X26 DIM.: WXT	520	KG	1	520 02/03/24
3	HW1270384031 BAR MATERIAL FOR TURBINE BLADE S NICR20TIAL(NIMONIC 80 A) SPEC: HW12784 REV: 03 SIZE: 62X28 DIM.: WXT	536	KG	1	536 02/03/24
4	HW1270384104 BAR MATERIAL FOR TURBINE BLADE S	415	KG	1	415 02/03/24

MATERIAL CODE
ITEM DESCRIPTION

QUANTITY

UNIT

LOTNO

NICR20TIAL(NIMONIC 80 A) 7

0X29 MM

SPEC: HW12784 REV: 03

SIZE: 70X29

DIM.: 70X29

5	HW1270384112	444	KG	1	444 02/03/24
---	--------------	-----	----	---	--------------

BAR MATERIAL FOR TURBINE BLADE
S

MATERIAL CODE
ITEM DESCRIPTION

QUANTITY

UNIT

LOTNO

NICR20TIAL(NIMONIC 80 A) 7

3X36 MM

SPEC: HW12784 REV: 03

SIZE: 73X36

DIM.: 73X36

6	HW1270384120	480	KG	1	480	02/03/24
---	--------------	-----	----	---	-----	----------

BAR MATERIAL FOR TURBINE BLADE
S

MATERIAL CODE ITEM DESCRIPTION	QUANTITY	UNIT	LOTNO
-----------------------------------	----------	------	-------

NICR20TIAL(NIMONIC 80 A) 7
 5X36 MM
 SPEC: HW12784 REV: 03
 SIZE: 75X36
 DIM.: 75X36

 ** IMPORTANT: This enquiry is 2 part tender. Techno-Commercial bid (Part-1) & Price Bids (Part-2) should be submitted in separate envelopes. These two envelopes should be submitted in a common sealed envelope. Techno-Commercial Bid shall contain detailed Technical Specification, Drawings Technical documents, Catalogues, taxes & duties, payment terms, delivery period, Validity of offer, Replica of Price Bid (Copy of price bid without price part) etc. The confirmation to the special terms & conditions must be submitted alongwith Techno-Commercial bid.

 Special Instructions:
 AS PER OPEN TENDER DOCUMENT.

 General Instructions:
 Please visit our site www.bhelhwr.co.in for latest version of General Instructions and Standard Terms & Conditions (GISTC) for Tender Enquiries. All the bidders/vendors must ensure compliance of latest GISTC. Terms & Conditions printed overleaf of this Standard Tender enquiry format are null & void.
 For this procurement, Public Procurement (Preference to Make in India), Order 2017 dated 15.06.2017 & 28.05.2018 and subsequent Orders issued by the respective Nodal Ministry shall be applicable even if issued after issue of this NIT but before finalization of contract / PO / WP against this NIT.
 In the event of any Nodal Ministry prescribing higher or lower percentage of purchase preference and/ or local content in respect of this procurement, same shall be applicable.
 Default purchase preference under Make in India order shall be 20% to suppliers with default minimum local content of 50% for all items / works / services.
 For further details, please refer latest version of GISTC.
 Procurements where the Estimated value to be procured is less than Rs. 5 lakhs shall be exempted from Public Procurement (Preference to Make in India), Order 2017 dated 15.06.2017 & 28.05.2018
 Kindly produce GeM seller Id with documentary proof along with your Bids/offers for case Value more than 25 Lacs.

RAVI KUMAR
MANAGER(PPX-TURBINE)

Tender Reference No.	T/3990/22/2070K/1	
Techno-Commercial Terms and Conditions		
Tender Inviting Authority: BHEL HEEP Haridwar		
Item Name: BAR MATERIAL FOR TURBINE BLADES (NIMONIC 80A)		
Quotation Reference No. & Date		
Name of the Bidder/ Bidding Firm / Company :		
(This Techno-Commercial term and Conditions template must not be modified/replaced by the bidder and the same should be uploaded after filling the relevant columns, else the bidder is liable to be rejected for this tender. Bidders are allowed to enter the Bidder Name, Quotation Reference No., Date and Confirmation only)		
NUMBER #	TEXT #	TEXT #
Sl.No.	Techno-Commercial terms	Vendor Confirmation
1	Please specify whether you are manufacturer or Trader of the item.	
2	<p>Procurement directly from Manufacturers/ suppliers shall be preferred. However, in case of submission of offer through agents including dealers/ traders/ distributors/ stockiest/ Channel partners etc. on behalf of manufacturer or the manufacturer themselves insists for making suppliers through their such agents only, following guidelines will be followed.</p> <p>a. Either the agent could bid on behalf of the manufacturer / supplier or the manufacturer / supplier could bid directly but not both.</p> <p>b. In case bids are received from both the manufacturer / supplier and the agent, the bid received from agent shall be ignored.</p> <p>c. The agent shall not allow to represent more than one manufacturer / supplier in the same tender.</p> <p>d. Agent should submit the authorization letter from the manufacturer clearly indicating details like Name, e-mail and address of manufacturer and relationship with agent and its validity to be submitted with bid. The authorization letter should be tender specific.</p> <p>e. In case order is to be placed and executed by agent following aspects are to be ensured:</p> <ul style="list-style-type: none"> • Manufacturer of the agent should meet the PQR as defined in tender. • Agent should have annual turnover of at least equal to Rs. 200 Lacs during one financial year and the net worth of the agent should be positive. • Manufacturer and bidder / agent should jointly confirm Guarantee for the quality of product and timely delivery as stipulated in the NIT. 	
3	Material will be supplied as per BHEL drawing and specification mentioned in enquiry.	
4	Vendor to provide point wise reply/confirmation along with relevant supporting documents to each and every point of Annexure (Pre-Qualification Requirement/PQR) for all enquiry items. Non-compliance of these may lead to rejection of offer as these are essential condition for participating in tender enquiry.	
5	Vendor to confirm, endorse and return back enclosed BHEL QP "QA/CF/QP/358, rev03".	
6	<p>Inspection by BHEL/BHEL nominated inspection agency "TUV" & NTPC AS PER FINALLY NTPC APPROVED QP. INSPECTION BY CUSTOMER AT VENDOR WORKS MAY BE DONE AS PER CUSTOMER APPROVAL LETTER.</p> <p>Test certificates shall be submitted by the vendor with clear marking of QP clause number at the top of the each page. Also, test certificates shall be arranged QP clause wise</p>	
7	Delivery Terms (BHEL Standard term: FOR Destination means CPS/HEEP/ BHEL Haridwar)	
8	Despatch mode	
9	Origin of Despatch	
10	Freight Charges (Pre-paid/ To Pay) # Loading shall be done as per extant rules of BHEL-Haridwar, if Freight is mentioned as 'To Pay'	
11	Packing Charges Kindly inform the Packing Charges (Included/Extra). Kindly indicate the percentage in case of 'Extra' charges	

NUMBER #	TEXT #	TEXT #
Sl.No.	Techno-Commercial terms	Vendor Confirmation
12	Forwarding Charges (Included/Extra) Kindly inform the Forwarding Charges (Included/Extra). Kindly indicate the percentage in case of 'Extra' charges	
13	Delivery Period in months (Lead Time from PO date)	
14	Payment term: "100% payment against receipt & acceptance of material at BHEL HEEP Haridwar". # If vendor deviates from BHEL's standard payment term, loading on account of deviation in standard payment term shall be done as per extant rules of BHEL-Haridwar (Refer GISTC)	
15	Bank Charges # If BHEL's Standard Payment terms accepted then bank charges not applicable, otherwise please mention	
16	Rate of GST (CGST/SGST/IGST) extra in % (for Indian Bidder only)	
17	Test certificate as per Ordering Drawing & Specification shall be provided.	
18	Guarantee Certificate (In line of GISTC) shall be provided	
19	Liquidated Damages (LD) for Late Deliveries shall be applicable @0.5% per week or part thereof on the value of respective delayed supplies subject to maximum of 10% of the value of respective delayed supplies. If vendor do not mention anything about LD clause in their offer, then it shall be presumed to be acceptable. No further clarification shall be asked in this regard after opening of techno-commercial bid part-1. # If vendor don't accept this clause, then loading shall be done as per GISTC.	
20	Quotation Validity (As per NIT, Validity is 120 days from techno-commercial bid opening date).	
21	Currency	
22	The evaluation currency for this tender shall be INR.	
23	Are you registered under Micro Small Enterprises (MSE vendor)? if Yes then provide Udyam Certificate (for Indian Bidder only)	
24	Vendor Contract clause regarding GST ITC and provision for E-Invoices w.e.f. 01.10.2020: (i) W.e.f. 01.04.2022, vendor to ensure submission of E-Invoice who is having turnover of more than Rs. 10 Crs. in any preceding financial year from 2017-18 onwards. (ii) It has been specified by the Govt. that it is mandatory to mention a valid unique invoice Reference No. (IRN) and QR code as generated from Govt. portal on a Tax Invoice. Based on such information, GST ITC as claimed by BHEL in GST Returns shall be matched with the corresponding details uploaded by supplier in E-Invoicing System. (iii) In case the vendor /contractor delays or fails to provide all the documents as per the Purchase order / Work Order at the time of submitting Tax invoice to BHEL, any subsequent financial loss to BHEL on account of vendor/contractor shall be to vendor's / contractor's account. BHEL has further right to take necessary steps to protect its interest at the time of release of payment. This further requires inclusion of IRN and QR code on tax invoice as announced by Govt. of India w.e.f. 01.10.2020.	
25	Any other comments (like any other charges, order to be placed on etc.)	
26	BHARAT HEAVY ELECTRICALS LIMITED HARIDWAR reserves the right to reject any or all the bids / quotations without assigning any reason thereof. BHEL also reserves the right to increase or decrease the tendered quantities. Bidders should be prepared to accept order for reduced quantity without any extra charges.	
27	Vendor to ensure that their quoted rates are not more than those quoted for any other customer including other BHEL units.	

NUMBER #	TEXT #	TEXT #
Sl.No.	Techno-Commercial terms	Vendor Confirmation
28	Vendor to declares that they will not enter into any illegal or undisclosed agreement or understanding, whether formal or informal with other Bidder(s). This applies in particular to prices, specifications, certifications, subsidiary contracts, submission or non-submission of bids or any other actions to restrict competitiveness or to introduce cartelization in the bidding process. In case, the Bidder is found having indulged in above activities, suitable action shall be taken by BHEL as per extant policies/ guidelines.	
29	For this tender, only Class-I and Class-II Local suppliers as per MII order dated 4.6.2020 will be eligible to bid. Non - Local suppliers as per MII order dated 04.06.2020 are not eligible to participate. Bid of non-local suppliers (if any) shall be outrightly rejected.	
30	Remaining terms and conditions shall be as per General instruction and standard terms & conditions (GISTC): Version June-2021, Rev: 06.	
31	In case of any difference in conditions quoted above & elsewhere in the offer, terms quoted above shall be treated as final and binding on vendor.	

ANNEXURE-PQR

Indent No.:- 20222070

24.11.2022

Specification: HW12784, Rev 03, HW0993008 and all cross-referred standards

Minimum Qualification Requirement for blade flats of material grade NiCr20TiAl, HW12784 Rev 03

1.0 Experience Requirement:

- a. Vendor must satisfy following requirements:
 - (i) Must have experience of manufacturing and supplying rectangular bars in material grade NiCr20TiAl, (material number 2.4952) or other precipitation hardened Nickel based alloys like Alloy 105, Alloy 115 etc.
Must have manufactured and executed at least one purchase order of flat bars of NiCr20TiAl or other precipitation hardened Nickel based alloys e.g. Alloy 105, Alloy 115 etc. in the last 7 years.

In support of above vendor to submit experience details in enquired grade preferably in format given below:

Sl. No	Name of customer	Purchase order No	Size	Date of supply	Quantity

- b. Following documents are to be submitted in support of experience:
 - Test certificate duly witnessed/certified by Third party inspection agency / customer of above referred purchase order. Test certificates shall include - chemical & mechanical properties, heat treatment details and dimensions.
- c. Vendor must have creep rupture data of NiCr20TiAl as per the requirement of EN/AMS/ASTM etc. In support, vendor has to submit Creep Rupture Data for flat or round bars or forgings etc., of NiCr20TiAl.

2.0 Manufacturing and Testing Facilities:

- a. **Vendor to confirm** that they have in house rolling/forging and heat treatment facility to manufacture rectangular bars as per enquiry specification HW12784 and enquiry dimensions and tolerances as per HW0993008.

Following in house facility details are to be submitted:

- Rolling/forging
 - Heat treatment facility
- b. Vendor to furnish details of in house melting and refining facilities to manufacture raw material for further rolling/forging for turbine blade flats as per enquiry specification. At least one test certificate for material grade NiCr20TiAl manufactured in house to be submitted with offer.
In case, melting & refining facility is not available in house, vendor to inform their source of raw material with following details of their source – Experience for enquiry material grade with at least one mill test certificate of enquiry material grade, melting & refining facilities.
 - c. Vendor to confirm that they have in house testing facilities as per the requirement of enquiry specification. Details of in house facility to be submitted.
In case of outsourcing of any test, vendor to agree to carry out testing at Government accredited labs only.

- 3.0 Supply length is 2.5 meter to 5 meter with 10% short down to 1 meter as per Specification no HW 0993008. In case vendor wants to offer in shorter lengths wrt this specification, supply in shorter lengths will be acceptable only as cut pieces of fixed length. "For example bars of say 70x30mm will have to be supplied in fixed lengths of 230 mm." BHEL will inform exact lengths for each cross section, in case of offer of lengths shorter than specified, by vendor.

ANNEXURE-QP

MANUFACTURER'S NAME AND ADDRESS		STANDARD QUALITY PLAN				TO BE FILLED BY BHEL		TO BE FILLED BY BHEL				
BHEL	VENDOR'S NAME	ITEM	BAR MATERIAL FOR TURBINE BLADES	QP NO.	QA/CF/QP/358							
				REV.	03							
		DRG. NO.	-									
		SPEC.	HW12784									
		REV	AS PER PO		Page 1 of 2							
SL. NO.	COMPONENT & OPERATIONS	CHARACTERISTICS	CLASS	TYPE OF CHECK	QUANTUM OF CHECK	REFERENCE DOCUMENT	ACCEPTANCE NORMS	FORMAT OF RECORDS	AGENCY			REMARKS
									M	B	N	
1	2	3	4	5	6	7	8	9	D	10		11

1.	VACCUUM INDUCTION MELTING	CHEMICAL COMPOSITION	MAJOR	SPECTRO ANALYSIS	EACH HEAT	HW12784	HW12784	TC		P	V		
2.	ELECTRO SLAG REMELTING (ESR) OR VACCUUM ARC REMELTING (VAR)	CHEMICAL COMPOSITION	MAJOR	SPECTRO ANALYSIS	EACH HEAT	HW12784	HW12784	TC		P	V		
3.	ROLLING / FORGING					AS PER VENDOR'S PRACTICE		IR		P	-	-	
4.	HEAT TREATMENT	TIME & TEMPERATURE	MAJOR	HT CHART	100%	HW12784	HW12784	TC		P	V		
5.	STRAIGHTENING	STRAIGHTNESS	MAJOR	STARIGHTNESS	100%	HW12784 & AS PER VENDOR'S PRACTICE		TC		P	V		TO BE PERFORMED IF REQUIRED
6.	HARDNESS TEST	HARDNESS	MAJOR	HARDNESS	10% PER HEAT PER HT BATCH OR MIN 10 BARS WHICHEVER IS MAXIMUM	HW12784	HW12784	TC		P	W		
7.	MECHANICAL TESTING	0.2% PROOF STRENGTH TENSILE % ELONGATION % REDUCTION IN AREA IMPACT	MAJOR	MECHANICAL TEST	HARDEST AND SOFTEST BAR PER HEAT PER HT BATCH	HW12784	HW12784	TC		P	W		

MANUFACTURER/SUBCONTRACTOR	 <small>Digitally signed by INDRA BHUSHAN KUMAR DN: cn=INDRA BHUSHAN KUMAR, o=BHEL, ou=HEEP, email=ibkumar@bhel.in, c=IN Date: 2021.07.13 09:36:49 +05'30' Adobe Acrobat Reader version: 2021.005.20045</small>	LEGEND: ! RECORDS IDENTIFIED WITH 'TICK' SHALL BE ESSENTIALLY INCLUDED BY CONTRACTOR IN QA DOCUMENTATION. M: MANUFACTURER / SUBCONTRACTOR B: BHEL NOM. INSPECTION AGENCY "TUV" (INDIAN VENDORS) THIRD PARTY INSPECTION AGENCY LRS/TUB/BV (FOR FOREIGN VENDORS) N: CUSTOMER INDICATE 'P' PERFORM 'W' WITNESS AND 'V' VERIFICATION ALL 'W' INDICATED IN COLUMN 'N' SHALL BE 'CHP' OF CUSTOMER	FOR CUSTOMER USE	APPROVED BY

MANUFACTURER'S NAME AND ADDRESS		STANDARD QUALITY PLAN				TO BE FILLED BY BHEL		TO BE FILLED BY BHEL				
BHEL	VENDOR'S NAME	ITEM	BAR MATERIAL FOR TURBINE BLADES		QP NO.	QA/CF/QP/358						
		DRG. NO.	-		REV.	03						
		SPEC.	HW12784									
		REV	AS PER PO									
SL. NO.	COMPONENT & OPERATIONS	CHARACTERISTICS	CLASS	TYPE OF CHECK	QUANTUM OF CHECK	REFERENCE DOCUMENT	ACCEPTANCE NORMS	FORMAT OF RECORDS	AGENCY			REMARKS
1	2	3	4	5	6	7	8	9	D	10		11

		CREEP RUPTURE TEST	MAJOR	CREEP	AS PER SPEC	HW12784	HW12784	TC		P	V		
8.	METALLOGRAPHIC EXAMINATION IN CORNER AND IN CENTER POSITION	GRAIN SIZE / MICROSTRUCTURE	MAJOR	METALLOGRAPHIC	HARDEST AND SOFTEST BAR PER HEAT PER BATCH	HW12784	HW12784	TC		P	V		
9.	PROCESS QUALIFICATION FOR EACH FABRICATION FACILITY (FOR SUPPLY AS PER SPEC)												
9.1	MECHANICAL TESTING IN EDGE POSITION	0.2% PROOF STRENGTH TENSILE % ELONGATION % REDUCTION IN AREA IMPACT HARDNESS	MAJOR	MECHANICAL TEST	AS PER SPEC	HW12784	HW12784	TC		P	W		
9.2	METALLOGRAPHIC EXAMINATION IN LONGITUDINAL DIRECTION	MICROSTRUCTURE & GRAIN SIZE	MAJOR	METALLOGRAPHIC	AS PER SPEC	HW12784	HW12784	TC		P	V		
10.	NDT	SURFACE DEFECTS INTERNAL DEFECTS	MAJOR	VISUAL DP, UT	100%	HW12784	HW12784	TC		P	W		
11.	MATERIAL IDENTIFICATION / VERIFICATION CHECK	CHEMICAL (PMI)	MAJOR	SPECTRO OR PMI BY OTHER MEANS	100%	HW12784	HW12784	TC		P	W		
12.	VISUAL & DIMENSIONAL CHECK	VISUAL & DIMENSION	MAJOR	VISUAL & MEASURE	100%	PURCHASE ORDER	PURCHASE ORDER	TC		P	W*		*10% RANDOM
13.	IDENTIFICATION MARKING	MARKING	MAJOR	VISUAL	100%	HW12784	HW12784	TC		P	V		

TEST CERTIFICATES SHALL BE SUBMITTED BY THE VENDOR WITH CLEAR MARKING OF QP CLAUSE NUMBER AT THE TOP OF THE EACH PAGE. ALSO, TEST CERTIFICATES SHALL BE ARRANGED QP CLAUSE WISE.

MANUFACTURER/SUBCONTRACTOR	 <small>Digitally signed by INDRA BHUSAN KUMAR DN: cn=BHUSAN KUMAR, o=BHEL, ou=HEEP, email=B.kumar@bhel.in, c=IN Reason: 2023.07.13 09:37:08 +05'30' Adobe Acrobat Reader version: 2021.005.20048</small>	LEGEND: ! RECORDS IDENTIFIED WITH 'TICK' SHALL BE ESSENTIALLY INCLUDED BY CONTRACTOR IN QA DOCUMENTATION. M: MANUFACTURER / SUBCONTRACTOR B: BHEL NOM. INSPECTION AGENCY "TUV" (INDIAN VENDORS) THIRD PARTY INSPECTION AGENCY LRS/TUB/BV (FOR FOREIGN VENDORS) N: CUSTOMER INDICATE 'P' PERFORM 'W' WITNESS AND 'V' VERIFICATION ALL 'W' INDICATED IN COLUMN 'N' SHALL BE 'CHP' OF CUSTOMER	FOR CUSTOMER USE	APPROVED BY



संस्थान क्रय विनिर्देश (हीप - हरिद्वार)
PLANT PURCHASE SPECIFICATION
 (HEEP - HARIDWAR)

HW 12784

पृष्ठ का
 Page 1 of 7

COPYRIGHT AND CONFIDENTIAL

The information on these documents is the property of Bharat Heavy Electrical Limited. It must not be used directly or indirectly in any way detrimental to the interest of the company.

हस्ताक्षर एवं दिनांक
 SIGN & DATE

सामग्री सूची संख्या
 को नियंत्रित करता
 TLV9520 10

सामग्री सूची संख्या
 को नियंत्रित करता
 07/2008

BAR MATERIAL FOR TURBINE BLADES, NiCr20TiAl

1.0 GENERAL:

The specification governs the quality of bars, rolled or forged for milled turbine blades in grade NiCr20TiAl (Material No. 2.4952).

2.0 APPLICATION:

Bars are required for blades used for turbine and compressor

3.0 CONDITION OF DELIVERY

Bars shall be supplied in hot rolled or forged and milled, heat treated condition. The bars should be straight and free from waviness.

4.0 DIMENSION AND TOLERANCES:

Dimension tolerance, straightness, twisting and bulging limits shall be as per HW0993008.

5.0 GENERAL REQUIREMENTS:

The manufacturer must demonstrate that it has implemented a quality system that meets the requirements stipulated in EN ISO 9000. The stipulations of the present purchasing specification apply for all the manufacturers' production shops, as well as their sub-suppliers. If the material is delivered for the first time, a process qualification according to clause 12.0 "Process qualification" must be performed. Separate process qualification is required for each facility of the manufacturer.

Before starting the production, the manufacturer shall provide BHEL a manufacturing and inspection sequence plan (MIP) for information after the successful process qualification. The MIP establishes the quality assured sequence of operations. Information on internal and external specifications is also given to BHEL in MIP. BHEL may view the manufacturer's internal MIP if he wishes to do so. The manufacturer has to inform BHEL about every change in the manufacturing or subcontractor process or inspection process. BHEL decides if a new qualification process is necessary. Subcontracting of any manufacturing steps is permissible only with BHEL written approval.

Also manufacturer shall submit test instructions for non-destructive and destructive testing which are performed as part of his own quality assurance measures. The test instructions shall include precise information on the tests, illustrated by sketch if necessary. General hints on other specification are not sufficient.

6.0 MANUFACTURING

6.1 Melting

The alloy shall be made by vacuum induction melting / electro-slag re-melting (VIM/ESR) or by vacuum induction melting / vacuum arc re-melting (VIM / VAR) process.

PSC	G. Krishna	16/06/20	नाम NAME	हस्ताक्षर एवं दिनांक SIGNATURE & DATE
TSX				
QAY	U.K. Pandey	16/06/20	अनुवादक TRANSLATED BY	
STE-TB	R.K. Singh	16/06/20	निर्माणकर्ता WORKED BY	SUBODH RANA 16.06.20
			जांचकर्ता CHECKED BY	ASHISH RANJAN 16/06/20
सहमत विभाग AGREED DEPT.	नाम NAME	दिनांक एवं हस्ताक्षर DATE & SIGNATURE	पर्यवेक्षणकर्ता SUPERVISED BY	GOPAL KRISHNAN 16/06/20

स्वीकृति : संस्थान मानक समिति
 APPROVED : PLANT STANDARDS COMMITTEE

Gr. No
 2.60

REV NO.	03	निर्माण PREPARED : MTE	जारी : मानक विभाग ISSUED : STANDARDS DIVISION	दिनांक DATE : 01.06.1993
DI	18.06.2020			

स्वत्वाधिकार एवं गोपनीयता :
 इस दस्तावे में दी गई सूचना भारत हेवी इलेक्ट्रिकल्स की संपत्ति है इसका प्रयोग एवं प्रसारण इस से किसी भी तरह प्रयोग, जो कि संपत्ति के हित में हानिकारक हो ना किया जाए

हस्ताक्षर एवं दिनांक
 SIGN & DATE

सामग्री सूची संख्या
 INVENTORY NO.

4101
 19/06/20

दिनांक एवं हस्ताक्षर
& DATE



संस्थान क्रय विनिर्देश (हीप - हरिद्वार)
PLANT PURCHASE SPECIFICATION
 (HEEP - HARIDWAR)

HW 12784

पृष्ठ का
 Page 2 of 7

सुपरसेड्स
 INVENTORY NO.

समग्री सूची संख्या को
 अधिकाधिक असा है

स्वत्वाधिकार एवं गोपनीय
 इस दस्तावेज में दी गई सूचना भारत हेवी इलेक्ट्रिकल्स की संपत्ति है इसका प्रस्ताव एवं
 अस्तित्व बना से किसी भी तरह प्रयोग, जो कि कंपनी के हित में हानिकारक हो न किया जाए ।

हस्ताक्षर एवं दिनांक
 SIGN & DATE

समग्री सूची संख्या
 INVENTORY NO.

6.2 Ingot Discard:
 Sufficient discard shall be made from each ingot to ensure freedom from piping, injurious segregation and other imperfections.

6.3 Forging:
 The ingot conversion shall be conducted in such a manner as to produce substantially uniform structure throughout the forged bar. The manufacturing process of the bars can be rolling or forging.

6.4 Heat Treatment:
 The forging shall be heat treated to get desired mechanical properties as per clause 7.2.1.

Solution treatment : 8 h at 1050 - 1080°C, Air cooling
 Stabilizing: 24 h at 845°C (± 10°C), Air cooling
 Precipitation hardening: 16 h at 700°C (± 10°C), Air cooling
 The forming process and the solution treatment shall be chosen in such a way that over the whole cross section a homogeneous microstructure with a grain size of 3 to 6 according to ASTM E 122 will be reached. (See also 7.2.2)

7.0 PROPERTIES AND TESTS:

7.1 Chemical Composition:

Heat analysis in weight % (according to EN 10269 table 1) shall be as follows:

C	0.04 – 0.10	Si	≤ 0.30	Mn	≤ 1.00
P	≤ 0.010	S	≤ 0.010	Cr	18.0 – 21.0
Ti	1.80 – 2.70	Ni	Rest	Co	≤ 1.00
Fe	≤ 1.50	Al	1.0 – 1.8	B	≤ 0.008
Cu	≤ 0.20	Ti + Al	≥ 3.50		

7.2 Position of test pieces:

Specimen extraction is performed as per attachment 1. The specimens are to be taken in longitudinal direction. The positions of the specimens given in the attachment are meant to serve only as an example. Details concerning the locations of specimens, both at bar material and at bar material made of semi finished parts, are to be agreed upon by BHEL and must be given in the MIP, including a sketch of the specimen location.

7.2.1 Mechanical Properties:

It shall be ensured that the required mechanical properties are achieved throughout the entire bar cross section. The uniformity of the strength of the bars of a given delivery (per melt and heat treatment batch = test unit) shall be verified by a hardness test per EN ISO 6506-1. HBW 10/3000 or HBW 5/750 shall be used. Any other hardness test method shall be subject to prior agreement with BHEL. The hardness test shall be performed on 10% of each test unit, however on at least 10 bars, or if the test unit comprises less than 10 bars on every bar.

Mechanical properties shall be determined on the hardest and softest bar indentified by this test. Tensile testing shall be conducted according to EN 10002 resp. ASTM E8M (preferred round tension test specimen with L₀ = 50 mm and d₀ = 10 mm) or ASTM E8 (Standard specimen per fig. 8). Impact testing shall be performed with standard-test pieces with V-notch according to EN 10045. The following properties must be demonstrated at room temperature by the following tests:

REV 03

निर्माणकर्ता WORKED BY	Ashish Ranjan	AP Ranjan	20.9.11
जांचकर्ता CHECKED BY	Gopal Krishnan	Gopal	20.9.11

P-4101

20/9/11



संस्थान क्रय विनिर्देश (डीप - हरिद्वार)

HW 12784

पृष्ठ का

Page 3 of 7

PLANT PURCHASE SPECIFICATION
(HEEP - HARIDWAR)

0.2% proof Strength N/mm ²	Tensile Strength N/mm ²	Elongation (Lo=5d) (%)	Reduction in area (%)	Impact Energy (J)	Hardness HBW
≥ 600	1000 - 1300	≥ 17	≥ 17	≥ 20 ¹⁾	≥ 260

¹⁾ Average of 3 Charpy V-notch specimens.

In addition a short time creep rupture test according to DIN EN 10291 or other agreed standard has to be carried out, using the following parameters:

Test temperature: T = 750°C

Proof stress $\sigma_0 = 310$ MPa

The following values have to be reached:

Creep rupture time $t_m \geq 100$ h

Elongation $A_u \geq 4$ %

Reduction of area $Z_u \geq 4$ %

If no creep rupture is occurred after 100 h, the proof stress can be increased for further 30 MPa after every 24 h, until the creep rupture occurred.

7.2.2 Grain Size Check:

The metallographic examination has to be carried out at the beginning and at the end of the hardest and softest bar and in each case in the corner and in the center of the cross section. A substantially homogeneous microstructure with a grain size 3 -6 according to ASTM E 112 has to be achieved in the cross section. A grain size DUPLEX ALA 3 according to ASTM E 930 is acceptable provided, that a grain size of 1 is not exceeded. A deviating microstructure has to be documented according to ASTM E 1181 and to be approved by the BHEL. Reduction of amount of testing can be agreed with the BHEL. For this purpose the manufacturer has to provide adequate results.

7.2.3 Outer and Inner Quality / NDE:

7.2.3.1 Scope of Inspection:

Following NDE shall be performed in delivery condition:

- Visual inspection of all bars
- verification test of all bars
- Complete ultrasonic inspection (UT) of all bars according to EN 10308 type 1a (table 1) or other agreed standard (e.g. AMS STD 2154) has to be carried out. The calibration block and the reference block have to be manufactured out of materials with similar acoustic properties and similar surface conditions. The test has to be performed only by employees with level 2 certified according to EN 473 or SNT-TC-1A.
- 100% PT of all bars without the face areas according to EN 571-1. It is permitted to carry out a UT with a double transducer probe in the near surface area instead of PT.

हस्ताक्षर एवं तिथि
SIGN & DATE

सामग्री सूची संख्या
INVENTORY NO.

COPYRIGHT AND CONFIDENTIAL
The information on this document is the property of Bharat Heavy Electricals Limited. It must not be used directly or indirectly in any way detrimental to the interest of the company.

स्वत्वाधिकार एवं गोपनीय
इस प्रलेख में की गई सूचना भारत हेवी इलेक्ट्रिकल्स की संपत्ति है। इसका प्रयोग एवं अनावरण के बिना किसी भी तरह से प्रयोग, जो कि कंपनी के हित में सुनिश्चित हो न किया जाए।

हस्ताक्षर एवं तिथि
SIGN & DATE

सामग्री सूची संख्या
INVENTORY NO.

REV	03	निर्माणकर्ता WORKED BY	Ashish Ranjan	ARanjan	20.09.11
		जांचकर्ता CHECKED BY	Gopal Krishnan	Gopal	20.9.11

24/9/11

P-4101

निर्माक एवं हस्ताक्षर SIGN & DATE



संस्थान क्रय विनिर्देश (डीप - हरिद्वार)
PLANT PURCHASE SPECIFICATION
 (HEEP - HARIDWAR)

HW 12784
 पृष्ठ का
 Page 4 of 7

SUPERSEDES INVENTORY NO.
 शारीरी सूची संख्या को अतिरिक्त अंकन है

7.2.3.2 Criteria for registration and decision:

a) Regarding UT inspection quality class 3 according to EN10308 (table 3) shall be applied.

The decision limit for loss of back wall echo is 3 dB for all bar dimensions. The recording level is defined with $> 1\text{mm } d_{eq}$. All indication $d_{eq} \leq 1\text{mm}$ are acceptable.

b) PT: Indications $\geq 5\text{ mm}$ are unacceptable. Indications-free grinding excavations with depths $\leq 1\text{mm}$ are acceptable.

COPYRIGHT AND CONFIDENTIAL
 The information on this documents is the property of Bharat Heavy Electrical Limited. It must not be used directly or indirectly in any way detrimental to the interest of the company

8.0 MARKING:
 Blades are to be marked as per attachment 2 and specification AA0400310.

9.0 DOCUMENTATION:

The supplier shall supply four copies of the test certificate 3.1 as per EN10204 unless and otherwise stated on the order. The test certificate shall bear the following information:

- Order no.
- Specification no. / Material Designation
- Heat Number, heat analysis and melting method
- Complete information of all heat treatments performed
- Results of mechanical testing, including a list with all measured hardness
- Photos of microstructure with results of the grain size determination & creep test report
- Results of non destructive testing
- Confirmation of the material identification check
- Confirmation of the dimensional and visual check

स्वत्वधिकार एवं गोपनीय
 इस प्रलेख में दी गई सूचना भारत हेवी इलेक्ट्रिकल्स की संपत्ति है इस्तेमाल के इस्तेमाल के लिए न किया जाए।
 आगरा इस से किसी भी तरह प्रयोग, जो कि आगरा के लिए न हानिकारक हो न किया जाए।

10.0 CLEARANCE FOR DELIVERY:

The total results of the tests / checks carried out are the deciding factor for clearance for delivery, and hence shall be intimated to BHEL in advance. In case of nonconformance, BHEL evaluates the total results taking into consideration intended use of the material and examines accordingly the acceptability of deviation (if any). No material shall be delivered, if deviated, without acceptance by BHEL. The clearance, however, does not relieve the supplier of his responsibility for the hidden / unreported non-permissible defects which are found later.

11.0 DEVIATIONS:

Deviations from this Purchase Specification, which arise during manufacturing, may be submitted to BHEL in writing, giving full details of the deviation. Acceptance of concession request will be at the sole discretion of BHEL.

12.0 PROCESS QUALIFICATION:

A qualification review, performed jointly by the BHEL and supplier, is required before starting production for the first order.

This initial process qualification is required for each fabrication facility of the manufacturer. The fabrication and inspection parameters stipulated during this phase form the basis of the manufacturing and inspection sequence plan (MIP) which the supplier prepares at his own responsibility. Manufacturing is commenced after the check of conformity by the purchaser and depends on the results of the qualification review, If necessary; the manufacturing parameters are to be further optimized.

Unless otherwise stipulated by the purchaser, the process qualification shall also be required for the first three orders in addition. If desired, a process qualification can also be called for as verification of the reliability of fabrication.

हस्ताक्षर एवं दिनांक
 SIGN & DATE
 24/9/11

शारीरी सूची संख्या
 INVENTORY NO.
 P-4101

REV 03

निर्माणकर्ता WORKED BY	Ashish Ranjan	<i>A.Ranjan</i>	20.9.11
जांचकर्ता CHECKED BY	Gopal Krishnan	<i>G.Krishnan</i>	20.9.11

सामग्री सूची संख्या को
 INVENTORY NO

In addition to the scope of testing and examination given in section 7.0 the following tests shall performed (also on the hardest and softest bar):

- Mechanical tests also in the edge position of the cross section
- Photos of the microstructure with results of the grain size determination in longitudinal direction

All results shall be given in a detailed report to BHEL.

COPYRIGHT AND CONFIDENTIAL
 The information on this documents is the property of Bharat Heavy Electrical Limited it must not be used directly or indirectly in any way detrimental to the interest of the company.

13.0 CROSS REFERRED STANDARDS:
 EN ISO 9000, ASTM E122, EN 10269, EN ISO 6506-1, EN 10002, ASTM E8M, EN 10045, DIN EN 10291, ASTM E930, ASTM E1181, EN 10308, EN 473, EN 571-1, EN10204

स्वत्वाधिकार एवं गोपनीय
 इस दस्तावेज में दी गई सूचना भारत हेवी इलेक्ट्रिकल्स की सम्पत्ति है इसका प्रयोग एवं प्रसारण के बिना भी हर एक प्रयोग को कि कम्पनी के हित में हानिकारक हो न सके।

दिनांक एवं
 SIGN & DATE
 25/9/11

सामग्री सूची संख्या INVENTORY NO P-4101	REV 	निर्माणकर्ता WORKED BY Ashish Ranjan		20.09.11
		जांचकर्ता CHECKED BY Gopal Krishnan		20.9.11

दिनांक एवं हस्ताक्षर SIGN & DATE



संस्थान क्रय विनिर्देश (डीप - हरिद्वार)
PLANT PURCHASE SPECIFICATION
 (HEEP - HARIDWAR)

HW 12784

पृष्ठ का
 Page 6 of 7

संपत्ति सूची संख्या को SUPERSEDES INVENTORY NO
 अधिष्ठाता संख्या में

Attachment 1

STANDARD TESTING

Make sure that all specimens are located in the middle of material.

COPYRIGHT AND CONFIDENTIAL
 The information on this document is the property of Bharat Heavy Electricals Limited. It must not be used directly or indirectly in any way detrimental to the interest of the company.

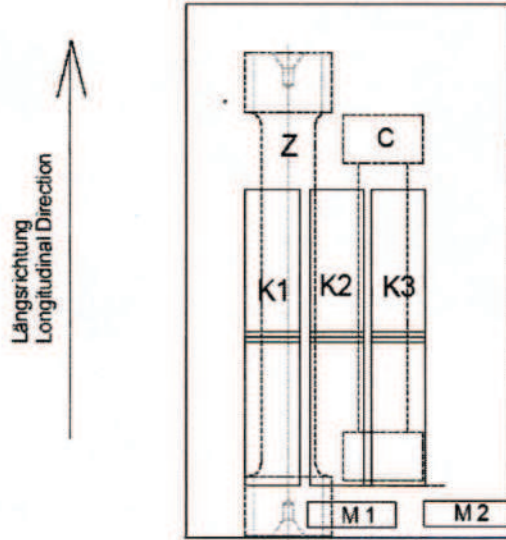

- Z: Tensile Specimen
- C: Creep test specimen
- K1- K3: Charpy impact specimen
- M1: Micro specimen (Cross Section)
- M2: Micro specimen (Cross Section)

स्वत्वाधिकार एवं गोपनीय
 इस दस्तावेज में दी गई सूचना भारत हेवी इलेक्ट्रिकल्स की संपत्ति है इसका प्रयोग एवं आरक्षण इस के धिकारी भी करते प्रयोग, जो कि कंपनी के हित में हितकारक ही न किया जाए ।

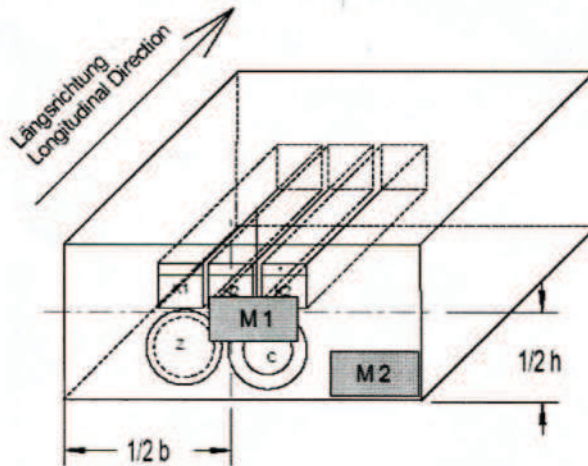

हस्ताक्षर एवं दिनांक
 SIGN & DATE
 24/9/11

संपत्ति सूची संख्या INVENTORY NO. P-4101	REV 03
--	-----------

निर्माणकर्ता WORKED BY Ashish Rajan	20.09.11
जांचकर्ता CHECKED BY Gopal Krishnan	20.9.11



संस्थान क्रय विनिर्देश (डीप - हरिद्वार)

HW 12784

पृष्ठ का
Page 7 of 7

PLANT PURCHASE SPECIFICATION
(HEEP - HARIDWAR)

Attachment 2

Marking for Steel for Steam Turbine Blades

Following details are to be marked on the blades:

- Heat No.
- Manufacturer Name / Reference
- Purchase order No.
- Material No.
- Dimensions

The identification marking shall be applied as follows:

In Case of bars:

Marking of each individual bar at the front with details mentioned above.

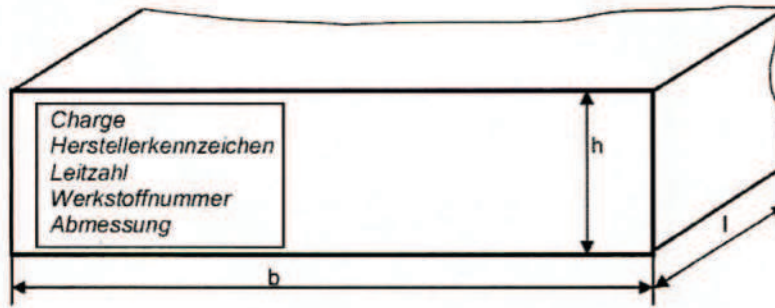

In case of cut pieces (cut bars, rhomboids): with stamped figures, ink stamp or stickers/labels

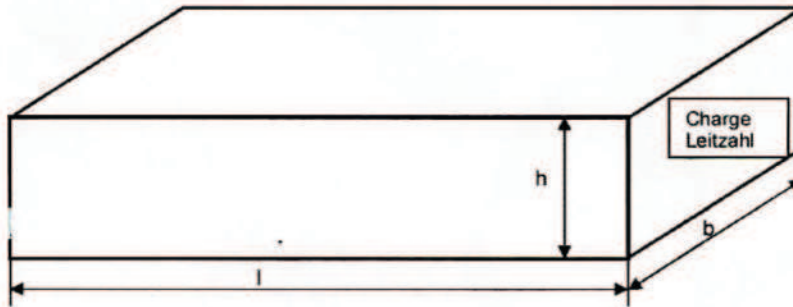

h = Dicke, thickness
l = Länge, length
b = Breite, width

COPYRIGHT AND CONFIDENTIAL.

The information on this document is the property of Bharat Heavy Electrical Limited. It must not be used directly or indirectly in any way detrimental to the interest of the company.

स्वाधिकार एवं गोपनीय

इस प्रतीक में दी गई सूचना भारत भारी इलेक्ट्रिकल्स की संपत्ति है इसका प्रयोग एवं अपर्याय रूप से किसी भी तरह प्रयोग, जो कि कंपनी के हित में हानिकारक हो न किया जाए।

दिनांक एवं हस्ताक्षर
SIGN & DATE

24/9/11

सामग्री सूची संख्या
INVENTORY NO.

P-4101

REV 03

निर्माणकर्ता
WORKED BY

Ashish Ranjan

Ashish Ranjan

20.09.11

जांचकर्ता
CHECKED BY

Gopal Krishnan

Gopal Krishnan

20.9.11

दिनांक एवं हस्ताक्षर
SIGN & DATE



संस्थान मानक (हीप : हरिद्वार)
PLANT STANDARD (HEEP: HARIDWAR)

HW0993008
पृष्ठ 2 का 1
Page 1 of 2

सुपरसेड्स
INVENTORY
NO.

(OWN EXPERIENCE)

COPYRIGHT AND CONFIDENTIAL
The information on this documents is the property of Bharat Heavy Electrical Limited. It must not be used directly or indirectly in any way detrimental to the interest of the company.

स्वाधिकार एवं गोपनीय
इस प्रबंध में की गई सूचना भारत हेवी एलेक्ट्रिकल लिमिटेड की संपत्ति है, इसका प्रयोक्ता एवं प्रयोक्ता रूप में किसी भी तरह प्रयोग, जो कि कंपनी के हित में हानिकारक हो, न किया जाए।

दिनांक एवं हस्ताक्षर
SIGN & DATE
P. 5123
13/06/20

DIMENSION AND TOLERANCES OF BAR MATERIAL OF BLADES FOR SPECIFICATIONS HW10663, HW10670, HW10786, HW10687 & NICKEL BASED SUPER ALLOYS (HW12784, INCONEL 617M, NIMONIC 105 ETC.)

1. Dimension & Tolerances:

The dimension shall be as per purchase order. Unless otherwise stated in the purchase order, length or bars shall be 2.5- 5 meters with maximum 10% short down to 1 meter.

Tolerance on thickness and width are as follows:



Table: 1.1 FOR HW10663, HW10670, HW10786, HW10687

B, width across flats (mm)	Max Allowable deviation on B, mm	S, Thickness (mm)	Max Allowable deviation on S, mm
B ≤ 35	+1.5	S ≤ 20	+1
35 < B ≤ 75	+2	20 < S ≤ 40	+2
B > 75	+3	S > 40	+3

Table: 1.2 FOR HW12784 (NIMONIC 80A), INCONEL 617M, NIMONIC 105 ETC.

B, width across flats (mm)	Max Allowable deviation on B, mm	S, Thickness (mm)	Max Allowable deviation on S, mm
B ≤ 75	+1	S ≤ 40	+1
B > 75	+1.5	S > 40	+1.5

Twisting and bending will be allowed as per following table:2

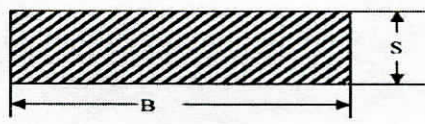

MTE	ASHISH Arayya	13/06/20	नाम NAME		दिनांक एवं हस्ताक्षर SIGNATURE & DATE
TSX	Sandeep Gupta	13/06/20	निर्माणकर्ता WORKED BY	SANDIP CHAKRABORTY	05/06/2020
STE-TB	R.K. Singh	10/06/2020	जांचकर्ता CHECKED BY	ANIL KUMAR	05/06/2020
QAX	U.K. Pandey	10/06/20	स्वीकृतकर्ता APPROVED BY	RAJIV KUMAR RAJAK	5/6/2020
सहमत विभाग AGREED DEPT.	नाम NAME	दिनांक एवं हस्ताक्षर DATE & SIGNATURE	पर्यवेक्षणकर्ता SUPERVISED BY	SANTANU BHOWMIK	5/6/2020
			स्वीकृति APPROVED :	संस्थान मानकीकरण समिति PLANT STANDARDIZATION COMMITTEE	Gr. NO. 6.4
REV.NO. 01			निर्माण : टी.बी.एम	ज़ारी : टी.स.एक्स	दिनांक DATE : 03.06.2020
DL	03/6/2020		PREPARED : TBM	ISSUED : TSX	
CHANGE ADVICE NO.	TSX (TBM) 20-166				

दिनांक एवं हस्ताक्षर
SIGN & DATE



संस्थान मानक (हीप : हरिद्वार)

HW0993008

पृष्ठ 2 का 2

PLANT STANDARD (HEEP : HARIDWAR)

Page 2 of 2

SUPERSEDES
INVENTORY

सामग्री सूची संख्या को
अपडेट करवाये

COPYRIGHT AND CONFIDENTIAL
The information on this documents is the property of Bharat Heavy
Electrical Limited. It must not be used directly or indirectly in any way
detrimental to the interest of the company

स्वतंत्राधिकार एवं गोपनीय
यस दस्तावेज में की गई प्रकृत्य भारत हीवी एलेक्ट्रिकल्स लिमिटेड की सम्पत्ति है इसका प्रयोग
अन्य उद्देश्य के लिए न किया जाये। यदि कम्पनी के हित में हस्तान्तरण हो तो बिना
अनुमति के नहीं किया जायेगा।

दिनांक एवं हस्ताक्षर
SIGN & DATE

सामग्री सूची संख्या
INVENTORY NO.

Table:2

Condition	Bending	Twisting
B & S both ≤ 110	1.5 mm/meter	1.5 mm/meter
B or S > 110	2 mm/meter	2 mm/meter

Table 3: Straightness tolerances (q_{max}) for rectangular section bar

Straightness	Value of q_{max} (mm)	Condition
	$(L \times 1.5)/2000$	B & S both ≤ 110
	$(L \times 2)/2000$	B or S > 110

Bulging on the sides shall not be more than $0.01 \times B$ & $0.02 \times S$ respectively

Table 4: Out of section tolerance for rectangular section bar:

Out of section	Nominal Thickness (mm)	Tolerance(mm)
	$10 < S \leq 25$	$u \leq 0.5$
	$25 < S \leq 40$	$u \leq 1.0$
	$40 < S \leq 80$	$u \leq 1.5$
	$S > 80$	$u \leq 3.0$

2. Cross referred documents: HW10663, HW10670, HW10786, HW10687, HW12784 and EN10269.

REV.
NO. 01

निर्माणकर्ता
WORKED BY

SANDIP
CHAKRABORTY

05/06/2020

जांचकर्ता
CHECKED BY

ANIL KUMAR

05/06/2020

13/06/20

डॉक्यूमेंट सर्वर पर मौजूब कर दी गई है।
DOCUMENT RELEASED FROM SERVER/ CTA

हस्ताक्षर दिनांक
SIGN & DATE

डॉक्यूमेंट सर्वर पर जमा कर दी गई है।
DOCUMENT DEPOSITED IN SERVER

हस्ताक्षर दिनांक
SIGN & DATE

संशोधन प्रपत्र
CHANGE ADVICE FORM



संशोधन सूचना संख्या
CHANGE ADVICE NO.
(1)

जारीकर्ता विभाग
ISSUING DEPTT.
TBM

उत्पाद का प्रकार
TYPE OF PRODUCT
Turbine blade

जोड़मास/जीआ
रएसपी/सीबोम सं
GMS / GRSP
/CBOM No.
(4)

मुद्रण वितरण
दिनांक
PRINT
DELIVERY DATE
(5)

स्वीकृतिकर्ता
APPROVED BY
Sudhakar Kumar
13/07/2020
HGM (TBM)

अधिकार
DESIGNATION
(DRAWING
No.etc) (7)

संशोधित
पृष्ठ
संख्या
REVISED
SHEET
NOS. (8)

संशोधन
संख्या
REV. NO. (9)

संशोधन का
कारण कोड
CODE FOR
REASON
OF CHANGE (10)

संशोधन का विवरण
DETAILS OF REVISION

जैसा है
AS IT EXISTS (11)

जैसा होना चाहिए
AS IT SHOULD BE (12)

प्रसार्य मद्र संख्या
CHARGEABLE
HEAD NO. (13)

सीबोम/जोड़मास /
जोड़मास की
प्रकारित सं
VARIANT NO. OF
CBOM/GMS/GRSP (14)

अन्य सीबोम
/जोड़मास सं
/जोड़मास सं/
सीबोम सं जहां
लागू है
OTHER CBOM
/GMS NOS./
GRSP NOS./
CBOM NOS.
WHERE
APPLICABILITY (15)

टिप्पणी
REMARKS (16)

ROUTE (7a)

2 01
Hw0993006

Additional
of Nimrod
alay.
(09)

Superceded by new plant standard
Specification under
the same
number vide
C/A No.. TSX(TBM)20166

निस्तारणकर्ता
RELEASED BY
STANDARDS (21)

जारी कर्ता
ISSUED BY
(CTA) (22)

प्राप्त कर्ता
RECEIVED BY
STANDARDS (23)

प्राप्त कर्ता
RECEIVED BY
(CTA) (24)

पृष्ठ सं
SHEET NO (25)

कुल पृष्ठ
TOTAL SHEETS (26)

CODES FOR REASON OF CHANGES:- 01- ENGINEERING ERROR INCLUDING D.O. ERRORS, 02- DESIGN UPGRADATION (INCLUDING ADDITION OF VARIANT), 03- DESIGN REVIEW, INCLUDING CHANGES DUE TO CHANGE ADVICE IN OTHER DOCUMENTS, 04- TO MEET MANUFACTURING REQUIREMENTS, 05- TO MEET TECHNOLOGICAL MODIFICATIONS, 06- TO SUIT CUSTOMER DEMANDS, 07 TO SUIT STATUTORY REQUIREMENTS, 08 TO REPLACE DAMAGED/ TURN OUT ORIGINALS BY A FRESH ORIGINALS ,09- ANY OTHER

AGREED सहमति (20)

निर्माताकर्ता
WORKED BY (17)

जांचकर्ता
CHECKED BY (18)

मानक नियंत्रण
STD. CONTROL (19)

नाम
NAME

हस्ताक्षर
SIGN

दिनांक
DATE

आभियांत्रिकी
ENGG.

प्रौद्योगिकी
TECHNOLO-
GY

क्यालिटी
QUALITY

विभा एवं टूल
विभाग
J & T DEPTT.

वेल्ड प्रौद्योगिकी
WELDING
TECHNOLOGY

केन्द्रीय संयंत्र
प्रयोग
CPL

अन्य विभाग
OTHER DEPTT.
()

नाम
NAME

हस्ताक्षर
SIGN

दिनांक
DATE



BHARAT HEAVY ELECTRICALS LIMITED

HEEP-HARIDWAR, UTTARAKHAND (249403)

General Instructions and Standard Terms & Conditions for bidding against Tender Enquiry (GISTC)

For Indian Bidders (Version June-2021, Rev: 06)

Table of Contents

1. GENERAL	1
2. ORIGIN OF QUOTATION	1
3. SUBMISSION OF TENDER	1
4. TENDER OPENING	2
5. SPECIFICATION, DRAWINGS & STANDARD	2
6. PRICE SCHEDULE	3
7. REVERSE AUCTION	3
8. DELIVERY TERMS	3
9. LD FOR LATE DELIVERY	4
10. PAYMENT TERMS	4
11. TAXES & DUTIES	5
12. BANK GUARANTEE	6
13. GUARANTEE / WARRANTY AND CORRESPONDING REPAIRS / REPLACEMENT OF GOODS	6
14. QUALITY REQUIREMENT	6
15. VALIDITY	6
16. RIGHT OF ACCEPTANCE	6
17. TRANSIT INSURANCE	7
18. RISK PURCHASE	7
19. FORCE MAJEURE CLAUSE	7
20. NON-DISCLOSURE AGREEMENT	8
21. SETTLEMENT OF DISPUTES / ARBITRATION	8
22. WHARFAGE / DEMURRAGE RESPONSIBILITY	8
23. CONDITIONS FOR AVAILING MICRO & SMALL ENTERPRISES (MSE'S) BENEFITS	8
24. INFORMATION TO THE BIDDERS	10
25. MAKE IN INDIA (GOVT-NOTIFICATION)	10
26. RESTRICTIONS UNDER RULE 144(XI) OF THE GENERAL FINANCIAL RULES (GFRs), 2017	12

27. NOTE..... 12

1. GENERAL.

These general terms & conditions shall apply to all the Tender Enquiries, notice inviting tenders, request for quotations concerning the supply of goods and / or rendering of services to Bharat Heavy Electricals Ltd., HEEP, Haridwar (hereinafter referred to as BHEL or the Purchaser). In case of placement of order these conditions will become part of Purchase Order (P.O) until unless the deviations are specifically agreed by BHEL.

2. ORIGIN OF QUOTATION.

- a) The quotation should preferably be from the principal bidder. However tender specific authorized registered dealer/agent can also submit the bid on their behalf, failing which the quotation is liable to be ignored. BHEL prefers to deal directly with the principal manufacturers.
- b) An agent cannot quote on behalf of more than one principal in the same Tender Enquiry.

3. SUBMISSION OF TENDER.

- a) Bid / Quotation must be enclosed in sealed cover on which tender enquiry number and the due date MUST BE written and be invariably sent under REGISTERED POST / SPEED POST / COURIER / Dropped in the Tender Box: addressed as follows:

Quotation against Enquiry No. _____

Dated: _____

Due on: _____

To,

**THE HEAD OF MATERIALS MANAGEMENT,
Heavy Electrical Equipment Plant,
Bharat Heavy Electricals Limited,
HARIDWAR-249403 (Uttarakhand), INDIA.**

- b) TENDER ROOM is located at: Room No. - 415, 4th Floor, Main Admin. Building, BHEL-HEEP, Haridwar.

Quotations / Bids not in accordance with General Instructions and Standard Terms & Conditions are likely to be ignored.



BHARAT HEAVY ELECTRICALS LIMITED

HEEP-HARIDWAR, UTTARAKHAND (249403)

General Instructions and Standard Terms & Conditions for bidding against Tender Enquiry (GISTC)

For Indian Bidders (Version June-2021, Rev: 06)

- c) In case of Three / Two Part Bid, technical bid containing technical offer, duly signed and un-priced copy of the Price Bid should be kept in one envelope. Price Bid containing only the price should be kept in a separate envelope. All envelopes indicating Part-1 or Part-2 or Part-3 as the case may be to be put in a bigger envelope. Please note that un-priced bid should be the exact replica of price bid but without prices.
- d) The bid / quotation must be posted before due date, keeping allowance for postal transit time. Quotations sent by any mode but not received in time will be ignored. Tender received through authorized E-mail is also acceptable. However, in time submission of tender in tender box shall be the responsibility of the bidder, sent through any mode. Documents submitted with the offer / bid shall be signed and stamped in each page by authorized representative of the bidder.
- e) Any additional documents submitted by supplier / bidder, during processing of registration application / tender or after placement of order shall not be accepted unless it is submitted with forwarding letter and duly signed and stamped.
- f) The bids of the bidders who are on the banned list and also the bids of the bidders, who engage the services of the banned firms, shall be rejected. The cutting / overwriting in the bid / offer must be duly attested by the signatories to the bid. The list of firms banned by BHEL is available on BHEL web site www.bhel.com.
- g) Being PMD vendor, if you are not quoting against this tender enquiry, please send your regret letter positively for our reference with valid reasons for not participating in the tender enquiry. Repeated lack of response on the part of bidder may lead to deletion such PMD vendor from BHEL's approved vendor list.
- h) The bidders will submit Integrity Pact, duly signed by its authorized signatory, along with their bids wherever estimated tender value is Rs. 2 Crore or more.
- i) In case of open tender, technically qualified unregistered bidders may apply online for registration through <http://www.bhel.com/index.php/vender>.
- j) BHEL reserves the right to award tendered quantities among more than one bidder (after acceptance of L1 price by the other bidders). BHEL can also consider awarding of part of the tendered quantity to other than L-1 bidder at L1 counter offered rates, if the quantity offered by the L-1 bidder is less than the quantity tendered for.
- k) In case of e-Tendering (Online bidding through e-portal), offline bid submitted in hard copy or in any other form by the vendor / supplier will not be accepted and will be rejected out rightly. Only e-portal bid will be accepted.

4. TENDER OPENING.

Tender opening is scheduled to start in the Tender Room at 2:00 PM, on the due date. Therefore, bid / quotations must reach this office / tender Box latest by 1:45 PM on due date. Only participating bidders are allowed to attend tender opening. **TENDERS RECEIVED AFTER THE SPECIFIED TIME OF THEIR 'SUBMISSION' WILL BE TREATED AS LATE TENDERS AND SHALL NOT BE CONSIDERED UNDER ANY CIRCUMSTANCES.** The bidders or their authorized representatives may be allowed to attend tender opening if duly authorized by their principals, through a tender specific letter on that particular day. General authorization letter is not acceptable.

Note: - Foreign bidders willing to attend the bid opening has to provide the requisite documents to the concerned Purchase executives for arranging gate pass for them.

5. SPECIFICATION, DRAWINGS & STANDARD.

- a) Bidders must give their detailed specification in the quotation along with relevant technical literature / catalogue etc. against the tender enquiry.
- b) The Bid should be accompanied with relevant copies of catalogues, drawings or specification as per tender enquiry.

Quotations / Bids not in accordance with General Instructions and Standard Terms & Conditions are likely to be ignored.



BHARAT HEAVY ELECTRICALS LIMITED

HEEP-HARIDWAR, UTTARAKHAND (249403)

General Instructions and Standard Terms & Conditions for bidding against Tender Enquiry (GISTC)

For Indian Bidders (Version June-2021, Rev: 06)

If these documents are not furnished, the offer is liable to be rejected.

- c) Wherever national / international (N/IN) standards are referred, the latest N/IN standards are to be followed. Mention year & date of standard revision that shall be followed for the supply.
- d) All Drawings and Standards are proprietary of BHEL. It must not be used in anyway detrimental to the interest of BHEL or without permission of BHEL.

6. PRICE SCHEDULE.

- a) Kindly quote your prices in figures and words both. In case of any discrepancy in value, the prices quoted in words shall be considered for evaluation and establishing L1 status.
- b) Prices quoted should not be more than the prices quoted to any other BHEL units / offices / divisions. Vendor to submit copy of latest Purchase Order placed by any unit of BHEL for similar items in the technical bid. In case no order has been placed on such items, specific confirmation that no order has been placed on such items should be provided.
- c) Prices should be quoted on F.O.R. Destination basis. Transit insurance shall be arranged by BHEL and not to be included in the prices. The offers quoted on other than F.O.R destination basis may result in non-consideration of such bids.
- d) In case BHEL accepts the EX-Works prices, such offers will be loaded by 1.5% of EX-Works value towards freight or with actual freight charges as per BHEL freight rate contract whichever is higher.
- e) In case of Indigenous items covered by DGS & D Rate Contract, the bidders should submit latest valid copy of the rate contract along with bid / quotation
- f) Applicable **IGST / CGST / SGST** and any other statutory levy should be indicated separately and clearly in the bid / quotation.

- g) Bidders can dispatch goods through any Indian Bank Association approved transporters having their branch at HARIDWAR / destination. If material is dispatched through other than Indian Bank Association approved transporter, material to be delivered on door delivery BHEL Stores basis.
- h) In case of dispatch of material through any other unapproved transporter, payment shall be made only after receipt of material and any additional charges payable to the transporter shall be to the bidder's account.
- i) Any demurrage / godown rent payable to the transporter / or to godown's owner due to any delay attributed by the supplier shall be recovered from supplier's account.
- j) Currency of Evaluation shall be INR.

NB: Financial evaluation of L1, L2Status will be on the basis of Landed Cost to BHEL.

7. REVERSE AUCTION.

Wherever RA is declared in the special terms and conditions of tender enquiry, following shall be applicable and Bidders to confirm the same:

"BHEL shall be resorting to Reverse Auction (RA) (Guidelines as available on www.bhel.com) for this tender. RA shall be conducted among all the techno-commercially qualified bidders.

Price bids of all techno-commercially qualified bidders shall be opened and same shall be considered as initial bids of bidders in RA. In case any bidder(s) do(es) not participate in online Reverse Auction, their sealed envelope price bid along with applicable loading, if any, shall be considered for ranking."

8. DELIVERY TERMS.

- a) Goods shall be delivered on 'FOR Destination' basis to the named destination unless otherwise called for in the tender enquiry.
- b) Loading on account of 3rd party inspection charges in case of Indian bidders shall be 0.20%.

Quotations / Bids not in accordance with General Instructions and Standard Terms & Conditions are likely to be ignored.



BHARAT HEAVY ELECTRICALS LIMITED

HEEP-HARIDWAR, UTTARAKHAND (249403)

General Instructions and Standard Terms & Conditions for bidding against Tender Enquiry (GISTC)

For Indian Bidders (Version June-2021, Rev: 06)

9. LIQUIDATED DAMAGES (LD) FOR LATE DELIVERY.

a) Where items of Purchase Order are independently usable.

Liquidated Damages (LD) for Late Deliveries shall be applicable @0.5% per week or part thereof on the value of respective delayed supplies subject to a maximum of 10% of the value of respective delayed supplies. Value of delayed supplies will mean the Gross Value payable to the vendor (Before LD) against such supplies excluding taxes and duties.

b) Where the total items are required for a main equipment and items are interdependent.

Liquidated Damages (LD) for Late Deliveries shall be applicable @0.5% per week or part thereof on total value of Purchase Order subject to maximum of 10% of the total value of Purchase Order. Purchase Order value for this purpose shall be the Total Gross Value payable to the vendor (Before LD) excluding taxes and duties.

c) Bidders are requested to quote the best delivery meeting the delivery requirements. BHEL reserves the right to reject the offers not meeting BHEL's delivery requirement.

d) Commencement of delivery period shall be reckoned from the date of PO / LOI or any other agreed milestone.

e) Bidder shall deliver the goods in the manner and schedule agreed under the terms and conditions of Purchase order.

f) DELIVERY IN CASE OF REJECTION: In case the material is rejected, then date of replacement will be considered as the actual date of delivery.

g) DELIVERY AGAINST BANK DOCUMENTS: In case payment terms quoted by bidder are documents through bank, and the delivery terms being "FOR Haridwar / FOR Transporter Go-down" then date of delivery will be date of intimation by transporter / bidder of delivery of material at Haridwar for the LD purpose.

h) Where the payments are through bank, the documents may be presented for negotiation to BHEL authorized / nominated bank.

i) Payment of Liquidated Damages (LD) shall not in any way relieve the vendor from any of its obligations & liabilities under the contract.

10. PAYMENT TERMS.

a) BHEL's standard payment term is Payment after receipt and acceptance of materials / items at HEEP, BHEL-Store or at desired destination unless otherwise specified in Special Terms attached to the tender enquiry.

b) BHEL reserves the right to accept or reject the offer of the bidder who quotes the payment term other than BHEL's standard payment term.

c) Loading on account of deviation in payment terms shall be done as per extant rules of BHEL-Haridwar.

d) 100% payment along with taxes, freight & insurance will be made after receipt and acceptance of material and within 75 days from the date of invoice subject to submission of non-discrepant documents within 15 days of supply as per terms and conditions of Purchase Order. In case any discrepancy found in the documents, BHEL will notify the same to vendor within 7 days of receipt. Vendor has to clear all the discrepancies in one go within 7 days thereafter else the payment of vendor may get delayed.

e) For MSEs (covered under MSME Act) which are registered and periodically renewed with BHEL, the payment will be made within 45 days or as prescribed in the relevant act.

f) Adherence to the above time schedule of payment is contingent upon Vendor complying with GST Rules w.r.t availment of Input Tax Credit by BHEL.

g) In case GST credit is delayed / denied to BHEL, due to non / delayed receipt of goods and / or tax invoice or expiry of the timeline prescribed in GST Law for availing such ITC, or any other reason not attributable to BHEL, GST amount shall be recoverable from Vendor along with interest levied / leviable on BHEL.

h) The taxes and duties that are reimbursed would be the ones applicable as on the contractual Purchase order delivery date or the amount actually paid whichever is less.



BHARAT HEAVY ELECTRICALS LIMITED

HEEP-HARIDWAR, UTTARAKHAND (249403)

General Instructions and Standard Terms & Conditions for bidding against Tender Enquiry (GISTC)

For Indian Bidders (Version June-2021, Rev: 06)

i) **The loading criteria for the different payment terms shall be as under;**

Payment Terms	Days of Loading
After Receipt & Acceptance of material within 75 days of supply.	No Loading
Against Delivery at BHEL-Stores Haridwar.	45
Against documents through bank (CAD):	45
Letter of Credit (LC)	120
Usance LC	No Loading if usance period is > 120 Days.
	Loading of days' difference i.e. difference between 120 days and usance period if the usance period is < 75 days.
Advance	Delivery Period + 120 Days - Advance Payment Days.

11. TAXES & DUTIES.

- a) The bidder to specify in their offer (part 1 bid) the category of their registration under GST like Registered, Unregistered and composite dealer.
- b) The provisional GST registration number of Bharat Heavy Electrical Ltd, Heavy Electricals Equipment Plant, Ranipur, Haridwar is "05AAACB4146P1ZL" with state Code as "05" and State Name as "Uttarakhand".
- c) Please quote our provisional GST registration number in all invoices raised for supply of goods and services under GST regime and also ensure filing of timely return and payment of tax and compliance of other applicable provisions on supplier under GST regime.
- d) No GST will be reimbursed to unregistered or composite dealer. In the event, any GST is quoted by composite dealer, the same shall be added to the cost of supply in evaluating the bid.
- e) Since, input credit of GST will be available to BHEL-Haridwar only after correct filing of return and payment of applicable GST by supplier, reimbursement of GST shall be made by

BHEL-Haridwar on matching of vendor inputs at GST portal, ensuring availability of input credit to BHEL Haridwar. Payment of GST will be made to vendor after matching of input credit and vendor to ensure submission of their invoices along with consent to accept payment of tax after such matching in all cases where bills are submitted directly to BHEL-Haridwar or through bank or under LC or through any other mode.

- f) In the event of any disallowance of input credit or applicability of interest or any other financial liability arises on BHEL-Haridwar due to any default of supplier under GST, such implication shall be to supplier's account.
- g) In the event of any change in the status of the vendor after the submission of the bid but before the supply, GST applicable at the time of supply or in the bid, based on the registration status of the vendor, whichever is lower shall be payable.
- h) Where ever applicable If PAN (Permanent Account Number) of the recipient is not available, income tax is deductible either at the normal rate or at the rate of 20 percent, whichever is higher as per Section 206AA of Indian Income Tax Act 1961.
- i) The bidder shall clearly indicate HSN (*Harmonised System Nomenclature*) / SAC (*Service Accounting Code*), its description and applicable rate of GST for each item in his techno-commercial bid.
- j) Statutory Variation in Taxes & duties as applicable at the time of supply shall be payable. However, in the event of no change in law but bidder quoting certain tax structure in bid document which is lower than the applicable one, such amount shall be the maximum amount of tax that can be claimed by bidder.
- k) **IMPORTED GOODS OFFERED BY INDIAN BIDDERS AGAINST DEALER INVOICE:** Wherever the material being offered is imported, the bidder must quote the prices inclusive of IGST. The rate and value of IGST as included in the price must be indicated separately. In case quantum of IGST is not mentioned by the bidder the same will not be considered for



BHARAT HEAVY ELECTRICALS LIMITED

HEEP-HARIDWAR, UTTARAKHAND (249403)

General Instructions and Standard Terms & Conditions for bidding against Tender Enquiry (GISTC)

For Indian Bidders (Version June-2021, Rev: 06)

evaluation. However, bidder will have to pass on the benefit of IGST to BHEL at the time supply.

- l) In case of directly dispatchable items to Customer's Site, BHEL-Haridwar will inform the GST registration number of the respective customer which must be mentioned on the vendor's invoice. Vendor to ensure availability of such information from BHEL-Haridwar before dispatch of any material. However, while filing GSTN-1, BHEL Haridwar GSTN number to be quoted.

Note: - Vendors must ensure compliance of all the applicable rules and procedure as envisaged in the GST Regime. Any loss to BHEL-Haridwar due to fault / non-compliance by the vendor will be to the vendor's account.

12. BANK GUARANTEE.

In case the bank guarantees are required to be deposited towards security deposit/performance guarantee or for any other purpose as per the terms of this tender enquiry, such bank guarantees of the requisite value in the denominated currency of the purchase order should be from one of the Indian branch of BHEL consortium banks and the bank guarantee should be in the proforma as prescribed by BHEL. The proforma of bank guarantee and the list of consortium banks are displayed at BHEL website www.bhelhwr.co.in. However, in case the bank guarantee is not from BHEL consortium banks, then the bidder has to get the bank guarantee confirmed from one of the Indian branch of BHEL consortium banks and the bank charges for such confirmation will be borne by the bidder.

13. GUARANTEE / WARRANTY AND CORRESPONDING REPAIRS / REPLACEMENT OF GOODS.

Goods shall comply with the specifications for material, workmanship and performance. Unless otherwise specified, the warranty shall be for a period of 18 months from the date of receipt. If the delivery is found non-compliant during the warranty period, leading to rejection, the Seller shall arrange free replacement / repair of goods, within one month from the date of intimation or any mutually agreed period. The rejected goods shall be taken away by the Seller at his cost and

replaced on Delivered Duty Paid (DDP) (FOR - BHEL Stores / designated destination basis) within such period. In the event of the Seller's failure to comply, Purchaser may take action as appropriate, including Repair / Replenish rejected goods & disposal of rejections, at the risk & cost of the Seller. In case the defects attributable to Seller are detected during processing of the goods at BHEL or at our subcontractor's works, the Seller shall be responsible for free replacement / repair of the goods as required by BHEL.

- b) **RETURN OF REJECTED MATERIAL FOR REPLACEMENT:** The bidder shall have to pay 5% incidental charges while taking back supplied material if it is found rejected on receipt. The rejected material shall be sent back only after receipt of replacement / submission of BG / refund of amount paid.

14. QUALITY REQUIREMENT.

Your bid / quotation should have specific confirmation regarding meeting all our quality requirements such as. (i) Test Certificate (TC), (ii) Guarantee Certificate (GC) / Warranty Certificate (WC), (iii) Quality Plan (QP) (if applicable); and (iv) Pre-Dispatch Inspection at your works (if applicable).

15. VALIDITY.

The quotation should be valid for a minimum period of 90 days effective from the date of opening of tender, unless otherwise specified in the tender enquiry.

16. RIGHT OF ACCEPTANCE.

- a) **BHARAT HEAVY ELECTRICALS LIMITED HARIDWAR** reserves the right to reject any or all the bids / quotations without assigning any reason thereof. BHEL also reserves the right to increase or decrease the tendered quantities. Bidders should be prepared to accept order for reduced quantity without any extra charges.
- b) Any discount / revised offer / bids submitted by a bidder on its own shall be considered, provided it is received on or before the due date and time of offer / bid submission (Part-1). Conditional discounts shall not be considered for evaluation of tenders.



BHARAT HEAVY ELECTRICALS LIMITED

HEEP-HARIDWAR, UTTARAKHAND (249403)

General Instructions and Standard Terms & Conditions for bidding against Tender Enquiry (GISTC)

For Indian Bidders (Version June-2021, Rev: 06)

- c) Unsolicited discounts / revised offers / bids given after Part-1 bid opening shall not be accepted. No change in price will be permitted within the validity period asked for in the tender enquiry.
- d) In case of changes in scope and / or technical specification and / or commercial terms & conditions having price implication, techno-commercially acceptable bidders shall be asked by BHEL to submit the impact of such changes on their price bids. In case a bidder opts to submit revised price bid instead of impact called for then the latest price bid shall prevail. However, in both situations, original price bid will be necessarily opened.
- e) The bidder whose bid is technically not accepted will be informed & EMD wherever submitted shall be returned after finalization of contract. EMD shall be forfeited in the event of bidder opting out after tender opening.
- f) BHEL reserves the right to short close the existing Purchase Order / Rate Contract / Work Order or any extension thereof at any stage.

17. TRANSIT INSURANCE.

- a) Transit Insurance will be covered by BHEL under its open Insurance Policy. Seller shall inform dispatch particulars (Purchase Order, RR /GR, Invoice value etc.) to "Finance department (Store bill Section), BHEL Ranipur, Haridwar (Uttarakhand-India) with value of consignment to the Purchaser within 07 days of dispatch for BHEL to arrange insurance coverage in its policy. Failure on the part of seller to inform dispatch particulars will make him liable to pay for any transit damages / losses suffered by the Purchaser.
- b) If Quoted Prices are inclusive of transit insurance, no weightage shall be given while evaluating the bids for Cost of Insurance, being in BHEL Scope.

18. RISK PURCHASE.

In case of abnormal delays (beyond the maximum late delivery period as per LD clause) in supplies / defective supplies or non-fulfillment of any other terms and conditions given in Purchase Order, BHEL may cancel the Purchase Order in full or part thereof, and may also make the purchase of such material from elsewhere / alternative source at the risk and cost of the supplier. BHEL will take all reasonable steps to get the material from alternate source at optimum cost. If bidder does not agree to the above Risk Purchase Clause, BHEL reserves the right to reject the offer. In case for compelling reasons BHEL accepts the offer without acceptance of this clause by the bidder and in the eventuality of Risk Purchase, appropriate action will be taken as per BHEL extant rules. This will be without prejudice to any other right of BHEL under the contract or under General Law.

19. FORCE MAJEURE CLAUSE.

Notwithstanding any other thing contained anywhere else in the contract or PO (Purchase Order), In case the discharge of obligation under the contract by either party is impeded or made unreasonably onerous, neither party shall be considered in breach of the contract to the extent that performance of their respective obligation is prevented by an event of Force Majeure that arises after the effective date (PO date).

In the above clause, Force Majeure means an event beyond the control of the parties to the contract which prevents a party from complying with any obligation of the contract including but not limited to:

- Act of God (Such as but not limited to earthquake, drought, tidal waves, floods etc.).
- War (whether war be declared or not), Hostilities Invasion, Act of foreign enemy etc.
- Rebellion, revolution, insurrection, civil war etc.
- Contamination of Radio Activity from any nuclear fuel or from any other nuclear waste or any other hazardous materials.
- Riots, commotions, strike unless restricted to the employees of supplier.
- Acts of terrorism.



BHARAT HEAVY ELECTRICALS LIMITED

HEEP-HARIDWAR, UTTARAKHAND (249403)

General Instructions and Standard Terms & Conditions for bidding against Tender Enquiry (GISTIC)

For Indian Bidders (Version June-2021, Rev: 06)

- g) Other unforeseeable circumstances beyond the control of the parties and which the affected party cannot avoid even by using its best efforts.
- h) Cancellation of contract by customer.
- i) Change in law / government. Regulation making the performance impossible.
- j) Pandemic or Epidemic.

The party claiming to be affected by force majeure shall notify the other party in writing immediately without delay on the intervention and on the cessation of such circumstances.

Irrespective of any extension of time, if an event of force majeure occurs and its effect continues for more than 180 days the affected party shall have right to cancel the contract.

As soon as reasonably practicable following the date of commencement of a Force Majeure Event, and within a reasonable time following the date of termination of a Force Majeure Event, either Party invoking it shall submit to the other Party reasonable proof of the nature of the Force Majeure Event and of its effect upon the performance of the Party's obligations under this Agreement.

The party shall, and shall ensure that its Subcontractors shall, at all times take all reasonable steps within their respective powers and consistent with Good Operating Practices (but without incurring unreasonable additional costs) to:

- a) Prevent Force Majeure Events affecting the performance of the party's obligations under this Agreement.
- b) mitigate the effect of any Force Majeure Event and
- c) Comply with its obligations under this Agreement.

If the war like situation has developed in a country where a seller's works is located in this P.O. or there is political instability and Indian Embassy located in that country forbids or advises for not having any business dealing with the sellers located in such zone / region/ country, then BHEL reserves the right to cancel the order.

20. NON-DISCLOSURE AGREEMENT.

All Drawing and Technical Documents relating to the product or it's manufacture submitted by one party to the other, prior or

subsequent to the formation of contract, shall remain property of the submitting party. Drawing, technical documents or other technical information received by one party, shall not without the consent of the other party, be used for any other purpose than that, for which they were provided. Such technical information shall not without the consent of the submitting party, otherwise be used or copied, reproduced, transmitted or communicated to a third party. Patterns supplied by BHEL will remain BHEL's property which shall be returned by the bidder on demand to BHEL. Bidder shall in no way share or use such intellectual property of BHEL to promote his own business with others or to gain a commercial advantage. BHEL reserves the right to claim damages from the bidder, or take appropriate action as deemed fit against the bidder, for any infringement of the provisions contained herein as available under law or equity.

21. SETTLEMENT OF DISPUTES / ARBITRATION.

In case of any dispute arising out of as in connection with this contract, the same shall be referred to arbitration under Arbitration & Conciliation Act 1996 of a sole arbitrator who shall be appointed by mutual consent of the parties. The seat & venue of arbitration shall be Haridwar.

The proceedings shall be conducted in English. The Governing law of contract shall be the substantive law of India.

22. WHARFAGE / DEMURRAGE RESPONSIBILITY.

In the event of delay in receipt of documents by Manager (Stores-Shipping) BHEL-Haridwar and in case where dispatches are made through Unapproved Transporter the sole responsibility for wharfage / demurrage for such delay shall be that of supplier.

23. CONDITIONS FOR AVAILING MICRO & SMALL ENTERPRISES (MSE'S) BENEFITS.

- a) "MSE Suppliers can avail the intended benefits only if they submit along with the offer, attested copies of either EM II certificate having deemed validity (**five years** from the date of issue of acknowledgement in EM II) or valid NSIC certificate or EM II certificate along with attested copy of a CA certificate



BHARAT HEAVY ELECTRICALS LIMITED

HEEP-HARIDWAR, UTTARAKHAND (249403)

General Instructions and Standard Terms & Conditions for bidding against Tender Enquiry (GISTC)

For Indian Bidders (Version June-2021, Rev: 06)

(Format enclosed at annexure-1 where deemed validity of EM II certificate of five years has expired) applicable for the relevant financial year (latest audited). Date to be reckoned for determining the deemed validity will be the date of bid opening (Part 1 in case of two-part bid) or vendor has to give Udyog Adhar Memorandum (UAM). Non submission of such documents will lead to consideration of their bid at par with other bidders. No benefit shall be applicable for this enquiry if any deficiency in the above required documents is found or the requisite documents are not submitted before price bid opening. If the tender is to be submitted through e-procurement portal, then the above require document are to be uploaded on the portal. Documents should be notarized or attested by a Gazetted officer. **UAM need not required to be notarized or attested.**

b) Any new supplier will be eligible for registration with BHEL as MSE supplier provided at least any one of the following documents are submitted along with application for registration: -

1. Udyog Adhar Memorandum (UAM).
2. Valid National Small Industries Commission (NSIC) Certificate.
3. Entrepreneurs Memorandum part II (EM II) certificate (valid based on deemed validity of 5 years) or
4. EM II certificate along with attested copy of CA Certificate (as per prescribed format at annexure-A) applicable for the relevant financial year (latest audited), where the deemed validity of EM II is over.
5. However, credentials of all MSE suppliers will be verified before advancing the intended benefits.
6. MSE bidders claiming SC/ST status will have to submit SC/ST certificate of the Proprietor from competent authority. Attested (notarized or attested by Gazetted officer) copy to be submitted along with the offer.
7. In case techno-commercial accepted bidders include MSE source and their prices (based on landed cost – considering quoted prices) are within the price band of 15% w.r.t. L-1 bidder, then BHEL can offer **25%** of quantity of respective item (rounded off to nearest number) to MSE bidders at L-1 price and in case, more than one MSE bidder is in 15 % band and the same is accepted by more than one MSE bidders then **25%** quantities of respective items will be considered for ordering on proportionate basis amongst MSE bidders.
8. There will be minimum of **3%** reservation for women owned MSEs within the above mentioned 25% reservation.
9. The reservation for MSEs owned by SC/ST will be **6.25%** { 25% out of target of 25% - refer para 4 of Public Procurement Policy for the Micro and Small Enterprises(MSEs)}.
10. The definition of MSEs owned by Women Entrepreneurs is clarified as under:
 - a) In case of proprietary MSE, proprietor shall be Woman.
 - b) In case of partnership MSE, the Woman partners shall be holding at least 51% of share in the unit.
 - c) In case of Private Limited companies, at least 51% share shall be held by Women promoters.
11. The definition of MSEs owned by SC/ST is clarified as under:
 - a) In case of proprietary MSE, proprietor(s) shall be SC/ST.
 - b) In case of partnership MSE, the SC/ST partners shall be holding at least 51% of shares in the unit.
 - c) In case of Private Limited companies, at least 51% share shall be held by SC/ST promoters.
12. While distributing the **25%** quantity amongst MSE bidders the decimal points in quantity shall be ignored for all the bidders except the L-1 amongst MSE bidders. Balance quantity after allocating the quantity to other MSE bidders ignoring the quantities in decimal, shall be given to L-1 (amongst MSE) bidder. However, if there are more than one MSE bidder at the same price level than preference for additional quantities due to ignoring off the decimal (as mentioned above) shall be given to the bidder offering favorable terms to BHEL and if the conditions offered are also same then preference will be given to the bidder having high SPR rating.
13. In case there are more than one MSE bidders (with different landed cost to BHEL) within 15% price band of lowest bidder and quantity to be offered is 1 no. only, then preference shall be given to the MSE bidder with lowest landed cost.
14. In case there are more than one MSE bidders (with same landed cost to BHEL) within 15% price band of lowest bidder and quantity to be offered is 1 no. only, then preference shall be given first, based on the favorable terms in the bid and in case terms are also same, the bidder with high SPR rating shall be given preference.
15. If L1 bidder is MSE bidder, entire quantity will be given to such MSE bidder only.

Quotations / Bids not in accordance with General Instructions and Standard Terms & Conditions are likely to be ignored.



BHARAT HEAVY ELECTRICALS LIMITED

HEEP-HARIDWAR, UTTARAKHAND (249403)

General Instructions and Standard Terms & Conditions for bidding against Tender Enquiry (GISTIC)

For Indian Bidders (Version June-2021, Rev: 06)

16. Note: It may however be noted that MSE guidelines as on date (Date of Technical Bid Opening Part-1) shall prevail.

17. "As per the OM No. F.No. 1(2)(1)/2016-MA dtd. 09.02.2017 issued from the Office of Development Commissioner (Micro, Small & Medium Enterprises), "Traders and agents should not be allowed to avail the benefits extended under the PP Policy."

In view of this, it is clarified that benefits of MSE (such as EMD Waiver, Tender fee exemption, Price preference, Payment preference etc.) will be given only to those MSE Vendors who are manufacturers of offered items against the NIT. No MSE benefits shall be provided to Agents / Stockists / Dealers / Traders etc. for the items offered but not manufactured by themselves."

24. INFORMATION TO THE BIDDERS.

a) Purchase related information is available at our Business-to-Business (B2B) Portal available on our website <https://hwr.bhel.com>. The user ID & password can be obtained by sending a request to concerned purchase executives.

b) Intimate your change in mail address or communication address or changes, if any, by email to AGM (SDX/MM) giving your bidder Code.

c) Please resolve your rejections and unexecuted overdue purchase order immediately which are posted at our B2B Portal, which can be visited through our site <https://hwr.bhel.com>

d) Copy of this Tender Enquiry is being sent through the post.

e) The Bidder declares that they will not enter into any illegal or undisclosed agreement or understanding, whether formal or informal with other bidder(s). This applies in particular to prices, specifications, certifications, subsidiary contracts, submission or non-submission of bids or any other actions to restrict competitiveness or to introduce cartelization in the bidding process.

In case, the bidder is found having indulged in above activities, suitable action shall be taken by BHEL as per extant policies/guidelines.

f) Supplier must upload digitally signed e-Invoice on B2B portal for processing of Bills.

In other cases, inked signed hard copy of Invoice to be submitted for processing of Bills.

25. MAKE IN INDIA (GOVT-NOTIFICATION).

A. This tender enquiry shall be governed by notification no. P-45021/2/2017-PP (BE-II) dated 04.06.2020 of government of INDIA and subsequent circulars issued afterwards. Accordingly, the minimum local content, the margin of purchase preference and the procedure for preference to make in INDIA shall be adhered.

B. The margin of purchase preference shall be 20%.

- 'Class-I local Supplier' means a supplier or service provider, whose goods, services or works offered for procurement, has local content equal to or more than 50%, as defined under this order.
- 'Class-II local Supplier' means a supplier or service provider, whose goods, services or works offered for procurement, has local content more than 20% but less than 50%, as defined under this order.
- 'Non- local Supplier' means a supplier or service provider, whose goods, services or works offered for procurement, has local content less than or equal to 20%, as defined under this order.

C. Vendor to specifically confirm if they are Class-I or Class-II local supplier or not as per above mentioned notification. Accordingly, the 'Class-I local supplier' / 'Class-II local Supplier' at the time of tender, bidding or solicitation shall be required to indicate percentage of local content and provide self-certification that the item offered meets the local content requirement for 'Class-I local supplier' / 'Class-II local Supplier', as the case may be. They shall also give details of the location(s) at which the local value addition is made.

D. In cases of Procurement for a Value in Excess of Rs. 10 Crores, the 'Class-I local supplier' / 'Class-II local Supplier' shall be required to provide a Certificate from the Statutory Auditor or Cost Auditor of the Company (in the case of companies) or from a practicing Cost Accountant or practicing Chartered Accountant (in respect of suppliers other than companies) giving the percentage of Local Content.



BHARAT HEAVY ELECTRICALS LIMITED

HEEP-HARIDWAR, UTTARAKHAND (249403)

General Instructions and Standard Terms & Conditions for bidding against Tender Enquiry (GISTC)

For Indian Bidders (Version June-2021, Rev: 06)

E. Requirement of Purchase Preference:

Purchase preference shall be given to 'Class-I local supplier' in procurements undertaken by procuring entities in the manner specified hereunder -

a. In the procurements of goods or works, which are covered by para 3(b) of mentioned Govt. circular and which are divisible in nature, the 'class-I local supplier' shall get purchase preference over 'Class-II supplier' as well as 'Non-local supplier', as per following procedure:

- i. Among All qualified bids, the lowest bid will be termed as L1. If L1 is 'Class-I local supplier', the contract for full quantity will be awarded to L1.
- ii. If L1 bid is not a 'Class-I local supplier', 50% of the order quantity shall be awarded to L1. Thereafter, the lowest bidder among the 'Class-I local supplier' will be invited to match the L1 price for the remaining 50% quantity subject to the class-I local supplier's quoted price falling within the margin of purchase preference, and contract for that quantity shall be awarded to such 'Class-I local supplier' subject to matching the L1 price. In case such lowest eligible 'Class-I local supplier' fails to match the L1 price or accepts less than the offered quantity, the next higher 'Class-I local supplier' within the margin of purchase preference shall be invited to match the L1 price for remaining quantity and so on, and contract shall be awarded accordingly. In case some quantity is still left uncovered on Class-I local supplier, then such balance quantity may also be ordered on the L1 bidder".

b. In the procurements of goods or works, which are covered by para 3(b) of mentioned Govt. circular and which are not divisible in nature, and in procurement of services where the bid is evaluated on price alone, the 'class-I local supplier' shall get purchase preference over 'Class-II supplier' as well as 'Non-local supplier', as per following procedure:

- i. Among all qualified bids, the lowest bid will be termed as L1. If L1 is 'Class-I local supplier', the contract will be awarded to L1.
- ii. If L1 is not 'Class-I local supplier', the lowest bidder among the 'Class-I local supplier', will be invited to match the L1 price subject to Class-I local supplier's quoted price falling

within the margin of purchase preference, and the contract shall be awarded to such 'Class-I local supplier' subject to matching the L1 price.

- iii. In case such lowest eligible 'Class-I local supplier', fails to match the L1 price, the 'Class-I local supplier' with the next higher bid within the margin of purchase preference shall be invited to match the L1 price and so on and contract shall be awarded accordingly. In case none of the 'Class-I local supplier' within the margin of purchase preference matches the L1 prices, the contract may be awarded to the L1 bidder.

c. 'Class-II local supplier' will not get purchase preference in any procurement, undertaken by procuring entities.

F. For this procurement, the local content to categorize a supplier as a Class-I local supplier/ Class-II local supplier/ Non-local supplier and purchase preference to Class-I local supplier, is as defined in Public Procurement (Preference to Make in India), Order 2017 dated 04.06.2020 issued by DPIIT. In case of subsequent orders issued by nodal ministry, changing the definition of local content for the items of the NIT, the same shall be applicable even if issued after issue of this NIT, but before opening of Part-II bids against this NIT.

G. Procurements where estimated value to be procured is less than Rs. 5 lakhs shall be exempted from GOI order No. P-45021/2/2017-PP (BE-II) dated 04.06.2020.

H. For procurement of Goods & Services which are divisible in nature, following shall be operated for **MSE bidders** under Public procurement Policy for the Micro and Small Enterprises (MSEs) Amendment Order, 2019, Ref. No. AA:SSP: MSE: Amndt, dtd. 30.11.2018, Circular No. 44 of 2018-19;-

a. If L1 bid is not from "Class-I local Supplier" and price quoted by MSE bidder falls within the margin of Purchase preference (L1+15% for MSEs), then 25 % of total order quantity of respective item (rounded off to nearest number) shall be awarded to MSE bidder, subject to MSE bidder matching the L1 Price. Out of Remaining 75% quantity, distribution shall be operated as per below sub-clause (2) –

b. If "Class- I Local Supplier" (Next to L1, other than MSE) quoted price falling within the Margin of Purchase Preference, and "Class-I local supplier" matches the L1 price,



BHARAT HEAVY ELECTRICALS LIMITED

HEEP-HARIDWAR, UTTARAKHAND (249403)

General Instructions and Standard Terms & Conditions for bidding against Tender Enquiry (GISTC)

For Indian Bidders (Version June-2021, Rev: 06)

then 50% of remaining Quantity (after allocation of 25% to MSE) i.e. 37.5% shall be awarded to local supplier and 37.5% shall be awarded to foreign bidder.

Note: L1 Price refers to lowest evaluated / landed cost to Company.

For Further details, please refer GOI order no. P-45021 / 2 / 2017 - PP (BE-II) dated 04.06.2020.

26. RESTRICTIONS UNDER RULE 144(XI) OF THE GENERAL FINANCIAL RULES (GFRs), 2017

All provisions of Order No. F.No.6/18/2019-PPD of Department of Expenditure (DoE) shall be applicable for this tender enquiry (Order copy is available at <https://doe.gov.in/procurement-policy-divisions>). Accordingly, any bidder from a country which shares a land border with India (except the countries to which the Govt. of India has extended lines of credit or in which the Govt. of India is engaged in development projects for which list is available at <https://www.mea.gov.in/>) will be eligible to bid in this tender only if the bidder is registered with the Competent Authority as specified in Annex I of the said Order of DoE.

Updated list of the countries to which lines of credit have been extended or in which development projects are undertaken are available on the Ministry of External affairs website (<https://www.mea.gov.in/>)

For the purpose of this order, definition of Bidder from a country which shares a land border with India shall be same as defined in the Annex III of the said order.

Registration with the competent authority as stipulated in the said order is responsibility of bidder. Bidder has to submit a certificate certifying following along with offer:

"I have read the clause regarding restrictions on procurement from a bidder of a country which shares a land border with India; I certify that bidder (.... Name of Bidder) is not from such a country or, if from such a country, has been registered with the Competent Authority. I hereby certify that bidder (.....Name of bidder) fulfils all requirements in this regard and is eligible to be considered"

If the bidder is from such country which shares a land border with India evidence of valid registration by the Competent Authority shall also be attached along with offer."

27. NOTE.

- a) Special conditions of enquiry, if enclosed by BHEL, will supersede the respective standard / general terms of enquiry.
- b) Any other Standard terms and Conditions of the bidder attached / referred against the tender enquiry will be treated as null and void ab initio.
- c) In order to protect the commercial interests of BHEL, it becomes necessary to take action against suppliers / contractors by way of suspension of business dealings, who either fail to perform or are in default without any reasonable cause, cause loss of business / money / reputation, indulged in malpractices, cheating, bribery, fraud or any other misconducts or formation of cartel so as to influence the bidding process or influence the price etc. Guide- lines for Suspension of Business Dealings with Suppliers / Contractors shall prevail over which is available at BHEL website <http://www.bhel.com>
- d) The bidder along with its associate / collaborators / sub-contractors / sub-vendors / consultants / service providers shall strictly adhere to BHEL Fraud Prevention Policy displayed on BHEL website <http://www.bhel.com> and shall immediately bring to the notice of BHEL-Management about any fraud or suspected fraud as soon as it comes to their notice.
- e) "BHEL shall recover the amount of compensation paid to victim(s) by BHEL towards loss of life / permanent disability due to an accident which is attributable to the negligence of contractor, agency or firm or any of its employees as detailed below;
 1. **Victim:** Any person who suffers permanent disablement or dies in an accident as defined below.
 2. **Accident:** Any death or permanent disability resulting solely and directly from any unintended and unforeseen injurious

Quotations / Bids not in accordance with General Instructions and Standard Terms & Conditions are likely to be ignored.



BHARAT HEAVY ELECTRICALS LIMITED

HEEP-HARIDWAR, UTTARAKHAND (249403)

General Instructions and Standard Terms & Conditions for bidding against Tender Enquiry (GISTC)

For Indian Bidders (Version June-2021, Rev: 06)

occurrence caused during the manufacturing / operation and works incidental thereto at BHEL factories/ **offices and precincts** thereof , project execution , erection and commissioning, services, repairs and maintenance, trouble shooting, serving , overhaul, renovation and retrofitting , trial operation, performance guarantee testing undertaken by the company or during any works / during working at BHEL Units/ Offices/ townships and premises/ project sites.

3. Compensation in respect of each of the victims:

- (i) In the event of death or **permanent disability** resulting from **Loss of both limbs**: Rs. 10,00,000/- (Rs. Ten Lakh).
- (ii) In the event of **other permanent disability**: Rs. 7,00,000/- (Rs. Seven Lakh).

4. Permanent Disablement: A disablement that is classified as a permanent total disablement under the proviso to Section 2(l) of the Employees Compensation Act, 1923.”

f) The bidder shall be in compliance with applicable laws, rules and regulations throughout the terms of the contract for conducting its business generally and to perform its obligations under this contract.

INTEGRITY PACT**Between**

Bharat Heavy Electricals Ltd. (BHEL), a company registered under the Companies Act 1956 and having its registered office at "BHEL House", Siri Fort, New Delhi - 110049 (India) hereinafter referred to as "The Principal", which expression unless repugnant to the context or meaning hereof shall include its successors or assigns of the ONE PART

and

_____, (description of the party along with address), hereinafter referred to as "The Bidder/ Contractor" which expression unless repugnant to the context or meaning hereof shall include its successors or assigns of the OTHER PART

Preamble

The Principal intends to award, under laid-down organizational procedures, contract/s for _____

_____ (hereinafter referred to as "Contract"). The Principal values full compliance with all relevant laws of the land, rules and regulations, and the principles of economic use of resources, and of fairness and transparency in its relations with its Bidder(s)/ Contractor(s).

In order to achieve these goals, the Principal will appoint panel of Independent External Monitor(s) (IEMs), who will monitor the tender process and the execution of the contract for compliance with the principles mentioned above.

Section 1- Commitments of the Principal

- 1.1 The Principal commits itself to take all measures necessary to prevent corruption and to observe the following principles: -
 - 1.1.1 No employee of the Principal, personally or through family members, will in connection with the tender for, or the execution of a contract, demand, take a promise for or accept, for self or third person, any material or immaterial benefit which the person is not legally entitled to.
 - 1.1.2 The Principal will, during the tender process treat all Bidder(s) with equity and reason. The Principal will in particular, before and during the tender process, provide to all Bidder(s) the same information and will not provide to any Bidder(s) confidential/ additional information through which the Bidder(s) could obtain an advantage in relation to the tender process or the contract execution.
 - 1.1.3 The Principal will exclude from the process all known prejudiced persons.
- 1.2 If the Principal obtains information on the conduct of any of its employees which is a penal offence under the Indian Penal Code 1860 and Prevention of Corruption Act 1988 or any other statutory penal enactment, or if there be a substantive suspicion in this regard, the Principal will inform its Vigilance Office and in addition can initiate disciplinary actions.

Section 2 - Commitments of the Bidder(s)/ Contractor(s)

- 2.1 The Bidder(s)/ Contractor(s) commit himself to take all measures necessary to prevent corruption. The Bidder(s)/ Contractor(s) commits himself to observe the following principles during participation in the tender process and during the contract execution.

- 2.1.1 The Bidder(s)/ Contractor(s) will not, directly or through any other person or firm, offer, promise or give to the Principal or to any of the Principal's employees involved in the tender process or the execution of the contract or to any third person any material, immaterial or any other benefit which he/ she is not legally entitled to, in order to obtain in exchange any advantage of any kind whatsoever during the tender process or during the execution of the contract.
- 2.1.2 The Bidder(s)/ Contractor(s) will not enter with other Bidder(s) into any illegal or undisclosed agreement or understanding, whether formal or informal. This applies in particular to prices, specifications, certifications, subsidiary contracts, submission or non-submission of bids or any other actions to restrict competitiveness or to introduce cartelization in the bidding process.
- 2.1.3 The Bidder(s)/ Contractor(s) will not commit any penal offence under the relevant Indian Penal Code (IPC) and Prevention of Corruption Act; further the Bidder(s)/ Contractor(s) will not use improperly, for purposes of competition or personal gain, or pass on to others, any information or document provided by the Principal as part of the business relationship, regarding plans, technical proposals and business details, including information contained or transmitted electronically.
- 2.1.4 Foreign Bidder(s)/ Contractor(s) shall disclose the name and address of agents and representatives in India and Indian Bidder(s)/ Contractor(s) to disclose their foreign principals or associates. The Bidder(s)/ Contractor(s) will, when presenting his bid, disclose any and all payments he has made, and is committed to or intends to make to agents, brokers or any other intermediaries in connection with the award of the contract.
- 2.2 The Bidder(s)/ Contractor(s) will not instigate third persons to commit offences outlined above or be an accessory to such offences.
- 2.3 The Bidder(s)/ Contractor(s) shall not approach the Courts while representing the matters to IEMs and shall await their decision in the matter.

Section 3 - Disqualification from tender process and exclusion from future contracts

If the Bidder(s)/ Contractor(s), before award or during execution has committed a transgression through a violation of Section 2 above, or acts in any other manner such as to put his reliability or credibility in question, the Principal is entitled to disqualify the Bidder(s)/ Contractor(s) from the tender process, terminate the contract, if already awarded, exclude from future business dealings and/ or take action as per the separate "Guidelines on Banning of Business dealings with Suppliers/ Contractors", framed by the Principal.

Section 4 - Compensation for Damages

- 4.1 If the Principal has disqualified the Bidder (s) from the tender process before award / order acceptance according to Section 3, the Principal is entitled to demand and recover the damages equivalent to Earnest Money Deposit/ Bid Security.
- 4.2 If the Principal is entitled to terminate the Contract according to Section 3, or terminates the Contract in application of Section 3 above, the Bidder(s)/ Contractor (s) transgression through a violation of Section 2 above shall be construed breach of contract and the Principal shall be entitled to demand and recover from the Contractor an amount equal to 5% of the contract value or the amount equivalent to Security Deposit/ Performance Bank Guarantee, whichever is higher, as damages, in addition to and without prejudice to its right to demand and recover compensation for any other loss or damages specified elsewhere in the contract.

Section 5 - Previous Transgression

- 5.1 The Bidder declares that no previous transgressions occurred in the last 3 (three) years with any other company in any country conforming to the anti-corruption approach or with any other Public Sector Enterprise in India that could justify his exclusion from the tender process.
- 5.2 If the Bidder makes incorrect statement on this subject, he can be disqualified from the tender process or the contract, if already awarded, can be terminated for such reason or action can be taken as per the separate "Guidelines on Banning of Business dealings with Suppliers/ Contractors", framed by the Principal.

Section 6 - Equal treatment of all Bidder (s)/ Contractor (s) / Sub-contractor (s)

- 6.1 The Principal will enter into Integrity Pacts with identical conditions as this Integrity Pact with all Bidders and Contractors.
- 6.2 In case of Sub-contracting, the Principal Contractor shall take the responsibility of the adoption of Integrity Pact by the Sub-contractor(s) and ensure that all Sub-contractors also sign the Integrity Pact.
- 6.3 The Principal will disqualify from the tender process all Bidders who do not sign this Integrity Pact or violate its provisions.

Section 7 - Criminal Charges against violating Bidders/ Contractors /Subcontractors

If the Principal obtains knowledge of conduct of a Bidder, Contractor or Subcontractor, or of an employee or a representative or an associate of a Bidder, Contractor or Subcontractor which constitutes corruption, or if the Principal has substantive suspicion in this regard, the Principal will inform the Vigilance Office.

Section 8 -Independent External Monitor(s)

- 8.1 The Principal appoints competent and credible panel of Independent External Monitor (s) (IEMs) for this Integrity Pact. The task of the IEMs is to review independently and objectively, whether and to what extent the parties comply with the obligations under this Integrity Pact.
- 8.2 The IEMs are not subject to instructions by the representatives of the parties and performs his functions neutrally and independently. He reports to the CMD, BHEL.
- 8.3 The IEMs shall be provided access to all documents/ records pertaining to the Contract, for which a complaint or issue is raised before them as and when warranted. However, the documents/records/information having National Security implications and those documents which have been classified as Secret/Top Secret are not to be disclosed.
- 8.4 The Principal will provide to the IEMs sufficient information about all meetings among the parties related to the Contract provided such meetings could have an impact on the contractual relations between the Principal and the Contractor. The parties offer to the IEMs the option to participate in such meetings.

- 8.5 The advisory role of IEMs is envisaged as that of a friend, philosopher and guide. The advice of IEMs would not be legally binding and it is restricted to resolving issues raised by a Bidder regarding any aspect of the tender which allegedly restricts competition or bias towards some Bidders. At the same time, it must be understood that IEMs are not consultants to the Management. Their role is independent in nature and the advice once tendered would not be subject to review at the request of the organization.
- 8.6 For ensuring the desired transparency and objectivity in dealing with the complaints arising out of any tendering process or during execution of Contract, the matter should be examined by the full panel of IEMs jointly, who would look into the records, conduct an investigation, and submit their joint recommendations to the Management.
- 8.7 The IEMs would examine all complaints received by them and give their recommendations/ views to the CMD, BHEL at the earliest. They may also send their report directly to the CVO, in case of suspicion of serious irregularities requiring legal/ administrative action. Only in case of very serious issue having a specific, verifiable Vigilance angle, the matter should be reported directly to the Commission. IEMs will tender their advice on the complaints within 30 days.
- 8.8 The CMD, BHEL shall decide the compensation to be paid to the IEMs and its terms and conditions.
- 8.9 IEMs should examine the process integrity, they are not expected to concern themselves with fixing of responsibility of officers. Complaints alleging mala fide on the part of any officer of the Principal should be looked into by the CVO of the Principal.
- 8.10 If the IEMs have reported to the CMD, BHEL, a substantiated suspicion of an offence under relevant Indian Penal Code / Prevention of Corruption Act, and the CMD, BHEL has not, within reasonable time, taken visible action to proceed against such offence or reported it to the Vigilance Office, the IEMs may also transmit this information directly to the Central Vigilance Commissioner, Government of India.
- 8.11 After award of work, the IEMs shall look into any issue relating to execution of Contract, if specifically raised before them. As an illustrative example, if a Contractor who has been awarded the Contract, during the execution of Contract, raises issue of delayed payment etc. before the IEMs, the same shall be examined by the panel of IEMs. Issues like warranty/ guarantee etc. shall be outside the purview of IEMs.
- 8.12 However, the IEMs may suggest systemic improvements to the management of the Principal, if considered necessary, to bring about transparency, equity and fairness in the system of procurement.
- 8.13 The word 'Monitor' would include both singular and plural.

Section 9 - Pact Duration

- 9.1 This Integrity Pact shall be operative from the date this Integrity Pact is signed by both the parties till the final completion of contract for successful Bidder, and for all other Bidders 6 months after the Contract has been awarded. Any violation of the same would entail disqualification of the bidders and exclusion from future business dealings.
- 9.2 If any claim is made/ lodged during currency of this Integrity Pact, the same shall be binding and continue to be valid despite the lapse of this Pact as specified above, unless it is discharged/ determined by the CMD, BHEL.

Section 10 - Other Provisions

- 10.1 This Integrity Pact is subject to Indian Laws and exclusive jurisdiction shall be of the competent Courts as indicated in the Tender or Contract, as the case may be.
- 10.2 Changes and supplements as well as termination notices need to be made in writing.
- 10.3 If the Bidder(s)/ Contractor(s) is a partnership or a consortium or a joint venture, this Integrity Pact shall be signed by all partners of the partnership or joint venture or all consortium members.
- 10.4 Should one or several provisions of this Integrity Pact turn out to be invalid, the remainder of this Integrity Pact remains valid. In this case, the parties will strive to come to an agreement to their original intentions.
- 10.5 Only those bidders / contractors who have entered into this Integrity Pact with the Principal would be competent to participate in the bidding. In other words, entering into this Integrity Pact would be a preliminary qualification.
- 10.6 In the event of any dispute between the Principal and Bidder(s)/ Contractor(s) relating to the Contract, in case, both the parties are agreeable, they may try to settle dispute through Mediation before the panel of IEMs in a time bound manner. In case, the dispute remains unresolved even after mediation by the panel of IEMs, either party may take further action as the terms & conditions of the Contract. The fees/expenses on dispute resolution through mediation shall be shared by both the parties. Further, the mediation proceedings shall be confidential in nature and the parties shall keep confidential all matters relating to the mediation proceedings including any settlement agreement arrived at between the parties as outcome of mediation. Any views expressed, suggestions, admissions or proposals etc. made by either party in the course of mediation shall not be relied upon or introduced as evidence in any further arbitral or judicial proceedings, whether or not such proceedings relate to the dispute that is the subject of mediation proceedings. Neither of the parties shall present IEMs as witness in any Alternative Dispute Resolution or judicial proceedings in respect of the dispute that was subject of mediation.

 For & On behalf of the Principal
 (Office Seal)

 For & On behalf of the Bidder/ Contractor
 (Office Seal)

Place _____
 Date _____

Witness: _____
 (Name & Address) _____

Witness: _____
 (Name & Address) _____

Clause on IP in the tender

Integrity Pact (IP)

- (a) IP is a tool to ensure that activities and transactions between the Company and its Bidders/ Contractors are handled in a fair, transparent and corruption free manner. Following Independent External Monitors (IEMs) on the present panel have been appointed by BHEL with the approval of CVC to oversee implementation of IP in BHEL.

SI	IEM	Email
1.	Shri Otem Dai, IAS (Retd.)	iem1@bhel.in
2.	Shri Bishwamitra Pandey, IRAS (Retd.)	iem2@bhel.in
3.	Shri Mukesh Mittal, IRS (Retd.)	iem3@bhel.in

- (b) The IP as enclosed with the tender is to be submitted (duly signed by authorized signatory) along with techno-commercial bid (Part-I, in case of two/ three part bid). Only those bidders who have entered into such an IP with BHEL would be competent to participate in the bidding. In other words, entering into this Pact would be a preliminary qualification.
- (c) Please refer Section-8 of IP for Role and Responsibilities of IEMs. In case of any complaint arising out of the tendering process, the matter may be referred to any of the above IEM(s). All correspondence with the IEMs shall be done through email only.

Note:

No routine correspondence shall be addressed to the IEM (phone/ post/ email) regarding the clarifications, time extensions or any other administrative queries, etc on the tender issued. All such clarification/ issues shall be addressed directly to the tender issuing (procurement) department's officials whose contact details are provided below:

Details of contact person(s):

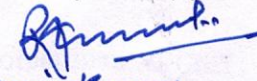
(1) 
Name: Ravi Kumar
Deptt: PPX-T
Address: BHEL, HEEP, HARIDWAR
Phone: (Landline/ Mobile)
01334-281275
Email: RaviKumar.2@bhel.in
Fax: _____

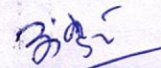
(2) 
Name: ANKUR MEGHANI
Deptt: PPX-T
Address: BHEL, HEEP, HARIDWAR
Phone: (Landline/ Mobile)
01334-281274
Email: ankur.meghani@bhel.in
Fax: _____

एनटीपीसी NTPC	CORPORATE QUALITY ASSURANCE/ कॉर्पोरेट गुणवत्ता आश्वासन SUB-VENDOR QUESTIONNAIRE/ सब-वेंडर प्रश्नावली
--------------------------	--

i.	Item/Scope of Sub-contracting उप-संविदा(अनुबंध) का मद/ दायरा	
ii.	Address of the registered office पंजीकृत कार्यालय का पता	Details of Contact Person संपर्क व्यक्ति का विवरण (Name, Designation, Mobile, Email) (नाम, पदनाम, मोबाइल, ईमेल)
iii.	Name and Address of the proposed Sub-vendor's works where item is being manufactured प्रस्तावित उप-विक्रेता के कार्यों का नाम और पता, जहां मद का निर्माण किया जा रहा है	Details of Contact Person: संपर्क व्यक्ति का विवरण (Name, Designation, Mobile, Email) (नाम, पदनाम, मोबाइल, ईमेल)
iv.	Annual Production Capacity for proposed item/scope of sub-contracting उप-संविदा(अनुबंध) के प्रस्तावित मद / दायरे के लिए वार्षिक उत्पादन क्षमता	
v.	Annual production for last 3 years for proposed item/scope of sub-contracting उप-संविदा(अनुबंध) के प्रस्तावित मद / दायरे के लिए पिछले 3 वर्षों का वार्षिक उत्पादन	
vi.	Details of proposed works प्रस्तावित कार्यों का विवरण	
1.	Year of establishment of present works वर्तमान फैक्टरी की स्थापना का वर्ष	
2.	Year of commencement of manufacturing at above works उपरोक्त फैक्टरी में निर्माण कार्य शुरू होने का वर्ष	
3.	Details of change in Works address in past (if any) पूर्व में फैक्टरी स्थल में परिवर्तन का विवरण (यदि कोई हो)	
4.	Total Area कुल क्षेत्र Covered Area शामिल क्षेत्र	
5.	Factory Registration Certificate फैक्टरी पंजीकरण प्रमाण पत्र	Details attached at Annexure – F2.1 विवरण अनुलग्नक- एफ 2.1 पर संलग्न है
6.	Design/ Research & development set-up डिजाइन / अनुसंधान और विकास सेटअप (No. of manpower, their qualification, machines & tools employed etc.) (श्रमिकों की संख्या, उनकी योग्यता, मशीन और उपलब्ध उपकरण आदि)	Applicable / Not applicable if manufacturing is as per Main Contractor/purchaser design Details attached at Annexure – F2.2 (if applicable) लागू / लागू नहीं, अगर विनिर्माण मुख्य संविदाकार / खरीददार के डिजाइन के अनुसार है। विवरण अनुलग्नक –एफ 2.2 पर संलग्न है। (यदि लागू हो)
7.	Overall organization Chart with Manpower Details (Design/Manufacturing/Quality etc) मैनपावर विवरण के साथ समग्र संगठन का चार्ट(डिजाइन / विनिर्माण / गुणवत्ता आदि)	Details attached at Annexure – F2.3 विवरण अनुलग्नक – F2.3 में संलग्न है।
8.	After sales service set up in India, in case of foreign sub-vendor(Location, Contact Person, Contact details etc.) भारत	Applicable / Not applicable लागू / लागू नहीं

	में विक्री सेवा की स्थापना के बाद, विदेशी उप-विक्रेता के मामले में(स्थल , संपर्क व्यक्ति, संपर्क विवरण आदि)	<i>Details attached at Annexure – F2.4</i> विवरण अनुलग्नक -2.4 पर संलग्न है।			
9.	<i>Manufacturing process execution plan with flow chart indicating various stages of manufacturing from raw material to finished product including outsourced process, if any</i> फ्लोचार्ट सहित विनिर्माण प्रक्रिया निष्पादन योजना , जिसमें आउटसोर्स प्रक्रिया, यदि कोई हो, सहित कच्चे माल से तैयार उत्पाद तक विनिर्माण के विभिन्न चरणों को दर्शाया गया हो,	<i>Details attached at Annexure – F2.5</i> विवरण अनुलग्नक - F2.5में संलग्न है।			
10.	<i>Sources of Raw Material/Major Bought Out Item</i> कच्चे माल के स्रोत / खरीदे हुए मुख्य मद	<i>Details attached at Annexure – F2.6</i> विवरण अनुलग्नक - F2.6में संलग्न है।			
11.	<i>Quality Control exercised during receipt of raw material/BOI, in-process , Final Testing, packing</i> कच्चे माल / खरीदे हुए मद, प्रक्रियाबद्ध, अंतिम परीक्षण, पैकिंग करते समय गुणवत्ता नियंत्रण	<i>Details attached at Annexure – F2.7</i> विवरण अनुलग्नक - F2.7 पर संलग्न है			
12.	<i>Manufacturing facilities (List of machines, special process facilities, material handling etc.)</i> विनिर्माण सुविधा(मशीनों की सूची, विशेष प्रक्रिया सुविधाएं, सामग्री रख-रखाव आदि)	<i>Details attached at Annexure – F2.8</i> विवरण अनुलग्नक - F2.8में संलग्न है।			
13.	<i>Testing facilities (List of testing equipment)</i> परीक्षण सुविधाएं(परीक्षण उपकरण की सूची)	<i>Details attached at Annexure – F2.9</i> विवरण अनुलग्नक – F2. 9 में संलग्न है।			
14.	<i>If manufacturing process involves fabrication then-</i> यदि निर्माण प्रक्रिया में फेब्रिकेशन की गई है तो- <i>List of qualified Welders</i> पात्र वेल्डर की सूची <i>List of qualified NDT personnel with area of specialization</i> विशेषज्ञता के क्षेत्र सहित पात्र एनडीटी कार्मिकों की सूची	<i>Applicable / Not applicable</i> लागू / लागू नहीं <i>Details attached at Annexure – F2.10</i> विवरण अनुलग्नक - F2.10में संलग्न है। <i>(if applicable)</i> लागू / लागू नहीं			
15.	<i>List of out-sourced manufacturing processes with Sub-Vendors' names & addresses</i> सब-वेंडर द्वारा बाह्य स्रोतों (उनके नाम और पते सहित)से करवाएं गए निर्माण प्रक्रियाओं की सूची	<i>Applicable / Not applicable</i> लागू / लागू नहीं <i>Details attached at Annexure. –F2.11</i> विवरण अनुलग्नक - F2.10में संलग्न है। <i>(if applicable)</i> (यदि लागू हो)			
16.	<i>Supply reference list including recent supplies</i> नवीनतम आपूर्ति सहित आपूर्ति संदर्भ सूची	<i>Details attached at Annexure – F2.12</i> विवरण अनुलग्नक - F2.12 में संलग्न है। <i>(as per format given below)</i> (नीचे दिए गए प्रारूप के अनुसार)			
<i>Project/ package परियोजना /पैकेज</i>	<i>Customer Name</i> ग्राहक का नाम	<i>Supplied Item (Type/Rating/Model /Capacity/Size etc)</i> आपूर्ति की गई वस्तु (प्रकार / रेटिंग / मॉडल / क्षमता / आकार आदि)	<i>PO ref no/date</i> पीओ संदर्भ सं. / तिथि	<i>Supplied Quantity</i> आपूर्ति की मात्रा	<i>Date of Supply</i> आपूर्ति की तारीख
17.	<i>Product satisfactory performance feedback letter/certificates/End User Feedback</i> उत्पाद के संतोषजनक प्रदर्शन संबंधी फीडबैक पत्र / प्रमाण पत्र / अंतिम उपयोगकर्ता फीडबैक			<i>Attached at annexure - F2.13</i> अनुलग्नक F2. 3पर संलग्न है	
18.	<i>Summary of Type Test Report (Type Test Details, Report No, Agency, Date of testing) for the proposed product</i>			<i>Applicable / Not applicable</i> लागू / लागू नहीं	

**CORPORATE QUALITY ASSURANCE/ कॉर्पोरेट गुणवत्ता आश्वासन****SUB-VENDOR QUESTIONNAIRE/ सब-वेंडर प्रश्नावली**

	<i>(similar or higher rating)</i> प्रस्तावित उत्पाद (एक समान या उच्च रेटिंग वाले) के लिए टाइप टेस्ट रिपोर्ट (टाइप टेस्ट विवरण, रिपोर्ट संख्या, एजेंसी, जांच की तारीख) का सारांश नोट: - रिपोर्ट प्रस्तुत करने की आवश्यकता नहीं है Note:- Reports need not to be submitted	Details attached at Annexure – F2.14 विवरण अनुलग्नक - F2.1 4में संलग्न है (if applicable) (यदि लागू हो)
19.	Statutory / mandatory certification for the proposed product प्रस्तावित उत्पाद के लिए वैधानिक / अनिवार्य प्रमाणीकरण	Applicable / Not applicable लागू / लागू नहीं Details attached at Annexure – F2.15 (if applicable) (यदि लागू हो)
20.	Copy of ISO 9001 certificate आईएसओ 9001 प्रमाण पत्र की प्रति (if available) (यदि उपलब्ध हो)	Attached at Annexure – F2.16 अनुलग्नक में संलग्न - F2.1 6 है
21.	Product technical catalogues for proposed item (if available) प्रस्तावित मद के लिए उत्पाद तकनीकी कैटलॉग (यदि उपलब्ध हो)	Details attached at Annexure – F2.17 विवरण अनुलग्नक - F2.1 7 में संलग्न है

Name:		Desig:		Sign:		Date:	
नाम:		पद:		हस्ता		तिथि:	
				क्षर:			

Company's Seal/Stamp:- कंपनी की मुहर / मोहर: -



CORPORATE QUALITY ASSURANCE/ कॉरपोरेट गुणवत्ता आश्वासन
MAIN CONTRACTOR'S PROPOSAL CUM EVALUATION REPORT
मुख्य संविदाकार प्रस्ताव सह मुल्यांकन रिपोर्ट

Ref No: संदर्भ सं.:		Date: तिथि:	
i. Main Contractor मुख्य संविदाकार			
ii. Project परियोजना			
iii. Package Name पैकेज का नाम		Package No पैकेज सं.	
iv. Proposed Item/Scope of Sub-contracting उप-संविदा(अनुबंध) का प्रस्तावित मद/ दायरा			
v. Item covered under निम्नलिखित के अंतर्गत शामिल मद	Schedule-1 /अनुसूची- 1		As per contract clause No- अनुबंध के अनुसार खंड सं.-- -
	Schedule-2 अनुसूची- -2		
vi. If item is Schedule-1 and proposed sub-vendor is indigenous, Main Contractor to explain how the contractual provisions will be fulfilled /यदि मद अनुसूची -1 है और प्रस्तावित उप-विक्रेता स्वदेशी है, तो मुख्य संविदाकार को स्पष्ट करना होगा कि संविदा/अनुबंध के प्रावधान कैसे पूरे किए जाएंगे			
vii. Name and Address of the proposed Sub-vendor's works /प्रस्तावित सब-वेंडर का नाम तथा पता			
viii. PO placement date/ Start of manufacturing (if self-manufactured) as per L2 network पीओ नियोजन की तिथि / एल- 2 नेटवर्क के अनुसार विनिर्माण (यदि स्व-निर्मित है) की शुरुआत			
ix. Item Description (Type/Size/Rating/Scope of Sub-Contracting) मद का विवरण (प्रकार / आकार / रेटिंग / उप-अनुबंध का दायरा)	Total quantity of proposed item envisaged in this package (Nos/ Running Meters/ Kgs/ Tons etc) इस पैकेज में परिकल्पित प्रस्तावित मद की कुल मात्रा (संख्या / क्रियाशील मीटर / किलोग्राम / टन आदि)	Quantity proposed to be procured from proposed sub-vendor (Nos/ Running Meters /Kgs /Tons etc) प्रस्तावित उप-विक्रेता (संख्या / क्रियाशील मीटर / किलोग्राम / टन आदि) से खरीदी जाने वाली मात्रा	Timeline for quantity requirements as per project schedule & whether the proposed Sub-vendor equipped with adequate capacity to supply proposed order quantity in time / परियोजना समय सूची के अनुसार मात्रा आवश्यकताओं के लिए समय-सीमा और क्या प्रस्तावित उप-विक्रेता समय पर प्रस्तावित मांग की मात्रा की आपूर्ति करने में पूरी तरह से सक्षम है
x. Supply experience of the proposed sub-vendor (including supplies to Main Contractor, if any) for similar item/scope of sub-contracting, for last 3 years (Note:- Only relevant experience details w.r.t. proposed item/scope of subcontracting to be brought out here) पिछले 3 वर्षों के लिए उप-अनुबंध के समान मद / दायरे के लिए प्रस्तावित सब-वेंडर (मुख्य संविदाकार हेतु			



CORPORATE QUALITY ASSURANCE/ कॉर्पोरेट गुणवत्ता आश्वासन
MAIN CONTRACTOR'S PROPOSAL CUM EVALUATION REPORT
मुख्य संविदाकार प्रस्ताव सह मुल्यांकन रिपोर्ट

आपूर्ति, यदि कोई हो, सहित) का आपूर्ति अनुभव (नोट: - उप-अनुबंध के प्रस्तावित मद / दायरे के संबंध में केवल प्रासंगिक अनुभव के विवरण का उल्लेख हो									
Project/Package परियोजना/पैकेज	Customer Name ग्राहक का नाम	Supplied Item (Type/Rating/Model /Capacity/Size etc) आपूर्ति मद (प्रकार/रेटिंग /मॉडल /क्षमता/आकार आदि)	PO ref no/date पीओ संदर्भ सं. /तिथि	Supplied Quantity आपूर्ति की मात्रा	Date of Supply आपूर्ति की तिथि				
We confirm that as per our assessment, the proposed sub-vendor has requisite capabilities & supply experience and is suitable for supplying the proposed item/scope of sub-contracting/हम अपने आकलन के अनुसार इस बात की पुष्टि करते हैं कि, प्रस्तावित उप-विक्रेता के पास अपेक्षित क्षमता और आपूर्ति करने का अनुभव है और उप-अनुबंध के दायरे /प्रस्तावित मद की आपूर्ति के लिए उपयुक्त है।									
Name: नाम:		Desig: पद:		Contact No: दूरभाष सं.:		Sign: हस्ताक्षर:		Date: तिथि:	

Company's Seal/Stamp:- कंपनी का मुहर:-

Self-certification

As per Government Public procurement order no. P-45021/2/2017-BE-II dt.15.06.2017 & P-45021/2/2017-PP(BE-II) dated 28.05.2018,29.5.2019 & 04.6.2020, it is hereby certifying that we

.....

(supplier name) are(Class-I/Class-II) local supplier and will meet the requirement of minimum local content of (50%/20%) as defined in public procurement order dated 04.6.2020 for material against Enquiry no.

.....

Details of location at which local value addition will be made is as follows: -

.....

.....

We also understand, false declarations will be in breach of the code of integrity under Rule 175(1)(i)(h) of the General Financial Rules for which a bidder or its successors can be debarred for up to two years as per Rule 151 (iii) of the general financial rules along with such other actions as may be permissible under law.

Seal & Signature of Supplier