

CHECK LIST

NOTE: - Suppliers are required to fill in the following details in their Letterhead and no column should be left blank

A	Name and Address of the Supplier		
B	GSTN No. the Supplier (Place of Execution of Contract / Purchase Order)		
C	Details of Contact person for this Tender	Name: Mr./ Ms. Designation: Telephone No: Mobile No: Email ID:	
D	EMD DETAILS	Not Applicable	
E	DESCRIPTION	APPLICABILITY (BY BHEL)	ENCLOSE BY BIDDER
i.	Whether Pre - Qualification Criteria is understood and provided proper supporting documents.	Applicable/ Not Applicable	YES / NO
ii.	Whether all pages of the Tender documents including annexures, appendices etc. are read and understood	Applicable/ Not Applicable	YES / NO
iii.	Audited Balance Sheet and profit & Loss Account for the last three years	Applicable/ Not Applicable	YES / NO
iv.	Copy of PAN Card & GST registration	Applicable/ Not Applicable	YES / NO
v.	Submission of MSE certificate as specified in Tender	Applicable/ Not Applicable	YES / NO
vi.	Offer forwarding letter / tender submission letter as per Annexure – 2	Applicable/ Not Applicable	YES / NO
vii.	Submission of Certificate of No Deviation as per Annexure – 3	Applicable/ Not Applicable	YES / NO
viii.	Declaration regarding Insolvency/ Liquidation/ Bankruptcy Proceedings as per Annexure – 4	Applicable/ Not Applicable	YES / NO
ix.	Declaration by Authorized Signatory as per Annexure – 5	Applicable/ Not Applicable	YES / NO
x.	Declaration by Authorized Signatory regarding Authenticity of submitted Documents Annexure – 6	Applicable/ Not Applicable	YES / NO
xi.	Submission of Non-Disclosure Certificate as per Annexure – 7	Applicable/ Not Applicable	YES / NO

xii.	Submission of Integrity Pact as specified in Tender as per Annexure – 8	Applicable/ Not Applicable	YES / NO
xiii.	Declaration confirming knowledge about Site Conditions as per Annexure – 9	Applicable/ Not Applicable	YES / NO
xiv.	Declaration reg. Related Firms & their areas of Activities as per Annexure – 10	Applicable/ Not Applicable	YES / NO
xv.	Declaration for relation in BHEL as per Annexure – 11	Applicable/ Not Applicable	YES / NO
xvi.	Declaration reg. minimum local content in line with revised public procurement as per Annexure – 12	Applicable/ Not Applicable	YES / NO
xvii.	Declaration regarding compliance to Restrictions under Rule 144 (xi) of GFR 2017 as per Annexure – 13	Applicable/ Not Applicable	YES / NO
xviii.	Bank Account Details for E-Payment as per Annexure – 14	Applicable/ Not Applicable	YES / NO
xix.	Power of Attorney for submission of tender as per Annexure – 15	Applicable/ Not Applicable	YES / NO
xx.	Proforma of Bank Guarantee for Earnest Money as per Annexure – 16	Applicable/ Not Applicable	YES / NO
xxi.	Proforma of treatment of cases regarding conflict of interest as per Annexure – 19	Applicable/ Not Applicable	YES / NO

NOTE: Strike off ‘YES’ or ‘NO’, as applicable. Tender not accompanied by the prescribed **above applicable documents** are liable to be summarily rejected.

DATE:

**Sign. of the
AUTHORISED SIGNATORY
(With Name, Designation and Company seal)**

Buyers Specific Additional Terms & Conditions
Item Name: Vapour Exhausters with IE3 Motor
Projects: Yamunanagar Project

1. Scope of Enquiry

E-bids on GeM portal are invited from bidders for the supply of Vapour Exhauster with IE3 Motor (As per TG60432 Rev 05) as below description for Yamunanagar Project, as per requirement mentioned below:

Sl. No.	Material Code & Item Description	Project	Total Qty (set)	Tentative Date for Supply Completion
1	Material Code W96415003127 Vapour Exhauster with IE3 Motor SPEC: TG 60432 REV: 05	1X800MW YAMUNA NAGAR HPGCL	2 Nos.	30.09.2027

2. Consignee Details:

OFFICE OF CHIEF ENGINEER/DCRTPP, HPGCL, 1X800 MW ULTRA SUPERCRITICAL EXPANSION UNIT, DEEN BANDHU CHHOTU RAM THERMAL POWER PLANT (DCRTPP), VPO- PANSARA, YAMUNA NAGAR, HARYANA-135001, INDIA

3. EARNEST MONEY DEPOSIT (EMD): NIL

Annexure A: Buyers Specific Additional Terms & Conditions in addition to GTC

Sl. NO.	Terms	Description	Your confirmation
1.	Confirmation to compliance of GeM GTC	General terms and conditions on GeM 4.0 (Version 1.29, dated 25.03.2026) or subsequent rules/policies issued by GeM shall be applicable. Please confirm.	
2.	Pre-Qualification Requirements (PQR)	The Pre-Qualification Requirements have been compiled and submit filled copy of Table and supporting PO copy, unpriced dispatch document, approved GA drawing, motor datasheet, characteristics curves etc. All the bidders should ensure submission of complete details and documents as called for in these requirements. The Offers submitted by the bidders would be scrutinized with respect to Pre-Qualification Requirements first. Techno-Commercial offer of only those bidders shall be evaluated who meet the Pre-Qualification Requirements.	
3.	Special Instruction of Technical requirement	<ol style="list-style-type: none"> 1. Please confirm that material specification as per Spec TG60432 rev 05 only is followed for concerned items of the enquiry without any deviation. 2. Painting of the material shall be as per respective BHEL Specification. Vendor submit <u>Paint DFT & Shade details in drawing for approval</u>. Approx. DFT shall be 200 microns and shade shall be RAL 9002 as per IS-5 or equivalent. 3. Test and Guarantee certificates are required to be submitted. 4. Operation and maintenance manual copy to be send with each packing box 5. Kindly confirm that quoted offer by you have been complied all technical requirements as given in tender documents and submit all documents to BHEL as per tender specifications and drawings without any deviations. 6. Foundation bolt of size M16 x 150, qty 4 nos to be supplied with each exhauster. 7. Suitable antivibration Pad to be supplied with each Vapour Exhauster. 	

4.	Quality Requirement	<ul style="list-style-type: none"> ➤ Bidders to submit endorse copy of SQP QA/BE/QP/306, Rev 04 dt 19.03.2025. ➤ Bidders to confirm that inspection shall be by done by BHEL Nominated inspection agency (M/s QUEST) & end customer as per finally customer approved QP. ➤ BHEL/Customer approved QP shall be followed in totality. BHEL can modify / changes in above QP during QP approval. ➤ Please note that BHEL will pay directly to BHEL's nominated TPI. 	
5.	Price basis, Evaluation Currency, Firm prices & Transit Insurance	<p>Prices should be quoted on Ex works freight Prepaid up to Yamunanagar Project basis i.e. including freight, packing & forwarding charges, GST etc.</p> <p>The evaluation currency for this tender shall be INR.</p> <p>Price will remain firm and fixed during entire execution of tender/supply.</p> <p>Transit insurance shall be arranged by BHEL and not to be included in the prices.</p>	
6.	Consignee Address Declaration	Consignee mentioned in GeM enquiry may be different. However, material to be dispatched to mentioned address.	
7.	Evaluation criteria	Evaluation will be done on the basis of total landed cost to BHEL , with cost involved for delivery up to Yamunanagar Project Site (considering material cost, taxes & duties, Freight etc.	
8.	Payment Terms	<p>Payment shall be made within 45/ 60/ 90 days (as applicable for MSE, Medium and Non-MSME bidders respectively) from the material entry date in BHEL, subject to submission of non-discrepant documents by the vendor, uploading of all documents on BHEL's SUVIDHA portal at the time of dispatch, and the acceptance of material by BHEL after receipt.</p> <p><u>Note: This is in supersession of 10 days' time as provided in Clause 12 of GeM GTC and also 45 days from CRAC as provided in the standard format of GeM Bid under Payment Timelines.</u></p>	
9.	DIGITALLY SIGNED INVOICE:	For supply orders placed under this GEM Tender Irrespective of the value of the invoice amount, the bidder / vendor should necessarily upload the dispatch documents & invoice details on BHEL SUVIDHA portal at https://suvidha.bhel.in/suvidha/ . All documents as per PO checklist, along with additional documents (if any), must be uploaded on the portal. It is mandatory that tax invoices with a net amount (including taxes) exceeding Rs five lakhs uploaded on the portal are digitally signed using a Class 3 Digital Signature Certificate (DSC) issued by a licensed Certifying Authority. Submission of invoice document in hard copy is allowed for invoices with a net amount (including taxes) equal to and up to Rs five lakhs, in case they were not digitally signed and uploaded on the portal. Vendor invoice cannot be processed in absence of the above.	
10.	Document submission & approval	Drawings/Data sheets, Quality Plan etc. as called for in the specifications shall be submitted for approval to BHEL for BHEL approval within 30 days of purchase order . Approved documents/QP are to be followed by the supplier without any price implication. Any delay in delivery on account of late submission of drawings/data sheets/QAP/documents shall be to vendors account. BHEL will arrange the approval of the drawings/data sheets/ documents within 30 days of their receipt provided those are complete in all respect. Delays in approval shall be dealt on merit basis.	
11.	Manufacturing-Clearance	In case of ordering, vendor has to take manufacturing clearance from BHEL before starting manufacturing of material. No manufacturing is to be started without getting clearance from BHEL. Kindly confirm.	
12.	Manufacturing cum Delivery Period	<p>Kindly quote your minimum delivery period in no. of weeks. (time taken including manufacturing + inspection by BHEL TPIA+ 07 days for MDCC issuance and up to Dispatch)</p> <p>From the date of Manufacturing Clearance.....</p>	
13.	MDCC clause	Material shall be dispatched only after issue of material dispatch clearance certificate (MDCC) by BHEL. All test certificates and relevant documents are to be sent to BHEL before dispatch of material for issue of MDCC, which will be issued after review of test certificates etc. MDCC will be issued within 07 days of receipt of these documents once found complete in all respects. In case of any delay on account of BHEL in issuing MDCC,	

		<p>delivery shall be extended by no. of days in excess of 7 days taken by BHEL in issuing MDCC and delays shall be dealt on merit basis.</p> <p>In case any material is dispatched without MDCC and any loss is incurred by Supplier/Vendor for any reason whatsoever, BHEL shall not be responsible in any manner to compensate the supplier in this regard.</p> <p>Material is to be dispatched within 07 days of receipt of MDCC from BHEL without waiting for PO amendment.</p>	
14.	Guarantee	<p>Kindly confirm that all equipment shall be guaranteed for trouble free & satisfactory operation for minimum period of 18 months from the date of delivery or 12 months from date of commissioning, whichever is earlier.</p> <p>Please note that offers with guarantee period lesser than above mentioned guarantee period may result in rejection of the offer.</p>	
15.	Liquidated Damages	<p>If the Seller/Service Provider fails to deliver any or all of the Goods/Services within the original/re-fixed delivery period(s) specified in the contract, the Buyer will be entitled to deduct/recover the Liquidated Damages for the delay, unless covered under Force Majeure conditions aforesaid, @ 0.5% of the contract value of delayed quantity (LOT-WISE) per week or part of the week of delayed period as pre-estimated damages not exceeding 10% of the contract value of delayed quantity without any controversy/dispute of any sort whatsoever.</p> <p>The date of dispatch mentioned on LR/GR would be treated as the date of delivery for penalty purposes.</p>	
16.	BID to RA	Applicable as per GeM NIT (H1 Elimination)	
17.	Offer Validity	As per GeM NIT (120 Days)	
18.	Settlement of Dispute, CONCILIATION & ARBITRATION:	<p>Settlement of Dispute If any dispute or difference of any kind whatsoever shall arise between BHEL and the Supplier/Vendor, arising out of the contract for the performance of the work whether during the progress of contract termination, abandonment or breach of the contract, it shall in the first place referred to Designated Officer / IEM for amicable resolution by the parties. Designated Officer / IEM who within 60 days after being requested shall give written notice of his decision to the contractor. Save as hereinafter provided, such decision in respect of every matter so referred shall forthwith be given effect to by the Supplier/Vendor who shall proceed with the work with all due diligence, whether he or BHEL desires to resolve the dispute as hereinafter provided or not. If after the Designated Engineer has given written notice of this decision to the party and no intention to pursue the dispute has been communicated to him by the affected party within 30 days from the receipt of such notice, the said decision shall become final and binding on the parties. In the event the Supplier/Vendor being dissatisfied with any such decision or if amicable settlement cannot be reached then all such disputed issues shall be resolved through conciliation in terms of the BHEL Conciliation Scheme 2018 as per 'CONCILIATION' Clause.</p> <p>CONCILIATION: Any dispute, difference or controversy of whatever nature howsoever arising under or out of or in relation to this Agreement (including its interpretation) between the Parties, and so notified in writing by either Party to the other Party (the "Dispute") shall, in the first instance, be attempted to be resolved amicably in accordance with the conciliation procedure as per BHEL Conciliation Scheme 2018. The proceedings of Conciliation shall broadly be governed by Part-III of the Arbitration and Conciliation Act 1996 or any statutory modification thereof and as provided in - "Procedure for conduct of conciliation proceedings" (as available in www.bhel.com). Note: Ministry of Finance has issued OM reference No. 1/2/24 dated 03.06.2024 regarding "Guidelines for Arbitration and Mediation in Contracts of Domestic Public Procurement. In the said OM it has been recommended that Government departments/ Entities/agencies are to encourage mediation under the Mediation Act. 2023. The said Act has not yet been notified by the Government. Therefore, the clause "Settlement of Disputes" shall be modified accordingly as and when the Mediation Act 2023 gets notified.</p> <p>ARBITRATION: Except as provided elsewhere in this Contract, in case Parties are unable to reach amicable settlement (whether by Conciliation to be conducted as provided herein above or otherwise) in respect of any dispute or difference; arising out of the formation, breach, termination, validity or execution of the Contract; or, the respective rights and liabilities of the Parties; or, in relation to interpretation of any provision of the Contract; or, in any manner touching upon the Contract (hereinafter referred to as the 'Dispute'), then, either Party may, refer the disputes to Arbitral Institution and such dispute to be adjudicated by Sole Arbitrator appointed in accordance with the Rules of said Arbitral Institution.</p> <p>A party willing to commence arbitration proceeding shall invoke Arbitration Clause by giving notice to the other party in terms of section 21 of the Arbitration & Conciliation Act, 1996 (hereinafter referred to as the 'Notice') before referring the matter to arbitral institution. The Notice shall be addressed to the Head of the Region, Power Sector/ Unit, BHEL, executing the Contract and shall contain the particulars of all claims to be referred to arbitration with sufficient detail and shall also indicate the monetary amount of such claim including interest, if</p>	

		<p>any.</p> <p>After expiry of 30 days from the date of receipt of aforesaid notice, the party invoking the Arbitration shall submit that dispute to the Arbitral Institutions (shall be identified by the contract issuing agency) and that dispute shall be adjudicated in accordance with their respective Arbitration Rules. The matter shall be adjudicated by a Sole Arbitrator who shall necessarily be a Retd Judge having considerable experience in commercial matters to be appointed/nominated by the respective institution. The cost/expenses pertaining to the said Arbitration shall also be governed in accordance with the Rules of the respective Arbitral Institution. The decision of the party invoking the Arbitration for reference of dispute to a specific Arbitral institution for adjudication of that dispute shall be final and binding on both the parties and shall not be subject to any change thereafter. The institution once selected at the time of invocation of dispute shall remain unchanged.</p> <p>The fee and expenses shall be borne by the parties as per the Arbitral Institutional rules.</p> <p>The Arbitration proceedings shall be in English language and the seat and venue of Arbitration shall be at the court(s) of Haridwar.</p> <p>Subject to the above, the provisions of Arbitration & Conciliation Act 1996 and any amendment thereof shall be applicable. All matters relating to this Contract and arising out of invocation of Arbitration clause are subject to the exclusive jurisdiction of the Court(s) situated at Haridwar, shall have exclusive jurisdiction.</p> <p>Notwithstanding any reference to the Designated Engineer or Conciliation or Arbitration herein, a. the parties shall continue to perform their respective obligations under the Contract unless they otherwise agree. Settlement of Dispute clause cannot be invoked by the Contractor, if the Contract has been mutually closed or 'No Demand Certificate' has been furnished by the Contractor or any Settlement Agreement has been signed between the Employer and the Contractor.</p> <p>It is agreed that Mechanism of resolution of disputes through arbitration shall be available only in the cases where the value of the dispute is less than Rs. 10 Crores.</p> <p>In case the disputed amount Claim, Counter claim including interest is Rs. 10 crores and above, the parties shall be within their rights to take recourse to remedies other than Arbitration, as may be available to them under the applicable laws after prior intimation to the other party. Subject to the aforesaid conditions, provisions of the Arbitration and Conciliation Act, 1996 and any statutory modifications or re-enactment thereof as amended from time to time, shall apply to the arbitration proceedings under this clause.</p> <p>In case, multiple arbitrations are invoked (whether sub-judice or arbitral award passed) by any party to under this contract, then the cumulative value of claims (including interest claimed or awarded) in all such arbitrations shall be taken in account while arriving at the total claim in dispute for the subject contract for the purpose of clause mentioned above. Disputes having cumulative value of less than 10 crores shall be resolved through arbitration and any additional dispute shall be adjudicated by the court of competent jurisdiction.</p>	
19.	BREACH OF CONTRACT, REMEDIES AND TERMINATION:	<p>The following shall amount to breach of contract:</p> <ul style="list-style-type: none"> I. Non-supply of material/ non-completion of work by the Supplier/Vendor within scheduled delivery/ completion period as per contract or as extended from time to time. II. The Supplier/Vendor fails to perform as per the activity schedule and there are sufficient reasons even before expiry of the delivery/ completion period to justify that supplies shall be inordinately delayed beyond contractual delivery/ completion period. III. The Supplier/Vendor delivers equipment/ material not of the contracted quality. IV. The Supplier/Vendor fails to replace the defective equipment/ material/ component as per guarantee clause. V. Withdrawal from or abandonment of the work by the Supplier/Vendor before completion as per contract. VI. Assignment, transfer, subletting of Contract by the Supplier/Vendor without BHEL's written permission resulting in termination of Contract or part thereof by BHEL. VII. Non-compliance to any contractual condition or any other default attributable to Supplier/Vendor. VIII. Any other reason(s) attributable to Vendor towards failure of performance of contract. In case of breach of contract, BHEL shall have the right to terminate the Purchase Order/ Contract either in whole or in part thereof without any compensation to the Supplier/Vendor. IX. Any of the declarations furnished by the contractor at the time of bidding and/ or entering into the contract for supply are found untruthful and such declarations were of a nature that could have resulted in non-award of contract to the contractor or could expose BHEL and/ or Owner to adverse consequences, financial or otherwise. X. Supplier/Vendor is convicted of any offence involving corrupt business practices, antinational activities or any such offence that compromises the business ethics of BHEL, in violation of the Integrity Pact entered into with BHEL has the potential to harm the overall business of BHEL/ Owner. <p>Note-Once BHEL considers that a breach of contract has occurred on the part of Supplier/Vendor, BHEL shall notify the Supplier/Vendor by way of notice in this regard. Contractor shall be given an opportunity to rectify the reasons causing the breach of contract within a period of 14 days.</p> <p>In case the contractor fails to remedy the breach, as mentioned in the notice, to the satisfaction of BHEL, BHEL shall have the right to take recourse to any of the remedial actions available to it under the relevant provisions of contract.</p> <p>Remedies in case of Breach of Contract.</p> <p>i) Wherein the period as stipulated in the notice issued under above clause has expired and Supplier/Vendor has failed to remedy the breach, BHEL will have the right to terminate the contract on the ground of "Breach of</p>	

		<p>Contract" without any further notice to contractor.</p> <p>ii) Upon termination of contract, BHEL shall be entitled to recover an amount equivalent to 10% of the Contract Value for the damages on account of breach of contract committed by the Supplier/Vendor. This amount shall be recovered by way of encashing the security instruments like performance bank guarantee etc available with BHEL against the said contract. In case the value of the security instruments available is less than 10% of the contract value, the balance amount shall be recovered from other financial remedies (i.e. available bills of the Supplier/Vendor, retention amount, from the money due to the Supplier/Vendor etc. with BHEL) or the other legal remedies shall be pursued.</p> <p>iii) wherever the value of security instruments like performance bank guarantee available with BHEL against the said contract is 10% of the contract value or more, such security instruments to the extent of 10% contract value will be encashed. In case no security instruments are available or the value of the security instruments available is less than 10% of the contract value, the 10% of the contract value or the balance amount, as the case may be, will be recovered in all or any of the following manners:</p> <p>iv) In case the amount recovered under sub clause (a) above is not sufficient to fulfil the amount recoverable then; a demand notice to deposit the balance amount within 30 days shall be issued to Supplier/Vendor.</p> <p>v) If Supplier/Vendor fails to deposit the balance amount within the period as prescribed in demand notice, following action shall be taken for recovery of the balance amount:</p> <p>a) from dues available in the form of Bills payable to defaulted Supplier/Vendor against the same contract.</p> <p>b) If it is not possible to recover the dues available from the same contract or dues are insufficient to meet the recoverable amount, balance amount shall be recovered from any money(s) payable to Supplier/Vendor under any contract with other Units of BHEL including recovery from security deposits or any other deposit available in the form of security instruments of any kind against Security deposit or EMD.</p> <p>vi) In-case recoveries are not possible with any of the above available options, Legal action shall be initiated for recovery against defaulted supplier/Vendor.</p> <p>vii) It is an agreed term of contract that this amount shall be a genuine pre-estimate of damages that BHEL would incur in completion of balance contractual obligation of the contract through any other agency and BHEL will not be required to furnish any other evidence to the Supplier/Vendor for the purpose of estimation of damages.</p> <p>viii) In addition to the above, imposition of liquidated damages, debarment, termination, de-scoping, short-closure, etc., shall be applied as per provisions of the contract.</p> <p>Note:</p> <p>1) The defaulting Supplier/Vendor shall not be eligible for participation in any of the future enquiries floated by BHEL to complete the balance work. The defaulting contractor shall mean and include:</p> <p>(a) In case defaulted Supplier/Vendor is the Sole Proprietorship Firm, any Sole Proprietorship Firm owned by same Sole Proprietor.</p> <p>(b) In case defaulted Supplier/Vendor is The Partnership Firm, any firm comprising of same partners/ some of the same partners; or sole proprietorship firm owned by any partner(s) as a sole proprietor.</p>	
20.	Suspension of Business Dealings with Suppliers / Contractors:	<p>The offers of the bidders who are under suspension as also the offers of the bidders, who engage the services of the banned firms / principal / agents, shall be rejected. The list of banned firms is available on BHEL web site www.bhel.com.</p> <p>If any bidder / supplier / contractor during pre-tendering / tendering / post tendering / award / execution / post-execution stage indulges in any act, including but not limited to, mal-practices, cheating, bribery, fraud or and other misconduct or formation of cartel so as to influence the bidding process or influence the price or tampers the tendering process or acts or omits in any manner which tantamount to an offence punishable under any provision of the Indian Penal Code, 1860(Bhartiya Nyaya Samhita 2023) or any other law in force in India, or does anything which is actionable under the Guidelines for Suspension of Business dealings, action may be taken against such bidder / supplier / contractor as per extant guidelines of the company available on www.bhel.com and / or under applicable legal provisions. Guidelines for suspension of business dealings is available in the webpage: http://www.bhel.com/vender_registration/vender.php.</p>	
21.	CONFLICT OF INTEREST AMONG BIDDERS/ AGENTS	<p>A bidder shall not have conflict of interest with other bidders. Such conflict of interest can lead to anti-competitive practices to the detriment of Procuring Entity's interests. The bidder found to have a conflict of interest shall be disqualified. A bidder may be considered to have a conflict of interest with one or more parties in this bidding process, if:</p> <p>a) they have controlling partner (s) in common; or</p> <p>b) they receive or have received any direct or indirect subsidy/ financial stake from any of them; or</p> <p>c) they have the same legal representative/agent for purposes of this bid; or</p> <p>d) they have relationship with each other, directly or through common third parties, that puts them in a position to have access to information about or influence on the bid of another Bidder, or</p> <p>e) Bidder participates in more than one bid in this bidding process. Participation by a Bidder in more than one Bid will result in the disqualification of all bids in which the parties are involved. However, this does not limit the inclusion of the components/ sub-assembly/ Assemblies from. one bidding manufacturer in more than one bid; or</p> <p>f) In cases of agents quoting in offshore procurements, on behalf of their principal manufacturers, one agent cannot represent two manufacturers or quote on their behalf in a particular tender enquiry. One manufacturer can also authorise only one agent/dealer. There can be only one bid from the following:</p> <ol style="list-style-type: none"> 1. The principal manufacturer directly or through one Indian agent on his behalf; and 2. Indian/foreign agent on behalf of only one principal, . <p>or</p> <p>g) A Bidder or any of its affiliates participated as a consultant in the preparation of the design or technical specifications of the contract that is the subject of the Bid, or</p>	

		h) In case of a holding company having more than one independently manufacturing units, or more than one unit having common business ownership/management, only one unit should quote. Similar restrictions would apply to closely related sister companies. Bidders must proactively declare such sister/ common business/ management units in same/ similar line of business. "													
22.	MICRO AND SMALL ENTERPRISES (MSE):	<p>Any Bidder falling under MSE category shall furnish the following details & submit documentary evidence/ Govt. Certificate etc. in support of the same along with their techno-commercial offer.</p> <table border="1"> <thead> <tr> <th>Type under MSE</th> <th>SC/ST owned</th> <th>Women owned</th> <th>Others (excluding SC/ ST & Women Owned)</th> </tr> </thead> <tbody> <tr> <td>Micro</td> <td></td> <td></td> <td></td> </tr> <tr> <td>Small</td> <td></td> <td></td> <td></td> </tr> </tbody> </table> <p>Note: If the bidder does not furnish the above, offer shall be processed construing that the bidder is not falling under MSE category.</p> <p>a) MSE suppliers can avail the intended benefits in respect of the procurements related to the Goods and Services only (Definition of Goods and Services as enumerated by Govt. of India vide Office Memorandum F. No. 21(8)/2011-MA dtd. 09/11/2016 office of AS & DC, MSME) only if they submit along with the offer, attested copies of either Udyam Registration. Date to be reckoned for determining the deemed validity will be the last date of Technical Bid submission. Non-submission of supporting document in GeM portal will lead to consideration of their bids at par with other bidders. No benefits shall be applicable for this enquiry if the above required documents are not uploaded at the time of bid submission. Documents submitted by the bidder shall be verified by BHEL for rendering the applicable benefits.</p>	Type under MSE	SC/ST owned	Women owned	Others (excluding SC/ ST & Women Owned)	Micro				Small				
Type under MSE	SC/ST owned	Women owned	Others (excluding SC/ ST & Women Owned)												
Micro															
Small															
23.	JURISDICTION:	This contract shall be governed by the Law for the time being in force in the Republic of India. Subject to clause(s) mentioned above of this contract, the Civil Court having original Civil Jurisdiction at Haridwar shall alone have exclusive jurisdiction in regard to all matters in respect of the Contract.													
24.	Force Majeure	<p>"Force Majeure" shall mean circumstance which is: a) beyond control of either of the parties to contract, b) either of the parties could not reasonably have provided against the event before entering into the contract, c) having arisen, either of the parties could not reasonably have avoided or overcome, and d) is not substantially attributable to either of the parties And Prevents the performance of the contract, Such circumstances include but shall not be limited to: i) War, hostilities , invasion, act of foreign enemies. ii) Rebellion, terrorism, revolution, insurrection, military or usurped power, or civil war. iii) Riot, commotion or disorder by persons other than the contractor's personnel and other employees of the contractor and sub-contractors. iv) Strike or lockout not solely involving the contractor's personnel and other employees of the contractor and sub-contractors. v) Encountering munitions of war, explosive materials, ionizing radiation or contamination by radio-activity, except as may be attributable to the contractor's use of such munitions, explosives, radiation or radio- activity. vi) Natural catastrophes such as earthquake, tsunami, volcanic activity, hurricane or typhoon, flood, fire, cyclones etc. vii) Epidemic, pandemic etc.</p> <p>The following events are explicitly excluded from Force Majeure and are solely the responsibilities of the non-performing party: a) any strike, work-to-rule action, go slow or similar labour difficulty (b) late delivery of equipment or material (unless caused by Force Majeure event) and (c) economic hardship.</p> <p>If either party is prevented, hindered or delayed from or in performing any of its obligations under the Contract by an event of Force Majeure, then it shall notify the other in writing of the occurrence of such event and the circumstances thereof within 15 (fifteen) days after the occurrence of such event.</p> <p>The party who has given such notice shall be excused from the performance or punctual performance of its obligations under the Contract for so long as the relevant event of Force Majeure continues and to the extent that such party's performance is prevented, hindered or delayed. The Time for Completion shall be extended by a period of time equal to period of delay caused due to such Force Majeure event.</p> <p>Delay or non-performance by either party hereto caused by the occurrence of any event of Force Majeure shall not</p> <p>i) Constitute a default or breach of the Contract. ii) Give rise to any claim for damages or additional cost expense occasioned thereby, if and to the extent that such delay or non-performance is caused by the occurrence of an event of Force Majeure.</p> <p>BHEL at its discretion may consider short closure of contract after 1 year of imposition of Force Majeure in line with extant guidelines. In any case, Supplier/Vendor cannot consider deemed short-closure after 1 year of imposition of Force Majeure</p>													
25.	Cartel Formation	The Bidder declares that they will not enter into any illegal or undisclosed agreement or understanding, whether formal or informal with other Bidder(s). This applies in particular to prices, specifications, certifications, subsidiary contracts, submission or non-submission of bids or any other actions to restrict competitiveness or to introduce cartelization in the bidding process. In case, the Bidder is found having indulged in above activities, suitable action shall be taken by BHEL as per extant policies/ guidelines.													
26.	Fraud Prevention Policy:	Bidder along with its associate /collaborators /sub-contractors /sub-vendors / consultants / service providers shall strictly adhere to BHEL Fraud Prevention Policy displayed on BHEL website http://www.bhel.com and shall immediately bring to the notice of BHEL Management about any fraud or suspected fraud as soon as it comes to their notice.													

27.	Order of Precedence:	In the event of any ambiguity or conflict between the Tender Documents, the order of precedence shall be in the order below: a. Amendments/Clarifications/Corrigenda/Errata etc. issued in respect of the tender documents by BHEL. b. Buyer Added Bid Specific ATC c. GeM Bid Technical Conditions of Contract (TCC) d. GeM GTC			
28.	Contact details	Please provide 2 Nos of contact details (email id and contact no.) for clarifications. 1..... 2.....			
29.		Bid should be free from correction, overwriting, using corrective fluid, etc. Any interlineation, cutting, erasure or overwriting shall be valid only if they are attested under full signature(s) of person(s) signing the bid else bid shall be liable for rejection. In the event of any Technical or Commercial queries, the same may please be addressed to the following BHEL concerned before Part I opening- <table border="1" data-bbox="418 625 1528 806"> <tr> <td data-bbox="418 625 915 806">Mr. Adesh Garg Designation: Engineer (PPX-BOI) 4th Floor, Main Administrative Building, HEEP, BHEL, Hardwar- 249403, Uttarakhand, India Email ID: adesh@bhel.in Tel: +91 1334 28 1707</td> <td data-bbox="915 625 1528 806">Mr. Sagar Gupta Designation: Manager (PPX-BOI) 4th Floor, Main Administrative Building, HEEP, BHEL, Hardwar- 249403, Uttarakhand, India Email ID: sagargupta@bhel.in Tel: +91 1334 28 1045</td> </tr> </table>		Mr. Adesh Garg Designation: Engineer (PPX-BOI) 4 th Floor, Main Administrative Building, HEEP, BHEL, Hardwar- 249403, Uttarakhand, India Email ID: adesh@bhel.in Tel: +91 1334 28 1707	Mr. Sagar Gupta Designation: Manager (PPX-BOI) 4 th Floor, Main Administrative Building, HEEP, BHEL, Hardwar- 249403, Uttarakhand, India Email ID: sagargupta@bhel.in Tel: +91 1334 28 1045
Mr. Adesh Garg Designation: Engineer (PPX-BOI) 4 th Floor, Main Administrative Building, HEEP, BHEL, Hardwar- 249403, Uttarakhand, India Email ID: adesh@bhel.in Tel: +91 1334 28 1707	Mr. Sagar Gupta Designation: Manager (PPX-BOI) 4 th Floor, Main Administrative Building, HEEP, BHEL, Hardwar- 249403, Uttarakhand, India Email ID: sagargupta@bhel.in Tel: +91 1334 28 1045				

Note: Please fill your acceptance/ comments in confirmation column. Blank column will be understood as accepted by bidder.

OFFER FORWARDING LETTER / TENDER SUBMISSION LETTER
(To be typed and submitted in the Letter Head of the Company/Firm of Bidder)

Offer Reference No:

Date:

To,

Manager (PPX-BOI)
BHEL, HEEP Ranipur Haridwar

Dear Sir,

Sub: Submission of Offer against GeM Bid No:.....

Having examined the tender documents against your GeM Bid No. GEM/2025/B/6367287 dated _____ and having understood the provisions of the said tender documents and having thoroughly studied the requirements of BHEL related to the work tendered for, in connection with _____ (name of work & project site), we hereby submit our offer for the proposed work in accordance with terms and conditions mentioned in the tender documents, at the prices quoted by us and as per the indicated delivery schedule.

Should our Offer be accepted by BHEL for Award, I/we further agree to furnish 'Performance Security' for the work as provided for in the Tender Conditions within the stipulated time as may be indicated by BHEL.

I/We further agree to execute all the works referred to in the said Tender documents upon the terms and conditions contained or referred to therein and as detailed in the appendices annexed thereto.

I/We have deposited herewith the requisite Earnest Money Deposit (EMD) as per details furnished in the Check List.

Authorized Representative of Bidder

Signature:

Name:

Address:

Place:

Date:

CERTIFICATE OF NO DEVIATION

(To be Typed & submitted in the Letter Head of the Company/Firm of Bidder)

To,

Manager (PPX-BOI)
BHEL, HEEP Ranipur Haridwar

Dear Sir,

Subject: No Deviation Certificate

Ref: 1) GeM Bid No: GeM Bid No:.....
2) All other pertinent issues till date

We hereby confirm that we have not changed/ modified/materially altered any of the tender documents as downloaded from the website/ issued by BHEL and in case of such observance at any stage, it shall be treated as null and void.

We also hereby confirm that we have neither set any Terms and Conditions and nor have we taken any deviation from the Tender conditions together with other references applicable for the above referred GeM Bid.

We further confirm our unqualified acceptance to all Terms and Conditions, unqualified compliance to Tender Conditions.

We confirm to have submitted offer in accordance with tender instructions and as per aforesaid references.

Thanking you,

Yours faithfully,

(Signature, date & seal of authorized
representative of the bidder)

Date:
Place:

UNDERTAKING

(To be typed and submitted in the Letter Head of the Company/Firm of Bidder)

To,

Manager (PPX-BOI)
BHEL, HEEP Ranipur Haridwar

Dear Sir/Madam,

Sub: DECLARATION REGARDING INSOLVENCY/ LIQUIDATION/ BANKRUPTCY PROCEEDINGS

Ref: GeM Bid Specification No:

I/We,

declare that, I/We am/are not admitted under insolvency resolution process or liquidation under Insolvency and Bankruptcy Code, 2016, as amended from time to time or under any other law as on date, by NCLT or any adjudicating authority/authorities.

**Sign. of the AUTHORISED SIGNATORY
(With Name, Designation and Company seal)**

Place:

Date:

DECLARATION BY AUTHORISED SIGNATORY OF BIDDER
(To be typed and submitted in the Letter Head of the Company/Firm of Bidder)

To,

Manager (PPX-BOI)

BHEL, HEEP Ranipur Haridwar

Dear Sir,

Sub : **Declaration by Authorised Signatory regarding Authenticity of submitted documents.**

Ref : 1) GeM Bid No. & Date:

2) All other pertinent issues till date

I/We, hereby certify that all the documents submitted by us in support of possession of “Qualifying Requirements” are true copies of the original and are fully compliant required for qualifying / applying in the bid and shall produce the original of same as and when required by Bharat Heavy Electricals Limited.

I / We hereby further confirm that no tampering is done with documents submitted in support of our qualification as bidder. I / We understand that at any stage (during bidding process or while executing the awarded contract) if it is found that fake / false / forged bid qualifying / supporting documents / certificates were submitted, it would lead to summarily rejection of our bid / termination of contract. BHEL shall be at liberty to initiate other appropriate actions as per the terms of the Bid / Contract and other extant policies of Bharat Heavy Electricals Limited.

Yours faithfully,

(Signature, Date & Seal of Authorized
Signatory of the Bidder)

Date:

DECLARATION

Date: _____

To,

Manager (PPX-BOI)
BHEL, HEEP Ranipur Haridwar

Dear Sir/ Madam,

Sub: Details of related firms and their area of activities

Please find below details of firms owned by our family members that are doing business/ registered for same item with BHEL, (NA, if not applicable)

1	Material Category/ Work Description	
	Name of Firm	
	Address of Firm	
	Nature of Business	
	Name of Family Member	
	Relationship	
2	Material Category/ Work Description	
	Name of Firm	
	Address of Firm	
	Nature of Business	
	Name of Family Member	
	Relationship	
...		

Note: I certify that the above information is true and I agree for penal action from BHEL in case any of the above information furnished is found to be false.

Regards,

(_____)

From: M/s _____

Supplier Code:

DECLARATION FOR RELATION IN BHEL

(To be typed and submitted in the Letter Head of the Company/Firm of Bidder failing which the offer of Bidder is liable to be summarily rejected)

To,

Manager (PPX-BOI)
BHEL, HEEP Ranipur Haridwar

Dear Sir,

Sub: Declaration for relation in BHEL

Ref: 1) GeM Bid Specification No:

I/We hereby submit the following information pertaining to relation/relatives of Proprietor/Partner(s)/ Director(s) employed in BHEL

Tick (✓) any one as applicable:

1. The Proprietor, Partner(s), Director(s) of our Company/Firm DO NOT have any relation or relatives employed in BHEL

OR

2. The Proprietor, Partner(s), or Director(s) of our Company/Firm HAVE relation/relatives employed in BHEL and their particulars are as below:

- i.
- ii.

**(Signature, Date & Seal of Authorized
Signatory of the Bidder)**

Note:

- 1. Attach separate sheet, if necessary.
- 2. If BHEL Management comes to know at a later date that the information furnished by the Bidder is false, BHEL reserves the right to take suitable against the Bidder/Contractor.

Declaration for treatment of cases regarding conflict of interest

(To be typed and submitted in the Letter Head of the Company/Firm of Bidder)

To,

(Write Name & Address of Officer of BHEL inviting the Tender)

Dear Sir,

Sub: Declaration for treatment of cases regarding conflict of interest

Ref: Tender Reference No:

The bidder notes that a conflict of interest would said to have occurred in the tender process and execution of the resultant contract, in case of any of the following situations:

- i. If its personnel have a close personal, financial, or business relationship with any personnel of BHEL who are directly or indirectly related to the procurement or execution process of the contract, which can affect the decision of BHEL directly or indirectly;
- ii. The bidder (or his allied firm) provided services for the need assessment/ procurement planning of the Tender process in which it is participating;
- iii. Procurement of goods directly from the manufacturers/suppliers shall be preferred. However, if the OEM/Principal insists on engaging the services of an agent, such agent shall not be allowed to represent more than one manufacturer/ supplier in the same tender. Moreover, either the agent could bid on behalf of the manufacturer/ supplier or the manufacturer/ supplier could bid directly but not both. In case bids are received from both the manufacturer/ supplier and the agent, bid received from the agent shall be ignored. However, this shall not debar more than one Authorized distributor (with/ or without the OEM) from quoting equipment manufactured by an Original Equipment Manufacturer (OEM) in procurements under a Proprietary Article Certificate.
- iv. A bidder participates in more than one bid in this tender process. Participation in any capacity by a Bidder (including the participation of a Bidder as a partner/ JV member or sub-contractor in another bid or vice-versa) in more than one bid shall result in the disqualification of all bids in which he is a party. However, this does not limit the participation of an entity as a sub-contractor in more than one bid if he is not bidding independently in his own name or as a member of a JV.

The Bidder declares that they have read and understood the above aspects, and the bidder confirms that such conflict of interest does not exist and undertakes that they will not enter into any illegal or undisclosed agreement or understanding, whether formal or informal with other Bidder(s), in this regard. This applies in particular to prices, specifications, certifications, subsidiary contracts, submission or non-submission of bids or any other actions to restrict competitiveness or to introduce cartelization in the bidding process.

In case, the Bidder is found having indulged in above activities, the same will be considered as a violation of the tender conditions, and suitable action shall be taken by BHEL as per extant policies/ guidelines.

(Signature of the authorized signatory of the bidder)

Mandatory Pre-Qualification requirements for Vapour Exhauster**Description**

The Vapour Exhauster is required to handle mixture of turbine oil vapours, air & H₂ and for creating partial vacuum in generator bearing chamber & oil tanks of Tubogenerators. Vapour exhauster shall comprise of Centrifugal fan, Squirrel cage induction motor, base frame for mounting and motor terminal box.

Mandatory requirement for Pre-Qualification**1.0 Experience Requirement -**

The Vendor should be a regular manufacturer of such Vapour exhauster & should source motor set from regular manufacturer. Vendor should have supplied at least Three (3) nos. of vapour exhauster with motor in last Ten (10) years (from the date of issuance of enquiry) with following technical details -

Si No.	Parameter	Value
(i)	Exhauster & Motor Type	Centrifugal fan with squirrel cage 3 phase induction motor
(ii)	Flow medium	Mixture of Oil, Gases and Air.
(iii)	Material	Carbon Steel or Stainless steel
(iv)	Discharge Pressure	96 mmWC & above
(v)	Discharge Capacity	350 M ³ /Hr & above
(vi)	Motor Rating	0.75 KW & above
(vii)	Rated Speed	2820 RPM (approx)
(viii)	Rated Voltage	415V AC

In support of above, vendor to furnish information, as per the following format for previous supplied Vapour exhauster meeting the above technical requirement for the past Ten (10) years from the date of issuance of enquiry.

Si. No.	Purchase order reference no.	Purchase order issue date	QTY.	Motor KW rating	Discharge Pressure (mmWC)	Discharge Capacity (M ³ /Hr)

Vendor to submit the following documents as an evidence of acceptance of supplied Vapour exhauster, for the above mentioned successfully executed order -

- Vendor to furnish copy of Un-Priced Purchase Orders executed for supply of at least Three (3) nos. of vapour exhauster with motor in last Ten (10) years (from the date of issuance of enquiry).
- Vendor to furnish the test certificate for Exhauster fan & motor set as per relevant standard for any one of the PO submitted. The submitted test certificates should have co-relation with PO.
- Vendor to furnish supporting document for the evidence of final acceptance from End customer/Third Party of supplied vapour exhauster with motor for any one of the submitted PO's. Acceptance certificate should contain information like item details, Quantity accepted and should also have correlation with PO reference no.

2.0 Vendor shall submit the proof of manufacturer i.e. Factory license, NSIC certificate

Note - BHEL reserves the right to verify information submitted by vendor. In case the information is found to be false / incorrect, the offer shall be rejected.

31.07.23
Kunal Mishra
(Manager-EME)

31.7.23
K.C. Panda
(SDGM-EME)

MANUFACTURER'S NAME AND ADDRESS		STANDARD QUALITY PLAN					TO BE FILLED BY BHEL		TO BE FILLED BY BHEL				
BHEL	VENDOR'S NAME	ITEM	VAPOUR EXHAUSTER	QP NO.	QA/BE/QP/306								
				DATED & REV	19.03.2025 04								
		DRG. NO.	AS PER PO										
		SPEC.	TG 60432										
REV	AS PER PO		Page 1 of 2										
SL. NO.	COMPONENT & OPERATIONS	CHARACTERISTICS	CLASS	TYPE OF CHECK	QUANTUM OF CHECK	REFERENCE DOCUMENT	ACCEPTANCE NORMS	FORMAT OF RECORDS	AGENCY			REMARKS	
1	2	3	4	5	6	7	8	9	D	10		11	

1.0	RAW MATERIAL												
1.1	CASING, IMPELLER, BLADES & BASE FRAME/ PLATE, SLEEVE, O-RING	CHEMICAL, MECHANICAL PROPERTIES & SIZE	MAJOR	TEST & MEASUREMENT	100%	ORDERING SPEC. / BHEL APPD. DRG. / DATA SHEET	ORDERING SPEC. / BHEL APPD. DRG. / DATA SHEET	MTC	✓	P	V	V	
1.2	NUTS & BOLTS	TRADE MARK & PRPERTY CLASS	MAJOR	VISUAL	100%	AS PER VENDOR'S PROCEDURE	AS PER VENDOR'S PROCEDURE	IR	✓	P	V	-	
1.3	AC INDUCTION MOTOR (Please specify make, degree of protection and rating)	ROUTINE & TYPE TESTS CERTIFICATE INCLUDING DEGREE OF PROTECTION AND EXPLOSION PROOFNESS	MAJOR	REVIEW	100%	ORDERING SPEC. / BHEL APPD. DRG. / DATA SHEET	ORDERING SPEC. / BHEL APPD. DRG. / DATA SHEET	TC	✓	P	V	V	Also Include Enclosure Certificate as per Spec
2.0	INPROCESS INSPECTION												
2.1	ALL WELDS	QUALITY OF WELDS	MAJOR	DPT	100%	ORDERING SPEC. / BHEL APPD. DRG. / DATA SHEET	ORDERING SPEC. / BHEL APPD. DRG. / DATA SHEET	IR	✓	P	V	-	NOTE:1
2.2	IMPELLER	DIMENSIONS	MAJOR	MEASUREMENT	100%	ORDERING DWG	ORDERING DWG	IR	-	P	-	-	
		DIMENSIONS AFTER MACHINING	MAJOR	MEASUREMENT	100%	ORDERING DWG	ORDERING DWG	IR	-	P	-	-	
		DYNAMIC BALANCING	MAJOR	MEASUREMENT	100%	ORDERING SPEC. / BHEL APPD. DRG. / DATA SHEET	ORDERING SPEC. / BHEL APPD. DRG. / DATA SHEET	TC	✓	P	V	V	
2.3	ASSEMBLY OF FAN	INTERNAL CLEARANCE BETWEEN IMPELLER & CASING	MAJOR	MEASUREMENT	100%	ORDERING SPEC. / BHEL APPD. DRG. / DATA SHEET	ORDERING SPEC. / BHEL APPD. DRG. / DATA SHEET	IR	✓	P	V	-	
3.0	FINAL INSPECTION ON THE COMPLETE ASSEMBLY												
3.1		OVERALL DIMENSIONS	MAJOR	MEASUREMENT	100%	ORDERING SPEC. / BHEL APPD. DRG. & DATA SHEET	ORDERING SPEC. / BHEL APPD. DRG. & DATA SHEET	TC	✓	P	W	V	

		LEGEND: RECORDS IDENTIFIED WITH '✓' SHALL BE ESSENTIALLY INCLUDED BY CONTRACTOR IN QA DOCUMENTATION. M: MANUFACTURER / SUBCONTRACTOR B: BHEL / NOM. INSPECTION AGENCY N: CUSTOMER INDICATE 'P' PERFORM 'W' WITNESS AND 'V' VERIFICATION	FOR CUSTOMER USE
MANUFACTURER/ SUBCONTRACTOR		ALL 'W' INDICATED IN COLUMN 'N' SHALL BE 'CHP' OF CUSTOMER	APPROVED BY

MANUFACTURER'S NAME AND ADDRESS		STANDARD QUALITY PLAN					TO BE FILLED BY BHEL		TO BE FILLED BY BHEL									
BHEL	VENDOR'S NAME	ITEM	VAPOUR EXHAUSTER	QP NO.	QA/BE/QP/306		ACCEPTANCE NORMS	FORMAT OF RECORDS	AGENCY			REMARKS						
				DATED & REV	19.03.2025 04				M	B	N							
		DRG. NO.	AS PER PO		SL. NO.	COMPONENT & OPERATIONS			CHARACTERISTICS	CLASS	TYPE OF CHECK		QUANTUM OF CHECK	REFERENCE DOCUMENT	ACCEPTANCE NORMS	FORMAT OF RECORDS	AGENCY	REMARKS
		SPEC.	TG 60432															
REV	AS PER PO																	
Page 2 of 2																		
1	2	3	4	5	6	7	8	9	D	10	11							

3.2		PERFORMANCE (INCLUDING AIR DELIVERY, PRESSURE & POWER CONSUMPTION)	MAJOR	PERFORMANCE	100%	IS:4894/ ORDERING SPEC. / BHEL APPD. DRG. & DATA SHEET	IS:4894/ ORDERING SPEC. / BHEL APPD. DRG. & DATA SHEET	TC	✓	P	W	V	
3.4		FAN SPEED, SMOOTH RUNNING, DIRECTION OF ROTATION	MAJOR	VISUAL	100%	ORDERING SPEC. / BHEL APPD. DRG. & DATA SHEET	ORDERING SPEC. / BHEL APPD. DRG. & DATA SHEET	IR	✓	P	W	V	
3.5		NOISE LEVEL	MAJOR	MEASUREMENT	100%	ORDERING SPEC. / BHEL APPD. DRG. & DATA SHEET	ORDERING SPEC. / BHEL APPD. DRG. & DATA SHEET	IR	✓	P	W	V	
3.6		VIBRATION	MAJOR	MEASUREMENT	100%	ORDERING SPEC. / BHEL APPD. DRG. & DATA SHEET	ORDERING SPEC. / BHEL APPD. DRG. & DATA SHEET	IR	✓	P	W	V	
3.7		APPEARANCE INCLUDING PAINT THICKNESS (DFT)	MAJOR	VISUAL & MEASUREMENT	100%	ORDERING SPEC. / BHEL APPD. DRG. & DATA SHEET	ORDERING SPEC. / BHEL APPD. DRG. & DATA SHEET	IR/TC		P	V	V	As per Customer/ BHEL Req. (if any)
3.8		COMPLIANCE OF TECHNICAL REQUIREMENTS	MAJOR	--	100%	ORDERING SPEC. / BHEL APPD. DRG. & DATA SHEET	ORDERING SPEC. / BHEL APPD. DRG. & DATA SHEET	COC		P	V	-	
3.9		COMPLETION OF DOCUMENTS	MAJOR	PHYSICAL	100%	ORDERING SPEC. / BHEL APPD. DRG. & DATA SHEET	ORDERING SPEC. / BHEL APPD. DRG. & DATA SHEET	DOCUMENTS	✓	P	V	-	
4.0	PACKING												
4.1		SOUNDNESS OF PACKING AGAINST TRANSIT DAMAGE	MAJOR	PHYSICAL	100%	ORDERING SPEC. / BHEL APPD. DRG. & DATA SHEET	ORDERING SPEC. / BHEL APPD. DRG. & DATA SHEET	INTERNAL RECORDS		P	-	-	

NOTE:1 - Welding to be done by qualified welder as per ASME IX WPS and PQR to be checked by inspecting agency.

Note 2: All pages of the inspection documents shall be numbered in chronology with the QAP clauses, duly mentioning the corresponding QAP clause no. at the top of each page.

Note 3: One 'index' page containing the document descriptions, their page no's & QAP cl no. shall be attached upfront the inspection documents.

Note 4: For any spares item, apart from 'visual inspection' the 'interchangeability fitment certificate' or 'material TC' are to be submitted, with specific mentioning of the 'pert no/ item no of the approved GA/ x-sec drg.'.

		LEGEND:	FOR CUSTOMER USE	
MANUFACTURER/ SUBCONTRACTOR		RECORDS IDENTIFIED WITH '✓' SHALL BE ESSENTIALLY INCLUDED BY CONTRACTOR IN QA DOCUMENTATION.		
		M: MANUFACTURER / SUBCONTRACTOR B: BHEL / NOM. INSPECTION AGENCY N: CUSTOMER INDICATE 'P' PERFORM 'W' WITNESS AND 'V' VERIFICATION		
		ALL 'W' INDICATED IN COLUMN 'N' SHALL BE 'CHP' OF CUSTOMER		
			APPROVED BY	

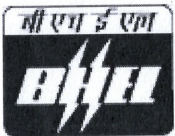
दिनांक एवं हस्ताक्षर SIGN & DATE		<p style="text-align: center;">उत्पाद क्रय विनिर्देश</p> <p style="text-align: center;">PRODUCT PURCHASE SPECIFICATION</p>		<p style="text-align: center;">TG60432</p> <p style="text-align: center;">मुख्य पृष्ठ PREFACE SHEET</p>	
सामग्री सूची संख्या को अधिकारित करता है	SUPERSEDES INVENTORY NO.	<p><u>VAPOUR EXHAUSTER</u></p> <p>केवल आंतरिक प्रयोग हेतु प्रदायक को देने से पूर्व इस मुख्य पृष्ठ को निकाल दें। FOR INTERNAL USE ONLY REMOVE THIS PREFACE BEFORE ISSUE TO SUPPLIERS.</p>			
<p style="text-align: center;">COPYRIGHT AND CONFIDENTIAL</p> <p style="font-size: small;">The information on this documents is the property of Bharat Heavy Electrical Limited It must not be used directly or indirectly in any way detrimental to the interest of the company</p>	<p>समतुल्य मानक / सूची आदि COMPARABLE STANDARDS / CATALOGUES ETC. } NIL</p>				
		<p style="text-align: center;">स्वत्वधिकार एवं गोपनीय</p> <p style="font-size: x-small;">इस प्रलेख में दी गई सूचना भारत हेवी एलेक्ट्रिकल्स की सम्पत्ति है इसका प्रत्यक्ष एवं अप्रत्यक्ष रूप से किसी भी तरह प्रयोग जो कि कंपनी के हित में होना आवश्यक हो न किया जाये</p>	<p>सुझाए / सम्भावित प्रदायक एवं श्रेणी SUGGESTED / PROBABLE SUPPLIERS AND GRADES. } PMD-BI025</p>		
<p>दिनांक एवं हस्ताक्षर SIGN & DATE</p> <p style="text-align: center;"><i>Sudhanu</i></p>	<p>कोई अन्य जानकारी ANY OTHER INFORMATIONS } NIL</p>				
<p>सामग्री सूची संख्या INVENTORY NO.</p> <p style="text-align: center;">P-5894</p>	<p style="text-align: center;">SUPERSEDES</p> <p>REV.NO. 05</p> <p>Date 14.05.26</p>	<p>स्वीकृति APPROVED : Asha Gupta (AGM / EME)</p> <p>निर्माण PREPARED : EME</p>	<p>Gr. No. 8.10</p> <p>जारी ISSUED : TSX</p> <p>दिनांक DATE : 09.09.92</p>		

SUPERSEDES INVENTORY NO.
 सामग्री सूची संख्या को अधिकृत करता है

COPYRIGHT AND CONFIDENTIAL
 The information on this document is the property of Bharat Heavy Electrical Limited. It must not be used directly or indirectly in any way detrimental to the interest of the company

स्वत्वधिकार एवं गोपनीय
 इस प्रलेख में दी गई सूचना भारत हेवी एलेक्ट्रिकल्स की सम्पत्ति है इसका प्रचलन एवं अप्रचलन रूप से किसी भी तरह प्रयोग जो कि कंपनी के हित में हानिकारक हो न किया जाय

दिनांक एवं हस्ताक्षर
SIGN & DATE
 सामग्री सूची संख्या
INVENTORY NO.
15/5/26
P-5894

Based on BHEL's own experience

VAPOUR EXHAUSTER

1.0 SCOPE AND APPLICATION:

This specification intended to cover design, manufacture, assembly testing & delivery of vapour exhauster, complete with motor, coupling, base plate and other accessories. The vapour exhauster is required to handle mixture of turbine oil vapours, air & H₂ and for creating partial vacuum in generator bearing chamber & oil tanks of Turbo-generators.

2.0 DESIGNATION:

The Vapour exhauster shall be designated as below: -

2.1 ON DRAWINGS INDENTS:

- | | | |
|-----------------------------------|---|------------------|
| (1) Material specification column | : | TG-60432 |
| (2) Description Column | : | Vapour Exhauster |
| (3) Material Code Column | : | W96415000578 |

2.2 ON ENQUIRES AND PURCHASE ORDER:-









In addition to incorporating the above details, a copy of the standard shall be enclosed along with enquiry.







3.0 TECHNICAL REQUIREMENTS:

3.1 TECHINCAL DATA OF VAPOUR EXHAUSTER:

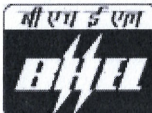



- | | | |
|--|---|-------------------------|
| (1) Continuous discharge capacity at operating point | : | 396 m ³ / hr |
| (2) Normal discharge pressure at operating point | : | 96 mmWC |
| (3) Operating temp. of the medium | : | 70°C |
| (4) Ambient temp. | : | 50°C |
| (5) Speed | : | 2820rpm |



				नाम NAME	दिनांक एवं हस्ताक्षर SIGNATURE & DATE
TSX	<i>Nikhil Kumar</i>	<i>Nikhil Kumar</i>	<i>15/5/26</i>	अनुवादक TRANSLATED BY	
PSC Member	<i>SS Meena</i>	<i>SS Meena</i>	<i>14.5.26</i>	निर्माणकर्ता WORKED BY	<i>ABHISHEK KUMAR</i> <i>14/5/26</i>
QAX	<i>RAJENDER</i>	<i>RAJENDER</i>	<i>14.5.26</i>	जांचकर्ता CHECKED BY	<i>SHIVANGI GUPTA</i> <i>14.05.26</i>
सहमत विभाग AGREED DEPTT.	नाम NAME	दिनांक एवं हस्ताक्षर DATE & SIGNATURE		पर्यवेक्षणकर्ता SUPERVISED BY	<i>MANJU AZAD</i> <i>14.5.26</i>
SUPERSEDES				स्वीकृति APPROVED : ASHA GUPTA (AGM / EME)	Gr. NO. 8.10
REV.NO.	05			निर्माणकर्ता PREPARED : EME	जारीकर्ता ISSUED : TSX
Date.	14.05.26				दिनांक DATE : 09.09.92
CHANGE ADVICE NO.	TGE-26-49				

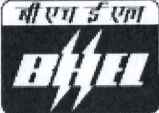

४ हस्ताक्षर SIGN & DATE		<h1>उत्पाद क्रय विनिर्देश</h1> <h2>PRODUCT PURCHASE SPECIFICATION</h2>	TG60432 पृष्ठ 8 का 2 Page 2 of 8															
SUPERSEDES INVENTORY	सामग्री सूची संख्या को अधिकतम करता है	<p>3.2 DESIGN AND CONSTRUCTION OF VAPOUR EXHAUSTER</p> <p>3.2.1 The material of the exhauster shall be such as to resist corrosion and shall give long trouble-free service.</p> <p>3.2.2 The design shall be such as to keep the friction and wear minimum caused by end thrust. Wear in mechanical seals bearings shall be minimum. The rotor of the exhauster shall be dynamically balanced as per ISO 1940, so that vibration of the exhauster is not greater than 25-micron peak to peak as per IEC 60034-14. The noise level shall not be greater than 85dB when measured at a distance of 1 meter from the base of the equipment, measurement should be done as per IEC 60034-9.</p> <p>3.2.3 Seals must comply with the following: - (a) Easy access for maintenance work. (b) No contamination of the medium from materials abraded from the seals. (c) No seepage of lubricants into the flow medium. (d) No leakage of gases outside in the atmosphere (e) No seepage of oil toward, motor and outside along with the shaft. (f) Shaft shall be sealed with grease lubricated axial seal as shown in the figure.</p> <p>3.2.4 Exhauster bearing shall be designed so as to ensure 50000 hours of continuous service.</p> <p>3.2.5 The exhauster shall be provided with a drain plug.</p> <p>3.2.6 Fan impeller is to be directly mounted onto rotor shaft as shown in the figure at page 8.</p> <p>3.2.7 The critical speed of the exhauster shall not lie within $\pm 30\%$ of the operating speed (2820 rpm) of the exhauster.</p> <p>3.2.8 Minimum clearance between impeller & casing shall be 2mm to ensure that there is no rubbing.</p> <p>3.2.9 The construction, mounting and base frame dimensions shall be generally as per figure at page 8.</p> <p>3.2.10 Materials of Construction:-</p> <table border="0"> <tr> <td>(1) Casing</td> <td>:</td> <td>Carbon Steel as per IS:2062 E250 BR</td> </tr> <tr> <td>(2) Impeller</td> <td>:</td> <td>Carbon Steel as per IS:2062 E250 BR</td> </tr> <tr> <td>(3) Base Frame</td> <td>:</td> <td>Carbon Steel as per IS:2062 E250 BR</td> </tr> <tr> <td>(4) Sleeve</td> <td>:</td> <td>Brass</td> </tr> <tr> <td>(5) 'O' ring</td> <td>:</td> <td>Neoprene</td> </tr> </table>	(1) Casing	:	Carbon Steel as per IS:2062 E250 BR	(2) Impeller	:	Carbon Steel as per IS:2062 E250 BR	(3) Base Frame	:	Carbon Steel as per IS:2062 E250 BR	(4) Sleeve	:	Brass	(5) 'O' ring	:	Neoprene	
(1) Casing	:	Carbon Steel as per IS:2062 E250 BR																
(2) Impeller	:	Carbon Steel as per IS:2062 E250 BR																
(3) Base Frame	:	Carbon Steel as per IS:2062 E250 BR																
(4) Sleeve	:	Brass																
(5) 'O' ring	:	Neoprene																
COPYRIGHT AND CONFIDENTIAL The information on this documents is the property of Bharat Heavy Electrical Limited. It must not be used directly or indirectly in any way detrimental to the interest of the company																		
स्वत्वधिकार एवं गोपनीय इस प्रलेख में दी गई सूचना भारत हेतु एल्यूमीनियम की सम्पत्ति है इस्का प्रचलन एवं उपयोग के बिना किसी भी तरह प्रयोग जो कि कंपनी के हित में हानिकारक हो न																		
दिनांक एवं हस्ताक्षर SIGN & DATE 		<p>3.3 MOTOR SPECIFICATIONS</p> <p>3.3.1 TYPE : TEFC squirrel cage induction motor to IEC 60034-1</p> <p>3.3.2 KW rating : 0.75kW</p> <p>3.3.3 Rated voltage : 415 Volts, 3 phase, 50Hz</p> <p>3.3.4 Type of duty : S1 (Continuous) as per IEC 60034-1</p> <p>3.3.5 Efficiency class : Refer Variant Table as below</p>																
सामग्री सूची संख्या INVENTORY NO 	REV. NO. 05		<table border="1"> <tr> <td>निर्माणकर्ता WORKED BY</td> <td>Abhishek Kumar</td> <td></td> <td>14/5/26</td> </tr> <tr> <td>जांचकर्ता CHECKED BY</td> <td>Shivangi Gupta</td> <td></td> <td>14/05/26</td> </tr> </table>	निर्माणकर्ता WORKED BY	Abhishek Kumar		14/5/26	जांचकर्ता CHECKED BY	Shivangi Gupta		14/05/26							
निर्माणकर्ता WORKED BY	Abhishek Kumar		14/5/26															
जांचकर्ता CHECKED BY	Shivangi Gupta		14/05/26															

<small>वे हस्ताक्षर SIGN & DATE</small>		<h1 style="margin: 0;">उत्पाद क्रय विनिर्देश</h1> <h2 style="margin: 0;">PRODUCT PURCHASE SPECIFICATION</h2>	<h3 style="margin: 0;">TG60432</h3> <p style="margin: 0;">पृष्ठ 8 का 3</p> <p style="margin: 0;">Page 3 of 8</p>												
<small>समग्री सूची संख्या को अधिकृतित करता है</small>	<small>SUPERSEDES INVENTORY</small>	<table border="1" style="width:100%; border-collapse: collapse;"> <thead> <tr> <th style="width:33%;">MATERIAL CODE OF VAPOUR EXHAUSTER ASSEMBLY</th> <th style="width:33%;">EFFICIENCY CLASS OF MOTOR AS PER IEC-60034-30</th> <th style="width:33%;">STARTING CURRENT (IN % OF FULL LOAD CURRENT) + 20% (Tolerance as per IEC: 60034-1)</th> </tr> </thead> <tbody> <tr> <td style="text-align: center;">W96415000578</td> <td style="text-align: center;">IE-2</td> <td style="text-align: center;">650</td> </tr> <tr> <td style="text-align: center;">W96415003127</td> <td style="text-align: center;">IE-3</td> <td style="text-align: center;">700</td> </tr> <tr> <td style="text-align: center;">TG9741500009</td> <td style="text-align: center;">IE-4</td> <td style="text-align: center;">700</td> </tr> </tbody> </table> <p>3.3.6 Permissible voltage variation : ± 10%</p> <p>3.3.7 Permissible Frequency variation : ± 5%</p> <p>3.3.8 Combined voltage & frequency variation : + 10%</p> <p>3.3.9 Min. voltage required under starting : 85%</p> <p>3.3.10 Conditions to bring driven equipment to rated speed</p> <p>3.3.11 Starting Torque : Min. 1.3 times the rated torque.</p> <p>3.3.12 Breakdown torque : Min. 2 times the rated torque.</p> <p>3.3.13 Starting : DOL</p> <p>3.3.14 Acceleration time with full load connected: 3.5 + 0.5 sec.</p> <p>3.3.15 Starting duty : 3 starts spread over on hour and 2 consecutive starts from hot</p> <p>3.3.16 Condition without injurious heating to the winding.</p> <p>3.3.17 Overload capacity : Motor shall be capable of running at full load with 80% of rated</p> <p>3.3.18 Voltage for 10min. and 70% of rated voltage for 1 min.</p> <p>3.3.19 Class of insulation : 'F' with temperature limited to Class B (70 °C)</p> <p>3.3.20 Ventilation : Totally enclosed & fan cooled</p> <p>3.3.21 Enclosure protection : IP 55 as per IEC 60034-5</p> <p>3.3.22 Explosion proof : Group II T4 as per IEC 60079</p> <p>3.3.23 Bearing : as per suppliers design. Life not less than 50000hrs.</p> <p>3.3.24 Earthing : Suitable arrangement to be provided at 2 places.</p> <p>3.3.25 Terminal box : Terminal box shall be explosion proof as per Group II T4 IEC 60079.</p> <p>3.3.26 Cable gland also to be provided in terminal box for 3 core Aluminium cable.</p> <p>3.3.27 Fault level: 50 KA for 1 sec.</p> <p>4.0 PUMP DATA SHEET (TO BE FURNISHED ALONGWITH OFFER :</p> <p>4.1 Capacity M3 / Sec. :</p> <p>4.2 Head MWC :</p> <p>4.3 Efficiency :</p> <p>4.4 Rated speed :</p> <p>4.5 Exhauster B.H.P. / kw at Rated Capacity :</p> <p>4.6 Material: Casing Impeller base Frame 'o' ring :</p> <p>4.7 Type of bearing used :</p> <p>4.8 Type of coupling :</p> <p>4.9 Type of Sealing :</p> <p>4.10 Suction size :</p> <p>4.11 Discharging size :</p>		MATERIAL CODE OF VAPOUR EXHAUSTER ASSEMBLY	EFFICIENCY CLASS OF MOTOR AS PER IEC-60034-30	STARTING CURRENT (IN % OF FULL LOAD CURRENT) + 20% (Tolerance as per IEC: 60034-1)	W96415000578	IE-2	650	W96415003127	IE-3	700	TG9741500009	IE-4	700
MATERIAL CODE OF VAPOUR EXHAUSTER ASSEMBLY	EFFICIENCY CLASS OF MOTOR AS PER IEC-60034-30	STARTING CURRENT (IN % OF FULL LOAD CURRENT) + 20% (Tolerance as per IEC: 60034-1)													
W96415000578	IE-2	650													
W96415003127	IE-3	700													
TG9741500009	IE-4	700													
<small>दिनांक एवं हस्ताक्षर SIGN & DATE</small>	<small>समग्री सूची संख्या INVENTORY</small>	<small>सब्सक्रिप्ट और गोपनीय</small> <small>इस प्रारंभ में दी गई सूचना भारत हेवी एलेक्ट्रिकल्स को सम्पत्ति है इसका प्रत्यक्ष एवं अप्रत्यक्ष रूप से किसी भी तरह प्रयोग जो कि सम्पत्ती के हित में हानिकारक हो न</small>													
<small>वे हस्ताक्षर SIGN & DATE</small>	<small>समग्री सूची संख्या INVENTORY</small>	<small>REV. NO. 05</small>	<table border="1" style="width:100%; border-collapse: collapse;"> <tr> <td style="width:20%;"><small>निर्माणकर्ता WORKED BY</small></td> <td style="width:20%;">Abhishek Kumar</td> <td style="width:20%; text-align: center;"></td> <td style="width:20%; text-align: center;">14/05/26</td> </tr> <tr> <td><small>जांचकर्ता CHECKED BY</small></td> <td>Shivangi Gupta</td> <td style="text-align: center;"></td> <td style="text-align: center;">14/05/26</td> </tr> </table>	<small>निर्माणकर्ता WORKED BY</small>	Abhishek Kumar		14/05/26	<small>जांचकर्ता CHECKED BY</small>	Shivangi Gupta		14/05/26				
<small>निर्माणकर्ता WORKED BY</small>	Abhishek Kumar		14/05/26												
<small>जांचकर्ता CHECKED BY</small>	Shivangi Gupta		14/05/26												

व हस्ताक्षर SIGN & DATE		उत्पाद क्रय विनिर्देश PRODUCT PURCHASE SPECIFICATION		TG60432 पृष्ठ 8 का 4 Page 4 of 8		
SUPERSEDES INVENTORY सामग्री सूची संख्या को अधिकारित करता है	4.12 Wt. of exhauster with motors base frame : 4.13 Wt. of exhauster : 4.14 General assy. & cross sectionals drawing enclosed with offer : 4.15 Capacity Vs discharge pressure curve enclosed : 4.16 Power consumption Vs discharge pressure curve enclosed : 4.17 Capacity Vs efficiency curve enclosed :					
COPYRIGHT AND CONFIDENTIAL The information on this documents is the property of Bharat Heavy Electrical Limited. It must not be used directly or indirectly in any way detrimental to the interest of the company	5.0 MOTOR DATA SHEET (TO BE FURNISHED ALONG WITH OFFER) 5.1 Manufacturer : 5.2 Type : 5.3 Frame size : 5.4 Power absorbed by exhauster at duty point (kW) : 5.5 Rated power (kW) : 5.6 Duty cycle : 5.7 Rated voltage : 5.8 No. of phase : 5.9 Frequency : 5.10 Allowable voltage variation : 5.11 Allowable frequency variation : 5.12 Allowable voltage & frequency variation : 5.13 Current : 5.14 Rated speed (RPM) : 5.15 Full load efficiency : 5.16 Full load power factor : 5.17 Method of starting : 5.18 Max. starting current : 5.19 Class of insulation : 5.20 Starting torque : 5.21 Max. torque : 5.22 Safe stall time : a. Under hot condition : b. Under cold condition : 5.23 Type of enclosure : 5.24 Enclosure protection : 5.25 Frequency of starting : 5.26 Temp. rise above 500C : 5.27 By resistance method : By thermometer method : 5.28 Type & no. of terminals brought out : 5.29 Type of connection during continuous running : 5.30 Type and size of cable for when gland is provided in the terminal box. : 5.31 Guaranteed min. voltage read at non terminals : 5.32 System of earthing :					
स्वत्वधिकार एवं गोपनीय इस प्रलेख में दी गई सूचना भारत हेवी एलेक्ट्रिकल्स की सम्पत्ति है इसका प्रत्यक्ष एवं अप्रत्यक्ष रूप से किसी भी तरह प्रयोग जो कि कंपनी के हित में हानिकारक हो न						
दिनक एवं हस्ताक्षर SIGN & DATE <i>Signature</i> 15/5/26						
सामग्री सूची संख्या INVENTORY NO. P-5894	REV. NO. 05		निर्माणकर्ता WORKED BY	Abhishek Kumar	<i>AK</i>	14/5/26
			जांचकर्ता CHECKED BY	Shivangi Gupta	<i>Shivangi</i>	14/05/26

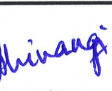
व हस्ताक्षर SIGN & DATE		<h2 style="text-align: center;">उत्पाद क्रय विनिर्देश</h2> <h3 style="text-align: center;">PRODUCT PURCHASE SPECIFICATION</h3>	TG60432			
सामग्री सूची संख्या को अधिकतम करना है SUPERSEDES INVENTORY				पृष्ठ 8 का 5 Page 5 of 8		
COPYRIGHT AND CONFIDENTIAL The information on this documents is the property of Bharat Heavy Electrical Limited. It must not be used directly or indirectly in any way detrimental to the interest of the company		<p>5.33 Relevant standard :</p> <p>5.34 Motor GD2 Valve :</p> <p>5.35 Type of bearings (DE) :</p> <p>5.36 Type of bearings (NDE) :</p> <p>5.37 Type of lubricant :</p> <p>5.38 Frequency of lubrication :</p> <p>5.39 Wt. of motor :</p> <p>5.40 Insulation class :</p> <p>6.0 QUALITY ASSURANCE, INSPECTION AND TESTING.</p> <p>6.1 The manufacture shall conduct all tests required to ensure that the exhauster conforms to the requirements of application codes and standards.</p> <p>6.2 The bidder shall submit the particulars of proposed shop tests along with procedures for information.</p> <p>6.3 The equipment shall be dispatched only after inspection and clearance by BHEL / owner.</p> <p>6.4 The min. tests check to be carried out on vapour exhauster, as envisaged by BHEL are given below: -</p> <p>6.4.1 The material of Casing, Impeller, Base frame, Sleeve & O Ring shall be tested as per relevant standard for the chemical composition and mechanical properties.</p> <p>6.4.2 TESTS DURING VARIOUS STAGE OF MANUFACTURING</p> <p>1)Check for dimension and finish of the components.</p> <p>2)D.P.T on all welding as per ASME section VIII.</p> <p>3)Dynamic balancing of impeller as per ISO 1940 Gr. 6.3.</p> <p>6.4.3 FINAL TESTS: - Following tests shall be carried out: -</p> <p>1)Flow rate of air</p> <p>2)Vibration test as per IEC 60034-14.</p> <p>3)Noise : shall not be greater than 85dB when measured at a distance of 1 meter from the base of the equipment, measurement should be done as per IEC 60034-9</p> <p>4)Speed</p> <p>5)Dimensional check</p> <p>6)Smooth running</p> <p>7)Performance test as per ISO:5801</p> <p>6.4.4 Type & Routine tests on motor as per IEC:60034-1</p> <p>6.4.5 Vendor to furnish the test certificates for the following</p> <p>1)Motor Enclosure certificate as per IP 55 as per IEC 60034-5</p> <p>2)Explosion proof certificate for motor for Group II T4 as per IEC60079</p> <p>3)Certificate for enclosure of Terminal box for explosion proof as per Group II T4 IEC 60079.</p> <p>4)Certificate for minimum clearance of 2mm between impeller & casing.</p>				
	स्वत्वाधिकार एवं गोपनीय इस प्रलेख में दी गई सूचना भारत हेवी एलेक्ट्रिकल्स की सम्पत्ति है इसका प्रत्यक्ष एवं अप्रत्यक्ष रूप से किसी भी तरह प्रयोग जो कि कंपनी के हित में हानिकारक हो न					
दिनक एवं हस्ताक्षर SIGN & DATE						
सामग्री सूची संख्या INVENTORY NO	REV. NO. 05		निर्माणकर्ता WORKED BY	Abhishek Kumar		14/5/26
P-5894			जांचकर्ता CHECKED BY	Shivangi Gupta		14/05/26

व हस्ताक्षर SIGN & DATE		उत्पाद क्रय विनिर्देश PRODUCT PURCHASE SPECIFICATION		TG60432 पृष्ठ 8 का 6 Page 6 of 8		
SUPERSEDES INVENTORY सामग्री सूची संख्या को अधिकृतित करता है	<p style="text-align: center;">6.4.6 After testing the exhauster, all the surface and internal shall be thoroughly cleaned, dried and conserved. All the metallic surface except bright parts exposed to weather shall be given suitable primary coating.</p> <p>7.0 DOCUMENTS TO BE FURNISHED AT THE TIME OF OFFER</p> <p>7.1 Assembly drawings part list, nozzle size, their coordinates base plate details etc.</p> <p>7.2 Technical data sheet of pump as per clause 4.</p> <p>7.3 Technical data sheet of motor as per clause 5.</p> <p>7.4 Performance curves.</p> <p>7.5 Quality plan in BHEL format, incorporating checks/tests at material stages, in process & final testing.</p> <p>7.6 Clause wise confirmations of specification TG60432.</p> <p>8.0 DOCUMENT TO BE SUPPLIED</p> <p>8.1 AFTER PLACEMENT OF ORDER</p> <p>8.1.1 G.A. drawing with parts list & material details.</p> <p>8.1.2 Final quality plan.</p> <p>8.2 DOCUMENT FOR FINAL SUBMISSION</p> <p>8.2.1 Performance curves.</p> <p>8.2.2 Test certificates for all test checks in clause 6.4 shall be furnished.</p> <p>9.0 CLEANING, PAINTING, CONSERVATION AND PACKING</p> <p>The surface shall be cleaned and prepared for application of paint by shot blasting. The protective coating should be oil resistant. After testing the exhauster, its internals shall be thoroughly cleaned, dried and conserved before packing. The exhauster packing shall be strong enough to safeguard against any damage during transit. The exhauster shall be packed such that it is safe for at least 2 year of storage in damp atmosphere.</p> <p>10.0 GUARANTEE</p> <p>10.1 The supplier shall guarantee trouble free and satisfactory operation of the equipment for a period of 12 months after commissioning at site or 18 months from the date of dispatch, whichever is earlier.</p> <p>10.2 The supplier shall guarantee the tested capacity head and capacity of the exhauster.</p> <p>10.3 The supplier shall repair /replace the defective parts at his own cost during the guarantee period.</p>					
COPYRIGHT AND CONFIDENTIAL The information on this documents is the property of Bharat Heavy Electrical Limited It must not be used directly or indirectly in any way detrimental to the interest of the company						
स्वत्वाधिकार एवं गोपनीय इस प्रलेख में दी गई सूचना भारत-भेरी एलेक्ट्रिकल्स की सम्पत्ति है इसका प्रत्यक्ष एवं अप्रत्यक्ष रूप से किसी भी तरह प्रयोग जो कि कम्पनी के हित में हानिकारक हो न						
दिनक एवं हस्ताक्षर SIGN & DATE 						
सामग्री सूची संख्या INVENTORY NO. P-5894	REV. NO. 05		निर्माणकर्ता WORKED BY	Abhishek Kumar		14/5/26
			जांचकर्ता CHECKED BY	Shivangi Gupta		14/5/26

व हस्ताक्षर SIGN & DATE		उत्पाद क्रय विनिर्देश PRODUCT PURCHASE SPECIFICATION		TG60432 पृष्ठ 8 का 7 Page 7 of 8			
सामग्री सूची संख्या को अधिकृतित करता है	SUPERSIDES INVENTORY	11.0 IDENTIFICATION A name plate of stainless steel with following information engraved on it, shall be affixed to the equipment at appropriate location – <ul style="list-style-type: none"> - Item description - Manufacturer's name - Year of manufacturing - Sl. No. - Main technical parameters i.e. Flow rate, Discharge pressure, Speed, Flow Medium, operating temperature, Motor KW Rating. - BHEL specification no. - BHEL material code. - BHEL P.O. No. 					
COPYRIGHT AND CONFIDENTIAL The information on this documents is the property of Bharat Heavy Electrical Limited. It must not be used directly or indirectly in any way detrimental to the interest of the company		12.0 GENERAL Bidder shall furnish all the documents as per clause 7 of the specification along with offer. Any deviation shall be clearly spelled out. The offer may not be considered if all the technical particulars and information called for in the specification are not submitted along with the offer.					
स्वत्वाधिकार एवं गोपनीय इस प्रलेख में दी गई सूचना भारत हेवी एलेक्ट्रिकल्स की सम्पत्ति है. इसका प्रत्यक्ष एवं अप्रत्यक्ष रूप से किसी भी तरह प्रयोग, जो कि कंपनी के हित में हानिकारक हो न		13.0 CROSS REFERRED STANDARD ISO 1940, ISO 5801 IEC 60034-14, IEC 60034-9, IEC 60034-1, IEC 60034-5, IEC 60079 IS:2062					
दिनक एवं हस्ताक्षर SIGN & DATE	15/5/26						
सामग्री सूची संख्या INVENTORY	P-5894	REV. NO. 05		निर्माणकर्ता WORKED BY Abhishek Kumar		14/5/26	
				जांचकर्ता CHECKED BY Shivangi Gupta		14/05/26	

हस्ताक्षर
SIGN & DATE



उत्पाद क्रय विनिर्देश

PRODUCT PURCHASE SPECIFICATION

TG60432

पृष्ठ 8 का 8
Page 8 of 8

SUPERSEDES
INVENTORY

सामग्री सूची संख्या को
अधिकतम करता है

COPYRIGHT AND CONFIDENTIAL.
The information on this documents is the property of Bharat Heavy Electrical Limited. It must not be used directly or indirectly in any way detrimental to the interest of the company

स्वत्वाधिकार एवं गोपनीय

इस प्रलेख में दी गई सूचना भारत हेवी एलेक्ट्रिकल्स की सम्पत्ति है। इसका प्रयोग एवं अप्रत्यक्ष रूप से किसी भी तरह प्रयोग जो कि कंपनी के हित में हानिकारक हो न

दिनांक एवं हस्ताक्षर
SIGN & DATE

Signature
15/5/26

सामग्री सूची संख्या
INVENTORY NO.

REV. NO. 05

निर्माणकर्ता
WORKED BY

Abhishek
Kumar

Signature

14/5/26

जांचकर्ता
CHECKED BY

Shivangi Gupta

Signature

11/05/26

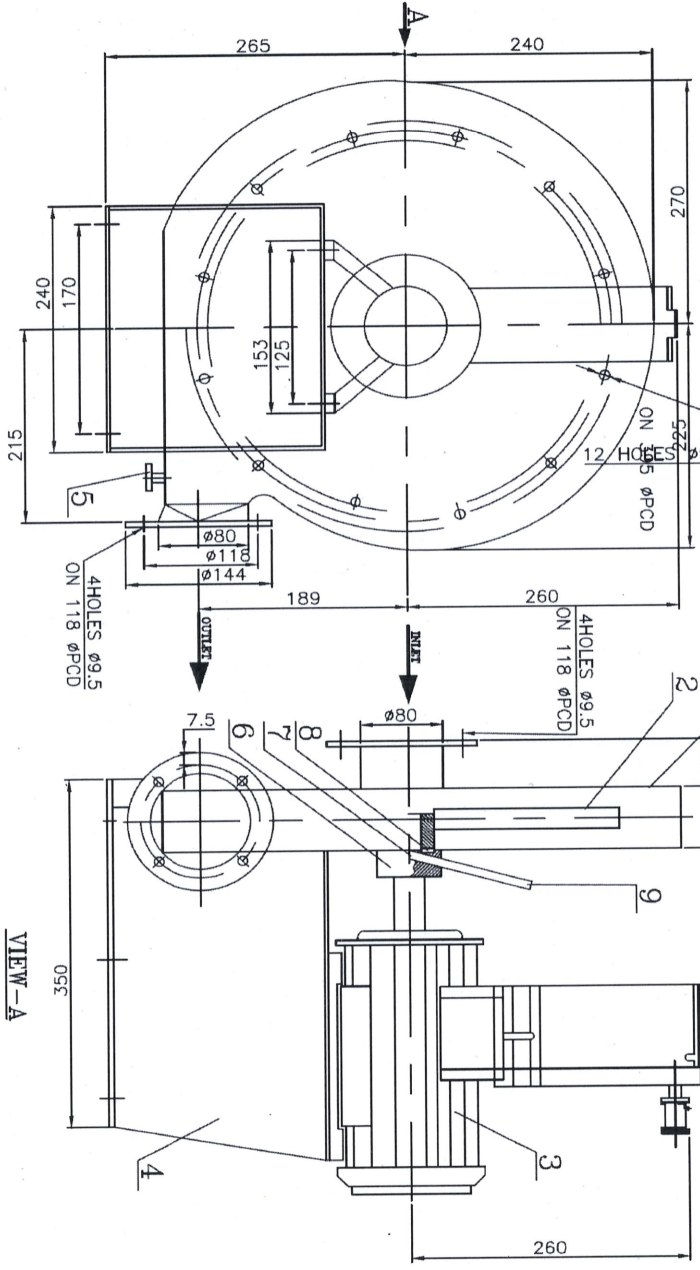

PART NO.	DESCRIPTION
1	CASING
2	IMPELLER
3	MOTOR
4	MOTOR SUPORTING BRACKET
5	DRAIN PLUG
6	STUFFING BOX
7	'O' RING OIL SEAL
8	SLEEVE
9	GREASE NIPPLE

बिड दस्तावेज़ / Bid Document

बिड विवरण / Bid Details	
बिड बंद होने की तारीख/समय / Bid End Date/Time	24-06-2026 15:00:00
बिड खुलने की तारीख/समय / Bid Opening Date/Time	24-06-2026 15:30:00
बिड पेशकश वैधता (बंद होने की तारीख से) / Bid Offer Validity (From End Date)	120 (Days)
मंत्रालय/राज्य का नाम / Ministry/State Name	Ministry Of Heavy Industries And Public Enterprises
विभाग का नाम / Department Name	Department Of Heavy Industry
संगठन का नाम / Organisation Name	Bharat Heavy Electricals Limited (bhel)
कार्यालय का नाम / Office Name	10110009-heap, Haridwar
शिकायत निवारण के संपर्क विवरण / Contact details of Grievance redressal	adesh@bhel.in
कुल मात्रा / Total Quantity	2
वस्तु श्रेणी / Item Category	VAPOUR EXHAUSTER WITH IE3 MOTOR SPEC: TG60432 REV: 05
GeMARPTS में खोजी गई स्ट्रिंग्स / Searched Strings used in GeMARPTS	vapour exhauster
GeMARPTS में खोजा गया परिणाम / Searched Result generated in GeMARPTS	Chemical Vapour Deposition System, Fume Exhaust System with Scrubber or Fume Hood with Scrubber, High Pressure Mercury Vapour Lamps Conforming To IS 9900, Smoke Exhauster cum Blower OR Air Exhausters, High Pressure Sodium Vapour Lamps (HPSV Lamps) Conforming To IS 9974, Vapour Pressure Dial Type Thermometer -as per EN 13190, PULLEY FOR EXHAUST FAN, Ballasts For Discharge Lamps Conforming To IS 15882, Propeller Type AC Ventilating Fans (Exhaust Fan) (V3) Conforming To IS 2312, Kerosene Oil Fired Bukhari with Exhaust Pipes as per MHA QRs
अधिसूचना के लिए चयनित प्रासंगिक श्रेणियाँ / Relevant Categories selected for notification	<ul style="list-style-type: none"> Smoke Exhauster cum Blower OR Air Exhausters
एमएसएमई के लिए अनुभव के वर्षों और टर्नओवर से छूट प्रदान की गई है / MSE Relaxation for Years of Experience and Turnover	No
स्टार्टअप के लिए अनुभव के वर्षों और टर्नओवर से छूट प्रदान की गई है / Startup Relaxation for Years of Experience and Turnover	No

बिड विवरण/Bid Details	
विक्रेता से मांगे गए दस्तावेज़/Document required from seller	Certificate (Requested in ATC) *In case any bidder is seeking exemption from Experience / Turnover Criteria, the supporting documents to prove his eligibility for exemption must be uploaded for evaluation by the buyer
क्या आप निविदाकारों द्वारा अपलोड किए गए दस्तावेजों को निविदा में भाग लेने वाले सभी निविदाकारों को दिखाना चाहते हैं? संदर्भ मेन् है/Do you want to show documents uploaded by bidders to all bidders participated in bid?	No
बिड लगाने की समय सीमा स्वतः नहीं बढ़ाने के लिए आवश्यक बिड की संख्या। / Minimum number of bids required to disable automatic bid extension	2
दिनों की संख्या, जिनके लिए बिड लगाने की समय-सीमा बढ़ाई जाएगी। / Number of days for which Bid would be auto-extended	7
ऑटो एक्सटेंशन अधिकतम कितनी बार किया जाना है। / Number of Auto Extension count	1
बिड से रिवर्स नीलामी सक्रिय किया/Bid to RA enabled	Yes
रिवर्स नीलामी योग्यता नियम/RA Qualification Rule	H1-Highest Priced Bid Elimination
क्रेता के लिए उपलब्ध आईटीसी/ITC available to buyer	Yes
बिड का प्रकार/Type of Bid	Two Packet Bid
तकनीकी मूल्यांकन के दौरान तकनीकी स्पष्टीकरण हेतु अनुमत समय /Time allowed for Technical Clarifications during technical evaluation	2 Days
निरीक्षण आवश्यक (सूचीबद्ध निरीक्षण प्राधिकरण /जेम के साथ पूर्व पंजीकृत एजेंसियों द्वारा)/Inspection Required (By Empanelled Inspection Authority / Agencies pre-registered with GeM)	No
Payment Timelines	Payments shall be made to the Seller within 45 days of issue of consignee receipt-cum-acceptance certificate (CRAC) and on-line submission of bills (This is in supersession of 10 days time as provided in clause 12 of GeM GTC)
मूल्यांकन पद्धति/Evaluation Method	Total value wise evaluation
मध्यस्थता खंड/Arbitration Clause	No
सुलह खंड/Mediation Clause	No

ईएमडी विवरण/EMD Detail

आवश्यकता/Required	No
--------------------------	----

ईपीबीजी विवरण /ePBG Detail

आवश्यकता/Required	No
-------------------	----

बोली विभाजन लागू नहीं किया गया/ Bid splitting not applied.

एमआईआई खरीद वरीयता/MII Purchase Preference

एमआईआई खरीद वरीयता/MII Purchase Preference	No
--	----

एमएसई खरीद वरीयता/MSE Purchase Preference

एमएसई खरीद वरीयता/MSE Purchase Preference	Yes
सूक्ष्म और लघु उद्यम मूल उपकरण निर्माताओं/सेवा प्रदाता को खरीद में प्राथमिकता, यदि उनका मूल्य L1+X% / Purchase Preference to MSE OEMs/ Service Provider available upto price within L1+X%	15
सूक्ष्म और लघु उद्यम मूल उपकरण निर्माता/सेवा प्रदाता को खरीद में प्राथमिकता के लिए बिड की मात्रा का अधिकतम प्रतिशत / Percentage of Bid quantity/amount for MSE OEMs/ Service Provider Purchase preference	100

ट्रेड्स भुगतान संबंधी विवरण/TReDS Payment Details

This Bid provides for Trade Receivables Discounting System (TReDS) as Preferred mode of payment. For MSME sellers, payments may be processed through a TReDS exchange in which the Buyer is registered, subject to applicable policy and regulatory guidelines. Accordingly, sellers intending to avail payment through TReDS are required to be registered with at least one TReDS exchange in which the buyer is registered.

1. **Purchase preference to Micro and Small Enterprises (MSEs):** Purchase preference will be given to MSEs having valid Udyam Certificate and whose credentials are validated online through Udyam Registration portal as defined in Public Procurement Policy for Micro and Small Enterprises (MSEs) Order, 2012 dated 23.03.2012 issued by Ministry of Micro, Small and Medium Enterprises and its subsequent Orders/Notifications issued by concerned Ministry. If the bidder wants to avail themselves of the Purchase preference, the bidder must be the manufacturer / OEM of the offered product on GeM. In respect of bid for Services, the bidder must be the Service provider of the offered Service. Traders are excluded from the purview of Public Procurement Policy for Micro and Small Enterprises and hence resellers offering products manufactured by some other OEM are not eligible for any purchase preference. Relevant documentary evidence in this regard shall be uploaded along with the bid in respect of the offered product or service, and Buyer will decide eligibility for purchase preference based on documentary evidence submitted in case of product bids, whereas in case of services the eligibility is automatically validated. If L-1 is not an MSE and MSE Seller (s) has / have quoted price within L-1+ 15% (Selected by Buyer) of margin of purchase preference /price band defined in relevant policy, such MSE Seller shall be given opportunity to match L-1 price and contract will be awarded for 100% (selected by Buyer) percentage of total quantity. The buyers are advised to refer the [OM No.1 4 2021 PPD dated 18.05.2023](#) for compliance of Concurrent application of Public Procurement Policy for Micro and Small Enterprises Order, 2012 and Public Procurement (Preference to Make in India) Order, 2017. Benefits of MSE will be allowed only if seller is validated on-line in GeM profile as well as validated and approved by Buyer after evaluation of documents submitted.

2. Reverse Auction would be conducted amongst all the technically qualified bidders except the Highest quoting bidder. The technically qualified Highest Quoting bidder will not be allowed to participate in RA. However, H-1

will also be allowed to participate in RA in following cases:

- If number of technically qualified bidders are only 2 or 3.
- If Buyer has chosen to split the bid amongst N sellers, and H1 bid is coming within N.
- In case Primary product of only one OEM is left in contention for participation in RA on elimination of H-1.
- If L-1 is non-MSE and H-1 is eligible MSE and H-1 price is coming within price band of 15% of Non-MSE L-1
- If L-1 is non-MII and H-1 is eligible MII and H-1 price is coming within price band of 20% of Non-MII L-1

If the buyer has mentioned MSE purchase preference in ATC then service provider is required to upload necessary documents for MSE purchase preference for verification by the buyer during evaluation.

VAPOUR EXHAUSTER WITH IE3 MOTOR SPEC: TG60432 REV: 05 (2 pieces)

तकनीकी विशिष्टियाँ /Technical Specifications

क्रेता विशिष्टि दस्तावेज़ /Buyer Specification Document	Download
---	--------------------------

इनपुट कर क्रेडिट(आईटीसी) तथा रिवर्स प्रभार (आरसीएम)/Input Tax Credit(ITC) and Reverse Charge(RCM) Details

जीएसटी पर इनपुट कर क्रेडिट /ITC on GST	जीएसटी उपकर कर क्रेडिट /ITC on GST Cess
100%	NA

अतिरिक्त विशिष्टि दस्तावेज़ /Additional Specification Documents

DrawingDocument1	View
DrawingDocument2	View

परेषिती/रिपोर्टिंग अधिकारी तथा मात्रा/Consignees/Reporting Officer and Quantity

क्र.सं./S.N o.	परेषिती/रिपोर्टिंग अधिकारी /Consignee Reporting/Officer	पता/Address	डिलीवरी अनुसूची /Delivery Schedule अनुबंध प्रारंभ होने की तारीख से दिनों की संख्या में /(In number of days from contract start days)		
			मात्रा /Quantity	प्रारंभ होने की तारीख से डिलीवरी /Delivery to start after	डिलीवरी _____तक पूरी कर ली जाए /Delivery to be completed by
1	Shekhar Saini	135001,OFFICE OF CHIEF ENGINEER/DCRTPP, HARYANA POWER GENERATION CORPORATION LIMITED (HPGCL), 1X800 MW ULTRA SUPERCRITICAL EXPANSION UNIT, DEEN BANDHU CHHOTU RAM THERMAL POWER PLANT (DCRTPP), VPO- PANSARA, YAMUNA NAGAR, HARYANA	2	1	426

Buyer added Bid Specific Additional Scope of Work

क्र.सं./S.No.	Document Title	Description	रिवर्स प्रभार के अनुसार जीएसटी/Applicable i.r.o. Items
1	PQR View	PQR	VAPOUR EXHAUSTER WITH IE3 MOTOR SPEC: TG60432 REV: 05(2)
2	QP View	QP	VAPOUR EXHAUSTER WITH IE3 MOTOR SPEC: TG60432 REV: 05(2)
3	ATC View	ATC	VAPOUR EXHAUSTER WITH IE3 MOTOR SPEC: TG60432 REV: 05(2)

The uploaded document only contains Buyer specific Additional Scope of Work and / or Drawings for the bid items added with due approval of Buyer's competent authority. Buyer has certified that these additional scope and drawings are generalized and would not lead to any restrictive bidding.

क्रेता द्वारा जोड़ी गई बिड की विशेष शर्तें/Buyer Added Bid Specific Terms and Conditions

1. Generic

OPTION CLAUSE: The Purchaser reserves the right to increase or decrease the quantity to be ordered up to 25 percent of bid quantity at the time of placement of contract. The purchaser also reserves the right to increase the ordered quantity up to 25% of the contracted quantity during the currency of the contract at the contracted rates. The delivery period of quantity shall commence from the last date of original delivery order and in cases where option clause is exercised during the extended delivery period the additional time shall commence from the last date of extended delivery period. The additional delivery time shall be $(\text{Increased quantity} \div \text{Original quantity}) \times \text{Original delivery period (in days)}$, subject to minimum of 30 days. If the original delivery period is less than 30 days, the additional time equals the original delivery period. The Purchaser may extend this calculated delivery duration up to the original delivery period while exercising the option clause. Bidders must comply with these terms.

2. Buyer Added Bid Specific ATC

Buyer Added text based ATC clauses

E-bids on GeM portal are invited from bidders for the supply of Vapour Exhauster with IE3 Motor (As per TG60432 Rev 05) as below description for Yamunanagar Project, as per requirement mentioned below:

Sl. No.	Material Code & Item Description	Project	Total Qty (set)	Tentative Date for Supply Completion
1	Material Code W9641500 3127 Vapour Exhauster with IE3 Motor SPEC: TG 60432 REV: 05	1X800MW YAMUNA NAGAR HPGCL	2 Nos.	30.09.2027

1. **Consignee Details:**

OFFICE OF CHIEF ENGINEER/DCRTPP, HPGCL, 1X800 MW ULTRA SUPERCRITICAL EXPANSION UNIT, DEEN BANDHU CHHOTU RAM THE
RMAL POWER PLANT (DCRTPP), VPO- PANSARA, YAMUNA NAGAR, HARYANA-135001, INDIA

3. **Buyer Added Bid Specific ATC**

Buyer uploaded ATC document [Click here to view the file.](#)

अस्वीकरण/Disclaimer

The Additional Terms and Conditions (ATC) have been incorporated by the Buyer after approval of their Competent Authority. The Buyer, is solely responsible for the impact of these clauses on the bidding process, its outcome, and consequences thereof including any restriction arising in the bidding process due to these ATCs and including the modification of technical specifications and / or terms and conditions governing the bid. All representations / grievances pertaining to the ATC clauses shall be raised with the buyer organization directly and not with GeM. If any of the clause(s) is/are incorporated by the Buyer regarding the following, the bid & resultant contract shall be treated as null & void. Further, GeM reserves the right, at its sole discretion, to cancel the bid forthwith, without issuance of any prior notice or intimation :-

1. Publishing Custom / BOQ bids for items for which regular GeM categories are available (unless such Custom / BOQ item is bunched with the major regular product Category Item).
2. Mandating procurement of / from specific Brand / Make / Model / Manufacturer / Dealer except in case of Single Bid / Proprietary Article Certificate (PAC) Buying.
3. Inclusion of disqualification criteria related to suspension of seller / service provider, where such suspension period has already expired.
4. Mandating submission of documents in physical form as a pre-requisite to qualify bidders.
5. Publishing bids on GeM for procurement of works.
6. Procurement of Goods by creating a Service bid on GeM & vice-versa.
7. Seeking sample with bid or approval of samples during bid evaluation process. However, trial / sample, as the case may be, shall be permitted in cases where trial / sample are allowed as per approved and published procurement policy of the Buyers' controlling Ministry / Department / State / Public Sector Enterprises Headquarters. If there is any violation of trial / sample clause with regard to approved policy of the Buyers' Ministry / Department / State / Public Sector Enterprises Headquarters, then this is to be determined and redressed by the concerned Buyer Organisation only.
8. Seeking experience from specific organization / department / institute only or from foreign / export experience.
9. Creating bid for items from incorrect categories.
10. Reference of conditions published on any external site or reference to external documents/clauses.
11. Asking for any Tender fee / Bid Participation fee, as the case may be.
12. Buyer added ATC Clauses which are in contravention of clauses defined in bid detail section, including specifications, EMD Detail, ePBG Detail and MII and MSE Purchase Preference sections of the bid, unless otherwise allowed by the applicable GeM GTC.
13. Any ATC clause in contravention with GeM GTC Clause 4 (xiii) (h) will be invalid. In case of multiple L1 bidders against a service bid, the buyer shall place the Contract by selection of a bidder amongst the L-1 bidders through a Random Algorithm executed by GeM system.
14. In a category based bid, adding additional items, through buyer added, additional scope of work/ additional terms and conditions/or any other document. If buyer needs more items along with the main item, the same must be added through bunching category based items or by bunching custom catalogues or bunching a BoQ with the main category based item, the same must not be done through ATC or Scope of Work.

Further, if any seller has any objection/grievance against these additional clauses or otherwise on any aspect of this bid, they can raise their representation against the same by using the Representation window provided in

the bid details field in Seller dashboard after logging in as a seller. Buyer is duty bound to reply to all such representations and would not be allowed to open bids if he fails to reply to such representations.

All GeM Sellers/Service Providers shall ensure full compliance with all applicable labour laws, including the provisions, rules, schemes and guidelines under the four Labour Codes i.e. the Code on Wages, 2019; the Industrial Relations Code, 2020; the Occupational Safety, Health and Working Conditions Code, 2020; and the Code on Social Security, 2020 as and when notified and brought into force by the Government of India.

For all provisions of the Labour Codes that are pending operationalisation through rules, schemes or notifications, the corresponding provisions of the pre-existing labour enactments (such as The Minimum Wages Act, 1948, The Payment of Wages Act, 1936, The Payment of Bonus Act, 1965, The Equal Remuneration Act, 1976, The Payment of Gratuity Act, 1972, etc. and relevant State Rules) shall continue to remain applicable.

The Seller/ Service Providers shall, therefore, be responsible for ensuring compliance under:

- **All notified and enforceable provisions of the new Labour Codes as mentioned hereinabove; and**
- **All operative provisions of the erstwhile Labour Laws until their complete substitution.**

All obligations relating to wages, social security, safety, working conditions, industrial relations etc. and any other statutory requirements shall be strictly met by the Seller/ Service Provider. Any non-compliance shall constitute a breach of the contract and shall entitle the Buyer to take appropriate action in accordance with the contract and applicable law.

This Bid is governed by the General Terms and Conditions, conditions stipulated in Bid and Service Level Agreement specific to the Service, as the case may be, as provided in the Marketplace.

However, in case of Service, if any condition specified in General Terms and Conditions is contradicted by the conditions stipulated in Service Level Agreement specific to said Service, then it will over-ride the conditions in the General Terms and Conditions.

[यह बिड सामान्य शर्तों के अंतर्गत भी शासित है /This Bid is also governed by the General Terms and Conditions](#)

जेम की सामान्य शर्तों के खंड 26 के संदर्भ में भारत के साथ भूमि सीमा साझा करने वाले देश के बिडर से खरीद पर प्रतिबंध के संबंध में भारत के साथ भूमि सीमा साझा करने वाले देश का कोई भी बिडर इस निविदा में बिड देने के लिए तभी पात्र होगा जब वह बिड देने वाला सक्षम प्राधिकारी के पास पंजीकृत हो। बिड में भाग लेते समय बिडर को इसका अनुपालन करना होगा और कोई भी गलत घोषणा किए जाने व इसका अनुपालन न करने पर अनुबंध को तत्काल समाप्त करने और कानून के अनुसार आगे की कानूनी कार्रवाई का आधार होगा।/In terms of GeM GTC clause 26 regarding Restrictions on procurement from a bidder of a country which shares a land border with India, any bidder from a country which shares a land border with India will be eligible to bid in this tender only if the bidder is registered with the Competent Authority. While participating in bid, Bidder has to undertake compliance of this and any false declaration and non-compliance of this would be a ground for immediate termination of the contract and further legal action in accordance with the laws.

---धन्यवाद/Thank You---