 <b>BHEL</b> Tenders		Government eProcurement System			
Tender Details					
Date : 03-Jun-2022 04:49 PM					
 Print					
<b>Basic Details</b>					
<b>Organisation Chain</b>	Bharat Heavy Electricals Limited  HEEP-Haridwar  Electrical Machines				
<b>Tender Reference Number</b>	E/ E242/2/0281C1				
<b>Tender ID</b>	2022_BHEL_13447_1				
<b>Tender Type</b>	Open Tender	<b>Form of contract</b>	Buy		
<b>Tender Category</b>	Goods	<b>No. of Covers</b>	2		
<b>General Technical Evaluation Allowed</b>	No	<b>ItemWise Technical Evaluation Allowed</b>	Yes		
<b>Payment Mode</b>	Not Applicable	<b>Is Multi Currency Allowed For BOQ</b>	No		
<b>Is Multi Currency Allowed For Fee</b>	No	<b>Allow Two Stage Bidding</b>	No		
<b>Cover Details, No. Of Covers - 2</b>					
<b>Cover No</b>	<b>Cover</b>	<b>Document Type</b>	<b>Description</b>		
1	Fee/PreQual/Technical	.pdf	Technical Offer/ PQR Documents		
2	Finance	.xls	BOQ for Price Bid Opening		
<b>Tender Fee Details, [Total Fee in ₹ * - 0.00]</b>				<b>EMD Fee Details</b>	
<b>Tender Fee in ₹</b>	0.00	<b>Fee Payable To</b>	Nil	<b>Fee Payable At</b>	Nil
<b>Tender Fee Exemption Allowed</b>	No			<b>EMD Amount in ₹</b>	0.00
				<b>EMD through BG/ST or EMD Exemption Allowed</b>	No
				<b>EMD Fee Type</b>	fixed
				<b>EMD Percentage</b>	NA
				<b>EMD Payable To</b>	Nil
				<b>EMD Payable At</b>	Nil
<a href="#">Click to view modification history</a>					
<b>Work /Item(s)</b>					
<b>Title</b>	Procurement of Insulated Strip, Tube and Round				
<b>Work Description</b>	Procurement of Insulated Strip, Tube and Round				
<b>Pre Qualification Details</b>	Attached with tender documents				
<b>Independent External Monitor/Remarks</b>	NA				
<b>Show Tender Value in Public Domain</b>	No				
<b>Tender Value in ₹</b>	2,00,000	<b>Product Category</b>	Electronic Components And Devices	<b>Sub category</b>	NA
<b>Contract Type</b>	Tender	<b>Bid Validity(Days)</b>	120	<b>Period Of Work (Days)</b>	60
<b>Location</b>	HEEP BHAEL Haridwar	<b>Pincode</b>	249403	<b>Pre Bid Meeting Place</b>	NA
<b>Pre Bid Meeting Address</b>	NA	<b>Pre Bid Meeting Date</b>	NA	<b>Bid Opening Place</b>	HEEP BHEL Haridwar
<b>Should Allow NDA Tender</b>	No	<b>Allow Preferential Bidder</b>	No		

**Critical Dates**

<b>Publish Date</b>	03-Jun-2022 06:00 PM	<b>Bid Opening Date</b>	25-Jun-2022 04:00 PM
<b>Document Download / Sale Start Date</b>	03-Jun-2022 06:00 PM	<b>Document Download / Sale End Date</b>	25-Jun-2022 01:00 PM
<b>Clarification Start Date</b>	NA	<b>Clarification End Date</b>	NA
<b>Bid Submission Start Date</b>	03-Jun-2022 06:00 PM	<b>Bid Submission End Date</b>	25-Jun-2022 01:00 PM

**Tender Documents**

<b>NIT Document</b>	<b>S.No</b>	<b>Document Name</b>	<b>Description</b>	<b>Document Size (in KB)</b>
	1	Tendernotice_1.pdf	NIT Documents for Technical offer preparation	10632.57

<b>Work Item Documents</b>	<b>S.No</b>	<b>Document Type</b>	<b>Document Name</b>	<b>Description</b>	<b>Document Size (in KB)</b>
	1	Tender Documents	NIT20220281.pdf	NIT Documents for offer preparation	10617.00
	2	BOQ	BOQ_14218.xls	BOQ for Price Bid entry	282.50

**Bid Openers List**

<b>S.No</b>	<b>Bid Opener Login Id</b>	<b>Bid Opener Name</b>	<b>Certificate Name</b>
1.	ashim.dalui@bhel.in	ASHIM DALUI	ASHIM DALUI
2.	dharams@bhel.in	Dharam Singh	DHARAM SINGH
3.	seemant@bhel.in	Seemant Kumar Singh	SEEMANT KUMAR SINGH
4.	dimri@bhel.in	Arvind Dimri	ARVIND DIMRI

**GeMARPTS Details**

<b>GeMARPTS ID</b>	9UV7CISZQ406
<b>Description</b>	ROUND
<b>Report Initiated On</b>	23-May-2022
<b>Valid Until</b>	22-Jun-2022

**Tender Properties**

<b>Auto Tendering Process allowed</b>	No	<b>Show Technical bid status</b>	Yes
<b>Show Finance bid status</b>	Yes	<b>Show Bids Details</b>	Yes
BoQ Comparative Chart model	Normal	BoQ Comparative chart decimal places	3
BoQ Comparative Chart Rank Type	L	Form Based BoQ	No

**Tender Inviting Authority**

<b>Name</b>	Bharat Bhushan
<b>Address</b>	4rh Floor, EM Purchase ,Main Administrative Building, HEEP BHEL Haridwar

**Tender Creator Details**

<b>Created By</b>	ASHIM DALUI
<b>Designation</b>	ENGR
<b>Created Date</b>	03-Jun-2022 04:44 PM



PPX-EM DEPARTMENT  
BHARAT HEAVY ELECTRICALS LIMITED  
HEEP: HARDWAR-249 403 (Uttarakhand)  
TEL: +91 1334 28 5021

**OPEN TENDER ENQUIRY**  
**ENQUIRY NO. E/ E242/2/0281C1**  
**DATE OF ISSUE: 03.06.2022**  
**ENQUIRY DUE DATE: 25<sup>th</sup> June 2022 (By 16:00 HRS IST)**

The **Heavy Electrical Equipment Plant (HEEP)** located in Haridwar, is one of the major manufacturing plants of BHEL. The core business of HEEP includes design and manufacture of large size steam and gas turbines, turbo generators, heat exchangers, condensers and auxiliaries.

**Sealed Bids are invited by HEEP Hardwar, from Indian bidders for the supply of following items: -**

Item Detail	Tender Quantity
INSULATED ROUND	04 No
INSULATING STRIP	24 no
INSULATION TUBE	14 No

**The details are given in enclosed Tender Enquiry document no. E/ E242/2/0281C1. All offers shall be submitted on through NIC portal by vendor, no offline offers shall be accepted.**

The documents listed below form a part of this tender enquiry. Bidders are advised to study all the tender documents carefully. Any submission of tender by the bidder shall be deemed to have been done after careful study and examination of the tender documents and with full understanding of the implications thereof.

SL.NO.	LIST OF DOCUMENTS
1.	TENDER ENQUIRY NO. <b>E/ E242/2/0281C1</b>
2.	PRE-QUALIFICATION REQUIREMENT/ <b>ANNEXURE -A</b>
3.	FRAMEWORK CONFIDENTIALITY AGREEMENT (FCA)/ <b>ANNEXURE -B</b>
4.	GENERAL INSTRUCTIONS AND STANDARD TERMS & CONDITIONS (GISTC) REV.06 FOR INDIAN BIDDERS/ <b>ANNEXURE-C &amp; ANNEXURE-4</b> FOR TENDER TERM AND CONDITION
5.	ANNEXURE- D , QUALITY PLAN FORMAT
6.	<b>ANNEXURE – E</b> TECHNICAL SPECIFICATION AA22415 REV 02, DRAWINGS 31430901104 REV 00, 4139360117400 REV 02, 31420501027 VAR-03 REV 03 AND 3142050102700 REV 03 <b>(Technical specification and drawings shall be provided by BHEL, only after submitting FCA.)</b>

Note: All offers shall be submitted through BHEL NIC portal (<https://eprocurebhel.co.in>). No offers through offline mode shall be acceptable.

For any further details, you may feel free to contact the following persons:

<b>Mr. Bharat Bhushan</b> <b>Designation: Dy. Manager (PPX-EM)</b> 4 <sup>th</sup> Floor, Main Administrative Building HEEP, BHEL Hardwar- 249403 Uttarakhand, India Email ID: <a href="mailto:bharat-b@bhel.in">bharat-b@bhel.in</a> Tel: +91 9917628376	<b>Mr. Rajpal Singh</b> <b>Designation: Manager (PPX-EM)</b> 4 <sup>th</sup> Floor, Main Administrative Building HEEP, BHEL Hardwar- 249403 Uttarakhand, India Email ID: <a href="mailto:rajpal@bhel.in">rajpal@bhel.in</a> Tel: +91 9759022600
--	--

DUEDATE

25-06-2022

SL	MATERIAL CODE ITEM DESCRIPTION	QUANTITY	UNIT	LOTNO	LOT DELIVERY QTY SCHEDULE
1	W98414301711 DRG: 31430901104 REV: 00 ROUND SPEC: AA22415 REV: 02	4	NO	1	4 31/08/22
2	W90413900959 DRG: 4139360117400 REV: 02 INSULATING STRIP SPEC: AA22415 REV: 02	24	NO	1	24 31/08/22
3	W98414200427 DRG: 31420501027 VAR-03 REV: 03 INSULATION TUBE SPEC: AA22415 REV: 02	10	NO	1	10 31/08/22
4	W98414200257 DRG: 3142050102700 REV: 03 INSULATION TUBE SPEC: AA22415 REV: 02	4	NO	1	4 31/08/22

\*\* IMPORTANT: This enquiry is 2 part tender. Techno-Commercial bid (Part-1) & Price Bids (Part-2) should be submitted in separate envelopes. These two envelopes should be submitted in a common sealed envelope. Techno-Commercial Bid shall contain detailed Technical Specification, Drawings Technical documents, Catalogues, taxes & duties, payment terms, delivery period, Validity of offer, Replica of Price Bid (Copy of price bid without price part) etc. The confirmation to the special terms & conditions must be submitted alongwith Techno-Commercial bid.

Standard Instructions:

TEST CERTIFICATE REQUIRED.  
GUARANTEE CERTIFICATE REQUIRED.  
PRE-INSP AT YOUR WORKS PRIOR DESP.  
BASIC RATES, TAXES & DUTIES SEPERATELY

Special Instructions:

1. THIS IS OPEN TENDER INVITING PARTICIPATION FROM INDIAN BIDDERS.

\*\*\*\*\*

2. THE PRE-QUALIFICATION REQUIREMENTS (PQR) HAVE BEEN COMPILED AND PLACED AT ANNEXURE-A. BIDDERS SHOULD ENSURE SUBMISSION OF COMPLETE DETAILS AND

SL	MATERIAL CODE	QUANTITY	UNIT	LOTNO	LOT DELIVERY
					QTY SCHEDULE
ITEM DESCRIPTION					

DOCUMENTS AS CALLED FOR IN THESE REQUIREMENTS. THE OFFER SUBMITTED BY THE BIDDER WOULD BE SCRUTINISED WITH RESPECT TO PQR FIRST. TECHNO-COMMERCIAL OFFER OF ONLY THOSE BIDDERS SHALL BE EVALUATED, WHO MEET THE PQR.

\*\*\*\*\*

3. THE INTERESTED BIDDERS MAY GO THROUGH THE PQR AND OBTAIN COMPLETE TECHNICAL SPECIFICATIONS FROM BHEL AGAINST SUBMISSION OF FRAMEWORK CONFIDENTIALITY AGREEMENT (FCA). THE FCA (ANNEXURE-B) CAN BE SUBMITTED IN SOFT COPY THRU EMAIL) FOR OBTAINING TECHNICAL DOCUMENTS. HOWEVER, HARD COPY OF THE FCA IS TO BE SUBMITTED ALONGWITH THE OFFER. THE CONTACT DETAILS OF INDIVIDUALS FOR OBTAINING TECHNICAL SPECIFICATIONS/DRAWINGS ARE AS FOLLOWS:

i) BHARAT BHUSHAN (DY. MGR). TEL: +91 9917628376 EMAIL ID:bharat-b@bhel.in

ii) RAJPAL SINGH (MGR). TEL: +91 9759022600 EMAIL ID: rajpal@bhel.in

\*\*\*\*\*

4. THE OFFER SHALL BE SUBMITTED IN TWO PARTS I.E. PART-I (TECHNO-COMMERCIAL OFFER INCLUDING PQR DOCUMENTS) & PART-II (PRICE BID).

PART-II (PRICE BID) OF ONLY THOSE BIDDERS WILL BE OPENED, WHO MEET PQR AND ARE TECHNO-COMMERCIALY ACCEPTABLE. PRICE BIDS WOULD BE OPENED AT A LATER DATE AND INTIMATION FOR PRICE BID OPENING WOULD BE NOTIFIED SEPARATELY.

\*\*\*\*\*

5. ALL OFFERS ARE TO BE SUBMITTED ON NIC PORTAL. NO OFFLINE OFFER SHALL BE ACCEPTED.

\*\*\*\*\*

6. GENERAL INSTRUCTIONS AND STANDARD TERMS & CONDITIONS (GISTC) REV.06 ALONG WITH COMMERCIAL TERMS ARE ENCLOSED AT ANNEXURE-C. OFFER MUST

BE SUBMITTED INLINE WITH TERMS & INSTRUCTIONS MENTIONED IN GISTC. AN ENDOSED COPY GISTC IS TO BE SUBMITTED ALONGWITH THE OFFER, AS A TOKEN OF ACCEPTANCE.

\*\*\*\*\*

7. DEVIATIONS FROM ENQUIRY CONDITIONS/GISTC ARE GENERALLY NOT ACCEPTABLE. THE DEVIATIONS (IF ANY) ARE TO BE LISTED OUT CLEARLY IN THE OFFER. THE ACCEPTANCE OF THESE DEVIATIONS WOULD BE AT THE DISCRETION OF BHEL AND BHEL MAY REJECT THE OFFER OF BIDDER NOT MEETING THE ENQUIRY CONDITIONS.

\*\*\*\*\*

8. THE TENDER DOCUMENTS CAN BE DOWNLOADED FROM OUR WEBSITES <http://www.bhel.com>, <https://hwr.bhel.com> OR <https://eprocure.gov.in>. ANY CORRIGENDUM/AMENDMENT WOULD BE UPLOADED ON OUR WEBSITES ONLY. THE SOFT COPY OF ALL DOCUMENTS (EXCLUDING TECHNICAL SPECS) ARE AVAILABLE ONLINE AND NO TENDER FEE IS APPLICABLE.

\*\*\*\*\*

9. THE EVALUATION OF THE BIDS WOULD BE DONE ON THE BASIS OF TOTAL LANDED COST TO BHEL FOR TOTAL QTY . THE EVALUATION CURRENCY FOR THIS TENDER SHALL BE INR.

\*\*\*\*\*

10. PRE DISPATCH INSPECTION SHALL BE AS PER APPROVED QUALITY PLAN BY BHEL/NOMINATED INSPECTION AGENCY AT SUPPLIER'S WORK. BIDDER TO SUBMIT QP.

\*\*\*\*\*

11. BIDDERS ARE REQUESTED TO SUBMIT THE OFFER WITH BEST POSSIBLE DELIVERY

SL	MATERIAL CODE	QUANTITY	UNIT	LOTNO	LOT DELIVERY QTY SCHEDULE
ITEM DESCRIPTION					

COMPLETION PERIOD.

\*\*\*\*\*

12. THE PRICES ARE TO BE QUOTED ON FIRM BASIS. BHEL RESERVES THE RIGHT TO REJECT THE OFFER OF BIDDERS SUBMITTING THEIR OFFER ON PVC BASIS. BIDDER IS REQUESTED TO READ ANNEXTURE-4 CAREFULLY AND SUBMIT FILLED ENDORSED COPY OF ANNEXTURE-4

\*\*\*\*\*

13. E-INVOICING FOR INDIAN BIDDERS:

E-INVOICING UNDER GST HAS BEEN IMPLEMENTED W.E.F. 01/04/2021 FOR ALL THE TAXABLE PERSONS HAVING TURNOVER MORE THAN RS 50 CR. IT HAS BEEN PECIFIED BY THE GOVT. THAT IT IS MENDATORY TO MANTION A VALID UNIQUE INVOICE REFERENCE NO. (IRN) AND QR CODE AS GENERATED FROM GOVT. PORTAL ON A TAX INVOICE. BASED ON SUCH INFORMATION, GST ITC AS CLAMIED BY BHEL IN GST RETURNS SHALL BE MATCHED WITH CORRESPONDING DETAILS UPLOADED BY SUPPLIER IN E-INVOICING SYSTEM.

IN CASE THE VENDOR/CONTRACTOR DELAYS OR FALLS TO PROVIDE ALL DOCUMENTS AS PER THE PURCHASE ORDER/WORK ORDER AT THE TIME OF SUBMITTING TAX INVOICE TO BHEL, ANY SUBSEQUENT FINANCIAL LOSS TO BHEL ON ACCOUNT OF VENDOR / CONTRACTOR SHALL BE TO VENDOR'S / CONTRACTOR'S ACCOUNT. BHEL HAS FURTHER RIGHT TO TAKE NECESSARY STEPS TO PROTECTS ITS INTREST AT THE TIME OF RELEASE OF PAYMENT. THIS FURTHER REQUIRES INCLUSION OF IRN QR CODE ON TAX INVOICE AS ANNOUNCED BY GOVT. OF INDIA W.E.F. 01/04/2021

\*\*\*\*\*

14. GUIDELINES/INSTRUCTIONS ISSUED BY GOVERNEMNT OF INDIA FROM TIME TO TIME RELATING TO THE PROVISIONS OF THE TERMS & CONDITIONS MENTIONED IN THIS ENQUIRY SHALL BE COMPLIED FOR FINALISATION OF THIS TENDER.

\*\*\*\*\*

\*\*\*\*\*

15. FOR ANY QUERIES REGARDING THE TENDER, YOU MAY FEEL FREE TO CONTACT THE FOLLOWING OFFICIALS:-

A. CONTACT PERSON 1:

NAME: MR. BHARAT BHUSHAN

DESIGNATION: DY.MANAGER (PPX-EM)

ADDRESS: 4TH FLOOR,MAIN ADMINISTRATIVE BUILDING, HEEP, BHEL, INDIA, PIN 249403

EMAIL ID: bharat-b@bhel.in

MOB: +91 9917628376

B. CONTACT PERSON 2:

NAME: MR. RAJPAL SINGH

DESIGNATION: MANAGER (PPX-EM)

ADDRESS: 4TH FLOOR,MAIN ADMINISTRATIVE BUILDING, HEEP, BHEL, INDIA, PIN 249403

EMAIL ID: rajpal@bhel.in

MOB: +91 9759022600

\*\*\*\*\*

SL	MATERIAL CODE ITEM DESCRIPTION	QUANTITY	UNIT	LOTNO	LOT DELIVERY QTY SCHEDULE
----	-----------------------------------	----------	------	-------	------------------------------

---

**BHARAT BHUSHAN**

**Dy. Manager**

Annexure - A  
Pre-Qualification Requirement (PQR)

## PRE-QUALIFICATION REQUIREMENTS (TECHNICAL) FOR INSULATING STRIP (AA22415)

**INTRODUCTION:** Insulating Strips (as per NEMA L1-1 Grade G11 or equivalent) are made from layers of fine & plain woven glass fabric (Non-Alkali Glass Type E) having suitable silane/volan finish with good electrical properties using thermosetting epoxy resin as bonding medium. The material has temperature index of Min.155°C. These sheet strips are used as an insulation in Turbo-Generator. Thickness tolerance of the sheet is  $1\pm 0.05$  mm and size is approx. 1500 x 250 mm.

1. **EXPERIENCE:** The vendor should have experience of successful manufacturing and supplying the above material of any thickness having thickness tolerance  $\leq 0.05$ mm to OEM of Turbo/Hydro-Generator/Rotating Electrical machines during last seven years from date of enquiry. In support of which, vendor to submit the following documents: -
  - 1.1. Unpriced Copies of two successfully executed purchase orders for above material, supplied to OEM of Turbo/Hydro-Generator/Rotating Electrical machines.
  - 1.2. Copy of Test Certificates (for dimensional, mechanical and electrical test, etc.) for the above item corresponding to the purchase orders submitted as per clause 1.1.
  - 1.3. Vendor to submit documentary evidence of acceptance of material, pertaining to purchase order submitted above as per clause 1.1.
2. **MANUFACTURING FACILITIES:** Vendor to confirm that they have all in-house manufacturing facilities for above Insulating Strip. Vendor to provide details of manufacturing facility required for manufacturing above Insulating Strip.
3. **TESTING FACILITIES:** Vendor to confirm that they have in-house test facilities (duly calibrated), sufficient to carry out all the test as per enquired specification AA22415 rev 02. Vendor to provide the details of testing facilities. In case vendor conducts test at an external testing agency, vendor to furnish the details of the same, e.g. NABL accredited/Government approved Lab.
4. The vendor shall source the raw material from reputed suppliers and shall furnish TC/details of the same to BHEL, along with the offer.
5. Vendor to confirm the detailed technical requirement of the enquired Specification AA22415 rev 02.
6. Vendor who is supplying this item to BHEL for the first time has to submit one complete set of samples as per Table – 1 for testing the material as per Clause 8,9 & 10 of BHEL specification AA22415 rev 02. Vendor will be qualified on the basis of successfully passing the test of submitted samples as per specification AA22415 rev 02 in addition to qualifying other requirement of PQR.

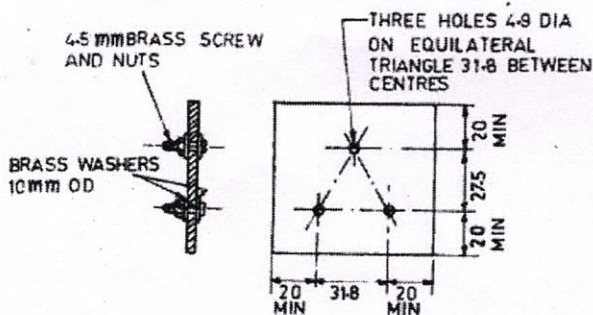

Fig. 12 Specimen And Electrodes

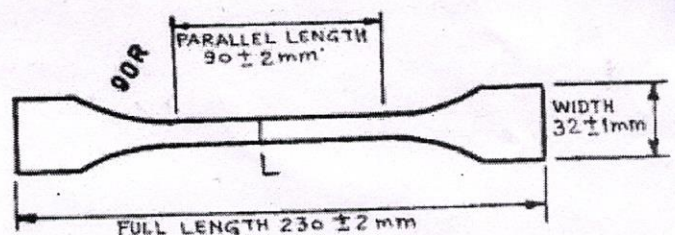

Fig. 1 Specimen for Tensile Strength Test.

*[Signature]*  
21/10/21

*[Signature]*  
22/10/21

*[Signature]*  
22/10/21

S.No	Test Parameter	Dimension (in mm)	Minimum No of samples
1	Specific Gravity	L/W/Tk = 20/20/10	2
2	MHDT	L/W/Tk = 120/15/10 (If sheet thickness is >10mm :Machine down to 10mm uniformly on both sides)	3
3	Water Absorption	L/W/Tk = 38/38/10 (If sheet thickness is >25mm:Machine down to 25mm leaving one surface intact)	2
4	Cross Breaking Strength at R.T	L/W/Tk = 250/ 15±0.5/ 10 (If sheet thickness is >10mm : Machine down to 10mm leaving one surface intact)	5
5	Cross Breaking Strength at 150°C)	L/W/Tk = 250/ 15±0.5/ 10 (If sheet thickness is >10mm : Machine down to 10mm leaving one surface intact)	5
6	Compression Strength	L/W/Tk = 15/15/25 (Layers can be buildup to achieve 25mm thickness of sample e.g. 15/15/10 & 15/15/5 samples piled up to make 15/15/25)	5
7	Impact Strength-Charpy Flatwise	L/W/Tk = 120/15/10 (If sheet thickness is >10mm : Machine down to 10mm leaving one surface intact)	5
8	Electrical strength (Parallel to layers)	L/W/Tk = 100/25/10 (No surface machining allowed)	2
9	Heat shock test	L/W/Tk = 100 x 100 x 10 (No surface machining allowed)	2
10	Splitting load (Edgewise)	L/W/Tk = 20±0.2 /20±0.2/ 10±0.1 (Machine down to 10mm uniformly on both sides)	5
11	Insulation Resistance	L/W/Tk = Fig.12 / Fig.12 /10	2
12	Electrical strength (Perpendicular to layers)	L/W/Tk = 150/150/1±0.05mm (No surface machining allowed)	2
13	Tan Delta	L/W/Tk = 150/150/1±0.05mm (No surface machining allowed)	2
14	CTI	L/W/Tk = 20/20/10 (If sheet thickness is >10mm : Machine down to 10mm leaving one surface intact)	2
15	Tensile Strength	Thickness: 10 mm. Other dimensions as per figure-1	5

L: Length (in mm), W: Width (in mm), Tk: Thickness (in mm)

Sample machining must be done in a manner such that Length & Width side are parallel to Glass Fabric layers and Thickness is perpendicular to Glass Fabric layers.

#### NOTE

- BHEL reserves the right to verify the information submitted by the vendor. In case the information is found to be false or incorrect, the offer shall be rejected.
- All the documents should be furnished in English language only. If the document provided by vendor is in any language other than English, it must be supported with its certified English translation.

  
Nitin Raj 21/10/21  
Manager / ISE & CPL

  
Deepak Kumar  
Dy.Manager/ EME

  
Rajesh Ranjan  
AGM / ISE, CPL &GRI

## PRE-QUALIFICATION REQUIREMENTS (TECHNICAL) FOR INSULATING TUBE (AA22415)

**INTRODUCTION:** Insulating Tubes are made by rolling process using fine & plain woven glass fabric (Non-Alkali Glass Type E) having suitable silane/volan finish with good electrical properties using thermosetting epoxy resin as bonding medium. The material has temperature index of Min.155°C. These tubes are used as insulating component in field coil of Turbo-Generator exciters. The raw material shall confirm to the technical requirements of NEMA L1-1 Grade G11 or equivalent, when several layers are laminated to sheets.

1. **EXPERIENCE:** The vendor should have experience of successful manufacturing and supplying the Insulating Tubes/sleeves (manufactured by rolling process and the above mentioned raw materials) to OEM of Generator of capacity 200MW and above. In support of which, vendor to submit the following documents: -
  - 1.1. Unpriced Copies of two successfully executed purchase orders of the Insulating Tubes/sleeves (manufactured by rolling process and the above mentioned raw materials) to OEM of Generator of capacity 200MW and above.
  - 1.2. Copy of one Test Certificates (for dimensional, mechanical and electrical test, etc.) for the above item corresponding to the purchase orders submitted as per clause 1.1.
  - 1.3. Vendor to submit documentary evidence of acceptance of material, pertaining to purchase order submitted for which TC has been submitted.
2. **MANUFACTURING FACILITIES:** Vendor to confirm that they have all in-house manufacturing facilities for above Insulating Tubes. Vendor to provide details of manufacturing facility required for manufacturing above Insulating Tubes.
3. **TESTING FACILITIES:** Vendor to confirm that they have in-house test facilities, sufficient to carry out all the test as per enquired specification AA22415 rev 02. Vendor to provide the details of testing facilities. In case vendor conducts test at an external testing agency, vendor to furnish the details of the same, e.g. NABL accredited/Government approved Lab.
4. The vendor shall furnish TC/details of the raw material required for manufacturing the enquired item.
5. Vendor to confirm the detailed technical requirement of the enquired Specification AA22415 rev 02.
6. Vendor who is supplying this material to BHEL for the first time has to submit one complete set of samples as per Table – 1 for testing the material as per Clause 8,9 & 10 of BHEL specification AA22415 rev 02. Vendor will be qualified on the basis of successfully passing the test of submitted samples as per specification AA22415 rev 02 in addition to qualifying other requirement of PQR.

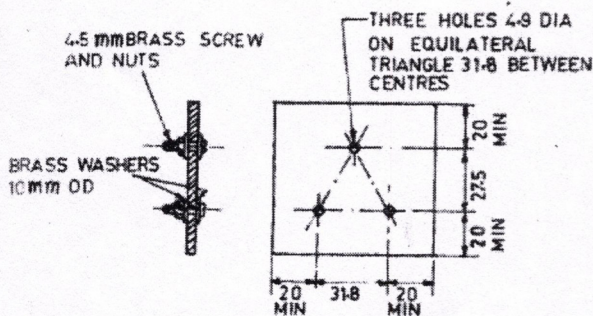

Fig. 12 Specimen And Electrodes

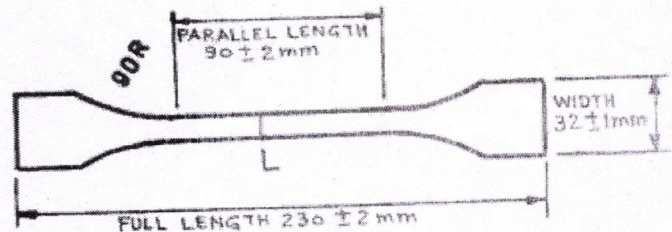

Fig. 1 Specimen for Tensile Strength Test.

*[Signature]*  
08/10/22

*[Signature]*

*[Signature]*  
15/11/2022

TABLE - 1

S.No	Test Parameter	Dimension (in mm)	Minimum No of samples
1	Specific Gravity	L/W/Tk = 20/20/10	2
2	MHDT	L/W/Tk = 120/15/10 (If sheet thickness is >10mm :Machine down to 10mm uniformly on both sides)	3
3	Water Absorption	L/W/Tk = 38/38/10 (If sheet thickness is >25mm:Machine down to 25mm leaving one surface intact)	2
4	Cross Breaking Strength at R.T	L/W/Tk = 250/ 15±0.5/ 10 (If sheet thickness is >10mm : Machine down to 10mm leaving one surface intact)	5
5	Cross Breaking Strength at 150°C)	L/W/Tk = 250/ 15±0.5/ 10 (If sheet thickness is >10mm : Machine down to 10mm leaving one surface intact)	5
6	Compression Strength	L/W/Tk = 15/15/25 (Layers can be buildup to achieve 25mm thickness of sample e.g. 15/15/10 & 15/15/5 samples piled up to make 15/15/25)	5
7	Impact Strength-Charpy Flatwise	L/W/Tk = 120/15/10 (If sheet thickness is >10mm : Machine down to 10mm leaving one surface intact)	5
8	Electrical strength (Parallel to layers)	L/W/Tk = 100/25/10 (No surface machining allowed)	2
9	Heat shock test	L/W/Tk = 100 x 100 x 10 (No surface machining allowed)	2
10	Splitting load (Edgewise)	L/W/Tk = 20±0.2 /20±0.2/ 10±0.1 (Machine down to 10mm uniformly on both sides)	5
11	Insulation Resistance	L/W/Tk = Fig.12 / Fig.12 /10	2
12	Electrical strength (Perpendicular to layers)	L/W/Tk = 150/150/1±0.05mm (No surface machining allowed)	2
13	Tan Delta	L/W/Tk = 150/150/1±0.05mm (No surface machining allowed)	2
14	CTI	L/W/Tk = 20/20/10 (If sheet thickness is >10mm : Machine down to 10mm leaving one surface intact)	2
15	Tensile Strength	Thickness: 10 mm. Other dimensions as per figure-1	5

L: Length (in mm), W: Width (in mm), Tk: Thickness (in mm)

Sample machining must be done in a manner such that Length & Width side are parallel to Glass Fabric layers and Thickness is perpendicular to Glass Fabric layers.

#### NOTE

- BHEL reserves the right to verify the information submitted by the vendor. In case the information is found to be false or incorrect, the offer shall be rejected.
- All the documents should be furnished in English language only. If the document provided by vendor is in any language other than English, it must be supported with its certified English translation.

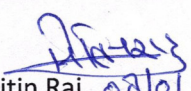
  
Nitin Raj 08/01/22  
Manager / ISE & CPL

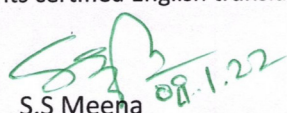
  
S.S Meena 08.1.22  
DGM/ EME

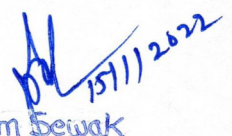
  
Ram Sewak 15/1/2022  
AGM / ISE, CPL & GRI

## PRE-QUALIFICATION REQUIREMENTS (TECHNICAL) FOR INSULATING ROUND (AA22415)

**INTRODUCTION:** Insulating Round are machined components, manufactured from Sheets (as per NEMA L1-1 Grade G11 or equivalent) made from layers of fine & plain woven glass fabric (Non-Alkali Glass Type E) having suitable silane/volan finish with good electrical properties using thermosetting epoxy resin as bonding medium. The material has temperature index of Min.155°C. The material has temperature index of Min.155°C. It is used in exciter lead assembly to provide insulation for earth fault monitoring slip rings.

1. **EXPERIENCE:** The vendor should have experience of successful manufacturing and supplying the machined component, machined out of the sheet material mentioned above to OEM of Generator of capacity 200MW and above. In support of which, vendor to submit the following documents: -
  - 1.1. Unpriced Copies of two successfully executed purchase orders of the machined component (machined out of the sheet material mentioned above) to OEM of Generator of capacity 200MW and above.
  - 1.2. Copy of Test Certificates (for dimensional, mechanical and electrical test, etc.) for the above item corresponding to the purchase orders submitted as per clause 1.1.
  - 1.3. Vendor to submit documentary evidence of acceptance of material, pertaining to purchase order submitted above as per clause 1.1.
2. **MANUFACTURING FACILITIES:** Vendor to confirm that they have all in-house manufacturing facilities for above Insulating Round. Vendor to provide details of manufacturing facility required for manufacturing above Insulating Round.
3. **TESTING FACILITIES:** Vendor to confirm that they have in-house test facilities, sufficient to carry out all the test as per enquired specification AA22415 rev 02. Vendor to provide the details of testing facilities. In case vendor conducts test at an external testing agency, vendor to furnish the details of the same, e.g. NABL accredited/Government approved Lab.
4. The vendor shall furnish TC/details of the raw material required for manufacturing the enquired item.
5. Vendor to confirm the detailed technical requirement of the enquired Specification AA22415 rev 02.
6. Vendor who is supplying this material to BHEL for the first time has to submit one complete set of samples as per Table – 1 for testing the material as per Clause 8,9 & 10 of BHEL specification AA22415 rev 02. Vendor will be qualified on the basis of successfully passing the test of submitted samples as per specification AA22415 rev 02 in addition to qualifying other requirement of PQR.

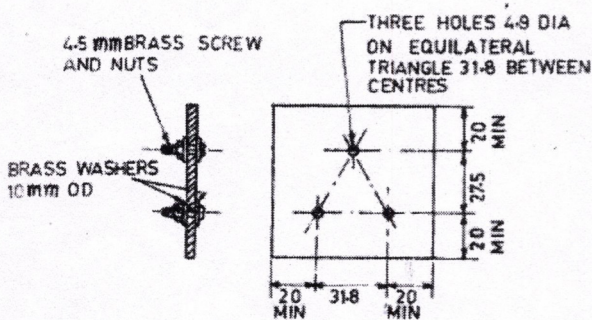

Fig. 12 Specimen And Electrodes

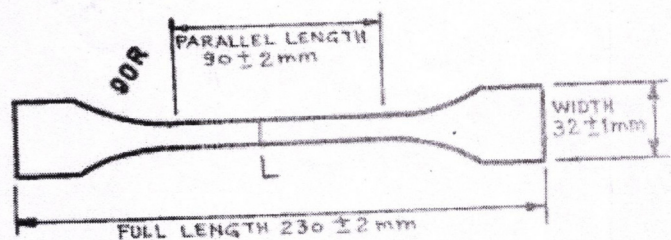

Fig. 1 Specimen for Tensile Strength Test.

*(Signature)*  
6/1/22  
(NITIN RAS)  
Mgr / ISE&CPL

*(Signature)*

*(Signature)*  
07/01/22

TABLE - 1

S.No	Test Parameter	Dimension (in mm)	Minimum No of samples
1	Specific Gravity	L/W/Tk = 20/20/10	2
2	MHDT	L/W/Tk = 120/15/10 (If sheet thickness is >10mm :Machine down to 10mm uniformly on both sides)	3
3	Water Absorption	L/W/Tk = 38/38/10 (If sheet thickness is >25mm:Machine down to 25mm leaving one surface intact)	2
4	Cross Breaking Strength at R.T	L/W/Tk = 250/ 15±0.5/ 10 (If sheet thickness is >10mm : Machine down to 10mm leaving one surface intact)	5
5	Cross Breaking Strength at 150°C)	L/W/Tk = 250/ 15±0.5/ 10 (If sheet thickness is >10mm : Machine down to 10mm leaving one surface intact)	5
6	Compression Strength	L/W/Tk = 15/15/25 (Layers can be buildup to achieve 25mm thickness of sample e.g. 15/15/10 & 15/15/5 samples piled up to make 15/15/25)	5
7	Impact Strength-Charpy Flatwise	L/W/Tk = 120/15/10 (If sheet thickness is >10mm : Machine down to 10mm leaving one surface intact)	5
8	Electrical strength (Parallel to layers)	L/W/Tk = 100/25/10 (No surface machining allowed)	2
9	Heat shock test	L/W/Tk = 100 x 100 x 10 (No surface machining allowed)	2
10	Splitting load (Edgewise)	L/W/Tk = 20±0.2 /20±0.2/ 10±0.1 (Machine down to 10mm uniformly on both sides)	5
11	Insulation Resistance	L/W/Tk = Fig.12 / Fig.12 /10	2
12	Electrical strength (Perpendicular to layers)	L/W/Tk = 150/150/1±0.05mm (No surface machining allowed)	2
13	Tan Delta	L/W/Tk = 150/150/1±0.05mm (No surface machining allowed)	2
14	CTI	L/W/Tk = 20/20/10 (If sheet thickness is >10mm : Machine down to 10mm leaving one surface intact)	2
15	Tensile Strength	Thickness: 10 mm. Other dimensions as per figure-1	5

L: Length (in mm), W: Width (in mm), Tk: Thickness (in mm)

Sample machining must be done in a manner such that Length & Width side are parallel to Glass Fabric layers and Thickness is perpendicular to Glass Fabric layers.

#### NOTE

- BHEL reserves the right to verify the information submitted by the vendor. In case the information is found to be false or incorrect, the offer shall be rejected.
- All the documents should be furnished in English language only. If the document provided by vendor is in any language other than English, it must be supported with its certified English translation.

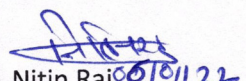
  
Nitin Raj  
Manager / ISE & CPL

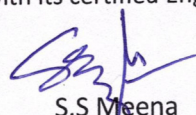
  
S.S Meena  
DGM/ EME

  
Rajesh Panjan  
AGM / ISE, CPL & GRI

Annexure - B

**FRAMEWORK CONFIDENTIALITY  
AGREEMENT (FCA)**

# **FRAMEWORK CONFIDENTIALITY AGREEMENT CUM UNDERTAKING** **(FCA)**

This Agreement made on this the day \_\_\_\_\_ of (month) 20 \_\_\_\_\_ ("Effective Date") by and between M/s BHARAT HEAVY ELECTRICALS LIMITED, having registered office at "BHEL House", Siri Fort, New Delhi — 110049 (India), acting through its Unit \_\_\_\_\_ (hereinafter may be referred to as "BHEL" or "the Company").

And  
M/s \_\_\_\_\_ (address) \_\_\_\_\_  
represented by authorized representative \_\_\_\_\_ Sri (herein after referred to as the "Supplier").

The Supplier and the Company may, unless the context otherwise requires, hereinafter be collectively referred to as "Parties" or singly as the "Party".

## RECITALS

Whereas, BHEL is engaged in the design, engineering, manufacturing, construction, testing, commissioning and servicing of a wide range of products, systems and services for the core sectors of the economy, viz. Power, Transmission, Industry, Transportation, Renewable energy, Oil & Gas and Defense and providing associated services to varied customers in relation to which BHEL/its affiliates own valuable information of a secret and confidential nature.

Whereas the Company may, in connection with Contract(s) (as defined hereunder) placed or to be placed upon the Supplier, or otherwise, from time to time, make available, Technical Information as is defined hereunder.

And Whereas BHEL is willing to provide such Technical Information to the Supplier from time to time and the Supplier understands and acknowledges that such Technical Information is valuable for the Company and as such is willing to protect confidentiality of such information, subject to the terms and conditions set out hereunder.

Now therefore, in view of the foregoing premises and in consideration of the mutual covenants and agreements hereinafter set forth, the Parties agree as under:

### 1. Definitions:

Unless the context so requires, in this Agreement, the following terms will bear the meaning ascribed to the said term in this clause.

- a) "Contract" means the Contract entered into with a Supplier and includes a Purchase Order, or a Work Order for procurement of any goods or for provision of any services.
- b) "Effective Date" means the date of this Agreement as mentioned in the preamble of this Agreement.
- c) "Supplier" includes a Contractor or a Vendor of the Company whether for supplying of goods or for providing any services under a Contract or both.
- d) "Technical Information" includes Drawings, and/or Product Standards and/or Specifications and/or Corporate / Plant Specifications and/or Technological Process Sheets and/or Technical Data Sheets and/or Jigs & Fixtures and/or Pattern & Dies and/or Special Gauges and/or Tools etc. belonging to or wherein the Company has acquired from a third party a right of user and includes any improvement thereto from time to time whether carried out by the Company or by the Supplier.
- e) "Intended Purpose" means the purpose for which the Technical Information is provided to the Supplier under or in connection with a Contract.
- f) "Improvement" includes any modification made to, or adaptation of, the Technical Information which enhances or is calculated to enhance the performance (whether in terms of effectiveness or in terms of efficiency or both) of the product and/or the service to be provided by the Supplier under a Contract.

2. This Agreement shall come into force/deemed to have come into force, as the case may be, on the Effective Date; or, on the first date when the Technical Information or any part thereof is provided by BHEL to the Supplier; whichever is earlier.

3. Agreement deemed to be incorporated in each Contract: Unless and to the extent otherwise stipulated in the Contract, the conditions of this Agreement are deemed to be incorporated in all Contracts which may be entered into between the Company and the Supplier. Further, unless otherwise stipulated, the obligations under this Agreement are and will be independent of the obligations under the Contracts and such obligations of the Supplier hereunder will remain of full effect and validity notwithstanding that the period of validity of the Contracts has expired by efflux of time stipulated therein; or, the contract has been discharged by performance or breach; or, the termination of the Contracts for any reason whatsoever.

4. Ownership:

4.1 The Company may, from time to time, make available to the Supplier, Technical Information on a non-exclusive basis by way of loan.

4.2 The Supplier acknowledges and agrees that all Technical Information and copies thereof that are or may be provided by the Company to the Supplier, are and shall remain the property of BHEL or that of the concerned entity from whom BHEL has obtained the Technical Information and such Technical Information are and shall constitute trade secrets of the BHEL. Nothing in this Agreement or in any disclosures made hereunder by or on behalf of the Company shall be construed as granting upon the Supplier any patent, copyright or design or any other intellectual property rights of whatsoever description that subsists or may hereinafter exist in the Technical Information. Furthermore, nothing in this Agreement or in any disclosures made hereunder by or on behalf of the Company shall be construed as granting upon the Supplier any license or rights of use of such patent, copyright or design or any other intellectual property rights of whatsoever description which may now or hereafter exist in the Technical Information except for use of the Technical Information strictly in accordance with this Agreement and the Contract and/or as directed in writing by the Company, solely for the Intended Purpose under the Contract.

4.3 Neither Party is obligated by or under this Agreement to purchase from or provide to the other Party any service or product and that any such purchase/sale of any product and/or service by one Party to the other Party will be governed by the Contract if any, that may be entered into by and between the Company and the Supplier.

4.4 The Supplier is/has been made well aware and acknowledges that the Technical Information being/which may be shared with it by the Company has been either generated by the Company by incurring huge investment and cost or obtained from foreign collaborators under Technical Collaboration Agreement (TCA) with stringent confidentiality conditions.

4.5 The Supplier agrees and undertakes to adhere to confidentiality requirements as applicable to BHEL under a TCA and also ensure that the confidentiality requirements are adhered to by all its concerned employees or sub-contractors/suppliers (where permitted to be engaged by BHEL). Any damages, losses, expenses of any description whatsoever, arising out of or in connection with a breach of the confidentiality requirements under a TCA owing to any act or omission on the part of the Supplier or its employees or sub-contractors/suppliers that is claimed by a foreign collaborator from the Company shall be wholly borne by the Supplier and it shall keep BHEL fully indemnified in this behalf. The demand by the Company shall be conclusive upon the Supplier who shall thereupon forthwith pay to the Company without demur, dispute or delay the amount as demanded without demanding any further proof thereof.

4.6 The Supplier agrees and undertakes that unless so decided and advised by the Company in writing all rights/title to any Improvement to the Technical Information shall vest in the Company. The Supplier undertakes and agrees to inform forthwith to the Company of any such Improvement made to the Technical Information and transfer all drawings/documents or other materials connected with such

Improvement to the Company and also agrees to fully cooperate with the Company for protecting the Company's interests in such Improvement in the Technical Information including but not limited to obtaining necessary protection for the intellectual property rights in such improvement, if so desired by the Company. If a question answers whether a modification amounts to Improvement to the Technical Information, the same shall be decided by the Company and such decision shall be final and binding upon the Supplier.

## 5. Use and Non-Disclosure:

5.1 Unless otherwise stipulated by the Company, all Technical Information made available to the Supplier, by the Company shall be treated as Confidential irrespective of whether the same is marked or otherwise denoted to be Confidential or not.

5.2 The Supplier undertakes and agrees that the Technical Information in its possession shall be held in strict confidence and will be used strictly in accordance with this Agreement and solely for the Intended Purpose under the Contract. Use of the Technical Information for any other purpose other than Intended Purpose is prohibited.

5.3 In particular, the Supplier shall not use Technical Information or any Improvement in its possession for the manufacture or procurement of the Product(s) or components or parts thereof or use the Technical Information or any portion thereof or any modification or adaptation thereof in any form to provide any product and/or service to any third party, without the prior written consent of the Company.

5.4 The Supplier shall not disclose any of such Technical Information to any third party without the prior written consent of the Company. The Supplier agrees that without prior written consent of the Company, the Supplier shall not disclose to a third party about the existence of this Agreement, or of the fact that it is/was in possession of or has experience in the use of any Technical Information nor shall the Supplier share in any manner whatsoever, with a third party, the name or details of any Contract(s) awarded by the Company to it or performed by the Supplier or the scope of work thereof or share any document or correspondence by and between the Company and the Supplier in or in connection with this Agreement or such Contract(s). Notwithstanding what is stated elsewhere, the overall responsibility of any breach of the confidentiality provisions under this Agreement shall rest with the Supplier.

5.5 The Supplier undertakes and agrees not to make copies or extracts of and not to disclose to others any or all of the Technical Information in its possession, except as follows:

- a) The Supplier may disclose the Technical Information to such of its officers and employees strictly to the extent as is necessary for such officer or employee for the Intended Purpose, provided that the Confidential Information (or copies thereof) disclosed shall be marked clearly as the confidential and proprietary information of Company and that such officers and employees shall similarly be bound by undertakings of confidence, restricted use and non-disclosure in respect of the Technical Information. The Supplier shall be responsible for any breach of such confidentiality provisions by such officers and employees.
- b) With the prior written consent of Company, the Supplier may disclose for the Intended Purpose such Technical Information as is provided for in such consent to such of its professional advisers: consultants, insurers and subcontractors who shall be similarly bound by undertakings of confidence, restricted use and nondisclosure in respect of such Technical Information.
- c) The Supplier shall not be prevented to make any disclosure required by (i) order of a court of competent jurisdiction or (ii) any competent regulatory authority or agency where such disclosure is required by law, provided that where the Supplier intends to make such disclosure, it shall first consult Company and take all reasonable steps requested by it to minimize the extent of the Technical Information disclosed and to make such disclosure in confidence and also shall cooperate with the Company in seeking any protective order or any other remedy from proper authority in this matter.

## 6. Exceptions:

The obligations of the Supplier pursuant to the provisions of this agreement shall not apply to any Confidential Information that:

- a) was/is known to, or in the possession of the Supplier prior to disclosure thereof by the Company;
- b) is or becomes publicly known, otherwise than as a result of a breach of this agreement by the Supplier.
- c) is developed independently of the Disclosing Party by the Supplier in circumstances that do not amount to a breach of the provisions of this Agreement or the Contract;
- d) is received from a third party in circumstances that do not result in a breach of the provisions of this Agreement.

7. The obligation of maintaining confidentiality of the Technical Information on each occasion, shall subsist for the entire duration during which the Technical Information / equipment is in possession of the Supplier and shall thereafter subsist for a further period of ----years from the date when the complete Technical Information has been returned to the Company and if Technical Information has been returned in portions on different dates then, the period of ---- years will be reckoned from the date when the last portion of the Technical Information has been returned. Notwithstanding the expiry of the confidentiality obligation, the obligation of the Supplier under clause 5.4 shall continue to subsist for a further period of ----years.

#### 8. Warranties & Undertakings:

- a) The Supplier undertakes to ensure the due observance of the undertakings of confidence, restricted use and non-disclosure by its persons to whom it discloses or releases copies or extracts of the Technical Information.
- b) The Supplier shall keep the Technical Information or improvement made therein properly segregated and not mix up the same with any other material/documents belonging to him/it or to any other third party.
- c) The Supplier further undertakes that he/it shall not hypothecate or give on lease or otherwise alienate or do away with any of the Technical Information and/or equipment of the Company, made available to him/it, and undertakes that he/it shall hold the same as a trustee, in capacity of custodian thereof and use/utilize the same solely for the purpose of executing the Contract awarded by the Company.
- d) The Supplier further undertakes that he/it shall return all the equipment and/or Technical Information as far as practicable in the same condition in which the same was made available to him/it by the Company together with any Improvement thereon and the documents connected with such Improvement, to the Company forthwith upon completion of the scope 2 of work or Contract for which such Technical Information was provided by the Company to it or as directed by the Company together with a confirmation by way of an affidavit or in such manner as directed by the Company that it has not retained any equipment and/or Technical Information/improvement thereof. In case any such equipment and/or Technical Information or Improvement thereof shall remain in his possession or is not capable of being returned, the retention and use of such Technical Information or Improvement thereto shall continue to be governed by this Agreement.
- e) The Supplier undertakes to indemnify the Company for all the direct, indirect and/or consequential losses, damages, expenses whatsoever including any consequential loss of business, profits suffered by the Company owing to breach by the Supplier of its obligations under this Agreement and/or the confidentiality requirements, if any, contained in the Contract and that the Supplier hereby agrees that the decision of the Company in all such or any such matter/s shall be final and binding on the Supplier. On mere written demand of the Company, the Supplier shall forthwith and without demur or delay pay to the Company any such sum as determined by the Company as the amount of loss or damage or expense which has been suffered by the Company. The Supplier agrees that the Company shall be entitled to withhold and appropriate any amount payable to the Supplier under any Contract then existing between the Company and the Supplier, in case the Supplier fails to make payment, in terms of the written demand, within 7 days thereof. Without prejudice to the foregoing actions, in respect to any breach of this Agreement, the Company shall be entitled to take any other action against the Supplier as per applicable laws, the Contract, Company's applicable policies, guidelines rules, procedures, etc.

9. Without prejudice to any other mode of recovery as may be available to the Company for recovery of the amount determined as due as per Clause 8(e) hereinabove, the Company shall have a right to withhold, recover and appropriate the amount due towards such losses, damages, expenses, from any amount due to

the Supplier in respect of any other Contract (s) placed on lum/it by any department/office/Unit/Diusion of the said Company.

10. Arbitration & Conciliation:

- a) In case amicable settlement is not reached between the Parties, in respect of any dispute or difference or claim or controversy arising out of the formation, breach, termination, validity or execution of the Contract(or Agreement) or the respective rights and liabilities of the parties or in relation to interpretation of any provision of the Contract or in any manner touching upon the Contract, then, either Party may, by a notice in writing to the other Party refer such dispute or difference or controversy or claim, (except as to any matters, the decision of which is specifically provided for therein) to the sole arbitration by the arbitrator appointed by Head/In-Charge of the Unit/Division/Region.
- b) The Arbitrator shall pass a reasoned award and the award of the Arbitrator shall be final and binding upon the parties to the dispute.
- c) Subject as aforesaid, the provisions of Arbitration and Conciliation Act 1996 (India), or other statutory modifications or re-enactments thereof and the rules made thereunder and for the time being in force shall apply to the arbitration proceedings under this clause. The seat of arbitration shall be at -- (Insert the name of the city/town of the concerned BHEL Unit/Division).
- d) In case of Contract with Public Sector Enterprise (PSE) or a Government Department, the following shall be applicable:
- e) In the event of any dispute or difference relating to the interpretation and application of the provisions of the Contract, such dispute or difference shall be referred to by either party to the arbitration of one of the arbitrators in the department of public enterprises to be nominated by the Secretary to the Government of India in-charge of the Department of Public Enterprises. The Arbitration and Conciliation Act, 1996 shall not be applicable to arbitration under this clause. The award of the arbitrator shall be binding upon the parties to the dispute, provided, however, any party aggrieved by such award may make further reference for setting aside or revision of the award to the Law Secretary, Department of Legal Affairs, Ministry of Law and Justice, Government of India. Upon such reference the dispute shall be decided by the Law Secretary or the Special Secretary or Additional Secretary when so authorized by the Law Secretary, whose decision shall bind the parties hereto finally and conclusively.
- f) Notwithstanding the existence or any dispute or differences and/or reference for the arbitration, the Supplier shall proceed with and continue without hindrance the performance of its obligations under this Contract with due diligence and expedition in a professional manner.

II. Governing Law & Jurisdiction:

This Agreement shall be governed by and be construed as per applicable Indian Laws in force at the relevant time. Subject to clauses and hereinabove, all matters in connection with the subject agreement shall be subject to exclusive jurisdiction of Courts situated at — --(insert the name of the place where the BHEL Unit/Division is located)

SIGNATURE:

WITNESSES

1.  
Name  
Address:

2.  
Name:  
Address:

**Annexure – C-1**

**General Instructions and Standard Terms  
and Conditions (GISTC)**

**(For Indian Bidders)**



## BHARAT HEAVY ELECTRICALS LIMITED

HEEP-HARIDWAR, UTTARAKHAND (249403)

General Instructions and Standard Terms & Conditions for bidding against Tender Enquiry (GISTC)

For Indian Bidders (Version June-2021, Rev: 06)

### Table of Contents

1. GENERAL .....	1
2. ORIGIN OF QUOTATION .....	1
3. SUBMISSION OF TENDER .....	1
4. TENDER OPENING .....	2
5. SPECIFICATION, DRAWINGS & STANDARD .....	2
6. PRICE SCHEDULE .....	3
7. REVERSE AUCTION .....	3
8. DELIVERY TERMS .....	3
9. LD FOR LATE DELIVERY .....	4
10. PAYMENT TERMS .....	4
11. TAXES & DUTIES .....	5
12. BANK GUARANTEE .....	6
13. GUARANTEE / WARRANTY AND CORRESPONDING REPAIRS / REPLACEMENT OF GOODS .....	6
14. QUALITY REQUIREMENT .....	6
15. VALIDITY .....	6
16. RIGHT OF ACCEPTANCE .....	6
17. TRANSIT INSURANCE .....	7
18. RISK PURCHASE .....	7
19. FORCE MAJEURE CLAUSE .....	7
20. NON-DISCLOSURE AGREEMENT .....	8
21. SETTLEMENT OF DISPUTES / ARBITRATION .....	8
22. WHARFAGE / DEMURRAGE RESPONSIBILITY .....	8
23. CONDITIONS FOR AVAILING MICRO & SMALL ENTERPRISES (MSE'S) BENEFITS .....	8
24. INFORMATION TO THE BIDDERS .....	10
25. MAKE IN INDIA (GOVT-NOTIFICATION) .....	10
26. RESTRICTIONS UNDER RULE 144(XI) OF THE GENERAL FINANCIAL RULES (GFRs), 2017 .....	12

27. NOTE..... 12

### 1. GENERAL.

These general terms & conditions shall apply to all the Tender Enquiries, notice inviting tenders, request for quotations concerning the supply of goods and / or rendering of services to Bharat Heavy Electricals Ltd., HEEP, Haridwar (hereinafter referred to as BHEL or the Purchaser). In case of placement of order these conditions will become part of Purchase Order (P.O) until unless the deviations are specifically agreed by BHEL.

### 2. ORIGIN OF QUOTATION.

- a) The quotation should preferably be from the principal bidder. However tender specific authorized registered dealer/agent can also submit the bid on their behalf, failing which the quotation is liable to be ignored. BHEL prefers to deal directly with the principal manufacturers.
- b) An agent cannot quote on behalf of more than one principal in the same Tender Enquiry.

### 3. SUBMISSION OF TENDER.

- a) Bid / Quotation must be enclosed in sealed cover on which tender enquiry number and the due date MUST BE written and be invariably sent under REGISTERED POST / SPEED POST / COURIER / Dropped in the Tender Box: addressed as follows:

Quotation against Enquiry No. \_\_\_\_\_

Dated: \_\_\_\_\_

Due on: \_\_\_\_\_

To,

**THE HEAD OF MATERIALS MANAGEMENT,  
Heavy Electrical Equipment Plant,  
Bharat Heavy Electricals Limited,  
HARIDWAR-249403 (Uttarakhand), INDIA.**

- b) TENDER ROOM is located at: Room No. - 415, 4<sup>th</sup> Floor, Main Admin. Building, BHEL-HEEP, Haridwar.

## Quotations / Bids not in accordance with General Instructions and Standard Terms & Conditions are likely to be ignored.



## BHARAT HEAVY ELECTRICALS LIMITED

HEEP-HARIDWAR, UTTARAKHAND (249403)

General Instructions and Standard Terms & Conditions for bidding against Tender Enquiry (GISTC)

For Indian Bidders (Version June-2021, Rev: 06)

- c) In case of Three / Two Part Bid, technical bid containing technical offer, duly signed and un-priced copy of the Price Bid should be kept in one envelope. Price Bid containing only the price should be kept in a separate envelope. All envelopes indicating Part-1 or Part-2 or Part-3 as the case may be to be put in a bigger envelope. Please note that un-priced bid should be the exact replica of price bid but without prices.
- d) The bid / quotation must be posted before due date, keeping allowance for postal transit time. Quotations sent by any mode but not received in time will be ignored. Tender received through authorized E-mail is also acceptable. However, in time submission of tender in tender box shall be the responsibility of the bidder, sent through any mode. Documents submitted with the offer / bid shall be signed and stamped in each page by authorized representative of the bidder.
- e) Any additional documents submitted by supplier / bidder, during processing of registration application / tender or after placement of order shall not be accepted unless it is submitted with forwarding letter and duly signed and stamped.
- f) The bids of the bidders who are on the banned list and also the bids of the bidders, who engage the services of the banned firms, shall be rejected. The cutting / overwriting in the bid / offer must be duly attested by the signatories to the bid. The list of firms banned by BHEL is available on BHEL web site [www.bhel.com](http://www.bhel.com).
- g) Being PMD vendor, if you are not quoting against this tender enquiry, please send your regret letter positively for our reference with valid reasons for not participating in the tender enquiry. Repeated lack of response on the part of bidder may lead to deletion such PMD vendor from BHEL's approved vendor list.
- h) The bidders will submit Integrity Pact, duly signed by its authorized signatory, along with their bids wherever estimated tender value is Rs. 2 Crore or more.
- i) In case of open tender, technically qualified unregistered bidders may apply online for registration through <http://www.bhel.com/index.php/vender>.
- j) BHEL reserves the right to award tendered quantities among more than one bidder (after acceptance of L1 price by the other bidders). BHEL can also consider awarding of part of the tendered quantity to other than L-1 bidder at L1 counter offered rates, if the quantity offered by the L-1 bidder is less than the quantity tendered for.
- k) In case of e-Tendering (Online bidding through e-portal), offline bid submitted in hard copy or in any other form by the vendor / supplier will not be accepted and will be rejected out rightly. Only e-portal bid will be accepted.

#### 4. TENDER OPENING.

Tender opening is scheduled to start in the Tender Room at 2:00 PM, on the due date. Therefore, bid / quotations must reach this office / tender Box latest by 1:45 PM on due date. Only participating bidders are allowed to attend tender opening. **TENDERS RECEIVED AFTER THE SPECIFIED TIME OF THEIR 'SUBMISSION' WILL BE TREATED AS LATE TENDERS AND SHALL NOT BE CONSIDERED UNDER ANY CIRCUMSTANCES.** The bidders or their authorized representatives may be allowed to attend tender opening if duly authorized by their principals, through a tender specific letter on that particular day. General authorization letter is not acceptable.

***Note: - Foreign bidders willing to attend the bid opening has to provide the requisite documents to the concerned Purchase executives for arranging gate pass for them.***

#### 5. SPECIFICATION, DRAWINGS & STANDARD.

- a) Bidders must give their detailed specification in the quotation along with relevant technical literature / catalogue etc. against the tender enquiry.
- b) The Bid should be accompanied with relevant copies of catalogues, drawings or specification as per tender enquiry.

## Quotations / Bids not in accordance with General Instructions and Standard Terms & Conditions are likely to be ignored.



## BHARAT HEAVY ELECTRICALS LIMITED

HEEP-HARIDWAR, UTTARAKHAND (249403)

General Instructions and Standard Terms & Conditions for bidding against Tender Enquiry (GISTC)

For Indian Bidders (Version June-2021, Rev: 06)

If these documents are not furnished, the offer is liable to be rejected.

- c) Wherever national / international (N/IN) standards are referred, the latest N/IN standards are to be followed. Mention year & date of standard revision that shall be followed for the supply.
- d) All Drawings and Standards are proprietary of BHEL. It must not be used in anyway detrimental to the interest of BHEL or without permission of BHEL.

### 6. PRICE SCHEDULE.

- a) Kindly quote your prices in figures and words both. In case of any discrepancy in value, the prices quoted in words shall be considered for evaluation and establishing L1 status.
- b) Prices quoted should not be more than the prices quoted to any other BHEL units / offices / divisions. Vendor to submit copy of latest Purchase Order placed by any unit of BHEL for similar items in the technical bid. In case no order has been placed on such items, specific confirmation that no order has been placed on such items should be provided.
- c) Prices should be quoted on F.O.R. Destination basis. Transit insurance shall be arranged by BHEL and not to be included in the prices. The offers quoted on other than F.O.R destination basis may result in non-consideration of such bids.
- d) In case BHEL accepts the EX-Works prices, such offers will be loaded by 1.5% of EX-Works value towards freight or with actual freight charges as per BHEL freight rate contract whichever is higher.
- e) In case of Indigenous items covered by DGS & D Rate Contract, the bidders should submit latest valid copy of the rate contract along with bid / quotation
- f) Applicable **IGST / CGST / SGST** and any other statutory levy should be indicated separately and clearly in the bid / quotation.

- g) Bidders can dispatch goods through any Indian Bank Association approved transporters having their branch at HARIDWAR / destination. If material is dispatched through other than Indian Bank Association approved transporter, material to be delivered on door delivery BHEL Stores basis.
- h) In case of dispatch of material through any other unapproved transporter, payment shall be made only after receipt of material and any additional charges payable to the transporter shall be to the bidder's account.
- i) Any demurrage / godown rent payable to the transporter / or to godown's owner due to any delay attributed by the supplier shall be recovered from supplier's account.
- j) Currency of Evaluation shall be INR.

**NB: Financial evaluation of L1, L2 .....Status will be on the basis of Landed Cost to BHEL.**

### 7. REVERSE AUCTION.

**Wherever RA is declared in the special terms and conditions of tender enquiry, following shall be applicable and Bidders to confirm the same:**

"BHEL shall be resorting to Reverse Auction (RA) (Guidelines as available on [www.bhel.com](http://www.bhel.com)) for this tender. RA shall be conducted among all the techno-commercially qualified bidders.

Price bids of all techno-commercially qualified bidders shall be opened and same shall be considered as initial bids of bidders in RA. In case any bidder(s) do(es) not participate in online Reverse Auction, their sealed envelope price bid along with applicable loading, if any, shall be considered for ranking."

### 8. DELIVERY TERMS.

- a) Goods shall be delivered on 'FOR Destination' basis to the named destination unless otherwise called for in the tender enquiry.
- b) Loading on account of 3rd party inspection charges in case of Indian bidders shall be 0.20%.

**## Quotations / Bids not in accordance with General Instructions and Standard Terms & Conditions are likely to be ignored.**



## BHARAT HEAVY ELECTRICALS LIMITED

HEEP-HARIDWAR, UTTARAKHAND (249403)

General Instructions and Standard Terms & Conditions for bidding against Tender Enquiry (GISTC)

For Indian Bidders (Version June-2021, Rev: 06)

### 9. LIQUIDATED DAMAGES (LD) FOR LATE DELIVERY.

#### a) Where items of Purchase Order are independently usable.

Liquidated Damages (LD) for Late Deliveries shall be applicable @0.5% per week or part thereof on the value of respective delayed supplies subject to a maximum of 10% of the value of respective delayed supplies. Value of delayed supplies will mean the Gross Value payable to the vendor (Before LD) against such supplies excluding taxes and duties.

#### b) Where the total items are required for a main equipment and items are interdependent.

Liquidated Damages (LD) for Late Deliveries shall be applicable @0.5% per week or part thereof on total value of Purchase Order subject to maximum of 10% of the total value of Purchase Order. Purchase Order value for this purpose shall be the Total Gross Value payable to the vendor (Before LD) excluding taxes and duties.

#### c) Bidders are requested to quote the best delivery meeting the delivery requirements. BHEL reserves the right to reject the offers not meeting BHEL's delivery requirement.

#### d) Commencement of delivery period shall be reckoned from the date of PO / LOI or any other agreed milestone.

#### e) Bidder shall deliver the goods in the manner and schedule agreed under the terms and conditions of Purchase order.

#### f) DELIVERY IN CASE OF REJECTION: In case the material is rejected, then date of replacement will be considered as the actual date of delivery.

#### g) DELIVERY AGAINST BANK DOCUMENTS: In case payment terms quoted by bidder are documents through bank, and the delivery terms being "FOR Haridwar / FOR Transporter Go-down" then date of delivery will be date of intimation by transporter / bidder of delivery of material at Haridwar for the LD purpose.

#### h) Where the payments are through bank, the documents may be presented for negotiation to BHEL authorized / nominated bank.

i) Payment of Liquidated Damages (LD) shall not in any way relieve the vendor from any of its obligations & liabilities under the contract.

### 10. PAYMENT TERMS.

a) BHEL's standard payment term is Payment after receipt and acceptance of materials / items at HEEP, BHEL-Store or at desired destination unless otherwise specified in Special Terms attached to the tender enquiry.

b) BHEL reserves the right to accept or reject the offer of the bidder who quotes the payment term other than BHEL's standard payment term.

c) Loading on account of deviation in payment terms shall be done as per extant rules of BHEL-Haridwar.

d) 100% payment along with taxes, freight & insurance will be made after receipt and acceptance of material and within 75 days from the date of invoice subject to submission of non-discrepant documents within 15 days of supply as per terms and conditions of Purchase Order. In case any discrepancy found in the documents, BHEL will notify the same to vendor within 7 days of receipt. Vendor has to clear all the discrepancies in one go within 7 days thereafter else the payment of vendor may get delayed.

e) For MSEs (covered under MSME Act) which are registered and periodically renewed with BHEL, the payment will be made within 45 days or as prescribed in the relevant act.

f) Adherence to the above time schedule of payment is contingent upon Vendor complying with GST Rules w.r.t availment of Input Tax Credit by BHEL.

g) In case GST credit is delayed / denied to BHEL, due to non / delayed receipt of goods and / or tax invoice or expiry of the timeline prescribed in GST Law for availing such ITC, or any other reason not attributable to BHEL, GST amount shall be recoverable from Vendor along with interest levied / leviable on BHEL.

h) The taxes and duties that are reimbursed would be the ones applicable as on the contractual Purchase order delivery date or the amount actually paid whichever is less.



## BHARAT HEAVY ELECTRICALS LIMITED

HEEP-HARIDWAR, UTTARAKHAND (249403)

General Instructions and Standard Terms & Conditions for bidding against Tender Enquiry (GISTC)

For Indian Bidders (Version June-2021, Rev: 06)

i) **The loading criteria for the different payment terms shall be as under;**

Payment Terms	Days of Loading
After Receipt & Acceptance of material within 75 days of supply.	<b>No Loading</b>
Against Delivery at BHEL-Stores Haridwar.	<b>45</b>
Against documents through bank (CAD):	<b>45</b>
Letter of Credit (LC)	<b>120</b>
Usance LC	No Loading if usance period is > 120 Days.
	Loading of days' difference i.e. difference between 120 days and usance period if the usance period is < 75 days.
Advance	Delivery Period + 120 Days - Advance Payment Days.

### 11. TAXES & DUTIES.

- a) The bidder to specify in their offer (part 1 bid) the category of their registration under GST like Registered, Unregistered and composite dealer.
- b) The provisional GST registration number of Bharat Heavy Electrical Ltd, Heavy Electricals Equipment Plant, Ranipur, Haridwar is "05AAACB4146P1ZL" with state Code as "05" and State Name as "Uttarakhand".
- c) Please quote our provisional GST registration number in all invoices raised for supply of goods and services under GST regime and also ensure filing of timely return and payment of tax and compliance of other applicable provisions on supplier under GST regime.
- d) No GST will be reimbursed to unregistered or composite dealer. In the event, any GST is quoted by composite dealer, the same shall be added to the cost of supply in evaluating the bid.
- e) Since, input credit of GST will be available to BHEL-Haridwar only after correct filing of return and payment of applicable GST by supplier, reimbursement of GST shall be made by

BHEL-Haridwar on matching of vendor inputs at GST portal, ensuring availability of input credit to BHEL Haridwar. Payment of GST will be made to vendor after matching of input credit and vendor to ensure submission of their invoices along with consent to accept payment of tax after such matching in all cases where bills are submitted directly to BHEL-Haridwar or through bank or under LC or through any other mode.

- f) In the event of any disallowance of input credit or applicability of interest or any other financial liability arises on BHEL-Haridwar due to any default of supplier under GST, such implication shall be to supplier's account.
- g) In the event of any change in the status of the vendor after the submission of the bid but before the supply, GST applicable at the time of supply or in the bid, based on the registration status of the vendor, whichever is lower shall be payable.
- h) Where ever applicable If PAN (Permanent Account Number) of the recipient is not available, income tax is deductible either at the normal rate or at the rate of 20 percent, whichever is higher as per Section 206AA of Indian Income Tax Act 1961.
- i) The bidder shall clearly indicate HSN (*Harmonised System Nomenclature*) / SAC (*Service Accounting Code*), its description and applicable rate of GST for each item in his techno-commercial bid.
- j) Statutory Variation in Taxes & duties as applicable at the time of supply shall be payable. However, in the event of no change in law but bidder quoting certain tax structure in bid document which is lower than the applicable one, such amount shall be the maximum amount of tax that can be claimed by bidder.
- k) **IMPORTED GOODS OFFERED BY INDIAN BIDDERS AGAINST DEALER INVOICE:** Wherever the material being offered is imported, the bidder must quote the prices inclusive of IGST. The rate and value of IGST as included in the price must be indicated separately. In case quantum of IGST is not mentioned by the bidder the same will not be considered for



## BHARAT HEAVY ELECTRICALS LIMITED

HEEP-HARIDWAR, UTTARAKHAND (249403)

General Instructions and Standard Terms & Conditions for bidding against Tender Enquiry (GISTC)

For Indian Bidders (Version June-2021, Rev: 06)

evaluation. However, bidder will have to pass on the benefit of IGST to BHEL at the time supply.

- l) In case of directly dispatchable items to Customer's Site, BHEL-Haridwar will inform the GST registration number of the respective customer which must be mentioned on the vendor's invoice. Vendor to ensure availability of such information from BHEL-Haridwar before dispatch of any material. However, while filing GSTN-1, BHEL Haridwar GSTN number to be quoted.

Note: - Vendors must ensure compliance of all the applicable rules and procedure as envisaged in the GST Regime. Any loss to BHEL-Haridwar due to fault / non-compliance by the vendor will be to the vendor's account.

### 12. BANK GUARANTEE.

In case the bank guarantees are required to be deposited towards security deposit/performance guarantee or for any other purpose as per the terms of this tender enquiry, such bank guarantees of the requisite value in the denominated currency of the purchase order should be from one of the Indian branch of BHEL consortium banks and the bank guarantee should be in the proforma as prescribed by BHEL. The proforma of bank guarantee and the list of consortium banks are displayed at BHEL website [www.bhelhwr.co.in](http://www.bhelhwr.co.in). However, in case the bank guarantee is not from BHEL consortium banks, then the bidder has to get the bank guarantee confirmed from one of the Indian branch of BHEL consortium banks and the bank charges for such confirmation will be borne by the bidder.

### 13. GUARANTEE / WARRANTY AND CORRESPONDING REPAIRS / REPLACEMENT OF GOODS.

Goods shall comply with the specifications for material, workmanship and performance. Unless otherwise specified, the warranty shall be for a period of 18 months from the date of receipt. If the delivery is found non-compliant during the warranty period, leading to rejection, the Seller shall arrange free replacement / repair of goods, within one month from the date of intimation or any mutually agreed period. The rejected goods shall be taken away by the Seller at his cost and

replaced on Delivered Duty Paid (DDP) (FOR - BHEL Stores / designated destination basis) within such period. In the event of the Seller's failure to comply, Purchaser may take action as appropriate, including Repair / Replenish rejected goods & disposal of rejections, at the risk & cost of the Seller. In case the defects attributable to Seller are detected during processing of the goods at BHEL or at our subcontractor's works, the Seller shall be responsible for free replacement / repair of the goods as required by BHEL.

- b) **RETURN OF REJECTED MATERIAL FOR REPLACEMENT:** The bidder shall have to pay 5% incidental charges while taking back supplied material if it is found rejected on receipt. The rejected material shall be sent back only after receipt of replacement / submission of BG / refund of amount paid.

### 14. QUALITY REQUIREMENT.

Your bid / quotation should have specific confirmation regarding meeting all our quality requirements such as. (i) Test Certificate (TC), (ii) Guarantee Certificate (GC) / Warranty Certificate (WC), (iii) Quality Plan (QP) (if applicable); and (iv) Pre-Dispatch Inspection at your works (if applicable).

### 15. VALIDITY.

The quotation should be valid for a minimum period of 90 days effective from the date of opening of tender, unless otherwise specified in the tender enquiry.

### 16. RIGHT OF ACCEPTANCE.

- a) **BHARAT HEAVY ELECTRICALS LIMITED HARIDWAR** reserves the right to reject any or all the bids / quotations without assigning any reason thereof. BHEL also reserves the right to increase or decrease the tendered quantities. Bidders should be prepared to accept order for reduced quantity without any extra charges.
- b) Any discount / revised offer / bids submitted by a bidder on its own shall be considered, provided it is received on or before the due date and time of offer / bid submission (Part-1). Conditional discounts shall not be considered for evaluation of tenders.



## BHARAT HEAVY ELECTRICALS LIMITED

HEEP-HARIDWAR, UTTARAKHAND (249403)

General Instructions and Standard Terms & Conditions for bidding against Tender Enquiry (GISTC)

For Indian Bidders (Version June-2021, Rev: 06)

- c) Unsolicited discounts / revised offers / bids given after Part-1 bid opening shall not be accepted. No change in price will be permitted within the validity period asked for in the tender enquiry.
- d) In case of changes in scope and / or technical specification and / or commercial terms & conditions having price implication, techno-commercially acceptable bidders shall be asked by BHEL to submit the impact of such changes on their price bids. In case a bidder opts to submit revised price bid instead of impact called for then the latest price bid shall prevail. However, in both situations, original price bid will be necessarily opened.
- e) The bidder whose bid is technically not accepted will be informed & EMD wherever submitted shall be returned after finalization of contract. EMD shall be forfeited in the event of bidder opting out after tender opening.
- f) BHEL reserves the right to short close the existing Purchase Order / Rate Contract / Work Order or any extension thereof at any stage.

### 17. TRANSIT INSURANCE.

- a) Transit Insurance will be covered by BHEL under its open Insurance Policy. Seller shall inform dispatch particulars (Purchase Order, RR /GR, Invoice value etc.) to "Finance department (Store bill Section), BHEL Ranipur, Haridwar (Uttarakhand-India) with value of consignment to the Purchaser within 07 days of dispatch for BHEL to arrange insurance coverage in its policy. Failure on the part of seller to inform dispatch particulars will make him liable to pay for any transit damages / losses suffered by the Purchaser.
- b) If Quoted Prices are inclusive of transit insurance, no weightage shall be given while evaluating the bids for Cost of Insurance, being in BHEL Scope.

### 18. RISK PURCHASE.

In case of abnormal delays (beyond the maximum late delivery period as per LD clause) in supplies / defective supplies or non-fulfillment of any other terms and conditions given in Purchase Order, BHEL may cancel the Purchase Order in full or part thereof, and may also make the purchase of such material from elsewhere / alternative source at the risk and cost of the supplier. BHEL will take all reasonable steps to get the material from alternate source at optimum cost. If bidder does not agree to the above Risk Purchase Clause, BHEL reserves the right to reject the offer. In case for compelling reasons BHEL accepts the offer without acceptance of this clause by the bidder and in the eventuality of Risk Purchase, appropriate action will be taken as per BHEL extant rules. This will be without prejudice to any other right of BHEL under the contract or under General Law.

### 19. FORCE MAJEURE CLAUSE.

Notwithstanding any other thing contained anywhere else in the contract or PO (Purchase Order), In case the discharge of obligation under the contract by either party is impeded or made unreasonably onerous, neither party shall be considered in breach of the contract to the extent that performance of their respective obligation is prevented by an event of Force Majeure that arises after the effective date (PO date).

In the above clause, Force Majeure means an event beyond the control of the parties to the contract which prevents a party from complying with any obligation of the contract including but not limited to:

- Act of God (Such as but not limited to earthquake, drought, tidal waves, floods etc.).
- War (whether war be declared or not), Hostilities Invasion, Act of foreign enemy etc.
- Rebellion, revolution, insurrection, civil war etc.
- Contamination of Radio Activity from any nuclear fuel or from any other nuclear waste or any other hazardous materials.
- Riots, commotions, strike unless restricted to the employees of supplier.
- Acts of terrorism.



## BHARAT HEAVY ELECTRICALS LIMITED

HEEP-HARIDWAR, UTTARAKHAND (249403)

General Instructions and Standard Terms & Conditions for bidding against Tender Enquiry (GISTC)

For Indian Bidders (Version June-2021, Rev: 06)

- g) Other unforeseeable circumstances beyond the control of the parties and which the affected party cannot avoid even by using its best efforts.
- h) Cancellation of contract by customer.
- i) Change in law / government. Regulation making the performance impossible.
- j) Pandemic or Epidemic.

The party claiming to be affected by force majeure shall notify the other party in writing immediately without delay on the intervention and on the cessation of such circumstances.

Irrespective of any extension of time, if an event of force majeure occurs and its effect continues for more than 180 days the affected party shall have right to cancel the contract.

As soon as reasonably practicable following the date of commencement of a Force Majeure Event, and within a reasonable time following the date of termination of a Force Majeure Event, either Party invoking it shall submit to the other Party reasonable proof of the nature of the Force Majeure Event and of its effect upon the performance of the Party's obligations under this Agreement.

The party shall, and shall ensure that its Subcontractors shall, at all times take all reasonable steps within their respective powers and consistent with Good Operating Practices (but without incurring unreasonable additional costs) to:

- a) Prevent Force Majeure Events affecting the performance of the party's obligations under this Agreement.
- b) mitigate the effect of any Force Majeure Event and
- c) Comply with its obligations under this Agreement.

If the war like situation has developed in a country where a seller's works is located in this P.O. or there is political instability and Indian Embassy located in that country forbids or advises for not having any business dealing with the sellers located in such zone / region/ country, then BHEL reserves the right to cancel the order.

### **20. NON-DISCLOSURE AGREEMENT.**

All Drawing and Technical Documents relating to the product or it's manufacture submitted by one party to the other, prior or

subsequent to the formation of contract, shall remain property of the submitting party. Drawing, technical documents or other technical information received by one party, shall not without the consent of the other party, be used for any other purpose than that, for which they were provided. Such technical information shall not without the consent of the submitting party, otherwise be used or copied, reproduced, transmitted or communicated to a third party. Patterns supplied by BHEL will remain BHEL's property which shall be returned by the bidder on demand to BHEL. Bidder shall in no way share or use such intellectual property of BHEL to promote his own business with others or to gain a commercial advantage. BHEL reserves the right to claim damages from the bidder, or take appropriate action as deemed fit against the bidder, for any infringement of the provisions contained herein as available under law or equity.

### **21. SETTLEMENT OF DISPUTES / ARBITRATION.**

In case of any dispute arising out of as in connection with this contract, the same shall be referred to arbitration under Arbitration & Conciliation Act 1996 of a sole arbitrator who shall be appointed by mutual consent of the parties. The seat & venue of arbitration shall be Haridwar.

The proceedings shall be conducted in English. The Governing law of contract shall be the substantive law of India.

### **22. WHARFAGE / DEMURRAGE RESPONSIBILITY.**

In the event of delay in receipt of documents by Manager (Stores-Shipping) BHEL-Haridwar and in case where dispatches are made through Unapproved Transporter the sole responsibility for wharfage / demurrage for such delay shall be that of supplier.

### **23. CONDITIONS FOR AVAILING MICRO & SMALL ENTERPRISES (MSE'S) BENEFITS.**

- a) "MSE Suppliers can avail the intended benefits only if they submit along with the offer, attested copies of either EM II certificate having deemed validity (**five years** from the date of issue of acknowledgement in EM II) or valid NSIC certificate or EM II certificate along with attested copy of a CA certificate



## BHARAT HEAVY ELECTRICALS LIMITED

HEEP-HARIDWAR, UTTARAKHAND (249403)

General Instructions and Standard Terms & Conditions for bidding against Tender Enquiry (GISTC)

For Indian Bidders (Version June-2021, Rev: 06)

(Format enclosed at annexure-1 where deemed validity of EM II certificate of five years has expired) applicable for the relevant financial year (latest audited). Date to be reckoned for determining the deemed validity will be the date of bid opening (Part 1 in case of two-part bid) or vendor has to give Udyog Adhar Memorandum (UAM). Non submission of such documents will lead to consideration of their bid at par with other bidders. No benefit shall be applicable for this enquiry if any deficiency in the above required documents is found or the requisite documents are not submitted before price bid opening. If the tender is to be submitted through e-procurement portal, then the above require document are to be uploaded on the portal. Documents should be notarized or attested by a Gazetted officer. **UAM need not required to be notarized or attested.**

**b)** Any new supplier will be eligible for registration with BHEL as MSE supplier provided at least any one of the following documents are submitted along with application for registration: -

1. Udyog Adhar Memorandum (UAM).
2. Valid National Small Industries Commission (NSIC) Certificate.
3. Entrepreneurs Memorandum part II (EM II) certificate (valid based on deemed validity of 5 years) or
4. EM II certificate along with attested copy of CA Certificate (as per prescribed format at annexure-A) applicable for the relevant financial year (latest audited), where the deemed validity of EM II is over.
5. However, credentials of all MSE suppliers will be verified before advancing the intended benefits.
6. MSE bidders claiming SC/ST status will have to submit SC/ST certificate of the Proprietor from competent authority. Attested (notarized or attested by Gazetted officer) copy to be submitted along with the offer.
7. In case techno-commercial accepted bidders include MSE source and their prices (based on landed cost – considering quoted prices) are within the price band of 15% w.r.t. L-1 bidder, then BHEL can offer **25%** of quantity of respective item (rounded off to nearest number) to MSE bidders at L-1 price and in case, more than one MSE bidder is in 15 % band and the same is accepted by more than one MSE bidders then **25%** quantities of respective items will be considered for ordering on proportionate basis amongst MSE bidders.

8. There will be minimum of **3%** reservation for women owned MSEs within the above mentioned 25% reservation.
9. The reservation for MSEs owned by SC/ST will be **6.25%** { 25% out of target of 25% - refer para 4 of Public Procurement Policy for the Micro and Small Enterprises(MSEs)}.
10. The definition of MSEs owned by Women Entrepreneurs is clarified as under:
  - a) In case of proprietary MSE, proprietor shall be Woman.
  - b) In case of partnership MSE, the Woman partners shall be holding at least 51% of share in the unit.
  - c) In case of Private Limited companies, at least 51% share shall be held by Women promoters.
11. The definition of MSEs owned by SC/ST is clarified as under:
  - a) In case of proprietary MSE, proprietor(s) shall be SC/ST.
  - b) In case of partnership MSE, the SC/ST partners shall be holding at least 51% of shares in the unit.
  - c) In case of Private Limited companies, at least 51% share shall be held by SC/ST promoters.
12. While distributing the **25%** quantity amongst MSE bidders the decimal points in quantity shall be ignored for all the bidders except the L-1 amongst MSE bidders. Balance quantity after allocating the quantity to other MSE bidders ignoring the quantities in decimal, shall be given to L-1 (amongst MSE) bidder. However, if there are more than one MSE bidder at the same price level than preference for additional quantities due to ignoring off the decimal (as mentioned above) shall be given to the bidder offering favorable terms to BHEL and if the conditions offered are also same then preference will be given to the bidder having high SPR rating.
13. In case there are more than one MSE bidders (with different landed cost to BHEL) within 15% price band of lowest bidder and quantity to be offered is 1 no. only, then preference shall be given to the MSE bidder with lowest landed cost.
14. In case there are more than one MSE bidders (with same landed cost to BHEL) within 15% price band of lowest bidder and quantity to be offered is 1 no. only, then preference shall be given first, based on the favorable terms in the bid and in case terms are also same, the bidder with high SPR rating shall be given preference.
15. If L1 bidder is MSE bidder, entire quantity will be given to such MSE bidder only.



## BHARAT HEAVY ELECTRICALS LIMITED

HEEP-HARIDWAR, UTTARAKHAND (249403)

General Instructions and Standard Terms & Conditions for bidding against Tender Enquiry (GISTIC)

For Indian Bidders (Version June-2021, Rev: 06)

16. Note: It may however be noted that MSE guidelines as on date (Date of Technical Bid Opening Part-1) shall prevail.

17. "As per the OM No. F.No. 1(2)(1)/2016-MA dtd. 09.02.2017 issued from the Office of Development Commissioner (Micro, Small & Medium Enterprises), "Traders and agents should not be allowed to avail the benefits extended under the PP Policy."

In view of this, it is clarified that benefits of MSE (such as EMD Waiver, Tender fee exemption, Price preference, Payment preference etc.) will be given only to those MSE Vendors who are manufacturers of offered items against the NIT. No MSE benefits shall be provided to Agents / Stockists / Dealers / Traders etc. for the items offered but not manufactured by themselves."

#### 24. INFORMATION TO THE BIDDERS.

a) Purchase related information is available at our Business-to-Business (B2B) Portal available on our website <https://hwr.bhel.com>. The user ID & password can be obtained by sending a request to concerned purchase executives.

b) Intimate your change in mail address or communication address or changes, if any, by email to AGM (SDX/MM) giving your bidder Code.

c) Please resolve your rejections and unexecuted overdue purchase order immediately which are posted at our B2B Portal, which can be visited through our site <https://hwr.bhel.com>

d) Copy of this Tender Enquiry is being sent through the post.

e) The Bidder declares that they will not enter into any illegal or undisclosed agreement or understanding, whether formal or informal with other bidder(s). This applies in particular to prices, specifications, certifications, subsidiary contracts, submission or non-submission of bids or any other actions to restrict competitiveness or to introduce cartelization in the bidding process.

In case, the bidder is found having indulged in above activities, suitable action shall be taken by BHEL as per extant policies/guidelines.

f) Supplier must upload digitally signed e-Invoice on B2B portal for processing of Bills.

In other cases, inked signed hard copy of Invoice to be submitted for processing of Bills.

#### 25. MAKE IN INDIA (GOVT-NOTIFICATION).

A. This tender enquiry shall be governed by notification no. P-45021/2/2017-PP (BE-II) dated 04.06.2020 of government of INDIA and subsequent circulars issued afterwards. Accordingly, the minimum local content, the margin of purchase preference and the procedure for preference to make in INDIA shall be adhered.

B. The margin of purchase preference shall be 20%.

- 'Class-I local Supplier' means a supplier or service provider, whose goods, services or works offered for procurement, has local content equal to or more than 50%, as defined under this order.
- 'Class-II local Supplier' means a supplier or service provider, whose goods, services or works offered for procurement, has local content more than 20% but less than 50%, as defined under this order.
- 'Non- local Supplier' means a supplier or service provider, whose goods, services or works offered for procurement, has local content less than or equal to 20%, as defined under this order.

C. Vendor to specifically confirm if they are Class-I or Class-II local supplier or not as per above mentioned notification. Accordingly, the 'Class-I local supplier' / 'Class-II local Supplier' at the time of tender, bidding or solicitation shall be required to indicate percentage of local content and provide self-certification that the item offered meets the local content requirement for 'Class-I local supplier' / 'Class-II local Supplier', as the case may be. They shall also give details of the location(s) at which the local value addition is made.

D. In cases of Procurement for a Value in Excess of Rs. 10 Crores, the 'Class-I local supplier' / 'Class-II local Supplier' shall be required to provide a Certificate from the Statutory Auditor or Cost Auditor of the Company (in the case of companies) or from a practicing Cost Accountant or practicing Chartered Accountant (in respect of suppliers other than companies) giving the percentage of Local Content.



## BHARAT HEAVY ELECTRICALS LIMITED

HEEP-HARIDWAR, UTTARAKHAND (249403)

General Instructions and Standard Terms & Conditions for bidding against Tender Enquiry (GISTC)

For Indian Bidders (Version June-2021, Rev: 06)

### E. Requirement of Purchase Preference:

Purchase preference shall be given to 'Class-I local supplier' in procurements undertaken by procuring entities in the manner specified hereunder -

a. In the procurements of goods or works, which are covered by para 3(b) of mentioned Govt. circular and which are divisible in nature, the 'class-I local supplier' shall get purchase preference over 'Class-II supplier' as well as 'Non-local supplier', as per following procedure:

- i. Among All qualified bids, the lowest bid will be termed as L1. If L1 is 'Class-I local supplier', the contract for full quantity will be awarded to L1.
- ii. If L1 bid is not a 'Class-I local supplier', 50% of the order quantity shall be awarded to L1. Thereafter, the lowest bidder among the 'Class-I local supplier' will be invited to match the L1 price for the remaining 50% quantity subject to the class-I local supplier's quoted price falling within the margin of purchase preference, and contract for that quantity shall be awarded to such 'Class-I local supplier' subject to matching the L1 price. In case such lowest eligible 'Class-I local supplier' fails to match the L1 price or accepts less than the offered quantity, the next higher 'Class-I local supplier' within the margin of purchase preference shall be invited to match the L1 price for remaining quantity and so on, and contract shall be awarded accordingly. In case some quantity is still left uncovered on Class-I local supplier, then such balance quantity may also be ordered on the L1 bidder".

b. In the procurements of goods or works, which are covered by para 3(b) of mentioned Govt. circular and which are not divisible in nature, and in procurement of services where the bid is evaluated on price alone, the 'class-I local supplier' shall get purchase preference over 'Class-II supplier' as well as 'Non-local supplier', as per following procedure:

- i. Among all qualified bids, the lowest bid will be termed as L1. If L1 is 'Class-I local supplier', the contract will be awarded to L1.
- ii. If L1 is not 'Class-I local supplier', the lowest bidder among the 'Class-I local supplier', will be invited to match the L1 price subject to Class-I local supplier's quoted price falling

within the margin of purchase preference, and the contract shall be awarded to such 'Class-I local supplier' subject to matching the L1 price.

- iii. In case such lowest eligible 'Class-I local supplier', fails to match the L1 price, the 'Class-I local supplier' with the next higher bid within the margin of purchase preference shall be invited to match the L1 price and so on and contract shall be awarded accordingly. In case none of the 'Class-I local supplier' within the margin of purchase preference matches the L1 prices, the contract may be awarded to the L1 bidder.

c. 'Class-II local supplier' will not get purchase preference in any procurement, undertaken by procuring entities.

F. For this procurement, the local content to categorize a supplier as a Class-I local supplier/ Class-II local supplier/ Non-local supplier and purchase preference to Class-I local supplier, is as defined in Public Procurement (Preference to Make in India), Order 2017 dated 04.06.2020 issued by DPIIT. In case of subsequent orders issued by nodal ministry, changing the definition of local content for the items of the NIT, the same shall be applicable even if issued after issue of this NIT, but before opening of Part-II bids against this NIT.

G. Procurements where estimated value to be procured is less than Rs. 5 lakhs shall be exempted from GOI order No. P-45021/2/2017-PP (BE-II) dated 04.06.2020.

H. For procurement of Goods & Services which are divisible in nature, following shall be operated for **MSE bidders** under Public procurement Policy for the Micro and Small Enterprises (MSEs) Amendment Order, 2019, Ref. No. AA:SSP: MSE: Amndt, dtd. 30.11.2018, Circular No. 44 of 2018-19;-

a. If L1 bid is not from "Class-I local Supplier" and price quoted by MSE bidder falls within the margin of Purchase preference (L1+15% for MSEs), then 25 % of total order quantity of respective item (rounded off to nearest number) shall be awarded to MSE bidder, subject to MSE bidder matching the L1 Price. Out of Remaining 75% quantity, distribution shall be operated as per below sub-clause (2) –

b. If "Class- I Local Supplier" (Next to L1, other than MSE) quoted price falling within the Margin of Purchase Preference, and "Class-I local supplier" matches the L1 price,



## BHARAT HEAVY ELECTRICALS LIMITED

HEEP-HARIDWAR, UTTARAKHAND (249403)

General Instructions and Standard Terms & Conditions for bidding against Tender Enquiry (GISTC)

For Indian Bidders (Version June-2021, Rev: 06)

then 50% of remaining Quantity (after allocation of 25% to MSE) i.e. 37.5% shall be awarded to local supplier and 37.5% shall be awarded to foreign bidder.

*Note: L1 Price refers to lowest evaluated / landed cost to Company.*

For Further details, please refer GOI order no. P-45021 / 2 / 2017 - PP (BE-II) dated 04.06.2020.

### 26. RESTRICTIONS UNDER RULE 144(XI) OF THE GENERAL FINANCIAL RULES (GFRs), 2017

All provisions of Order No. F.No.6/18/2019-PPD of Department of Expenditure (DoE) shall be applicable for this tender enquiry (Order copy is available at <https://doe.gov.in/procurement-policy-divisions>). Accordingly, any bidder from a country which shares a land border with India (except the countries to which the Govt. of India has extended lines of credit or in which the Govt. of India is engaged in development projects for which list is available at <https://www.mea.gov.in/>) will be eligible to bid in this tender only if the bidder is registered with the Competent Authority as specified in Annex I of the said Order of DoE.

Updated list of the countries to which lines of credit have been extended or in which development projects are undertaken are available on the Ministry of External affairs website (<https://www.mea.gov.in/>)

For the purpose of this order, definition of Bidder from a country which shares a land border with India shall be same as defined in the Annex III of the said order.

Registration with the competent authority as stipulated in the said order is responsibility of bidder. Bidder has to submit a certificate certifying following along with offer:

"I have read the clause regarding restrictions on procurement from a bidder of a country which shares a land border with India; I certify that bidder (.... Name of Bidder) is not from such a country or, if from such a country, has been registered with the Competent Authority. I hereby certify that bidder (.....Name of bidder) fulfils all requirements in this regard and is eligible to be considered"

If the bidder is from such country which shares a land border with India evidence of valid registration by the Competent Authority shall also be attached along with offer."

### 27. NOTE.

- a) Special conditions of enquiry, if enclosed by BHEL, will supersede the respective standard / general terms of enquiry.
- b) Any other Standard terms and Conditions of the bidder attached / referred against the tender enquiry will be treated as null and void ab initio.
- c) In order to protect the commercial interests of BHEL, it becomes necessary to take action against suppliers / contractors by way of suspension of business dealings, who either fail to perform or are in default without any reasonable cause, cause loss of business / money / reputation, indulged in malpractices, cheating, bribery, fraud or any other misconducts or formation of cartel so as to influence the bidding process or influence the price etc. Guide- lines for Suspension of Business Dealings with Suppliers / Contractors shall prevail over which is available at BHEL website <http://www.bhel.com>
- d) The bidder along with its associate / collaborators / sub-contractors / sub-vendors / consultants / service providers shall strictly adhere to BHEL Fraud Prevention Policy displayed on BHEL website <http://www.bhel.com> and shall immediately bring to the notice of BHEL-Management about any fraud or suspected fraud as soon as it comes to their notice.
- e) "BHEL shall recover the amount of compensation paid to victim(s) by BHEL towards loss of life / permanent disability due to an accident which is attributable to the negligence of contractor, agency or firm or any of its employees as detailed below;
  1. **Victim:** Any person who suffers permanent disablement or dies in an accident as defined below.
  2. **Accident:** Any death or permanent disability resulting solely and directly from any unintended and unforeseen injurious

**## Quotations / Bids not in accordance with General Instructions and Standard Terms & Conditions are likely to be ignored.**



## BHARAT HEAVY ELECTRICALS LIMITED

HEEP-HARIDWAR, UTTARAKHAND (249403)

General Instructions and Standard Terms & Conditions for bidding against Tender Enquiry (GISTC)

For Indian Bidders (Version June-2021, Rev: 06)

occurrence caused during the manufacturing / operation and works incidental thereto at BHEL factories/ **offices and precincts** thereof , project execution , erection and commissioning, services, repairs and maintenance, trouble shooting, serving , overhaul, renovation and retrofitting , trial operation, performance guarantee testing undertaken by the company or during any works / during working at BHEL Units/ Offices/ townships and premises/ project sites.

### 3. Compensation in respect of each of the victims:

- (i) In the event of death or **permanent disability** resulting from **Loss of both limbs**: Rs. 10,00,000/- (Rs. Ten Lakh).
- (ii) In the event of **other permanent disability**: Rs. 7,00,000/- (Rs. Seven Lakh).

4. Permanent Disablement: A disablement that is classified as a permanent total disablement under the proviso to Section 2(l) of the Employees Compensation Act, 1923.”

f) The bidder shall be in compliance with applicable laws, rules and regulations throughout the terms of the contract for conducting its business generally and to perform its obligations under this contract.

**Tender No: E/ E242/2/0281C1****Annexure-4**

<b>Commercial Term and condition of the enquiry (Indian Bidders)</b>			<b>Bidder's response</b>
1	Bidder to upload technical bid on NIC Portal	Bidder to confirm	
2	Bidder to confirm that offered price on NIC portal shall be all- inclusive i.e. including all taxes & duties, transportation, packing, forwarding etc. upto BHEL HEEP STORE Haridwar	Bidder to confirm	
3	Bidder to inform % of GST quoted in price bid		
4	<b>TEST CERTIFICATES: -</b> 3 copies of test certificates should be supplied along with the supply as per approved Quality plan/specification.	Bidder to confirm	
5	<b>GUARANTEE/WARRENTY CERTIFICATES: -</b> A warranty certificates for 18 months of trouble free performance from the date of receipt of material shall be provided along with supply	Bidder to confirm	
6	BHEL reserve the right to increase or decrease tender quantity at the time of ordering.	Bidder to confirm	
7	<b>Delivery Period</b> Bidder to quote delivery in weeks, considering 10 days for arranging inspection by BHEL at vendor works from date of email for inspection.  Bidders are requested to quote the best delivery meeting the delivery requirements. BHEL reserves the right to reject the offers not meeting BHEL's delivery requirement.	Bidder to Inform	Delivery Period in weeks
8	<b>Price Validity</b> Bidder to confirm their price validity for 120 days from the date of Part-1 opening of tender.	Bidder to confirm	
9	<b>Price Basis</b> Bidder to confirm that prices have been quoted on FOR BHEL Haridwar basis inclusive of packing ,forwarding & Freight.	Bidder to confirm	
10	<b>Payment term</b> <ul style="list-style-type: none"> <li>• BHEL's standard payment term is <b>Payment after receipt and acceptance of materials</b> / items at HEEP, BHEL-Store. 100% payment along with taxes, freight &amp; insurance will be made after receipt and acceptance of material and within 75 days from the date of invoice subject to submission of non-discrepant documents within 15 days of supply as per terms and conditions of Purchase Order. In case any discrepancy found in the documents, BHEL will notify the same to vendor within 7 days of receipt. Vendor has to clear all the discrepancies in one go within 7 days thereafter else the payment of vendor may get delayed.</li> <li>• BHEL reserves the right to accept or reject the offer of the bidder who quotes the payment term other than BHEL's standard payment term.</li> <li>• Loading on account of deviation in payment terms shall be done as per extant rules of BHEL-Haridwar on bidder's offered prices.</li> <li>• The loading criteria for the different payment terms shall be as per BHEL's GISTC (<b>General Instructions and Standard Terms &amp; Conditions</b>).</li> </ul>	Bidder to quote payment term	
11	<b>Bank Charges</b> Please confirm that Bank charges shall be either side. If the documents are submitted directly to BHEL, Haridwar, all bank charges shall be borne by vendor.	Bidder to confirm	

Bidder Sign &amp; Stamp

**Tender No: E/ E242/2/0281C1****Annexure-4**

12	<p><b>Firm &amp; Fixed Price</b></p> <p><b>Please confirm that prices shall be firm and fixed till execution of contract.</b> Please note no revision in the prices or submission of supplementary price bid will be allowed during the validity of the offer. However if there is any change by BHEL w.r.t. original specifications/ requirement/ scope/terms and conditions, the bidders may be asked by BHEL to submit only the price impact bid for such changes only.</p>	Bidder to confirm	
13	<p><b>Transit Insurance</b></p> <p>Transit Insurance will be arranged by BHEL. Please send your offer keeping this in view.</p>	Bidder to confirm	
14	<p><b>Taxes &amp; Duties</b></p> <p>Applicable taxes and duties during the dispatch of material should be quoted separately in your offer. If nothing is mentioned in offer, same would be deemed included in the quoted price. Kindly confirm.</p>	Bidder to Inform	
15	<p><b>Deviation</b></p> <p>Confirm that there is no deviation with respect to BHEL Specifications &amp; GISTC. However, deviations, if any, are to be listed as a separate attachment. The offers that do not meet the substantial requirements of our enquiry are liable to be ignored. The bidders shall be deemed to comply with all the requirements of bidding documents except for listed deviations without any extra cost irrespective of any mention to the contrary anywhere else in the bid.</p>	Bidder to confirm	
16	<p><b>LD for Late delivery</b></p> <p>Liquidated Damages (LD) for Late Deliveries shall be applicable @0.5% per week or part thereof on the value of respective delayed supplies subject to a maximum of 10% of the value of respective delayed supplies. Value of delayed supplies will mean the Gross Value payable to the vendor (Before LD) against such supplies excluding taxes and duties. Date of Receipt of material at BHEL Haridwar Shall be treated as date of delivery for penalty purpose. In case of non –acceptance to LD clause, bidder’s offer will get loaded up to maximum 10 % to decide L1. BHEL reserves the right to reject the bidder’s offer.</p>	Bidder to confirm	
17	<p><b>RISK PURCHASE.</b></p> <p>Bidder to confirm that they have read the risk purchase clause as per BHEL’s GISTC and acceptable to them.</p> <p>If bidder does not agree to the said Risk Purchase Clause in GISTC, BHEL reserves the right to reject the offer.</p>	Bidder to confirm	
18	<p><b>Force Majeure.</b></p> <p>Bidder to confirm that they have read the force majeure clause as per BHEL’s GISTC and acceptable to them.</p> <p>If bidder does not agree to the said Risk Purchase Clause in GISTC, BHEL reserves the right to reject the offer.</p>	Bidder to confirm	
19	<p><b>Settlement of dispute / Arbitration</b></p> <p>The seat &amp; venue of arbitration shall be Haridwar as per BHEL’s GISTC.</p>	Bidder to confirm	
20	<p><b>Pre-Qualification Requirement (PQR)</b></p> <p>The Pre-Qualification Requirements have been compiled and placed at ANNEXURE-A. All the bidders should ensure submission of complete details and documents as called for in these requirements. The Offers submitted by the bidders would be scrutinized with respect to Pre-Qualification Requirements first. Techno-Commercial offer of only those bidders shall be evaluated who meet the Pre-Qualification Requirements. All documents / information required as per PQR should be signed by the bidder and submitted in the manner a prescribed in the ANNEXURE-A.</p>	Bidder to confirm	
21	<p><b>Evaluation</b></p> <p>Evaluation will be done on the basis of Total Landed Cost to BHEL Haridwar matcode wise</p>	Bidder to confirm	

Bidder Sign &amp; Stamp

**Tender No: E/ E242/2/0281C1**

**Annexure-4**

22	<b>BHEL Registration</b> Online Registration Portal is operational in BHEL. Bidders not registered at BHEL, Hardwar for this item; have to apply through Online Registration portal, <a href="https://supplier.bhel.in/">https://supplier.bhel.in/</a> . All credentials and/or documents duly signed and stamped related to registration has to be uploaded on the website and the application submitted for registration. Application registration No (for applying online form) should be mentioned in the techno commercial offer	Bidder to confirm	
23	<b>Pre-dispatch Inspection</b> Inspection shall be done by BHEL OR Nominated Inspection agency, at supplier's work.  <b>Inspection charges is in BHEL's scope.</b>	Bidder to confirm	
24	Bidder to submit Quality plan for approval as per QP format attached with this tender	Bidder to confirm	
25	Seller should take into account 10 days for inspection from the date of intimation for inspection and quote their delivery period accordingly.	Bidder to confirm	
26	<b>GISTC</b> Please confirm compliance to enclosed "General Instructions and Standard Terms & Conditions for bidding against Tender Enquiry (GISTC)" and submit a signed and stamped copy of the same along with offer.	Bidder to confirm/ Submit signed GISTC	
27	<b>Terms and condition as per Annexure -4 shall supersedes any term and condition written in bidders offer.</b>	Bidder to confirm	

Annexure – D  
Quality Plan

