



**BHARAT HEAVY ELECTRICALS LIMITED  
CENTRALISED STAMPING UNIT & FABRICATION  
PLANT, Jagdishpur**

**TENDER FOR ENHANCING THE 11 KV POWER SUPPLY  
AND IT'S DISTRIBUTION INCLUDING PROVIDING,  
INSTALLING, COMMISSIONING OF SUB STATION AND  
IT'S EQUIPMENTS ON TURNKEY BASIS AT  
JAGDISHPUR**

**Tender Enquiry No: BHE/FP/CVL/026**

**CONTENTS**

<b>SECTION – I:</b>	<b>NOTICE INVITING TENDER</b>
<b>SECTION - II:</b>	<b>GENERAL CONDITIONS OF CONTRACT</b>
<b>SECTION - III:</b>	<b>SPECIAL CONDITIONS OF CONTRACT</b>
<b>SECTION - IV:</b>	<b>BILL OF QUANTITIES &amp; PRICE SCHEDULE</b>
<b>SECTION - V:</b>	<b>TECHNICAL SPECIFICATION</b>

**BHARAT HEAVY ELECTRICALS LIMITED  
(A GOVERNMENT OF INDIA UNDERTAKING)  
CSU & FP  
Industrial Area  
Jagdishpur (UP) 227817**

**TENDER FOR ENHANCING THE 11 KV POWER SUPPLY  
AND IT'S DISTRIBUTION INCLUDING PROVIDING,  
INSTALLING, COMMISSIONING OF SUB STATION AND  
IT'S EQUIPMENTS ON TURNKEY BASIS AT  
JAGDISHPUR**

**Tender Enquiry No: BHE/FP/CVL/026**

THIS TENDER SPECIFICATION ISSUED TO:

M/S

---

---

---

---

---

**SECTION - I****NOTICE INVITING TENDER****Tender Enquiry No: BHE/FP/CVL/026**

1. Sealed Tenders are invited for the following work from reputed contractors who meet the Qualification Requirements.

Nature of work	Earnest money deposit (Rs)	Issue of Tender Documents	Tender submission date & time	Tender opening date & time
TENDER FOR ENHANCING THE 11 KV POWER SUPPLY AND IT'S DISTRIBUTION INCLUDING PROVIDING, INSTALLING, COMMISSIONING OF SUB STATION AND IT'S EQUIPMENTS ON TURNKEY BASIS AT JAGDISHPUR	150000 (Rs one Lakh fifty thousand only)	From 04/09/2010 to 25/09/2010	Up to 14:00Hrs on 25/09/10 through post/Courier or by hand in tender box at BHEL, CSU & FP Jagdishpur	<b>Techno-Commercial Bid on:</b> 25/09/10 at 15:00 Hrs at BHEL, CSU & FP Jagdishpur

Cost of Tender Documents (non- refundable): Rs 1000/- (Rs One Thousand Only)

2. Address for purchase, submission & opening of Tender

a) **Purchase , submission and opening of tender:**

Sh Vaibhav Jain, Engineer (Civil-Planning)  
Centralised Stamping Unit (CSU) & Fabrication Plant (FP)  
Bharat Heavy Electricals Limited  
Jagdishpur Industrial Area  
Jagdishpur  
Distt Sultanpur (UP) 227 817

Tel : 05361 270057  
Fax : 05361 270057  
Email: [vjain@bhelepd.com](mailto:vjain@bhelepd.com)  
[ramnik@bhelepd.com](mailto:ramnik@bhelepd.com)

And

BB) By hand in the tender box located at BHEL, CSU & FP, Jagdishpur (U.P.)

3. Tender documents may be obtained from the above office by submitting an application and cost of tender documents by Demand Draft (in favour of Bharat Heavy Electricals Ltd payable at Industrial area Jagdishpur or, at Lucknow). Courier charges will be Rs 500 extra if documents are requested through courier.
4. Tender documents may be obtained from the above office by submitting an application and cost of tender documents by Demand Draft (in favour of Bharat Heavy Electricals Ltd payable at **Industrial area Jagdishpur** or, at **Lucknow**). Courier charges will be Rs 500 extra if documents are requested through courier.
5. Bidders may also download the tender documents from the web page of BHEL ([www.bhel.com](http://www.bhel.com)) and use the documents for submission of tender. In such cases, the cost of tender documents shall have to be paid by Demand Draft at the time of submission of offer.
6. BHEL takes no responsibility for any delay / loss of documents or correspondence sent by courier or post.
7. The Earnest Money Deposit shall be paid by a Demand Draft in favour of Bharat Heavy Electricals Limited, payable at Industrial Area Jagdishpur or, at Lucknow along with the bid in separate sealed envelop.
8. The offer is to be submitted in a sealed envelope properly marked .The tender shall be submitted in two parts. The first part shall consist of the techno-commercial offer without price schedule and marked on top of the envelope as "Part I -Techno-commercial Bid" along with tender enquiry no. and due date. The second part shall be the price schedule and marked on top of the envelope as "Part II - Price Bid" along with tender enquiry no and due date. Each part shall be in a separate sealed envelope. Both the parts shall then be put in a bigger sealed envelope. The tender enquiry no. & due date of opening must be clearly mentioned on top of the envelope.
9. Part I of the bid will be opened first and scrutinized. Successful bidders in techno-commercial bid Part – I will only be considered for opening of Price Schedule i.e. Part – II. Date of opening of Price Bid will be intimated separately to the Tenderers who qualify in the Techno-Commercial bid.
10. Offers should be strictly in accordance with the tender specifications & General Instructions to the Tenderer enclosed herewith.
11. Only Tenderers who have previous experience in the work of the nature and description detailed in this tender specification are expected to quote for this work. Offer from Tenderer who do not have proven and established experience in the field as per Annexure NIT – I will not be considered.
12. Tenderers are advised to go through the project scope of work, site location etc and get themselves fully acquainted with the work place and prevailing working conditions before submitting the Offer.
13. The Tenderer should accept all terms & conditions of the tender unconditionally. In case the Tenderer wants to deviate from the tender conditions, such

- deviations shall be clearly specified in the offer. If no deviations are given in the offer, it will be assumed that the Tenderer accepts all terms and conditions of the tender.
14. Offers with deviations from terms and conditions of this tender are likely to be rejected.
  15. Clarifications, if any, of Technical / Commercial nature, can be obtained from the officer to whom the tender is to be submitted or from following office at the following address up to one week before the tender due date.

**Sh Ramnik Sarbahi, Dy GM/ Projects**

Centralised Stamping Unit (CSU) & Fabrication Plant (FP)  
Bharat Heavy Electricals Limited  
Jagdishpur Industrial Area  
Jagdishpur  
Distt Sultanpur (UP) 227 817

Tel : 05361 270057  
Fax : 05361 270057  
Email:1) ramnik@bhelepd.com  
2) ramnik\_sarbahi@yahoo.com

16. The Tenderers are required to quote for the complete scope of work with rates for all the items & no column should be left blank. Tenders for part of the work or incomplete in any respect are liable to be rejected. Tenders shall certify in the Techno- commercial bid that rates for all the items have been quoted.
17. Order will be placed on a single bidder for the complete scope of work.
18. Penalty will be levied by BHEL as per relevant clauses of the Tender on account of delay, violation of contract conditions and non-performance of the Contractor.
19. All documents submitted by the Tenderer in his offer shall be accompanied with a covering letter giving index interlinking all the documents.
20. BHEL reserves the right to accept or reject any of the bid / all bids with or without deviation or cancel / withdraw the invitation for bid without assigning any reason whatsoever and in such case no bidder shall have any claim arising out of such action by BHEL.
21. BHEL reserves the right to reject the tender from any bidder on the basis of unsatisfactory performance of the bidder in any ongoing job or any similar job of BHEL in last five years, or if the bidder has been kept under hold/ blacklisted by BHEL.
22. BHEL reserves the right to go for Reverse Auction (on line bidding on Internet) instead of opening the submitted sealed paper price bid as per CI 35 of part-B of GCC. Any bidder who do not accept the processing of price bids through Reverse Auction as per point-18 of Annex-E (checklist) of GCC are liable for rejection.

**23. Mobilisation Advance :**

23.1 Interest bearing mobilisation advance can be accepted by BHEL on request of the contractor limited to a maximum of 5% of the contract value . Such mobilisation advance shall be payable after acceptance of order and submission of contract security deposit. The mobilisation advance shall be interest bearing and secured through bank guarantee of 1.2 times of advance amount valid for 12 months initially and thereafter extension for a period upto which the advance is fully adjusted not exceeding the completion schedule. (Ref para 16.9 of SCC)

For & on behalf of BHEL  
Engineer (Civil-Planning)

**Annexure NIT – I****TENDER FOR ENHANCING THE 11 KV POWER SUPPLY AND  
IT'S DISTRIBUTION INCLUDING PROVIDING,  
INSTALLING, COMMISSIONING OF SUB STATION AND IT'S  
EQUIPMENTS ON TURNKEY BASIS AT JAGDISHPUR****A. QUALIFICATION REQUIREMENTS**

1. The tenderer should have, in the last seven years ending on 31-03-10, successfully completed the supply, installation, testing and commissioning of complete sub station of 11 KV including drawing/ distributing power from the power centre for industrial plant / buildings , infrastructural projects or other commercial establishments and multistory appartments. Values of such work done should be as under:
  - a) One job of value of Rs 79 Lakh or above, or
  - b) Two jobs of value of Rs 49 Lakh or above each, or
  - c) Three jobs of value of Rs 40 Lakh or above each

And

The Tenderer shall be financially sound and should have achieved an average annual financial turnover of minimum Rs 30 Lakh per year over three consecutive financial years ending on 31.03.2010.

2. Tenderer should have successfully completed the engineering, supply, installation, testing of supply, installation, testing and commissioning of complete sub station of 11 KV including drawing/ distributing power from the power centre for industrial plant / buildings , infrastructural projects or other commercial establishments and multistory appartments of upto 500 KVA capacity minimum during last seven years.
3. The manufacturer whose equipments are quoted by the bidder should be an equipment manufacturer or licensee dealer/ service provider of the equipment manufacturer and should be in the business of similar field for atleast three years as on 31.03.2010

**B. DOCUMENTS REQUIRED**

The Tenderer shall submit documents in respect of possessing Qualifying requirements as under duly certified and stamped by his authorised signatory:

- a) List of Jobs undertaken with details and value meeting the above conditions.
- b) Copies of work orders issued by customers.
- c) Copies of completion certificates issued by customers.
- d) Copies of audited profit and loss accounts accompanied by relevant schedules for turnover figures.



**BHARAT HEAVY ELECTRICALS LIMITED  
CENTRALISED STAMPING UNIT &  
FABRICATION PLANT  
Jagdishpur**

**TENDER FOR ENHANCING THE 11 KV POWER  
SUPPLY AND IT'S DISTRIBUTION INCLUDING  
PROVIDING, INSTALLING, COMMISSIONING OF SUB  
STATION AND IT'S EQUIPMENTS ON TURNKEY BASIS  
AT JAGDISHPUR**

**Tender Enquiry No: BHE/FP/CVL/026**

**SECTION II**

**GENERAL CONDITIONS OF CONTRACT**

**BHARAT HEAVY ELECTRICALS LIMITED  
(A GOVERNMENT OF INDIA UNDERTAKING)  
CSU & FP  
Industrial Area  
Jagdishpur (UP) 227817**

**SECTION II**  
**GENERAL CONDITIONS OF CONTRACT**

INDEX

SL. NO.	CONTENTS
1	Part A General Instructions to Tenderers
2	Part B General terms & conditions
3	Part C Terms and Conditions for Civil, Structural and Architectural Works
4	Annexure - A Proforma – Financial Viability
5.	Annexure- B Proforma – Non- Discloser agreement
6	Annexure - C Proforma – Analysis of similar jobs executed
7	Annexure - D Proforma – Declaration Sheet
8	Annexure - E Check list & schedule of General Particulars
9	Annexure - F Proforma – Contract Agreement
10	Annexure- G Proforma- Security cum performance BG bond
11	Annexure-H Proforma – Month wise manpower deployment plan
12	Annexure-I Proforma- Status of T & Ps and deployment plan
13.	Annexure- J Proforma- Knowledge of site conditions
14.	Annexure- K Proforma- Details of court cases pending against BHEL
15.	Annexure- L List of Consortium Banks

**SECTION- II****PART – A****GENERAL INSTRUCTIONS TO TENDERERS**

- 1 This tender specification as a whole, furnishing all the details and other documents as required in the following pages, shall be duly signed and sent in a sealed cover (IN DUPLICATE) super-scribing the name of work as given in the tender notice.
- 2 The tender shall be addressed to the OFFICER INVITING TENDER AS INDICATED IN THE TENDER NOTICE.
- 3 Tenders submitted by post shall be sent as "REGISTERED POST ACKNOWLEDGEMENT DUE" and shall be posted with due allowance for any postal delay. The tenders received after the due date and time of opening are liable to be rejected. Telegraphic offers and offers received by telex may not be considered. BHEL takes no responsibility for any delay/loss of documents or correspondences sent by carrier/ post.
- 4 Tenders shall be opened at the time and date as specified in the tender notice in the presence of such of those tenderers or their authorised representatives who may be present.
- 5 The tenderers shall closely peruse all the clauses, specifications and drawings indicated in the Tender Documents before quoting. Should the tenderer have any doubt about the meaning of any portion of the Tender Specifications or find discrepancies / omission in the Drawings or the tender documents issued are incomplete or shall require clarification on any of the technical aspect, scope of work etc., he shall at once contact the authority inviting the tender for clarification before the submission of the tender.
- 6 Before tendering, the tenderers are advised to inspect the site of work and the environments and be acquainted with the actual working and other prevalent conditions, facilities available, position of material and labour. No claim will be entertained later on grounds of lack of knowledge.
- 7 Tenderer must fill up all the schedules and furnish all the required information as per the instructions given in various sections of the tender specification. Each and every page of the Tender Specification must be SIGNED, STAMPED AND SUBMITTED ALONG WITH THE OFFER by the Tenderer in token of complete acceptance thereof. The information furnished shall be complete by itself.
- 8 The Tenderer shall quote the rates in English Language and international numerals. These rates shall be entered in figures as well as in words. In case of difference in rates between words and figures THE LESSER OF THE TWO will be treated as valid rate. The "amount" column shall be the arithmetic multiplication of "quantity" and the "rate quoted" of each row. For the purpose of tender, the metric system of units shall be used. Both the blank columns of bill of quantities(BOQ), titled "Rates" and "Amount" as well as the total and grand total at the last page of the BOQ has to be filled by the Tenderer in legible and neat handwriting or typed. All totals shall be given both in words as well as in

figures. In case of any discrepancy in the quoted "Grand Total" of the Price schedule and BOQ , the correct arithmetic total shall be considered.

- 9 All entries in the tender shall either be typed or be written in ink. Erasure and over writings are not permitted and may render such tenders liable to summary rejection. All cancellations and insertions shall be duly attested by the tenderer.
- 10 QUALIFICATIONS OF TENDERERS:** Only Tenderers who have previous experience in the work of this nature and description detailed in this tender specification at section "Qualifying requirements" are expected to quote for this work. Offers from tenderers who do not have proven and established experience in the field are not likely to be considered.
- 11 DATA TO BE ENCLOSED:** Full information shall be given by the tenderer in respect of the following. Non-submission of this information may lead to rejection of the offer.
- 11.1 FINANCIAL STATUS:** Financial viability as per proforma enclosed at **ANNEXURE-`A`**
- 11.2 INCOME TAX CERTIFICATES:** A Certificate of Income tax clearance from the appropriate authority in the forms prescribed there for duly indicating annual turnover. These certificates shall be valid for one year from the date of issue or for the period prescribed therein for all tenders submitted during the period. Copy of last assessment order duly certified as true copy by the chartered accountant shall also be submitted.
- 11.3 PREVIOUS EXPERIENCE :** A statement giving particulars (duly supported by documentary evidence) of the various service rendered in progress for each similar works by the tenderer indicating the particulars and value of each work, the site location, the duration, date of completion etc., strictly as per proforma enclosed at **ANNEXURE-C.**
- 11.4 An attested copy of the **Power of Attorney**, in case the tender is signed by an individual other than the sole Proprietor, shall also be attached.
- 11.5 Information on type of holding details of the Tenderer's organization shall be submitted as follows:  
**IN CASE OF FIRMS WITH SOLE OWNERSHIP:** Full name, experience and address of the proprietor and nature of business.  
**IN CASE OF PARTNERSHIP FIRMS:** The names of all the partners with addresses and their experience. A copy of the partnership deed/ instrument of Partnership duly certified by a Notary Public shall be enclosed.  
**IN CASE OF COMPANIES:** Date and place of registration including date of commencement certificate in case of public companies and the nature of business carried or by the Company. Certified copies of memorandum and Articles of Association are also to be furnished. Also indicate names, addresses and experience of the Directors.
- 11.6** Declaration sheet as per proforma enclosed at **ANNEXURE-`D`.**
- 11.7** Checklist and schedule of general particulars duly filled in, signed and stamped as per **ANNEXURE-`E`.**

- 11.8** Details of pending court cases, if any, between the Tenderer and any unit of BHEL as per **Annexure 'K'**.
- 11.9** In addition to the above, the particulars required elsewhere in tender documents including **Annexure- 'B' 'H', 'I', 'J'**.
- 11.10** Submission of documents pertaining to **PAN no, Service tax and sales tax registration nos. , Tin No., ESI regn. Nos ,PF regn. No., contract labour license and electrical contractor license** etc are mandatory, failing which the tenders are liable for rejection.

**NOTE** :In terms of clauses 11.1 to 11.10 above, all the data required to be enclosed with the tender need to be furnished neatly typed, signed and stamped in the given formats only (in the form of separate sheets) failing which the tender may be considered as incomplete and is liable for rejection. Documentary proofs wherever necessary also need to be enclosed.

**12 EARNEST MONEY DEPOSIT:**

- 12.1.1** Every tender must be accompanied by the prescribed amount of refundable, non-interest bearing Earnest Money Deposit. The amount of EMD and the manner in which it is to be deposited shall be as per Notice Inviting Tender.
- 12.2** Tenders received without Earnest Money in full in the manner prescribed above will not be considered.
- 12.3** The Earnest Money Deposit of the successful Tenderer will be retained towards part of Security Deposit.
- 12.4** In the case of unsuccessful tenderers, the Earnest Money will be refunded to them after acceptance of award of work by successful tenderer.
- 12.5** BHEL reserves the right of **forfeiture of Earnest Money deposit** in case the successful tenderer,
- (a) After opening of tender, revokes/ withdraws his tender within the validity period or revises/ alters his earlier quoted rates/ conditions.
  - (b) Fails to communicate unqualified acceptance of Letter of Intent within 15 days from the date of issue of Letter of Intent.
  - (c) Fails to submit 50% of the total Security Deposit before start of work.
  - (d) Fails to start the work as may be indicated in the Letter of Intent.
- 12.6** EMD shall not carry any interest.

**13 AUTHORIZATION AND ATTESTATION:** Tenders shall be signed by persons duly authorised / empowered to do so. Certified copies of such authority and relevant documents shall be submitted along with the tenders.

**14 VALIDITY OF OFFER:** The offer shall be kept open for acceptance for a minimum period of **SIX MONTHS** from the date of opening of tenders. In

case Bharat Heavy Electricals Limited calls for negotiations, such negotiations shall not amount to cancellation or withdrawal of the original offer which shall be binding on the tenderers.

**15 EXECUTION OF CONTRACT:** The successful Tenderer's responsibility under this Contract commences from the date of issue of the Letter of Intent by Bharat Heavy Electricals Limited. The successful tenderer shall be required to execute an agreement in the prescribed form as per **ANNEXURE-'F'** with the BHEL within a reasonable time after the acceptance of his tender and in any case before submitting the first bill for payment. The expenses for completion and making required number of copies and compilation of Contract Documents duly bound / titled and stamping / registration of the agreement with prescribed authority, if necessary, shall be borne by the contractor.

**16 SECURITY DEPOSIT :** Upon acceptance of tender, the successful tenderer must deposit the required amount of security deposit within the time specified in the Letter of Intent for satisfactory completion of work.

16.1 The total amount of Security Deposit shall be as follows:

(a) In case of work costing up to Rs 10 Lakh: SD shall be 10% of the contract value.

(b) In case of work costing Rs.10 Lakh and up to Rs.50 Lakh: SD shall be Rs 1 Lakh + 7.5 % of the contract value exceeding Rs 10 Lakh.

(c) In case of work costing more than Rs.50 Lakh: SD shall be Rs 4 Lakh + 5 % of the contract value exceeding Rs 50 Lakh.

16.2 The Security Deposit shall be deposited within 15 days from the date of issue of Letter of Intent but before start of work in any one of the following forms:

(a) The total Security Deposit as indicated in the Letter of Intent in cash (as permissible under income tax act) or demand draft in favour of BHEL payable at Lucknow or industrial area Jagdishpur.

(b) Bank guarantee from named banks listed in Annexure-L of GCC . The Bank guarantee format should have the approval of BHEL. However, BHEL reserves the right to accept bank guarantee issued by any other scheduled banks.

(c) 50% in cash (as permissible under income tax act) or demand draft in favour of BHEL payable at Lucknow or industrial area Jagdishpur, and the balance 50% in the form of Bank Guarantee in the prescribed proforma as per **Annexure 'G'**.

(d) 50% in Bank Guarantee in the prescribed proforma as per **Annexure 'G'**. And the balance 50% shall be recovered by deductions from running bills @ 10% of the value of each running bill, till the full Security Deposit is made up.

The validity of the Bank Guarantee furnished towards Security Deposit under (b) above shall be up to the period of completion of work as stipulated in the Letter of Intent + 2 (TWO) months and the same shall be kept valid by proper renewal till the satisfactory completion of the Guarantee Period. The bank guarantee issued by any of the consortium banks of BHEL (list given in **Annexure L**) only will be accepted.

- EMD of the successful tenderer shall be converted and adjusted against the security deposit.
- 16.3 If the value of the work done at any time exceeds the accepted agreement value, the Security Deposit shall be correspondingly enhanced and the extra Security Deposit shall be immediately deposited by the Contractor or recovered from payments due to him.
- 16.4 Failure to deposit the Security Deposit within the stipulated time, may lead to forfeiture of Earnest Money Deposit and Cancellation of the award of work.
- 16.5 BHEL reserves the right of **forfeiture of Security Deposit** in addition to other claims and penalties in the event of the contractor's failure to fulfill any of the contractual obligations or in the event of termination of contract as per terms and conditions of contract. BHEL reserves the right to set off the Security Deposit, against any claims of any other contracts with BHEL.
- 16.6 RETURN OF SECURITY DEPOSIT :** If the contractor fully performs and completes the work in all respects to the entire satisfaction of BHEL and presents an absolute "**No Demand Certificate**" in the prescribed form and returns properties belonging to BHEL taken, borrowed or hired by him for carrying out the said works, half the amount of Security Deposit will be released to the contractor after deducting all costs, expenses and other amounts that are to be paid to BHEL under this or other contracts entered into with the Contractor along with the final bill. Balance half of the amount of Security Deposit will be released only after the Guarantee Period is over.
- 17 No interest** shall be payable by BHEL on Earnest Money Deposit, Security Deposit or on any moneys due to the contractor.
- 18 EVALUATION AND REJECTION OF TENDER AND OTHER CONDITIONS:**
- 18.1 The acceptance of Tender will rest with BHEL which does not bind itself to accept the lowest tender or any tender and reserves to itself full rights for the following without assigning any reasons whatsoever.
- (a) To reject any or all of the tenders.
- (b) To split up the work amongst two or more Tenderers.
- (c) To award the work in part.
- (d) In either of the contingencies stated in (b) and (c) above to modify the time for completion suitably.
- 18.2 Conditional and un-witnessed tenders, tenders containing absurd or unworkable rates and amounts, tenders which are incomplete or otherwise considered defective and tenders not in accordance with the tender conditions, specifications etc., are liable to be rejected.
- 18.3 If a tenderer expires after the submission of his tender or after the acceptance of his tender, BHEL may at its discretion, cancel such tender. If a partner of a firm expires after the submission of the tender or after the acceptance of the

- tender, BHEL may cancel such tender at its discretion unless the firm retains its character.
- 18.4 BHEL will not be bound by any Power of Attorney granted by the tenderer or by changes in the composition of the firm made subsequent to the execution of the contract. BHEL may, however, recognise such Power of Attorney and changes after obtaining proper legal advice, the cost of which will be chargeable to the contractor concerned.
- 18.5 If the tenderer deliberately gives wrong information in his tender, BHEL reserves the right to reject such tender at any stage or to cancel the contract, if awarded and forfeit the Earnest Money/ Security Deposit/ any other moneys due.
- 18.6 Canvassing in any form in connection with the tender is strictly prohibited and the tenders submitted by the contractor who resorts to canvassing are liable to be rejected.
- 18.7 Should a tenderer or contractor or in the case of a firm or Company of contractors/ one or more of its Partners/ share holders / Directors have a relation or relations employed in BHEL, the authority inviting tender shall be informed to the fact along with the offer, failing this BHEL may, at its sole discretion reject the tender or cancel the contract and forfeit the Earnest Money/ Security Deposit
- 18.8 The successful tender should not sub-contract the part or complete work detailed in the tender specification without written permission of BHEL. The tenderer is solely responsible to BHEL for the work awarded to him.
- 19.0 BHEL reserves its right to give purchase preference to CPSUs as per Govt. Guidelines and as per rules in vogue.
- 18.9 NO DEVIATIONS** to the tender conditions will normally be accepted. However, if the tenderer insists for certain deviations to the conditions, financial implication thereof shall be loaded to the quoted price for evaluating the Tenderer's offer.

X-X-X

**SECTION - II****PART – B****GENERAL TERMS AND CONDITIONS****19.0 DEFINITION OF TERMS**

Throughout the Tender Documents including the Enquiry Letter, the following words shall have the meanings assigned to them herein, unless the subject matter or the context requires otherwise.

- 19.1 The '**Purchaser**' or '**BHEL**' shall mean Bharat Heavy Electricals Limited (A Govt. of India Undertaking) incorporated under the Companies Act 1956, with its Registered Office at BHEL House, Siri Fort, New Delhi-110 049, which expression shall include its successors and assigns; acting through its Fabrication Plant (FP), or its authorised officers or its Engineer or other employees authorised to deal with any matters with which these persons are concerned, on its behalf.
- 19.2 The '**Tenderer**' shall mean the Firm/Company/Organisation, which quotes against the Tender Enquiry issued by the Purchaser. It may also be referred as '**Bidder**'.
- 19.3 The '**Contractor**' shall mean the individual, firm or company whose Offer is accepted by BHEL and enters into Contract with BHEL and shall include their executors, administrators, successors and permitted assigns.
- 19.4 The '**Contract**' shall mean and include the agreement, the work order, the accepted appendices of rates, Schedules of Quantities, if any, General Conditions of Contract, Special Conditions of Contract, Instructions to Tenderers, the drawings, the technical specifications, the special specifications, if any, the tender documents and the Letter of Intent/ Acceptance letter issued by BHEL. Any conditions or terms stipulated by the Tenderer in the tender documents or subsequent letters shall not form part of the Contract unless specifically accepted in writing by BHEL in the Letter of Intent and incorporated in the Agreement. It may also be referred as '**Contract Document**'.
- 19.5 The '**Sub-contractor**' shall mean the person/firm/company/organisation to whom any part of the work has been sub-contracted by the Supplier, with the written consent of the Purchaser and shall include his heirs, executors, administrators, representatives and assigns.
- 19.6 The '**Engineer**', for the purpose of this Contract shall mean an engineer, person or company duly appointed as such from time to time or such other officials as may be duly authorised and appointed and notified in writing by purchaser to act as engineer. In cases where no such Engineer has been so appointed, the word 'Engineer' shall mean the Purchaser or his duly authorised representative. It may also be referred to as **Engineer –in –Charge**.

- 19.7 The '**Inspector**' shall mean the Purchaser for the time being or such other person as may be duly authorised and appointed in writing by Purchaser to act as Inspector for the purpose of Contract.
- 19.8 The '**Equipment**' shall mean and include plant and stores on which work is to be done by the Contractor under the Contract.
- 19.9 The '**Work**' shall mean and include supply of all categories of labour, specified consumables, tools and tackles required for complete and satisfactory construction, site transportation, handling, stacking, storing, erecting, testing and commissioning of the equipment; as defined in the Tender Documents, to the satisfaction of BHEL. It may also be referred as '**CONTRACT WORK**'.
- 19.10 The '**Tender Document**' shall mean and include the instruction to Tenderers, general conditions, bidding conditions, specific conditions, specifications, schedules, drawings, form of tender, schedule of prices and quantities, contained in the Tender and any subsequent modifications thereof.. It may also be referred as '**Tender Specification**'
- 19.11 The '**Offer**' shall mean and include the technical and commercial documents including specifications, schedule of prices and quantities, drawings etc submitted by the Tenderer in response to the tender enquiry and any subsequent clarifications thereof. It may also be referred as '**Bid**'.
- 19.12 '**Acceptance of offer**' shall mean issue of letter of intent/award or memorandum or detailed Order/Contract communicating the acceptance of offer, to the successful Tenderer.
- 19.13 The '**Letter Of Intent**' shall mean the intimation by a letter / fax to the Tenderer that the tender has been accepted in accordance with provisions contained in the letter. The responsibility of the contractor commences from the date of issue of this letter and all the terms and conditions of contract are applicable from this date.
- 19.14 The '**Site**' shall mean the site of the proposed work at BHEL Plant at Jagdishpur.
- 19.15 The '**General Manager**' shall mean the Officer in Administrative charge of the contracting Unit of BHEL.
- 19.16 The '**Completion Time**' shall mean the period specified in the Letter of Intent or date mutually agreed upon for completing the work to the satisfaction of the Engineer, being of required standard and conforming to the specifications of the Contract.
- 19.17 The '**Tests**' shall mean and include such test or tests to be carried out by the Contractor as are prescribed in the Contract or considered necessary by BHEL in order to ascertain the quality, workmanship, performance and efficiency of the contracted work or part there of.
- 19.18 The '**Commissioning**' shall mean the first operation of the equipment after all initial adjustments, trials, cleaning and re-assembly required at site, if any, have been completed and equipment is made ready for commercial use.

- 19.19 The **'Approved', 'Directed' Or 'Instructed'** shall mean approved, directed or instructed by BHEL.
- 19.20 **'Contract Engineer'** shall mean the official who has signed the Order/Contract on behalf of the Purchaser.
- 19.21 **'Months'** shall mean calendar months.
- 19.22 **'Days'** shall mean calendar days.
- 19.23 **'Writing'** shall include any manuscript, typewritten or printed statement under or over signature, seal as the case may be.
- 19.24 **"Contract Value"** shall mean the awarded/ executed value of work calculated on the basis of the awarded/ executed quantities of work and the approved /accepted rates by BHEL.

The words incorporating singular shall include plural and vice-versa, in the words importing masculine gender shall include feminine and vice-versa and the words importing persons shall include bodies corporate, limited liability companies, partnership and other legal entities.

## **20.0 TWO PART BIDS:**

- 20.1 Bidders shall submit the offer in three inner envelops (covers) and one outer envelop (cover) as indicated below.

**Envelope I:** This sealed envelope should contain all the copies of technical & commercial bid together with price formats (without prices). This envelope should be clearly marked **"Part I - Technical and commercial bid"**, indicating Tender No., Due Date and Address & Reference of the Bidder.

**Envelope II:** This sealed envelope should contain only **price formats with prices**. This envelope should be clearly marked **"Part II - Price bid"**, indicating Tender No., Due Date and Address & Reference of the Bidder.

**Envelop III:** This sealed envelop should contain Demand Draft for cost of Tender if not submitted earlier, and Demand Draft/ copy of Cash Deposit Receipt for EMD.

All the envelopes shall be put in one envelop, duly sealed, super scribed as Part I and Part II of Enquiry No., due date of opening, name & address of the officer inviting Tender and the address and reference of the Bidder.

## **20.2 Part I – Technical and Commercial Bid**

This part shall include / indicate the following:

- Complete scope of services with all technical details and other technical and commercial terms and conditions.
- Confirmation of the Technical and Commercial Specification. If there are any deviations, the same should be clearly specified in a separate sheet along with covering letter. Offers received without confirmation to our specification will be rejected.

- List of customers to whom similar services have been supplied along with performance certificates.
- A copy of "Un-Priced Part II" i.e., a copy of the Price Bid **without the price details.**

### **20.3 Part II (PRICE- BID)**

This part should contain the schedule of price particulars co-related to the Bill of Quantities.

## **21 OPENING & EVALUATION OF OFFERS AND AWARD OF WORK**

- 21.1 Authorised officer of BHEL at his office shall open tenders at the time and date as specified in the tender notice in the presence of such of those Tenderers or their authorised representative who may be present.
- 21.2 The envelop III will be opened first. Tenders received without the demand draft for cost of Tender and EMD will be rejected and Part I of Bid will not be opened.
- 21.3 The Part I - Technical & commercial bid alone would be opened on the Tender opening date.
- 21.4 The Part II - Price bid of only those Bidders who have been found to be techno-commercially suitable would be opened at a later date. These Bidders would be informed about the tender opening date.
- 21.5 Clarifications if any required by BHEL for technical and commercial evaluation may be sought from Bidders before opening of Part II - price bid.
- 21.6 In case it becomes necessary for the Tenderer to make any changes in his original price bid (Part-II) on account of technical/commercial confirmations/clarifications, against the changes advised by BHEL to bring the offer in line with the requirement of the specifications, the impact of such changes on price shall be submitted in the form of a revised price bid, if asked for by BHEL.
- 21.7 If a revised price bid has been submitted, normally only the final revised price bid shall be opened. However, BHEL reserves the right to open the earlier price bids, if required.
- 21.8 Unsolicited price bids shall not be entertained.
- 21.9 Any revision or changes in quoted prices and/or conditions of offer made after tender opening, which will give benefit to the Tenderer over others, may result in rejection of his tender.
- 21.10 Evaluation of offers shall be on the basis of cost at Site i.e. total cost to BHEL, taking into consideration loadings, if any, and all available financial advantages.
- 21.11 Deviations (Commercial as well as Technical) from the Tender Specifications are generally not acceptable. However, if any deviation is considered by the Purchaser, the same shall be loaded for comparison, while evaluating the offer.

- 21.12 Loading/loading criteria in respect of the deviation(s) shall be communicated to the concerned Tenderer(s) before Price Bid opening. If a Tenderer unconditionally withdraws any deviation before Price Bid opening, the same shall not be loaded.
- 21.13 BHEL reserves its right to allow to the Public Sector Enterprises ordering and price preference facilities as admissible under the existing policy of the Govt. of India.
- 21.14 The Purchaser shall issue a Letter of Intent for award of work to the successful Tenderer as soon as his Bid has been accepted giving brief details of the equipment and other terms & conditions.
- 21.15 The Letter of Intent/ Purchase Order shall be issued in the name of Bidder only.
- 21.16 BHEL reserves its right to negotiate with the bidder and/ or go for reverse auction.**

## **22.0 PRICES AND TERMS OF PAYMENT**

- 22.1 Prices quoted by the bidder shall be fixed and not subject to any escalation whatsoever during the period of Bid validity and execution of the Contract. A Bid submitted with an adjustable price will be treated as non -responsive and rejected.
- 22.2 Prices should be inclusive of all taxes and duties (except service tax). Service tax should be specifically stated in the offer as per section-IV i.e bill of quantities and price schedule.
- 22.3 Terms of payment shall be as given in Special Conditions of Contract.
- 22.4 All payments will be released after deduction of taxes as per the rules in force and Tax Deduction at Source (TDS) certificate will be issued by BHEL as applicable.

## **23.0 COMMENCEMENT AND COMPLETION OF WORK**

- 23.1 The contractor shall commence the work within the time indicated in the Letter of Intent and shall proceed with the same with due expedition without delay. The responsibility of successful Tenderer under this Contract commences from the date of issue of the Letter of Intent.
- 23.2 If the successful tenderer fails to commence the work within the stipulated time, BHEL, at its sole discretion, will have the right to cancel the contract. His Earnest Money and/ or Security Deposit will stand forfeited without any further reference to him without prejudice to any and all of BHEL's other rights and remedies in this regard.
- 23.3 All the works shall be carried out under the direction and to the satisfaction of BHEL.
- 23.4 The transported equipment, erected /constructed plant or work performed under the Contract, as the case may be, shall be taken over by BHEL in part or in full when it has been completed in all respects and/or satisfactorily put into operation at site. However, the work under the Contract shall be considered as completed only when the full scope of work is taken over by BHEL.

**24.0 MEASUREMENT OF WORK AND MODE OF PAYMENT**

- 24.1 All payments due to the contractor shall be made by 'Account Payee' Cheques.
- 24.2 For progress/ running bill payments, the contractor shall present detailed measurement sheets in triplicate duly indicating all relevant details based on technical documents and connected drawings for the work done during the month/ period under different categories in line with terms of payment as per Letter of Intent. The basis of arriving at the quantities/ weights shall be the relevant documents and drawings released by BHEL. These measurement sheets shall be prepared jointly with Engineer and signed by both the parties.
- 24.3 These measurement sheets will be checked by the Engineer and quantities and percentages eligible for payment under different groups shall be decided by him. The abstract of quantities and percentages so arrived at based on the terms of payment shall be entered in the **Measurement Book** and signed by both the parties.
- 24.4 Based on the above quantities, contractor shall prepare the bills in the prescribed proforma and work out the financial value. These will be entered in the Measurement Book and signed by both the parties. Payment shall be made by BHEL after affecting the recoveries due from the contractor.
- 24.5 All recoveries due from the contractor for the month / period shall be effected in full from corresponding running bills unless specific approval from Competent authority is obtained to the contrary.
- 24.6 Measurement shall be restricted to that quantity for which it is required to ascertain the financial liability of BHEL under this contract.
- 24.7 Measurement shall be taken jointly by persons duly authorised by BHEL and the Contractor.
- 24.8 The Contractor shall bear the expenditure involved, if any, in making the measurements and testing of materials to be used/ used in the work. The Contractor shall, without extra cost to BHEL, provide all the assistance with appliances and other things necessary for measurement.
- 24.9 If, at any time due to any reason whatsoever, it becomes necessary to re-measure the work done, in full or in part, the expenses towards such re-measurement shall be borne by the Contractor.
- 24.10 Passing of bills covered by such measurements does not amount to acceptance by BHEL of the completion of the work measured. Any left out work has to be completed by the Contractor, as directed.
- 24.11.1 Final measurement bill shall be prepared in the proforma prescribed for the purpose, based on the certificate issued by the Engineer that the entire work as stipulated in the tender specifications has been completed in all respects to the entire satisfaction of BHEL. The Contractor shall give unqualified 'No Claim' and 'No Demand' certificates. All the tools and tackles loaned to him should be returned in condition satisfactory to BHEL. The abstract of final quantities and financial values shall also be entered in the

Measurement Book and signed by both the parties. The final bill shall be paid within a reasonable time after completion of the work. After the payment of final bill, only the guarantee obligation percentage value shall remain unpaid which shall be released after completion of guarantee period.

## **25.0 RIGHTS OF BHEL**

**BHEL** reserves to itself the following rights in respect of this contract without entitling the contractor to any compensation.

- 25.1 To get the work done through another agency at the risk and cost of the contractor, in the event of poor progress or the contractor's inability to progress the work for completion as stipulated in the contract, poor quality of work, persistent disregard of instructions of BHEL, assignment, transfer, subletting of the contracted work without written permission of BHEL, non-fulfillment of any contractual obligations etc. and to claim / recover compensation for such losses from the contractor including BHEL's supervision charges and overheads from Security Deposit/ other dues.
- 25.2 To withdraw any portion of work and / or to restrict / alter quantum of work as indicated in the contract during the progress of work and get it done through another agency and/ or by the departmental labour to suit BHEL's commitments or in case BHEL decides to advance the completion due to other emergent reasons.
- 25.3 To terminate the contract after due notice and forfeit the Security Deposit and recover the loss sustained in getting the balance work done through other agencies in addition to liquidated damages/ penalty in the event of:
  - (a) Contractor's continued poor progress.
  - (b) Withdrawal from or abandonment of the work before completion of the work.
  - (c) Corrupt act of the contractor.
  - (d) Insolvency of the contractor.
  - (e) Persistent disregard of the instructions of BHEL.
  - (f) Assignment, transfer, subletting of the contract work without BHEL's written permission.
  - (g) Non-fulfillment of any contractual obligations.
- 25.4 To recover any moneys due from the Contractor from out of any moneys due to the Contractor under this or any other Contract or from the Security Deposit.
- 25.5 To claim compensation for losses sustained including BHEL's supervision charges and overheads in case of termination of contract and to levy penalty for delay in completion of work.
- 25.6 To determine the Contract or to restrict the quantum of work and pay for the portion of work done in case BHEL's contract with its customer is terminated for any reason.

- 25.7 To effect recoveries from any amounts due to the contractor under this or any other contract or in any other form the moneys which BHEL is forced to pay to anybody due to contractor's failure to fulfill any of his obligations.
- 25.8 To restrict or increase the quantity and nature of work to suit site requirements, since the tender specification is based on preliminary documents and quantities furnished therein are indicative and approximate and the rates quoted shall not be subject to revision.
- 25.9 To deploy BHEL's skilled and semiskilled workmen in case of emergency / poor progress/ deficiency in skill on the part of the employees of the contractor and to recover the expenditure on account of the same from the moneys due to the contractor.
- 25.10 While every endeavor will be made by BHEL to this end, BHEL cannot guarantee uninterrupted work due to conditions beyond its control. The Contractor will not be entitled to any compensation/ extra payment on this account.
- 25.11 In the event of any dispute of technical nature, the decision of BHEL shall be final and binding on the Contractor.

**26.0 RESPONSIBILITIES OF CONTRACTOR IN RESPECT OF LOCAL LAWS, EMPLOYMENT OF WORKERS, ETC.**

The following are the responsibilities of the Contractor in respect of observance of local laws, employment of personnel, payment of taxes etc.:

- 26.1 As far as possible, unskilled workers shall be engaged from the local areas in which the work is being executed.
- 26.2 The contractor at all times during the continuance of this contract, shall in all his dealings with the local labour for the time being employed on or in connection with the work, has due regard to all local festivals, religious and other customs.
- 26.3 The Contractor shall comply with all State and Central Laws, Statutory Rules, Regulations, etc., such as The payment of wages Act, The Minimum Wages Act, The workmen's Compensation Act, The Employer's Liability Act, The industrial Disputes Act, The Employees' Provident Fund Act, Employees' State Insurance Scheme, the Contract Labour (Regulations and Abolition Act, 1970) and other Acts, Rules and Regulations for labour as may be enacted by the Government during the tenure of the Contract and having force or jurisdiction at site. The contractor shall give to the local Governing Body, Police and other concerned Authorities all such notice as may be required under law.
- 26.4 The Contractor, in the event of his engaging 20 or more workmen, will obtain independent license under the Contract Labour (Regulations and Abolition Act, 1970) from the concerned authorities based on the certificate (Form-V) issued by the principal employer.
- 26.5 The contractor shall pay all taxes, fees, license charges, deposits, duties, tolls, royalty, commissions or other charges which may be leviable on account of any of his operations connected with this contract. In case BHEL is forced to

- make any such payment, BHEL shall recover the same from the contractor either from moneys due to him or otherwise as deemed fit.
- 26.6 While BHEL will pay the inspection fees of the government statutory Inspectorate, all other arrangements for the periodical visits of such Inspectors to site, inspection certificates etc. will have to be made by the contractor at his cost. The contractor will also meet all expenses in connection with observed discrepancies by these govt. inspectors and performing any requisite qualification tests.
- 26.7 The contractor shall be responsible for the provision of health and sanitary arrangements more particularly described in the Contract Labour (Regulations and Abolition Act, 1970) and safety precautions as may be required for safe and satisfactory execution of the contract.
- 26.8 The contractor shall be responsible for proper accommodation including adequate medical facilities for the personnel employed by him.
- 26.9 The contractor shall be responsible for the proper behavior and observance of all regulations by the staff employed by him.
- 26.10 The contractor shall ensure that no damage is caused to any person / property of other parties working at site. If any such damage is caused, it shall be the responsibility of the contractor to make good the losses and compensate them.
- 26.11 All the properties/ equipment/ components of BHEL/ its customer loaned with or without deposit, to the contractor shall remain the properties of BHEL/ its customer. The contractor shall use such properties for the purpose of execution of this contract. All such properties/ equipment/ components shall be taken to be in good condition unless notified to the contrary by the contractor within 48 hours. The contractor shall return them in good condition as and when required by BHEL/ its customer. In case of non-return, loss, damage, repairs etc., the cost thereof, as may be fixed by the Engineer, will be recovered from the contractor.
- 26.12 It shall not be obligatory on the part of BHEL to supply any tools and tackles or materials other than those specifically agreed to be given by BHEL. However, depending upon availability / possibility, BHEL/ its customer's equipment and other materials may be made available to the contractor on payment of hire charges as fixed by them, subject to the conditions laid down by BHEL/ its customer from time to time. Unless paid in advance, such hire and other charges shall be recovered from out of dues to the contractor or security deposit in one installment.
- 26.13 The contractor shall fully indemnify and keep indemnified BHEL against all claims of whatever nature arising during the course of execution of this contract.
- 26.14 In case the contractor is required to undertake any work outside the scope of this contract, the amount payable shall be as may be mutually agreed upon.
- 26.15 Any delay in completion of works or non-achievement of periodical targets, due to reasons attributable to the contractor, will have to be compensated by the contractor either by increased manpower and resources or by working extra hours or more than one shift at no extra cost to BHEL.

- 26.16 The contractor shall execute the work under the conditions usual to such plant construction and in conjunction with numerous other operations at site. The contractor and his personnel shall cooperate and coordinate with other agencies at project site and proceed in a manner that shall help in the progress of work at site as a whole.
- 26.17 The contractor will be directly responsible for payment of wages to his workmen. A pay-roll sheet giving details of all payments made to the workmen duly signed by the contractor's representative should be furnished to BHEL, if called for.
- 26.18 In case of any class of work for which there is no specification laid down in the contract, such work shall be carried out in accordance with the instructions and requirements of the Engineer.
- 26.19 No levy, payment or charges made or imposed shall be impeached by reason of any clerical error or by reason of any mistake in the amount levied, demanded or charged.
- 26.20 **No idle labour charges** will be admissible in the event of any stoppage of work resulting in the contractor's workmen being rendered idle due to any reason at any time.
- 26.21 The contractor shall take all reasonable care to protect the materials and the work till such time the plant / equipment has been taken over by BHEL.
- 26.22 Contractor shall not stop work or abandon the site for whatsoever reason or dispute, excepting for Force Majeure conditions. All problems / disputes shall be separately discussed and settled without effecting the progress of work. Stoppage or abandonment of work, other than under force Majeure conditions, shall be treated as breach of Contract and dealt with accordingly.
- 26.23 The contractor shall keep the area of work clean and shall remove the debris etc while executing day-to-day work. Upon completion of work, the contractor shall remove from the vicinity of work, all scrap, packing materials, rubbish, unused and other materials and deposit them in places specified by the Engineer. The contractor will also demolish all the hutments, sheds, offices, etc. constructed and used by him and shall clean the debris. In the event of his failure to do so, the same will be arranged to be done by the Engineer and the expenses recovered from the contractor.
- 26.24 The contractor shall execute the work in the most substantial and workman like manner in the stipulated time. Accuracy of work and timely execution shall be the essence of this contract. The contractor shall be responsible to ensure that the quality, assembly and workmanship conform to the dimensions and clearance given in the drawings and/ or as per the instructions of the Engineer.
- 26.25 The contractor shall furnish fortnightly labour deployment report indicating the classification and number of workmen engaged, date wise and category wise. Besides, the contractor shall also furnish progress reports on work at regular intervals as required by the Engineer.
- 26.26 No land belonging to BHEL shall be occupied by the Contractor without the written permission of BHEL.

**27.0 RESPONSIBILITIES OF CONTRACTOR IN RESPECT OF SAFETY OF MEN, EQUIPMENT, MATERIAL AND ENVIRONMENT.**

- 27.1 All safety rules and codes applied by BHEL and its customer at site shall be observed by the contractor and his workmen without exception. The contractor shall be responsible for the safety of the equipment / material and work to be performed by him and shall maintain all lights, fencing guards, signs etc. or other protections necessary for the purpose. Contractor shall also take such additional precautions as may be indicated from time to time by the Engineer, with a view to prevent pilferage, accidents, fire hazards etc. Suitable number of clerical staff, watch and ward, store keepers to take care of equipment, materials, construction tools and tackles shall be posted at site by the contractor till the completion of the work under this contract. The contractor shall arrange for such safety devices as are necessary for this type of work and carry out the requisite site tests of handling equipment, lifting tools, tackles etc. as per usual standards and practices.
- 27.2 The contractor shall provide to it's work force and ensure the use of the following personal protective equipment as found necessary and as directed by the authorised BHEL officials.
- (a) Safety Helmets conforming to IS-2925
  - (b) Safety Belts conforming to IS-3521
  - (c) Safety shoes conforming to IS-1989
  - (d) Eye, Ear & Face Protection devices conforming to IS-8520 and IS-8940, IS-5983
  - (e) Hand & body protection devices conforming to IS-2573, IS-6994, IS-8807 & IS-8519.
  - (f) Rubber gloves for electrical purposes confirming to IS-4770
  - (g) Industrial safety gloves (leather & cotton gloves) confirming to IS-6994
  - (h) Industrial and safety rubber knee boots confirming to IS- 5557
- 27.3 All tools, tackles, lifting appliances, material handling equipment, scaffolds, cradles, safety nets, ladders, equipment etc. used by the contractor shall be of safe design and construction. These shall be tested and certificate of fitness obtained before putting them to use and from time to time as instructed by authorised BHEL official who shall have the right to ban the use of any item.
- 27.4 All electrical equipment, connections and wiring for construction power, its distribution and use shall conform to the requirements of Indian Electricity Act and Rules. Only electricians licensed by the appropriate statutory authority shall be employed by the contractor to carry out all types of electrical works. All electrical appliances including portable electric tools used by contractor shall have safe plugging system to source of power and be appropriately earthed.
- 27.5 The contractor shall not use any hand lamp energised by electric power with supply voltage of more than 24 volts. For work in confined spaces, lighting shall be arranged with power source of not more than 24 volts.
- 27.6 Where it becomes necessary to provide and / or store petroleum products, explosives, chemicals and liquid or gaseous fuel or any other substance that

- may cause fire or explosion, the contractor shall be responsible for carrying out such provision and/or storage in accordance with the rules and regulations laid down in the relevant Government Acts, such as Petroleum Act, Explosives Act, petroleum and Carbides of Calcium Manual of the Chief Controller of Explosives, Government of India etc. Prior approval of the authorised BHEL official at the site shall also be taken by the contractor in all such matters.
- 27.7 The contractor shall arrange at his cost (wherever not specified) appropriate illumination at all work spots for safe working, when natural daylight may not be adequate for clear visibility.
- 27.8 In case of a fatal or disabling injury / accident to any person at construction sites due to lapses by the contractor, the victim and / or his / her dependents shall be compensated by the contractor as per statutory requirements. However, if considered necessary, BHEL shall have the right to impose appropriate financial penalty on the contractor and recover the same from payments due to the contractor for suitably compensating the victim and / or his / her dependents. Before imposing any such penalty, appropriate enquiry shall be held by BHEL giving opportunity to the contractor to present his case.
- 27.9 In case of any damage to property due to lapses by the contractor, BHEL shall have the right to recover the cost of such damages from the payments due to the contractor after holding an appropriate enquiry.
- 27.10 In case of any delay in the completion of a job due to mishaps attributable to lapses by the contractor, BHEL shall have the right to recover cost of such delay from the payments due to the contractor, after notifying the contractor suitably and giving him opportunity to present his case.
- 27.11 If the contractor fails to improve the standards of safety in its operation to the satisfaction of BHEL after being given reasonable opportunity to do so and / or if the contractor fails to take appropriate safety precautions or to provide necessary safety devices and equipment or to carry out instructions regarding safety issued by the authorised BHEL official, BHEL shall have the right to take the corrective steps at the risk and cost of the contractor after giving a notice of not less than seven days indicating the steps that would be taken by BHEL.
- 27.12 The contractor shall submit report of all accidents, fires, property damage and dangerous occurrences to the authorised BHEL official immediately after such occurrence, but in any case not later than 12 hours of the occurrence. Such reports shall be furnished in the manner prescribed by BHEL. In addition, periodic reports on safety shall also be submitted by contractor to the authorised BHEL official from time to time as prescribed.
- 27.13 During the course of construction, alteration or repairs scrap lumbers with protruding nails, sharp edges etc., and all other debris including combustible scrap shall be kept cleared from working areas, passageways and stairs in and around site.
- 27.14 Cylinders shall be moved by tilting and rolling them on their bottom edges. They shall not be intentionally dropped, struck or permitted to strike each other violently. When cylinders are transported by powered vehicles, they shall be secured in a vertical position.

- 27.15 The contractor shall be responsible for the safe storage of his radioactive sources.
- 27.16 All the contractor's supervisory personnel and sufficient number of workers shall be trained for fire fighting and shall be assigned specific fire protection duties. Enough number of such trained personnel must be available during the tenure of the contract.
- 27.17 Contractor shall provide enough fire protecting equipment of the types and numbers at his office, stores, erection site, other temporary structures, labour colony area etc. Access to such fire protection equipment shall be easy and kept open at all times. Compliance of the above requirement under fire protection shall in no way relieve the contractor of any of his responsibility and liabilities to fire accident occurring. In the event fire safety measures are not to BHEL's satisfaction, BHEL shall have option to provide the same and recover the cost plus incidentals from contractor's bills and / or impose penalty as deemed fit by the Engineer.
- 27.18 Before commencing the work, the contractor shall appoint / nominate a responsible officer to supervise implementation of all safety measures and liaison with his counterpart of BHEL.
- 27.19 If safety record of the contractor in execution of the awarded job is to the satisfaction of Safety Department of BHEL, issue of an appropriate certificate to recognise the safety performance of the contractor may be considered by BHEL after completion of the job.
- 27.20 All prescribed forms of BHEL pertaining to HSE requirements shall be duly filled and submitted by the contractor periodically or otherwise as per the requirement of the engineer-in-charge.
- 27.21 Necessary precautions and arrangements including sprinkling of water during work as acceptable to BHEL for safety and reducing environmental pollution have to be made by the contractor. No claim on this account shall be entertained on this account and the contractor's rates shall be deemed to have taken this into account.

## **28.0 CONSEQUENCES OF CANCELLATION**

- 28.1 Whenever BHEL exercises its authority to terminate the contract / withdraw a portion of work under clause 25, the work may be got completed by any other means at the contractor's risk and cost provided that in the event of the cost of completion (as certified by the Engineer which shall be final and binding on the contractor) being less than the contract value, the advantage shall accrue to BHEL. If the cost of completion exceeds the moneys due to the contractor under the contract, the contractor shall either pay the excess amount demanded by BHEL or the same shall be recovered from the contractor. This will be in addition to the forfeiture of Security Deposit and recovery of liquidated damages as per relevant clauses.
- 28.2 In case BHEL completes the work under the provisions of this clause, the cost of such completion to be taken into account for determining the excess cost to be charged to the contractor shall consist of cost of materials purchased and /

or labour provided by BHEL with an addition of such percentage to cover supervision and establishment charges as may be decided by BHEL.

## **29.0 INSURANCE**

- 29.1 BHEL shall arrange for insuring the materials / property of BHEL covering the risks during transit, storage, erection and commissioning. The Contractor has to arrange on his own insurance pertaining to their scope of work for all workers and to arrange for accident risk policy/ workmen compensation policy, materials like Cement, Reinforcement steel and other bought out items and other valuable building materials during its transport, storage, till it goes to the permanent work, their all T & Ps and, IMTEs and fixed assets which they may acquire and deploy at site. Proper insurance cover against any eventuality such as earthquakes, floods and other calamities has to be taken by the contractor for constructed and completed structures at site till these are handed over to BHEL.
- 29.2 It shall be the sole responsibility of the contractor to insure his workmen against risks of accidents and injury while at work as required by the relevant Rules and to pay compensation, if any, to them as per Workmen's Compensation Act. The contractor shall also insure his staff against accidents. The work will be carried out in a protected area and all the Rules and Regulations of BHEL in the Project Area which are in force from time to time will be followed by the contractor.
- 29.3 If due to negligence and/or non-observance of safety and other precautions, any accident / injury occurs to any other persons/ public, the contractor shall pay necessary compensation and other expenses, if so decided by the appropriate authority.
- 29.4 The contractor will take necessary precautions and due care to protect the material, while in his custody from any damage/ loss till the same is taken over by BHEL. For lodging / processing of insurance claim the contractor will submit necessary documents. BHEL will reserve the right to recover the loss from the contractor, in case the damage / loss is due to carelessness / negligence on the part of the contractor. In case of any theft of material under contractor's custody, matter shall be reported to police by the contractor immediately and copy of FIR and subsequently police investigation report shall be submitted to BHEL for taking up with insurance.
- 29.5 If due to negligence/ carelessness on the part of the contractor, any material/ equipment owned by BHEL is damaged, the contractor shall submit necessary documents for lodging insurance claims as required by BHEL Engineer. BHEL shall however reserve the right to recover deductible franchise and also unsettled portion of insurance claim amount from the contractor.
- 29.6 If due to negligence/ carelessness on the part of the contractor, any surrounding properties also get damaged, the contractor shall submit necessary documents for lodging insurance claims as required by BHEL Engineer. BHEL shall however reserves the right to recover deductible franchise and to unsettled portion of insurance claim amount from the contractor.

29.7 The contractor may note that BHEL T&Ps / IMTEs are not insured. The Contractor will take necessary precautions and due care to protect the same while in his custody from any damage/ loss till the same is handed over back to BHEL. In case the damage / loss is due to carelessness/ negligence on the part of the contractor, the Contractor is liable to get them repair/ replaced immediately and in case of his failure to do so within a reasonable time, BHEL will reserve the right to recover the loss from the contractor.

### **30.0 COMPLETION SCHEDULE AND PENALTY FOR DELAY**

30.1 The Contractor shall complete the work as per the time frame given in the Letter of Intent.

30.2 Failure to complete the work in time as per the time frame specified will make the Contractor liable to an unconditional penalty as specified in Special Conditions of Contract.

### **31.0 STRIKES AND LOCKOUTS**

31.1 The contractor will be solely responsible for all disputes and other issues connected with his workmen. In the event of contractor's workmen resorting to strike or the contractor resorting to lockout and if the strike or lockout so declared is not settled within a period of one month, BHEL shall have the right to get the erection work executed by employing its own men or through other agencies or both. The cost incurred by BHEL in this regard shall be recovered from the contractor.

31.2 For any purpose whatsoever, the employees of the contractor shall not be deemed to be in the employment of BHEL

### **32.0 FORCE MAJEURE**

32.1 The following shall amount to Force Majeure conditions. Acts of God, Act of any Government, War, Sabotage, Riots, Civil Commotion, Police Action, Revolution, Flood, Fire, Cyclone, Earthquake and Epidemic and other similar causes over which the contractor has no control.

32.2 If the contractor suffers delay in the due execution of the contract, due to delays caused by force Majeure conditions, as defined above, the agreed time for completion of the work covered by this contract shall be extended by a period of time equal to the period of delay, provided that on the occurrence of any such contingency, the contractor immediately reports to BHEL in writing the causes for the delay but the Contractor shall not be eligible for any compensation on this account.

**33.0 GUARANTEE :** Even though the work will be carried out under the supervision of the Engineer, the contractor will be responsible for the quality of the workmanship and shall guarantee the work done for a period as specified in the Special Conditions of Contract and shall rectify, free of cost to BHEL, all defects arising out of faulty erection/ construction during the guarantee period. In the event of the contractor failing to repair the defective works within the time specified by the Engineer, BHEL may proceed to undertake the repairs of such defective works at the contractor's risk and cost, without prejudice to any other rights and recover the same from out of any moneys payable to the contractor or by other legal means.

**34.0 CONTRACT LAW, NOTICE AND ARBITRATION:**

- 34.01 The Contract shall be governed by the Law for the time being in force in the Republic of India. The Civil Court having ordinary civil jurisdiction over site shall alone have exclusive jurisdiction in regard to all claims in respect of the contract.
- 34.02 The Contractor shall furnish to the Engineer, the name, designation and address of his authorised agent and all complaints, notices, communications and references shall be deemed to have been duly given to the Contractor, if delivered to the Contractor or his authorised agent or left at or posted to the address either of the contractor or his authorised agent and shall be deemed to have been so given in the case of posting on the day on which they would have reached such address in the ordinary course of post or at which they were so delivered or left.
- 34.03 All disputes between the parties to the contract arising out of or in relation to the contract, other than those for which the decision of the Engineer or any other person is by the contract expressed to be final and conclusive, shall after written notice by either party to the contract to the other party, be referred to sole arbitration of the General Manager or his nominee. The arbitration shall be conducted in accordance with the provisions of the Arbitration and Reconciliation Act, 1996. The parties to the contract understand and agree that it will be no objection that the General Manager or the person nominated as Arbitrator had earlier in his official capacity to deal directly or indirectly with the matters to which the contract relates or that in the course of his official duties had expressed views on all or any of the matters in dispute or difference. The award of the Arbitrator shall be final and binding on the parties to this contract. In the event of the Arbitrator dying, neglecting or refusing to act or resigning or being unable to act for any reason or his award being set aside by the Court for any reason, it shall be lawful for the General Manager or his successor, as the case may be, either to act himself as the Arbitrator or to appoint another Arbitrator in place of the outgoing Arbitrator in the manner aforesaid. The Arbitrator may, from time to time, with the consent of both the parties to the contract, enlarge the time for making the award. Work under the contract shall be continued during the arbitration proceedings. The venue of the arbitration shall be the place from which the contract is issued or such other place as the Arbitrator at his discretion may determine.

**35.0 REVERSE AUCTION (RA)**

- 35.01 BHEL may go for Reverse Auction (on line bidding on Internet) instead of opening the submitted sealed paper price bid. The decision to go for Reverse Auction will be taken after techno-commercial evaluation. Information and general terms and conditions governing RA are given below.
- 35.02 For the proposed reverse auction, technically and commercially acceptable bidders only shall be eligible to participate.
- 35.03 BHEL will engage the services of a Service Provider who will provide all necessary training and assistance/ demonstration before commencement of on line bidding on internet.
- 35.04 BHEL will inform the Vendors in writing the details of Service Provider to enable

them to contact for training/ demonstration.

- 35.05 Business rules like event date, time, start price, bid decrement, extensions etc. also will be communicated through Service Provider for compliance.
- 35.06 Vendors have to fax the Compliance form in the prescribed format (provided by Service provider) before start of Reverse Auction. Without this, the vendor will not be eligible to participate in the event.
- 35.07 BHEL may provide the calculation sheet which will help the Vendors to enable them to fill-in the price and keep it ready for keying in during the Auction.
- 35.08 Reverse auction will be conducted on a scheduled date & time.
- 35.09 At the end of Reverse Auction event, the lowest bid value will be known on the network.
- 35.10 The lowest bidder has to fax the duly signed filled-in prescribed format as provided to BHEL through Service Provider within 24 hours of Auction without fail.
- 35.11 Any variation between the on-line bid value and the signed document will be considered as sabotaging the tender process and will invite disqualification of vendor to conduct business with BHEL as per prevailing procedure.
- 35.12 In case BHEL decides not to go for Reverse Auction procedure for this tender enquiry, the paper Price bids already submitted and available with BHEL shall be opened as per BHEL's standard practice.

--X--X--

**SECTION - II****PART – C****TERMS AND CONDITIONS FOR CIVIL, STRUCTURAL AND FINISHING WORKS****36.0 CONTRACTOR'S SITE OFFICE / SUPERVISION**

- 36.1 The Contractor shall establish an office at Site and keep posted an authorised, responsible officer with valid Power of Attorney for the purpose of the contract. Any order or instructions of the Engineer or his duly authorised representative, communicated to the contractor's representative at site office will be deemed to have been communicated to the contractor at his legal address.
- 36.2 The Contractor shall either himself supervise the execution of the Contract or shall appoint a competent Engineer / agent approved by the Engineer to act in his stead.
- 36.3 The Contractor shall employ an Engineer/ Agent having atleast a 'Degree of Bachelor in Civil Engineering' from a recognised university with six years as post qualification experience or having atleast a 'Diploma in Civil Engineering' from a recognised college with ten years of post qualification experience.
- 36.4 The employment of an Engineer / Agent as aforesaid shall not be necessary if the Contractor himself is in possession of a recognised technical qualification and is in the opinion of the Engineer capable of receiving instructions of the Engineer and of executing the work to the satisfaction of the Engineer.
- 36.5 If the Contractor fails to appoint a suitable Engineer /Agent as aforesaid, the Engineer shall have full powers to suspend the execution of work and stop payment of any money that may have become due until such date as a suitable Engineer / Agent is appointed and the Contractor shall be held responsible for the delay caused to the work and no extension of time on this account shall be given to him.
- 36.6 Orders given to the Contractor's Engineer / Agent shall be considered to have the same force as if they had been given to the Contractor himself.
- 36.7 The Contractor or his Agent shall be in attendance at the site during all working hours and shall superintend the execution of work with such additional assistance in each grade as the Engineer may consider necessary.
- 36.8 The Contractor or his accredited Agent shall attend, when required and without making any claim for doing so, either the office of the Engineer or the work site to receive instructions.
- 36.9 The BHEL Engineer shall have full powers to instruct the Contractor to arrange for immediate termination of services, in connection with this contract, of any

Agent, servant or employee whose continued employment is, in his opinion, undesirable, without assigning any reason.

### **37.0 SUPERVISORY STAFF AND WORKMEN**

- 37.1 The contractor shall deploy all the experienced skilled, semiskilled and unskilled workmen required for all the works under this specification. BHEL reserves the right to decide on the suitability of the workers and other personnel who will be deployed by the contractor. BHEL reserves the right to insist on removal of any employee of the contractor at any time, if they find him unsuitable and the contractor shall forth with removes him.
- 37.2 The supervisory staff including qualified Engineers deployed by the contractor shall ensure proper out-turn of work and discipline on the part of the labour put on the job by the contractor and in general see that the works are carried out in a safe and proper manner and in coordination with other labour and staff deployed directly by BHEL or other contractors of BHEL / other agency.
- 37.3 The work shall be executed under the usual conditions like rain, insufficient space, improper approach roads etc., and effecting major construction work and in conjunction with numerous other operations at site. The contractor and his personnel shall cooperate with other personnel / contractor, coordinating his work with others and proceed in a manner that shall not delay or hinder the progress of work as a whole.
- 37.4 The contractor's supervisory staff shall execute the work in the most substantial and workman like manner in the stipulated time. Accuracy of work and aesthetic finish are essential part of this contract. The contractor shall be responsible to ensure that assembly and workmanship conform to the dimensions and tolerances given in the drawings /documents / instructions given by BHEL Engineer from time to time.
- 37.5 It is the responsibility of the contractor to engage his workmen in shifts or on overtime basis for achieving the targets set by BHEL. The contractor's finally accepted rates shall include all these contingencies.
- 37.6 During the course of construction, if the progress is found unsatisfactory, or in the opinion of BHEL, if it is found that the skilled workmen like welder, fitters, technicians etc. deployed are not sufficient, BHEL after giving reasonable opportunity to the contractor, will induct on the work the required workmen in addition to contractor's workmen to improve the progress and recover from the contractor's bills.
- 37.7 If the contractor or his workmen or employees shall break, deface, injure or destroy any part of a building, road kerb, fence, enclosure, water pipes, cables, drains, electric or telephone posts or wire, trees or any other property or to any part of erected components etc., the contractor shall make the same good at his own expense or in default, BHEL may cause the same to be made good by other workmen or by other means and deduct the expenses (of which BHEL's decision will be final) from any money due to the contractor.
- 37.8 The month wise manpower deployment plan to be submitted as per format (at Annexure-C – Part B) is only to assess the capability as well as understanding of the contractor to execute the work. It shall be the contractor's responsibility

to deploy the required manpower, for timely and successful completion of the job, to any extent over and above those indicated in the above deployment plan (including those which are not covered in the plan submitted) without any compensation on this account.

- 37.9 The Contractor shall ensure deposit of provident funds and get necessary ESI of their deployed workmen, employees at site and produce documents to BHEL in respect of these as desired by BHEL from time to time.

### **38.0 TOOLS AND PLANTS / IMTEs**

- 38.1 All T&Ps and IMTEs which are required for successful and timely execution of the work covered within the scope of this tender, shall be arranged and provided by the contractor at his own cost in working condition. Indicative lists of T&Ps and IMTEs to be arranged by the contractor are given **as per Annexure in Special Conditions of Contract**. In the event of the failure of contractor to bring necessary and sufficient T&Ps/ and IMTEs, BHEL will be at liberty to arrange the same at the risk and cost of contractor including transportation cost of same from any of BHEL site/place and hire charges as applicable shall be deducted from contractor's bill. Decision of BHEL in this regard shall be final and binding on contractor.
- 38.2 All distribution boards, connecting cables / welding cables, wire ropes, hoses etc. including temporary air/water / electrical connections etc. shall have to be arranged by the contractor at his own cost.
- 38.3 In case of non-availability of the T&Ps to be provided by BHEL due to breakdown, major overhauls, distribution pattern or any other reason, the contractor shall plan / amend / alter his activities to meet erection / commissioning targets in consultation with BHEL.
- 38.4 The contractor shall arrange at his own cost operators, fuel, and other consumables etc. for the operation. All lubricants such as mobile oil, gear oil, break oil, hydraulic oil, torque converter oil & grease shall be provided by contractor free of cost.
- 38.5 The contractor shall engage trained and experienced operators for the operation of T&Ps. BHEL Engineer will check their skill and performance before they are allowed to operate the same. However checking of skills by BHEL does not absolve the contractor of his responsibilities for proper & safe handling of equipment, consistent good performance of operators & regular performance evaluation of operators.
- 38.7 The day to day and routine maintenance of T&Ps should be carried out by contractor as per manufacturer's schedule at his cost. These shall be maintained in good working condition during the entire period of use. T&Ps in defective / damaged condition shall be rectified promptly to the full satisfaction of BHEL engineer. Contractor shall maintain records for maintenance of major T&Ps which shall be made available for Inspection whenever required. In case of any lapses on the part of the contractor BHEL at its own discretion get the servicing / repair of equipment done at the risk and cost of the contractor with BHEL overheads.
- 38.8 Increasing / shortening of the crane boom to suit work requirements shall have to be arranged by the indenting contractor at his cost. All necessary manpower,

- tools, support, consumables, illumination etc. will have to be arranged by contractor at his cost.
- 38.9 Consolidation of ground and arrangement of sleepers / sand bag filling etc. for safe operation / movement of equipment including cranes / trailers etc. shall be the responsibility of the contractor at his cost.
- 38.10 Contractor shall ensure deployment of serviced and healthy T&Ps including cranes, lifting tackles, wire ropes, Manila ropes, winches and slings etc. History card and maintenance records for major T&Ps will be maintained by the contractor and will be made available to BHEL Engineer for inspection as and when required. Identification for such T&Ps will be done as per BHEL Engineer's advice.
- 38.18 Contractor shall ensure deployment of reliable and calibrated IMTEs (Inspection measuring and Test equipment). The IMTEs shall have test/calibration certificates from authorised / Govt. approved / accredited agencies traceable to National / International standards. Each IMTE shall have a label indicating calibration status i.e. date of calibration, calibration agency and due date for calibration. A list of such instruments deployed by contractor at site with its calibration status is to be submitted to BHEL Engineer for control.
- 38.19 Retesting / re-calibration shall also be arranged at regular intervals during the period of use as advised by BHEL Engineer with in the contract price. The contractor will also have alternate arrangements for such IMTE so that work does not suffer when the particular instrument is sent for calibration. Also if any IMTEs not found fit for use, BHEL shall have the right to stop the use of such item and instruct the contractor to deploy proper item and recall i.e. repeat the readings taken by that instrument, failing which BHEL may deploy IMTEs and retake the readings at contractor's cost.
- 38.20 BHEL shall have lien on all T&P, IMTEs & other equipment of the Contractor brought to the site for the purpose of erection, testing and commissioning. BHEL shall continue to hold the lien on all such items throughout the period of contract. The Contractor and/or his Sub-contractors shall remove no material brought to the Site from the Site without the prior written approval of the Engineer.
- 38.21 The month wise T&P deployment plan to be submitted as per format (at Annexure-D to general conditions of contract) is only to assess the capability as well as understanding of the contractor to execute the work. It shall be the contractor's responsibility to deploy the required T&Ps, for timely and successful completion of the job, to any extent over and above those indicated in the above deployment plan (including those which are not covered in the plan submitted) without any compensation on this account.

### **39.0 MATERIALS**

- 39.1 **BHEL shall provide only reinforcement steel as free issue item.** The same shall be directly supplied at the work site and contractor shall make arrangement for it's verification, unloading, segregating the steel dia-wise, safety and security of material, reconciliation and deposition of scrap generated at BHEL stores .The contractor shall at his own expenses provide all other materials e.g. cement, structural steel, cladding, all finishing material as per BOQ or otherwise including paints, welding electrodes and other consumables

etc. required for the work. Necessary indents shall be raised by the contractor well in advance at least before 30 days notice for quantity of reinforcement steel to be supplied month wise by BHEL. **The following clauses shall be read in accordance with this CI 39.1 for the specific material issued by BHEL as free issue.**

- 39.2 All materials to be provided by the Contractor shall be of the best kind in conformity with the specifications laid down in the contract or as per relevant Indian standard and the Contractor shall, if requested by the Engineer, furnish proof to the satisfaction of Engineer that the materials so comply.
- 39.3 The Contractor shall, at his own expense and without delay, supply to the Engineer samples of materials proposed to be used in the works. The Engineer shall within seven days of supply of samples or within such further period as he may require will intimate to the Contractor in writing, whether samples are approved by him or not. If samples are not approved, the Contractor shall forthwith arrange to supply to the Engineer for his approval fresh samples complying with the specifications laid down in the Contract. Any delay in approval of samples (original or fresh ones) shall not make the contractor eligible for any compensation.
- 39.4 The BHEL Engineer shall have full powers for removal of any or all of the materials brought to site by the Contractor which are not in accordance with the Contract specifications or do not conform in character or quality to samples approved by him. In case of default on the part of the Contractor in removing rejected materials, the Engineer shall be at liberty to have them removed by other means. The BHEL Engineer shall have full powers to procure other proper material to be substituted for rejected materials and in the event of the Contractor refusing to comply; he may cause the same to be supplied by other means. All costs, which may attend upon such removal and / or substitution, shall be borne by the Contractor.
- 39.5 The Contractor shall indemnify BHEL, its representatives or employees against any action, claim or proceeding relating to infringement or use of any patent or design or any alleged patent or design rights and shall pay any royalties or other charges which may be payable in respect of any article or material or part thereof included in the Contract. In the event of any claim being made or action being brought against BHEL or any agent, servant or employee of BHEL in respect of any such matters as aforesaid, the Contractor shall immediately be notified thereof, provided that such indemnity shall not apply when such infringement has taken place in complying with the specific directions issued by BHEL but the Contractor shall pay any royalties or other charges payable in respect of any such use, the amount so paid being reimbursed to the Contractor only if the use was the result of any drawings and / or specifications issued after submission of the tender.
- 39.6 The Engineer shall be entitled to have tests carried out as specified in the Contract for any materials supplied by the Contractor other than those for which, as stated above, satisfactory proof has already been furnished, at the cost of the Contractor and the Contractor shall provide at his expense all facilities which the Engineer may require for the purpose. If no tests are specified in the Contract, and the Engineer requires such tests, the Contractor shall provide all facilities required for the purpose and the charges for these tests shall be borne by the Contractor only. The cost of materials consumed in

tests shall be borne by the Contractor in all cases except when otherwise provided.

- 39.7 In addition the Contractor shall perform / submit at his own cost such tests / samples as may be required by the Engineer out of the materials used by the company except for the costs of materials used in such tests / samples.
- 39.8 After acceptance of the Contract, if Contractor desires BHEL to supply any other materials, such material may be supplied by BHEL, if available, at rates to be fixed by the Engineer along with prevailing departmental charges (current rate of 30%). BHEL reserve the right not to issue any material. The non-issue of such material will not entitle the Contractor for any compensation whatsoever either in time or in cost.
- 39.9 Material required for the works, whether brought by the Contractor or supplied by BHEL, shall be stored by the Contractor only at places approved by the Engineer. Storage, theft insurance and safe custody of material shall be the responsibility of the contractor for all materials whether supplied by BHEL or brought by contractor for works.
- 39.10 BHEL's officials concerned with the Contract shall be entitled at any time to inspect and examine any materials intended to be used in or on the works, either on the Site or at factory or workshop or other place(s) where such materials are assembled, fabricated, manufactured or at any place (s) where these are lying or from which these are being obtained and the Contractor shall give such facilities as may be required for such inspection and examination.
- 39.11 All materials brought to the Site shall become and remain the properties of BHEL and shall not be removed off the Site without the prior written approval of the Engineer. But whenever the Works are finally completed and advance, if any, in respect of any such material is fully recovered, the Contractor shall, at his own expense, forthwith remove from the Site all surplus material originally supplied by him and upon such removal, the same shall re-vest in and become the property of the Contractor.
- 39.12 It shall be the responsibility of the contractor to obtain prior approval of BHEL, regarding suppliers, type of electrodes etc. before procurement of welding electrodes / TIG wires. On receipt of electrodes at site these shall be subjected to inspection and approval by BHEL. The contractor shall inform BHEL details regarding type of electrodes, batch No., date of expiry etc. and produce test certificate for each lot / batch with correlation of batch / lot number with respective test certificate. Without valid test certificate, the use of welding electrodes is prohibited.
- 39.13 **All charges on account of Octroi, terminal or sales tax and other duties on materials obtained for the works from any source shall be borne by the contractor.**
- 40.0 **HANDLING OF CEMENT, REINFORCEMENT AND STRUCTURAL STEEL**
- 40.1 **Materials will be accounted only for permanent works and not for making templates, other temporary works, enabling works etc. and the same shall not be taken into account for purpose of material reconciliation for billable items. The coefficients for theoretical consumption of material shall be as per CPWD specifications.**

- 40.3 The contractor shall bear all other costs including the lifting, carting from issue points to works site/contractor's stores, custody and handling etc. and return of surplus/ serviceable materials to Owner's stores to be designated by the Engineer –in-charge and all expenditure will be made by the contractor.
- 40.4 All steel shall be accounted in available lengths / shapes and no claims for extra payment on account of receipt of non-standard lengths/shapes will be entertained. For the purpose of billing and accounting only linear measurement will be taken and weight will be calculated as per the IS co-efficient. The difference in unit weight as per IS and actual as issued, if any shall be to the contractor's account and contractor shall quote the rates for corresponding item to take care of such difference.
- 40.5 The theoretical weight of each bag of cement will be considered as 50 kg per Bag. No claim whatsoever shall be entertained on this. The weight of each consignment at suitable capacity of weighbridge, nearest to the plant shall be ensured in the presence of BHEL representative, if required, and ascertained by BHEL. Empty cement bags shall be the property of Contractor
- 40.6 The Contractor shall maintain good stores for storing the cement and reinforcement steel and other bought out items. The flooring of the storage house, the clearance of cement bags from the side walls, etc., shall be as per the instructions of the Engineer-in-charge.
- 40.7 The **cement stores** shall be open for supervision and verification by the Engineer-in-charge or his authorised representative by any time when the Engineer-in-charge feels the need to do so.
- 40.8 In the case of steel materials if weight of consignment is not available it will be considered as received based upon linear measurement basis and the corresponding weight in such cases will be calculated as per Indian Standard. For the purpose of billing & accounting, only linear measurement will be taken and any difference in weight based on linear measurement & actual weight shall be to contractor's account. Quoted price shall be deemed to include the above & the permissible wastage mentioned. No claim whatsoever shall be entertained on account of wastage & difference in weight as referred to above.
- 40.9 Issue of stores material is subject to availability and the contractor shall not be entitled to any claim or compensation for non-supply or delay in supply under any circumstances. The material will be issued generally during the working hours. The Contractor shall bear all incidental costs including site lifting, carting from issue points to site / contractor's store, custody and handling etc no separate payment for such expenditure shall be made.
- 40.10 The Contractor will have to submit their design mix duly certified by technical institutes like IIT etc.or equivalent accredited laboratory for different grades of Concrete keeping in view the requirements stipulated in IS: 456, specifically regarding slump and Water Cement ratio and Specific Gravity of Materials brought to site as analysed in the laboratories. The design shall be used upon absolute volume method and theoretical consumption of Cement shall be worked out on this basis. For other than above designated mix Concrete items, the coefficients for consumption of cement shall be adopted as per CPWD practice. The theoretical consumption of cement thus worked out shall be binding upon the Contractor for reconciliation of Cement issued by the Owner.

For any excess /under consumption based on these coefficients, the Contractor shall be penalised as per contract provisions. Though, permissible wastage specified shall be considered, while effecting penal recovery, no other allowance whatsoever shall be taken for reconciliation purposes

- 40.12 The theoretical consumption of cement, reinforcement steel and structural steel required for the work will be calculated on the basis of approved drawings / joint measurements. In the case of Cement, the theoretical consumption shall be decided by the Engineer as mentioned above and his decision in this regard shall be final and binding on the Contractor. Reinforcement and structural steel shall be measured by weight in tones. The weight will be arrived at by multiplying the used length by the sectional weight. The sectional weight will be same as were applied at the time of issue. Standard hooks, cranks, bends and authorised laps, chairs, separator pieces etc. specified in drawing or instructed by engineer as required shall be measured and paid for. No payment shall be made for binding wires, spacer block etc. required for keeping the steel in position unless otherwise specified in the contract. No extra payment will be made for modification of already embedded reinforcement, if required due to faulty fabrication or placement.
- 40.13 The contractor shall submit proper account of material / material reconciliation statement for the material drawn by him from stores with each RA bill. Failing compliance of this requirement further issue of steel to the contractor may be suspended and no claim of compensation for delay in execution on this account shall be entertained.
- 40.14 All the steel thus issued shall be properly accounted for as per the following permissible wastage over the theoretical quantity / consumption incorporated in the works

ITEM	AREA	PERMISSIBLE WASTAGE
(A) Cement	For all works except piling	2%
	For Piling works	7%
(B) Reinforcement Steel	For all works except piling	3%
	For Piling works	5%
(C) Structural Steel	Accountable (Visible)	4%
	Un accountable (Invisible)	1%

Invisible wastages are losses of material due to gas cutting, straightening of edges etc

- 40.15 Any unused / serviceable quantity of cement, reinforcement steel & structural steel not returned in good condition & wastages / loss / consumption beyond specified / agreed limits shall be charged at penal rate of Rs 6000 per MT for cement , Rs 55000 per MT for reinforcement steel & Rs 60000 per MT for structural steel respectively at the time of preparing final bill, during finalization of the contract. The decision of engineer- in –charge with regard to applicability of penal rates shall be final & binding upon the contractor.
- 40.16 All excavated material shall remain the property of the BHEL. In case the Contractor wishes to utilize the boulders excavated by him during the excavation work at the site, the same may be issued to him at prevailing rates on the cost recovery basis as decided BHEL.

**41.1 SCRAP & SERVICEABLE MATERIALS**

- 41.1 All structural steel of length above 2 M except M.S. Plates shall be considered as serviceable materials provided the materials is in good and acceptable condition. Structural steel in length less than 2 M shall be treated as scrap.
- 41.2 All reinforcement steel of length above 3 M shall be considered serviceable provided the material is in good & acceptable condition. Reinforcement steel of length less than 3 M shall be treated as scrap.
- 41.3 Plates having both sides greater than 1 Meter or If any side is less than 1 M but greater than 0.5 M and the total area is equal or greater than 2 Sq. Meter shall be considered as serviceable.
- 41.4 All pipes measuring 2 M and above in length shall be treated as serviceable materials provided they are in good and acceptable condition. Pipe in less than 2 M length shall be treated as scrap.

**42.0 EXECUTION OF WORK**

- 42.1 The work shall be executed in a workman like manner and to the entire satisfaction of the Engineer and as per technical specification issued with tender, IS codes, CPWD specifications as applicable. In case of conflict, the decision of the Engineer shall be final & binding.
- 42.2 The Engineer will communicate or confirm his instructions to the Contractor in respect of the execution of the work in a "Work Site Order Book" maintained at his office and the Contractor shall visit this office daily and shall confirm receipt of such instructions by signing the relevant entries in this book. Such entries will rank as order or notices in writing within the intent and meaning of these conditions.
- 42.3 Only BHEL approved make of electrodes will be used. All electrodes shall be heated and dried in the electric electrode drying oven to the required temperature for the period specified by the Engineer before these are used in erection work. All welders shall have electrodes drying portable oven at the work spot. The electrodes brought to site will have valid manufacturing test certificate. The test certificate will have co-relation with the lot no. / batch no. given on electrode packets. No electrodes will be allowed to be used in the absence of above requirement. The thermostat and thermometer of electrode drying oven will be also calibrated and test certificate from Govt. approved / accredited test house traceable to National / International standards) will be submitted to BHEL before putting the oven in use. Periodical calibration for the same shall also be arranged by the contractor within the finally accepted rates.
- 42.4 Inspection and stage approval of all bought out items: Contractor at his own cost shall make necessary arrangements for the prior approval and stage inspections of the supplied bought out items as per requirement of FQP and as directed by the Engineer-in-charge of BHEL. These inspections can either be carried out at site or at the works as per decision of engineer-in-charge of BHEL without any extra claim from contractor towards such inspections.**

#### **42.4 SETTING OUT**

42.4.1 All the works shall be set out to the true lines, grades and elevation indicated on the drawing. The contractor shall be responsible to locate and set out the works. Only one grid reference line and benchmark all be made available for setting out the works under the contract. This reference lines shall be used as datum for the works under the contract and the contractor has to establish for his work area at available points horizontal and vertical control points. The contractor shall inform BHEL well in advance of the times & places at which he wishes to do work in the area allotted to him so that suitable datum points established by him are checked by BHEL / Customer to enable the contractor to proceed with the works. Any work done without being properly located may be removed and / or dismantled by BHEL / Customer at Contractor's expense.

42.4.2 The Contractor shall at his own expense take all proper and responsible precautions to preserve and maintain these datum marks to its true position. In the event of these marks being disturbed or obliterated by accident or due to any other cause whatsoever, the same may be deemed necessary placed by BHEL / Customer at contractor's expenses.

#### **42.5 SITE DRAINAGE**

42.5.1 All water including sub-soil water which may accumulate on the Site during the progress of the works or in trenches and excavations, including monsoon period shall be removed by the contractor from the Site to the satisfaction of the Engineer. It will also be responsibility of the contractor to de-water all the foundation pits, trenches with suitable de-watering methods like, pumping out, well point system etc. considering the depth of water table at plant site. All such expenditure on **de-watering** shall be deemed to be included in quoted rates.

#### **42.6 INSPECTION AND STAGE APPROVAL OF THE WORK**

42.6.1 The owner or his duly authorised representative shall have at all reasonable times access to the contractor's premises or works and shall have the power to inspect drawings or any portion of the work, examine the materials and workmanship and shall have the authority to reject any work. This would be implemented through joint inspection by the representative of the owner and BHEL and in the form of joint protocols without any extra claims and loss of time and amount.

42.6.2 All work embracing more than one process shall be subject to examination and approval at each stage thereof and the Contractor shall give due notice in writing to the Engineer when each stage is ready. In default of such notice being received, the Engineer shall be entitled to approve the quality and extent thereof at any time he may choose and in the event of any dispute; the decision of the Engineer thereon shall be final and conclusive.

#### **42.7 UNCOVERING AND MAKING GOOD**

42.7.1 The Contractor shall uncover any part of the Works and/or make openings in or through the same as the Engineer may from time to time direct for his verification and shall reinstate and make good such part to the satisfaction of the Engineer. If any such part has been covered up or put out of view after being approved by the Engineer and is subsequently found on uncovering to be

executed in accordance with the Contract, the expenses of uncovering and / or making opening in or through, reinstating and making good the same shall be borne by BHEL. In any other case all such expenses shall be borne by the Contractor.

#### **42.8 DISCREPANCIES AND ADJUSTMENT OF ERRORS**

42.8.1 The several documents forming the Contract are to be taken as mutually explanatory of one another, detailed drawings being followed in preference to small-scale drawings and figures dimensions in preference to scale and special conditions in preference to general conditions.

42.8.2 In case of discrepancies between schedules of quantities, the specification and / or the drawings, the following order of preference shall be observed.

- (a) Description in schedule of quantities.
- (b) Special conditions
- (c) Drawings
- (d) Technical Specifications
- (e) General conditions of contract

If there are varying or conflicting provisions made in any one document forming part of the contract, the Engineer shall be the deciding authority with regard to the document.

42.8.3 Any error in description, quantity in schedule of quantities or any omission there from shall not vitiate the contract or release the contractor from the execution of the whole or any part of the works comprised therein according to the drawings and specifications or from any of his obligations under the contract.

42.8.4 If on check there are found to be differences between the rates given by the contractor in words and figures or in the amount worked out by him in the schedule of quantities and general summary, the same shall be adjusted in accordance with the following rules:

- (a) In the event of discrepancies between description in words and figures quoted by a Tenderer, the lesser of the two will be treated as valid rate.
- (b) In the event of an error occurring in the amount column of schedule of quantities as a result of wrong extension of the unit rate and quantity, the unit rate shall be regarded as firm and extension shall be amended on the basis of the rate.
- (c) All errors in totaling in the amount column and in carrying forward totals shall be corrected.
- (d) The totals of various sections of bill of quantities amended shall be carried over to the general summary and the tendered sum amended accordingly. The tendered sum so altered shall, for the purpose of tender, be substituted for the sum originally tendered and considered for acceptance instead of the original sum quoted by the Tenderer. Any rounding of quantities or in sections of bill of quantities or in general summary, by the Tenderer, shall be ignored.

42.8.5 If neither drawing nor specification contain any mention of minor details of construction which in the opinion of the Engineer whose decision shall be final and conclusive, are reasonable and obviously and fairly intended for satisfactory completion of work, such details shall be provided by the contractor without any extra cost, as if they were specially mentioned and shall be deemed to be included in his scope.

#### **42.9 SAFETY CODE**

42.9.1 Besides provision with regard to safety under Clause 27, Contractor shall note that Explosives shall not be used on the work by contractor except with permission in writing of the Engineer and in manner and to the extent to which he has prescribed. Where explosives are used, the same shall be stored in a special magazine to be provided by and at the cost of the contractor who shall be liable for all damages, losses and injury to any person or property and shall be responsible for complying with all statutory obligations in this respect. Further, the contractor is required to provide proper Safety Net System wherever the hazard of fall from height is present as per instructions of BHEL Engineer at site. The safety net shall be duly tested and shall be of ISI mark and the nets shall be located as per site requirement to arrest or to reduce the consequences of a possible fall of persons working at different heights.

42.9.2 The contractor will be responsible for Health, Safety & Environment management at site for the construction activities to be carried out by them in accordance with requirements of BHEL

42.9.3 Contractor shall arrange for following provisions of HSE

1. Contractor has to maintain contact with local hospital having scanning & other modern medical facilities required during emergency.
2. Contractor has to ensure pre employment medical check for all staff & workers.
3. Contractor has to ensure that adequate minimum First Aid facilities with trained nurse & ambulance are available at work site for emergency purpose.. This emergency set-up of contractor should include, but not limited to, following
  - Male nurse (in shifts)
  - Oxygen set up
  - Breathing apparatus
  - Eye wash facility
  - Stretcher
  - Trauma blanket
  - Medicines
  - Ambulance with operator.

However, emergency First Aid facilities as available at BHEL Hospital, Jagdishpur can be utilized in case of emergency on chargeable basis

**42.10 NUISANCE**

42.10.1 The Contractor shall not at any time do, cause or permit any NUISANCE on Site or do anything which shall cause unnecessary disturbance or inconvenience to owners, tenants or occupiers of other properties near the Site and to the public generally.

**42.11 MATERIAL OBTAINED FROM EXCAVATION**

42.11.1 Materials of any kind obtained from EXCAVATION on the Site shall remain the property of BHEL and shall be disposed of as the Engineer may direct, at no extra cost.

**42.12 TREASURE, TROVE, FOSSILS etc.**

42.12.1 All fossils, coins, articles of value or antiquity and structures and other remains or things of geological or archaeological interest discovered on the site shall be the absolute property of BHEL and the Contractor shall take reasonable precautions to prevent his workmen or any other person from removing or damaging any such article or thing, shall immediately upon discovery thereof and before removal acquaint the Engineer with such discovery and carryout the Engineer's directions as to the disposal of the same.

**42.13 PROTECTION OF WORKS**

42.13.1 Trees designated by the Engineer shall be protected from damage during the course of the Works and earth level. Where necessary, such trees shall be protected properly.

42.13.2 The contractor shall provide and maintain at his own expense all lights, guards, fencing and watching when and where necessary or required by the Engineer for the protection of the Works or for the safety and convenience of those employed on the Works or the public.

42.13.3 The contractor shall have total responsibility for protecting his works till it is finally taken over by the Engineer. No claim will be entertained by the Engineer for any damage or loss to the contractor's works and the contractor shall be responsible for the complete restoration of the damaged works to its original condition to comply with the specifications and drawings. Should any such damage to the contractor's works occur because of other party not under his supervision or control, the contractor shall make his claim directly with the party concerned. The contractor shall not cause any delay in the repair of such damaged works because of any delay in the resolution of such disputes. The contractor shall proceed to repair the work immediately and no cause thereof will be assigned pending resolution of such disputes.

42.13.4 Contractor shall be fully responsible for the security of his workmen/ employees/ associates/all kinds of materials deployed by the contractor / tools and plants. Contractor shall also be responsible for the security of all the executed works, under execution works and completed works till the period it is fully taken over by BHEL.

**42.14 RECORD FOR MATERIALS CONSUMED**

42.14.1 The contractor shall maintain and furnish to the Engineer the RECORD OF MATERIALS consumed in the works for each activity. The statement showing the theoretical vis-à-vis actual consumption of specified materials, such as structural /reinforcement steel, cement, bitumen, lead, paint etc., shall be enclosed along with the Running Bills submitted by the contractor. Contractor has to also furnish the test results of the materials used in the work as per IS specifications.

**42.15 PROTECTION OF EMBEDMENTS, BOLTS ETC.**

42.15.1 The contractor shall ensure proper protection to the satisfaction of the Engineer, of all bolts, inserts, embedments etc. from weather etc/ by greasing, rapping them with gunny bags or canvas or by any other means as directed by Engineer. Cost of such protections shall be deemed to be included in the rates quoted for the item.

**42.16 CLEARANCE OF SITE AND REPAIRS.**

42.16.1 Contractor has to clear the site / area where mechanical and electrical erection work is to be commenced / or in progress. The contractor shall remove construction materials and equipment lying in the vicinity and causing obstruction in the erection work within 24 hrs notice. In case, he fails to clear the site, this will be done at his risk & cost by BHEL.

**42.17 QUALITY ASSURANCE**

42.17.1 The contractor has to establish / arrange at site the field testing facilities for testing of civil construction materials and concrete cubes for ensuring the proper quality, grade and strength of the materials used in the construction in line with approved field quality check list of BHEL. Contractor has to submit detailed report for testing of all material used etc. All testing shall be done as per IS code specifications/ BHEL's quality plan. If further test is required by the engineer to be carried from outside laboratory, the cost of the same shall be borne by the contractor.

**42.18 COMPLETION OF WORK**

42.18.1 The works shall be completed to the entire satisfaction of the Engineer and in accordance with the completion schedule as specified in the Contract, and all unused stores and materials, tools, plant, equipment, temporary buildings, site office, labour hutments and other things shall be removed and the site and work cleared of rubbish and all waste materials and delivered up clean and tidy to the satisfaction of the Engineer at the Contractor's expenses.

42.18.2 BHEL shall have power to take over from the Contractor from time to time such sections of the work as have been completed to the satisfaction of the Engineer. Such work however shall not be treated as have been completed until the extra works are executed to the satisfaction of Engineer. The Guarantee period shall commence only after handing over of the entire works.

42.18.3 The Engineer shall certify to the contractor the date on which the work is completed and the date thereof.

**42.19 RECORDS AND MEASUREMENTS**

- 42.19.1 All items having a financial value shall be entered in BHEL measurement Book so that a complete record is obtained of all works performed under the Contract.
- 42.19.2 Lump sum omissions will be entered for deduction. Measurement shall be restricted to that required to ascertain the financial liability of BHEL under the contract.
- 42.19.3 Work, which fails to be measured in details, shall be measured physically without reference to any local custom that may obtain excepting where it may otherwise be directed in the tender documents. The measurements shall be taken jointly by any person duly authorised on the part of BHEL and by the Contractor.
- 42.19.4 The Engineer shall give reasonable notice in writing to the Contractor of appointment for measurement.
- 42.19.5 The Contractor shall, without extra charge, provide assistance with appliances and other things necessary for measurement and shall bear all the cost of measurement of his work.
- 42.19.6 Measurement shall be entered in BHEL Measurement Book and signed and dated by both parties each day at the site on completion of measurement. If the Contractor objects to any of the measurements recorded on the behalf of BHEL, a note to that effect will be made in BHEL Measurement Book or against the item or items objected to and such note shall be signed and dated by both the parties engaged in taking the measurement.
- 42.19.7 If, as a result of such objection, it becomes necessary to re-measure the work wholly or in part the expense of such re-measurement shall be borne by the contractor.
- 42.19.8 If the Contractor's representative fails to attend when required, the Engineer shall have power to proceed by himself to take measurements and in that case these measurements shall be accepted by the Contractor as final.
- 42.19.9 The Contractor shall, once in every month, submit to the Engineer details of his claims for the work done by him up to and including the previous month which are not covered by this Contract Agreement in any of the following respects:
- (a) Deviation from the items and Specifications provided in the Contract documents.
  - (b) Extra items/new items of work.
  - (c) Quantities in excess of those provided in the Contract Schedule.
  - (d) Items in respect of which rates have not been settled.

**43.0 METHOD OF MEASUREMENT**

43.1 Method of measurements shall be as per standard specifications included in the tender. For other items measurements shall be as per relevant IS Codes.

**44.0 DEVIATION**

44.1 The Contractor shall not make any alteration in, addition to or omission from the work as described in the tender documents except in pursuance of the written instructions of the Engineer. No such deviation from the work described in the tender documents shall be valid unless the same has been specifically confirmed and accepted by the Engineer in writing and incorporated in the Contract.

44.2 The Engineer may deviate, either by way of addition or deduction, from the work so described, provided that the Contract sum be not thereby varied on the whole by more than the percentage set out in the tender documents. The value of all additions and deductions shall be added to or deducted from the Contract sum. (Whenever the Engineer intends to exercise such a right his intentions shall specify the deviations which are to be made, the lumpsum assessment or the proposed basis of payment, the extra time allowed, if any, and the date for completion of the entire contract). Any objection by the contractor to any matter concerning the order shall be notified by him in writing to the Engineer within seven days from the date of such order, but under no circumstances shall the work be stopped (unless so ordered by the Engineer) owing to differences or controversy that may arise from such an objection. In the absence of such a notification of objection by the Contractor, he will be deemed to have accepted the order and the conditions stated therein.

**45.0 VALUATION OF DEVIATIONS**

Rates for deviated items or new items of work shall be as follows:

45.1 If the rates for the additional, altered or substituted work are specified in the Contract for the work, the Contractor is bound to carry out the additional, altered or substituted work at the same rates as are specified in the Contract for the work.

45.2 If the rates for the additional, altered or substituted work are not specifically provided in the Contract for the work, the rates will be derived from the rates for a similar class of work as are specified in the Contract for the work.

45.3 If the rates for the altered, additional or substituted work cannot be determined in the manner specified in above clauses the rate for such part or parts will be determined by the Engineer on the basis of prevailing market rates when the work was done and the decision given in this behalf shall be final and binding on the Contractor. Rate analysis will be worked on CPWD manual of rate analysis as guidance.

45.4 If the rates for the altered, additional or substituted work cannot be determined in the manner specified in above clauses, then the contractor shall within 7 days of the date of receipt of order to carry out the work inform the Engineer of the rate at which it is his intention or charge for such class of work, supported by analysis of the rate or rates claimed, and the Engineer shall determine the

rate or rates on the basis of prevailing market rates and pay the Contractor accordingly. However, the Engineer, by notice in writing, will be at liberty to cancel his order to carryout such class of work and arrange to carry it out in such manner, as he may consider advisable. But under no circumstance the Contractor shall suspend the work on the plea of non-settlement of rates falling under the clause or claim any compensation on that account. Elements of profit, overheads, supervision and establishment charges, depreciation and maintenance will be taken as 15% over direct cost.

#### **46.0 COMPLIANCE TO REGULATIONS AND BYELAWS**

46.1 The Contractor shall conform to the provisions of any statute relating to the work and regulations and bylaws of any local authority and of any water and lighting Companies or Undertaking with whose system the work is proposed to be connected. He shall, before making any variation from the drawings or the specifications that may be necessitated for such connections give the Engineer, notice specifying the variation proposed to be made and the reasons therefore and shall not carryout any such variation until he has received instructions from the Engineer in respect thereof. The Contractor shall be bound to give all notices required by statute, regulations or bye-laws as aforesaid and to pay all fees and taxes payable to any authority in respect thereof.

#### **47.0 FACILITIES TO BE PROVIDED BY BHEL / CONTRACTOR**

47.1 BHEL shall provide limited open space for office and store/ workshop at site free of rental charge as and where made available. It is the responsibility of the contractor to develop the space for construction of office sheds, to provide all utilities like electricity, drinking water etc., as a part of his scope of work within the accepted rates. Contractor shall make water arrangement from the water pipe line of local network area. Contractor shall be responsible for providing all necessary facilities like residential accommodation, transport, electricity, water, medical facilities etc. as required under various labour laws and statutory rules and regulations framed there under to the personnel employed by him.

**Contractor shall make his own arrangement of power through DG sets for construction purposes in the initial stages.**

**Electric power for office and workshop depending upon availability will be provided on chargeable basis based upon prevailing rates at one point** within the plant premises at a distance upto 500 meters and as decided by BHEL. Further distribution will have to be made by contractor. The Contractor at his own cost shall install the calibrated Energy meter with specified current transformers and TPN switches for the electricity metering.

All wiring must comply with local regulations and will be subject to Engineer's inspection and approval before connecting supply. Required calibrated energy meter for measurement of power consumed has to be arranged / installed by Contractor at his cost. Non-availability of power supply from BHEL source shall not be an excuse for delay in completion of work. **Sufficient DG sets have to be arranged by the contractor in case of non- availability/ interrupted power supply from BHEL.**

The Contractor shall not effect any change in the temporary installation unless permission is obtained from BHEL or their authorized representatives.

Contractors are requested to take above into account while quoting. The Contractor confirms that unit rates quoted above take care of such variation during execution stage.

- 47.2 The land along with facilities e.g water, sanitation and electricity etc and lease rent for labour colony shall be arranged by the contractor himself near to the site.
- 47.3 On completion / termination of the work, the Contractor shall remove all temporary structure built by him and restore the land in its original condition and the land shall be handed over to BHEL. The Contractor at his cost shall remove debris generated from demolition of temporary structure. If the contractor fails to give vacant possession of the land as aforesaid in the original condition BHEL reserves the right to withhold payment of Contractors bill till handing over of the vacant possession of the land and contractor shall be liable to pay compensation determined by BHEL for such unauthorised occupation of land. The compensation shall be recovered from the bills of contractor, without any notice.
- 47.4 Provision of distribution lines of power from the central points to the required place with proper distribution boards observing the safety rules laid down by the authorities of the state shall be done by the contractor, supplying all the materials like cables, distribution board, switch boards, TPN, CBS, ELCBS/MCCBS / Copper / Brass clamps, copper conductor, change over switches pipes etc. at his own cost. If any failure is caused in supply of the power and water, it is the responsibility of the contractor to make alternate arrangements at his cost. The contractor shall adjust his working shift / hours accordingly and deploy additional manpower if necessary so as to achieve the targets.
- 47.5 In case of power cuts / load shedding no compensation for idle labour or extension of time for completion of work will be given to contractor.
- 47.6 Adequate lighting facilities such as flood lamps, hand lamps and area lighting shall be arranged by the contractor at the site of construction, contractor's material storage area etc. within finally accepted rates.
- 47.7 No claim for damages will be entertained by BHEL on account of interruptions of water supply or limitation of quantity of water as aforesaid or on account of the water so taken being not fit for construction purposes or on any other account in connection with such water supply.
- 47.8 **Construction water on chargeable basis shall be supplied** by BHEL at lump sum rent of Rs 2000/- per month at a single point within a distance of 500 meter from the battery limit. The construction water shall be ground water. The Contractor shall make his own arrangements to lay and maintain necessary distribution lines at his own cost. **Alternatively, contractor can himself arrange for construction water by providing suitable bore well within the quoted rates** at location approved by BHEL and in such case BHEL shall not arrange for construction water for the contractor.
- 47.9 In the event of poor or interrupted water supply by BHEL at site, the contractor then has to make his own arrangement for uninterrupted construction water supply so that work doesn't get effected. This arrangement of water supply shall be without any extra cost to BHEL.

- 47.9 The Contractor should make arrangements for storage of sufficient quantity of water to meet his requirement of two days in well-built water storage tanks with covered tops. The Contractor shall ensure that there is no wastage of water. The contractor shall obtain prior approval of BHEL of the distribution scheme before laying the pipelines.
- 47.10 The Contractor shall during the progress of the work, provide, erect and maintain at his own expenses all necessary temporary workshops, stores, consumables, offices, etc. required for the proper and efficient execution of the work. The planning, setting and erection of these buildings shall have the approval of the Engineer and the Contractor shall at all times keep them tidy and in a clean and sanitary condition to the entire satisfaction of the Engineer.
- 47.11 On completion of work or as and when required by BHEL, all the temporary buildings, structures, pipe lines, cables etc. shall be dismantled and leveled and debris shall be removed as per instruction of BHEL by the contractor at his cost. In the event of his failure to do so, same will be got done by the Engineer and expenses incurred shall be recovered from the contractor along with prevailing overhead. The decision of BHEL Engineer in this regard shall be final.
- 47.12 No residential facilities shall be provided by BHEL for contractor's employees/ workmen and associated agencies.**

**47.12 Gate Passes:**

It is the responsibility of the contractor to arrange gate pass for all his employees, T & Ps etc. Necessary coordination with security officials is the responsibility of the contractor. Contractor shall follow all the laid down procedures for obtaining these gate passes. Contractor shall arrange to receive necessary permits for working beyond normal working hours, working on holidays and during night.

**48.0 PROGRESS REPORTING**

- 48.1 Contractor is required to draw mutually agreed monthly programme in consultation with BHEL well in advance. Contractor shall ensure achievement of agreed programme and shall also timely arrange additional resources considered necessary at no extra cost to BHEL.
- 48.2 Weekly progress review meetings will be held at site during which actual progress during the week vis-a-vis scheduled programme shall be discussed for actions to be taken for achieving targets. Contractor for discussions shall also present the programme for subsequent week. The contractor shall constantly update / revise his work programme to meet the overall requirement. All quality problems shall be discussed during above review meetings. Necessary preventive and corrective action shall be discussed and decided upon in such review meetings and shall be implemented by the contractor in time bound manner so as to eliminate the cause of non-conformities.
- 48.3 The contractor shall submit weekly and monthly progress reports, materials reports, consumables report and other reports as per proforma considered necessary by the Engineer.

- 48.4 The progress report shall indicate the progress achieved against planned , with reasons indicating delays , if any, and shall give the remedial actions which the contractor intends to take to make good the slippage or lost time , so that further works again proceed as per the original programme and the slippages do not accumulate and effect the overall programme.
- 48.5 The daily manpower reports shall clearly indicate the manpower deployed, category-wise specifying also the activities in which they are engaged.
- 48.6 Contractor shall submit periodical reports in respect of the following aspects of operation:
- Consumption of construction power.
  - Daily Manpower report
  - Progress report- daily, weekly and monthly
  - Field Quality checks carried out.-report
  - Field calibration reports
  - HSE reports
  - Accident/ unfortunate mishap report
- BHEL at site shall inform formats for these reports

#### **49.0 DRAWINGS AND DOCUMENTS**

- 49.1 The detailed drawings, specifications available with BHEL engineers will form part of this tender specification. These documents will be made available to the contractor during execution of work at site. The contractor will also ensure availability of all drawings / documents at work place.
- 49.2 Necessary drawings / documents by BHEL to carry out the construction work will be furnished to the contractor by BHEL (except those proposed to be prepared by contractor, as mentioned in this contract, if any) on loan which shall be returned to BHEL Engineer at site after completion of work. Contractor shall ensure safe storage and quick retrieval of these documents.
- 49.3 The contractor shall maintain a record of all drawings and documents available with him in a register as per format given by BHEL Engineer. Contractor shall ensure use of pertinent drawings / data / documents and removal of obsolete ones from work place and return to BHEL.
- 49.4 The data furnished in various annexure enclosed with this tender specification are only approximate and for guidance. However, the change in the design and in the quantity may occur as is usual in any such large scale of work.
- 49.5 Should any error or ambiguity be discovered in the specification or information the contractor shall forthwith bring the same to the notice of BHEL before commencement of work. BHEL's interpretation in such cases shall be final and binding on the contractor.
- 49.6 Deviation from design dimensions should not exceed permissible limit. The contractor shall not correct or alter any dimension / details, without specific approval of BHEL.

**50.0 DELAY AND EXTENSION OF TIME**

50.1 The Contractor shall not be allowed any time extension of completion except in the following cases:

- (a) Force majeure conditions
- (b) Major changes or substantial addition to work ordered by the BHEL adversely affecting the completion time.
- (c) Any other circumstance of any kind whatsoever which may occur making the contractor entitled to an extension of time which, however, shall be in the absolute discretion of BHEL. By reason of any other cause, which in the absolute discretion of the Engineer is beyond the Contractor's control, then in any such case, the Engineer (or higher authority) may make fair and reasonable extension in the completion dates of the individual items of work or the Contract as a whole. Such extension, which will be communicated to the Contractor by the Engineer in writing, shall be final and binding on the Contractor. No other claim in this respect for compensation or otherwise howsoever is admissible. Upon the happening of any such event causing delay, the Contractor shall immediately give notice thereof in writing to the Engineer but shall nevertheless use constantly his best endeavor to prevent or make good the delay and shall do all that may reasonably be required to the satisfaction of the Engineer to proceed with the work.

The Contractor, upon happening of any such event shall immediately present the case. The request for extension of time shall be submitted by the Contractor in writing and based on the merit the case shall be considered.

The contractor shall not be eligible for any time extension on account of delay in procurement of materials.

## ANNEXURE-A

**FINANCIAL VIABILITY**

1. Owner's capital in the business (incase of Partnership, please mention percentage shares and amounts).
2. Quantum of business done during last three financial years.
  - i) Rs.
  - ii) Rs.
  - iii) Rs.
3. Value of fixed Assets of the business in last three years.
  - i) Rs.
  - ii) Rs.
  - iii) Rs.
4. Name, address and email ID of the Bank and Account No:
5. Guarantee limits (if any) enjoyed by the firm.
6. Over draft limits (if any) enjoyed by the firm.
7. Please enclose audited profit and loss account and balance sheet for last 3 years (indicate no of sheets).
8. Certificate from Scheduled Bank to prove Contractor's financial capacity to undertake the work duly indicating the financial limits the tenderer enjoys.

(Signature of tenderer)  
With Stamp

**NOTE:**

All the above documents should be duly certified by auditors/ Chartered Accountant/ Bank as may be applicable.

ANNEXURE-B

**NON DISCLOSER AGREEMENT**

**Memorandum of Understanding**

BHEL, CSU & FP is committed to information security management system as per information security policy.

M/s ....., providing .....  
.....service to BHEL,  
CSU & FP hereby undertake to comply with the following in line with information security policy of BHEL, CSU:

- To maintain confidentiality of documents & information used during the execution of the contract.
- The documents & information shall not be revealed to or shared with third party in a manner which is detrimental to the business interest of BHEL, CSU.

( )

M/s BHEL, CSU & FP

( )

M/s.....

## ANNEXURE - C

**ANALYSIS OF SIMILAR JOBS EXECUTED / IN PROGRESS**

S. No.	Agency by whom awarded	Location of Project	Particulars of work awarded	Scope of work & tonnage	Date of award	Contract value
1	2	3	4	5	6	7
For BHEL						
For Others						

%age work completed and due date for completion	Date of completion if job is already over	No. of skilled / unskilled workers deployed at peak	No. of Engrs. & supervisors deployed at peak	Details of major T&P like cranes, Tractor Trailors, winches, welding M/cs excavators, dumpers batching plants etc supplied		Consumables by whom
				By contractor	By other agency	
8	9	10	11	12	13	14

(SIGNATURE OF TENDERER)  
WITH STAMP

**ANNEXURE - D**

**DECLARATION SHEET**

I, \_\_\_\_\_ hereby certify that, all the information and data furnished by me with regard to this Tender Specification No. \_\_\_\_\_ true and complete to the best of my knowledge. I have gone through the specification, conditions and stipulations in detail and agree to comply with the requirements and intent of specification.

I, further certify that I am the duly authorised representative of the under mentioned tenderer and a valid power of attorney to this effect is also enclosed.

Tenderer's Name & Address

Authorised representative's signature with name and address.

**ANNEXURE - 'E'****CHECKLIST AND SCHEDULE OF GENERAL PARTICULARS**

NOTE: Tenderers are requested to fill in the following details and no column should be left blank

- |    |   |         |
|----|---|---------|
| 1  | Name and address of the tenderer  |         |
| 2  | Telegraphic/ telex address  |         |
| 3  | Phone No. (Office) / Fax No.  |         |
| 4  | Name & designation of the official of the tenderer to whom all the references shall be made.      |         |
| 5  | Tenderer's proposal No. & date  |         |
| 6  | Whether EMD submitted (By cash/ bank draft)   | by..... |
| 7  | Validity of offer/ rates quoted for six months from the date of opening of tender                 | Yes/No  |
| 8  | Financial Status as per Clause 11.1 (in the format as per Annexure-A)                             | Yes/No  |
| 9  | Income tax Clearance certificate as per Clause 11.2, Details of PAN, VAT/ Sales tax registrations | Yes/No  |
| 10 | Details of experience as per clause 11.3 (in the format as per Annexure-C)                        | Yes/No  |
| 11 | Attested copy of power of attorney as per clause 11.4   | Yes/No  |

- |     |   |        |
|-----|---|--------|
| 12  | Details about type of the firm as per clause 11.5   | Yes/No |
| 13  | Declaration sheet as per clause 11.6 (in the format as per Annexure-D)  | Yes/No |
| 14  | Details of PF no. (as per Cl 11.9)  | Yes/No |
| 15. | Non-Disclouser agreement as per Annex-J   | Yes/No |
| 16. | Monthwise manpower deployment plan as per Annex-H   | Yes/No |
| 17. | Status of T & Ps and monthwise T & P deployment plan as per Annex-I   | Yes/No |
| 18. | BHEL may decide to process the price bids through Reverse Auction(RA). Vendor to give their confirmation for participation. | Yes/No |
| 19  | Service tax have been quoted separately in the price bid at it's relevant item  | Yes/No |

Date \_\_\_\_\_ (SIGNATURE OF TENDERER)  
WITH STAMP

WITNESS  
(SIGNATURES WITH FULL PARTICULARS)

1.

2.

**ANNEXURE - F**

**CONTRACT AGREEMENT  
(To be issued on non- judicial stamp paper of appropriate value)**

Agreement No and Date \_\_\_\_\_  
 Name of the Work \_\_\_\_\_  
 Name of the Contractor with full address \_\_\_\_\_  
 Value of work awarded \_\_\_\_\_  
 Letter of Intent No and Date \_\_\_\_\_  
 Scheduled Commencement Date \_\_\_\_\_  
 Scheduled Completion Date \_\_\_\_\_

THIS AGREEMENT MADE THIS \_\_\_\_\_ DAY OF \_\_\_\_\_ 2000 between BHARAT HEAVY ELECTRICALS LIMITED (A Government of India Enterprise) a Company incorporated under the Companies Act, 1956, having its Registered Office at BHEL House, Siri Fort New Delhi- 110049 (herein after called BHEL) of the ONE PART.

AND

M/S \_\_\_\_\_ (hereinafter called the `Contractor') of the SECOND PART.

WHEREAS M/s -----state that they have acquired and possess extensive experience in the field of -----

And Whereas in response to an Invitation to Tender No. ----- issued by BHEL for execution of ----- the contractor submitted their offer No.-----dated -----And whereas BHEL has accepted the offer of the Contractor on terms and conditions specified in the Letter of Intent No.-----dated -----read with the references cited therein.

THIS AGREEMENT WITNESSES AND it is hereby agreed by and between the parties as follows:

1. That the contractor shall execute the work of -----and more particularly described in Tender Specification No -----including Drawings and Specifications (hereinafter called the said works) in accordance with and subject to terms and conditions contained in these presents, instructions to Tenderers, General Conditions of Contract, Special Conditions, Annexures, Letter of Intent dated -----and such other instructions, Drawings, Specifications given to him from time to time by BHEL.
2. The Contractor is required to furnish to BHEL Security deposit in the form of cash/ approved securities/ Bank Guarantee valid upto ----- for a sum of Rs.----- towards satisfactory performance and completion of the Contract.

3. The Contractor has furnished a Bank Guarantee bearing no.-----dated ---  
-----for a sum of Rs.-----executed by -----  
----- in favour of BHEL towards Security Deposit valid upto -----  
OR

The Contractor has furnished to BHEL an initial Security Deposit of Rs.-----  
---in the form of cash / approved Securities/ B.G No.----- dated -----  
- for Rs.-----executed by ----- in favour of BHEL valid  
upto ----- and has agreed for recovery of the balance security deposit by  
BHEL @ 10% of the value of work done from each running bill till the entire  
Security Deposit is recovered.

OR

The contractor has furnished to BHEL an initial Security Deposit of Rs.-----(Rs.---  
----- vide Bank draft No.-----dated -----and by adjusting EMD of  
Rs.-----submitted vide Bank draft No.----- dt.-----) and has  
agreed for recovery of balance Security Deposit by BHEL @ 10% of the  
value of work done from each running bill till the entire security deposit is  
recovered.

4. The Contractor hereby agrees to extend the validity of the Bank Guarantee for  
such further period or periods as may be required by BHEL and if the Contractor  
fails to obtain such extension(s) from the Bank, the Contractor, shall pay forthwith  
or accept recovery of Rs.----- from the bills in one installment and the  
contractor further agrees that failure to extend the validity of the Bank Guarantee  
or failure to pay the aforesaid amount in the manner specified above shall  
constitute breach of contract. In addition to above, BHEL shall be entitled to take  
such action as deemed fit and proper for recovering the said sum of Rs.-----.

OR

In case the contractor furnishes the bank guarantee at a later date the contractor  
hereby agrees to extend the validity of bank guarantee for such further period or  
periods as may be required by BHEL and if the contractor fails to obtain such  
extension(s) from the bank, the contractor shall pay forthwith or accept recovery  
of the amount of bank guarantee given in lieu of security deposit from the bills in  
one installment and the contractor further agrees that failure to extend the  
validity of bank guarantee or failure to pay the aforesaid amount in the manner  
specified above shall constitute breach of contract. In addition to above, BHEL  
shall be entitled to take such action as deemed fit and proper for recovering the  
said sum.

5. That in consideration of the payments to be made to the Contractor by BHEL in  
accordance with this Agreement the Contractor hereby covenants and  
undertakes with BHEL that they shall execute, construct, complete the works in  
conformity, in all respects, with the terms and conditions specified in this  
Agreement and the documents governing the same.
6. That the Contractor shall be deemed to have carefully examined this Agreement  
and the documents governing the same and also to have satisfied himself as to  
the nature and character of the Works to be executed by him.
7. That the Contractor shall carry out and complete the execution of the said works  
to the entire satisfaction of the Engineer or such other officer authorised by

BHEL, within the agreed time schedule, the time of completion being the essence of the Contract.

- 8. That BHEL shall, after proper scrutiny of the bills submitted by the Contractor, pay to him during the progress of the said works such sum as determined by BHEL in accordance with this Agreement.
- 9. That this Agreement shall be deemed to have come into force from ----- the date on which the letter of intent has been issued to the Contractor.
- 10. That whenever under this contract or otherwise, any sum of money shall be recoverable from or payable by the Contractor, the same may be deducted in the manner as set out in the General Conditions of Contract or other conditions governing this Agreement.
- 11. That all charges on account of Octroi, Terminal and other taxes including sales tax or other duties on material obtained for execution of the said works shall be borne and paid by the Contractor.
- 12. That BHEL shall be entitled to deduct from the Contractor's running bills or otherwise Income Tax under Section 194 (C) of the Income Tax Act, 1961.
- 13. That BHEL shall be further entitled to recover from the running bills of the Contractor or otherwise such sum as may be determined by BHEL from time to time in respect of consumables supplied by BHEL, hire charges for tools and plants issued (Where applicable) and any other dues owed by the Contractor.
- 14. That it is hereby agreed by and between the parties that non- exercise, forbearance or omission of any of the powers conferred on BHEL and /or any of its authorities will not in any manner constitute waiver of the conditions hereto contained in these presents and the liability of the Contractor with respect to compensation payable to BHEL or Contractor's obligations shall remain unaffected.
- 15. It is clearly understood by and between the parties that in the event of any conflict between the Letter of Intent and other documents governing this Agreement, the provisions in the Letter of Intent shall prevail.

16. The following documents

- 1. Invitation to Tender No-----  
and the documents specified therein.
- 2. Contractor's Offer No-----  
dated-----.
- 3. \_\_\_\_\_
- 4. \_\_\_\_\_
- 5. \_\_\_\_\_
- 6. Letter of Intent No \_\_\_\_\_  
dated \_\_\_\_\_.
- 7. \_\_\_\_\_

shall also form part of and govern this Agreement.

IN WITNESS HEREOF, the parties hereto have respectively set their signatures in the presence of

WITNESS

(CONTRACTOR)  
(to be signed by a person holding  
a valid Power of Attorney)

1.

2.

WITNESS

(For and on behalf of BHEL)

1.

2.

**Annexure-G****PROFORMA FOR SECURITY DEPOSIT BANK GUARANTEE**

This deed of Guarantee made this .....day of ..... two thousand and ..... by .....(Bank) herein after called the " The Guarantor" ( which expression shall unless repugnant to the context or meaning thereof be deemed to include it's successors and assigns ) in favour of M/s Bharat Heavy Electricals Limited ( A Govt. of India Undertaking) a company incorporated under the Companies Act, 1956, having it's registered office at BHEL House , Siri Fort, Asiad, New Delhi- 110049 through it's unit at Jagdishpur, distt, Sultanpur ( UP) herein after called " The Company" ( which expression shall unless repugnant to the context or meaning thereof by deemed to include it's successors and assigns)

WHEREAS .....(herein after referred to as the Contractor) have entered into contract arising out of Letter of Intent no. .... dt.....( herein after referred to as "the contract") for the construction of ..... with the company.

AND WHEREAS the contract inter-alia provides that the contractor shall furnish to the company a sum of Rs.....( Rupees ..... ) towards security deposit for due and faithful performance of the contract in the form and manner specified therein .

AND WHEREAS the contractor has approached the Guarantor and in consideration of the arrangement arrived at between the Contractor and the Guarantor, the Guarantor has agreed to give the Guarantee as hereinafter mentioned in favour of the company.

The Guarantor do hereby guarantee to the company the due and faithful performance, observance or discharge of the Contract by the contractor and further unconditionally and irrevocably undertake to pay to the Company without demur and merely on a demand, to the extent of Rs.....( Rupees.....) against any claim by the company on them for any loss , damage, costs, charges and expenses caused to or suffered by the company by reasons of the contractor making any default in the performance, observance or discharge of the terms, conditions, stipulations or undertakings or any of them as contained in the contract.

The decision of the company whether any default has occurred or has been committed by the contractor in the performance, observance or discharge of any of the terms, conditions, stipulations or undertakings or any one of them as contained in the contract and/ or as to the extent of loss, damage, costs, charges and expenses caused to or suffered by the company by reason of the contractor making any default in the performance, observance or discharge of any of the terms, conditions, stipulations or undertakings or any one of them shall be conclusive and binding on the Guarantor irrespective of the fact whether the contractor admits or denies the default or questions the correctness of any demand made by the company in any Court, Tribunal or Arbitration proceedings or before any other Authority.

The company shall have the fullest liberty without affecting in any way the liability of the Guarantor under this Guarantee, from time to time to vary any of the terms and conditions of the contract or extend time of performance by the contractor or to postpone for any time and from time to time any of the powers exercisable by it against the contractor and either enforce or forebear from enforcing any of the terms and conditions governing the contract or securities available to the company and the Guarantor shall not be released from its liability under these presents by any exercise by the company of the liberty with reference to the matters aforesaid or by reasons of time being given to the contractor or any other forbearance act or commission on the part of the company or any indulgence by the company to the contractor or any other matter or thing whatsoever which under the law relating to securities would, but for this provision have the effect of so releasing the Guarantor from its liability under this guarantee.

The Guarantor further agrees that the Guarantee herein contained shall remain in full force and effect during the period that would be taken for the performance of the contract and its claim satisfied or discharged and till the company certifies that the terms and conditions of the contract have been fully and properly carried out by the contractor accordingly discharges this Guarantee, subject however, that the company shall have no claim under this Guarantee after..... i.e, ( the present date of validity of Bank Guarantee unless the date of validity of this Bank Guarantee is further extended from time to time, as the case may be ) unless a notice of the claim under this Guarantee has been served on the Guarantor before the expiry of the said period in which case the same shall be enforceable against the Guarantor notwithstanding the fact that the same is enforced after the expiry of the said period.

The Guarantor undertakes not to revoke this Guarantee during the period it is in force except with the previous consent of the Company in writing and agrees that any liquidation or winding up or insolvency or dissolution or any change in the constitution of the contractor or the Guarantor shall not discharge the Guarantor's liability hereunder.

It shall not be necessary for the company to proceed against the contractor before proceeding against the Guarantor and the Guarantee herein contained shall be enforceable against them notwithstanding any security which the company may have obtained or obtain from the Contractor shall at the time when proceedings are taken against the Guarantor hereunder be outstanding or unrealized.

Notwithstanding anything contained herein before, our liability under the Guarantee is restricted to Rs ..... ( Rupees.....). Our guarantee shall remain in force until....., i.e, ( the present date of validity of Bank Guarantee unless the date of validity of this Bank Guarantee is further extended from time to time ) unless a claim or demand under this guarantee is made against us on or before.....we shall be discharged from our liabilities under this Guarantee thereafter.

Any claim or dispute arising under the terms of this document shall only be enforced or settled in the courts having jurisdictions at Jagdishpur, Distt. Sultanpur (U.P.) only.

The Guarantor hereby declares that it has power to execute this guarantee and the executants have full powers to do so on behalf of the Guarantor.

IN WITNESS whereof the .....(Bank)  
has hereunto set and subscribed it's hand the day, month and year first, above written,

the Bank  
Signed for and on behalf of  
No,.....) ( Signatory

WITNESSES

- 1. Name and Address
  
- 2. Name and Address

Notes:

- 1. The above BG shall be executed on the non-judicial stamp papers of adequate value procured in the name of the bank in the state where the bank is located.
- 2. The above BG is required to be sent by the executing bank directly to BHEL at the address where tender is submitted/ accepted under seal cover.

**Annexure- H**

**MONTHWISE MANPOWER DEPLOYMENT PLAN**

S.NO. Category	No. of persons available on rolls of the organization	Months (indicate No. of persons to be deployed in each month)					
		Ist	2 <sup>nd</sup>	3 <sup>rd</sup>	4 <sup>th</sup>	5 <sup>th</sup>	6 <sup>th</sup> and so on
1.							
2.							
3.							
<b>Total</b>							

(Signature of tenderer)  
With Stamp

**Annexure- I**

**(A) STATUS OF TOOLS & PLANTS :**

S.No.	Name of Equipment	Quantity Owned	Registration No wherever applicable	Documents enclosed for proof of ownership	Present Location	Quantity to be deployed for this job
-------	-------------------	----------------	-------------------------------------	---	------------------	--------------------------------------

**(B) MONTHWISE T&P DEPLOYMENT PLAN**

S.NO.	Description of T & P	Months (indicate No. to be deployed in each month)					
		Ist	2 <sup>nd</sup>	3 <sup>rd</sup>	4 <sup>th</sup>	5 <sup>th</sup>	6 <sup>th</sup> and so on

- 1.
- 2.
- 3.

**ANNEXURE- "J"**

**CERTIFICATE OF DECLARATION CONFIRMING THE KNOWLEDGE OF SITE  
CONDITIONS**

We.....  
..... here by declare and confirm that we have visited the project site under  
the subject namely,.....and  
acquired full knowledge and information about the site conditions, wage structure,  
industrial climate and total work involved. We further confirm that the above  
information is true and correct and we will not raise any claim of any nature due to  
lack of knowledge of site condition.

**Tenderers Name and Address**

Date:  
(Signature of Tenderer)  
With Stamp

**ANNEXURE- "K"****Details of court cases pending against BHEL**

Certified that following court cases are pending against BHEL unit as per the details hereunder-

S.No.	Name of BHEL Unit	Details of work undertaken	Contract Period		Contract No.	Name of Court
			From	To		

- 1.
- 2.
- 3.

It is also certified that, in addition to above, M/s ..... have never been debarred / prohibited for execution of any work with any office / unit of BHEL

(Signature of tenderer)  
With Stamp

**ANNEXURE- L**

**LIST OF BANKS**

1. State Bank of India.
2. ABN AMRO BANK N.V.
3. Bank of Baroda
4. Canara Bank
5. CITI Bank N.A.
6. Deutsche Bank AG
7. HDFC Bank Ltd
8. ICICI Bank Ltd
9. IDBI Ltd
10. Punjab National Bank
11. Standard Chartered Bank
12. State Bank of Hyderabad
13. State Bank of Travancore
14. The Hongkong and Shanghai Banking Corporation Ltd.
15. Corporation Bank
16. Syndicate Bank
17. Oriental bank of commerce
18. Indian Bank



**BHARAT HEAVY ELECTRICALS LIMITED  
CENTRALISED STAMPING UNIT & FABRICATION  
PLANT  
Jagdishpur**

**TENDER FOR ENHANCING THE 11 KV POWER SUPPLY  
AND IT'S DISTRIBUTION INCLUDING PROVIDING,  
INSTALLING, COMMISSIONING OF SUB STATION AND IT'S  
EQUIPMENTS ON TURNKEY BASIS AT JAGDISHPUR**

**Tender Enquiry No: BHE/FP/CVL/026**

**SECTION III**

**SPECIAL CONDITIONS OF CONTRACT**

**BHARAT HEAVY ELECTRICALS LIMITED  
(A GOVERNMENT OF INDIA UNDERTAKING)  
CSU & FP  
Industrial Area  
Jagdishpur (UP) 227817**

**SECTION-III****SPECIAL CONDITIONS OF CONTRACTS****1. INTRODUCTION**

- 1.1. The terms and conditions mentioned in this section are in addition to what are stated in Section – II (General Conditions of Contract) of the tender document. In case of any contradiction between the terms and conditions given in Section - II and those specified in this Section- III, the terms and conditions of this Section–3 shall prevail.

**2. SITE LOCATION**

- 2.1. Bharat Heavy Electricals Ltd. is setting up a manufacturing plant at Jagdishpur; district Sultanpur UP, for production of fabricated components and electrical components . New facility will be located adjacent to the existing Insulator Plant (IP) and upcoming centralized stamping unit (CSU) of BHEL. The site area is about 31.6 Acre. The site location is about 80 KM south east of Lucknow on Lucknow Varanasi highway and approx 55 KM from Sultanpur and 210 Km from Varanasi. The nearest Airport is Amousi at Lucknow.

**3. SCOPE OF WORK :**

- 3.1 (a) The scope of work will broadly cover laying of 11 KV XLPE- HT cable from the source to the sub station inside the multistory township comprising of Type- A, B, C & D blocks of upto eight stories and other utilities and buildings in the under construction township .The contractor shall also supply, erect, test and commission the transformers , DG sets and control panels as per BOQ. Contractor shall also be responsible for obtaining all necessary statutory clearances from the government authorities/ regulatory bodies , UPSIDC, UP PWD (for right of way) etc and safety clearances from UP electrical safety deptt. Contractor shall also prepare drawings required by these statutory authorities for obtaining NOC. Other items of scope of BHEL supplies includes the Civil , architectural works and services of multistory township and construction of electrical sub station building and foundations in particular.
- (b) Bidder's scope shall also be maintenance of sub station during guarantee period along with necessary spares and T & Ps, consumables and skilled, unskilled manpower.
- 3.2. The bidder's scope shall broadly include supply, installation, testing and commissioning , maintenance all complete as per BOQ, specifications and drawings.
- 3.3. In addition to above the bidder's scope shall also cover engineering and submission of drawings/designs details/ brochures / technical write ups /

manufacturer's test certificates and field test results etc, as applicable, along with source of supplies for the bought out items pertaining to his scope of supplies and execution for the passenger lift.

- 3.4. It is mandatory for the bidder to produce manufacturer test certificates of materials incorporated into the lifts .
- 3.5. The specific technical requirements for work to be executed under this Contract shall be as per Section V. **The applicability of specifications shall be limited to the scope of works only as specified in the BOQ.** Civil works items indicated are for general information only.
- 3.6. The scope of work will also include such other related works although they may not be specifically mentioned above and all such incidental items not specified but reasonably implied and necessary for completion of the job as a whole and as desired and as directed by the engineer. The detail scope of work covered above is not a comprehensive list of items of work involved. The detail scope of work may vary considerably depending on the actual construction requirements.
- 3.7. Unless otherwise specified, the work to be provided by the contractor for the items mentioned in the "Bill of Quantities" shall include but not be limited to the following.
  - a) Furnishing all labour, materials, supervision, construction plans, equipment, supplies, transport, to and from the site, fuel, electricity, compressed air, water, transit and storage insurance and all other incidental items and temporary works not shown or specified but reasonably implied or necessary for the proper completion, maintenance and handling over the works, except in accordance with the stipulations laid down in the contract documents and additional stipulations as may be provide by the engineer during the course of works.
  - b) Furnishing samples of all materials required by the engineers for testing / inspection and approval for use in the works. The engineer for final incorporation in the works may retain the samples.
  - c) Furnishing test reports for the products used or intended to be used, if called for the specifications or if so desired by the engineer.
  - d) Giving all notices, paying all fees, taxes etc., in accordance with the general conditions of contract, that is required for all works including temporary works.
  - e) Arranging manufacturer's supervision for items of work done as per manufacturer's specifications when so specified.
  - f) Carrying out topographic survey of required area and establish levels and coordinates at suitable intervals from existing grid levels and coordinates furnished by the owner established bench marks, setting out the locations and levels of proposed structures, constructions and marking of reference pillars

and other identification works etc., The contractor shall provide BHEL such a assistance, instruments, machines, labour and materials as are normally required for examining, measuring and testing any work and the quality, weight or quantity of any material used.

- g) Providing all incidental items not shown or specified but reasonably implied or necessary for the successful completion of the work in accordance with contract.
  - h) Make necessary storage arrangement / sheds of adequate capacity to store cement within his normal scope without any extra cost to BHEL.
  - i) Arrange necessary T & P and IMTEs for carrying out the work. A list of such T & P and IMTEs required for such work as a minimum is given in **Annexure SCC-I and SCC-II.**
- 3.8. BHEL is ISO 9001-2000, ISO 14001-1996 and OHSAS 18001-1999 certified company. The contractor in all respects shall organize his work, systems, environment, process control documentation, tools, plant, inspection, measuring and testing equipments etc. as per instructions of Engineer.
- 3.9. The contractor shall also comply with applicable legislation and regulations with regards to Health, safety and environmental aspects for minimizing risk arising from occupational health, safety hazards, controlling pollution and wastage.
- 3.10. BHEL and their Consultant may depute their representative for checking and supervision of important stages of work. The contractor shall be required to provide all facilities for inspection of works at no extra cost to BHEL. Any defect in quality of work or deviations from drawings / specifications pointed out during such inspection shall be made good by the contractor in the same way as if pointed out by the BHEL Engineer, without any cost implication to BHEL.

#### 4. TIME SCHEDULE

- 4.2. The contractor is required to commence the work within 15 days from the date of issue of letter of intent unless BHEL decides to fix any other later date.
- 4.3. Entire work/ installations as detailed in tender specification shall be completed within **6 (six) months** as per the programs / milestones decided by BHEL from time to time .The date of start of work shall be taken as given in Letter of Intent.
- 4.4. The start date for the indicative mile stones shall be as per the **annexure-SCC-III** and as directed by BHEL from time to time. The Contractor shall ensure that the mile stones are completed in time.
- 4.5. Contractor has to mobilise adequate resources to meet his commitments to BHEL as indicated from time to time. **In case due to reasons not attributable to the contractor, the work gets delayed and additional manpower / resources**

**have to be mobilized so as to expedite the work to meet various milestones, same shall be done within the quoted rates as per Rate Schedule, at no extra cost to BHEL.** In the event the contractor fails to respond to these requirements, BHEL shall take appropriate actions to meet its commitments in line with the provisions of General Conditions of Contract.

- 4.6. In case due to reasons not attributable to the contractor, the work gets delayed and scheduled completion gets extended, time extension will be granted by BHEL but in no case over run compensation will be payable.
- 4.7. The work under the scope of this contract is deemed to be completed in all respects, only when all the works are carried out as per satisfaction of BHEL. The decision of BHEL on completion date shall be final and binding on the contractor.

## 5. TAKING OVER OF WORKS BY BHEL

- 5.2. All works/ installations shall be taken over by BHEL in part or in full when it has been completed in all respects and /or can be put to use satisfactorily. The complete work under the contract shall be taken over only after completion of all punch points, pending work, rework wherever required, site clearing and reconciliation of materials.
- 5.3. The guarantee period shall start only after the complete work under the contract has been taken over by BHEL.

## 6. PRICE

- 6.2. Price quoted shall be fixed and not subject to any escalation whatsoever during the period of execution of the Contract including the extended period, if any.
- 6.3. The quoted price shall include all taxes and duties (except service tax) . Service tax shall be quoted separately in the bill of quantities and price schedule under section-IV.
- 6.4. Price quoted shall be in INR (Indian national Rupee) only.
- 6.5. **No price variation /over run charges** on account of any increase whatsoever, (irrespective of whether escalation is steep/ unanticipated) will be payable during the entire period of execution of Contract including extended period, if any.

## 7. SALES TAX / WORKS CONTRACT TAX

- 7.2. Sales tax on transfer of property in goods involved in works contract is applicable as per laws in force in U.P. state .The contractor shall register him self with the sales tax authorities of the state and submit proof of such registration to BHEL along with the first RA bill. Deduction of tax at source shall be made as per the provisions of law. The TDS shall be deducted from the bills of the contractor and

deposited with the UP trade tax authorities. Present rate of TDS on this account is 4 % (Four percent). If UP Trade tax authorities allows compounding scheme then the tax at source shall be deducted accordingly.

- 7.3. Contractor shall get his organization registered with concerned sales tax authorities within 30 days of award of this contract. The delay on this account and delay in bringing the material shall be to contractor's account and no extension of time shall be allowed on this account. The sales tax registration for this contract shall be forwarded to BHEL. In case the contractor is already registered for sales tax with Govt. Authorities he must quote his registration no., while submitting their tender.
- 7.4. Contractor has to make his own arrangement at his cost for completing the formalities, if required, with Sales Tax Authorities, for bringing their materials, plants, and equipment at site for the execution of the work under this contract.
- 7.5. With introduction of Cenvat credit rules 2004 which come into force w.e.f. 10.09.2004, excise duty paid on input goods including capital goods used for providing the output service and service tax paid on input service can be taken credit of against the service tax payable on output service. As such, while offering the rates, the contractors may take into account the benefit of above provisions as the cost of input to contractors will be the cost net of excise duty and service tax and adjust their offer price accordingly to make it more competitive.

## 8. SERVICE TAX

- 8.2. Contractor's price/ rates shall be exclusive of service tax and cess on output services.
- 8.3. Contractor shall deposit the service tax with the concerned tax authorities, such amount will be paid by BHEL. Contractor shall submit to BHEL documentary evidence of service tax registration and remittance records of such tax immediately after depositing the tax with the concerned authorities.
- 8.4. (i) The prevailing rate of service tax is 4.12 % (Four point one two percent) effective from 01/03/2008, inclusive of education cess and SAH education cess under works contract (composition scheme for payment of service tax) Rules, 2007  
  
(ii) Service tax payable on free issue of material by BHEL shall be reimbursed as per prevalent rule . However, prior consent of BHEL shall be required for calculating value of free material issued.

**9. INCOME TAX**

- 9.2. Income Tax at the prevailing rate on gross value of work done and applicable surcharge and education cess shall be deducted from the running bills as per relevant rules unless exempted by the Income Tax Authorities.

**10. NEW TAXES/ LEVIES**

- 10.2. In case the Government imposes any new tax/ levy on the output services/ goods / work after the award of work, the same shall be reimbursed by BHEL at actuals. All necessary documents as required by BHEL shall have to be provided by the contractor. However, in the event of delay in work execution solely attributable to the contractor the new taxes/ levies imposed during the delay period shall not be reimbursed to the contractor.
- 10.3. In case any tax/levy/duty etc becomes applicable after the date of bidder's offer, the bidder/ Contractor must convey it's impact on his price duly substantiated by documentary evidence in support of the same before opening of the Price Bid. Claim for any such impact after opening the price bid will not be considered by BHEL for reimbursement of tax or reassessment of offer.
- 10.4. No reimbursement on account of increase/ decrease in the rate of taxes, levies, duties etc on input goods/ services/ work shall be made. Bidder has to make his own assessment of the impact of future variation if any, in rates/ duties/ levies etc in his price bid.

**11. MODALITIES OF TAX INCIDENCE ON BHEL**

- 11.2. Wherever the relevant tax laws permit more than one option or methodology for discharging the liability of tax/levy/duty, BHEL will have the right to adopt the appropriate one considering the amount of tax liability on BHEL as well as procedural simplicity with regard to assessment of the liability. The option chosen by BHEL shall be binding on the contractor for discharging the obligation of BHEL in respect of the tax liability to the contractor.
- 11.3. The contractor shall pay all (save the specific exclusions as enumerated in this contract) taxes, fees, misc. charges, deposits, duties, tools, royalties, commissions or other charges which may be levied on the input goods and services delivered in course of his operations in executing the contract. In case BHEL is forced to pay any of such taxes, BHEL shall have the right to recover the same from his bills or otherwise as deemed fit.

**12. RATE SCHEDULE CUM BOQ**

- 12.2. Contractor shall fully understand description and scope of work before quoting. The scope of work and responsibility of the contractor as mentioned under this specification shall be covered within the quoted / finally accepted rates.
- 12.3. The Tenderer shall quote the prices/rates for entire scope of work as per the rate schedule only, in part II - price bid. Conditional price bids or price bids with any deviation / clarification etc. are liable to be rejected. No cutting / erasing / over writing shall be done.
- 12.4. Quantities mentioned in the rate schedules are approximate only and liable for variation both on positive and negative sides. The tentative contract value (CV) for entire scope of work shall be calculated as per finally quoted / accepted item rates & the quantities indicated in Rate Schedule cum BOQ.
- 12.5. In addition to the above, the Contractor shall also submit the rates as asked for in the **Annexure: SCC-IV**.

**13. EVALUATION OF THE OFFERS**

- 13.2. Comparison of the prices & determination of lowest bidder shall be as per Price Schedule for the complete scope.
- 13.3. The grand total price of all the items in BOQ shall be the basis for deciding the lowest bidder. Refer section-IV i.e Bill of Quantities and price schedule

**14. VARIATION IN SCOPE OF WORK / DEVIATION LIMIT**

- 3.1. BHEL reserves the right to add or delete items of scope of work depending upon the final requirement. For such addition or deletion the Contract value shall be adjusted based on the quoted unit price. Such variation is not expected to be more than  $\pm 30\%$  of the contract value. However, the quantities in the BOQ are tentative which may vary or deviate upto any limit provided the contract value is limited to  $\pm 30\%$ . The price quoted by the Contractor shall be valid for such variation. Variation beyond the above limit shall be settled on mutually agreed rates. This clause to be read in conjunction with Cl 44 and 45 of section-II i.e GCC.

**15. EXTRA WORK**

- 15.2. The Contractor shall, when requested by BHEL, perform extra work at mutually agreed rates.

**16. TERMS OF PAYMENT**

- 16.2. The Contractor shall be paid monthly running bill of **90%** of the value of the work actually executed on site provided the work has been executed to the satisfaction of the Engineer.
- 16.3. The balance **10%** of the bill value shall be released as follows--
- (a) The **5.0%** of the bill value shall be payable on taking over of schedule works by BHEL as per each mile stones completion mentioned in annexure-SCC-III along with the running bills. The amount to be released shall be calculated prorata based upon the agreed executed value of each milestone derived from the quoted rates and executed quantities till completion of such mile stones.
  - (b) The **2.5%** of the bill value shall be released on completion of Mile Stone - 2 mentioned in annexure-SCC-III along with the final bill.
  - (c) The balance **2.5%** of bill value will be payable on completion of the guarantee period. BHEL reserves the right to release this amount on successful completion of all mile stones and upon submission of equivalent bank guarantee valid upto the guarantee period.
- 16.4. From the amount payable, recovery such as advances, security deposit, taxes etc. would be made.
- 16.5. Measurement of work completed shall be done by the Contractor and submitted to BHEL for checking and approval. For this purpose, Contractor shall submit hard copies as well as a soft copy in the CD containing abstract & detailed measurement sheets of the bill. The measurement sheets and the bill will be checked and approved by BHEL for further processing, or returned to the Contractor for correction and resubmission. The certificate of Engineer regarding such approval and passing of sums shall be final and conclusive against the Contractor.
- 16.6. The abstract of the measurements and RA bill shall be entered in BHEL Measurement Book and signed and dated by both parties as per the provisions of the General Conditions of Contract.
- 16.7. All running bill payments shall be regarded as advance payments against the final bill. Any certificate relating to the work done during monthly running bills may be modified by any subsequent interim certificates or by the final certificates and no certificate of the Engineer supporting an advance payment shall of itself be conclusive evidence that any work or materials to which it relates are in accordance with the contract.
- 16.8. In case any amount is withheld by BHEL during course of execution of work on account of non-compliance of contract requirement, the same shall be recovered / released from the contractors bills as deemed fit by the engineer-in-charge of

BHEL and the decision of engineer-in-charge shall be final in this regard and binding on the contractor.

#### **16.9. Mobilisation Advance :**

**16.9.1** Interest bearing mobilisation advance can be accepted by BHEL on request of the contractor limited to a maximum of 5% of the contract value . Such mobilisation advance shall be payable after acceptance of order and submission of contract security deposit. The mobilisation advance shall be interest bearing and secured through bank guarantee of 1.2 times of advance amount valid for 12 months initially and thereafter extension for a period upto which the advance is fully adjusted not exceeding the completion schedule.

**16.9.2** The recovery of mobilisation advance shall be made from the running bills to an extent of 10% of each progressive bill amount along with interest charges till it is fully recovered. The interest rate shall be the prime lending rate of State Bank of India (SBI) plus 2%.

**16.9.3** Mobilisation advance shall be released subject to signing of contract agreement and physical mobilisation at site by the contractor which includes opening of site office, construction of testing laboratory and cement stores, sufficient T& Ps mobilisation at site of work and upon certification of BHEL engineer regarding start of work.

#### **17. GUARANTEE**

**17.2.** The works / installations done by the Contractor shall be guaranteed for a period of 24 (twenty four) months from taking over of all works / installations by BHEL i.e Mile Stone-2 in annexure SCC-III. During this period the Contractor shall attend to all the matters relating to the Contract work and rework as required by BHEL.

#### **18. PENALTY FOR DELAY**

**18.1** If the Work is not completed within the specified period and any extension thereof, the Contractor shall be liable to pay penalty for delay in completion of work @ 0.5% of the value of each mile stone awarded for every week of delay or part thereof, subjected to a maximum of 10 % of the awarded contract value without BHEL being required to establish and prove the actual loss /damage suffered by BHEL on account of such delay. The value of each mile stone shall be calculated as per Cl 18.2 below.

**18.2** The mile stone value shall be calculated prorata based upon the agreed awarded value of each milestone derived from the quoted rates and quantities in section-IV i.e price schedule and BOQ till completion of such mile stones. These mile stones are listed in annexure-SCC-III.

## **19. COMPLETION CERTIFICATES/ NOC FROM LOCAL STATUTORY BODIES**

- 19.2. Contractor has to arrange at his own cost to obtain building/ work completion certificates or NOCs if required to be obtained from the local statutory bodies of central and state govt. such as lift safety deptt., electrical safety, UPSIDC, Fire authority, UP PWD, UP pollution control board etc. However, any fees required for obtaining such NOCs shall be paid by BHEL on production of relevant depository challans/ receipts from such Govt. authorities.

## **20. DRAWINGS AND SPECIFICATIONS**

- 20.2. Following detailed drawings of township are enclosed for reference purpose only. Drg Nos CSU/FP/01 to 08 (Eight sheets).
- 20.2 The construction of the works/ supplies and installations shall be taken up on the basis of construction drawings which shall be issued by BHEL after award of the work.
- 20.3 Contractor shall submit it's drawing along with bill of material for supplies to BHEL upon award of work order.

**Annexure-SCC-I****INDICATIVE LIST OF TOOLS AND PLANTS (T&Ps) TO BE ARRANGED BY THE CONTRACTOR AT HIS OWN COST**

<b>SL NO</b>	<b>EQUIPMENT</b>	<b>QUANTITY</b>
1	HYDRA CRANE 8 / 10 T	1 NO
2	MOBILE CRANE 15/18 T	1 NO
3	15/20 MT TRAILORS WITH PULLING UNIT	1 NO
4	WATER TANKER	AS PER REQUIREMENT
5	DEWATERING PUMP	AS PER REQUIREMENT
6	POWER / HAND WINCHES	AS PER REQUIREMENT
7	WELDING MACHINES	AS PER REQUIREMENT
8	HEATING OVEN	AS PER REQUIREMENT
9	DG SETS OF REQUIRED CAPACITY	AS PER REQUIREMENT
10	PORTABLE OVENS	AS PER REQUIREMENT

**NOTES**

- 1 The above list specifies only major T&Ps (may not be complete to be deployed by the contractor). All additional / other tools and plants including trucks & devices, tackles, machines, measuring instruments etc. in good and safe working conditions which are required for satisfactory & timely completion of work shall also be deployed by the contractor within finally accepted rate / price.
- 2 Other terms and conditions regarding above items please also refer clause 38 T&P/IMTEs).

**Annexure- SCC II****INDICATIVE LIST OF INSPECTION MEASURING AND TESTING EQUIPMENTS  
(IMTEs) TO BE ARRANGED BY THE CONTRACTOR AT HIS OWN COST**

<b>SL NO</b>	<b>EQUIPMENT</b>	<b>QTY</b>
1	THEODOLITE ONE SECOND ACCURACY	1 NO
2	DUMPY LEVEL UPTO 350 MM	2 NO
3	HEATING OVEN	1 NO

**NOTES:**

1. The above list specifies only major IMTEs (may not be complete to be deployed by the contractor). Contractor has to set up the field laboratory with facilities required for material & concrete testing. All additional / other IMTEs / measuring instruments etc. in good and safe working conditions which are required for satisfactory & timely completion of work shall also be deployed by the contractor within finally accepted rate / price.
2. Other terms and conditions regarding above items please also refer clause 38 T&P/IMTEs).

**Annexure- SCC-III****INDICATIVE MILE STONES TO BE ACHIEVED DURING THE CONTRACT EXECUTION**

Entire work shall be completed as per time schedule. However, the indicative period of completion for the following major mile stones is as follows (To be reckoned from the date of LOI issue). The same shall be finalised mutually after award of work based upon BHEL's requirement and contractor shall furnish micro detailing including resource planning to achieve such intermediate mile stones of the project . Such detailed schedule to be furnished by the contractor immediately after award of work but before mobilization:

- (a) **MILE STONE- 1:** Commissioning of electrical sub station with all equipments for drawing quality LT power supply : **5 months**

(Includes all items of Sec-IV i.e BOQ & price schedule )

- (c) **MILE STONE- 2:** Completion of all works including disposition of punch points ,material reconciliation, site clearing and final handing over : **6 months**

- NOTE: 1) Contractor shall submit to BHEL detailed monthly schedule along with resource planning after placement of LOI but before mobilization to site for achieving above mile stones .
- 2) Contractor shall submit value of each mile stone based upon the accepted final rates and the quantities as per BOQ cum rate schedule of section-IV in prorate basis.

**ANNEXURE: SCC -IV****ANALYSIS OF UNIT RATE QUOTED**

Sl.no.	Description	Percentage of the unit rate quoted	Remarks
1.	Salary & Wages of Staff & workers		
2.	Consumables (a) Gases (b) Welding Electrodes (c) P.O.L. (d) Others		
3.	Depreciation & maintenance for T & Ps		
4.	Depreciation & maintenance for other items		
5.	Establishment and administrative expences of site		
6.	Overheads		
7.	Profit		

(Signature of tenderer)  
With Stamp



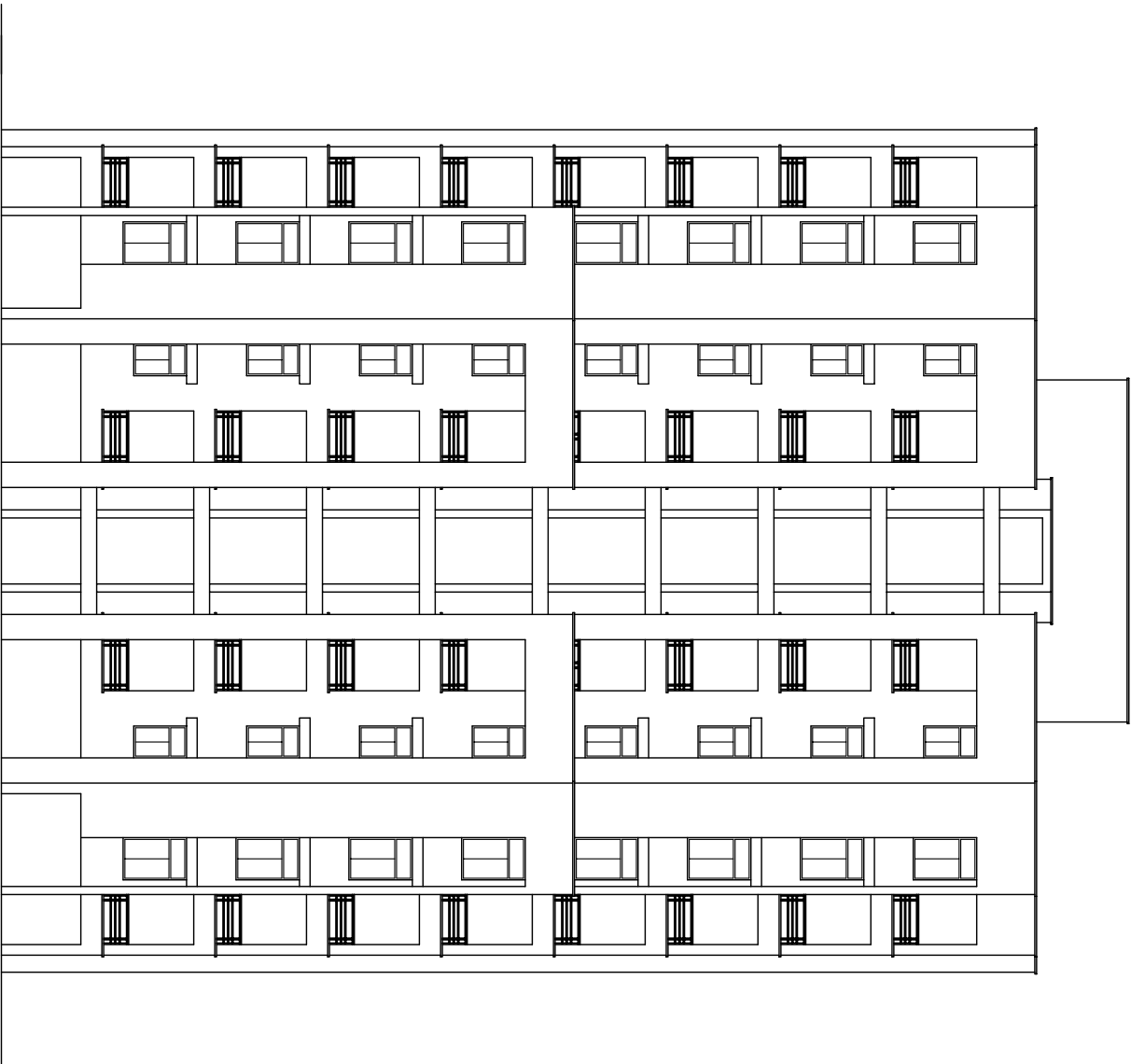

FRONT ELEVATION  
(1/200)

- NOTE :
1. ABOVE TO BE EXECUTED BASED UPON FINISHING SPECIFICATION
  2. CHART OF EACH TYPE OF CONSTRUCTION AS ATTACHED
  3. DETAILS TO BE READ IN CONJUNCTION WITH BOQ ITEMS
- FACILITIES SHOWN ARE INDICATIVE WHICH IS SUBJECT TO VARIATION DEPENDING UPON REQUIREMENT AND APPROVAL BY BHEL

PRELIMINARY DRAWING  
FOR TENDER PURPOSE  
ONLY

	TOWNSHIP CSU & FP
	BHEL, JAGDISHPUR
	SKETCH No. CSU/FP/02
	DATE 20/07/2009 REV No. 00

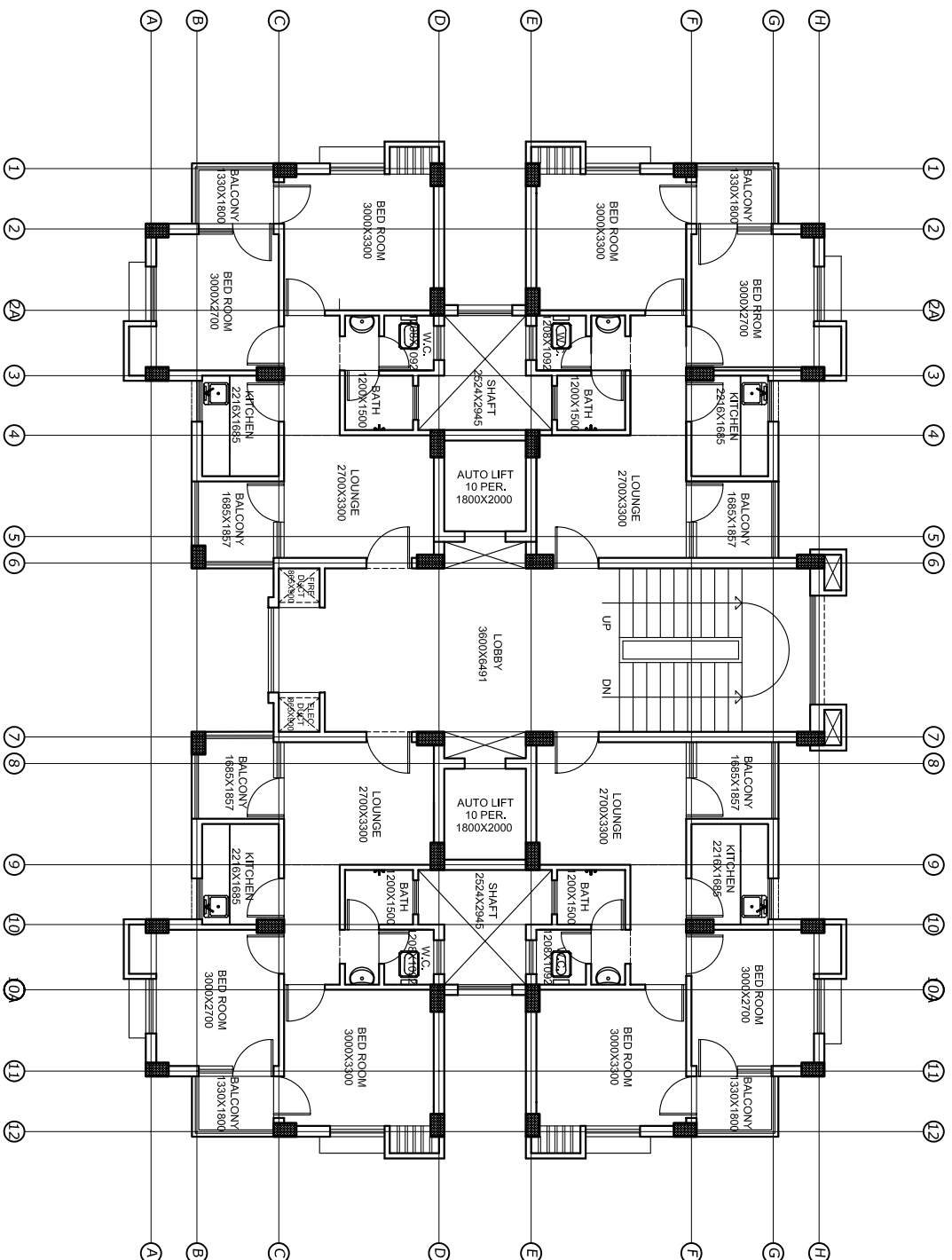

**TYPICAL FLOOR PLAN  
BLOCK-A**

- NOTE : 1. ABOVE TO BE EXECUTED BASED UPON FINISHING SPECIFICATION  
 2. CHART OF EACH TYPE OF CONSTRUCTION AS ATTACHED  
 3. DETAILS TO BE READ IN CONJUNCTION WITH BOQ ITEMS  
 4. FACILITIES SHOWN ARE INDICATIVE WHICH IS SUBJECT TO VARIATION  
 5. DEPENDING UPON REQUIREMENT AND APPROVAL BY BHEL

PRELIMINARY DRAWING  
FOR TENDER PURPOSE  
ONLY

	TOWNSHIP CSU & FP BHEL, JAGDISHPUR
SKETCH No. CSU/FP/03	DATE 20/07/2009 REV No. 00

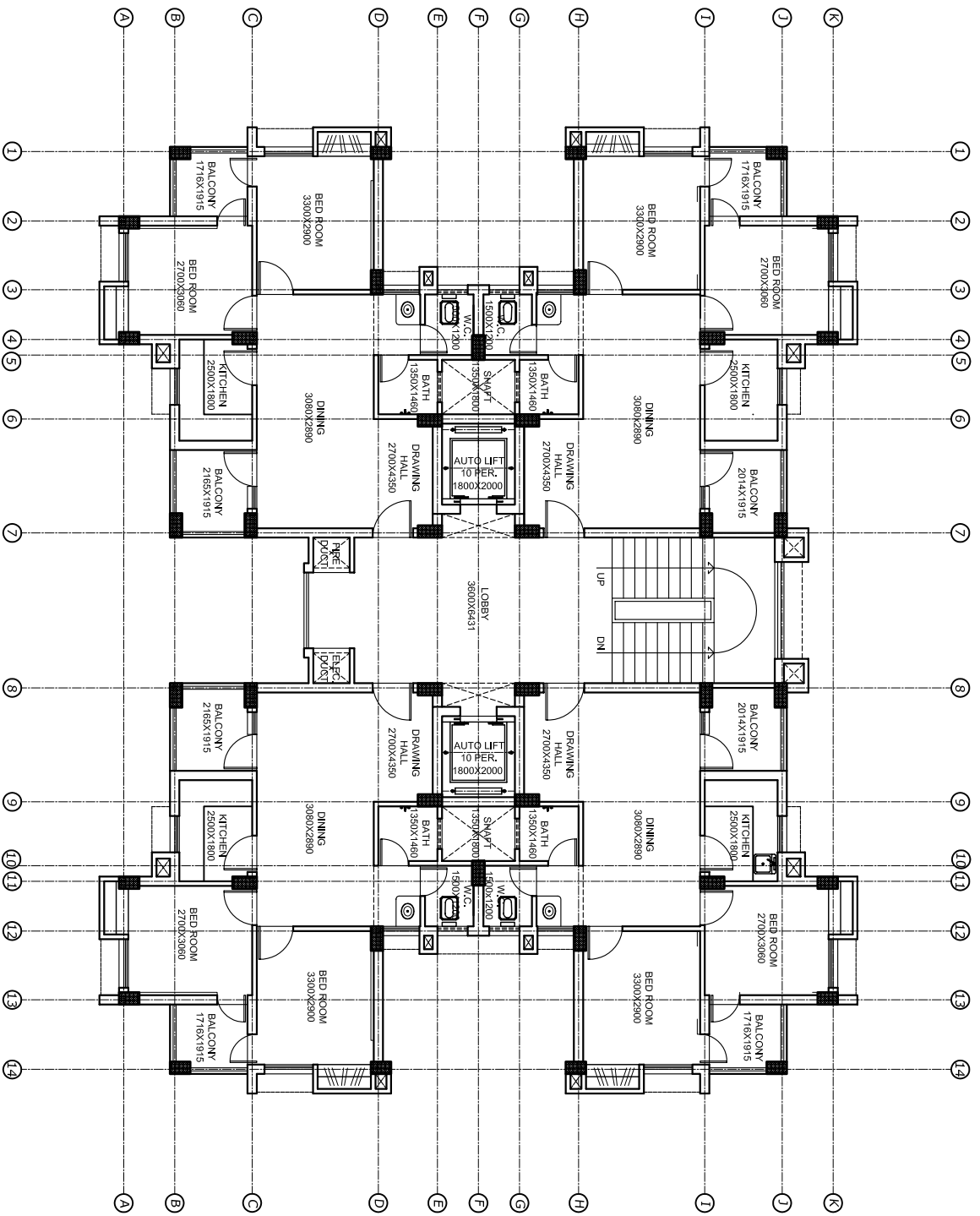

**TYPICAL FLOOR PLAN  
(TYPE-B)**

- NOTE : 1. ABOVE TO BE EXECUTED BASED UPON FINISHING SPECIFICATION  
 2. CHART OF EACH TYPE OF CONSTRUCTION AS ATTACHED  
 3. DETAILS TO BE READ IN CONJUNCTION WITH BOQ ITEMS  
 4. FACILITIES SHOWN ARE INDICATIVE WHICH IS SUBJECT TO VARIATION  
 5. DEPENDING UPON REQUIREMENT AND APPROVAL BY BHEL

PRELIMINARY DRAWING  
 FOR TENDER PURPOSE  
 ONLY

**भारतीय**  
**एन**

TOWNSHIP CSU & FP  
 BHEL, JAGDISHPUR  
 SKETCH No. CSU/FP/04  
 DATE 20/07/2009 REV No. 00

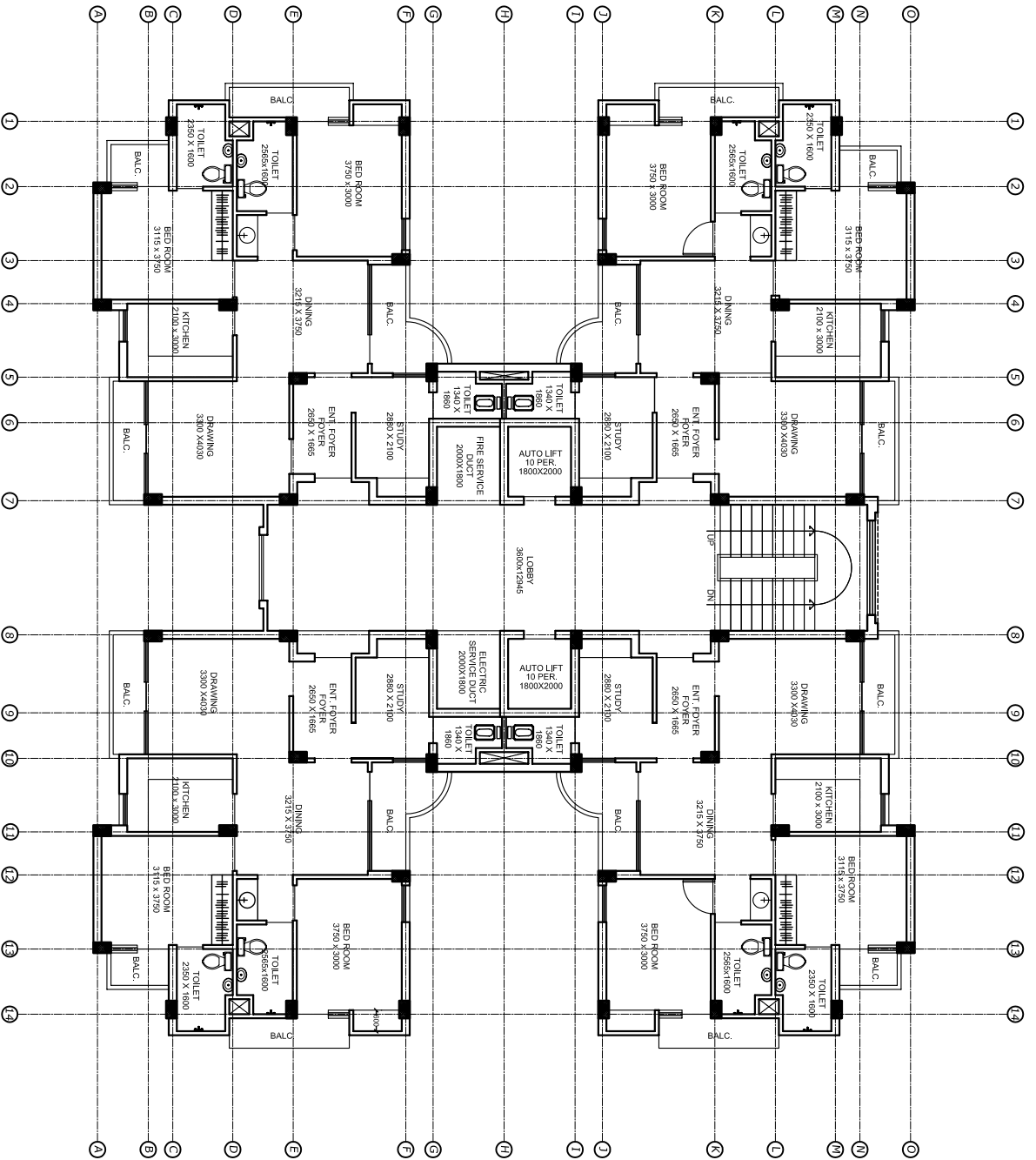

TYPICAL FLOOR PLAN  
BLOCK - C

PRELIMINARY DRAWING  
FOR TENDER PURPOSE  
ONLY

- NOTE :
1. ABOVE TO BE EXECUTED BASED UPON FINISHING SPECIFICATION CHART OF EACH TYPE OF CONSTRUCTION AS ATTACHED
  2. DETAILS TO BE READ IN CONJUNCTION WITH BOQ ITEMS
  3. FACILITIES SHOWN ARE INDICATIVE WHICH IS SUBJECT TO VARIATION DEPENDING UPON REQUIREMENT AND APPROVAL BY BHFL

	TOWNSHIP CSU & FP
	BHEL, JACDISHPUR
	SKETCH No. CSU/FP/05
	DATE 20/07/2009 REV. No. 00

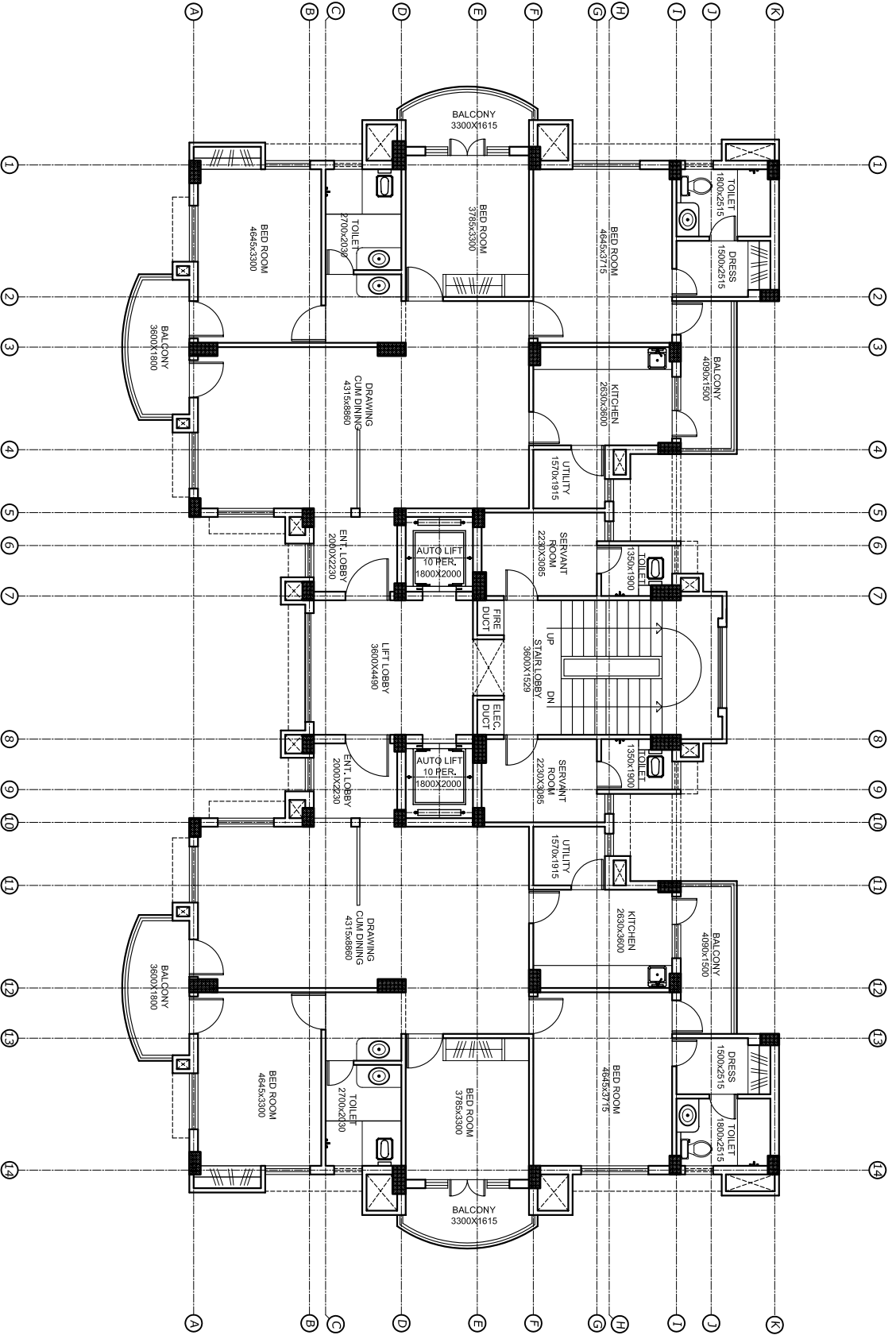

**TYPICAL FLOOR PLAN**  
**TYPE-D**

PRELIMINARY DRAWING  
FOR TENDER PURPOSE  
ONLY

- NOTE : 1. ABOVE TO BE EXECUTED BASED UPON FINISHING SPECIFICATION  
 2. CHART OF EACH TYPE OF CONSTRUCTION AS ATTACHED  
 3. DETAILS TO BE READ IN CONJUNCTION WITH BOQ ITEMS  
 4. FACILITIES SHOWN ARE INDICATIVE WHICH IS SUBJECT TO VARIATION  
 5. DEPENDING UPON REQUIREMENT AND APPROVAL BY BHFL

	TOWNSHIP CSU & FP
	BHEL, JAGDISHPUR
	SKETCH No. CSU/FP/06
DATE 20/07/2009 REV No. 00	

POWER OBTAIN FROM O/H 11KV GRID

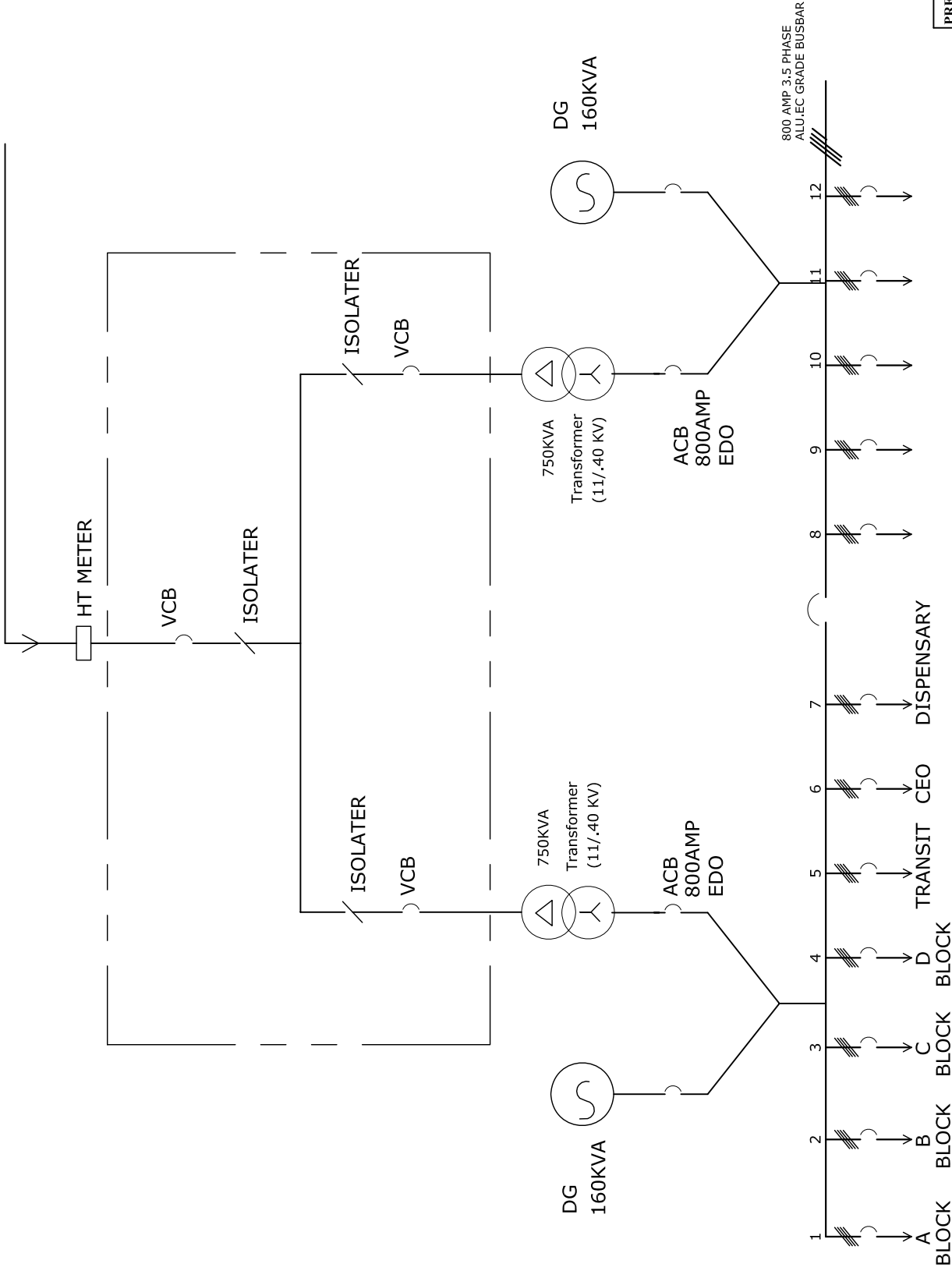

OUT GOING FOR BLOCK & STORIES WISE

- NOTE : 1. ABOVE TO BE EXECUTED BASED UPON SPECIFICATIONS  
 2. DETAILS TO BE READ IN CONJUNCTION WITH BOQ ITEMS  
 3. FACILITIES SHOWN ARE INDICATIVE WHICH IS SUBJECT TO VARIATION DEPENDING UPON REQUIREMENT AND APPROVAL BY BHEL

SINGLE LINE DIAGRAM FOR COLONY SUB STATION

PRELIMINARY DRAWING  
 FOR TENDER PURPOSE  
 ONLY

TOWNSHIP CSU & FP  
 BHEL, JAGDISHPUR  
 SKETCH No. CSU/FP/07  
 DATE 03/09/2010 REV No. 00

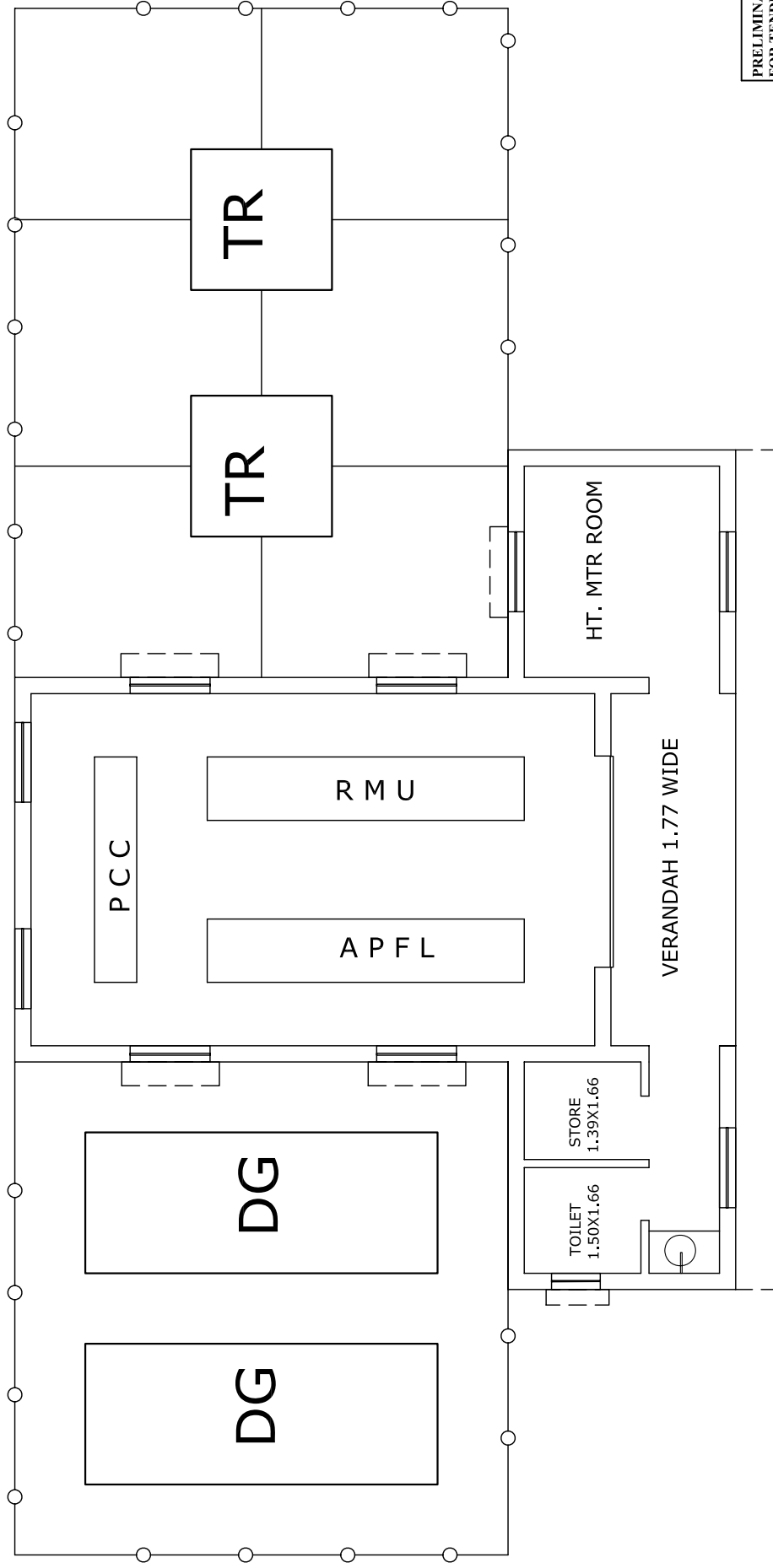

- NOTE :
1. ABOVE TO BE EXECUTED BASED UPON SPECIFICATIONS
  2. DETAILS TO BE READ IN CONJUNCTION WITH BOQ ITEMS
  3. FACILITIES SHOWN ARE INDICATIVE WHICH IS SUBJECT TO VARIATION DEPENDING UPON REQUIREMENT AND APPROVAL BY BHEL

PRELIMINARY DRAWING  
FOR TENDER PURPOSE  
ONLY

TOWNSHIP CSU & FP  
BHEL, JAGDISHPUR  
SKETCH No. CSU/FP/08  
DATE: 03/09/2010 REV. No. 00

**SUB STATION PLAN DETAIL**



**BHARAT HEAVY ELECTRICALS LIMITED  
CENTRALISED STAMPING UNIT & FABRICATION  
PLANT  
Jagdishpur**

**TENDER FOR ENHANCING THE 11 KV POWER SUPPLY  
AND IT'S DISTRIBUTION INCLUDING PROVIDING,  
INSTALLING, COMMISSIONING OF SUB STATION AND  
IT'S EQUIPMENTS ON TURNKEY BASIS AT  
JAGDISHPUR**

**Tender Enquiry No: BHE/FP/CVL/026**

**SECTION IV**

**BILL OF QUANTITIES AND PRICE SCHEDULE**

**BHARAT HEAVY ELECTRICALS LIMITED  
(A GOVERNMENT OF INDIA UNDERTAKING)  
CSU & FP  
Industrial Area  
Jagdishpur (UP) 227817**



**BHARAT HEAVY ELECTRICALS LIMITED  
CENTRALISED STAMPING UNIT & FABRICATION  
PLANT, Jagdishpur**

**TENDER FOR ENHANCING THE 11 KV POWER SUPPLY  
AND IT'S DISTRIBUTION INCLUDING PROVIDING,  
INSTALLING, COMMISSIONING OF SUB STATION AND IT'S  
EQUIPMENTS ON TURNKEY BASIS AT JAGDISHPUR**

**Tender Enquiry No: BHE/FP/CVL/026**

**SECTION V**

**TECHNICAL SPECIFICATION**

**(SPECIFIC TECHNICAL REQUIREMENTS FOR ELECTRICAL WORKS)**

**BHARAT HEAVY ELECTRICALS LIMITED  
(A GOVERNMENT OF INDIA UNDERTAKING)  
CSU & FP  
Industrial Area  
Jagdishpur (UP) 227817**

## SECTION V

### **SPECIFIC TECHNICAL REQUIREMENTS FOR ELECTRICAL WORKS**

#### **1.0 GENERAL**

This section covers specific technical requirements for electrical works of contract and should be read in conjunction with BOQ and other sections of the contract. In case of any conflict between the contents of BOQ and technical Specifications, BOQ will prevail over technical specification.

**The following sections of technical specification may be read for such clauses which are relevant to this tender.**

#### **2.0 FREE ISSUE MATERIALS**

Nothing shall be supplied as free issue material by BHEL.

#### **3.0 DISMANTLING OF EXISTING STRUCTURES**

The contractor will have to carryout dismantling of buried/ semi buried structures, if any, encountered within the battery limit and disposal of it within plant boundary as directed by BHEL at no extra cost to BHEL.

#### **4.0 STATUTORY REQUIREMENTS**

Bidder shall comply with all the applicable statutory rules pertaining to Factories Act, Fire Safety Rules of Tariff Advisory Committee, Water Act for pollution control, Explosives Act, etc. Provisions of safety, health and welfare according to Factories Act shall be complied with. Statutory clearances and norms of State Pollution Control Board shall be followed. Bidder shall obtain approval of electrical drawings from concerned authorities before taking up the work.

#### **5.0 WORKMANSHIP**

Workmanship shall be of the best possible quality and all work shall be carried out by skilled workmen except for those which normally require unskilled persons. Welding shall be done by experienced and certified welders in proper sequence using necessary jigs and fixtures. Fabrications shall be done in shops having proper equipment for accurate edge planning and milling of column shall ends, base late surfaces etc. and shaping and dimensioning of anchor bolt assembly, inserts and other misc. items. In addition to the requirement specified above, if the bye-laws of the local Govt., Municipal or other authorities require the employment of licensed or registered workmen for various traders, the contractor shall arrange to have the work done by such registered or licensed personnel. In case of manufactured materials, the Contractor shall have, with no additional cost to the owner, the services of the supervisors of the manufacturers to achieve that the work is being done according to the manufacturer's specifications.

## 6.0 TEMPORARY WORK

All scaffoldings, staging, temporary bracing and other necessary temporary work required for proper execution of the Contract shall be provided by the Contractor at his own cost and inclusive of all materials, labour, supervision and other facilities.

The layout and details of such Temporary work shall have the prior approval of the Engineer as agreed, but the Contractor shall be responsible for proper strength and safety of the same. All Temporary work shall be so constructed as not to interfere with any permanent work or with the work by other agencies. If it is necessary to remove any of the temporary work at any time to facilitate execution of the work or with the work of other agencies, such removal and re-erection, if required, shall be carried out by the Contractor at the discretion of the Engineer without any delay and any extra cost on this account shall be borne by the Contractor.

## 7.0 INTERFACE WITH STRUCTURES UNDER OTHER'S SCOPE

a) In cases of interface e.g. structures under other's scope of supply being supported on structures under scope of this contractor, the same will be discussed and suitably addressed.

b) Modification in layout of foundation/structure during detail engineering stage may be necessary to avoid fouling with those under other's scope. Necessary changes on this account will be made without any extra cost to Owner.

c) Necessary engineering is to be done and provisions are to be kept accordingly by the Contractor to construct foundations/underground structures, etc. without disturbing/ endangering the constructions done under the scope of other contracts.

## 8.0 INSPECTION, TESTING AND QUALITY CONTROL FOR ELECTRICAL WORKS

Sampling and testing for major items of electrical works shall be carried out in accordance with the requirements of this specification and field quality plan (FQP).

The bidder shall submit for BHEL's approval a detailed field quality assurance programme for electrical works before starting of the construction work. This shall include frequency of sampling and testing nature/type of test, method of test, setting of a testing laboratory, arrangement of testing apparatus/equipment, deployment of qualified/experienced manpower, preparation of format for record, Field Quality Plan, etc. Tests shall be done in the field and/or at a laboratory approved by the Engineer and the Bidder shall submit to the Engineer, the test results in triplicate. In addition, the bidder shall furnish the original test certificate from the manufacturer's of various materials to be used in the construction.

If any work found to be of inferior quality or sub-standard, the same shall be dismantled and shall be redone as per approved quality or relevant standard. BHEL reserve the rights to reject the work of inferior quality. All expenses on account of dismantling and rework shall be born by contractor.

**The contractor's finally accepted rates shall include cost of such field tests with standard equipments and IMTEs**

## 9.0 CONSTRUCTION / ERECTION METHODOLOGY

- All fabrication and erection activities of structural steel shall be carried out using automatic submerged arc welding machines, cutting machine, gantry cranes, crawler / wheel mounted heavy cranes and other equipments like heavy plate

bending machines, shearing machines, lathe, milling machines etc. Use of derricks shall not be permitted.

- All handling of materials shall be with cranes. Heavy tailors shall be used for transportation.
- Mechanized modular units of scaffolding and shuttering shall be used.
- Grouting shall be carried out using hydraulically controlled grouting equipment.
- All finishing items shall be installed using appropriate modern mechanical tools.
- Manual punching etc. shall not be permitted.
- Heavy duty hoist for lifting of construction materials shall be deployed.
- Compressors for cleaning of foundations and other surfaces shall be used.
- All persons working at site shall be provided with necessary safety equipment and all safety aspects shall be duly considered for each construction/erection activity. Moreover, only the persons who are trained in the respective trade shall be employed for executing that particular work.
- Fabrication and Erection of all fabricated columns shall be done in single piece unless otherwise provided for in the approved drawings. Main columns of the power house building can have maximum of one number of the erection splice. All shop and site splice shall suitably staggered. The erection splice shall be provided with full strength splice cover plate over the butt weld. Contractor shall submit the erection scheme for the erection of all type of structures and carryout the erection work only after approval of the scheme by the owner.

#### **11.0 FIELD LABORATORY FACILITIES AT SITE FOR MATERIAL TESTING:**

Contractor shall provide field testing facilities at site laboratory built by the contractor

#### **12.0 MAKE OF BOUGHT OUT MATERIAL:**

Contractor shall supply bought out items as per the list attached at **Annexure-A-1** (16 Sheets) of this section.

#### **13.0 SPECIFIC TECHNICAL REQUIREMENT FOR ELECTRICAL WORKS FOR BUILDINGS :**

- All electrical fittings shall be concealed in walls ,floors and roofs.
- Telephone, cable wires shall be provided in each room.
- Fittings shall be of superior make.

#### **14.0 OTHER TECHNICAL REQUIREMENT FOR ELECTRICAL WORKS**

Contractor shall ensure **deployment of Qualified & Experienced Safety Engineer / Officer** at site. **It may be noted that non-compliance to this will result in penal action as may be decided by the competent authority of BHEL.**

Some of the common safety rules to be followed during working are as follows

- No outsider is allowed to enter construction area without permission.
- No body is allowed to enter at construction site without Safety Shoe.
- Never enter work area without Safety helmet & chin strap in place.
- No climbing/working allowed without proper safety belt above 2 m. height.
- Do not exceed the speed limit 25 Kmph within premises.

- No debris obstacles allowed on the roads & passages.
- All accidents/incidents to be reported to site Incharge.
- Do not walk on pipelines or false ceiling.
- Maintain good Housekeeping at work site.
- No photography/ Videography allowed without permission
- Risk factor in construction is approximately 3 times the manufacturing sector.
- 85% of the workforce is drawn from rural background. They lack technical perspective & relevant industrial common sense. Safety awareness to be developed among these workers employed by Sub-contractors.
- Infrastructure to be developed for carrying out jobs properly in a safe manner.
- All Site supervisors & engineers (including subcontractor's) must be imparted structured training on construction safety before start of the job & record to be maintained.
- Availability of qualified & trained Site Engineer at site during all working hours.
- Site Safety training to be imparted to all workers & plan to be made to cover every worker.
- Tools box talk (5-15 minutes) by supervisor prior to commencement of any job.
- All accident / incidents(Near Miss) to be reported & investigated.(formats & procedure should be finalized)
- Daily Safety Checking by Each Site Engineer along with Safety engineer.
- Weekly co-ordination meeting of all Safety engineers with BHEL safety officer.
- Monthly safety meeting with Site In-charges.
- Reports: Weekly/monthly/annual SHE report format should be finalized.
- All Safety equipment must be ISI marked & checked by Safety officer before use.
- Tag system for erection & use of scaffoldings.
- Bamboo/wooden Scaffolding material not allowed.
- LPG cylinders not allowed for gas cutting.
- Good House keeping. Separate waste bins to be used for flammable & non flammable material.
- Safety awareness programs for workers by display of boards, posters, competitions, talks etc.
- Deployment of Safety Supervisors for every 250 workers and part there of at work site.
- Display of List of First Aid trained persons.
- Testing certificates for lifting tools & tackle.
- Provision & maintenance of fire extinguishers at construction site & material stores.
- Display of emergency telephone numbers at various locations.
- For work in confined space use 24 V lamp fitting & use tools with air motors or electric tools with max. 24 V.
- For confined space entry Gas test must be done before & at regular intervals.
- Checking & tag of equipment like grinding machine, welding machine, gas cutting set etc. by supervisors before use.

**Further, the contractor is required to provide proper Safety Net System wherever the hazard of fall from height is present as per instructions of BHEL Engineer at site. The safety net shall be fire resistant, duly tested and shall be of ISI mark and the nets shall be located as per site requirement to arrest or to reduce the consequences of a possible fall of persons working at different heights**

## 15. ERECTION

All works such as cleaning, checking, levelling, aligning, assembling, temporary erection for alignment, dismantling of certain equipment for checking, cleaning, surface preparation, fabrication at site, cutting, grinding, straightening, blue matching, chamfering, filing, chipping, drilling, machining, surface grinding, shaping, fitting up etc. as may be applicable in such erection works are to be treated as incidental to erection and necessary to complete the work satisfactorily and shall be carried out by the contractor as part of the work.

Any fixtures, scaffolding materials, concrete block supports, steel structures required for temporary supporting, for pre-assembly or checking, welding, lifting and handling during pre-assembly and erection shall be arranged by contractor at his cost.

The following provisions cover the technical requirements for some of equipment installation. The brief idea about the work involved is indicated below however the work is to be carried out in accordance with the recommendations of the equipment manufacturer drawings, documents furnished to the contractor by BHEL or as directed by BHEL Engineer.

### 16.0 LT OIL FILLED SERVICE TRANSFORMERS :

Scope of work includes checking and preparation of foundation surface, erection of accessories and auxiliaries, carrying out minor modification wherever required; Preparation of oil and oil filling under vacuum, dry out of transformer, testing of transformer, oil and other auxiliaries, laying of cable trays upto marshalling box, cabling upto marshalling box and termination for auxiliaries, earthing of accessories to earth conductor / riser, testing of all auxiliaries, pre-commissioning and back charging of transformers.

Painting of Transformer (**Including supply of paint**), as approved by BHEL Engineer. The other requirements of Transformers to be furnished by the bidder are –

### SCHEDULE OF GUARANTEED TECHNICAL PARTICULARS OF TRANSFORMERS

S N	Particular	Requirement
1	Capacity in KVA	750
2	Make	GTB/Voltamp/Kirloskar/Crompton
3	Reference Standards	
	Transformer design & testing	IS2026
	Loading	IS 6600
	Oil	IS 335
	Porcelain bushing	IS 3347
4.	Tolerance on electrical parameters	IS 2026
5	Duty	Continuous duty
6	Windings	EG Copper, Double wound
7	Core	CRGO
8	Type	outdoor
9	Rated Input	11000 V
10	Rated Output	433 V

S N	Particular	Requirement
11	Frequency	50 Hz+/-3 Hz
12	No. of Phases	3
13	Input configuration	Delta
14	Output Configuration	star
15	Vector Group	Dyn 11
16	Tapping	Off circuit tap changer shall be provided on HV winding in variation from +/-5% in steps of 2.5%.
17	Cooling	ONAN
18	Max. ambient temperature	50° C
19	Max. oil temperature rise	45° C
20	Max. winding temperature rise	55° C
21	HV side High voltage withstand test	70 KV
22	LV side High voltage withstand test	3 KV
23	% impedance at 75° C	6.25%
24	Mounting of cooling radiators	Detachable
25	Induced over voltage withstand test	
	applied on LV side	0.866 KV
	induced on HV side	66 KV
26	Terminal Arrangement	
	HV side	Cable Box
	LV side	Cable Box
	Neutral	Required
27	Standard fittings	
	NAME,RATING & DIAGRAM PLATE	Required
	EARTHING TERMINALS	Required
	LIFTING LUGS	Required
	OIL LEVEL INDICATOR	Required
	FILTER VALVE WITH PLUG	Required
	DRAIN CUM SAMPLING VALVE	Required
	CONSERVATOR WITH OIL FILLING HOLE	Required
	THERMOMETER POCKET	Required
	DIAL TYPE OIL TEMP.INDICATOR WITH MAX. INDICATING POINTER	Required
	AIR RELEASE PLUG	Required
	DEHYDRATING BREATHER	Required
	EXPLOSION VENT	Required
	INSPECTION COVER	Required

S N	Particular	Requirement
	FIRST FILLING OF TRANSFORMER OIL CONFORMING TO IS:335	Required
	SILICA GEL BREATHER	Required
	BIDIRECTIONAL WHEEL	Required
	BUCHHOLZ RELAY WITH ALARM & TRIP	Required
	MARSHALLING BOX	Required
	WTI WITH ALARM & TRIP	Required
	OTI WITH ALARM & TRIP	Required
	MAGNETIC OIL LEVEL GAUGE	Required

#### 17.0 PANELS – POWER , CONTROL & RELAY ( LTMCCs , GRP / GCPs ,Unit Aux Control Board and Station Aux Control Board etc.)

Erection at site / control room including chipping of floor, fabrication and fixing of base channel frame, levelling & alignment with spirit level, welding the base channel to the embedded plates / channels, grouting , fixing of anti-vibration pads, termination of inter panel connections, mounting / connections of loose instruments, inter panel bus bar connections, commissioning including loop checking, system checking, and putting necessary controls on automatics. ***Tenderer may note that fabrication / fixing / painting of base channel(Including supply of paint),/ suitable steel stool, if required, is included under the scope of this work. Contractor will be paid for fabrication / erection as per applicable rates for structural steel fabrication / erection..*** Checking of internal wiring, rectification, testing and calibration of equipment mounted inside is in the scope of contractor. The contractor may have to change / replace items found faulty without any extra cost, however materials for this shall be provided by BHEL. Mostly panels will be delivered fully wired. However wherever required termination of loose wires , bus wires is to be done. Canopy for panels will be supplied loose & shall be installed by the contractor after erection of panels. The cleaning of panels have to be done with electrical vacuum cleaner, besides conventional cleaning with brush etc. The drilling of holes in the gland plates for cable entry shall be part of panel erection. All blank holes / gaps in the gland plates / boxes etc. shall be properly sealed. The base frames shall be painted suitably. The contractor shall carry out the plugging and sealing of left out holes in the gland plates and other openings at the bottom of panels at his own cost by using fire retardant mortar or good quality sealing material as advised by BHEL . **Any minor alterations required in the bus bar arrangement, wiring in the panels/ cubicles shall also form part of the work. During testing, commissioning, some equipment / modules may need replacement / repairs. All such replacements / repairs and assistance during commissioning and running of the unit till handing over to the Customer are part of the scope as some of the test / commissioning will have to be done after the machine is running on various loads.**

Touch-Up Painting with paint(***Including supply of paint***), as approved by BHEL Engineer .

## 18.0 CABLE RACK AND TRAY

Cable trays shall be supplied either ladder, prefabricated, slotted or duct type. **Cost of cable tray erection as per BOQ Cum Rate Schedule shall include fabrication of supports to suit site requirement, fixing of support in position by welding as per Engineers instruction , erection and fixing of cable trays and racks by welding or by bolts and nuts. No separate payment will be released for fabrication / fixing / painting of support structure for cable trays(Including supply of paint),. shall be released after completion of cable tray erection / reconciliation of total material used in fabrication / erection of cable tray supports.** Jointing of trays can be carried out by bolting / welding as per direction of Engineer. Contractor shall carryout cutting of tray only by Hacksaw for obtaining proper routing from standard lengths supplied. Materials for support fabrication like flats, channels, angles etc. shall be supplied by contractor free of cost. The cutting & welding points on trays will be painted by primer & Al paint by the contractor including supply of paint within the erection price and no extra cost to BHEL. These cable trays may also be required for laying copper tubing, plica type / GI flexible conduits, local cabling and metal temp. thermocouples.

Beside above angels / channels of various sizes may have to be fabricated / erected, for use as cable trays, from structural steel to be supplied by contractor free of cost.

In many cases, trays are supplied with tray covers. These covers have to be erected after completion of bottom cable tray and lying of cables etc. The covers are to be properly secured on the bottom trays and no separate payment will be made for putting these covers. If required, GI / Al strip clamps are to be used.

## 19.0 CABLE LAYING

**Laying, dressing & clamping ( by Nylon / PVC ties or Aluminium strips or any other method specified by BHEL Engineer ) of the cables in the cable trays / angles. The final dressing of cables on cable trays not erected by contractor shall also be done with Nylon Cord / Aluminium strip.** Cost of cable laying as per BOQ Cum Rate Schedule shall include the cost of Nylon / PVC ties & Aluminium strip required for dressing / clamping.

**The cable run number shall be provided by punching Aluminium Tag plates and tying suitably with nylon ties (at both ends and at regular intervals as advised by BHEL Engineer ) which shall be arranged by contractor at his cost.** Nylon / PVC ties & Aluminium strip required for cable tags shall have to be provided by the Contractor.

**While laying cables, existing cable tray covers and false flooring may require to be removed and re-fixed. The same has to be done at no extra cost to BHEL**

## 20.0 CABLE TERMINATION

- a) **Termination Of HT Cables Only Shall Be Measured And Paid Separately As Per Quoted / Accepted Rate Of Respective Item Of BOQ CUM Rate Schedule.**
- b) **For Cables Other Than HT Cables , The Cost Of Cable Laying As Per BOQ Cum Rate Schedule Shall Also Include The Cost Of Termination With Suitable Crimping Type Lugs Including Supply Of Ferrules ( for cross / direct ferruling**

**as per BHEL instructions). Drilling of holes in gland plates of HT / LT switchgear, transformer, control panels, JB's etc as per requirement shall also be part of cabling at no extra cost to BHEL.**

- c) The contractor shall carryout insulation testing, simulation testing etc. as per the instructions of Engineer at site.
- d) Screen of signal cables shall run in insulated sleeve (to be arranged by contractor at no extra cost) and shall be terminated as per the instructions of the BHEL Engineer.

## **21. JUNCTION BOX, PUSH BUTTONS ETC**

Includes supply ,fabrication / fixing / painting of stands for junction boxes / push buttons / frame mounted panels etc will be included in quoted / accepted price of respective item. **Tenderer may note that fabrication / fixing / painting of stands for junction boxes / local push buttons / indication boxes etc. will be included in quoted / accepted price of respective item. No separate payment will be released for fabrication / erection of these stands.**

## **22 RIGID PIPE/CONDUITS**

Cutting / threading of standard lengths of conduits, laying on fabricated supports or on floor, using screwed fittings, clamping, sealing of open ends. Approved Good quality sealant shall be used to make the joint water proof.

## **23 PLICA FLEXIBLE CONDUIT**

Laying of conduits in cable trays, end connection with instrument / J.B. / panel, using suitable connectors / unions etc. . Suitable thread / Plica sealant shall be used to make the conduit system water proof. Aluminum painting, clamping and tagging in tray / angle forms part of erection job

## **24 EARTHING**

Earthing work mainly involves laying and tack welding of conductors on columns / beams at every one meter interval and bolted connections with equipment at least at two points. Low hydrogen content electrodes shall be used for welding. All the galvanized items shall be given surface treatment (by thoroughly cleaning with sand paper and / or cotton cloth to make the surface clean, smooth & free from any type of spots) at the welded joints & the places where galvanizing has been damaged. Welded joints shall be applied with two coats of cold zinc paint whereas portions with damaged galvanizing shall be applied with single coat.

- Any cutting of masonry work, which is necessary shall be done by the contractor at his own cost and shall be made good to match the original work. The Contractor shall obtain prior approval before cutting any masonry / concrete work.
- Conduits shall be thoroughly cleaned before pulling in the cable.
- Pipes sent in standard length shall be cut to suit the site conditions and the layouts. Tubes or pipes wherever deemed to be convenient will be sent in running lengths with sufficient bends. Bends upto 80 mm Nb will have to be fabricated at site.
- In case of Transformers if any leakage / sweating is observed from field assembled / shop assembled gasket joints, valves, welded joints the same

shall be attended by the contractor including draining of oil, refilling of oil & centrifuging if required at no extra cost to BHEL till handing over period. Sealing compound and any other consumable, if needed, shall be arranged by the contractor with in the quoted rates.

- Calibration log-sheets / history cards of all the instruments, panels, drives, relay testing etc. under the scope shall be recorded and submitted on BHEL approved formats. Proper logging will form a part of calibration / erection activity for the purpose of monthly running bills payments.
- The contractor shall use only SHEARING machine or HACKSAW for cutting angles, flats, channels and trays. No gas cutting is permitted . Drill machine shall be used for drilling holes.
- The contractor should note that after execution of work they will hand over marked up drawings "as erected" drawings to BHEL Engineer at site for preparation of firm "as built" drawings. "As erected" drawings will bear the signature of BHEL Engineer and contractor.
- The contractor shall paint the name / put tag numbers on all the equipment / instruments / cables etc. erected by him. Materials for tagging shall be supplied by the contractor . Contractor at his cost shall also arrange the adhesive etc.
- Contractor shall fabricate and erect stands / supports for Junction boxes, push button stations, fixing of push button and plugging of holes in JB's. This is considered inclusive in the item erection.
- DRIP SHIELDS shall be fabricated for all field mounted panels / instruments / instrument racks / JB Racks / control cabinets etc. The fabrication forms part of erection work.
- The motors and motorized valves actuators and solenoid valves will be erected and commissioned by other agency. However, if required electrical commissioning, of motorized valves may have to be carried out, wherever required, against this contract , payment of which shall be made as per applicable item of the Rate schedule.

## **16.0 TESTING, PRE-COMMISSIONING, COMMISSIONING AND POST- COMMISSIONING.**

- 16.1 Site testing shall be required for all equipment installed by the contractor to ensure proper installation, setting, connection and functioning in accordance with drawings, specifications and manufacturer's recommendations.
- 16.2 Commissioning protocols are to be prepared as advised by BHEL Engineer for getting approved by customer/ Consultant.
- 16.3 Testing, and pre-commissioning checks shall be as per relevant codes / practices and BHEL drawings / specifications/ approved commissioning Protocols and same shall include, but not be limited to the following :

### **(I.) TRANSFORMERS**

- (a) Insulation resistance and earth resistance checks.
- (b) Oil testing like BDV of oil of each drum before pouring, after processing and in the course of dry out, moisture content tests as and hen required. Provision should be made for preparation of oil in a separate tank before filling in the main transformer tank.
- (c) Checking of Buchholz Relay, oil level indicator PRV, calibration of OTI, WTI etc.

- (d) Winding resistance, vector group, turns ratio test on different taps, magnetising current, core balance check etc.
- (d) After installation the contractor will get oil samples tested at an accredited test lab as per relevant IS as advised by BHEL Engineer and submit the test results, in case the test results are found unsatisfactory the tests will be got repeated by the contractor after reprocessing of oil & submitted to BHEL for approval/acceptance.
- (e) Turns ratio, polarity, insulation resistance and winding resistance checks on all CT's.

## **(II.) CONTROL & PROTECTION PANELS**

- (a) Checking of complete wiring and insulation resistance.
  - (b) IR test and loop checking of all field wiring in the panel.
  - (c) Checking of all protection, metering and indicating schemes.
  - (d) Calibration of all indicating and measuring instruments, relays, timers.
  - (e) Checking of all auxiliary schemes e.g. space heating, illumination.
  - (f) Checking of operation of all relays, switches and other indicators.
  - (g) Commissioning of total scheme including relevant internal equipment.
  - (h) Carrying out suitable modifications as per system requirement.
  - (i) Carrying out primary injection, secondary injection, stability checks etc.
- 16.4 In case any defect is noticed during tests, trial runs and commissioning such as loose components, undue noise or vibration, strain on connected equipment etc. the contractor shall immediately attend to these defects and take necessary corrective measures. If any readjustment and realignment are necessary, the same shall be done as per Engineer's instructions including repair, rectification and replacement work by the contractor at his cost. The parts to be replaced shall be provided by BHEL.
- 16.5 During this period, though the BHEL's staff / Consultant appointed by BHEL will also be associated in the work, the contractor's responsibility will be to arrange for the complete requirement of supervision, labour, consumable, T&P and IMTEs required till such time the commissioned units are taken over by the BHEL's customer.
- 16.6 During commissioning activities and for carrying out various tests, special instruments etc, have to be temporarily erected and commissioned to suit the commissioning activities. Contractor will provide the necessary equipment. Contractor has to carry out the erection, calibration, dismantling of the same. After completion of activities the temporary systems have to be removed and to be taken back at no extra cost to BHEL.
- 16.7 During erection of various equipment, prior to commissioning and after commissioning, protocols have to be made with BHEL's customer. The proforma and formats as approved have to be printed by the contractor in adequate numbers. The pre-commissioning activities will start with various trials, commissioning operations shall continue till units are handed over to customer. Simultaneous commissioning activities will be progress in various areas, checking of equipment erected, making ready for trial runs, all these works need specialised gangs including electricians / instrument technicians in each area to render assistance to BHEL commissioning staff. Contractor shall earmark separate manpower for various commissioning activities. The manpower shall not be disturbed or diverted.
- 16.8 It shall be the responsibility of the contractor to provide workmen of various categories in sufficient numbers along with Engineers/ Supervisors including

necessary consumables, T&P etc. during pre-commissioning, commissioning and post commissioning period for commissioning of equipment and attending any problem in equipment erected by the contractor till handing over. The rates quoted shall include all these contingencies also.

- 16.9 It shall be specifically noted that the above employees of the contractor may have to work round the clock alongwith BHEL commissioning Engineer and hence overtime payment by the contractor to his employees may be involved. The contractor's accepted rates shall be inclusive of all these factors also.
- 16.10 In case, any rework is required because of contractor's faulty erection which is noticed during commissioning, the same has to be rectified by the contractor at his cost. If any equipment / part is required to be inspected during commissioning, the contractor will dismantle / open up the equipment / part and reassemble/redo the work without any extra claim.
- 16.11 During commissioning, opening and closing of valves, attending to leakage, changing of gaskets, modifications in wiring, realigning of equipment, re-calibration of instrument, attending to leakage, minor adjustments of erected equipment may arise. The accepted rates shall include all such works.

#### 17.00 FINISH PAINTING

- 17.1 All equipment within the scope of these specifications shall be received duly painted. The type of painting to be carried out is specified. For panels, during storage and handling the same may get peeled off / damaged / deteriorate. All such surfaces are to be thoroughly cleaned and to be touch up painted with suitable approved primer / finish paint matching with shop paint / approved final colour. **Besides above two coats of approved primer paint and at least two coats of approved finish paint to get the desired dry film thickness, is to be applied on various loose equipment and all steel structures fabricated and erected at site.** All paints, tools and other consumables including scaffolding materials required for painting shall be arranged and provided by contractor within the quoted rates. Paint and other materials so purchased shall be ISI marked and painting should be as per colour scheme and quality approved / specified by Engineer. Valid Test certificate for the paint so supplied shall be made available before use of the same on work. The contractor shall provide legend on equipment in size specified by Engineer. Letter writing shall be done in Hindi / English or in both language. The printer have to under go test and only qualified painters will be allowed to work.
- 17.2 Certain equipment shall require spray painting (touch up). The contractor shall make arrangements of the required equipment for spray painting of such equipment ***Including supply of paint,*** at his own cost. Spray painting at the job site shall be permitted only at times and locations approved by the owner / Engineer.

**INDICATIVE LIST AND SPECIFICATIONS OF APPROVED MAKE OF BOUGHT OUT MATERIAL TO BE ARRANGED BY THE CONTRACTOR AT HIS OWN COST**

The following list may be read in conjunction with the relevant make/ makes of materials mentioned in the BOQ or elsewhere in this tender document.

AA) Wiring Materials & Light :

S.N.	Particulars	Technical Specifications	Make
1.	MS tray 300mm width made by perforated angle	300mm width Supply & fixing	
2.	Slotted angle 25mmx25mmx3mm support for cable tray	--do--	
3.	Nut-Bolt and washer 12mmx6mm	GI quoted	
4.	PVC pipe dia 25mm thick 2mm	2mm thick heavy duty	
5.	PVC junction box 25mm	--do--	
6.	Ceiling rose	--do--	
7.	PVC Elbow 25mm	--do--	
8.	MCB box 8 way (TPN) double door	TPN double door powder quoted IP 54 insulated surface mounting with transparent cover/door	Legrand/ABB/L&T
9.	MCB 10Amp. single phase	10KA BC	Legrand/GE/ABB/L&T
10.	Casing Patti PVC 25mm	2mm thick heavy duty	
11.	PVC bend 25mm	--do--	
12.	Casing PVC 25mm 'T'	--do--	

## All Electrical – List of bought out items

Annexure-“A-1”

S.N.	Particulars	Technical Specifications	Make
13.	Casing Konia 25mm	--do--	
14.	PVC Gully	--do--	
15.	Steel screw 34/8mm	35/8mm nikkled	
16.	Copper wire 6sq.mm multi-stand/multi-layer - FR grade	1.1KV grade FR	Finolex/Polycap RR/National
17.	Copper wire 4sq.mm multi-stand/multi-layer - FR grade	--do--	--do--
18.	Copper wire 2.5sq.mm multi-stand/multi-layer - FR grade	--do--	--do--
19.	Copper wire 1.5sq.mm multi-stand/multi-layer - FR grade	--do--	--do--
20.	Flexible pipe 25mm	2mm thick ISI mark	
21.	MCB 16Amp. single phase	10KV BC	Legrand/GE/ABB/L&T
22.	Power box PVC casing 16 Amp.	2mm thick	
23.	Integral industrial medium highway lights 150watt	Except bulb, 150watt. hight revenues, high pressure	GE/Philips
24.	Lamp 150watt.	--do--	--do--
25.	Labour charges for wiring-cable tray fittings and light, power point fittings	Complete wiring tray making hanging fixing light fan	

BB) Light Control Panel

S.N.	Particulars	Technical Specifications	Make
	<b>Panel (as per single diagram hall no.1)</b>	Custom built panel CRC sheet, clad, dust and vermin proof floor mounted type comprise with aluminium bus-bar 250Amp. 3.5 phase neutral wires, Lugs, insulators and engineering. CPRI approved panel builders.	
<b>A.</b>	<b>Details of incoming and outgoing fitters switch gears</b>		
<b>1.</b>	Incoming MCCB 200Amp.	4 pole, 35 KA BC	Legrand/GE/ABB/L&T
<b>2.</b>	Metering set (CT 250/5 Volt meter, Amp meter and sector switch )	96x96mm CT operated meter with sector switch and control	
<b>3.</b>	MCB 63Amp. 4 pole	'C' curve	Legrand/GE/ABB/L&T

**CC) 33KV/11KV/0.4 KV 6000KVA ELECTRICAL BUILDING & POWER SUB STATION**

Sl.No.	Particulars	Technical Specification	Make
1.	Over Head Line	Supply & fixing steel tubular pole 9.5meter long designated 410. SP-28 in 1:3:6 cement concrete foundation include excavation back filling etc. complete in all respect. Over head aluminium mink (3 phase 33KV) conductor code.	
2.	11 KV Grade XLPE Aurmard 3 core cable - 185 Sq.mm	XL.PE-33KV 3 core 185 Sq.mm.	Finolex/Polycap RR/National
3.	End Termination Kit For 11 KV 185 Sq.mm Heat Shrinkable type 9 Indoor type + 1 Outdoor type	Mahindra Hot set made 11 KV grade joint kit	
4.	11 KV grade 21 KA - 630 Amp. RMU Unit One Incoming + Two Out going VCB	IP-54 category 11KV grade indoor type front opening floor mounted	
5.	Transformer outdoor type – upto 2000 KVA 11/0.40 KV with OLTC/RTCC, AVR	Transformer with OLTC RTCC outdoor type H.T. side cable termination box LT side bus bar termination+ Bockhoultz rely temperature and oils indicators.	
6.	DG Set 1000 KVA -0.40 KV Grade with PMG & SYN, AMF Panel (Super Silent	DG set 1100KVA 0.40KV grade with PMG/SYN. AMF panel super silent type.	

Sl.No.	Particulars	Technical Specification	Make
	Type)		
7.	PCC Panel as details of Single line Diagram- (Sl.No. EL-01), details given below -	<p>PCC factory fabricated and wired metal clad dust and vermin proof mounting instruments chamber shall be separate and shall comprise of flush type a meter volt meter selector switch suitable CT metering class – the board shall have suitable electrolytic Al. bus bar 3200 AMP 3.5 phase as per IS 8623 insulated with heat shrink sleaving and mounted on non hygroscopic supports shush as DMC/CMC the panel shall be fabricated with CRCA sheet with a minimum thickness of 1.6mm/2mm switch board shall be of cat IP-54. CPRI approved panel builder.</p> <p><b><u>Interlock</u></b> – DC source ACB 3200Amp. EDO, power source transformer no. 1 (4000KVA) ACB 3200Amp. EDO, transformer no. 2 (2000KVA) power source ACB 3200Amp. EDO bus coupler ACB interlocked electrical and mechanical to be required.</p> <p><b><u>Interlock Motive</u></b> – At a time one source ACB shall be in on condition.</p>	

Sl.No.	Particulars	Technical Specification	Make
	<b>EQUIPMENT DETAILS</b>		
	(a) ACB - EDO type 3200Amp, 4 Pole- 50 KA with Micro Processor release	Micro processor protection . O/L, S/C, E/F with time delay.	GE/L&T/Legrand
	(b) ACB EDO type 3200 Amp, 4 Pole - 50 KA without release	Micro processor protection . O/L, S/C, E/F with time delay.	
	(c) Out going ACB MDO Type 1250Amp, 3 Pole -50KA with Micro Processor Release	Micro processor protection . O/L, S/C, E/F with time delay.	
	(d) Capacitor panel out going 1600 Amp, 3 Pole- 50 KA, MDO Type ACB with Micro Processor Release	Micro processor protection . O/L, S/C, E/F with time delay.	GE/L&T/Legrand
	(e) MCCB, 4 Pole -50 KA 250 Amp.		GE/L&T/Legrand
	(f) Multi Function METER	96mm x 96mm L.E.D. Display	
8.	Bus duct 3200 Amp., 3.5 Phase with aluminium Bus Bar	3200Amp. IP-56 Cat out door type	
9.	Earthing (G.I.) for HT Transformer/ Switch/HT Panel/LT Panel	GI strip 50mmx6mm electrode size 900x900x3mm as per attached.	
10.	APFC panel with heavy duty capacitor – 1000Kvar	50 Kvar, 25Kvar. MPPH type capacitor micro processor PF rely. manual switching system. Bank conf. 1:2:3 each bank AMP meter 96x96mm.	GE/L&T/Legrand

DD) Wiring Material of Electrical Building /Power Sub Station:

S.N.	Particulars	Technical Specifications	Make
1.	Copper wire 4sq.mm multi-stand/multi-layer - FR grade	1.1 KV grade FR	Finolex/Polycap RR/National
2.	Copper wire 2.5sq.mm multi-stand/multi-layer - FR grade	--do--	Finolex/Polycap RR/National
3.	Copper wire 1.50sq.mm multi-stand/multi-layer - FR grade	--do--	Finolex/Polycap RR/National
4.	Copper wire 1.00sq.mm multi-stand/multi-layer - FR grade	--do--	Finolex/Polycap RR/National
5.	Telephone wire 4 pair	Screen protected	Finolex/Polycap RR/National
6.	PVC pipe 25mm dia. thick 2mm	2mm thick ISI mark	
7.	PVC bend 25mm thick 2mm	--do--	
8.	PVC bend 25mm thick 2mm but deep type	--do--	
9.	PVC bend 25mm	--do--	
10.	CI box 12"x10"	Factory make	
11.	CI box 7"x4"	--do--	
12.	CI box 4"x4"	--do--	

## All Electrical – List of bought out items

Annexure-“A-1”

S.N.	Particulars	Technical Specifications	Make
13.	Mica sheet 13"x11"	ISI mark	
14.	Mica sheet 8"x5"	--do--	
15.	Mica sheet 5"x5"	--do--	
16.	Switch on – off 6 Amp.	Piano type	
17.	Socket 6 Amp. 5 pin	5 pin	
18.	Switch on – off 16Amp.	Piano type	
19.	Socket 16Amp. 5 pin	5 pin	
20.	Button holder	State type	
21.	Ceiling rose	5 Amp.	
22.	MCB box 3way	TPN Powder quoted double door	
23.	MCB 63Amp. TPN	'B' curve 20 KA BC	Legrand/GE/ABB/L&T
24.	MCB 32Amp. SP	10 KA BC	Legrand/GE/ABB/L&T
25.	MCB 25Amp. SP	--do--	Legrand/GE/ABB/L&T
26.	Round mica sheet	ISI mark	
27.	Double T/L fittings	industrial type copper choke ballast	
28.	Ceiling fan 48"	wall bearing type	
29.	Exhaust fan 300mm	wall bearing type	

## All Electrical – List of bought out items

Annexure-“A-1”

S.N.	Particulars	Technical Specifications	Make
30.	Cabin fan 18"	450mm dia.	
31.	Fan dimmer	300watt flush mounted	
32.	Fan box MS	3mm thick	
33.	PVC gully		
34.	Steel screw	Nikkled	
35.	Brass screw 1.5"		
36.	Brass screw 2.5"		
37.	Steel screw 1.5"		
38.	Steel screw 2.5"		
39.	Steel nail 1"	Nikkle	
40.	PVC tape	¾" width self adhesive	
41.	Telephone jack	flush mounted	

EE) Main PCC panel of  
Administration Building

S.N.	Particulars	Technical Specifications	Make
1.	MCCB 250Amp. TP	35KA 415 Volt	Legrand/GE/ABB/L&T
2.	MCCB 63Amp. TP	--do--	Legrand/GE/ABB/L&T
3.	MCCB 125Amp. TP	--do--	Legrand/GE/ABB/L&T
4.	Metering set	96x96mm C.T. ratio 250/5 metering class	Legrand/GE/ABB/L&T
5.	Panel (as per single circuit diagram)	Custom built panel CRC sheet, 14SWG/16SWG clad, dust and vermin proof floor mounted type comprise with aluminium bus-bar 250Amp. 3.5 phase neutral wires, Lugs, insulators and engineering. CDRI approved panel builder.	
	<b>Ground Floor</b>		
1.	Copper wire 6sq.mm multi-stand/multi-layer - FR grade	1.1KV grade FR grade	Finolex/Polycap RR/National
2.	Copper wire 4sq.mm multi-stand/multi-layer - FR grade	--do--	--do--
3.	Copper wire 2.5sq.mm multi-stand/multi-layer - FR grade	--do--	--do--
4.	Copper wire 1.5sq.mm multi-stand/multi-layer - FR grade	--do--	--do--
5.	Copper wire 1.00sq.mm multi-stand/multi-layer - FR grade	--do--	--do--

## All Electrical – List of bought out items

Annexure-“A-1”

S.N.	Particulars	Technical Specifications	Make
6.	Telephone wire 4 pair		
7.	PVC pipe 25mm dia. thick 2mm	2mm thick	
8.	PVC bend 25mm thick 2mm	--do--	
9.	PVC junction box 25mm	--do--	
10.	PVC junction box 25mm deep type	--do--	
11.	Fan box (metal)	3mm thick	
12.	Metal box 4 module	--do--	
13.	Metal box 10 module	--do--	
14.	Metal box 12 module	--do--	
15.	AC box 32Amp.	--do--	
16.	Outer +inner 4 module	--do--	
17.	Outer +inner 10 module	--do--	
18.	Outer +inner 12 module	--do--	
19.	6Amp. on of switch	--do--	
20.	6Amp. socket	--do--	
21.	15Amp. socket	--do--	
22.	15Amp. on of switch	--do--	
23.	Metal box 2 modular	--do--	
24.	Outer+inner box 2 modular	--do--	
25.	Telephone Jack	--do--	
26.	Internet Jack	--do--	

## All Electrical – List of bought out items

Annexure-“A-1”

S.N.	Particulars	Technical Specifications	Make
27.	Fan dimmer	--do--	
28.	MCB 10Amp. SP	10KV BC	Legrand/GE/ABB/L&T
29.	MCB 16Amp. SP	--do--	Legrand/GE/ABB/L&T
30.	MCB 40Amp. TPN	--do--	Legrand/GE/ABB/L&T
31.	MCB 63Amp. TPN	--do--	Legrand/GE/ABB/L&T
32.	MCB box (double door) 4 way SP	Double door	Legrand/GE/ABB/L&T
33.	Tube light fittings wall mounted 40watt	Copper choke	
34.	Down light 18 watt	PLL/CFL	
35.	Down light 600mmx300mm 18 watt PLL optics mirror reflector type	PLL/Copper/Bleats	
36.	Wall bracket light	CFL 18 watt	
37.	Exhaust fan 18"	900 RPM	
38.	PVC tape	Steel grip self adhesive	
39.	PVC gully		
40.	Screw 1½"		
41.	Brass screw 1½"		
42.	Brass screw 2½"		
43.	Foot light fitting	Food light 6"x4" width 6 watt CFL	
44.	DB 12 way TPN (double door)	TPN double door	
45.	MCB 32Amp. DP	10KA, BC	Legrand/GE/ABB/L&T
46.	MCB 16Amp. DP	--do--	Legrand/GE/ABB/L&T

## All Electrical – List of bought out items

Annexure-“A-1”

S.N.	Particulars	Technical Specifications	Make
47.	Ceiling fan 48"	Medium speed	
48.	Basin light	18 watt CFL IP-56	
49.	Ceiling rose		
50.	Labour charges	Complete wiring, light, exhaust fan, hanging and fixing	
	<b>First Floor</b>		
1.	Copper wire 6sq.mm multi-stand/multi-layer - FR grade	1.1KV grade FR grade	Finolex/Polycap RR/National
2.	Copper wire 4sq.mm multi-stand/multi-layer - FR grade	--do--	--do--
3.	Copper wire 2.5sq.mm multi-stand/multi-layer - FR grade	--do--	--do--
4.	Copper wire 1.5sq.mm multi-stand/multi-layer - FR grade	--do--	--do--
5.	Copper wire 1.00sq.mm multi-stand/multi-layer - FR grade	--do--	--do--
6.	Telephone wire 4 pair	2mm ISI mark	
7.	PVC pipe 25mm dia. thick 2mm	--do--	
8.	PVC bend 25mm thick 2mm	--do--	
9.	PVC junction box 25mm	--do--	
10.	PVC junction box 25mm deep type	--do--	
11.	Fan box (metal)	3mm thick MS	
12.	Metal box 10 module	--do--	
13.	Metal box 4 module	--do--	

## All Electrical – List of bought out items

Annexure-“A-1”

S.N.	Particulars	Technical Specifications	Make
14.	AC box 32Amp.	Factory made	
15.	Outer +inner 10 module /12 module	MS 3mm thick	
16.	Outer +inner 4 module	3mm thick MS	
17.	6Amp. on off switch	Piano type	
18.	6Amp. on off switch socket	High pin	
19.	16Amp. on off switch	Piano type	
20.	16Amp. socket 5 pin	5 pin	
21.	Telephone jack	Flush mounted	
22.	Internet jack	Flush mounted	
23.	Fan electronic dimmer flush mounted	Flush mounted 300 watt	
24.	MCB 16Amp. SP	10KA BC	Legrand/GE/ABB/L&T
25.	MCB 20Amp. SP	--do--	Legrand/GE/ABB/L&T
26.	MCB 32Amp. SP	--do--	Legrand/GE/ABB/L&T
27.	MCB 63Amp. TPN	'C' curve	Legrand/GE/ABB/L&T
28.	MCB box 4 way SP (double door)	Powder quoted factory made	Legrand/GE/ABB/L&T
29.	Ceiling down light 600mmx300mm PLL light 18 watt x 2nos.	18 watt PLL copper ballast	
30.	Ceiling down light CFL 18 watt	18 watt CFL	
31.	Wall bracket light	--do--	
32.	Basin light 300mm	18 watt CFL, IP - 56	
33.	Exhaust fan 18"	1400 RPM	

## All Electrical – List of bought out items

Annexure-“A-1”

S.N.	Particulars	Technical Specifications	Make
34.	Wall mounted fan	450mm dia.	
35.	Call bell	Battery operated	
36.	Call bell switch	MK type	
37.	Chandelier (Jhumar)	600mm dia.	
38.	Foot light fittings	150mmx100mm CFL 4 watt	
39.	PVC gully	100mmx3mm	
40.	Steel screw 1.5"	Nikkled	
41.	Brass screw 1.5"		
42.	Brass screw 2.5"		
43.	Cup washer		
44.	PVC Tape	3/4 " self adhesive	
45.	SDF 125Amp. in SS enclosure with fuse	with 125Amp. fuse	
46.	DB 12 way TPN (double door)	Power quoted double door	
47.	MCB 32Amp. DP	10KA BC	Legrand/GE/ABB/L&T
48.	Ceiling fan 48"	48"	
49.	Fan dimmer flush mounted	300 watt flush mounted	
50.	Ceiling rose	5 Amp.	

**Note –**

1. All the critical tests shall be witnessed during PDI.
2. Vendor has to submit the Quality Plan inline with this RQP for review and approval of BHEL.
3. Bought out items shall be of reputed standard make and subject to owner's approval.
4. Manufacturer's TC to be submitted for review
5. Calibration certificates to be submitted