



Bharat Heavy Electricals Limited

Heavy Equipment Repair Plant

Tarna Shivpur Varanasi-221003

website: <https://herp.bhel.com>

Enquiry Number : **E-RC-304-26-0080-61-1** Date : **22/Jun/2026**

Enquiry For Material :-

Sl No	Material Description	Material Code	Quantity	Unit
1	JR. STOP BOLT(HY-326.01)-ROUGH M/CD FORG. - ROD DIA 125 x 590 MM LENGTH WITH MATL AS PER SPECN. HY-19366/01	RV1059565013	200.0	NOS
2	JOURNAL STOP BOLT FORG. - ROD DIA 125 x 570 MM LONG (HY-958.01) WITH MATL AS PER SPECN. HY19366/01	RV1059565021	45.0	NOS
3	TRUNION SHAFT (HY-37.F) - ROUGH M/CD FORGING AS PER DRG. 46137690011/04 WITH MATL AS PER SPECN. AA19332/10	RV1930132034	37.0	NOS
4	LOWER JOURNAL HSG. (HY-15.F) - ROUGH M/CD FORGING AS PER DRG. 36106202364/02 WITH MATL AS PER SPECN. AA19332/10	RV1930132042	10.0	NOS.
5	JOURNAL SHAFT (HY-62.F) - ROUGH M/CD FORGING AS PER DRG. 46036090009/02 WITH MATL AS PER SPECN. AA19332/10	RV1930132050	10.0	NOS
6	GRINDING ROLL LOCK NUT (HY-312.A.03) - ROUGH M/CD FORGING AS PER DRG. HY-312.A.03.F WITH MATL AS PER SPECN. AA19332/10	RV1930132175	300.0	NOS
7	TRUNION SHAFT (HY-313.02) - ROUGH M/CD FORGING AS PER DRG. HY-313.02.F WITH MATL AS PER SPECN. AA19332/10	RV1930132220	38.0	NOS
8	TRUNION SHAFT (HY-903.02) - ROUGH M/CD FORGING AS PER DRG. 46108802245/01 WITH MATL AS PER SPECN. AA19332/10	RV1930132705	12.0	NOS
9	SPRING STUD LOCK NUT (HY-921.15) - ROUGH M/CD FORGING AS PER DRG. HY-921.15.F/00 WITH MATL AS PER SPECN. AA19332/10	RV1930132713	18.0	NOS

Remarks

(A) SCOPE OF SUPPLY:-

1. THIS ENQUIRY HAS BEEN RAISED FOR ENTERING INTO FRAMEWORK AGREEMENT (VALUE WISE) WITH VENDORS FOR FORGING. SEPARATE PO WILL BE GIVEN TIME TO TIME AS PER REQUIREMENT , UNDER THIS RC. ITEM QUANTITY MENTIONED IN THE INDENT IS TENTATIVE & IT MAY INCREASE OR DECREASE AS PER OUR FINAL REQUIREMENT.
- 2.THE % WEIGHTAGE FOR CALCULATING TOTAL COST OF INDIVIDUAL ITEM HAS BEEN ARRIVED CONSIDERING INDIVIDUAL ITEM'S CONTENT IN TOTAL ESTIMATED COST OF ALL THE ENQUIRY ITEMS. THE % WEIGHTAGE WILL BE AS PER ANNEXURE-IV.
3. VALUE WISE MEANS FA WILL DONE ON SINGLE SET BASIS FOR ALL THE 09 ITEMS WITH THEIR FULL QUANTITY AND NOT QUANTITY OF INDIVIDUAL ITEM.
4. RATE FOR INDIVIDUAL ITEM WILL BE ARRIVED AS PER PERCENTAGE WEIGHTAGE MENTIONED IN ANNEXURE-IV ATTACHED.
5. RATES OF ITEMS AGAINST FA WILL BE FIRM & VALID FOR ORDERING FOR A PERIOD OF ONE YEAR FROM THE DATE OF AGREEMENT. PRICE VARIATION CLAUSE (PVC) IS NOT ACCEPTABLE.
6. VENDOR HAS TO QUOTE FOR ALL THE 09 ITEMS OF TENDER ENQUIRY COMPULSORILY. IN CASE, ANY VENDOR QUOTES FOR PART ITEM, THEIR OFFER WILL NOT BE CONSIDERED FOR FURTHER EVALUATION.
7. L-1 VENDOR WILL BE DECIDED ON TOTAL COST ON SET BASIS.
8. RC QTY AGAINST EACH ITEM IS INDICATIVE ONLY. PO WILL BE PLACED BASED ON ACTUAL REQUIREMENT IRRESPECTIVE OF RC QUANTITY NOT EXCEEDING THE TOTAL RATE CONTRACT VALUE.

AFTER FINALIZATION OF RATE CONTRACT, PO QUANTITY WILL BE PLACED AS PER REQUIREMENT.

(B) SUPPLY CONDITION :

1. ITEM TO BE SUPPLIED AT BHEL HERP STORES.
2. PRE-DESPATCH INSPECTION WILL BE CARRIED OUT AT PARTY'S WORKS BY BHEL REPRESENTATIVE AS PER QUALITY PLAN MENTIONED BELOW:-

a.)FOR ITEM SPEC. AA19332- AS PER QUALITY PLAN RV/C&F/21 REV-10

b.)FOR ITEM SPEC. HY19366- AS PER QUALITY PLAN RV/C&F/23 REV-01

(C) TECHNICAL DELIVERY CONDITION :

1. MATERIAL SHOULD BE AS PER SPEC. MENTIONED IN THE DESCRIPTION/DRG.
2. DIMENSIONS AND TOLERANCES TO BE MAINTAINED AS PER DRG.
3. HEAT TREATMENT CHART IS REQUIRED.
4. DIMENSION REPORT IS REQUIRED.
5. FOR JOURNAL STOP BOLT FORGINGS(HY-958.01 & HY-326.01) TOLERANCE ON DIA AND LENGTH MAY BE TAKEN AS +2/-0 MM.
6. FOR JOURNAL STOP BOLT FORGINGS(HY-958.01 & HY-326.01) SURFACE FINISH SHOULD BE OF 12.5
7. ALL TECHNICAL REQUIREMENT MENTIONED IN THE DRG./SPEC & QP MUST BE STRICTLY FULFILLED.
8. VENDOR SHOULD PROCURE RAW MATERIAL FOR FORGING FROM BHEL APPROVED SOURCES AS PER PMD SA01

(D) TEST CERTIFICATE :

- 1) REQUIRED FOR CHEMICAL & MECHANICAL PROPERTIES FOR EACH HEAT No.
- 2) TEST RESULTS OF UST AND MPI FOR FOR ITEM SPEC. AA19332 & TEST RESULTS OF UST FOR ITEM SPEC. HY19366.

(E) GUARANTEE CERTIFICATE: REQUIRED FOR 24 MONTHS AGAINST ANY MANUFACTURING DEFECTS FROM THE DATE OF RECEIPT AT BHEL HERP.

(F) PACKING INSTRUCTIONS: ALL ITEM SHOULD BE SUPPLIED IN LOOSE CONDITION WITH PROPER STACKING AT VEHICLE.

(G) RATE CONTRACT VALIDITY: FOR 1 (ONE) YEAR FROM THE RC-PO DATE.

(H) SPLITTING CONDITION:

1. THERE WILL BE SPLITTING BETWEEN TWO VENDORS IN THE RATIO OF L1:L2::60:40.
2. THE EQUATED L1 RATES OF ITEMS WOULD BE COUNTER OFFERED TO THE NEXT HIGHER BIDDER IN ORDER OF THEIR RANKING AND THE QUANTITY WOULD BE GIVEN TO THE BIDDER WHO ACCEPT THE EQUATED L1 PRICE ON THE BASIS OF THEIR RANKING IN THE PRICE BID.
3. IF NONE OF THE OTHER BIDDERS ACCEPT THE L1 PRICE, THEN THE ENTIRE QUANTITY OF THE TENDER WOULD BE ORDERED TO THE ORIGINAL L1 PARTY ONLY.
4. AT ANY POINT OF TIME OR IF THE PERFORMANCE OF ANY VENDOR IS FOUND UNSATISFACTORY, THE ABOVE DISTRIBUTION RATIO MAY BE CANCELLED OR CHANGED BY BHEL AND ITEMS MAY BE PROCURED FROM PERFORMING VENDORS.

(I) SPECIAL REMARKS:

1. ITEM WISE MAXIMUM QTY IN EACH LOT (WHICH MAY BE REQUIRED IN A PARTICULAR ORDER) WILL BE AS MENTIONED IN ANNEXURE--RC-LOT-BA02/01.
2. DELIVERY IS WITHIN 04 MONTHS FROM DATE OF PO FOR FIRST LOT. THERE WILL BE A GAP OF 01 MONTH BETWEEN TWO CONSECUTIVE LOTS. EARLY DELIVERY IS ACCEPTABLE.
3. REVERSE AUCTION (RA) WILL NOT BE CONDUCTED.
4. IN ORDER TO AVAIL BENEFITS OF MSE UNDER VARIOUS CATEGORIES, ALL BIDDERS FALLING UNDER MSE CATEGORY SHALL FURNISH THE FOLLOWING DETAILS & SUBMIT DOCUMENTARY EVIDENCE/ GOVT. CERTIFICATE ETC. IN SUPPORT OF THE SAME ALONG WITH THEIR TECHNO-COMMERCIAL OFFER AS PER ANNEXURE - MSES 2012 REV 01 ATTACHED.

SPECIAL TERMS AND CONDITIONS:

1. ALL OTHER TERMS AND CONDITIONS SHALL BE AS PER THE GTC ATTACHED WITH ENQUIRY (PARTY HAVE TO STRICTLY ADHERE THESE TERMS & CONDITIONS).

List of required Quality Documents along with supply:-

S.No	Material Code	Material Description	Documents Description
1	RV1930132042	LOWER JOURNAL HSG. HY-15 F AS PER DRG. 36106202364	<ol style="list-style-type: none"> 1. Dimension Report 2. Guarantee Certificates 3. Heat Treatment Chart 4. Inspection Report by TPI/BHEL 5. MPI report 6. Test Certificates Chemical Properties 7. Test Certificates-Mechanical Properties 8. UT Report
2	RV1930132050	JOURNAL SHAFT HY-62 F	<ol style="list-style-type: none"> 1. UT Report 2. Test Certificates-Mechanical Properties 3. Test Certificates Chemical Properties 4. MPI report 5. Inspection Report by TPI/BHEL 6. Heat Treatment Chart 7. Guarantee Certificates 8. Dimension Report
3	RV1930132220	TRUNION SHAFT FORGING AS PER DRG. HY-313.02.F	<ol style="list-style-type: none"> 1. Dimension Report 2. Guarantee Certificates 3. Heat Treatment Chart 4. Inspection Report by TPI/BHEL 5. MPI report 6. Test Certificates Chemical Properties 7. Test Certificates-Mechanical Properties 8. UT Report

Note : Any other document mentioned in QP/Drg/Spec will also be applicable

PQR for Forging Mill items

PQR Ref No: PQR/24-25/ Forgings	Date: 23.08.2024
Rev No: 04	Review Date: 29.03.2026
PQR Revision Date: 29.03.2026	

Sl. No.	BHEL Terms	Supplier's Compliance YES/NO
1	Offers are accepted from:	
1.a	Only Manufacturer's Offers shall be considered for the Tender Enquiry.	
2	Supplier shall give list of In-House Facilities:	
2.a	Vendor shall have in-House necessary Manufacturing facilities required for manufacturing and supply of item/s as per drawing/specification. This being primarily a forging requirement, Vendor must have all in-house required forging facilities and fulfil all requirement of our QAP. Vendor may outsource the Fully/Rough machining activities of the job.	
2.b	BHEL reserves right to visit the Works of the Manufacturer for Physical verification of the Manufacturing facilities (as declared by them) and assessment of their Quality systems during Technical Evaluation of the Offers.	
2.c	Bidders shall submit duly filled, signed & stamp copy of detailed Manufacturing process Plan along with the Technical Offer.	
3	Experience:	
3.a	Bidders shall submit the necessary documents proving their Experience in Supplying same or similar items to any Power Plant Equipment Manufacturer (Original Equipment Manufacturer)/ Defence Equipment Manufacturer (Original Equipment Manufacturer) (Govt or PSU)/AeroSpace Equipment Manufacturer (Original Equipment Manufacturer) (Govt or PSU)/Indian Railway during last Five (05) years from the date of Enquiry. Documentary evidences to be submitted in the form of Executed Purchase Order copies along with Material Acceptance Report and drawings/specifications of the supplied item/items. No relaxation in experience shall be given to MSEs & Notified start-ups.	
3.b	BHEL reserves right to verify the details from the Bidder's customers based on Documents submitted as a part of past experience. BHEL may ask for other relevant documents in line with above to review the capacity and capability of vendor with respect to enquired items.	
4	Financial Capability:	
4.a	Turn Over:- Turn over of Non-MSE vendors should be 100% of tender value. Relaxation for MSE vendors/ Notified Start-Ups on turn over will be as per MSME guidelines. Latest UDYAM Certificate required for MSE status.	
4.b	Applicable only for Non-MSE vendors: Audited balance Sheet and Profit and Loss account Statement of last three consecutive year (with UDIN) required along with part-1 bid. Or A CA Certified Consolidated summary (with UDIN) for last 3 consecutive years having annual turn over and Profit and Loss to be enclosed along with Part-1 bid . For Vendors having Turn over less than 1 crore in any of the financial year, CA certified Financial Turn over and Profit Loss (with UDIN) may be accepted for that year only.	
5	Vendor past Performance	
5.a	Any vendor who is on HOLD in BHEL HERP shall not be considered, and their offer shall be adjudged technically not suitable.	

Note-1: Non Submission of the above requested documents/non compliance to the above points is liable for rejection of the Offers without any further Notice/Intimation to the Bidder and no correspondance will be entertained at later stage.

Note-2: "Similar items" means items having same or similar Constructional feature, manufacturing process, similar nature of use, etc.

ANNEXURE-IV

S.NO	MATERIAL CODE	ITEM DESCRIPTION	QTY(NOS)	% WEIGHTAGE
1	RV1930132175	GRINDING ROLL LOCK NUT (HY-312.A.03) - ROUGH M/CD FORGING AS PER DRG. HY-312.A.03.F WITH MATL AS PER SPECN. AA19332/10	300	43.14%
2	RV1930132050	JOURNAL SHAFT (HY-62.F) - ROUGH M/CD FORGING AS PER DRG. 46036090009/02 WITH MATL AS PER SPECN. AA19332/10	10	1.95%
3	RV1059565021	JOURNAL STOP BOLT FORG. - ROD DIA 125 x 570 MM LONG (HY-958.01) WITH MATL AS PER SPECN. HY19366/01	45	3.27%
4	RV1059565013	JR. STOP BOLT(HY-326.01)-ROUGH M/CD FORG. - ROD DIA 125 x 590 MM LENGTH WITH MATL AS PER SPECN. HY-19366/01	200	11.95%
5	RV1930132042	LOWER JOURNAL HSG. (HY-15.F) - ROUGH M/CD FORGING AS PER DRG. 36106202364/02 WITH MATL AS PER SPECN. AA19332/10	10	3.67%
6	RV1930132713	SPRING STUD LOCK NUT (HY-921.15) - ROUGH M/CD FORGING AS PER DRG. HY-921.15.F/00 WITH MATL AS PER SPECN. AA19332/10	18	0.65%
7	RV1930132220	TRUNION SHAFT (HY-313.02) - ROUGH M/CD FORGING AS PER DRG. HY-313.02.F WITH MATL AS PER SPECN. AA19332/10	38	20.93%
8	RV1930132034	TRUNION SHAFT (HY-37.F) - ROUGH M/CD FORGING AS PER DRG. 46137690011/04 WITH MATL AS PER SPECN. AA19332/10	37	9.73%
9	RV1930132705	TRUNION SHAFT (HY-903.02) - ROUGH M/CD FORGING AS PER DRG. 46108802245/01 WITH MATL AS PER SPECN. AA19332/10	12	4.71%
TOTAL			670	100.00%

TOTAL NO OF ITEMS(NOS)

670

ANNEXURE--RC-LOT-BA02/01

S.NO	MATERIAL CODE	ITEM DESCRIPTION	QTY(NOS)	MAX LOT
1	RV1930132175	GRINDING ROLL LOCK NUT (HY-312.A.03) - ROUGH M/CD FORGING AS PER DRG. HY-312.A.03.F WITH MATL AS PER SPECN. AA19332/10	300	50
2	RV1930132050	JOURNAL SHAFT (HY-62.F) - ROUGH M/CD FORGING AS PER DRG. 46036090009/02 WITH MATL AS PER SPECN. AA19332/10	10	10
3	RV1059565021	JOURNAL STOP BOLT FORG. - ROD DIA 125 x 570 MM LONG (HY-958.01) WITH MATL AS PER SPECN. HY19366/01	45	25
4	RV1059565013	JR. STOP BOLT(HY-326.01)-ROUGH M/CD FORG. - ROD DIA 125 x 590 MM LENGTH WITH MATL AS PER SPECN. HY-19366/01	200	50
5	RV1930132042	LOWER JOURNAL HSG. (HY-15.F) - ROUGH M/CD FORGING AS PER DRG. 36106202364/02 WITH MATL AS PER SPECN. AA19332/10	10	10
6	RV1930132713	SPRING STUD LOCK NUT (HY-921.15) - ROUGH M/CD FORGING AS PER DRG. HY-921.15.F/00 WITH MATL AS PER SPECN. AA19332/10	18	18
7	RV1930132220	TRUNION SHAFT (HY-313.02) - ROUGH M/CD FORGING AS PER DRG. HY-313.02.F WITH MATL AS PER SPECN. AA19332/10	38	20
8	RV1930132034	TRUNION SHAFT (HY-37.F) - ROUGH M/CD FORGING AS PER DRG. 46137690011/04 WITH MATL AS PER SPECN. AA19332/10	37	20
9	RV1930132705	TRUNION SHAFT (HY-903.02) - ROUGH M/CD FORGING AS PER DRG. 46108802245/01 WITH MATL AS PER SPECN. AA19332/10	12	12
TOTAL			670	

**GENERAL COMMERCIAL TERMS & CONDITIONS OF ENQUIRY
(FOR INDIAN VENDORS)**

Amendment- 27
ANNEXURE-A

**ITEM DESCRIPTION:
ENQUIRY NO:**

SI No	BHEL STANDARD TERMS & CONDITIONS	Confirmation of supplier (Yes/No)
1.	A) OFFER MUST BE SUBMITTED IN TWO PART BID SYSTEM NAMELY TECHNO-COMMERCIAL BID & PRICE BID FOR THE ITEM AS PER ENQUIRY IN SEPARATE SEALED COVERS: (I) TECHNO – COMMERCIAL BID & (II) PRICE BID SHOULD BE CLEARLY SUPERSCRIBED THE ENQUIRY NO. AND DUE DATE ON THE ENVELOPES. (B) UN-PRICED OFFER WITH TECHNICAL BID IS REQUIRED TO BE FURNISHED BY THE VENDOR. TECHNICAL OFFER SHOULD CLEARLY REFLECT AT LEAST OUR MATERIAL CODE, ITEM DESCRIPTION & QUANTITY. (C) THE DIFFERENCE BETWEEN “UN-PRICED OFFER” AND “PRICED OFFER” SHOULD BE ONLY THE PRICES WHEREVER APPLICABLE. THE RATES AND AMOUNT SHOULD BE CLEARLY WRITTEN IN FIGURES AND WORDS BOTH WITHOUT ANY CUTTING / OVERWRITING. (D) IMPORTANT POINT FOR VENDOR WHO HAVE NOT SUBMITTED THE SRF (SUPPLIER REGISTRATION FORM) SO FAR: THE VENDORS, WHO HAVE NOT SUBMITTED THE SRF SO FAR, MUST SUBMIT THE SAME ALONG WITH PART- 1 BID. THE SRF TO BE DOWNLOADED FROM WWW.BHEL.COM OR https://herp.bhel.com .	
2.	BID SHOULD BE FREE FROM CORRECTION, OVERWRITING, USING CORRECTIVE FLUID, ETC. ANY INTERLINEATION , CUTTING , ERASURE OR OVERWRITING SHALL BE VALID ONLY IF THEY ARE ATTESTED UNDER FULL SIGNATURE(S) OF PERSON(S) SIGNING THE BID ELSE BID SHALL BE LIABLE FOR REJECTION .	
3.	YOUR TECHNO COMMERCIAL BID SHOULD MENTION THAT PRICE BID HAS BEEN SENT IN A SEPARATE ENVELOPE GIVING ITS REFERENCE.	
4.	VENDOR TO ENSURE THAT ITEM & QUANTITY MENTIONED IN THE OFFERS ARE EXACTLY SAME AS PER ENQUIRY. IF ANY DEVIATION IS THERE PARTY MUST MENTION SPECIFIC HEREWITH OTHERWISE BHEL SHALL CONSIDER THAT ITEM & QUANTITY AS REQUIRED IN ENQUIRY.	
5.	PLEASE MAKE SURE THAT THERE IS NO DISCREPANCY IN BETWEEN ACCEPTED TERMS & CONDITIONS MENTIONED IN THE CHECK LIST AND QUOTATION SUBMITTED BY VENDOR AND IF FOUND SO THEN THE TERMS & CONDITIONS WHICH ARE BENEFICIAL TO BHEL WOULD ONLY BE CONSIDERED.	
6.	THE TENDER RECEIVED AFTER 14:00 HRS ON THE DUE DATE WILL NOT BE CONSIDERED.	
7.	PART-I CONTAINING THE TECHNO-COMMERCIAL BID WILL BE OPENED ON THE DATE AND TIME SPECIFIED IN THE ENQUIRY, IN THE PRESENCE OF THOSE TENDERERS WHO WISH TO ATTEND. PART-II i.e., PRICE BID WILL BE OPENED ONLY OF THOSE BIDDERS WHO ARE FOUND TECHNO-COMMERCIALY SUITABLE AFTER SCRUTINY OF THEIR PART-I OFFERS.	
8.	NO REVISED OFFERS WILL BE ACCEPTED UNLESS ASKED BY BHEL AFTER OPENING OF PART-1 BID IN ANY CASE.	
9.	THE RATE OF GST SHOULD BE CLEARLY MENTIONED IN THE OFFER.	
10.	VALIDITY OF OFFER SHOULD BE MINIMUM 90 DAYS FROM THE DATE OF TECHNO - COMMERCIAL BID OPENING OR 60 DAYS FROM THE REVERSE AUCTION DATE.	
11.	BHEL RESERVES THE RIGHT TO REJECT THE OFFER, WHICH IS HAVING DEVIATIONS TO THE TERMS AND CONDITIONS GIVEN IN THE TENDER ENQUIRY.	
12.	PRICING TERMS: PRICES ONCE QUOTED SHALL REMAIN FIRM WITHIN THE VALIDITY OR ANY EXTENSION THEREOF FOR PLACEMENT OF ORDER, TILL COMPLETE EXECUTION OF THE ORDER, WITHOUT ANY ESCALATION/INCREASE FOR ANY REASON, WHATSOEVER, UNLESS SPECIFICALLY PROVIDED FOR IN THE ENQUIRY & PO. IN CASE OF FOREIGN VENDORS, THE QUOTED PRICE SHALL BE TAKEN AS INCLUSIVE OF THIRD PARTY INSPECTION AND TESTING CHARGES AS CALLED FOR IN THE NIT.	
13.	BID EVALUATION: UNLESS SPECIFIED IN THE TENDER, VENDOR MUST NOTE THAT BHEL WILL ARRIVE THE L1 STATUS FOR EACH ITEM ON LANDED COST BASIS. ACCORDINGLY, ORDER SHALL BE PLACED ON LOWEST BIDDER ON INDIVIDUAL ITEM BASIS ONLY, UNLESS BHEL ASK FOR TERMS OTHER THAN THIS ON EXCEPTION BASIS. IN THE COURSE OF EVALUATION, IF MORE THAN ONE BIDDER HAPPENS TO OCCUPY L-1 STATUS, EFFECTIVE L-1 WILL BE DECIDED BY SOLICITING DISCOUNTS FROM THE RESPECTIVE L-1 BIDDERS. IN CASE MORE THAN ONE BIDDERS HAPPENS TO OCCUPY THE L-1 STATUS EVEN AFTER SOLICITING DISCOUNT, THE L-1 BIDDER SHALL BE DECIDED BY A TOSS/DRAW OF LOTS, IN THE PRESENCE OF THE RESPECTIVE BIDDER(S) OR THEIR REPRESENTATIVE(S). RANKING WILL BE DONE ACCORDINGLY. BHEL'S DECISION IN SUCH SITUATION SHALL BE FINAL AND BINDING.	
14.	TERMS OF DELIVERY: I. FOR INDIGENOUS SUPPLIERS: THE TERMS OF DELIVERY SHOULD BE QUOTED ON F.O.R. DESTINATION (BHEL HERP STORES VARANASI) BASIS ONLY (i.e. FREIGHT & INSURANCE ON VENDOR'S ACCOUNT ONLY). IF ANY BIDDER STILL QUOTES OTHER DELIVERY TERM IN PLACE OF BHEL HERP STORES, THEIR OFFER MAY NOT BE CONSIDERED FOR FURTHER PROCESSING. IT MUST BE SPECIFICALLY NOTED.	
15.	IF ANY INDIAN SUPPLIERS ARRANGE SUPPLY FROM FOREIGN PRINCIPLES/WORKS, TERMS OF DELIVERY SHOULD BE QUOTED ON CIF JNPT MUMBAI (INDIA) SEA PORT BASIS ONLY (i.e. FREIGHT & INSURANCE ON VENDOR'S ACCOUNT UPTO JNPT MUMBAI (INDIA) SEA PORT) OR CFR MUMBAI AIRPORT. HOWEVER FREIGHT CHARGES AS PER BHEL TRANSPORT CONTRACT FROM JNPT MUMBAI SEAPORT/MUMBAI AIRPORT TO BHEL VARANASI FOR EACH ITEM WILL BE LOADED AT THE TIME OF TOTAL LANDED COST CALCULATION (RATE OF BHEL TRANSPORT CONTRACT SHALL BE AS APPLICABLE RATE ON PART-1 BID OPENING DATE).	
16.	INSURANCE CHARGES SHALL BE TO VENDOR'S ACCOUNT ONLY IF PRICE QUOTED ON BHEL HERP STORES BASIS. IN CASE PRICE QUOTED IS ON CIF JNPT MUMBAI BASIS/ CFR MUMBAI AIRPORT BASIS, INSURANCE UP TO CIF JNPT MUMBAI/ MUMBAI AIRPORT SHALL BE IN VENDOR ACCOUNT.	
17.	PAYMENT TERMS: I.FOR MSES VENDORS: 100% AGAINST SRV WITHIN 45 DAYS THROUGH EFT (ELECTRONIC FUND TRANSFER) FROM THE DATE OF RECEIPT OF MATERIAL (DATE OF SRV) AT BHEL HERP VARANASI STORES AS PER PO. II.FOR MEDIUM ENTERPRISES VENDORS: 100% AGAINST SRV WITHIN 60 DAYS THROUGH EFT (ELECTRONIC FUND TRANSFER) FROM THE DATE OF RECEIPT OF MATERIAL (DATE OF SRV) AT BHEL HERP VARANASI STORES AS PER PO. III. FOR NON- MSME: 100% AGAINST SRV WITHIN 90 DAYS THROUGH EFT (ELECTRONIC FUND TRANSFER) FROM THE DATE OF RECEIPT OF MATERIAL (DATE OF SRV) AT BHEL HERP VARANASI STORES AS PER PO. IV.BHEL HERP WILL MAKE PAYMENTS IN TWO PARTS: - PART-I: BASIC INVOICE VALUE AND ALL OTHER CHARGES (EXCEPT GST AMOUNT) WILL BE PAID AS PER P.O. PAYMENT TERMS. PART-II: GST PORTION OF INVOICE VALUE WILL BE PAID ONLY AFTER FULFILLING FOLLOWING CONDITIONS: (A) PAYMENT OF GST AMOUNT INTO GOVT. ACCOUNT BY SUPPLIER AGAINST INVOICE RAISED TO BHEL. (B) FILING OF GST RETURN (C) DISPLAY OF GST CREDIT AGAINST BHEL GSTIN NO.09AAACB4146P2ZC IN GSTR-2B ON GSTN PORTAL. NOTE: 1. PAYMENT WILL BE MADE AFTER ACCEPTANCE OF MATERIAL. 2. ADVANCE PAYMENT IS NOT ACCEPTABLE BY BHEL HERP VARANASI IN ANY CASE. 3. IF ANY SUPPLIER FALLS UNDER “NON MSE” OR “NON MEDIUM” CATEGORY AT THE TIME OF PO PLACEMENT AND IF PARTY DOES NOT INFORM BHEL REGARDING CHANGE IN THEIR STATUS BEFORE PROCESSING OF THE PAYMENT, THEIR PAYMENT TERM WILL BE CONSIDERED AS NON MSME SUPPLIER WITHOUT ANY FURTHER INTIMATION. IF SUCH SUPPLIER INFORM BHEL OR BHEL GETS UPDATED ON THEIR OWN ABOUT PARTY'S STATUS CHANGE (WHEN PARTY BECOMES MSME FROM NON-MSME) BEFORE PROCESSING OF THE PAYMENT, PARTY'S PAYMENT TERM WILL BE CHANGED AS PER APPLICABLE STATUS. ACCORDINGLY, PURCHASING OFFICER WILL CHANGE PAYMENT TERMS IN THE APPLICABLE PO/S ALSO.	
18.	LOADING OF PAYMENT TERM: IN CASE OF DEVIATION, LOADING @ REPO RATE+4% (AS ON PART-1 OPENING DATE) SHALL BE LOADED WHILE ARRIVING AT LANDED COST TO BHEL.	
19.	LIQUIDATED DAMAGES/ LATE DELIVERY (LD) PENALTY CLAUSE: SUBJECT TO FORCE MAJEURE CONDITIONS, FAILURE TO SUPPLY WITHIN PURCHASE ORDER DELIVERY SCHEDULE WILL MAKE THE SUPPLIER LIABLE TO AN UNCONDITIONAL PENALTY OF 0.5 % PER WEEK OR PART THEREOF SUBJECT TO THE MAXIMUM OF 10% OF THE UNDELIVERED PURCHASE ORDER VALUE EXCLUDING TAXES & DUTIES. NO GRACE PERIOD SHALL BE GIVEN.	

**GENERAL COMMERCIAL TERMS & CONDITIONS OF ENQUIRY
(FOR INDIAN VENDORS)**

Amendment- 27
ANNEXURE-A

20.	<p>LOADING OF LIQUIDATED DAMAGES (LD): DEVIATION TO ABOVE STANDARD PENALTY CLAUSE, MAXIMUM LOADING OF 10% (IN CASE OF NON ACCEPTANCE OF LD CLAUSE) OR PART THEREOF (IN CASE OF PART ACCEPTANCE OF LD) SHALL BE LOADED WHILE ARRIVING LANDED COST TO BHEL.</p> <p>LOADING OF DELIVERY TERM: FURTHER IF DEVIATION IS FOUND IN THE ACCEPTED DELIVERY TERM AS WELL AS ACCEPTED PENALTY TERM, SUITABLE LOADING BASED ON TRANSPORTATION TIME TO BE TAKEN SHALL BE LOADED WHILE ARRIVING LANDED COST TO BHEL HERP STORES WHICH MAY BE AS BELOW:</p> <p>(i) 1% OF THE BASIC COST FOR INDIAN SUPPLIERS,</p>	
21.	<p>DELIVERY PERIOD: VENDOR SHOULD STRICTLY QUOTE THE DELIVERY PERIOD AS MENTIONED IN NIT.</p>	
22.	<p>IF ANY VENDOR DOES NOT SUPPLY THE ITEM WITHIN THE PURCHASE ORDER DELIVERY PERIOD, BHEL MAY/MAY NOT ACCEPT THE SUPPLY AT ITS SOLE DISCRETION.</p>	
23.	<p>BANK GUARANTEE: THE COST OF BHEL FREE ISSUE MATERIALS PER SET/PER ASSEMBLY AND TOTAL COST OF FIM FOR THE ENQUIRY ARE MENTIONED IN NIT. IN THIS REGARD:</p> <p>1 (a). PARTY WILL HAVE TO SUBMIT EQUAL AMOUNT OF SECURITY DEPOSIT (IN THE FORM OF 10% BG/FDR/DD/CHEQUE/BANK TRANSFER AND 90% INDEMNITY BOND) TOWARDS THE COST OF BHEL MATERIALS TO BE ISSUED TO THEM BEFORE THE ISSUE OF BHEL MATERIALS TO THEM. AT ANY POINT OF TIME, PROPORTIONATE SECURITY DEPOSIT OF TOTAL/CUMMULATIVE MATERIAL VALUE SHOULD BE MAINTAINED.</p> <p>(b) IN CASE OF TRIAL/DEVELOPMENTAL ORDER, PARTY WILL HAVE TO SUBMIT 30% BG/FDR/DD/CHEQUE/BANK TRANSFER AND 70% INDEMNITY BOND TOWARDS THE COST OF BHEL FIM.</p> <p>2. BHEL MAY ASK THE SUPPLIER FOR SUBMISSION OF FULL SECURITY DEPOSIT AMOUNT OR PART DEPENDING UPON THE AVAILABILITY OF FREE ISSUE MATERIALS AT OUR END.</p> <p>3. PARTY MUST HAVE TO SUBMIT THE SAME WITHIN 02 WEEK TIME FROM THE DATE OF WRITTEN INTIMATION BY BHEL WITHOUT FAIL OTHERWISE IT WOULD TREATED AS FAILURE OF HONOURING PO TERMS AND ACCORDINGLY BHEL MAY CANCEL THE PURCHASE ORDER AND INITIATE ALTERNATE PROCUREMENT ACTION AT SUPPLIER RISK & COST.</p> <p>4. IN CASE OF ABSENCE OF DESIRED SECURITY DEPOSIT AT BHEL END AND ALSO NON RESPONSE OF POINT NO. 03 AS ABOVE,</p> <p>I. BHEL MAY HOLD THE PENDING PAYMENTS OF SUPPLIER AVAILABLE AT BHEL ON THEIR CONSENT.</p> <p>II. IF NO PAYMENT IS PENDING AT BHEL END, ACTION FOR ALTERNATE PROCUREMENT ACTION MAY BE INITIATED.</p> <p>5. THE FORMAT OF BG AND IB SHALL BE PER ATTACHED ANNEXURE-BG/FIM AND IB-FIM RESPECTIVELY</p> <p>6. PARTY SHALL HAVE TO ARRANGE FURNISHING OF THE SFMS CODE ALONG WITH THE BG.</p>	
24.	<p>TRANSPORTATION CHARGES FOR SENDING BHEL FREE ISSUE MATERIALS (FIM) TO THE PARTY WORKS WILL BE BORNE BY BHEL ONLY. THE FREIGHT CHARGES FOR SENDING THE BHEL FIM FROM HERP STORES TO PARTY'S WORK FOR EACH ITEM WILL BE LOADED AS PER BHEL TRANSPORT CONTRACT AT THE TIME OF TOTAL LANDED COST CALCULATION (RATE OF BHEL TRANSPORT CONTRACT SHALL BE AS APPLICABLE RATE ON PART-1 BID OPENING DATE). HOWEVER, VARANASI/LOCAL BASED VENDORS WILL LIFT THE FIM FROM BHEL STORES AND BORNE ITS TRANSPORTATION CHARGES.</p>	
25.	<p>IF BHEL ISSUES FREE ISSUE MATERIALS TO THE SUPPLIER, IT MUST BE RETURNED WITHIN THE TIME LIMIT AS PRESCRIBED IN GST LAW (PRESENTLY 01 (ONE) YEAR FROM THE DATE OF FREE ISSUE DATE) TO COMPLY THE GST RULES. IF ANY VENDOR DOES NOT RETURN THE BHEL FREE ISSUE MATERIALS AS MENTIONED ABOVE, THE FINANCIAL IMPLICATION ON ACCOUNT OF THIS, IF ANY, SHALL BE RECOVERED FROM THE PARTY BILLS.</p>	
26.	<p>REVERSE AUCTION: BHEL SHALL BE RESORTING TO REVERSE AUCTION (RA) (GUIDELINES AS AVAILABLE ON WWW.BHEL.COM) FOR THIS TENDER. RA SHALL BE CONDUCTED AMONG ALL THE TECHNO-COMMERCIALY QUALIFIED BIDDERS.</p> <p>PRICE BIDS OF ALL TECHNO-COMMERCIALY QUALIFIED BIDDERS SHALL BE OPENED AND SAME SHALL BE CONSIDERED AS INITIAL BIDS OF BIDDERS IN RA. IN CASE ANY BIDDER(S) DO (ES) NOT PARTICIPATE IN ONLINE REVERSE AUCTION, THEIR SEALED ENVELOPE PRICE BID ALONG WITH APPLICABLE LOADING, IF ANY, SHALL BE CONSIDERED FOR RANKING.</p>	
27.	<p>IF ANY OF THE VENDORS DO NOT ACCEPT THE ABOVE POINT MENTIONED AT SL. NO. 26, THEIR OFFER MAY BE LIABLE FOR REJECTION WITHOUT INTIMATION.</p>	
28.	<p>BHEL MAY SHORT CLOSE/CANCEL AN ORDER AT ANY TIME DURING THE CURRENCY OF THE CONTRACT/PO IRRESPECTIVE OF THE PO DELIVERY DATE, IF</p> <p>(I) THE WORK PROGRESS OF THE VENDOR IS POOR, OR</p> <p>(II) THE DELIVERY REQUIREMENT OF THE ITEM IS VERY CRITICAL & NOT BEING MET BY THE VENDOR ON WHICH ORDER HAS BEEN PLACED, OR</p> <p>(III) THERE IS NO RESPONSE FOR IMPROVEMENT IN DELIVERY AS PER BHEL REQUIREMENT,</p>	
29.	<p>THE OFFERS OF THE BIDDERS WHO ARE ON THE BANNED LIST AND ALSO THE OFFER OF THE BIDDERS, WHO ENGAGE THE SERVICES OF THE BANNED FIRMS, SHALL BE REJECTED. THE LIST OF BANNED FIRMS IS AVAILABLE ON BHEL WEB SITE www.bhel.com</p>	
30.	<p>RESERVATION RIGHTS OF BHEL: – BHEL RESERVES THE RIGHT TO REJECT ANY OR ALL QUOTATIONS WITHOUT ASSIGNING ANY REASONS THEREOF. BHEL ALSO RESERVES THE RIGHT TO INCREASE OR DECREASE THE TENDERED QUANTITIES. VENDORS SHOULD BE PREPARED TO ACCEPT ORDER FOR REDUCED QUANTITIES WITHOUT ANY EXTRA CHARGES. VENDOR SHOULD ALSO BE PREPARED FOR GIVING DISCOUNT IN CASE OF INCREASE IN QUANTITY.</p>	
31.	<p>NON-DISCLOSURE AGREEMENT: ALL DRAWINGS AND STANDARDS ARE PROPRIETARY OF BHEL. IT MUST NOT BE USED IN ANY WAY DETRIMENTAL TO THE INTEREST OF THE COMPANY. ALL SUPPLIERS SHALL FURNISH NDAS (NON-DISCLOSURE AGREEMENT) AGAINST USE OF DOCUMENTS FURNISHED BY BHEL TOWARDS UN-AUTHORIZED USE EXCEPT FOR THE PURPOSE IT HAS BEEN FURNISHED.</p>	
32.	<p>SETTLEMENT OF DISPUTE:</p> <p>IF ANY DISPUTE OR DIFFERENCE OF ANY KIND WHATSOEVER SHALL ARISE BETWEEN BHEL AND THE SUPPLIER/VENDOR, ARISING OUT OF THE CONTRACT FOR THE PERFORMANCE OF THE WORK WHETHER DURING THE PROGRESS OF CONTRACT TERMINATION, ABANDONMENT OR BREACH OF THE CONTRACT, IT SHALL IN THE FIRST PLACE REFERRED TO DESIGNATED ENGINEER FOR AMICABLE RESOLUTION BY THE PARTIES. DESIGNATED ENGINEER (TO BE NOMINATED BY BHEL FOR SETTLEMENT OF DISPUTES ARISING OUT OF THE CONTRACT) WHO WITHIN 60 DAYS AFTER BEING REQUESTED SHALL GIVE WRITTEN NOTICE OF HIS DECISION TO THE CONTRACTOR. SAVE AS HEREINAFTER PROVIDED, SUCH DECISION IN RESPECT OF EVERY MATTER SO REFERRED SHALL FORTHWITH BE GIVEN EFFECT TO BY THE SUPPLIER/VENDOR WHO SHALL PROCEED WITH THE WORK WITH ALL DUE DILIGENCE, WHETHER HE OR BHEL DESIRES TO RESOLVE THE DISPUTE AS HEREINAFTER PROVIDED OR NOT.</p> <p>IF AFTER THE DESIGNATED ENGINEER HAS GIVEN WRITTEN NOTICE OF THIS DECISION TO THE PARTY AND NO INTENTION TO PURSUE THE DISPUTE HAS BEEN COMMUNICATED TO HIM BY THE AFFECTED PARTY WITHIN 30 DAYS FROM THE RECEIPT OF SUCH NOTICE, THE SAID DECISION SHALL BECOME FINAL AND BINDING ON THE PARTIES. IN THE EVENT THE SUPPLIER/VENDOR BEING DISSATISFIED WITH ANY SUCH DECISION OR IF AMICABLE SETTLEMENT CANNOT BE REACHED THEN ALL SUCH DISPUTED ISSUES SHALL BE RESOLVED THROUGH CONCILIATION IN TERMS OF THE BHEL CONCILIATION SCHEME 2018 AS PER CLAUSE 14.1</p>	
33.	<p>CONCILIATION (Clause 14.1):</p> <p>ANY DISPUTE, DIFFERENCE OR CONTROVERSY OF WHATEVER NATURE HOWSOEVER ARISING UNDER OR OUT OF OR IN RELATION TO THIS AGREEMENT (INCLUDING ITS INTERPRETATION) BETWEEN THE PARTIES, AND SO NOTIFIED IN WRITING BY EITHER PARTY TO THE OTHER PARTY (THE "DISPUTE") SHALL, IN THE FIRST INSTANCE, BE ATTEMPTED TO BE RESOLVED AMICABLY IN ACCORDANCE WITH THE CONCILIATION PROCEDURE AS PER BHEL CONCILIATION SCHEME 2018. THE PROCEEDINGS OF CONCILIATION SHALL BROADLY BE GOVERNED BY PART-III OF THE ARBITRATION AND CONCILIATION ACT 1996 OR ANY STATUTORY MODIFICATION THEREOF AND AS PROVIDED IN - "PROCEDURE FOR CONDUCT OF CONCILIATION PROCEEDINGS" (AS AVAILABLE IN WWW.BHEL.COM)).</p> <p>Note:</p> <p>MINISTRY OF FINANCE HAS ISSUED OM REFERENCE NO. 1/2/24 DATED 03.06.2024 REGARDING "GUIDELINES FOR ARBITRATION AND MEDIATION IN CONTRACTS OF DOMESTIC PUBLIC PROCUREMENT. IN THE SAID OM IT HAS BEEN RECOMMENDED THAT GOVERNMENT DEPARTMENTS/ ENTITIES/AGENCIES ARE TO ENCOURAGE MEDIATION UNDER THE MEDIATION ACT. 2023. THE SAID ACT HAS NOT YET BEEN NOTIFIED BY THE GOVERNMENT. THEREFORE, THE CLAUSE "SETTLEMENT OF DISPUTES" SHALL BE MODIFIED ACCORDINGLY AS AND WHEN THE MEDIATION ACT 2023 GETS NOTIFIED.</p>	
34.	<p>ARBITRATION (14.2) :</p>	

**GENERAL COMMERCIAL TERMS & CONDITIONS OF ENQUIRY
(FOR INDIAN VENDORS)**

Amendment- 27
ANNEXURE-A

	<p>14.2.1 EXCEPT AS PROVIDED ELSEWHERE IN THIS CONTRACT, IN CASE PARTIES ARE UNABLE TO REACH AMICABLE SETTLEMENT (WHETHER BY CONCILIATION TO BE CONDUCTED AS PROVIDED IN CLAUSE 14.1 HEREIN ABOVE OR OTHERWISE) IN RESPECT OF ANY DISPUTE OR DIFFERENCE; ARISING OUT OF THE FORMATION, BREACH, TERMINATION, VALIDITY OR EXECUTION OF THE CONTRACT; OR, THE RESPECTIVE RIGHTS AND LIABILITIES OF THE PARTIES; OR, IN RELATION TO INTERPRETATION OF ANY PROVISION OF THE CONTRACT; OR, IN ANY MANNER TOUCHING UPON THE CONTRACT (HEREINAFTER REFERRED TO AS THE 'DISPUTE'), THEN, EITHER PARTY MAY, REFER THE DISPUTES TO ARBITRAL INSTITUTION (TO BE IDENTIFIED BY BHEL VARANASI) AND SUCH DISPUTE TO BE ADJUDICATED BY SOLE ARBITRATOR APPOINTED IN ACCORDANCE WITH THE RULES OF SAID ARBITRAL INSTITUTION.</p> <p>14.2.2 A PARTY WILLING TO COMMENCE ARBITRATION PROCEEDING SHALL INVOKE ARBITRATION CLAUSE BY GIVING NOTICE TO THE OTHER PARTY IN TERMS OF SECTION 21 OF THE ARBITRATION & CONCILIATION ACT, 1996 (HEREINAFTER REFERRED TO AS THE 'NOTICE') BEFORE REFERRING THE MATTER TO ARBITRAL INSTITUTION. THE NOTICE SHALL BE ADDRESSED TO THE HEAD OF THE UNIT, BHEL, EXECUTING THE CONTRACT AND SHALL CONTAIN THE PARTICULARS OF ALL CLAIMS TO BE REFERRED TO ARBITRATION WITH SUFFICIENT DETAIL AND SHALL ALSO INDICATE THE MONETARY AMOUNT OF SUCH CLAIM INCLUDING INTEREST, IF ANY.</p> <p>14.2.3 AFTER EXPIRY OF 30 DAYS FROM THE DATE OF RECEIPT OF AFORESAID NOTICE, THE PARTY INVOKING THE ARBITRATION SHALL SUBMIT THAT DISPUTE TO THE ARBITRAL INSTITUTIONS (TO BE IDENTIFIED BY BHEL VARANASI)AND THAT DISPUTE SHALL BE ADJUDICATED IN ACCORDANCE WITH THEIR RESPECTIVE ARBITRATION RULES. THE MATTER SHALL BE ADJUDICATED BY A SOLE ARBITRATOR WHO SHALL NECESSARILY BE A RETD JUDGE HAVING CONSIDERABLE EXPERIENCE IN COMMERCIAL MATTERS TO BE APPOINTED/NOMINATED BY THE RESPECTIVE INSTITUTION. THE COST/EXPENSES PERTAINING TO THE SAID ARBITRATION SHALL ALSO BE GOVERNED IN ACCORDANCE WITH THE RULES OF THE RESPECTIVE ARBITRAL INSTITUTION. THE DECISION OF THE PARTY INVOKING THE ARBITRATION FOR REFERENCE OF DISPUTE TO A SPECIFIC ARBITRAL INSTITUTION FOR ADJUDICATION OF THAT DISPUTE SHALL BE FINAL AND BINDING ON BOTH THE PARTIES AND SHALL NOT BE SUBJECT TO ANY CHANGE THEREAFTER. THE INSTITUTION ONCE SELECTED AT THE TIME OF INVOCATION OF DISPUTE SHALL REMAIN UNCHANGED.</p> <p>14.2.4 THE FEE AND EXPENSES SHALL BE BORNE BY THE PARTIES AS PER THE ARBITRAL INSTITUTIONAL RULES.</p> <p>14.2.5 THE ARBITRATION PROCEEDINGS SHALL BE IN ENGLISH LANGUAGE AND THE SEAT AND VENUE OF ARBITRATION SHALL BE AT Varanasi (U.P.).</p> <p>14.2.6 SUBJECT TO THE ABOVE, THE PROVISIONS OF ARBITRATION & CONCILIATION ACT 1996 AND ANY AMENDMENT THEREOF SHALL BE APPLICABLE. ALL MATTERS RELATING TO THIS CONTRACT AND ARISING OUT OF INVOCATION OF ARBITRATION CLAUSE ARE SUBJECT TO THE EXCLUSIVE JURISDICTION OF THE COURT(S) SITUATED AT Varanasi (U.P.).</p> <p>14.2.7 NOTWITHSTANDING ANY REFERENCE TO THE DESIGNATED ENGINEER OR CONCILIATION OR ARBITRATION HEREIN, A. THE PARTIES SHALL CONTINUE TO PERFORM THEIR RESPECTIVE OBLIGATIONS UNDER THE CONTRACT UNLESS THEY OTHERWISE AGREE. SETTLEMENT OF DISPUTE CLAUSE CANNOT BE INVOKED BY THE CONTRACTOR, IF THE CONTRACT HAS BEEN MUTUALLY CLOSED OR 'NO DEMAND CERTIFICATE' HAS BEEN FURNISHED BY THE CONTRACTOR OR ANY SETTLEMENT AGREEMENT HAS BEEN SIGNED BETWEEN THE EMPLOYER AND THE CONTRACTOR.</p> <p>14.2.8 IT IS AGREED THAT MECHANISM OF RESOLUTION OF DISPUTES THROUGH ARBITRATION SHALL BE AVAILABLE ONLY IN THE CASES WHERE THE VALUE OF THE DISPUTE IS LESS THAN RS. 10 CRORES.</p> <p>14.2.9 IN CASE THE DISPUTED AMOUNT CLAIM, COUNTER CLAIM INCLUDING INTEREST IS RS. 10 CRORES AND ABOVE, THE PARTIES SHALL BE WITHIN THEIR RIGHTS TO TAKE RECOURSE TO REMEDIES OTHER THAN ARBITRATION, AS MAY BE AVAILABLE TO THEM UNDER THE APPLICABLE LAWS AFTER PRIOR INTIMATION TO THE OTHER PARTY. SUBJECT TO THE AFORESAID CONDITIONS, PROVISIONS OF THE ARBITRATION AND CONCILIATION ACT, 1996 AND ANY STATUTORY MODIFICATIONS OR RE-ENACTMENT THEREOF AS AMENDED FROM TIME TO TIME, SHALL APPLY TO THE ARBITRATION PROCEEDINGS UNDER THIS CLAUSE.</p> <p>14.2.10 IN CASE, MULTIPLE ARBITRATIONS ARE INVOKED (WHETHER SUB-JUDICE OR ARBITRAL AWARD PASSED) BY ANY PARTY TO UNDER THIS CONTRACT, THEN THE CUMULATIVE VALUE OF CLAIMS (INCLUDING INTEREST CLAIMED OR AWARDED) IN ALL SUCH ARBITRATIONS SHALL BE TAKEN IN ACCOUNT WHILE ARRIVING AT THE TOTAL CLAIM IN DISPUTE FOR THE SUBJECT CONTRACT FOR THE PURPOSE OF CLAUSE 14.2.9. DISPUTES HAVING CUMULATIVE VALUE OF LESS THAN 10 CRORES SHALL BE RESOLVED THROUGH ARBITRATION AND ANY ADDITIONAL DISPUTE SHALL BE ADJUDICATED BY THE COURT OF COMPETENT JURISDICTION.</p> <p>14.2.11 IN CASE OF CONTRACT WITH PUBLIC SECTOR ENTERPRISE (PSE) OR A GOVERNMENT DEPARTMENT, THE FOLLOWING SHALL BE APPLICABLE: IN THE EVENT OF ANY DISPUTE OR DIFFERENCE RELATING TO THE INTERPRETATION AND APPLICATION OF THE PROVISIONS OF COMMERCIAL CONTRACT(S) BETWEEN CENTRAL PUBLIC SECTOR ENTERPRISES (CPSES)/ PORT TRUSTS INTER SE AND ALSO BETWEEN CPSES AND GOVERNMENT DEPARTMENTS/ORGANIZATIONS (EXCLUDING DISPUTES CONCERNING RAILWAYS, INCOME TAX, CUSTOMS & EXCISE DEPARTMENTS), SUCH DISPUTE OR DIFFERENCE SHALL BE TAKEN UP BY EITHER PARTY FOR RESOLUTION THROUGH AMRCD (ADMINISTRATIVE MECHANISM FOR RESOLUTION OF CPSES DISPUTES) AS MENTIONED IN DPE OM NO. 05/0003/2019-FTS-10937 DATED 14-12-2022 AS AMENDED FROM TIME TO TIME.</p>	
35.	<p>JURISDICTION : THIS CONTRACT SHALL BE GOVERNED BY THE LAW FOR THE TIME BEING IN FORCE IN THE REPUBLIC OF INDIA. THE CIVIL COURT HAVING ORIGINAL CIVIL JURISDICTION AT VARANASI-UP, SHALL ALONE HAVE EXCLUSIVE JURISDICTION IN REGARD TO ALL MATTERS IN RESPECT OF THE CONTRACT.</p>	
36.	<p>I. FOLLOWING DOCUMENTS SHOULD BE ENCLOSED AND ADDRESSED TO DGM (FINANCE) AND SAME SHALL BE DISPATCHED TO MM DEPTT. BHEL, HERP, TARNA, SHIVPUR, VARANASI-221003 FOR PAYMENT PURPOSE:</p> <ol style="list-style-type: none"> 05 (FIVE) COPIES OF GST INVOICES COPY OF GR/RR. TEST CERTIFICATE AND GUARANTEE/WARRANTEE CERTIFICATE AND PDI REPORT, IF APPLICABLE. (ONE COPY). <p>II. FURTHER TO ABOVE, 02 (TWO) COMPLETE SETS OF DOCUMENTS (COPIES OF ABOVE MENTIONED DOCUMENTS AT SL. NO. I FOR INDIAN SUPPLIERS (UNDER THIS CLAUSE) SHALL BE SENT FOR PURCHASE AND QUALITY DEPARTMENTS. ORIGINAL COPIES OF TC, GC, PDI REPORTS & OTHER QUALITY PAPERS SHALL BE ATTACHED IN THE SET OF DOCUMENTS FOR QUALITY DEPARTMENTS.</p> <p>III. THE VENDOR SHOULD PROVIDE BILLS & OTHER DOCUMENTS COMPLETE IN ALL RESPECT AS PER PURCHASE ORDER ALONGWITH DESPATCH OF MATERIALS. BHEL SHALL SEEK CLARIFICATION(S) (IF ANY) RELATED TO PAYMENT DOCUMENTS IN ONE GO. THE VENDOR SHOULD PROVIDE ALL SUCH CLARIFICATION(S) IMMEDIATELY.ANY DELAY IN PROCESSING OF PAYMENT, DUE TO NON RECEIPT OF CLARIFICATION(S) SOUGHT BY BHEL, SHALL BE ATTRIBUTABLE COMPLETELY TO VENDOR.</p> <p>IV. DIGITALLY SIGNED INVOICE IS ALSO ACCEPTABLE FOR PROCESSING OF PAYMENT.</p>	
37.	<p>THE VENDOR SHALL ENSURE THAT THEIR BANK DETAILS ARE UPDATED WITH US FOR TIMELY PAYMENT THROUGH EFT (ELECTRONICS FUND TRANSFER).</p>	
38.	<p>GUIDELINES FOR SUSPENSION OF BUSINESS DEALINGS WITH SUPPLIERS/ CONTRACTORS: THE REVISED GUIDELINES FOR SUSPENSION OF BUSSINESS DEALINGS ARE AVAILABLE ON BHEL WEBSITE AT "www.bhel.com" on "SUPPLIER REGISTRATION PAGE". RESPECTIVE BIDDERS / SUPPLIERS MAY REFER THIS BEFORE QUOTING AS PER THEIR REQUIREMENT. ACTION AGAINST THE DEFAULTED SUPPLIERS/ CONTRACTORS' SHALL BE TAKEN AS PER THESE GUIDELINES ONLY.</p>	
39.	<p>VENDOR MUST FOLLOW THE SEQUENTIAL DELIVERY SCHEDULE i.e. ITEMS TO BE SUPPLIED IN SUCH A MANNER THAT THE PURCHASE ORDER HAVING OLDER DELIVERY SCHEDULE SHOULD BE SUPPLIED EARLIER AND PURCHASE ORDER HAVING LATTER DELIVERY SCHEDULE TO BE SUPPLIED LATTER. IF ANY VENDOR DOES NOT FOLLOW THE SEQUENTIAL DELIVERY SCHEDULE ESPECIALLY FOR SAME ITEM, BHEL MAY ACCOUNT FOR THE ITEM IN SEQUENTIAL MANNER OR MAY RECOVER THE FINANCIAL IMPLICATION.</p>	
40.	<p>ALL ABOVE ACCEPTED TERMS & CONDITIONS SHALL BE PART OF PURCHASE ORDER WITH OR WITHOUT MENTIONING IN THE PO/CONTRACT BASED ON YOUR ACCEPTANCE AND OFFER SUBMITTED.</p>	

**GENERAL COMMERCIAL TERMS & CONDITIONS OF ENQUIRY
(FOR INDIAN VENDORS)**

Amendment- 27
ANNEXURE-A

41.	<p>IMPORTANT INSTRUCTION:</p> <p>I.VENDORS ARE REQUESTED TO QUOTE THEIR RATE WITH DESCRIPTION MENTIONED IN THE ENQUIRY CONSIDERING ALL TECHNICAL TERMS & CONDITIONS OF THE ENQUIRY. ALSO RATES QUOTED SHOULD BE EXACTLY AS PER SL. NO. OF HARD COPY OF THE ENQUIRY (IF ENQUIRY HAS BEEN FLOATED THROUGH CONVENTIONAL MODE) OR AS PER SL. NO. APPEARING IN THE e-Procurement PORTAL (IF ENQUIRY HAS BEEN FLOATED THROUGH e-Procurement) ONLY. IT MUST BE FOLLOWED UP TO AVOID CONFUSION AT LATER STAGES. ALSO RATES TO BE SUBMITTED BOTH IN NUMERICS AS WELL AS IN WORD. IN CASE OF DISCREPENCY, RATES SUBMITTED IN WORDS SHALL BE CONSIDERED FOR FURTHER PROCESSING.</p> <p>II.DOCUMENTS SUBMITTED WITH THE OFFER SHOULD BE SIGNED AND STAMPED IN EACH PAGE BY AUTHORIZED REPRESENTATIVE OF THE BIDDER.</p> <p>II.II.IN CASE OF PDI, VENDOR SHALL RAISE ONLINE INSPECTION CALL IN ONLINE INSPECTION PORTAL/INTIMATE BHEL IN WRITTING (WHERE INSPECTION IS IN BHEL HERP SCOPE) AT LEAST 01 WEEK IN ADVANCE OR AS MUTUALLY AGREED PERIOD ABOUT THE DATE AND PLACE AT WHICH GOODS WILL BE READY FOR INSPECTION.</p> <p>IV.PURCHASER OR HIS AUTHORIZED REPRESENTATIVE SHALL BE ENTITLED TO CARRY OUT SURVEILLANCE INSPECTION OF MATERIAL AND WORKMANSHIP AT SELLER'S PREMISES OR AT HIS SUB-CONTRACTOR'S PREMISES AT ALL REASONABLE TIMES DURING EXECUTION OF THE CONTRACT. SUCH INSPECTION, EXAMINATION AND TESTING, IF MADE, SHALL NOT ABSOLVE THE SELLER FROM HIS OBLIGATIONS UNDER THE CONTRACT.</p> <p>V.SUCH PRE-DISPATCH INSPECTION, EXAMINATION AND TESTING, IF MADE, AT VENDOR'S WORKS SHALL NOT ABSOLVE THE SELLER FROM HIS OBLIGATIONS TO MANUFACTURE/MACHINING THE GOODS UNDER THE CONTRACT. IF DEFECTS ARE FOUND AT LATER STAGE, IT IS THE SOLE RESPONSIBILITY OF THE VENDOR TO REPLACE/RECTIFY THE SAME.</p>	
42.	<p>IMPORTANT CLAUSE FOR GST: INPUT TAX CREDIT OF GST CAN BE AVAILED BY BHEL ONLY WHEN THE MATERIAL HAS BEEN PHYSICALLY RECEIVED AND GST INVOICE IS IN POSSESSION OF BHEL. THEREFORE, SUPPLIERS SHOULD ENSURE THE FOLLOWING IN RESPECT OF POS ISSUED BY BHEL:</p> <p>I. GST INVOICE SHOULD CONTAIN ADDRESS, GST NO. AND PAN NO. OF BHEL AS WELL AS OF SUPPLIER. APPLICABLE HSN CODE OF THE MATERIAL SHOULD BE INDICATED IN THE GST INVOICE.</p> <p>II. FIVE COPIES OF GST INVOICE AND LORRY RECEIPT MAY BE DESPATCHED ALONGWITH SHIPMENT OF THE GOODS IN ORDER TO AVOID ANY DELAY IN AVAILING INPUT CREDIT BY BHEL.</p> <p>III. DECLARE SUCH INVOICE IN HIS GSTR-1 RETURN FOR THE MONTH OF DESPATCH OF MATERIAL.</p> <p>IV. PAYMENT OF GST TO STATUTORY AUTHORITIES WITHIN PRESCRIBED TIME.</p> <p>V. IN CASE OF DISCREPANCY IN THE DATA UPLOADED BY THE BIDDER IN THE GSTN PORTAL VIS-A-VIS THE TAX INVOICE OR IN CASE OF ANY SHORTAGES OR REJECTION IN THE SUPPLY, THEN BHEL WILL NOT BE ABLE TO AVAIL THE TAX CREDIT. BIDDER HAS TO RECTIFY THE DATA DISCREPANCY IN THE GSTN PORTAL OR ISSUE CREDIT NOTE OR DEBIT NOTE (DETAILS ALSO TO BE UPLOADED IN GSTN PORTAL) FOR THE SHORTAGES OR REJECTIONS IN THE SUPPLIES OR ADDITIONAL CLAIMS FOR PROCESSING OF SUCH INVOICES.</p> <p>VI. GST TDS DEDUCTED AS PER GST ACT, IS UPLOADED IN GSTN PORTAL ALONG GSTR7. BIDDERS CAN DIRECTLY DOWNLOAD THE GST TDS CERTIFICATE FROM THE GSTN PORTAL.</p> <p>IN CASE GST CREDIT IS DELAYED /DENIED TO BHEL DUE TO NON OR DELAYED RECEIPT OF GOODS AND OR TAX INVOICE OR EXPIRY OF TIMELINE PRESCRIBED IN GST LAW FOR AVAILING SUCH ITC OR ANY OTHER REASON NOT ATTRIBUTABLE TO BHEL, GST AMOUNT SHALL BE RECOVERABLE FROM VENDOR ALONG WITH INTEREST /PENALTY LEVIABLE ON BHEL.</p> <p>IN CASE SUPPLIERS DELAYS DECLARING SUCH INVOICE IN HIS RETURN AND GST CREDIT AVAILED BY BHEL IS DENIED OR REVERSED SUBSEQUENTLY AS PER GST LAW, GST AMOUNT PAID BY BHEL TOWARDS SUCH ITC REVERSAL SHALL BE RECOVERABLE FROM SUPPLIER ALONGWITH INTEREST LEVIED/LEVIABLE ON BHEL.</p> <p>IN CASE OF RAISING ANY SUPPLEMENTARY TAX INVOICE (DEBIT/ CREDIT NOTE), THE SUPPLIER SHALL ISSUE THE SAME CONTAINING ALL THE DETAILS AS REFERRED TO IN SECTION 34 READ WITH SECTION 31 OF GST ACT & RULES REFERRED THERE UNDER .</p>	
43.	<p>STATUTORY VARIATION CLAUSE : ANY INCREASE IN THE RATE OF GST SHALL BE PAYABLE ONLY FOR DELIVERIES COMPLETED WITHIN THE SCHEDULED DELIVERY PERIOD, IN OTHER WORDS INCREASE IN THE RATE OF GST SHALL NOT BE PAYABLE FOR VALUE OF CONSIGNMENT DELIVERED AFTER THE SCHEDULED PURCHASE ORDER DELIVERY PERIOD.2.NEW TAXES AND DUTIES, IF IMPOSED SUBSEQUENT TO DUE DATE OF OFFER SUBMISSION, BY STATUTORY AUTHORITY DURING CONTRACT PERIOD (INCLUDING EXTENSION IF THE SAME IS NOT ATTRIBUTABLE TO BIDDER) SHALL BE REIMBURSED BY BHEL ON PRODUCTION OF RELEVANT SUPPORTING DOCUMENTS TO THE SATISFACTION OF BHEL. HOWEVER, BIDDER SHALL TAKE PRIOR APPROVAL OF BHEL BEFORE DEPOSITING NEW TAXES AND DUTIES.</p>	
44.	<p>IMPORTANT INSTRUCTION FOR MSEs SUPPLIERS:</p> <p>I. "MSE SUPPLIERS CAN AVAIL THE INTENDED BENEFITS ONLY IF THEY SUBMIT ALONG WITH OFFER, ATTESTED COPIES OF EITHER EM-II CERTIFICATE HAVING DEEMED VALIDITY (FIVE YEARS FROM THE DATE OF ISSUE OF ACKNOWLEDGEMENT IN EM-II) OR VALID NSIC CERTIFICATE OR EM-II CERTIFICATE ALONG WITH CA CERTIFICATE (FORMAT ENCLOSED AS PER ANNEXURE-1 WHERE DEEMED VALIDITY OF EM-II CERTIFICATE OF FIVE YEARS HAS EXPIRED) APPLICABLE FOR THE RELEVANT F/Y (LATEST AUDITED).DATE TO BE RECKONED FOR DETERMINING THE DEEMED VALIDITY WILL BE THE DATE OF BID OPENING (PART -1 IN CASE OF TWO PART BID). NON SUBMISSION OF SUCH DOCUMENTS WILL LEAD TO CONSIDERATION OF THEIR BID AT PAR WITH OTHER BIDDERS. NO BENEFIT SHALL BE APPLICABLE FOR THIS ENQUIRY IF ANY DEFICIENCY IN THE ABOVE REQUIRED DOCUMENTS ARE NOT SUBMITTED BEFORE PRICE BID OPENING. IF THE TENDER IS TO BE SUBMITTED THROUGH e-procurement PORTAL, THEN THE ABOVE REQUIRED DOCUMENTS ARE TO BE UPLOADED ON THE PORTAL. DOCUMENTS SHOULD BE NOTARIZED OR ATTESTED BY A GAZETTED OFFICE.</p> <p>II.IN CASE OF ANY CHANGE IN THE MSE STATUS OF THE BIDDER, IT SHALL BE RESPONSIBILITY OF THE BIDDER TO NOTIFY THE CHANGE AS A PART OF THE BID DOCUMENT. IF AT A LATER DATE IT COMES TO NOTICE OF BHEL, THAT THE CHANGE IN THE STATUS HAS NOT BEEN INTIMATED BY THE BIDDER AND THE ORDER IS OBTAINED UNDER THE PREMISE OF AN MSE, THEN BHEL WOULD CANCEL THE PENDING ORDER AGAINST THIS TENDER AND TAKE NECESSARY ACTION SUSPENSION OF THE BUSSINESS DEALING WITH THE BIDDER AS PER PROCUREMENT POLICY OF BHEL.</p> <p>III.25 % OF THE TENDERED QUANTITY IS EARMARKED FOR MSE SUPPLIERS IN THIS TENDER.</p> <p>IV.OUT OF THIS 25% TENDERED QUANTITY RESERVED FOR MSE SUPPLIERS, 4 % SHALL BE EARMARKED FOR PROCUREMENT FROM MSEs OWNED BY SC/ST ENTREPRENEURS.</p> <p>V.OUT OF THIS 25% TENDERED QUANTITY RESERVED FOR MSE SUPPLIERS, 3% SHALL BE EARMARKED FOR PROCUREMENT FROM MSEs OWNED BY WOMEN.</p> <p>VI.IN CASE MSE VENDOR PARTICIPATING IN THE TENDER QUOTES WITHIN THE PRICE BAND OF "L1+15%", THEY WILL BE ALLOWED TO SUPPLY THE 25% PORTION OF THE REQUIREMENT SUBJECT TO ACCEPTANCE OF L1 PRICE (ON LANDED COST BASIS) BY MSE VENDOR. IN CASE OF MORE THAN ONE SUCH MSE VENDOR WITHIN THE "L1+15% PRICE BAND" THE SUPPLY SHALL BE SHARED PROPORTIONATELY (TO 25% TENDERED QUANTITY).</p> <p>VII.IF THE L1 VENDOR HAPPENS TO BE A MSE VENDOR AGAINST ANY ITEM CODE, THEN 100% OF THE TENDERED QTY (FOR RESPECTIVE ITEM CODE) SHALL BE PROPOSED TO ORDER ON THE L1 (MSE) VENDOR, EVEN THOUGH THERE MAY BE OTHER MSE VENDORS WITHIN THE "L1+15% PRICE BAND".</p> <p>VIII.IN CASE AFTER OPENING OF PRICE BID, IT IS SEEN THAT NO MSE HAS BECOME L1, THEN DEPENDING ON THE NATURE OF THE ITEM, IF IT IS NOT POSSIBLE TO SPLIT THE TENDERED ITEMS/QUANTITIES ON ACCOUNT OF REASONS LIKE CUSTOMER CONTRACT REQUIREMENTS OF SUPPLYING ONE MAKE FOR A GIVEN PROJECT OR TECHNICAL REASONS LIKE TENDERED ITEMS BEING A SYSTEM etc. THEN BHEL WOULD NOT COUNTER OFFER THE L1 PRICES EVEN THOUGH THERE MAY BE MSE BIDDERS WITHIN THE "L1+15% PRICE BAND" OF L1.</p>	
45.	<p>THE STARTUPS AS DEFINED IN THE GAZETTE OF INDIA NOTIFICATION NO.: G.S.R. 127 (E) DATED 19/02/2019 WILL BE EXEMPTED FROM FULFILLING THE CRITERIA, IF MENTIONED, IN THE PQR (PRE-QUALIFYING REQUIREMENT) REGARDING PRIOR TURNOVER AND PRIOR EXPERIENCE. HOWEVER, THERE MAY BE CIRCUMSTANCES (LIKE PROCUREMENTS OF ITEMS RELATED TO PUBLIC SAFETY, HEALTH, CRITICAL SECURITY OPERATIONS AND EQUIPMENTS ETC.) WHERE BHEL MAY PREFER THE VENDORS TO HAVE PRIOR EXPERIENCE RATHER THAN GIVING ORDER TO NEW ENTITIES. FOR SUCH PROCUREMENTS, BHEL MAY NOT RELAX THE CRITERIA OF PRIOR EXPERIENCE/TURNOVER FOR THE STARTUPS.</p>	
46.	<p>PURCHASE PREFERENCE FOR INDIAN VENDORS: FOR THIS PROCUREMENT, THE LOCAL CONTENT TO CATEGORIZE A SUPPLIER AS A CLASS I LOCAL SUPPLIER / CLASS II LOCAL SUPPLIER /NON LOCAL – SUPPLIER AND PURCHASE PREFERENCE TO CLASS I LOCAL SUPPLIER, IS AS DEFINED IN PUBLIC PROCUREMENT (PREFERENCE TO MAKE IN INDIA), ORDER 2017 DATED 04.06.2020 ISSUED BY DPIIT. IN CASE OF SUBSEQUENT ORDERS ISSUED BY THE NODAL MINISTRY, CHANGING THE DEFINITION OF LOCAL CONTENT FOR THE ITEMS OF THE NIT, THE SAME SHALL BE APPLICABLE EVEN IF ISSUED AFTER ISSUE OF THIS NIT, BUT BEFORE OPENING OF PART –II BIDS AGAINST THIS NIT.</p> <p>MODEL CLAUSE FOR TENDER.</p> <p>I. ANY BIDDER FROM A COUNTRY WHICH SHARES A LAND BORDER WITH INDIA WILL BE ELIGIBLE TO BID IN THIS TENDER ONLY IF THE BIDDER IS REGISTERED WITH THE COMPETENT AUTHORITY.</p>	

**GENERAL COMMERCIAL TERMS & CONDITIONS OF ENQUIRY
(FOR INDIAN VENDORS)**

Amendment- 27

ANNEXURE-A

	<p>II. "BIDDER" (INCLUDING THE TERM 'TENDERER', 'CONSULTANT' OR 'SERVICE PROVIDER' IN CERTAIN CONTEXTS) MEANS ANY PERSON OR FIRM OR COMPANY, INCLUDING ANY MEMBER OF A CONSORTIUM OR JOINT VENTURE (THAT IS AN ASSOCIATION OF SEVERAL PERSONS, OR FIRMS OR COMPANIES), EVERY ARTIFICIAL JURIDICAL PERSON NOT FALLING IN ANY OF THE DESCRIPTIONS OF BIDDERS STATED HEREINBEFORE, INCLUDING ANY AGENCY BRANCH OR OFFICE CONTROLLED BY SUCH PERSON, PARTICIPATING IN A PROCUREMENT PROCESS.</p> <p>III. "BIDDER FROM A COUNTRY WHICH SHARES A LAND BORDER WITH INDIA" FOR THE PURPOSE OF THIS ORDER MEANS: -</p> <p>a) AN ENTITY INCORPORATED, ESTABLISHED OR REGISTERED IN SUCH A COUNTRY; OR</p> <p>b) A SUBSIDIARY OF AN ENTITY INCORPORATED, ESTABLISHED OR REGISTERED IN SUCH A COUNTRY; OR</p> <p>c) AN ENTITY SUBSTANTIALLY CONTROLLED THROUGH ENTITIES INCORPORATED, ESTABLISHED OR REGISTERED IN SUCH A COUNTRY; OR</p> <p>d) AN ENTITY WHOSE BENEFICIAL OWNER IS SITUATED IN SUCH A COUNTRY; OR</p> <p>e) AN INDIAN (OR OTHER) AGENT OF SUCH AN ENTITY; OR</p> <p>f) A NATURAL PERSON WHO IS A CITIZEN OF SUCH A COUNTRY; OR</p> <p>g) A CONSORTIUM OR JOINT VENTURE WHERE ANY MEMBER OF THE CONSORTIUM OR JOINT VENTURE FALLS UNDER ANY OF THE ABOVE</p> <p>IV. THE BENEFICIAL OWNER FOR THE PURPOSE OF (III) ABOVE WILL BE AS UNDER:</p> <p>1. IN CASE OF A COMPANY OR LIMITED LIABILITY PARTNERSHIP, THE BENEFICIAL OWNER IS THE NATURAL PERSON (S) WHO, WHETHER ACTING ALONE OR TOGETHER, OR THROUGH ONE OR MORE JURIDICAL PERSON, HAS A CONTROLLING OWNERSHIP INTEREST OR WHO EXERCISES CONTROL THROUGH OTHER MEANS.</p> <p>EXPLANATION –</p> <p>a. "CONTROLLING OWNERSHIP INTEREST" MEANS OWNERSHIP OF OR ENTITLEMENT TO MORE THAN TWENTY-FIVE PER CENT. OF SHARES OR CAPITAL OR PROFITS OF THE COMPANY</p> <p>b. "CONTROL" SHALL INCLUDE THE RIGHT TO APPOINT MAJORITY OF THE DIRECTORS OR TO CONTROL THE MANAGEMENT OR POLICY DECISIONS INCLUDING BY VIRTUE OF THEIR SHAREHOLDING OR MANAGEMENT RIGHTS OR SHAREHOLDER'S AGREEMENTS OF VOTING AGREEMENTS;</p> <p>2. IN CASE OF A PARTNERSHIP FIRM, THE BENEFICIAL OWNER IS THE NATURAL PERSON (S) WHO, WHETHER ACTING ALONE OR TOGETHER, OR THROUGH ONE OR MORE JURIDICAL OF CAPITAL OR PROFITS OF THE PARTNERSHIP;</p> <p>3. IN CASE OF AN UNINCORPORATED ASSOCIATION OR BODY OF INDIVIDUALS, THE BENEFICIAL OWNER IS THE NATURAL PERSON (S), WHO, WHETHER ACTING ALONE OR TOGETHER, OR THROUGH ONE OR MORE JURIDICAL PERSON, HAS OWNERSHIP OF OR ENTITLEMENT TO MORE THAN FIFTEEN PERCENT OF THE PROPERTY OF CAPITAL OF PROFITS OF SUCH ASSOCIATION OR BODY OF INDIVIDUALS;</p> <p>4. WHERE NO NATURAL PERSON IS IDENTIFIED UNDER (1) OR (2) OR (3) ABOVE, THE BENEFICIAL OWNER IS THE RELEVANT NATURAL PERSON WHO HOLDS THE POSITION OF SENIOR MANAGING OFFICIAL;</p> <p>5. IN CASE OF TRUST, THE IDENTIFICATION OF BENEFICIAL OWNER (S) SHALL INCLUDE IDENTIFICATION OF THE AUTHOR OF THE TRUST, THE TRUSTEE, THE BENEFICIARIES WITH FIFTEEN PERCENT OR MORE INTEREST IN THE TRUST AND ANY OTHER NATURAL PERSON EXERCISING ULTIMATE EFFECTIVE CONTROL OVER THE TRUST THROUGH A CHAIN OF CONTROL OR OWNERSHIP.</p> <p>V. AN AGENT IS A PERSON EMPLOYED TO DO ANY ACT FOR ANOTHER, OR TO REPRESENT ANOTHER IN DEALINGS WITH THIRD PERSON.</p> <p>CERTIFICATE: IN ORDER TO AVAIL THE BENEFITS, VENDORS TO SUBMIT (ALONG WITH OFFER) THE SELF-CERTIFICATION THAT THE ITEM OFFERED MEETS THE CONTENT REQUIREMENT FOR CLASS-I/ CLASS-II LOCAL SUPPLIER AS THE CASE MAY BE, INDICATING THE PERCENTAGE OF LOCAL CONTENT . AND SHALL GIVE DETAILS OF LOCATION AT WHICH THE LOCAL VALUE ADDITION IS MADE (refer attached Make in India (Model Certificate no I)).</p>	
47.	<p>13.1 "FORCE MAJEURE" SHALL MEAN CIRCUMSTANCE WHICH IS:</p> <p>A) BEYOND CONTROL OF EITHER OF THE PARTIES TO CONTRACT,</p> <p>B) EITHER OF THE PARTIES COULD NOT REASONABLY HAVE PROVIDED AGAINST THE EVENT BEFORE ENTERING INTO THE CONTRACT,</p> <p>C) HAVING ARISEN, EITHER OF THE PARTIES COULD NOT REASONABLY HAVE AVOIDED OR OVERCOME, AND</p> <p>D) IS NOT SUBSTANTIALLY ATTRIBUTABLE TO EITHER OF THE PARTIES</p> <p>AND</p> <p>PREVENTS THE PERFORMANCE OF THE CONTRACT</p> <p>SUCH CIRCUMSTANCES INCLUDE BUT SHALL NOT BE LIMITED TO:</p> <p>I) WAR, HOSTILITIES, INVASION, ACT OF FOREIGN ENEMIES.</p> <p>II) REBELLION, TERRORISM, REVOLUTION, INSURRECTION, MILITARY OR USURPED POWER, OR CIVIL WAR.</p> <p>III) RIOT, COMMOTION OR DISORDER BY PERSONS OTHER THAN THE CONTRACTOR'S PERSONNEL AND OTHER EMPLOYEES OF THE CONTRACTOR AND SUB-CONTRACTORS.</p> <p>IV) STRIKE OR LOCKOUT NOT SOLELY INVOLVING THE CONTRACTOR'S PERSONNEL AND OTHER EMPLOYEES OF THE CONTRACTOR AND SUB-CONTRACTORS.</p> <p>V) ENCOUNTERING MUNITIONS OF WAR, EXPLOSIVE MATERIALS, IONIZING RADIATION OR CONTAMINATION BY RADIO-ACTIVITY, EXCEPT AS MAY BE ATTRIBUTABLE TO THE CONTRACTOR'S USE OF SUCH MUNITIONS, EXPLOSIVES, RADIATION OR RADIO- ACTIVITY.</p> <p>VI) NATURAL CATASTROPHES SUCH AS EARTHQUAKE, TSUNAMI, VOLCANIC ACTIVITY, HURRICANE OR TYPHOON, FLOOD, FIRE, CYCLONES ETC.</p> <p>VII) EPIDEMIC, PANDEMIC ETC</p> <p>13.2 THE FOLLOWING EVENTS ARE EXPLICITLY EXCLUDED FROM FORCE MAJEURE AND ARE SOLELY THE RESPONSIBILITIES OF THE NON-PERFORMING PARTY: A) ANY STRIKE, WORK-TO-RULE ACTION, GO-SLOW OR SIMILAR LABOUR DIFFICULTY (B) LATE DELIVERY OF EQUIPMENT OR MATERIAL (UNLESS CAUSED BY FORCE MAJEURE EVENT) AND (C) ECONOMIC HARDSHIP.</p> <p>13.3 IF EITHER PARTY IS PREVENTED, HINDERED OR DELAYED FROM OR IN PERFORMING ANY OF ITS OBLIGATIONS UNDER THE CONTRACT BY AN EVENT OF FORCE MAJEURE, THEN IT SHALL NOTIFY THE OTHER IN WRITING OF THE OCCURRENCE OF SUCH EVENT AND THE CIRCUMSTANCES THEREOF WITHIN 15 (FIFTEEN) DAYS AFTER THE OCCURRENCE OF SUCH EVENT.</p> <p>13.4 THE PARTY WHO HAS GIVEN SUCH NOTICE SHALL BE EXCUSED FROM THE PERFORMANCE OR PUNCTUAL PERFORMANCE OF ITS OBLIGATIONS UNDER THE CONTRACT FOR SO LONG AS THE RELEVANT EVENT OF FORCE MAJEURE CONTINUES AND TO THE EXTENT THAT SUCH PARTY'S PERFORMANCE IS PREVENTED, HINDERED OR DELAYED. THE TIME FOR COMPLETION SHALL BE EXTENDED BY A PERIOD OF TIME EQUAL TO PERIOD OF DELAY CAUSED DUE TO SUCH FORCE MAJEURE EVENT.</p> <p>13.5 DELAY OR NON-PERFORMANCE BY EITHER PARTY HERETO CAUSED BY THE OCCURRENCE OF ANY EVENT OF FORCE MAJEURE SHALL NOT</p> <p>I) CONSTITUTE A DEFAULT OR BREACH OF THE CONTRACT.</p> <p>II) GIVE RISE TO ANY CLAIM FOR DAMAGES OR ADDITIONAL COST EXPENSE OCCASIONED THEREBY, IF AND TO THE EXTENT THAT SUCH DELAY OR NON-PERFORMANCE IS CAUSED BY THE OCCURRENCE OF AN EVENT OF FORCE MAJEURE.</p> <p>13.6 BHEL AT ITS DISCRETION MAY CONSIDER SHORT CLOSURE OF CONTRACT AFTER 1 YEAR OF IMPOSITION OF FORCE MAJEURE IN LINE WITH EXTANT GUIDELINES. IN ANY CASE, SUPPLIER/VENDOR CANNOT CONSIDER DEEMED SHORT-CLOSURE AFTER 1 YEAR OF IMPOSITION OF FORCE MAJEURE.</p>	
48.	<p>FRAUD PREVENTION POLICY : THE BIDDER ALONG WITH ITS ASSOCIATE/ COLLABORATORS/ SUB-CONTRACTORS/ SUB-VENDORS/ CONSULTANTS/ SERVICE PROVIDERS SHALL STRICTLY ADHERE TO BHEL FRAUD PREVENTION POLICY DISPLAYED ON BHEL WEBSITE WWW.BHEL.COM AND SHALL IMMEDIATELY BRING TO THE NOTICE OF BHEL MANAGEMENT ABOUT ANY FRAUD OR SUSPECTED FRAUD AS SOON AS IT COMES TO THEIR NOTICE.</p>	
49.	<p>SHORT SHIPMENTS/ WARRANTY/GUARANTEE REPLACEMENTS: IN CASE OF ANY SHORT SHIPMENT DURING INITIAL SUPPLY WHICH IS SUBSEQUENTLY DISPATCHED BY THE VENDOR OR ANY GUARANTEE /WARRANTY REPLACEMENTS SHALL BE DISPATCHED ON "FOR-BHEL STORES/DESIGNATED DESTINATION" BASIS FOR INDIGENOUS</p>	

**GENERAL COMMERCIAL TERMS & CONDITIONS OF ENQUIRY
(FOR INDIAN VENDORS)**

Amendment- 27
ANNEXURE-A

	ITEMS. TAXES, IF ANY PAID BY INDIGENOUS VENDOR FOR GUARANTEE /WARRANTEE REPLACEMENT, REPAIR ACTIVITY EXCLUDING SHORT SUPPLY SHALL BE TO VENDOR'S ACCOUNT ONLY. THE VENDOR HAS TO RAISE A CREDIT NOTE FOR SHORT SUPPLIED QUANTITY AS PER GST PROVISIONS.	
50.	E WAY BILL: THE SUPPLIER HAS TO ARRANGE FOR E WAY BILL AS APPLICABLE FOR ANY MOVEMENT OF GOODS ALONG WITH OTHER PRESCRIBED DOCUMENTS AS PER GST LAW. THE SUPPLIER HAS ALSO TO COMPLY WITH ANY AMENDMENT AS PRESCRIBED FROM TIME TO TIME UNDER E WAY BILL RULE. ANY FINANCIAL IMPLICATION ARISES ON BHEL DUE TO NONCOMPLIANCE OF E WAY BILL RULE WILL BE PASSED ON TO THE SUPPLIER.	
51.	THE BIDDER DECLARES THAT THEY WILL NOT ENTER INTO ANY ILLEGAL OR UNDISCLOSED AGREEMENT OR UNDERSTANDING, WHETHER FORMAL OR INFORMAL WITH OTHER BIDDER (S). THIS APPLIES IN PARTICULAR TO PRICES, SPECIFICATIONS, CERTIFICATIONS, SUBSIDIARY CONTRACTS, SUBMISSION OR NON- SUBMISSION OF BIDS OR ANY OTHER ACTIONS TO RESTRICT COMPETITIVENES OR TO INTRODUCE CARTELIZATION IN THE BIDDING PROCESS. IN CASE, THE BIDDER IS FOUND HAVING INDULGED IN ABOVE ACTIVITIES, SUITABLE ACTION SHALL BE TAKEN BY BHEL AS PER EXTANT POLICIES / GUIDELINES.	
52.	THE BIDDER SHALL REGISTER THEMSELVES ON GEM PORTAL AND SHALL QUOTE THEIR GEM SELLER ID IN THEIR OFFER. GEM SELLER ID IS MANDATORY FOR PLACEMENT OF PURCHASE ORDER EXCEPT IN CASES WHERE FREE ISSUE MATERIAL IS TO BE ISSUED BY BHEL .	
53.	REJECTION/REPLACEMENT: THE SELLER SHALL ARRANGE REPLACEMENT / REPAIR UNDER ITS OBLIGATION UNDER THE CONTRACT. SELLER SHALL BE GIVEN GROUND RENT FREE PERIOD OF 90 DAYS FROM THE DATE OF REJECTION TO LIFT REJECTED MATERIAL. BEYOND 90 DAYS, A GROUND RENT OF 0.25% OF VALUE OF REJECTED MATERIAL PER WEEK WILL BE LEVIED FOR A MAXIMUM PERIOD OF 4 WEEKS. BEYOND THIS PERIOD SUPPLIER FORFEITS THEIR RIGHT TO THE MATERIALS.	
54.	TREATMENT OF CASES REGARDING CONFLICT OF INTEREST: THE BIDDER NOTES THAT A CONFLICT OF INTEREST WOULD SAID TO HAVE OCCURRED IN THE TENDER PROCESS AND EXECUTION OF THE RESULTANT CONTRACT, IN CASE OF ANY OF THE FOLLOWING SITUATIONS: I) IF ITS PERSONNEL HAVE A CLOSE PERSONAL, FINANCIAL, OR BUSINESS RELATIONSHIP WITH ANY PERSONNEL OF BHEL WHO ARE DIRECTLY OR INDIRECTLY RELATED TO THE PROCUREMENT OR EXECUTION PROCESS OF THE CONTRACT, WHICH CAN AFFECT THE DECISION OF BHEL DIRECTLY OR INDIRECTLY; II) THE BIDDER (OR HIS ALLIED FIRM) PROVIDED SERVICES FOR THE NEED ASSESSMENT/ PROCUREMENT PLANNING OF THE TENDER PROCESS IN WHICH IT IS PARTICIPATING; III) PROCUREMENT OF GOODS DIRECTLY FROM THE MANUFACTURERS/ SUPPLIERS SHALL BE PREFERRED. HOWEVER, IF THE OEM/ PRINCIPAL INSISTS ON ENGAGING THE SERVICES OF AN AGENT, SUCH AGENT SHALL NOT BE ALLOWED TO REPRESENT MORE THAN ONE MANUFACTURER/ SUPPLIER IN THE SAME TENDER. MOREOVER, EITHER THE AGENT COULD BID ON BEHALF OF THE MANUFACTURER/ SUPPLIER OR THE MANUFACTURER/ SUPPLIER COULD BID DIRECTLY BUT NOT BOTH. IN CASE BIDS ARE RECEIVED FROM BOTH THE MANUFACTURER/ SUPPLIER AND THE AGENT, BID RECEIVED FROM THE AGENT SHALL BE IGNORED. HOWEVER, THIS SHALL NOT DEBAR MORE THAN ONE AUTHORISED DISTRIBUTOR (WITH/ OR WITHOUT THE OEM) FROM QUOTING EQUIPMENT MANUFACTURED BY AN ORIGINAL EQUIPMENT MANUFACTURER (OEM) IN PROCUREMENTS UNDER A PROPRIETARY ARTICLE CERTIFICATE. IV) A BIDDER PARTICIPATES IN MORE THAN ONE BID IN THIS TENDER PROCESS. PARTICIPATION IN ANY CAPACITY BY A BIDDER (INCLUDING THE PARTICIPATION OF A BIDDER AS A PARTNER/ JV MEMBER OR SUB-CONTRACTOR IN ANOTHER BID OR VICE-VERSA) IN MORE THAN ONE BID SHALL RESULT IN THE DISQUALIFICATION OF ALL BIDS IN WHICH HE IS A PARTY. HOWEVER, THIS DOES NOT LIMIT THE PARTICIPATION OF AN ENTITY AS A SUB-CONTRACTOR IN MORE THAN ONE BID IF HE IS NOT BIDDING INDEPENDENTLY IN HIS OWN NAME OR AS A MEMBER OF A JV. THE BIDDER DECLARES THAT THEY HAVE READ AND UNDERSTOOD THE ABOVE ASPECTS, AND THE BIDDER CONFIRMS THAT SUCH CONFLICT OF INTEREST DOES NOT EXIST AND UNDERTAKES THAT THEY WILL NOT ENTER INTO ANY ILLEGAL OR UNDISCLOSED AGREEMENT OR UNDERSTANDING, WHETHER FORMAL OR INFORMAL WITH OTHER BIDDER(S), IN THIS REGARD. THIS APPLIES IN PARTICULAR TO PRICES, SPECIFICATIONS, CERTIFICATIONS, SUBSIDIARY CONTRACTS, SUBMISSION OR NON-SUBMISSION OF BIDS OR ANY OTHER ACTIONS TO RESTRICT COMPETITIVENESS OR TO INTRODUCE CARTELIZATION IN THE BIDDING PROCESS. IN CASE, THE BIDDER IS FOUND HAVING INDULGED IN ABOVE ACTIVITIES, THE SAME WILL BE CONSIDERED AS A VIOLATION OF THE TENDER CONDITIONS, AND SUITABLE ACTION SHALL BE TAKEN BY BHEL AS PER EXTANT POLICIES/ GUIDELINES.	
55.	VENDOR MUST VISIT OUR WEBSITE https://herp.bhel.com REGULARLY FOR ENQUIRY/PO/CLARIFICATIONS/FOR ANY LATEST UPDATES.	
56.	MSME VENDORS CAN AVAIL BENEFITS OF PAYMENT THROUGH TREDS.	
57.	"THE OFFERS OF THE BIDDERS WHO ARE UNDER SUSPENSION AS ALSO THE OFFERS OF THE BIDDERS, WHO ENGAGE THE SERVICES OF THE FIRMS DEBARRED ACROSS BHEL, SHALL BE REJECTED. THE LIST OF FIRMS DEBARRED ACROSS BHEL IS AVAILABLE ON BHEL WEBSITE WWW.BHEL.COM. 1.0 INTEGRITY COMMITMENT, PERFORMANCE OF THE CONTRACT AND PUNITIVE ACTION THEREOF: 1.1. COMMITMENT BY BHEL: BHEL COMMITS TO TAKE ALL MEASURES NECESSARY TO PREVENT CORRUPTION IN CONNECTION WITH THE TENDER PROCESS AND EXECUTION OF THE CONTRACT. BHEL WILL DURING THE TENDER PROCESS TREAT ALL BIDDER(S) IN A TRANSPARENT AND FAIR MANNER, AND WITH EQUITY. 1.2. COMMITMENT BY BIDDER/ SUPPLIER/ CONTRACTOR: 1.2.1. THE BIDDER/ SUPPLIER/ CONTRACTOR COMMIT TO TAKE ALL MEASURES TO PREVENT CORRUPTION AND WILL NOT DIRECTLY OR INDIRECTLY INFLUENCE ANY DECISION OR BENEFIT WHICH HE IS NOT LEGALLY ENTITLED TO NOR WILL ACT OR OMIT IN ANY MANNER WHICH TANTAMOUNT TO AN OFFENCE PUNISHABLE UNDER ANY PROVISION OF THE INDIAN PENAL CODE, 1860 OR ANY OTHER LAW IN FORCE IN INDIA. 1.2.2. THE BIDDER/ SUPPLIER/ CONTRACTOR WILL, WHEN PRESENTING HIS BID, DISCLOSE ANY AND ALL PAYMENTS HE HAS MADE, AND IS COMMITTED TO OR INTENDS TO MAKE TO AGENTS, BROKERS OR ANY OTHER INTERMEDIARIES IN CONNECTION WITH THE AWARD OF THE CONTRACT AND SHALL ADHERE TO RELEVANT GUIDELINES ISSUED FROM TIME TO TIME BY GOVT. OF INDIA/ BHEL. 1.2.3. THE BIDDER/ SUPPLIER/ CONTRACTOR WILL PERFORM/ EXECUTE THE CONTRACT AS PER THE CONTRACT TERMS & CONDITIONS AND WILL NOT DEFAULT WITHOUT ANY REASONABLE CAUSE, WHICH CAUSES LOSS OF BUSINESS/ MONEY/ REPUTATION, TO BHEL. IF ANY BIDDER/ SUPPLIER/ CONTRACTOR DURING PRE-TENDERING/ TENDERING/ POST TENDERING/ AWARD/ EXECUTION/ POST-EXECUTION STAGE INDULGES IN MALPRACTICES, CHEATING, BRIBERY, FRAUD OR AND OTHER MISCONDUCT OR FORMATION OF CARTEL SO AS TO INFLUENCE THE BIDDING PROCESS OR INFLUENCE THE PRICE OR ACTS OR OMTS IN ANY MANNER WHICH TANTAMOUNT TO AN OFFENCE PUNISHABLE UNDER ANY PROVISION OF THE INDIAN PENAL CODE, 1860 OR ANY OTHER LAW IN FORCE IN INDIA, THEN, ACTION MAY BE TAKEN AGAINST SUCH BIDDER/ SUPPLIER/ CONTRACTOR AS PER EXTANT GUIDELINES OF THE COMPANY AVAILABLE ON WWW. BHEL.COM AND/OR UNDER APPLICABLE LEGAL PROVISIONS".	
58.	BID SECURITY OR EARNEST MONEY DEPOSIT (EMD): TO SAFE GUARD AGAINST A BIDDER'S WITHDRAWING OR ALTERING ITS/ HIS BID DURING THE BID VALIDITY PERIOD, BID SECURITY [ALSO KNOWN AS EARNEST MONEY DEPOSIT (EMD)] SHALL BE OBTAINED FROM THE BIDDERS ALONG WITH THEIR BIDS (EXCEPT MICRO AND SMALL ENTERPRISES (MSES) OR STARTUPS AS RECOGNIZED BY DEPARTMENT FOR PROMOTION OF INDUSTRY AND INTERNAL TRADE (DPIT)). THE AMOUNT OF EMD SHALL BE AS MENTIONED IN ENQUIRY. 1. MODES OF DEPOSIT A) THE EMD MAY BE ACCEPTED ONLY IN THE FOLLOWING FORMS AND THE SAME MUST BE SUBMITTED BEFORE TENDER OPENING: (I) ELECTRONIC FUND TRANSFER CREDITED IN BHEL ACCOUNT. (II) BANKER'S CHEQUE/ PAY ORDER/ DEMAND DRAFT, IN FAVOUR OF BHEL. (III) FIXED DEPOSIT RECEIPT (FDR).(IN THE NAME OF " BIDDER'S NAME A/C BHEL") (IV) BANK GUARANTEE FROM ANY OF THE SCHEDULED BANKS. (V) INSURANCE SURETY BONDS. B) IN CASE THE EMD IS MORE THAN RUPEES TWO LAKH AND IN CASE OF FOREIGN BIDDERS, IT MAY BE IN THE FORM OF A BANK GUARANTEE (IN EQUIVALENT FOREIGN EXCHANGE AMOUNT, IN CASE OF FOREIGN BIDDERS) ISSUED/ CONFIRMED FROM ANY OF THE SCHEDULED COMMERCIAL BANK IN INDIA IN AN ACCEPTABLE FORM. THE EMD SHALL REMAIN VALID FOR A PERIOD OF 45 (FORTY-FIVE) DAYS BEYOND THE FINAL BID VALIDITY PERIOD. 2. FORFEITURE OF EMD	

**GENERAL COMMERCIAL TERMS & CONDITIONS OF ENQUIRY
(FOR INDIAN VENDORS)**

Amendment- 27
ANNEXURE-A

	<p>I) A BIDDER'S EMD WILL BE FORFEITED IF THE BIDDER WITHDRAWS OR AMENDS ITS/HIS TENDER OR IMPAIRS OR DEROGATES FROM THE TENDER IN ANY RESPECT WITHIN THE PERIOD OF VALIDITY OF THE TENDER OR IF THE SUCCESSFUL BIDDER FAILS TO FURNISH THE REQUIRED PERFORMANCE SECURITY WITHIN THE SPECIFIED PERIOD MENTIONED IN THE TENDER.</p> <p>(II) EMD BY THE TENDERER SHALL BE WITHHELD IN CASE ANY ACTION ON THE BIDDER IS ENVISAGED UNDER THE PROVISIONS OF EXTANT "GUIDELINES ON SUSPENSION OF BUSINESS DEALINGS WITH SUPPLIERS/ CONTRACTORS" AND FORFEITED/ RELEASED BASED ON THE ACTION AS DETERMINED UNDER THESE GUIDELINES.</p> <p>3. RETURN OF EMD</p> <p>(I) BID SECURITIES OF THE UNSUCCESSFUL BIDDERS SHALL BE RETURNED TO BIDDER AT THE EARLIEST AFTER EXPIRY OF THE FINAL BID VALIDITY PERIOD AND LATEST BY THE 30TH DAY AFTER THE AWARD OF THE CONTRACT. HOWEVER, IN CASE OF TWO PACKET OR TWO STAGE BIDDING, BID SECURITIES OF UNSUCCESSFUL BIDDERS DURING FIRST STAGE I.E. TECHNICAL EVALUATION ETC. SHALL BE RETURNED WITHIN 30 DAYS OF DECLARATION OF RESULT OF FIRST STAGE I.E. TECHNICAL EVALUATION ETC.</p> <p>(II) BID SECURITY SHALL BE REFUNDED TO THE SUCCESSFUL BIDDER ON CONCLUSION OF THE ORDER/ RECEIPT OF A PERFORMANCE SECURITY (IF CALLED IN THE TENDER).</p> <p>(III) EMD SHALL NOT CARRY ANY INTEREST.</p>	
59.	<p>PERFORMANCE SECURITY (PS): TO ENSURE DUE PERFORMANCE OF THE CONTRACT, PERFORMANCE BANK GUARANTEE (PBG) OR SECURITY DEPOSIT (SD), HEREAFTER REFERRED AS PERFORMANCE SECURITY SHALL BE OBTAINED FROM THE SUCCESSFUL BIDDER AWARDED THE CONTRACT. THE PERFORMANCE SECURITY OF REQUIRED AMOUNT IS TO BE SUBMITTED BY THE DATE SPECIFIED IN THE PO/CONTRACT.</p> <p>1. MODES OF DEPOSIT:</p> <p>A) PERFORMANCE SECURITY MAY BE FURNISHED IN THE FOLLOWING FORMS:</p> <p>(I) LOCAL CHEQUES OF SCHEDULED BANKS (SUBJECT TO REALIZATION)/ PAY ORDER/ DEMAND DRAFT/ ELECTRONIC FUND TRANSFER IN FAVOUR OF BHEL.</p> <p>(II) BANK GUARANTEE FROM SCHEDULED BANKS / PUBLIC FINANCIAL INSTITUTIONS AS DEFINED IN THE COMPANIES ACT. THE BANK GUARANTEE FORMAT SHOULD HAVE THE APPROVAL OF BHEL.</p> <p>(III) FIXED DEPOSIT RECEIPT ISSUED BY SCHEDULED BANKS / PUBLIC FINANCIAL INSTITUTIONS AS DEFINED IN THE COMPANIES ACT (FDR SHOULD BE IN THE NAME OF THE CONTRACTOR, A/C BHEL).</p> <p>(IV) SECURITIES AVAILABLE FROM INDIAN POST OFFICES SUCH AS NATIONAL SAVINGS CERTIFICATES, KISAN VIKAS PATRAS ETC. (HELD IN THE NAME OF CONTRACTOR FURNISHING THE SECURITY AND DULY ENDORSED/ HYPOTHECATED/ PLEDGED, AS APPLICABLE, IN FAVOUR OF BHEL).</p> <p>(V) INSURANCE SURETY BOND.</p> <p>(NOTE: BHEL WILL NOT BE LIABLE OR RESPONSIBLE IN ANY MANNER FOR THE COLLECTION OF INTEREST OR RENEWAL OF THE DOCUMENTS OR IN ANY OTHER MATTER CONNECTED THEREWITH)</p> <p>B) IN CASE OF GTE TENDERS, THE PERFORMANCE SECURITY SHALL BE IN THE SAME CURRENCY AS THE CONTRACT AND MUST CONFORM TO UNIFORM RULES FOR DEMAND GUARANTEES (URDG 758) - AN INTERNATIONAL CONVENTION REGULATING INTERNATIONAL SECURITIES.</p> <p>(C) PERFORMANCE SECURITY IS TO BE FURNISHED WITHIN A SPECIFIED DATE (GENERALLY 14(FOURTEEN) DAYS AFTER NOTIFICATION OF THE AWARD) AND IT SHOULD REMAIN VALID FOR A PERIOD OF 60 (SIXTY) DAYS BEYOND THE DATE OF COMPLETION OF ALL CONTRACTUAL OBLIGATIONS OF THE SUPPLIER, INCLUDING WARRANTY OBLIGATIONS.</p> <p>"BIDDER AGREES TO SUBMIT PERFORMANCE SECURITY REQUIRED FOR EXECUTION OF THE CONTRACT WITHIN THE TIME PERIOD MENTIONED. IN CASE OF DELAY IN SUBMISSION OF PERFORMANCE SECURITY, ENHANCED PERFORMANCE SECURITY WHICH WOULD INCLUDE INTEREST (REPO RATE+4%) FOR THE DELAYED PERIOD, SHALL BE SUBMITTED BY THE BIDDER. FURTHER, IF PERFORMANCE SECURITY IS NOT SUBMITTED TILL SUCH TIME THE FIRST BILL BECOMES DUE, THE AMOUNT OF PERFORMANCE SECURITY DUE SHALL BE RECOVERED AS PER TERMS DEFINED IN NIT CONTRACT, FROM THE BILLS ALONG WITH DUE INTEREST"</p> <p>2. FORFEITURE OF PERFORMANCE SECURITY: THE PERFORMANCE SECURITY WILL BE FORFEITED AND CREDITED TO BHEL'S ACCOUNT IN THE EVENT OF A BREACH OF CONTRACT BY THE SUPPLIER.</p> <p>3. RETURN OF PERFORMANCE SECURITY (PS): PS SHALL BE REFUNDED TO THE BIDDER WITHOUT INTEREST, AFTER HE DULY PERFORMS AND COMPLETES THE CONTRACT IN ALL RESPECTS BUT NOT LATER THAN 60(SIXTY) DAYS OF COMPLETION OF ALL SUCH OBLIGATIONS INCLUDING THE WARRANTY UNDER THE CONTRACT.</p> <p>4. THE PERFORMANCE SECURITY SHALL NOT CARRY ANY INTEREST.</p>	
60.	<p>BREACH OF CONTRACT, REMEDIES AND TERMINATION:</p> <p>16.1 BREACH OF CONTRACT:</p> <p>THE FOLLOWING SHALL AMOUNT TO BREACH OF CONTRACT:</p> <p>I. NON-SUPPLY OF MATERIAL/ NON-COMPLETION OF WORK BY THE SUPPLIER/VENDOR WITHIN SCHEDULED DELIVERY/ COMPLETION PERIOD AS PER CONTRACT OR AS EXTENDED FROM TIME TO TIME.</p> <p>II. THE SUPPLIER/VENDOR FAILS TO PERFORM AS PER THE ACTIVITY SCHEDULE AND THERE ARE SUFFICIENT REASONS EVEN BEFORE EXPIRY OF THE DELIVERY/ COMPLETION PERIOD TO JUSTIFY THAT SUPPLIES SHALL BE INORDINATELY DELAYED BEYOND CONTRACTUAL DELIVERY/ COMPLETION PERIOD.</p> <p>III. THE SUPPLIER/VENDOR DELIVERS EQUIPMENT/ MATERIAL NOT OF THE CONTRACTED QUALITY.</p> <p>IV. THE SUPPLIER/VENDOR FAILS TO REPLACE THE DEFECTIVE EQUIPMENT/ MATERIAL/ COMPONENT AS PER GUARANTEE CLAUSE.</p> <p>V. WITHDRAWAL FROM OR ABANDONMENT OF THE WORK BY THE SUPPLIER/VENDOR BEFORE COMPLETION AS PER CONTRACT.</p> <p>VI. ASSIGNMENT, TRANSFER, SUBLLETING OF CONTRACT BY THE SUPPLIER/VENDOR WITHOUT BHEL'S WRITTEN PERMISSION RESULTING IN TERMINATION OF CONTRACT OR PART THEREOF BY BHEL.</p> <p>VII. NON-COMPLIANCE TO ANY CONTRACTUAL CONDITION OR ANY OTHER DEFAULT ATTRIBUTABLE TO SUPPLIER/VENDOR.</p> <p>VIII. ANY OTHER REASON(S) ATTRIBUTABLE TO VENDOR TOWARDS FAILURE OF PERFORMANCE OF CONTRACT. IN CASE OF BREACH OF CONTRACT, BHEL SHALL HAVE THE RIGHT TO TERMINATE THE PURCHASE ORDER/ CONTRACT EITHER IN WHOLE OR IN PART THEREOF WITHOUT ANY COMPENSATION TO THE SUPPLIER/VENDOR.</p> <p>IX. ANY OF THE DECLARATIONS FURNISHED BY THE CONTRACTOR AT THE TIME OF BIDDING AND/ OR ENTERING INTO THE CONTRACT FOR SUPPLY ARE FOUND UNTRUTHFUL AND SUCH DECLARATIONS WERE OF A NATURE THAT COULD HAVE RESULTED IN NON-AWARD OF CONTRACT TO THE CONTRACTOR OR COULD EXPOSE BHEL AND/ OR OWNER TO ADVERSE CONSEQUENCES, FINANCIAL OR OTHERWISE.</p> <p>X. SUPPLIER/VENDOR IS CONVICTED OF ANY OFFENCE INVOLVING CORRUPT BUSINESS PRACTICES, ANTI-NATIONAL ACTIVITIES OR ANY SUCH OFFENCE THAT COMPROMISES THE BUSINESS ETHICS OF BHEL, IN VIOLATION OF THE INTEGRITY PACT ENTERED INTO WITH BHEL HAS THE POTENTIAL TO HARM THE OVERALL BUSINESS OF BHEL/ OWNER</p> <p>NOTE- ONCE BHEL CONSIDERS THAT A BREACH OF CONTRACT HAS OCCURRED ON THE PART OF SUPPLIER/VENDOR, BHEL SHALL NOTIFY THE SUPPLIER/VENDOR BY WAY OF NOTICE IN THIS REGARD. CONTRACTOR SHALL BE GIVEN AN OPPORTUNITY TO RECTIFY THE REASONS CAUSING THE BREACH OF CONTRACT WITHIN A PERIOD OF 14 DAYS.</p> <p>IN CASE THE CONTRACTOR FAILS TO REMEDY THE BREACH, AS MENTIONED IN THE NOTICE, TO THE SATISFACTION OF BHEL, BHEL SHALL HAVE THE RIGHT TO TAKE RECOURSE TO ANY OF THE REMEDIAL ACTIONS AVAILABLE TO IT UNDER THE RELEVANT PROVISIONS OF CONTRACT</p> <p>16.2 REMEDIES IN CASE OF BREACH OF CONTRACT.</p> <p>I. WHEREIN THE PERIOD AS STIPULATED IN THE NOTICE ISSUED UNDER CLAUSE 14.1 HAS EXPIRED AND SUPPLIER/VENDOR HAS FAILED TO REMEDY THE BREACH, BHEL WILL HAVE THE RIGHT TO TERMINATE THE CONTRACT ON THE GROUND OF "BREACH OF CONTRACT" WITHOUT ANY FURTHER NOTICE TO CONTRACTOR.</p> <p>II. UPON TERMINATION OF CONTRACT, BHEL SHALL BE ENTITLED TO RECOVER AN AMOUNT EQUIVALENT TO 10% OF THE CONTRACT VALUE FOR THE DAMAGES ON ACCOUNT OF BREACH OF CONTRACT COMMITTED BY THE SUPPLIER/VENDOR. THIS AMOUNT SHALL BE RECOVERED BY WAY OF ENCASHING THE SECURITY INSTRUMENTS LIKE PERFORMANCE BANK GUARANTEE ETC AVAILABLE WITH BHEL AGAINST THE SAID CONTRACT. IN CASE THE VALUE OF THE SECURITY INSTRUMENTS AVAILABLE IS LESS THAN 10% OF THE CONTRACT VALUE, THE BALANCE AMOUNT SHALL BE RECOVERED FROM OTHER FINANCIAL REMEDIES (I.E. AVAILABLE BILLS OF THE SUPPLIER/VENDOR, RETENTION AMOUNT, FROM THE MONEY DUE TO THE SUPPLIER/VENDOR ETC. WITH BHEL) OR THE OTHER LEGAL REMEDIES SHALL BE PURSUED</p>	

**GENERAL COMMERCIAL TERMS & CONDITIONS OF ENQUIRY
(FOR INDIAN VENDORS)**

Amendment- 27
ANNEXURE-A

	<p>III. WHEREVER THE VALUE OF SECURITY INSTRUMENTS LIKE PERFORMANCE BANK GUARANTEE AVAILABLE WITH BHEL AGAINST THE SAID CONTRACT IS 10% OF THE CONTRACT VALUE OR MORE, SUCH SECURITY INSTRUMENTS TO THE EXTENT OF 10% CONTRACT VALUE WILL BE ENCASHED. IN CASE NO SECURITY INSTRUMENTS ARE AVAILABLE OR THE VALUE OF THE SECURITY INSTRUMENTS AVAILABLE IS LESS THAN 10% OF THE CONTRACT VALUE, THE 10% OF THE CONTRACT VALUE OR THE BALANCE AMOUNT, AS THE CASE MAY BE, WILL BE RECOVERED IN ALL OR ANY OF THE FOLLOWING MANNERS:</p> <p>IV. IN CASE THE AMOUNT RECOVERED UNDER SUB CLAUSE (A) ABOVE IS NOT SUFFICIENT TO FULFIL THE AMOUNT RECOVERABLE THEN; A DEMAND NOTICE TO DEPOSIT THE BALANCE AMOUNT WITHIN 30 DAYS SHALL BE ISSUED TO SUPPLIER/VENDOR.</p> <p>V. IF SUPPLIER/VENDOR FAILS TO DEPOSIT THE BALANCE AMOUNT WITHIN THE PERIOD AS PRESCRIBED IN DEMAND NOTICE, FOLLOWING ACTION SHALL BE TAKEN FOR RECOVERY OF THE BALANCE AMOUNT:</p> <p>A. FROM DUES AVAILABLE IN THE FORM OF BILLS PAYABLE TO DEFAULTED SUPPLIER/VENDOR AGAINST THE SAME CONTRACT.</p> <p>B. IF IT IS NOT POSSIBLE TO RECOVER THE DUES AVAILABLE FROM THE SAME CONTRACT OR DUES ARE INSUFFICIENT TO MEET THE RECOVERABLE AMOUNT, BALANCE AMOUNT SHALL BE RECOVERED FROM ANY MONEY(S) PAYABLE TO SUPPLIER/VENDOR UNDER ANY CONTRACT WITH OTHER UNITS OF BHEL INCLUDING RECOVERY FROM SECURITY DEPOSITS OR ANY OTHER DEPOSIT AVAILABLE IN THE FORM OF SECURITY INSTRUMENTS OF ANY KIND AGAINST SECURITY DEPOSIT OR EMD.</p> <p>C. IN-CASE RECOVERIES ARE NOT POSSIBLE WITH ANY OF THE ABOVE AVAILABLE OPTIONS, LEGAL ACTION SHALL BE INITIATED FOR RECOVERY AGAINST DEFAULTED SUPPLIER/VENDOR.</p> <p>VI. IT IS AN AGREED TERM OF CONTRACT THAT THIS AMOUNT SHALL BE A GENUINE PRE-ESTIMATE OF DAMAGES THAT BHEL WOULD INCUR IN COMPLETION OF BALANCE CONTRACTUAL OBLIGATION OF THE CONTRACT THROUGH ANY OTHER AGENCY AND BHEL WILL NOT BE REQUIRED TO FURNISH ANY OTHER EVIDENCE TO THE SUPPLIER/VENDOR FOR THE PURPOSE OF ESTIMATION OF DAMAGES.</p> <p>VII. IN ADDITION TO THE ABOVE, IMPOSITION OF LIQUIDATED DAMAGES, DEBARMENT, TERMINATION, DE-SCOPING, SHORT-CLOSURE, ETC., SHALL BE APPLIED AS PER PROVISIONS OF THE CONTRACT.</p> <p>NOTE: 1) THE DEFAULTING SUPPLIER/VENDOR SHALL NOT BE ELIGIBLE FOR PARTICIPATION IN ANY OF THE FUTURE ENQUIRIES FLOATED BY BHEL TO COMPLETE THE BALANCE WORK. THE DEFAULTING CONTRACTOR SHALL MEAN AND INCLUDE:</p> <p>(A) IN CASE DEFAULTED SUPPLIER/VENDOR IS THE SOLE PROPRIETORSHIP FIRM, ANY SOLE PROPRIETORSHIP FIRM OWNED BY SAME SOLE PROPRIETOR</p> <p>(B) IN CASE DEFAULTED SUPPLIER/VENDOR IS THE PARTNERSHIP FIRM, ANY FIRM COMPRISING OF SAME PARTNERS/ SOME OF THE SAME PARTNERS ; OR SOLE PROPRIETORSHIP FIRM OWNED BY ANY PARTNER(S) AS A SOLE PROPRIETOR.</p>	
61.	<p>NO INTEREST PAYABLE TO CONTRACTOR: NOTWITHSTANDING ANYTHING TO THE CONTRARY CONTAINED IN ANY OTHER DOCUMENT COMPRISING IN THE CONTRACT, NO INTEREST SHALL BE PAYABLE BY BHEL TO CONTRACTOR ON ANY MONEYS OR BALANCES INCLUDING BUT NOT LIMITED TO THE SECURITY DEPOSIT, EMD, RETENTION MONEY, RA BILLS OR THE FINAL BILL, OR ANY AMOUNT WITHHELD AND/OR APPROPRIATED BY BHEL ETC., WHICH BECOMES OR AS THE CASE MAY BE, IS ADJUDGED TO BE DUE FROM BHEL TO CONTRACTOR WHETHER UNDER THE CONTRACT OR OTHERWISE</p>	
62.	<p>OVER RUN CHARGES: NO OVERRUN CHARGES ARE APPLICABLE</p>	
63.	<p>ORDER OF PRECEDENCE: THE PURCHASE ORDER ALONG WITH ITS ANNEXURES THE NIT, ITS AMENDMENTS /CORRIGENDUM'S SHALL ALL TOGETHER CONSTITUTE THE ENTIRE CONTRACT BETWEEN THE PARTIES AND SHALL BE COMPLEMENTARY TO ONE ANOTHER. IN CASE OF ANY CONTRADICTION, THE ORDER OF PRECEDENCE SHALL BE AS BELOW:</p> <p>a. PURCHASE ORDER ALONG WITH ITS ANNEXURES b. AMENDMENTS/CLARIFICATIONS/CORRIGENDA/ERRATA ETC. ISSUED IN RESPECT OF THE TENDER DOCUMENTS BY BHEL. c. NIT</p>	
64.	<p>OTHER POINTS: YOU SHALL HAVE TO OBSERVE ALL WORK QUALITY, SAFETY REGULATIONS, GENERAL TECHNICAL GUIDE LINES AS STIPULATED IN RELEVANT CLAUSES TENDER SPECIFICATION. YOU SHALL SUBMIT PROGRESS REPORTS TO BHEL AS PER TENDER CONDITIONS, REVIEW THE PROGRAMME FROM TIME TO TIME AND TAKE SUITABLE STEPS TO MEET OVERALL PROJECT SCHEDULE, IN CONSULTATION WITH BHEL/ BIFCL ENGINEER</p> <p>VENDOR SHOULD FOLLOW THE AGREED TENDER TERM (CL. NO. 29.0 OF GTC) STRICTLY: -- "THE OFFERS OF THE BIDDERS WHO ARE ON THE BANNED LIST AS ALSO THE OFFER OF THE BIDDERS, WHO ENGAGE THE SERVICES OF THE BANNED FIRMS, SHALL BE REJECTED. THE LIST OF BANNED FIRMS IS AVAILABLE ON BHEL WEB SITE WWW.BHEL.COM)".</p> <p>ALL OTHER TERMS & CONDITIONS NOT COVERED HERE SHALL BE AS PER THOSE SPECIFIED IN THE TENDER DOCUMENT (NIT) ALONG WITH TCNS INCLUDING TECHNICAL SPECIFICATION, SPECIFIC CONDITIONS OF CONTRACT & GENERAL CONDITIONS OF CONTRACT.</p> <p>YOU ARE REQUESTED TO SEND US THE ACKNOWLEDGEMENT AS PER SPECIFIED FORMAT AND CONVEY YOUR UNQUALIFIED ACCEPTANCE TO THIS PURCHASE ORDER AS PER ENCLOSED ANNEXURE-X WITHIN 7 (SEVEN) DAYS ELSE IT WILL BE DEEMED ACCEPTED.</p>	
65.	<p>FOR SUPPLY ORDERS PLACED ON INDIAN SUPPLIERS:</p> <p>IRRESPECTIVE OF THE VALUE OF THE INVOICE AMOUNT, THE BIDDER / VENDOR SHOULD NECESSARILY UPLOAD THE DESPATCH & INVOICE DETAILS ON BHEL SUVIDHA PORTAL AT HTTPS://SUVIDHA.BHEL.IN/SUVIDHA/, PRIOR TO DESPATCH. ALL DOCUMENTS AS PER PO CHECKLIST , ALONG WITH ADDITIONAL DOCUMENTS (IF ANY), MUST BE UPLOADED ON THE PORTAL. IT IS MANDATORY THAT TAX INVOICES WITH A NET AMOUNT (INCLUDING TAXES) EXCEEDING RS FIVE LAKHS UPLOADED ON THE PORTAL ARE DIGITALLY SIGNED USING A CLASS 3 DIGITAL SIGNATURE CERTIFICATE (DSC) ISSUED BY A LICENSED CERTIFYING AUTHORITY. SUBMISSION OF INVOICE DOCUMENT IN HARD COPY IS ALLOWED FOR INVOICES WITH A NET AMOUNT (INCLUDING TAXES) EQUAL TO AND UPTO RS FIVE LAKHS , IN CASE THEY WERE NOT DIGITALLY SIGNED AND UPLOADED ON THE PORTAL.</p> <p>THE MATERIAL WILL NOT BE ACCEPTED INSIDE BHEL IN ABSENCE OF THE ABOVE</p>	

**GENERAL COMMERCIAL TERMS & CONDITIONS OF ENQUIRY
(FOR INDIAN VENDORS)**

Amendment- 27
ANNEXURE-A

66.	<p>GRIEVANCE REDRESSAL MECHANISM:</p> <p>TO PROMOTE TRANSPARENCY AND ENSURE FAIR TREATMENT OF ALL BIDDERS, A STRUCTURED GRIEVANCE REDRESSAL MECHANISM IS IN PLACE TO ADDRESS ANY CONCERNS OR ISSUES ARISING DURING THE TENDERING PROCESS OR IN SUBSEQUENT BUSINESS DEALINGS WITH THE COMPANY.</p> <p>SUPPLIERS/CONTRACTORS ARE REQUESTED TO FOLLOW THE BELOW ESCALATION PROCESS FOR GRIEVANCE RESOLUTION:</p> <ol style="list-style-type: none">FIRST LEVEL: ANY GRIEVANCE SHOULD INITIALLY BE ADDRESSED TO THE DESIGNATED DEALING OFFICER, WHOSE CONTACT DETAILS ARE PROVIDED IN THE NOTICE INVITING TENDER (NIT)/CONTRACT. <p>SECOND LEVEL: IF THE ISSUE REMAINS UNRESOLVED, IT MAY BE ESCALATED BY LODGING A FORMAL GRIEVANCE THROUGH THE SUVIDHA PORTAL: HTTPS://SUVIDHA.BHEL.IN/SUVIDHA/. RESPONSES WILL BE PROVIDED IN ACCORDANCE WITH THE DEFINED ESCALATION MATRIX</p>	
-----	--	--

NOTE:

- PLEASE FILL IN THIS FORMAT AND SEND COMPULSORILY ALONG WITH QUOTATION WITH VENDOR'S SEAL, SIGNATURE AND DATE.

SIGNATURE ALONG WITH SEAL AND DATE:

**Umesh Kumar Gupta
DGM(Pur.)**

**Ashok Kr. Srivastava
DGM(Fin)**

On Bidder's office letter pad

Make in India (Model Certificate) Annexure-I

Self-Declaration

Enquiry No.	
Enquiry Date	

In line with Government public procurement order Number P-45021/2/2017-B.E-II dated 15.06.2017, and further modified order dt. 28.05.2018, 29.05-2019, 04.06.2020 and 19.07.2024.

I / We hereby declare that I / We are a "Local Supplier" meeting the requirement of minimum local content (.....%) defined in the above government notification for the goods against above mentioned enquiry Number.

Details of location at which local value addition will be made is as follows:

Door No.	
Street / Address 1	
Street / Address 2	
District	
State	
Country	
PIN Code	

We also understand that the false declarations will be considered as breach of Integrity and liable for action.

For Company Name:

Seal:

Signature:

Date:

Place :

(Please fill all Yellow color field)

Annexure – MSEs 2012 Rev 01

OWNERSHIP STATUS (SC/ ST OR WOMEN-OWNED OR OTHERS) UNDER MSE
(Mandatory for all Non-GeM tenders and custom bids on GeM)

In order to avail benefits of MSE under various categories, all Bidders falling under MSE category shall furnish the following details & submit documentary evidence/ Govt. Certificate etc. in support of the same along with their techno-commercial offer.

Type under MSE	SC/ST Owned	Women Owned	Others (excluding SC/ST & Women Owned)
Micro			
Small			

(Bidder details with Sign and date)

Note: In case party is falling under any of the above category, they shall mention **YES** in the against the box.

DRG NO. 19-2.0N.9RD
495Z0-290-19-2.0N.9RD

12.5/

THE INFORMATION ON THIS DOCUMENT IS THE PROPERTY OF BHARAT HEAVY ELECTRICALS LTD. IT MUST NOT BE USED DIRECTLY OR INDIRECTLY IN ANY WAY DETRIMENTAL TO THE INTEREST OF THE COMPANY.

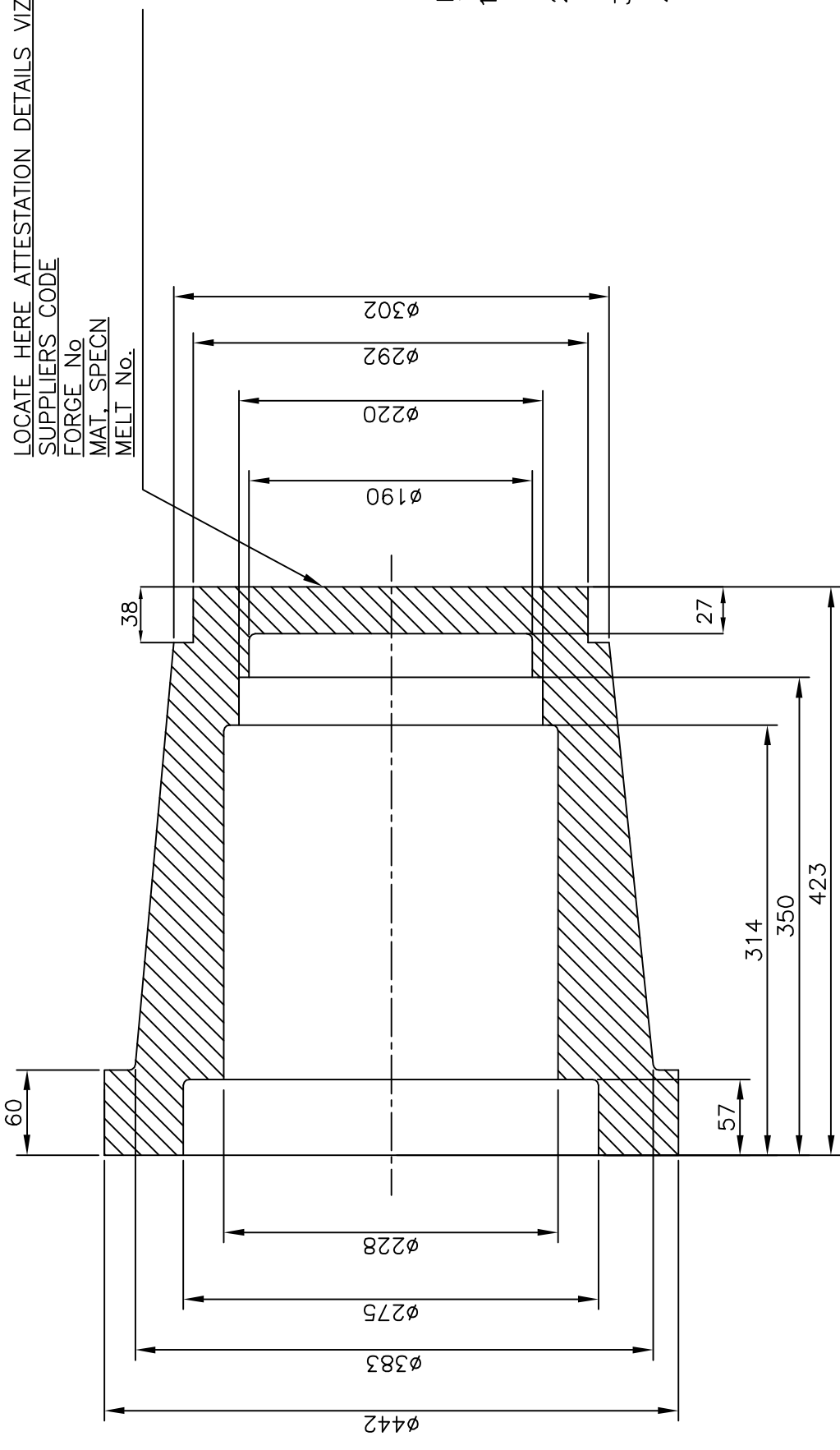

NOTES:-

1. FORGING TO BE ROUGH MACHINED TO DIMENSIONS INDICATED IN DRG
2. ULTRASONIC TEST TO BE CARRIED OUT AS PER AA0850118 CAT-3
3. TOLERANCE ON DIAMETERS AND LENGTH WILL BE ± 1 mm.
4. CORNER CHAMFER 2 mm AND FILLET RADIUS R6 TO BE MAINTAINED WHEREVER NOT MENTIONED

FORGING (R/Mcd)				BA9413221022	187.5
DESCRIPTION	DRAWING NO.	VAR. NO.	RAW MATERIAL SIZE OR CASTING DRG.NO. OR FORGING DRG.NO.	MATERIAL CODE	NET WT. GROSS WT.
				AA19332	QUANTITY

THE FOLLOWING CONDITIONS APPLY EXCEPT OTHERWISE STATED...

1. REF.TO HY0230261 FOR UNSPECIFIED TOLERANCES.
2. CHAMFER M/CD SHARP EDGES 1.2 TO 1.0 AT 45°.
3. INTERNAL M/CD CORNER RADII 1 TO 0.7.
4. THE SURFACE ROUGHNESS WHEREVER NOT SHOWN SHALL BE TAKEN FROM THE SURFACE ROUGHNESS SHOWN OUT SIDE BACK SLASHES GIVEN AT THE TOP MOST RIGHT CORNER OF THE DRG.

TYPE OF PRODUCT OR NAME OF CUSTOMER/PROJECT		MATERIAL ATTEST 62" BOWL MILL			
	DRN.	UC/ACAD10	NAME	SIGN.	DATE
	CHD.	N.D.SAMUEL	BHARAT HEAVY ELECTRICALS LTD.		29.11.95
	APPD.	G.KISHTAIAH	HYDERABAD		29.11.95
DEPT. PULVE.ENG	SCALE	WEIGHT (KG)	REF. TO ASSY DRG.	ITEM NO.	NO.OF ITEMS
CODE 446	N.T.S	187.5	36036000110		
TITLE		DRAWING NO.			
LOWER JOURNAL HOUSING (ROUGH M/CD FORGING)		3-61-062-02364			
		SHEET NO. 01	NO OF SHEETS 01		REV. 02

REV. 02	DATE 11.8.11	ALTERED PKP CHD. CKP	APPD. V. KUMAR	REV. 01	DATE 20.6.09	ALTERED PKP CHD. CKP	APPD. V.KR.
ZONE	STEP OF DIA 220 ADDED DIM. 57 WAS 50 DIM. 60 WAS 55 DIA 228 WAS 225 DIM. 27 WAS 32			ZONE	STEP OF DIA 292 ADDED		

THE INFORMATION ON THIS DOCUMENT IS THE PROPERTY OF BHARAT HEAVY ELECTRICALS LIMITED. IT MUST NOT BE USED DIRECTLY OR INDIRECTLY IN ANY WAY DETRIMENTAL TO THE INTEREST OF THE COMPANY.

REV. 01	DATE 7/6/86	ALTERED <i>St. Nagaraj</i>	REV.	DATE	ALTERED	ADDITIONAL INFORMATION
		CHECKED <i>C. C. Reddy</i>			CHECKED	STATUS OF DRAWING
APPROVED <i>(Signature)</i>			Ultrasonic level range to cut 2 from cat 4			DISTRIBUTION OF PRINTS
MAT. CODE INDICATED						
MAT. SPECN. AA 19332 WAS						
AISI C-1035						

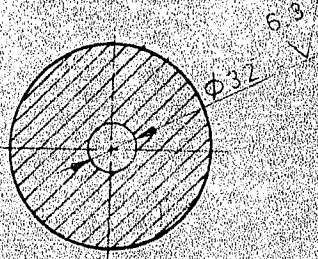
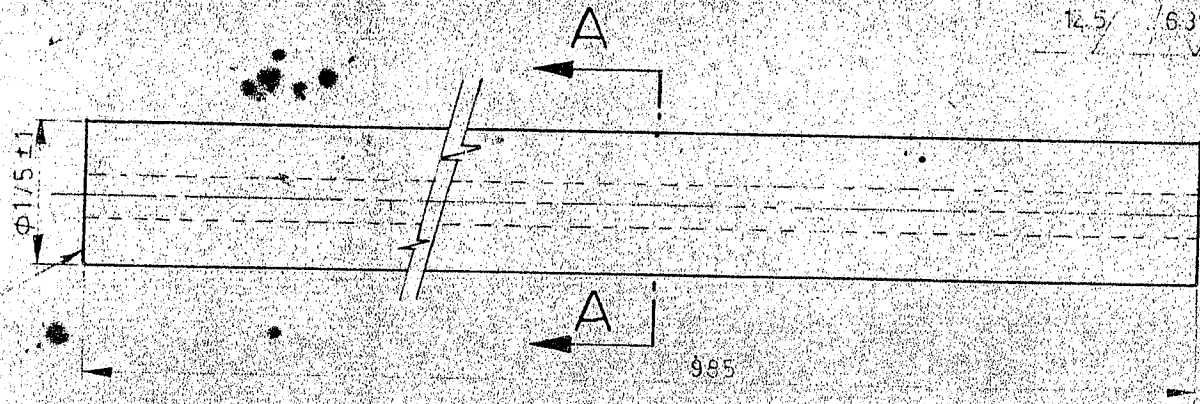

SECTION-A A

NOTE —

- 1 FORGING TO BE ROUGH MACHINED TO DIMENSIONS INDICATED IN DRAWING.
- 2 BORE TO BE MACHINED PRECISELY.
- 3 HOLE $\phi 32$ TO BE CONCENTRIC WITHIN 0.5 mm.
- 4 ULTRASONIC TEST TO BE CARRIED OUT AS PER SPECN. AA 085 01 18 CAT ~~X~~ 2
- 5 FORGINGS SHOULD BE AS PER SPECN. AA 19332.

LOCATE HERE ATTESTATION DETAILS
 SUPPLIER CODE VIZ.
 MELT. NO.
 MAT. SPECN.
 FORGE NO.

HY-62 F

MATERIAL ATTEST. 62" BOWL MILL

65	75	25	27	29	58	59	34	45	55	56	57	58	65
REMARKS	ITEM NO.	DESCRIPTION			STD.	46	MATL. SPECN.	54	A/C	UNIT	57	66	QTY.
CARD TYPE - 3		28	28		CARD TYPE - 1		28	CARD TYPE - 2					



BHARAT HEAVY ELECTRICALS LTD.
HYDERABAD

DRN.	NAME	SIGN.	DATE
	V. N. RAO.		13 4 81
CHD.	C. C. REDDY.		
APPD.			

DEPT. B M	GRADE OF TOL. DIM. C/M/F	SCALE N T S	WEIGHT (KG) 180.00	REF. TO OLD DRG. 40-F-002-086.	ITEM NO. 75 77	NO. OF ITEMS
-----------	--------------------------	-------------	--------------------	--------------------------------	----------------	--------------

TITLE: JOURNAL SHAFT (ROUGH MACHINED)

DRAWING NO. 4-60-360-90009	REV. 01
SHEET NO. 1	NO. OF SHEETS 102

REV.	DATE	ALTERED	NARAYANA	REV.	DATE	ALTERED		REV.	DATE	ALTERED	
01	14.11.03	CHECKED	N.D.S			CHECKED				CHECKED	
		APPROVED	S.GADGA			APPROVED				APPROVED	

DRAWING DRAWN ON AUTOCAD

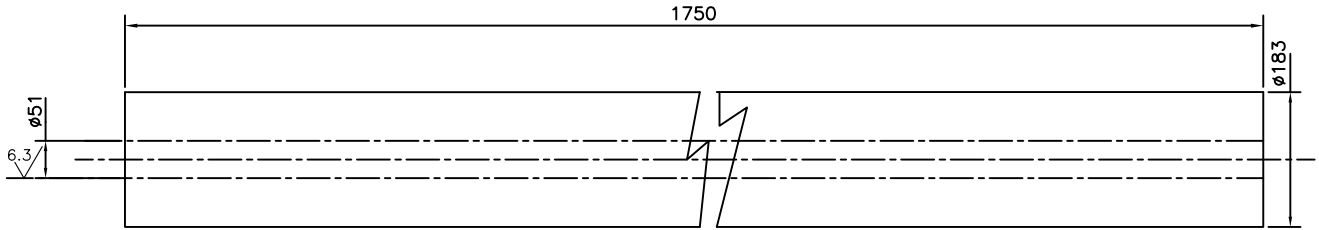
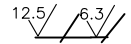

NOTE:-

- 1)HOLE $\phi 51$ SHOULD BE CONCENTRIC WITH CENTRE LINE WITHIN ± 1 MM
- 2)ULTRASONIC TEST TO BE AS PER AA085118 CAT-3
- 3)FORGING TO BE ROUGH MACHINED WITH A TOLERANCE OF ± 1 MM ON DIA&LENGTH
- 4)FOR FINISH MACHINING REFER DRG.NO.2-61-088-02147

GENERAL DIMENSIONS,LIMITS,FITS &TOLERANCE AS PER PS HY 0230261

FORGING			BA9413253315	337.0	
			AA19332	1	
DESCRIPTION & DRG.NO.	VAR NO.	RAW MATERIAL SIZE OR CASTING DRG.NO. OR FORGING DRG.NO.	MATL. CODE	NET.WT.	GROSS WT
			MATL. SPECN.	QTY.	

TYPE OF PRODUCT OR NAME OF CUSTOMER/PROJECT

883 XRP BOWL MILL

REF. TO HY0230261 FOR UNSPECIFIED TOLERANCES.	BHARAT HEAVY ELECTRICALS LTD. HYDERABAD	DRN.	NARAYANA	SIGN		DATE	14.11.03	NO.OF VAR.
		CKD.	N.D.S			14.11.03		
		APPD.	S.GADGA			14.11.03		
DEPT. PULV. ENGG		SCALE	WEIGHT(K.G.)	REF.TO ASSY.DRG.	ITEM NO.	NO.OF ITEM		
CODE 446		1:10	337	2.61.088.02147	01	01		
TITLE TRUNION SHAFT (ROUGH MACHINED)				DRAWING NO. 4-61-088-02245			REV. 01	
				SHT.NO. 1	NO.OF SHT. 1			

INVENTORY NO. SIGN. & DATE REF. DRG. NO. COMPUTER NO. THE INFORMATION ON THIS DOCUMENT IS THE PROPERTY OF BHARAT HEAVY ELECTRICALS LIMITED. IT MUST NOT BE USED DIRECTLY OR INDIRECTLY IN ANY WAY DETRIMENTAL TO THE INTEREST OF THE COMPANY. 46102245.DWG

INVENTORY NO. SIGN. & DATE REF. DRG. NO. COMPUTER NO. THE INFORMATION ON THIS DOCUMENT IS THE PROPERTY OF BHARAT HEAVY ELECTRICALS LIMITED. IT MUST NOT BE USED DIRECTLY OR INDIRECTLY IN ANY WAY DETRIMENTAL TO THE INTEREST OF THE COMPANY.

REV. DATE	ALTERED	SRINU	REV. DATE	ALTERED	REV. DATE	ALTERED
04 12.7.06	CHECKED	AMAN		CHECKED		CHECKED
	APPROVED	S.G		APPROVED		APPROVED

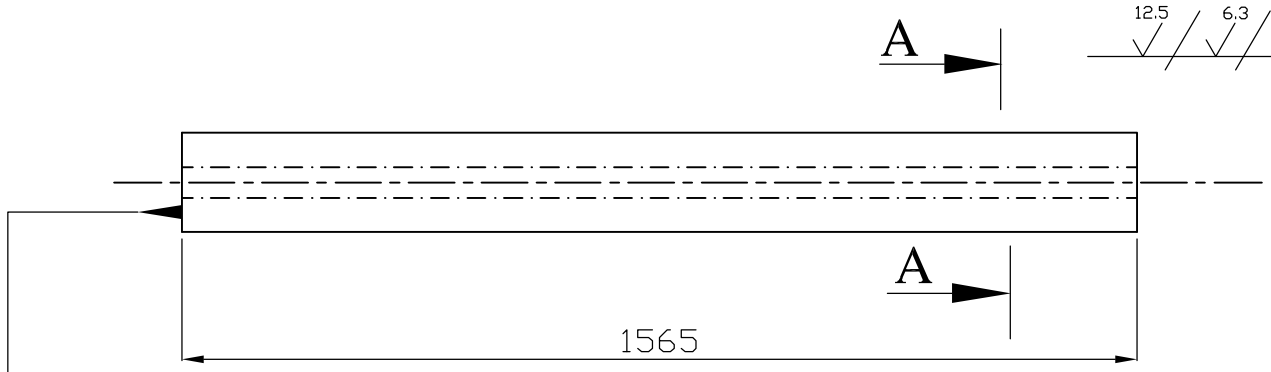

LOCATE HERE ATTESTATION DETAILS VIZ

SUPLIERS CODE
FORGE NO
MAT SPECN
MELT NO

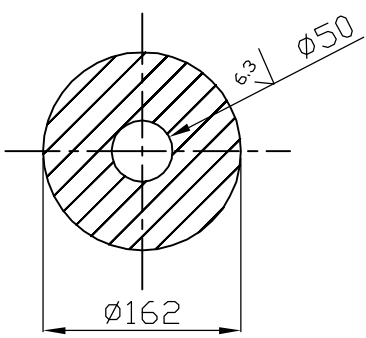

SECTION A-A

NOTE:-

1. FORGING TO BE ROUGH MACHINED TO DIMENSIONS INDICATED IN DRAWING.
2. BORE TO BE MACHINED PRECISELY
3. HOLE $\phi 50$ TO BE CONCENTRIC WITH RECEPT TO CENTRE LINE WITH IN 0.5
4. ULTRASONIC TEST TO BE CARRIED OUT AS PER SPECN AA0850118 CAT-3
5. FORGINGS SHOULD BE AS PER AA19332.
6. TOLERANCE ON ALL DIMN 1mm.

FORGING			BA9413253056	230.00
			AA19332	1
DESCRIPTION & DRG.NO.	VAR NO.	RAW MATERIAL SIZE OR CASTING DRG.NO. OR FORGING DRG.NO.	MATL. CODE	NET.WT. GROSS WT
			MATL. SPECN.	QTY.

TYPE OF PRODUCT OR NAME OF CUSTOMER/PROJECT **XRP 803-BOWL MILL**

REF. TO HY0230261 FOR UNSPECIFIED TOLERANCES.	BHARAT HEAVY ELECTRICALS LTD. HYDERABAD	DRN.	SRINU	12.7.06	NO.OF VAR.
		CKD.	AMAN	12.7.06	
		APPD.	S.G	12.7.06	
	DEPT. PULV.ENGG	SCALE 1:12 WEIGHT(K.G.) 230.00	REF.TO ASSY.DRG.	40-F-002-004	ITEM NO.
CODE 446		DRAWING NO. 4-61-376-90011			REV. 04
TITLE TRUNNION SHAFT (ROUGH MACHINED)		SHT.NO. 01	NO.OF SHT. 01		



CORPORATE PURCHASE SPECIFICATION

AA 193 32

Rev. No. 10

PAGE 1 OF 7

CARBON STEEL FORGINGS, CLASS-3

↑

1.0 GENERAL:

This specification governs the quality requirements of Carbon Steel Forgings, class 3.

↑

2.0 APPLICATION:

Suitable for general engineering purposes.

3.0 CONDITION OF DELIVERY:

Normalised/Normalised and tempered.

Rough machining of the forgings shall be carried out, unless otherwise specified in the BHEL order/drawing.

4.0 COMPLIANCE WITH NATIONAL STANDARDS:

The forgings shall comply, in general with the requirement of the following National standards and also meet the requirements of this specification.

IS::2004: 1991 (RA-2006) } Carbon Steel Forgings For General Engineering
Gr: 3 (30C8), } Purposes.

↑

5.0 DIMENSIONS AND TOLERANCES:

The dimensions and tolerances shall be as specified in the order/ drawing. Wherever these are not specified, specified, the machining allowances and tolerances shall be as specified below:

For finish machined drawings : 3 ± 1 mm

For rough machined drawings : ± 1 mm

Revisions : 36th MOM OF MRC FCF+HTM

APPROVED :
INTERPLANT MATERIAL RATIONALISATION COMMITTEE-MRC (FC&F+HTM)

Rev. No. 10

Amd.No.

Reaffirmed

Prepared

Issued

Dt. of 1st Issue

Dt. 23.01.2007

Dt :

Year:04-11-2011

HARDWAR

Corp. R&D

JANUARY 1978

COPYRIGHT AND CONFIDENTIAL
The Information on this document is the property of BHARAT HEAVY ELECTRICALS LIMITED
It must not be used directly or Indirectly in any way detrimental to the Interest of the company.

**6.0 MANUFACTURE:**

Forgings shall be manufactured from steel produced by the open hearth, electric or such other process as may be agreed to between BHEL and the manufacturer. ↑

Steel shall be fully killed.

Sufficient discard shall be made from each ingot to ensure freedom from pipe, segregation and other defects.

The amount of hot working and finishing temperature shall be such as to ensure complete soundness and adequate uniformity of structure and mechanical properties after heat treatment. The forgings shall not be overheated.

The minimum reduction ratio when forgings are made out of ingots shall be 4:1.

For sizes above 250 mm ruling section, the minimum reduction ratio shall be 3.5:1

Note: Raw material like Ingots/Blooms/Billets required for forgings should be procured from BHEL approved sources along with test certificate."

7.0 HEAT TREATMENT:

Forgings shall be normalised / normalised and tempered at suitable temperature to achieve the mechanical properties specified. ↑

Test pieces shall also be heat treated along with the forgings they represent.

8.0 FINISH:

As mentioned in the drawing.

9.0 FREEDOM FROM DEFECTS:

The forging shall be free from defects, such as cracks, fold, flakes, seams, segregation, nonmetallic inclusions and other defects which may affect the utility of the forging.

10.0 CHEMICAL COMPOSITION:

The melt analysis of steel and permissible variation in the composition of the forgings from the melt analysis shall be as follows:

Element	Melt analysis, percent		Permissible variation, percent
	Min.	Max.	
Carbon	0.25	0.35	± 0.03
Silicon	0.15	0.35	± 0.03
Manganese	0.60	0.90	± 0.04
Sulphur	---	0.040	+ 0.005
Phosphorus	---	0.040	+ 0.005

**Notes:**

1. Elements not quoted above shall not be added to the steel, other than for the purpose of finishing the heat and shall not exceed the following limits:

Element	Percent, max.
Nickel	0.30
Chromium	0.30
Copper	0.25
Molybdenum	0.15
Vanadium	0.05
Tin	0.05
Boron	0.0003

2. When steel is aluminium killed or killed with both aluminium and silicon, the requirements of minimum silicon content shall not apply. For aluminium killed steel the total aluminium content shall be within 0.02 to 0.05 percent.
3. $Mo \leq 0.15\%$, limiting to meeting conditions of $Cr + Mo + Ni = 0.5\%$.

11.0 TEST SAMPLES:

- 11.1 Unless otherwise specified in the order/drawing, test samples shall be taken from each melt and each heat treatment batch. Test samples should be cut from the heat treated forgings by cold process only and shall not have further heat treatment.

Test samples shall be taken from locations indicated on the drawing, leaving enough material, if required for testing at BHEL's end, integral with forgings.

The samples shall be cylindrical or rectangular in shape and cut at a distance of 12.5mm below the heat treated surface.

- 11.2 When integral test pieces are not called for, a test sample, having similar reduction ratio and heat treatment, as the forgings it represents, shall be provided per heat, per heat treatment batch, for check testing at BHEL, along with the forgings. The samples shall be properly identified and correlated with the Heat/Heat treatment Batch No./ Test Certificate No. Test samples shall be taken, at a distance of 12.5mm below the heat-treated surface.
- 11.3 Test samples shall generally be taken in the longitudinal direction. However, for economic reasons or where the size/ configuration does not permit the same, test samples may be taken in the transverse or radial direction.

**12.0 MECHANICAL PROPERTIES:**

The test pieces, after being heat treated as per clause 7.0 above, shall show the following properties upto a limiting ruling section of 800 mm. Properties for thicker sections shall be subject to agreement between BHEL and the manufacturer. Test methods are specified below:

- 12.1 Tensile test : IS:1608
 12.2 Hardness test (Brinell) : IS:1500
 12.3 Charpy Impact Value (2mm U-Notch) : IS:1499

This test applicable for forgings of sizes above 16mm only.

Property	Sample (See Cl.11.3)	Limiting ruling section, mm			
		Upto & incl 100	>100 & upto 300	> 300 & upto 500	>500 & upto 800
Tensile strength N/mm ²	Longitudinal/	490	470	450	450
	Transverse/ Radial/Tangential	490	470	450	450
Yield strength min, N/mm ²	Longitudinal/	270	245	230	220
	Transverse/ Radial/Tangential				
Elongation on 5.65 √So gauge length percent, min	Longitudinal	21	19	18	17
	Transverse	10	9	8	7
	Radial	14	12	11	10
	Tangential	16	14	13	12
Reduction in area, percent min.	Longitudinal	42	40	35	32
	Transverse	25	24	22	20
	Radial	27	26	24	22
	Tangential	34	32	32	30
*Hardness, Brinell,HB	—	140-192	140-192	135-190	135-190
Charpy Impact Value (2mm, U-Notch) min.,Joules	Longitudinal	35	31	27	23
	Transverse	18	16	14	12
	Radial	21	19	17	15
	Tangential	26	23	20	17

Note: 1. Unless otherwise stated on the order/drawing, small forgings of non-critical nature weighing less than 300kg shall be accepted on the basis of chemical composition and hardness.

* 2. Hardness test can be conducted only, when tensile test can not be performed.



13.0 ULTRASONIC TESTS:



- 13.1 For forgings ordered by BHEL, Hyderabad: Unless other wise specified on the drawing, ultrasonic test shall be carried out as per BHEL standard AA 085 01 18 and norms of acceptance shall be as per category 2.
- 3.13.2 For forgings ordered by other units: If specified on the drawing/order, ultrasonic test shall be carried out as per BHEL standard AA 085 01 18 and norms of acceptance shall be as per category 2, unless otherwise specified.

14.0 ADDITIONAL TESTS:

If specified in the drawing/order, the following tests shall be conducted:

14.1 Bend Test (Longitudinal):

The test pieces (230mm long and 32 mm square with edges rounded off, where the dimensions permit) shall be capable of being bent cold by direct pressure without fracture, until the sides are parallel, round a mandrel having a diameter of 44 mm when tested as per IS:1599.

14.2 Magnetic particle test.

14.3 Any other tests: Norms of acceptance shall be as specified in the drawing/order.

15.0 SCOPE OF THIRD PARTY INSPECTION:

Wherever, separate quality plan is not attached, the scope of third party inspection shall be as follows:

1. Review of supplier's declared chemical composition.
2. Selection of test samples for mechanical tests and witness of mechanical tests.
3. Witness of Non-destructive tests as applicable.
4. Review of HT charts.
5. Dimensional inspection.

16.0 TEST CERTIFICATE:

Three copies of test certificates shall be supplied unless otherwise stated in the order, preferably in the test certificate format annexed to this specification (Annexure 1).

In addition, the supplier shall ensure to enclose one copy of the test certificate along with their dispatch documents to facilitate quick clearance of the material.

The following details shall be furnished in the test certificate:

- i) Reduction ratio
- ii) Dimensional Inspection.
- iii) Chemical composition including trace elements.
- iv) Results of mechanical tests.
- v) Results of Ultrasonic test
- vi) Details of heat treatment
- vii) Results of additional tests called for in the drawing/order.

**17.0 PACKING & MARKING:**

Forgings shall be suitably packed to prevent corrosion and damage during transit.

Machined surfaces shall be properly protected with anticorrosive compounds.

Each package or forging (when supplied separately) shall be legibly marked with the following information:

AA 193 32 : Carbon Steel Forgings, Class 3



BHEL Order No.

Suppliers Name

Consignment/ Identification No.

Batch No.

Weight.

18.0 REFERRED STANDARDS (Latest publications Including Amendments):

1) AA 085 01 18
5) IS: 1608

2) IS:1499
6) 2004

3) IS:1500

4) IS:1599



CORPORATE PURCHASE SPECIFICATION

AA 193 32

Rev. No. 10

PAGE 7 OF 7

ANNEXURE-I: RECOMMENDED TEST CERTIFICATE FORMAT FOR FORGINGS

SUPPLIER'S NAME AND ADDRESS											
TEST CERTIFICATE FOR FORGINGS											
1. Customer:						9. Reduction Ratio } Ingot to Bloom Bloom to Blank					
2. TC No. & Date:						10. Batch No.:					
3. PO No.:						11. Heat/Melt No.					
4. Process of Melting Ingot:						12. Spec.No.					
5. Deoxidisation Process:						13. Test Bar Size & Nos.					
6. Forging Method:						14. Supplier of the ingot/billet/ Bloom and TC reference.					
7. BHEL's Reference for Approval of Bloom											
8. Discard: Top % , Bottom %											
15. FORGINGS COVERED BY TEST CERTIFICATE											
S.No.	Drawing No. & Item No.					Description	Quantity & Weight				
16. CHEMICAL COMPOSITION (PERCENT)											
Element	C	Si	Mn	S	P						
As Per Specn.	Min.										
	Max.										
Actual Values											
17. HEAT TREATMENT (To be accompanied by Recorder Chart, Whenever called for)											
Condition	Heating Rate, °C/hr.		Temp. °C		Soaking Time, Hrs.		Cooling Rate, °C/hr		Cooling Medium		
18. MECHANICAL PROPERTIES											
As Per Specn.	T.S. N/mm ²	Y.S. 0.5/0.2% Proof N/mm ²	% Elongation 5.65√So GL	%R.A. Min.	Hardness BHN(Min.3 values)	Impact Value Joules	Bend Test				
							Angle of bend	Dia of mandrel	Result		
Min.											
Max.											
Actual Values											
19. SURFACE FINISH (When called for in the order/drg.)											
20. DIMENSIONAL INSPECTION											
21. NON-DESTRUCTIVE TESTS											
Nature of Test	Acceptance level			Instrument used		Range	Results	Any other detail			
Ultrasonic											
Radiographic											
Dye penetrant/ Magnetic Particle											
22. METALLOGRAPHIC EXAMINATION (To be conducted if called for and photo micrographs to be attached along with a report)											
Location of Sample	Etchant used		Magnification		Constituent observed		Relative %				
Microstructure	Macroetch		Inclusion Rating								
23. OTHER TESTS IF ANY (MICROSCOPIC, SULPHUR PRINTS, ETC)											
24. IDENTIFICATION OF FORGINGS AS PER PURCHASE SPEC.											
We hereby certify that the items mentioned above have been tested and inspected in our presence and are found to be in accordance with drawings, specifications and purchase order.											
SIGNATURE, NAME & SEAL OF THE INSPECTING OFFICER DATE:						SIGNATURE, NAME & SEAL OF THE CHIEF OF QUALITY CONTROL/ CHIEF METALLURGIST OF THE SUPPLIER DATE:					
INSTRUCTIONS											
a) Details of all heat treatment processes carried out should be furnished sequentially in 17.											
b) Test certificates are to be furnished as per Purchase order and specification, in A4 size preferably in transparent paper.											
c) All the entries including signature should be in block colour ink.											
d) If testing is done by outside agencies, the original TCs shall be furnished.											
e) The actual TC may run into more than one A4 size paper, if needed, to facilitate filling up of details.											



CORPORATE STANDARD

AA0850118

Rev. No.01

PAGE 1 of 5

ULTRASONIC TESTING, CLASSIFICATION AND ACCEPTANCE STANDARDS FOR STEEL FORGINGS, BILLETS AND BLOOMS

1.0 SCOPE:

This standard deals with the ultrasonic testing of steel forgings, billets and blooms. The procedure covers pulse echo direct contact manual ultrasonic flaw detection technique. This standard does not apply to austenitic steel forgings for which AA0850119 may be referred to.

2.0 PERSONNEL REQUIREMENT:

Personnel performing non-destructive examination and evaluation shall be qualified to the recommended practice SNT - TC - 1A or any other recognised practice.

3.0 EQUIPMENT CHARACTERISTICS:

3.1. Frequency range:

The ultrasonic equipment shall be suitable for operating at frequencies within the range of 0.5 to 6 MHz.

3.2. Sensitivity:

The sensitivity of the equipment shall be tested to ensure that the number of full screen back wall echo is not less than that given below, when the appropriate probe is placed on the metalised surface of plastic insert of the Indian Standard reference block (IS:4904)/IIW block.

Frequency MHz	Min. No. of full screen back echoes
1	5
2	4
4 to 6	2

3.3. Resolution:

The resolution of the equipment and probe combined shall be such as to show separately indications of the three grooves in the IIW- VI block.

4.0 SURFACE CONDITION:

The test surface shall be free from loose scales, rust and such other extraneous material that would interfere with the ultrasonic energy transmission. In case of machined surface, it is desirable to have a surface finish of 6.25 microns or better. A gramophone record type

Revisions:
Clause.9.4 & 10.2.4 of MOM of WG-NDT

APPROVED:
INTER PLANT STANDARDISATION
COMMITTEE – WG(NDT)

Rev. No.01	Amd. No.01	Reaffirmed	Prepared	Issued	Dt. of 1 st Issue
Dt:02-01-1995	Dt: 15-01-1996	Year:	HEEP, Haridwar	Corp. R&D	Jan 1980

COPYRIGHT AND CONFIDENTIAL
The Information on this document is the property of BHARAT HEAVY ELECTRICALS LIMITED.
It must not be used directly or indirectly in any way detrimental to the Interest of the company.



of finish and tear produced by machining tools shall be avoided since these give rise to spurious echoes and cause probe wear.

5.0 COUPLANT:

To ensure adequate transmission of ultrasonic energy between the probe and the test object, a suitable couplant having good wetting characteristics such as oil, grease, glycerine or water shall be used.

6.0 TESTING TECHNIQUE:

6.1. Selection of testing technique shall be made after giving due consideration to the method of manufacture and shape of the object tested. Testing technique should be such that each and every part of the object volume is scanned at least once. Successive scans shall overlap a minimum of 15% of the probe width. Uniform contact shall be maintained between probe and object and scanning speed shall not exceed 150 mm/ second. The following techniques are considered to be minimum for providing adequate coverage.

6.2. Scanning Scheme (Solid And Hollow Forgings):

Complete length of the forging shall be scanned radially from sides/cylindrical surface through 360° using longitudinal wave probe. Whenever practicable the forging shall be scanned in axial direction also. Hollow forgings, and when necessary, solid forgings also shall be scanned using appropriate shear wave probes to detect axial and radial cracks. Hollow forgings are the forgings made hollow on the press by punching or ring rolling operation.

6.3. Solid Rectangular Forgings, Billets and Blooms: Complete length of the object shall be scanned from two adjacent faces and whenever practicable one end face using longitudinal wave probe.

6.4. Radial cracks on round sections which cannot be detected by normal testing method may be subjected to other crack detection methods such as MPI.

7.0 SCANNING:

7.1. Probes and Frequency:

Overall scanning shall be done using 2 MHz nominal, 20-25 mm diameter probes expect when large grain size and path length make it necessary to use a lower frequency. Smaller probes may be used when necessary. However, for forgings intended for backing material for white metal lined bearings, the examination shall be carried out by 4 MHz probes.

7.2. Time Base Calibration:

The time base shall be calibrated using a calibration block or a known dimension of forging under examination.

7.3. Sensitivity:

7.3.1. When Calibrated Attenuator is Not Available:

Reference sensitivity of equipment shall be set such that the maximum acceptable defect equivalent flat bottomed hole in the test block is equal to 75% of the full screen height. Testing shall be carried out at the highest sensitivity possible.



CORPORATE STANDARD

AA0850118

Rev. No.01

PAGE 3 of 5

7.3.2. When Calibrated Attenuator is Available:

The sensitivity of the equipment during scanning shall be set 6 dB more than the sensitivity required to give a full screen height echo from the maximum acceptable size of defect.

Note: The above sensitivity level adjustment is purely for scanning purposes. Once a defect is encountered, the sensitivity shall be brought down to estimate the size of defect for evaluation of the material under test.

8.0 ESTIMATION OF FLAW SIZE:

8.1. Large Size Flaws:

The size of large flaws can be estimated by moving the probe in all directions and plotting the midpoint of the probe when echo falls to 50 percent or 6 dB.

8.2. Small Size Flaws:

8.2.1. When Calibrated Attenuator is Not Available:

8.2.1.1. The size of the flaw may be estimated by comparing with the echoes of the flat bottomed holes at appropriate depths in a test block of ultrasonically similar material.

8.2.1.2. The size of the flaw may also be estimated by moving probe successively in all the four directions at right angles to each other and plotting the midpoint of the probe when echo height falls to 50% or 6 dB. Due allowance shall also be made for beam spread, depth and orientation of flaw and diameter of the forging if the scanning is done from the curved surface.

8.2.2. When Calibrated Attenuator is Provided With The Equipment:

The size of the flaw (smaller than the beam spread) can be estimated accurately in millimetres of equivalent circular flaw with the help of Krautkramer's DGS (Distance – Gain – Size) diagram. Method of estimating flaw size using a DGS diagram is given in Annexure - A.

9.0 CLASSIFICATION OF FORGINGS, BILLETS AND BLOOMS:

9.1. Forgings, billets and blooms are classified into the following five categories depending upon the defect size admissibility for the purpose of ultrasonic testing:

Category	Unacceptable defects
1	<ul style="list-style-type: none">i) Cracks, flakes, seams & laps.ii) Defects giving indication larger than that from a 2 mm diameter equivalent flaw.iii) Groups of defects with maximum indication less than that from a 2 mm diameter equivalent flaw which cannot be separated at testing sensitivity if the back echo is reduced to less than 70%.iv) Defects giving indications of 1 to 2 mm diameter equivalent flaw separated by a distance less than four times the size of the larger of the adjacent flaws.

Category	Unacceptable defects
2	i) Cracks, flakes, seams & laps. ii) Defects giving indication larger than that from a 4 mm diameter equivalent flaw. iii) Groups of defects with maximum indication less than that from a 4 mm diameter equivalent flaw which cannot be separated at testing sensitivity if the back echo is reduced to less than 50%. iv) Defects giving indications of 2 to 4 mm diameter equivalent flaw separated by a distance less than four times the size of the larger of the adjacent flaws.
3	i) Cracks, flakes, seams & laps. ii) Defects giving indication larger than that from a 6 mm diameter equivalent flaw. iii) Groups of defects with maximum indication less than that from a 6 mm diameter equivalent flaw which cannot be separated at testing sensitivity if the back echo is reduced to less than 40%. iv) Defects giving indications of 3 to 6 mm diameter equivalent flaw separated by a distance less than four times the size of the larger of the adjacent flaws.
4	i) Cracks, flakes, seams & laps. ii) Defects giving indication larger than that from a 10 mm diameter equivalent flaw. iii) Groups of defects with maximum indication less than that from a 10 mm diameter equivalent flaw which cannot be separated at testing sensitivity if the back echo is reduced to less than 20%. iv) Defects giving indications of 5 to 10 mm diameter equivalent flaw separated by a distance less than four times the size of the larger of the adjacent flaws.
5	i) Cracks, flakes, seams & laps. ii) Defects giving indication larger than that from a 15 mm diameter equivalent flaw. iii) Groups of defects with maximum indication less than that from a 15 mm diameter equivalent flaw which cannot be separated at testing sensitivity if the back echo is reduced to less than 10%.

Note: Loss of back wall echo not attributable to the presence of defects or geometry and exceeding the limits mentioned in item (iii) of each category of unacceptable defects shall be a cause for rejection.

ANNEXURE - A

The equivalent flaw size curves of the DGS diagram is prepared by plotting the amplitude in decibels from a series of circular reflectors with increasing distance from the probe in water and so the graph incorporates only the loss in water. When it is found that the attenuation in the material under test is more (this can be checked using back echo curve of DGS diagram), this shall be taken into account while calculating the flaw size. Corrections will not be required for majority of heat treated forgings when tested with 2-4 MHz probes.

A step by step method of estimating flaw size using universal DGS diagram is given below:

- Adjust the depth range of the equipment to the required depth.
- Adjust the back echo to 70% of screen height from a defect free area parallel wall of the material under test or ultrasonically similar test block and note the dB value (A) on the calibrated gain control.

- (c) Mark on the back echo curve of the diagram, the back wall of the distance in terms of near field in millimetres in the case of universal DGS diagram.
- (d) Move the probe to the defective area and get the maximum defect echo. Read off the flaw depth. Increase the gain with the calibrated gain control until echo height reaches 70% of screen height. Note the attenuator reading in dB (B).
- (e) Calculate the gain (G) in dB by subtracting 'A' from 'B'. Count off the gain 'G' downwards from the marked point on the back echo curve, and then move horizontally to intersect the vertical line from the base line corresponding to the flaw depth 'D*' in terms of near field in the case of universal diagram.
- (f) Note the equivalent flaw size curve passing through the above point. Multiply the reduced flaw dimension (S) of the curve by the probe diameter to give the equivalent flaw size in millimetres.

ANNXXURE - A

KRAUTKRAMER'S DGS DIAGRAM

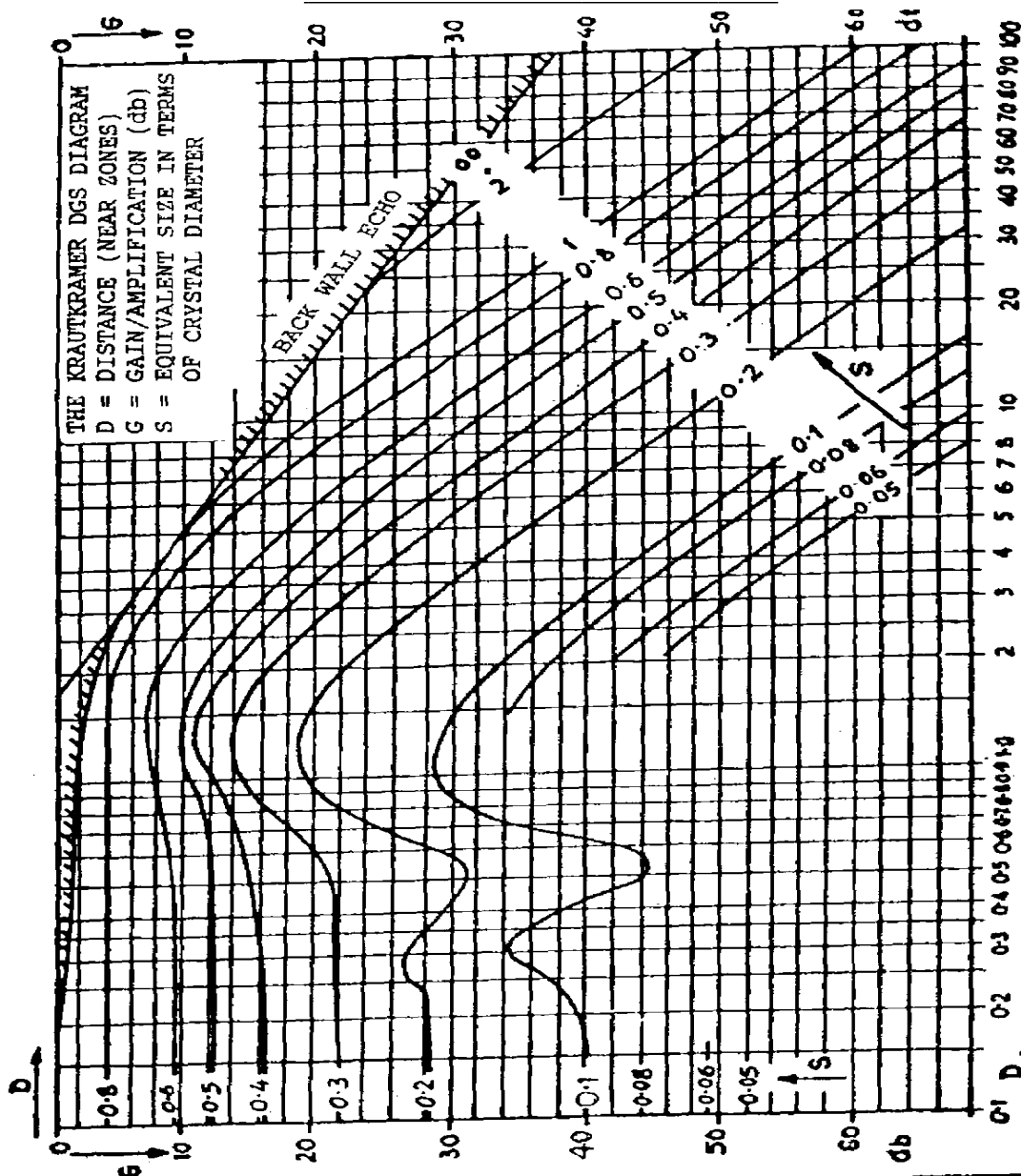



CORPORATE STANDARD

AA 085 01 33

Rev. No. 03

PAGE 1 OF 7

PROCEDURE FOR MAGNETIC PARTICLE EXAMINATION

1.0 SCOPE:

- 1.1 This standard outlines the procedure for magnetic particle examination of ferro-magnetic materials.
- 1.2 Typical surface and subsurface discontinuities detectable by this method are cracks, seams, laps, cold shut, inclusions, etc.
- 1.3 This shall be applied to all forms of ferromagnetic material as formed and semiformal as well as, finished state, such as welds, forgings, castings, etc.
- 1.4 This standard is generally based on ASTM E 709.

2.0 PERSONNEL REQUIREMENT:

Personnel performing non-destructive examination and evaluation shall be qualified to the recommended practice SNT- TC-1A or any other recognised practice.

3.0 TEST METHOD:

-
4

Finely divided magnetic particles are applied to the surface of a part which has been suitably magnetised. The particles are attracted to regions of magnetic non-uniformity associated with defects and discontinuities, thus producing indications which are observed visually. The magnetic particle is applied either as dry powder or in a wet suspension in a liquid medium.

4.0 SURFACE CONDITION/PREPARATION:

The surface being inspected shall be clean and dry. It shall be free from dirt, oil, grease, sand, rust or loose scale. As cast or as welded surfaces are generally satisfactory if clean. A pressure blast is useful for this purpose. Thin paint does not interfere with the formation of indications but must be removed at points where electrical contact is to be made. If the surface is unusually rough, such as with burned in sand or very rough weld bead, interpretation may be difficult because the particle is being trapped mechanically. In case of doubt, light grinding may be necessary to determine if actual indications are present..

COPYRIGHT AND CONFIDENTIAL
The Information on this document is the property of BHARAT HEAVY ELECTRICALS LIMITED
It must not be used directly or indirectly in any way detrimental to the interest of the company.

Revisions:

Cl. 12.8.8 of MOM of WG-NDT

APPROVED:
INTERPLANT STANDARDIZATION
COMMITTEE (WG-TOOLS)

Rev. No. 02

Amd.No.

Reaffirmed

Prepared

Issued

Dt. of 1st Issue

Dt: 15-12-97

Dt:

Year:

HYDERABAD

Corp. R&D

Sept.'79

**5 .0 SEQUENCE OF OPERATION:****5 .1 Method Of Examination:**

Examination shall be generally carried out by the continuous method, i.e., the magnetising current remains on, while the examination medium is being applied and excess being removed.

5 .2 Magnetisation:

Any suitable and appropriate means for establishing the necessary magnetic flux may be employed, such as passing current through the material (e.g. 'Prod' method) using magnetic yoke, or wrapping the part with a coil through which a magnetising current is passed.

5 .3 Examination Medium:

5 .3 .1 The finely divided ferromagnetic particles used for detection of discontinuities shall be of fine grain and the same shall be of high permeability and low retentivity. It shall be of dry powders (Fluorescent and nonfluorescent) ready for use, as supplied or powder concentrates (Fluorescent and non-fluorescent) for dispersion in water or suspending light petroleum distillates.

5 .3 .2 Dry Particles:

When dry particles are used, they shall be sprayed either by a low pressure pneumatic instrument or hand operated bulb blower. Colour of the powder shall be such as to provide adequate visual contrast with the back ground of the surface being examined. The temperature of the surface of the part under examination shall not exceed 315°C (600°F). Adequate lighting should be provided for easy observation of the indication. Some coloured organic coatings applied to dry particles to improve contrast lose their colour at higher temperatures- Fluorescent dry particles shall not be used at this high temperature. Manufacturer's recommendations for temperature limitation shall be followed.

5 .3 .3 Wet Particles:

When wet particles are used, the solid magnetic particles shall be suspended in a suitable liquid medium. The concentration of the particles in the liquid medium shall be 0.2 to 0.4 ml in a 100ml sample for fluorescent particles and from 1.2 to 2.4 ml in a 100 ml for non-fluorescent particles unless otherwise specified by the particle manufacturer.

5 .3 .4 Florescent Particlaes

5. 4. 3. 1 The fluorescent particle examination shall be performed using a black light in a darkned area.



CORPORATE STANDARD

AA 085 01 33

Rev. No. 02

PAGE 3 OF 7

5.3.4.2 The black light used for fluorescent particle testing shall be capable of developing the wave length of 365nm; in any case the wave length should be in the range of 330 to 390nm. with an intensity of not less than 1000 uw/cra² on t surface of the part.

5.3.4.3 The black light shall be allowed to warm up for a minimum of 5 min. prior to its use or measurement of the intensity of the ultraviolet light emission.

5.3.4.4 The examiner shall be in the darkened area for atleast 5 min. prior to examining the parts using black light so that his eyes will adopt to dark viewing. Photochromic or permanently tinted lenses shall not be worn during examination.

5.3.4.5 The black light intensity shall be measured with a black light meter at least once every 8 hours and whenever the work station is changed.

5.4 Orientation of Discontinuities And Examination Coverage:

Examination shall be conducted with sufficient overlap to ensure cent percent coverage at established test sensivity. To ensure most effective detection of discontinuities each area shall be examined at least twice with the lines of flux approximately perpendicular to each other.

5.5 Demagnetisation:

Demagnetisation following examination shall be carried out where residual magnetism can interfere with subsequent process or usage. Demagnetisation is not normally required on the type of parts where the dry powder Prod magnetisation is used.

6.0 METHODS OF MAGNETISATION:

6.1 Prod Method:

6.1.1 Magnetising Technique:

6.1.1.1 Magnetisation shall be accomplished by portable Prod type electrical contacts pressed against the surface in the area to be examined. To avoid arcing, a remote control switch may be provided to permit the current to be turned on after the prods have been properly positioned and turned off before they are removed.

6.1.2 Prod Spacing:

Prod Spacing shall be maximum of 200 mm. Shorter spacing may be used to meet the limitation of geometry or dimensions of the area being examined, or to increase the sensitivity, but prod spacing less than 75 mm usually is not recommended owing to banding of the particles around the prods



6. 1. 3 Magnetising Current:

Alternating, direct or rectified magnetising current shall be used. The current shall be 90 to 110 A per 25mm. of prod spacing for sections less than 19mm. thick and 110 to 125 A per 25mm. prod spacing for sections 19mm. and greater.'

6. 1. 4 Prod shall be kept free of iron pick up by frequent filing. Local areas of metal being tested which have been subjected to arcing shall be ground to clean metal wherever necessary.

6. 2 Coil Method:

6. 2 .1 Magnetising Technique:

Magnetisation shall be accomplished by pressing current through a multiturn coil looped around the part or section of the part to be examined to produce a magnetic field parallel to the axis of the coil.

6. 2. .2 Magnetising Current:

6. 2. 2.1 Encircling Coils:

There are four empirical longitudinal magnetization formulas for using encircling coils , the formulas to be used depending on the fill factor.

6. 2. .2. 1 .1 **Low Fill Factor Coils:** In this case , the cross sectional area of the fixed encircling coil greatly exceed the cross sectional area of the part (Less than 10% coil inside diameter). The part shall be placed well within the coils and close to the inside wall of the coil. For parts with length over diameter ratio (L/D) between 3 and 15 is calculated from the following equations.

(1) **Parts with low fill factor positioned closed to the inside wall of the coil in the center of the coil;**

$$= \frac{45,000}{L/D} \text{ Ampere Turns } (\pm 10\%)$$

(2) **Parts with a low fill factor positioned in the center of the coils:**

$$= \frac{43,000 \times R}{(6 L/D) - 5} \text{ Ampere Turns } (\pm 10\%)$$



6. 2. 2. 1.2 Intermediate Fill Factor Coils:

When the cross section of the coil is greater than twice and less than ten times the cross section of part being examined.

$$= (NI) hf (10-4) + (NI) lf (4 -2)/8$$

Where

NIhf = Value calculated for high fill factor coils using

$$\frac{35000}{(L/D) + 2} \quad (10\%)$$

NIlf = Value Calculated for low fill factor coils using

$$\frac{43/000 \times R}{(L/D) - 5} \quad (10\%)$$

Where R = Coil Radius

Y = Ratio of the cross sectional area of the coil to the cross section of the part.

For example if the coil has an inside diameter of 24 cm. and part (a bar) has outside diameter of 12 cm.

$$Y = \frac{n(12)^2}{n(6)^2} = 4$$

6. 2. 2. 1.3 High Fill Factor Coils:

In this case, when fixed coils or cable wraps used and the cross sectional area of the coil is less than twice the cross sectional area (Including hollow portions) of the part, the coil has a high fill factor.

For parts with in a high fill factor positional coil and for parts with L/D ratio equal or greater than 3.

$$= \frac{35,000}{(L/D)+2} \text{ Ampere turns (+ 10\%)}$$

L/D ratio for a hollow piece: When calculating L/D ratio for a hollow piece, D shall be replaced with an effective diameter Deff. Calculated using.

$$Deff. = [(At - Ah)/n]^{\frac{1}{2}}$$

Where

At = Total cross section area of part

Ah = Cross sectional area of hollow portion(s) of the part.

For a cylindrical piece this is equivalent to

$$Deff. = [(OD)^2 - (ID)^2]^{\frac{1}{2}}$$

Where

OD = Outside diameter of cylinder

ID = Inside diameter of cylinder.

**6.2.2.2 Through Coils:**

For through coils the current specified in para 6.3.2 divided by number of turns shall be used.

6.3 Direct Contact Method:**6.3.1 Magnetising Technique:**

Magnetising shall be accomplished by passing current end to end through the part to be tested to produce a circular magnetic field perpendicular to the current "flow through the part.

6.3.2 Magnetising Current :

Direct or rectified current shall be used at 280 to 360 amperes per centimeter of part for diameter upto 125 mm; 200 to 280 amperes per centimeter of part for diameter grater than 250mm.

(Note: A different means of magnetising shall be used for the second examination to fulfill the requirements specified in Cl.5.4).

6.4 Yoke Method:**6.4.1 Application:**

This method shall be used only to detect surface discontinuities which actually come to the surface.

6.4.2 Magnetising Technique:

6.4.2.1 Alternating current electromagnetic yoke shall be used to magnetise, provided the yoke has a lifting power of at least 4.5 Kg and a pole spacing of 75 to 150 mm.

6.4.2.2 Alternatively direct current electromagnetic or permanent magnetic yoke shall be used to magnetise, provided the yoke has a lifting power of at least 18 kg and a pole spacing of 75 to 150 mm.

6.5 Threading Bar and Coil Technique:

6.5.1 If the part is hollow, flaws in a longitudinal direction may be detected by passing the magnetising current through a bar or cable held within the bore of the part. Alternatively a threading coil may be used.

6.5.2 The current strength shall be equivalent to not less than 10500 ampere turns (a.c; r.m.s value) or 15000 ampere turns (d.c.) per metre of the maximum distance of the bar cable from the surface of the bore of the part.



CORPORATE STANDARD

AA 085 01 33

Rev. No. 02

PAGE 7 OF 7

- 6.5.3 Because of limitations of the equipment, it may be necessary to magnetise the part at several positions within the bore, with the bar or cable lying on the bore surface, in which case the distance between spacing of the conductor or coil for successive checks shall not be greater than 100 mm.

Note: Magnetising particle field indicator shall be used to establish adequacy of the magnetic field.

7.0 CALIBRATION:

Calibration of the ammeter shall be done as per BHEL Standard AA 085 01 59.

8.0 EVALUATION OF INDICATIONS & INTERPRETATION:

- 8.1 If the indication is caused by the surface discontinuity the particles are usually tightly held to the surface by a relatively strong magnetic leakage field. The line of particles will be sharp and well defined.
- 8.2 If the indication is caused by surface discontinuity, the particles are held in a broad fuzzy accumulation rather than being sharp and well-defined.
- 8.3 Non-relevant indications are caused by distortion of magnetic field resulting from magnetic writing, cold working, hard and soft spots, boundaries of heat affected zone, abrupt change of section, etc. Care shall be taken to identify and eliminate them as they may mask the actual defect.
- 8.4 Relevant indications are those which result from mechanical discontinuities. Linear indications are those in which the length is more than three times the width. Rounded indications are indications in which are circular or* elliptical with the length less than three times the width.

9.0 REFERRED STANDARDS (Latest Publication Including Amendments):

1. ASTM E 70

2. BHEL CS AA 085 01 59



ACCEPTANCE STANDARDS FOR INDICATIONS REVEALED DURING MAGNETIC PARTICLE EXAMINATION OF STEEL FORGINGS

1.0 SCOPE:

This standard gives the acceptance norms for indications revealed during the magnetic particle inspection of steel forgings used for general applications.

2.0 PROCEDURE:

The procedure, requirement of equipment, consumables and personnel shall be as per BHEL standard AA 085 01 33 which is generally based on ASTM E 709.

3.0 ACCEPTANCE NORMS:

Following defects are unacceptable.

Category I:

- i) Any cracks/linear indication.
- ii) Rounded indication larger than 3mm size.
- iii) Groups of rounded indications with individual size of 3mm or less and separated by a distance of less than 2 times the largest defect.

Category II:

- i) Any cracks/linear indication.
- ii) Rounded indication larger than 6mm size.
- iii) Groups of rounded indications with individual size of 6mm or less and separated by a distance of less than 2 times the largest defect.

4.0 REFERRED STANDARDS(Latest Publications Including Amendments):

- 1. BHEL CS AA 085 01 33
- 2. ASTM E 709

Revision:			Approved: INTERPLANT STANDARDIZATION COMMITTEE-WG (WG-NDT)		
Rev.No.	Amd.No.	Reaffirmed	Prepared SSTP TRICHY	Issued CORP. R&D	Dt. of 1st issue 1-12-96
Dt.	Dt.	Year:			

COPYRIGHT AND CONFIDENTIAL
 The information on this document is the property of BHARAT HEAVY ELECTRICALS LIM. D.
 It must not be used directly or indirectly in any way detrimental to the interest of the company.

(ALL DIMENSIONS ARE IN. m.m.) - (FIRST ANGLE PROJECTION)

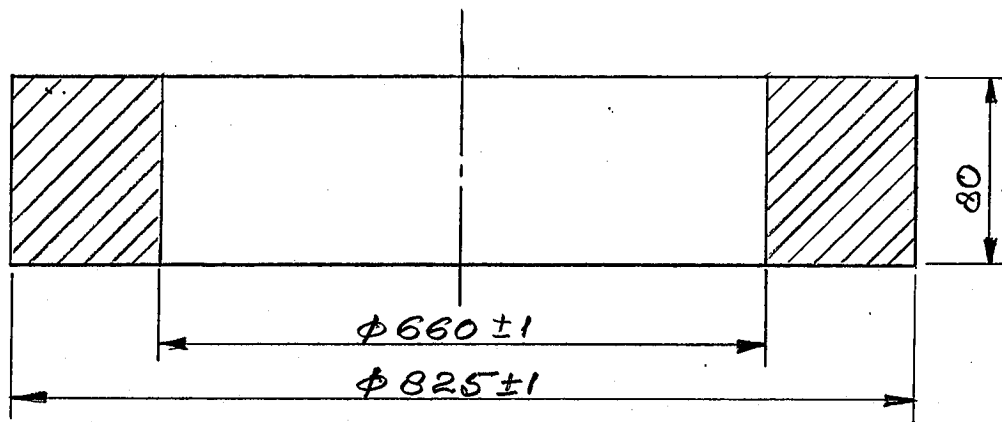

NOTES:-

01. BREAK ALL SHARP EDGES & CORNERS UNLESS OTHER WISE NOTED.
02. FORGINGS TO BE ROUGH MACHINED TO DIMENSIONS INDICATED IN DRAWING.
03. TEST ULTRASONICALLY AS PER CORP. STD. AA0850118 CAT2.
04. TOLERANCE ON ALL DIMENSIONS ± 1 m.m.

	01	FORGING			123.0
			AA19332		1
REMARKS	ITEM NO.	DESCRIPTION	MATERIAL CODE		WT. (kg)
			MATERIAL SPECN.		QTY.

Bharat Heavy Electricals Ltd. (H. E. R. P.) Shivpur, Varanasi-221003		DRN	NAME	SIGN.	DATE	NO. OF VAR.
		CHD	V. Kumar	<i>V. Kumar</i>	09.09.02	
		APPD	P.P. Singh	<i>P.P. Singh</i>	09.09.02	
		SCALE	HEIGHT (mm)	REF. TO ASSLY. DRG.	ITEM NO.	NO. OF ITEMS
		NTS	123.0	2-61-000-00752		
TITLE				DRAWING NO.		REV.
GRINDING ROLL LOCK NUT				HY-312.A.03F		1
				SHEET NO.	NO. OF SHEETS	

Master Copy →

REV.	DATE	ALTERED	REV.	DATE	ALTERED	REV.	DATE	ALTERED
		CHECKED			CHECKED			CHECKED
		APPROVED			APPROVED			APPROVED

THE INFORMATION ON THIS DOCUMENT IS THE PROPERTY OF BHARAT HEAVY ELECTRICALS LIMITED. IT MUST NOT BE USED DIRECTLY OR INDIRECTLY IN ANY WAY DETRIMENTAL TO THE INTEREST OF THE COMPANY.

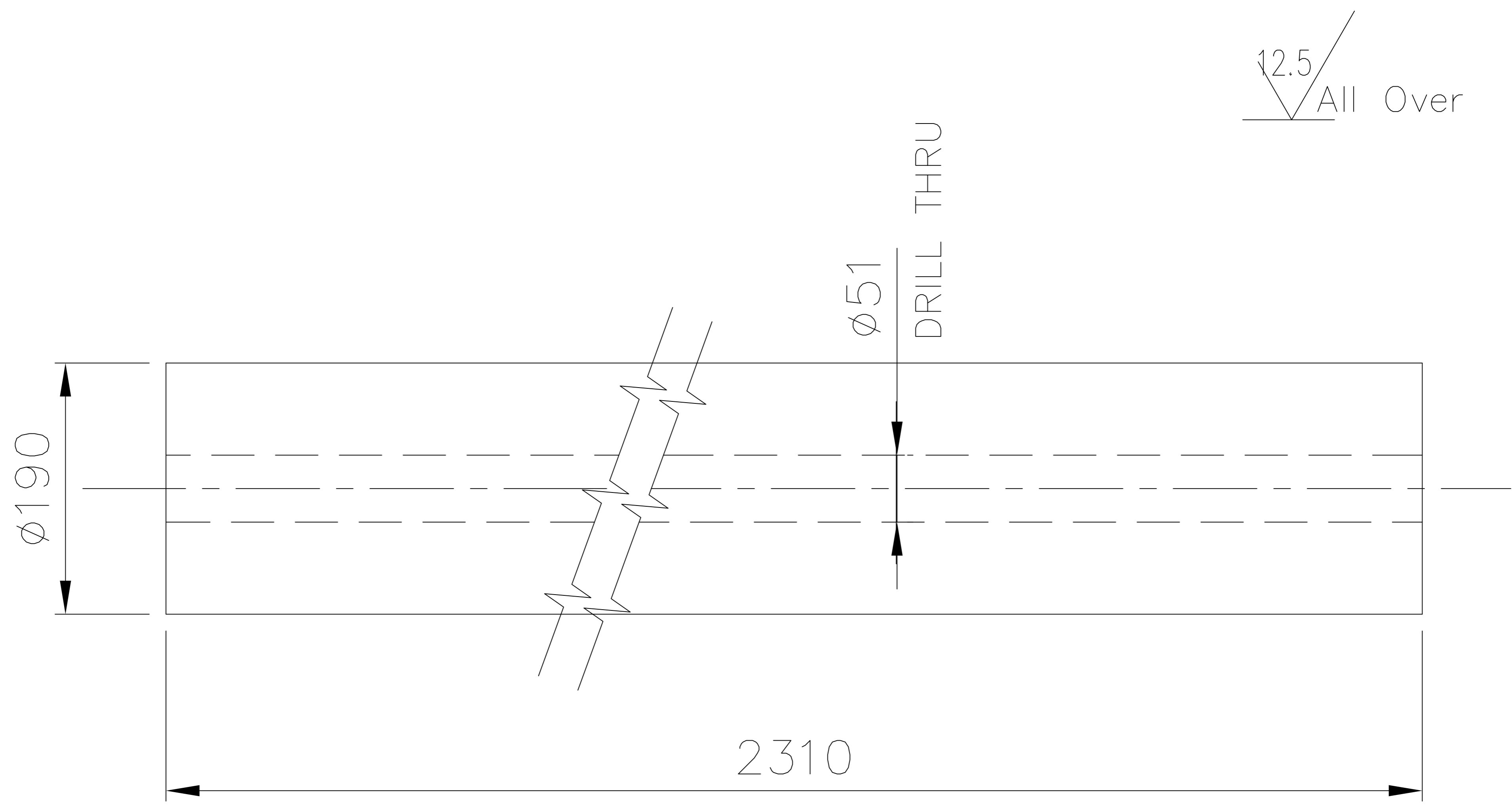

NOTES: -

1. FORGING SHOULD BE AS PER SPECN. AA19332
2. CHAMFER SHARP CORNERS TO R2
3. TOLERANCE ON DIAMETER AND LENGTH ± 1 mm
4. TEST ULTRASONICALLY AS PER SPEC AA 0850118 CAT2

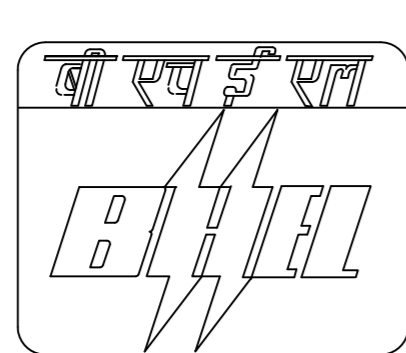
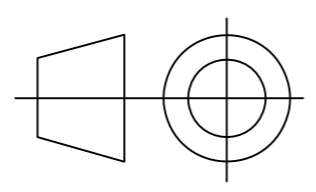
INVENTORY NO.	SIGN. & DATE	REF. DRG. NO.	COMPUTER NO.	FORGING	RV1930132220	474			
					AA 19332	1			
		DESCRIPTION & DRG.NO.	VAR NO.	RAW MATERIAL SIZE OR CASTING DRG.NO. OR FORGING DRG.NO.	MATL. CODE	NET.WT.	GROSS WT		
					MATL. SPECN.	QTY.			
		TYPE OF PRODUCT OR NAME OF CUSTOMER/PROJECT							
REF. TO HY0230261 FOR UNSPECIFIED TOLERANCES.	 BHARAT HEAVY ELECTRICALS LTD. VARANASI				NAME	SIGN	DATE	NO.OF VAR.	
					DRN.	D.BASAK			29.09.03
					CKD.	S.TEWARI			29.09.03
					APPD.	V.KUMAR		29.09.03	
		DEPT. P&D		NTS	WEIGHT(K.G.)	REF.TO ASSY.DRG.	ITEM NO.	NO.OF ITEM	
		CODE			474	16100000364			
		TITLE				DRAWING NO.		REV.	
		R/MCD TRUNION SHAFT				HY-313.02.F		00	
				SHT.NO. 01	NO.OF SHT. 01				

THE INFORMATION ON THIS DOCUMENT IS THE PROPERTY OF BHARAT HEAVY ELECTRICALS LIMITED. IT MUST NOT BE USED DIRECTLY OR INDIRECTLY IN ANY WAY DETRIMENTAL TO THE INTEREST OF THE COMPANY.

REV.	DATE	ALTERED	REV.	DATE	ALTERED	ADDITIONAL INFORMATION
		CHECKED			CHECKED	
		APPROVED			APPROVED	
						DISTRIBUTION OF PRINTS

TOLERANCES UNLESS OTHERWISE SPECIFIED
 CASTING +/- 1.6 mm
 DECIMAL +/- 0.1 mm

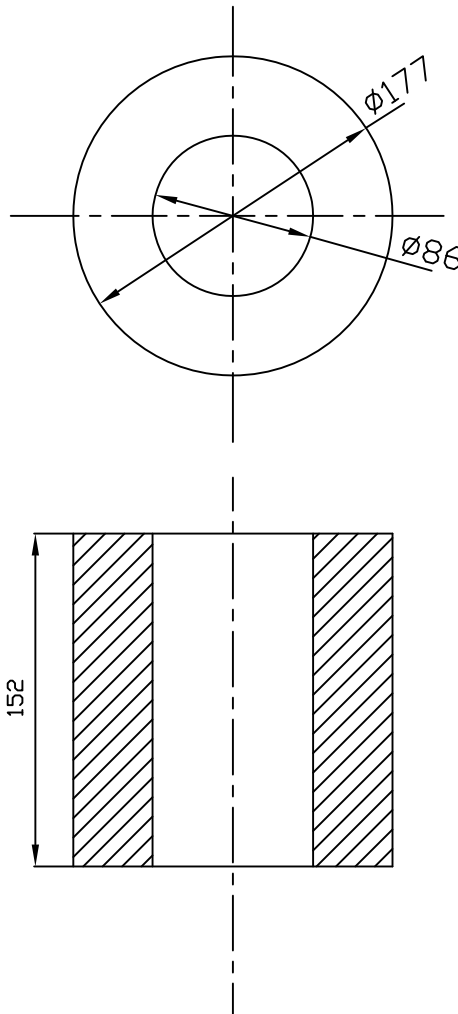

GENERAL DIMENSIONS, LIMITS, FITS & TOLERANCES AS PER PS HY0230261.

NOTE: -

BREAK ALL SHARP CORNERS AND EDGES UNLESS OTHERWISE SPECIFIED. ALL DIMENSIONS ARE IN MM.

	FORGING		RV1930132713	23
			AA19332	
ITEM NO.	DESCRIPTION	DRAWING NO.	MATL. CODE	UNIT WT.
			MATL. SPECN.	QTY

REF. DRG. NO.

COMPUTER FILE NAME
HY-921.A.25.DWG

	NAME	SIGN	DATE	NO. OF VAR.
	DRN. PKP		07.2.09	
	CHD CKP		07.2.09	
	APPD. V.KUMAR		07.2.09	

DEPT. PULV. ENGG CODE 446	GRADE OF TOL. DIM ϕ /M/F		SCALE NTS	WEIGHT(K.G.) 23	REF. TO ASSY. DRG. 26138802157	ITEM NO.	NO. OF ITEMS
---------------------------	-------------------------------	--	-----------	-----------------	--------------------------------	----------	--------------

INVENTORY NO.

TITLE SPRING STUD LOCK NUT KEEPER	CARD CODE /	DRAWING NO. HY-921.15.F	REV. 00
		SHEET NO. 01	NO. OF SHEETS 01



**PLANT PURCHASING
SPECIFICATION
HYDERABAD**

HY 19366

Rev. No.01

Page 1 of 5

Cr-Mn CASE HARDENING STEEL FORGINGS, ANNEALED
(GR : 16 Mn Cr 5G)

1.0 GENERAL :

This specification governs the requirements of alloy case hardening steel forgings of grade 16 Mn Cr 5G in annealed condition

2.0 APPLICATION :

For the manufacture of case hardened components of Steam Trubine, Switchgear Etc.

3.0 CONDITION OF DELIVERY :

The forgings shall be supplied in rough machined and annealed condition.

4.0 COMPLIANCE WITH NATIONAL STANDARDS :

The forgings shall comply with DIN: 17210 - 1986 Gr:16 Mn Cr 5G with the following specific/additional requirements.

5.0 DIMENSIONS AND TOLERANCES :

5.1 Dimensions: The dimensions shall be as specified on the drawings.

5.2 Tolerances:

- a) For finish machined component drawings, the extra allowance of 3 ± 1 mm per surface shall be provided for finish machining at BHEL.
- b) For rough machined Forging drawings necessary finish machining allowance is included in the dimensions. Hence extra allowance is not required. The tolerance shall be ± 1 mm on dimension, unless otherwise specified in the drawing.

6.0 MANUFACTURE :

The steel used shall be manufactured from basic oxygen or electric furnace process. The steel shall be fully killed. Sufficient discard shall be made from the ingot, if ingot is used as forging stock, to ensure freedom from piping, segregation and other harmful defects.

Revisions: 1) Revised as per DIN:17210-1986. 2) End Quench Test added.			Issued : STANDARDS ENGINEERING DEPARTMENT		
Rev.No. 01	Rev.Date SEP.93	REVISED: MATLS.ENGG	Prepared: MATLS ENGG.	Approved: AGM (ENGG)	Date: JULY, .82.



The amount of hot working shall be sufficient to ensure uniform working throughout the cross-section.

Reduction ratio shall be minimum 3:1 for ingot and 1.5:1 for rolled/forged stock.

7.0 HEAT TREATMENT : (For information only).

7.1 The forgings shall be soft annealed at 650-700⁰C and furnace cooled..

7.2 The recommended heat-treatment for sample test pieces shall be as follow:

- a) Blank carburizing at 880-980⁰C.
- b) Hardening at 860-900⁰C and quenching in oil or water
- c) Tempering at 150-200⁰ C followed by air cooling.

Heat treatment cycle followed shall be reported in test certificate.

8.0 FINISH :

Surface finish of the rough machined forgings shall be 6.3 microns (r.m.s) wherever ultrasonic test is called for and 12.5 microns (r.m.s) for other surfaces

9.0 FREEDOM FROM DEFECTS :

The Forgings shall be free from cracks, flakes, seams, segregation and other defects which may affect the utility of the forgings.

10.0 CHEMICAL COMPOSITION :

The chemical analysis of the steel shall be as follows .:

Element		C	Si	Mn	Cr	S	P
Melt Analysis	%Min	0.14	-	1.00	0.80	-	-
	%Max	0.19	0.40	1.30	1.10	0.035	0.035
Permissible Variation In product Analysis		±0.02	+0.03	±0.05	±0.05	+0.005	+0.005



**PLANT PURCHASING
SPECIFICATION
HYDERABAD**

HY 19366

Rev. No.01

Page 3 of 5

11.0 END QUENCH TEST :

The raw material used for forging of the components shall have the following limiting values of Rockwell C hardness as determined by the end Quench Test. The values plotted on the graph shall be submitted along with the Test Certificate. Hardening temperature for end quench test shall be 870⁰ C.

Hardness, in HRC

At a distance from the quenched end, in mm, of

	1	2	3	4	5	6	7	8	9	10	11	13	15
Max	47	46	44	41	37	35	44	33	31	30	29	28	27
Min	39	35	31	28	24	22	20	-	-	-	-	-	-

12.0 TEST SAMPLES:

Test samples shall be taken per melt and shall be blank carburised, hardened & tempered as per clause 7.2 to achieve the mechanical properties given in clause 13.1 (Forgings are to be supplied in soft annealed condition only)

13.0 MECHANICAL PROPERTIES :

The mechanical properties of blank carburized hardened and tempered test bar of ruling section 30 mm shall be as follows:

13.1 Tensile:

Tensile strength N/mm ² (Kgf/mm ²)	0.2% Proof Stress, min. N/mm ² (Kgf/mm ²)	Elongation %min (l=5d)
780-1080 (80-110)	590 (60)	10

13.2 Hardness: 5% of the forgings or min. two nos. in annealed condition, shall be tested for Brinell Hardness and the value shall be 207 BHN max.

14.0 NON-DESTRUCTIVE TEST :

If specified in the drawing, the following tests shall be conducted.



14.1 Magnetic particle Test: Shall be performed as per ASTM 'A' 275 and acceptance criteria shall be as follows:

- i) Cracks and porosity are not acceptable
- ii) Presence of the following individual inclusions on the surfaces are acceptable. Maximum eight numbers having a length of Max. 1mm or 5 inclusions of max. 3mm length or one inclusion of 5mm max. length concentrated in the area 25 cm . sq.

14.2 Ultrasonic Test: shall be performed as per ASTM: A 388 (BHEL Standard AA 0850118) and following shall be unacceptable defects.

- i) Cracks, flakes, seams and laps.
- ii) Defects giving indications larger than that from a 4 mm diameter equivalent flaw.
- iii) Groups of defects with maximum indication less than that from a 4mm diameter equivalent flaw which cannot be separated at testing sensitivity if the back echo is reduced to less than 50%
- iv) Defects giving indication of 2 to 4 mm diameter equivalent flaw separated by a distance less than four times the size of the larger of the adjacent flaws.

The above acceptance criteria is equivalent to level 2 of AA 0850118.

15.0 INSPECTION AT SUPPLIER'S WORKS :

BHEL representative shall have free entry and access to all areas where the manufacture of the forging is carried out. All reasonable facilities shall be extended to him including labour where ever necessary, free of charge Sufficient advance intimation shall be given to the representative to witness the various processes, tests etc. Identification of test coupons & forgings and excution of various tests shall be done in his presence.

16.0 TEST CERTIFICATE :

16.1 The suppliers shall furnish five copies of the test certificate (in English) to BHEL with the following details.

- a) BHEL Specification No. Hy 19366. Rev.01
- b) Material Grade : 16 Mn Cr 5G
- c) BHEL Order No:
- d) Item Description.
- e) Drawing NO:
- f) Supplier's Name.
- g) Melt No:
- h) Serial NO. of the forging.



**PLANT PURCHASING
SPECIFICATION
HYDERABAD**

HY 19366

Rev. No.01

PAGE 5 of 5

- i) Heat Treatment details for forgings and Test Specimen.
- j) Result of Chemical Analysis, Hardness test, Tensile tests for heat treated samples stipulated in this specification and any non-destructive tests as specified in the drawing/purchase order.
- k) End quench test report.

16.2 The test certificates shall be attested by the Chief of Inspection/Chief Metallurgist of the supplier and also by BHEL representative.

17.0 MARKING AND PACKING :

17.1 Marking: The following details shall be punched clearly on each forging and the same shall be encircled by paint:

- a) BHEL Specification No. Hy 19366. Rev.01
- b) Material Grade : 16 Mn Cr 5G
- c) BHEL Order No.
- d) Melt No.
- e) Serial No. of the forging
- f) Drawing No.
- g) BHEL Inspectors Stamp.

17.2 Packing: The forgings shall be suitably packed & prevented from damage and corrosion during transit. In the case of overseas supplies, the packing shall be seaworthy.

18.0 REJECTION AND REPLACEMENT :

In the event of the forging proving defective in the course of further processing at BHEL, the same shall be rejected notwithstanding any previous acceptance.

The supplier shall replace the rejected forging at his own cost and the rejected forging shall be returned after all the commercial conditions are satisfied.



**PLANT STANDARD
HYDERABAD**

HY0230261

REV. NO. 03

PAGE 1 OF 2

LIST OF APPLICABLE STANDARDS ON LIMITS, FITS AND TOLERANCES

1.0 SCOPE:

The standard covers the list of applicable standards on Limits, Fits and Tolerances. These standards are applicable unless or otherwise specified.

2.0 LIST OF APPLICABLE STANDARDS:

SL. NO.	STANDARD NO.	TITLE
1.	AA0230201 -	Limits and Fits (Tolerance grade, Position and Class).
2.	AA0230202 -	Limits and sizes for commercial bolts and nuts.
3.	AA0230204 -	Guide for selection of Fits.
4.	AA0230206 -	Standard limits for Shafts (upto 500 mm).
5.	AA0230207 -	Standard limits for Shafts (above 500 mm and upto 3150 mm).
6.	AA0230208 -	Allowable deviations for dimensions without specified tolerances (linear and angular).
7.	AA0230402 -	Permissible deviations for untoleranced dimensions of castings.
8.	AA0230403 -	Tolerancing system ISO Metric Screw Threads
9.	AA0621101 -	Tolerances and Machining allowances for Flame cutting.
10.	AA0621104 -	General tolerances for welding constructions for length and angles.
11.	AA0621105 -	General tolerances for welded structures – form and position.

Revisions:

Issued :

Withdrawn standards deleted (2 Nos.).

STANDARDS ENGINEERING DEPARTMENT

Rev. No. 03

Amd. No.

Reaffirmed:

**Prepared:
MANAGER
(STDS. ENGG.)**

Approved:

AGM (E&CC)

Date of 1st issue:

Dt. OCT. 06

Dt.

Year:

MAY, 1992

HY0230261

REV. NO. 03

PAGE 2 OF 2

**PLANT STANDARD
HYDERABAD**



NOTE:

1) AA 023 02 08

Medium class of deviation is applicable, if the same is not mentioned on the drgs./specs.

2) AA 023 04 02

Tolerance class 5 is applicable, if the same is not mentioned on the drgs./specs.

3) AA 062 11 04

Accuracy class A is applicable if the same is not mentioned on the drgs.

4) AA 062 11 05

Accuracy class E is applicable, if the same is not applicable on drgs.

Copyright and Confidential

The information on this document is the property of BHARAT HEAVY ELECTRICALS LIMITED.
It must not be used directly or indirectly in any way detrimental to the interest of the company.

	BHEL, HERP, VARANASI PMD Category View		Dt. 25/11/2023
Category ID :	SA01	Rev Detail:	2 dt 30/10/2023
Category Description :	RAW MATERIAL LIKE INGOT/BILLET / BLOOM ETC. SOURCES FOR CARBON STEEL FORGINGS		
Specification :	AA19331/19332/19333	Cat Type :	BOILER
Main Category :	FORGING		
PMD Remark/Basis of PMD:	HERP BASED PMD		
PMD Status :	PMD is ACTIVE		

Vendors in Category								MSE Status as on Date	
Sl	Ven ID	Common Supplier Code	VendorName	CITY	Nature of Business	VPR	HOLD	Relative Vendor Code(s)	MSE
1	6693	I0013970	M/s BANSAL ALLOYS AND METALS PVT. LTD	GOBINDGARH	MANUFACTURER				
2	181	I0000185	M/s BHEL CFFP HARIDWAR	HARIDWAR	MANUFACTURER				
3	4400	I0014055	M/S CHAUDHRY STEELS P LTD.	GHAZIABAD	MANUFACTURER				
4	5135	I0001453	M/S KALYANI CARPENTER SPECIAL STEEL LTD	PUNE	MANUFACTURER				
5	6909		M/s KESRI ALLOYS PRIVATE LIMITED	ALWAR	MANUFACTURER				Medium 30/04/2024
6	387	I0007176	M/S MAHINDRA SANYO SPECIAL STEEL PRIVATE LIMITED	RAIGAD	MANUFACTURER				
7	6692	I0003241	M/s RINL VSP	Visakhapatnam	MANUFACTURER				
8	242	I0000670	M/S STAR WIRE (INDIA) LIMITED	BALLABGARH	MANUFACTURER				
9	2571	I0000443	M/S STEEL AUTHORITY OF INDIA LIMITED	NEW DELHI	MANUFACTURER				
10	5139	I0003923	M/S SUNFLAG IRON & STEEL CO.LTD	BHANDARA	MANUFACTURER				
11	3828	I0002973	M/S VIMAL ALLOYS PVT. LTD.	MANDI GOBINDGARH	MANUFACTURER				Medium 31/12/2023

PMD MATERIAL EXCLUSION LIST			
MATERIAL CODE	DESCRIPTION	PMD CATEGORY	VENDOR NAME