

# TENDER ENQUIRY NO.: X/6620/2024/0232/B/1

## SUB:- TERMS & CONDITIONS FOR DRILLING OF MAIN TUBE PLATE

### NIT-Notice Inviting Tender

Salient Details of Notice Inviting Tender (NIT)		
Sl. No.	Issue	Description
1.	Item details	As per Enquiry Annexure X/6620/2024/0232/B/1
2.	Issue of Tender Documents	From BHEL eProcurement website <a href="https://eprocurebhel.co.in/nicgep/app">https://eprocurebhel.co.in/nicgep/app</a> (Tender documents will be available for downloading from BHEL e-Procurement website till due date of submission)
3.	Due Date Of Offer Submission	<b>Date: 05-07-2024 Time: 13:45 hrs</b> <b><a href="https://eprocurebhel.co.in/nicgep/app">https://eprocurebhel.co.in/nicgep/app</a></b> <b>Offer to be submitted in online only through e-procurement Portal.</b> (Bidders are requested to visit website to view corrigendum/ addenda/ amendments/ extension/ modification etc. before submitting offer).
4.	Opening of Tender (Techno-Commercial Bid)	<b>Date: 05-07-2024 Time: 14.00 Hrs</b> <b>Notes:</b> <b><i>This tender being an e-tender, it shall be opened online only through the E-Procurement Portal. Participating bidders may witness the Opening online only.</i></b>
5.	Cost of Tender	INR 2000/- (If hard copy of tender document is required from BHEL otherwise not applicable.)
6.	EMD (Earnest Money Deposit)	<b>Not Applicable</b>
7.	Schedule Of Pre-Bid Discussion	Not Applicable
8.	Integrity Pact & Details of Independent External Monitor (IEM)	Not Applicable
9.	Latest Updates	Latest updates on the important dates, Amendments, Correspondences, Corrigenda, Clarifications, Changes, Errata, Modifications, Revisions, etc to Tender Specifications will be hosted in BHEL e-tender portal <a href="https://eprocurebhel.co.in/nicgep/app">https://eprocurebhel.co.in/nicgep/app</a> and not in the newspapers. Bidders to keep themselves updated with all such information

Please submit your offer only for the above requirement subject to our **GENERAL INSTRUCTIONS AND STANDARD TERMS & CONDITIONS (Version: May-2024, Rev.07)**. Please visit our website [www.hwr.bhel.com](http://www.hwr.bhel.com) for General Instructions and Standard Terms & Conditions (GISTC) for Tender Enquiries. All the bidders/vendors must ensure compliance of these GISTC. GISTC can also be referred by login to B2B Portal for Registered Vendors.

**Tender Fee & EMD (If Applicable)** will be submitted in the form of Pay Order / Demand Draft (drawn in favor of 'BHEL HARIDWAR') only. It may be noted that if hard copy of any tender document is required, then the same may be collected against copy of Pay Order / Demand Draft of requisite tender fee (while original to be submitted with Part-I).

# TENDER ENQUIRY NO.: X/6620/2024/0232/B/1

For E-Payment, the RTGS details are mentioned as below:

Bank Details	SWIFT Details of bank
STATE BANK OF INDIA RANIPUR BRANCH, OPP: BHEL MAIN GATE, SECTOR-5, RANIPUR, HARIDWAR, UTTRAKHAND, INDIA PIN CODE : 249403	SWIFT NO.: SBININBB225 CC ACCOUNT NO.: 10667995458 IFSC CODE: SBIN0000586

As per notification reference no. NSIC/HO/GP/15(4)/2013-14 dated 07.07.2013 Micro & Small Enterprises (MSEs) are not required to submit Tender fees. A Valid MSE/MSME certificate such as Udyog Aadhar (UAN)/Udyam Certificate/NSIC/EM (Part-II) etc. issued from competent authority shall be submitted in support of Micro & Small Enterprises (MSEs).

“As per the OM No. F. No. 1(2)(1)/2016-MA dated. 09.02.2017 issued from the Office of Development Commissioner (Micro, Small & Medium Enterprises), “Traders and agents should not be allowed to avail the benefits extended under the PP Policy.”

Central / State – PSUs / Government departments are exempted from submission of EMD subject to approval by BHEL management.

BHEL will forfeit the EMD if, the successful bidder / vendor refuses to honor the order after award of the same on him and / or withdraws his bid and / or unilaterally changes the offer and / or any of its terms & conditions within the validity period.

## **INSTRUCTIONS TO BIDDERS FOR SUBMITTING OFFER**

**TECHNICAL QUALIFICATION:** Technical Requirement, Pre-Qualifying Requirements/PQR to be submitted. It is the mandatory requirement. Offer of vendors not meeting these requirements may not be considered.

## **ESSENTIAL INSTRUCTIONS**

The tender shall be **submitted in two parts** in separate cover as described below on or before the due date:

### **Part I (Cover-1) - Containing the following:**

1. Techno -Commercial Bid
2. Tender Fee & EMD (Earnest Money Deposit) Or Valid certificate/Document towards exemption of Tender fee and/or EMD (applicable for Micro and small Enterprises, Central / State – PSUs / Government departments, PMD vendors etc.)

### **Part II (Cover-2) - Containing Price Bid in attached Format**

Bidders against tender will necessarily have to obtain class – III DSCs. Procedure for application available on [www.bhel.com](http://www.bhel.com).

## **E-Procurement Portal Inputs**

## **TENDER ENQUIRY NO.: X/6620/2024/0232/B/1**

**Procedure for Submission of Offer for E – Tender-**Procedure for Submission of Tender is available in the “Bidder Manual for BHEL Bidders” at E-tender portal <https://eprocurebhel.co.in/nicgep/app> . Terms and conditions mentioned therein shall form integral part of the NIT and bidders shall abide by the same.

### **Hardware and Software requirements for participating in e-tender**

Please refer the website for the minimum system requirements and setting document for Bidders under the link: <https://eprocurebhel.co.in/nicgep/app>

### **Digital Signature**

To know the procedure for obtaining Digital Signature Certificate (DSC), suppliers who are not having the DSC are advised to visit our website [http://www.bhel.com/home.php/Tender Notifications/Sample Checklist](http://www.bhel.com/home.php/Tender%20Notifications/Sample%20Checklist).

### **NIC portal Helpdesk Contacts**

For any technical related queries please call at 24 x 7 Help Desk Number

0120-4001 002

0120-4200 462

0120-4001 005

0120-6277 787

International bidders are requested to prefix 91 as country code

### Email Support

Address: A) For any Issues or Clarifications relating to the published tenders, bidders are requested to contact the respective Tender Inviting Authority Technical - [support-eproc@nic.in](mailto:support-eproc@nic.in)

### **Note**

Offers/tenders submitted in the E-tender portal shall only be considered for further evaluation. Offers sent by FAX / E-mail / any mode other than E-tender would not be entertained.

The Tenderers must submit their Tenders, as detailed below:

**SPECIAL NOTE:** All documents to be submitted should be uploaded in respective places in the E-Tender portal as per the list mentioned given in this NIT. BHEL shall not be responsible for incomplete documents.

**TERMS & CONDITIONS FOR DRILLING OF MAIN TUBE PLATE**

Online offers are invited through e-procurement portal <https://eprocurebhel.co.in/nicgep/app> from suppliers for the supply of the items.

1. **SCOPE OF WORK:** -This enquiry is for Drilling of MAIN TUBE PLATE as per following details with BHEL material with duly Pilot Hole marked as per layout indicated in respective Drawings.:

Sl. No.	Item Description	Drg. No.	Qty.	Holes /Plate
1	MAIN TUBE PLATE	2160187005800	08 Nos.	13200

**Remark-**

1. Drawing T.R.'S and instructions to be strictly followed.
  - Quality plan (if any) to be followed for Material induction and CHP.
  - Customer's seal (if Any on supplied Material) to be transferred.
  - Copies of the relevant certificates to be supplied to the receiving shop.
  - Aesthetic appearance shall also be ensured and inspected before delivery to BHEL.
  - CHP Clearance may be obtained from NTPC/LLOYD/RITES/NPC at party's end.
  - The rate (s) should be quoted in **Rupees/Hole**
  
2. **VALIDITY:** -  
The validity of offers by vendors should be at least for a period of **90 days for this enquiry from the date of enquiry opening.**
  
3. **SUBMISSION OF OFFERS:** -  
Open tender is hoisted on the <https://eprocurebhel.co.in/nicgep/app> and no hard copy of document is provided by BHEL, no tender fee shall be insisted upon from the bidders.  
The offer is to be submitted in **two parts** on NIC portal only on website:  
<https://eprocurebhel.co.in/nicgep/app>  
BHEL reserves the right to reject any or all the tenders either in full or part thereof without assigning any reasons thereof.
  
4. **DELIVERY:** -  
F.O.R.: HEEP, BHEL Haridwar.
  
5. **DELIVERY SCHEDULE:** - Within **40** Days from last BHEL material sent

**Note:** - In case the delivery offered by any vendor is more than above mentioned Delivery days from Last Material Sent from BHEL to Vendor, loading shall be done @ 0.5% per week on the rate quoted by the vendor.

6. **Bank Guarantee/Indemnity Bond:** - 10 % Bank Guarantee and 90% Indemnity Bond for the value of materials to be given by vendor for free issue materials. Material value will be calculated on PPMIV/Challan value basis. On intimation from BHEL regarding BG & IB, the same shall be provided by the vendor (s) within 15 Days. If suitable BG and IB are not submitted to BHEL within 15 days of intimation, then the amount of days delayed beyond 15 days after intimation will be deducted from delivery days of that item and consequent PO amendment will be issued.

**For Example:** If intimation for requirement of BG & IB of an item of a PO is given to vendor on 01.04.2023 from BHEL, then vendor should mandatorily provide required BG and IB by 15.04.2023. In case, the vendor provides the same by 30.04.2023, then the difference of 15 days (between 30.04.2023 & 15.04.2023) will be deducted from delivery days of that item and consequent PO amendment will be issued.

7. **INSPECTION:** -

- The inspection will be carried out by BHEL/BHEL nominated inspection agency at Party's works. All facilities and equipment's, calibrated instruments and standard gauges required for inspection shall be provided by the vendor during inspection. In some cases, inspection by customer's representatives like NTPC/RITES etc. (excluding NPC) may also be carried out at Party's works and CHP clearance may be obtained. No additional charges will be paid on this account.
- The party is to follow system for material control, if applicable, as per BHEL Quality Control system.
- Identification marks shall be punched on each item by the vendor i.e. Purchase Order No., Drawing No., IR No. etc.
- Aesthetic appearance is to be maintained as per drg. requirement.

8. **GUARANTEE CERTIFICATE:** -

The vendor shall warrant that the supplied fabricated assemblies/items comply fully with the drawings and other technical conditions. If the fabrications/items are found defective owing to faulty workmanship/incomplete work within a period of **eighteen (18) months** from the date of dispatch, the vendor shall make good of it/replace the same free of cost. Alternatively, the rework/replacement charges will be recovered.

9. **PAYMENT TERMS:** -

- 9.1 90% after acceptance & final clearance of SRIV. 10% after FTS and final account of material.
- 9.2 No packing and forwarding charges will be paid extra.
- 9.3 In case of rejection, total cost of material will be recovered in case of BHEL Material and no labor cost will be paid.
- 9.4 For MSEs (covered under MSME Act) which are registered and periodically renewed with BHEL, the payment will be made within 45 days or as prescribed in the relevant act.
- 9.5 Detailed terms at clause 10.0 of GISTC Rev. 07, May 2024.

10. **LD CLAUSE:** -

@ 0.5% per week subject to max 10% for the delayed portion of supply. The entry date mentioned by CISF on the challan at BHEL material gate will be taken as material receipt date.

**11. GST: -**

As per clause 11.0 of GISTC (attached). At present GST rate applicable for this enquiry is 12 %. However, it is subjected to change as per latest Govt. guidelines/circulars (if any).

**12. Quality Requirement: -**

Inspection by BHEL/BHEL nominated inspection agency and customer/customer nominated inspection agency as per drawing and quality plan requirements (Manufacturing Quality plan no. 2.01.02 rev 01, dated 03.02.2020 (DOC NO 4540-001-110-QVM-Q-201) is attached.

Sub-contractor to provide a summary sheet of documents/TCs provided for correlation.

Sub-contractor to mention relevant QP clauses on all TCs/ reports for every lot.

**13. Reverse Auction: -**

“BHEL shall be resorting to Reverse Auction (RA) (Guidelines as available on [www.bhel.com](http://www.bhel.com)) for this tender. RA shall be conducted among the techno-commercially qualified bidders.

Price bids of all techno-commercially qualified bidders shall be opened and same shall be considered for RA. In case any bidder(s) do(es) not participate in online Reverse Auction, their sealed envelope price bid along with applicable loading, if any, shall be considered for ranking.”

For detailed terms and conditions of RA guidelines, kindly refer [www.bhel.com](http://www.bhel.com).

**14. EVALUATION OF BIDS:**

**All vendors will be assessed on total cost to BHEL basis that includes freight, taxes, ITC etc. Item wise evaluation will be applicable for this enquiry.**

In the course of evaluation, if more than one bidder happens to occupy L1 status, effective L1 bidder shall be decided by toss/draw of lots, in the presence of respective L1 bidder(s) or their representative(s).

Ranking will be done accordingly. BHEL's decision in such situation shall be final and binding.

**15. Transportation: -**

Transportation of raw material (PPMIV material) will be in scope of VENDOR. vendor will collect the material from bhel heap haridwar and will send it back to bhel shop in heap haridwar after completion of work/QC clearance.

**16. SCRAP: -**

- Generated scrap is to be retained by the sub-contractor. This scrap is not chargeable. The scrap rate will be calculated based on the monthly market scrap price Published in MSTC Bulletin/any other document under category of scrap MELTING SCRAP/any other similar category. The calculated monthly price for charging scrap will be rounded off to two decimal places of Rupee. GST charges on scrap shall also be applicable.
- BHEL would recover the amount of GST and Trade Tax as applicable from the sub-contractor's account in lieu of scrap retained by them. The difference between raw material weight and finalized weight shall be considered for the calculation of scrap generation.

**17. RECTIFICATION: -**

Any defect (noticed at Shop) arising out of the fabrication/machining/drilling/forming done by the Sub-Contractor, will have to be rectified or items replaced by the sub-contractor within 10 days at their own cost. Otherwise BHEL will be free to take necessary action as deemed fit and consequence/cost of the same will be to subcontractors-account.

**18. Breach of contract: -**

In case of breach of contract, wherever the value of security instruments like performance bank guarantee available with BHEL against the said contract is at least 10% of the contract value, the same be encashed. In case the value of the security instruments available is less than 10% of the contract value, the balance amount be recovered from other financial remedies (i.e. available bills of the contractor, retention amount, etc. with BHEL) or legal remedies be pursued. The balance scope shall be got done independently without Risk & Cost of the failed supplier/ contractor.

Further, levy of liquidated damages, debarment, termination, de-scoping, short-closure, etc., shall be applied as per provisions of the contract.

Accordingly, the tender/ contract terms shall be structured in such a way to ensure recovery of an amount equivalent to 10% of the contract value in case of breach of contract.

**19. Distribution of load:-**

Enquiry has been issued with following terms & conditions :

Vendor has to quote the rate in Rs. **per Hole basis**.

19.1 In view of shop manufacturing capacity constraints & to cope up with the increased Drilling/machining load, it is proposed to distribute load between 02 (two) BHEL approved subcontractors or as the case may be as per Annexure-A. Distribution of MAIN TUBE PLATE will be in the ratio of 5:3 among L1: L2 Vendors. Load distribution shall be done after counter offering finalized L-1 rate to L-2 vendors.

19.2 If L-2 vendor does not accept the counter offer rate then subsequent vendors (L-3 to L-n (n is number of vendors)) shall be counter offered the finalized L-1 rate in sequence till we get vendors who accept L1 rates.

If none of the vendor participating in RA accepts the counter offer rate, then L-1 vendor shall be approached for quantity discount (for that additional quantities) before ordering whole quantity.

19.3 In case of any ambiguity, BHEL HWR decision will be final.

**20. GENERAL INSTRUCTIONS: -**

**20.1** No further sub-contracting to third party or sister concern by the sub-contractor is allowed Without prior permission of BHEL. If found guilty, will be debarred.

**20.2** BHEL reserves the right to suspend/cancel the PO/Enquiry unilaterally without any financial repercussions, if Sub-contractor's performance is not found to be satisfactory.

- 20.2.1** BHEL reserves the right to revise the drawing after placement of purchase order. The prices in the purchase order will be amended according to revised drawing.
- 20.3** Please refer general instructions and standard terms & conditions (GISTC) for bidding against tender enquiry (**Version: May-2024, Rev.07**). the bidder/vendor must ensure compliance of these GISTC (**Version: May-2024, Rev.07**). Please refer <https://hwr.bhel.com>.
- 20.4** MSE suppliers are exempted for submission of EMD & Tender Fee.
- 20.5** Central / State – PSUs / Government departments are exempted from submission of EMD subject to approval by BHEL management.
- 20.6** Documents submitted with the offer/bid by the bidder should be signed and stamped in each page by authorized representative of the bidder.
- 20.6.1 PQR** required documents is to be submitted along with the Techno- Commercial offer (PART-I).  
Note :- Offer shall be entertained only after submission of duly filled, signed and stamped PQR and relevant documents. Offers of the vendor(s) not submitting this may be ignored.
- 20.7** Vendor Contract clause regarding GST ITC and provision for E-invoices:  
(i) E-invoicing under GST is being implemented w.e.f. 01.04.2022 for all the taxable persons having turnover more than Rs. 5 Cr. It has been specified by the Govt. that it is mandatory to mention a valid unique Invoice Reference No. (IRN) and QR code as generated from Govt. portal on a Tax Invoice. Based on such information, GST ITC as claimed by BHEL in GST Returns shall be matched with the corresponding details uploaded by supplier in E-invoicing System.  
(ii) In case the vendor /contractor delays or fails to provide all the documents as per the Purchase order / Work Order at the time of submitting Tax invoice to BHEL, any subsequent financial loss to BHEL on account of vendor/contractor shall be to vendor's / contractor's account. BHEL has further right to take necessary steps to protect its interest at the time of release of payment. This further requires inclusion of IRN and QR code on tax invoice as announced by Govt. of India w.e.f. 01.10.2020.
- 20.8** In case of ordering against the tender, vendor should submit their invoices against goods and services immediately after supply of goods & services but not later than 30 days from the invoice date. In case of delay, consequential losses like loss of input credit and non-availability of concessional forms etc. shall be to the vendor account.
- 20.9** The bidders against open tender will necessarily have to obtain class – III DSCs (Digital signature). Procedure for application is available on [hwr.bhel.com](https://hwr.bhel.com).
- 20.10** Following MSE conditions shall be followed: -  
MSE Suppliers can avail the intended benefits only if they submit along with the offer, attested copies of UDYAM Certificate.  
Detailed MSE conditions is at clause no. 23.0 of GISTC Rev. 07, May 2024.  
\* Govt. guidelines will supersede all clauses of this tender for MSE benefits to vendor(s).
- 20.11** BHEL may load maximum penalty under LD Clause, to the extent the same is not agreed by the vendor, for the purpose of comparative statement. Where deliveries quoted by the vendor are not suiting, BHEL may also ignore the offer of the vendor.

**21. Conflict of Interest:** A bidder shall not have conflict of interest with other bidders. Such conflict of interest can lead to anti-competitive practices to the detriment of Procuring Entity's interests. The bidder, found to have a conflict of interest shall be disqualified. A bidder may be considered to have a conflict of interest with one or more parties in this bidding process, if:

- a) they have controlling partner (s) in common; · or
- b) they receive or have received any direct or indirect subsidy/ financial

stake from any of them; or

c) they have the same legal representative/agent for purposes of this bid; or

d) they have relationship with each other, directly or through common third parties, that puts them in a position to have access to information about or influence on the bid of another Bidder, · or

e) Bidder participates in more than one bid in this bidding process.

Participation by a Bidder in more than one Bid will result in the disqualification of all bids in which the parties are involved. However, this does not limit the inclusion of the components/ sub-assembly/ Assemblies from. one bidding manufacturer in more than one bid; or

f) In cases of agents quoting in offshore procurements, on behalf of their principal manufacturers, one agent cannot represent two manufacturers or quote on their behalf in a particular tender enquiry. One manufacturer can also authorize only one agent/dealer. There can be only one bid from the following:

1. The principal manufacturer directly or through one Indian agent on his behalf; and

2. Indian/foreign agent on behalf of only one principal, · or

g) A Bidder or any of its affiliates participated as a consultant in the preparation of the design or technical specifications of the contract that is the subject of the Bid, · or

h) In case of a holding company having more than one independently manufacturing units, or more than one unit having common business ownership/management, only one unit should quote. Similar restrictions would apply to closely related sister companies. Bidders must proactively declare such sister/ common business/ management units in same/ similar line of business. "

- **Against vendor's replies, BHEL reserves the right to ask for more information/ documents / clarifications. Vendor's offer shall not be considered if vendor fails to furnish the document / information / clarifications as mentioned above or doesn't meet the acceptance criteria. Time period for technical/commercial clarification is 3 days.**
- Amendments/Corrigendum, if any, will be hosted on designated web site/ GePNIC Portal only. Other terms and conditions will be as per tender documents. Any vendor who is under hold (for the item)/ delisted/ banned with BHEL on date of opening of Part – 1 will not be allowed to quote for this tender. In case their offer is received, it may be out rightly rejected.
- the Tender Documents, Drawings, P.O copy etc. shall be sent by e-mails and shall not be sent in hard copies. Vendors to kindly note that the details sent by e-mail shall be considered for delivery against the finalized contract(s)/ P. O's placed.
- **\*\*OFFERS SHALL BE ADMITTED THROUGH GePNIC PORTAL <https://eprocurebhel.co.in/nicgep/app> ONLY**

**Annexure - A****DRILLING OF MAIN TUBE PLATE**

OpenTender Enquiry No.: X/6620/2024/0232/B/1

Sl. No.	Item Description	Drg. No.	Total Qty (nos)	Holes /Plate	Load Distribution of MAIN TUBE PLATE	Rates in Rs./Hole Tick the correct option
1	MAIN TUBE PLATE	2160187005800	08	13200	L1- 5 L2- 3	Quoted/Not Quoted

Authorised Signature:

(with date &amp; seal of company)

Name of Supplier: -

**Annexure - B**

**Make In India Certificate**

Certificate In line with Government Public Procurement Order No. P-45021/2/2017-BE-II dt. 15.06.2017 & P-45021/2/2017-PP (BE-II) dated 28.05.2018, we hereby certify that we M/s

\_\_\_\_\_ (supplier name) are local supplier meeting the requirement of minimum local content (50%) as defined in above orders for the material against Enquiry No. \_\_\_

X/6620/2024/0232/B/1 Details of location at which local value addition will be made is as follows:

\_\_\_\_\_

\_\_\_\_\_ We also understand, false declarations will be in breach of the Code of Integrity under Rule 175(1)(i)(h) of the General Financial Rules for which a bidder or its successors can be debarred for up to two years as per Rule 151 (iii) of the General Financial Rules along with such other actions as may be permissible under law.

**TERMS AND CONDITIONS FOR Enquiry No.X/6620/2024/0232/B/1**

SL.	TERMS	VENDOR'S ACCEPTANCE/REMARKS
1	Scope of Work: - Drilling of Main Tube Plate as per Drawing/Standard, QP and Technical requirements (as per clause 1 of terms & conditions).	
2	Quotation is valid for a minimum period of 90 days from date of opening of enquiry. (as per clause no. 2.0 of Terms and Conditions)	
3	Submission of offers (as per clause no. 3.0 of Terms and Conditions)	
4	Quoted rates are on F.O.R. sub-contract store, HEEP, Haridwar basis.(as per clause no. 4.0 of Terms and Conditions)	
5	Delivery schedule <b>40 Days</b> as per clause 5.0 of T& C of enquiry.	
6	Bank Guarantee/Indemnity Bond: 10 % BG & 90% Indemnity bond (as per clause 6.0 of T& C of enquiry)	
7	Inspection shall be done (as per clause no. 7.0 of Terms and Conditions of Enquiry)	
8	Guarantee Certificate shall be valid for <b>18 months</b> . (as per clause no. 8.0 of Terms and Conditions of Enquiry)	
9	90% after acceptance & final clearance of SRIV.10% after FTS and final accountal of material (as per clause no. 9.0 of Terms and Conditions of Enquiry).	
10	LD clause is applicable@0.5% per week or part thereof with a maximum limit of 10% of the delayed portion of the PO (as per clause no. 10.0 of Terms and Conditions of Enquiry).	
11	GST 12% shall be applicable against documentary proof. Input Tax Credit shall be applicable and BHEL can claim benefit (as per clause no. 11.0 of Terms and Conditions of Enquiry).	
12	Quality Requirements (as per clause no. 12.0 of Terms and Conditions of Enquiry).	
13	We accept Reverse Auction(RA) clause as per standard policy of BHEL (as per clause no. 13.0 of Terms and Conditions of Enquiry).	
14	Evaluation of bids (as per clause no. 14.0 of Terms and Conditions of Enquiry).	
15	<b>Transportation:</b> Confirm acceptance of clause 15.0 of T & C.	
16	Scrap :Confirm acceptance of Clause 16.0 of T & C of Enq.	
17	Rectification:Confirm acceptance of Clause 17.0 of T & C of Enq.	
18	Breach of contract : We accept Risk Purchase clause as per standard policy of BHEL and clause 18 of T & C	
19	Distribution of Load: Accept the Clause 19 of T & C	
20	We have read clause no. 20 of terms and conditions of Enquiry and confirm to abide the same.(Clause 20.1 to 20.11)	
21	Conflict of Interest: Confirm acceptance of Clause 21 of T & C of Enq.	
22	We have submitted Make in India certificate (duly filled and signed as per Annexure-B).	
23	We have submitted GISTC Rev.07 (duly filled and signed)	
24	Rates have been quoted in indian Rupees per Hole basis.	
25	PQR : as per clause 20.6.1 of T&C of enquiry.	

Note: BHEL reserves the right to reject any or all the offers (on techno-commercial ground) without assigning any reason thereof.

**(Vendor's signature with Stamp)**

**PQR for drilling of MTP/Tube Plate at Vendor Works for Indent No. 20240232**

01.00	TECHNICAL REQUIREMENT	Required	Offered	Remarks
01.01	<b>EXPERIENCE:</b> Vendors should have experience of drilling and supplying of at least 1 no. MTP/Tube plate or equivalent in last 7 years from the date of enquiry as per following details: i) Total thickness 40mm and above. ii) Drilled tube plate size should be 3.3 meter in width and 4.5 meter in length and above. iii) Number of drilled holes should be 7000 per plate and above. iv) Drilled size should be 24.0+0.2 mm and above. v) Material Grade : Carbon Steel as per SA 516, Gr. 70	Vendor to agree & submit suitable evidence		
01.02	<b>FACILITIES:</b> 1) EOT Crane of capacity 10 Ton and above. 2) Drilling facility to drill holes for following: i) Size of 25.2+0.2 in plate thickness 40mm. ii) Number of holes 13200 and above per plate. iii) Facility for marking radius R1. iv) Bed size to accomodate MTP/Tube Plate 4000mmX6000mm.	Vendor to agree & submit suitable documents		
01.03	Vendor to furnish certificate against clause 01.01 from the customer / company or end user duly confirming that drilled MTP/Tube plate or equivalent was supplied and used for power plant condenser tube plate application or equivalent <b>OR vendor to provide documents as per clause 01.04.</b>	Vendor to agree & submit suitable documents		
01.04	Vendor to furnish name of customer/company with complete contact details and month /year of previous supply along with copy of PO, type of manufacturing facility used for drilling, supply documents(Invoice/Challan) and inspection documents of supplied drilled MTP/Tube plate or equivalent for which certificate is furnished as per clause 01.01.	Vendor to agree & submit suitable documents		
01.05	All PQR documents are to be stamped and signed in original by Vendor. In case documents and official stamp is in language other than English, documents and details of official stamp are to be translated in English and duly certified by Government agency/approved agency of Government/Embassy.	Vendor to agree & submit suitable documents		
01.06	BHEL reserves the right to verify the information provided by vendor. In case the information provided by vendor is found to be false/ incorrect, their offers shall be rejected.	Vendor to agree		
02.00	<b>TECHNICAL ACCEPTANCE CRITERIA:</b>			
02.01	<b>DRILLING REQUIREMENT:</b> (a) Drilled hole finish 6.3 microns or better (b) Drilled hole ovality 0.03 mm max. (c) Drilled holes must be checked 100% by gauging (GO and NOT-GO) as per BHEL gauge drawing requirement. (d) Radius R-1 on both sides of holes	Vendor to agree		
2.05	All Vendors to confirm inspection of drilled MTP/Tube plate or equivalent by BHEL or BHEL nominated agency for as per BHEL approved quality plan before dispatch.	Vendor to agree		
<b>NOTE:</b>	<b>PQR IS NOT RESTRICTIVE</b>			

04/06/2024  
[Gaurav Sharma]  
Engineer (FT)

05/06/2024  
[Ravi Deshpande]  
Manager (FT)

05/6/2024  
[Vivek NASTAN]  
DCM (BL-2/FT)

05/6/24  
[K. Ganesh]  
AUM (BL-2/FT)



## BHARAT HEAVY ELECTRICALS LIMITED

HEEP-HARIDWAR, UTTARAKHAND (249403)

General Instructions and Standard Terms & Conditions for bidding against Tender Enquiry (GISTC)

For Indian Bidders (Version May-2024, Rev: 07)

### Table of Contents

1. GENERAL.....	1
2. ORIGIN OF QUOTATION .....	1
3. SUBMISSION OF TENDER.....	1
4. TENDER OPENING.....	2
5. SPECIFICATION, DRAWINGS & STANDARD .....	2
6. PRICE SCHEDULE.....	3
7. REVERSE AUCTION.....	3
8. DELIVERY TERMS .....	3
9. LD FOR LATE DELIVERY .....	4
10. PAYMENT TERMS.....	4
11. TAXES & DUTIES.....	5
12. BANK GUARANTEE.....	6
13. GUARANTEE / WARRANTY AND CORRESPONDING REPAIRS / REPLACEMENT OF GOODS .....	6
14. QUALITY REQUIREMENT.....	6
15. VALIDITY .....	6
16. RIGHT OF ACCEPTANCE .....	6
17. TRANSIT INSURANCE .....	7
18. RISK PURCHASE .....	7
19. FORCE MAJEURE CLAUSE.....	7
20. NON-DISCLOSURE AGREEMENT .....	8
21. SETTLEMENT OF DISPUTES / ARBITRATION.....	8
22. WHARFAGE / DEMURRAGE RESPONSIBILITY.....	8
23. CONDITIONS FOR AVAILING MICRO & SMALL ENTERPRISES (MSE'S) BENEFITS .....	8
24. INFORMATION TO THE BIDDERS .....	10
25. MAKE IN INDIA (GOVT-NOTIFICATION) .....	10
26. RESTRICTIONS UNDER RULE 144(XI) OF THE GENERAL FINANCIAL RULES (GFRs), 2017 .....	12
27. NOTE. ....	12

### 1. GENERAL.

These general terms & conditions shall apply to all the Tender Enquiries, notice inviting tenders, request for quotations concerning the supply of goods and / or rendering of services to Bharat Heavy Electricals Ltd., HEEP, Haridwar (hereinafter referred to as BHEL or the Purchaser). In case of placement of order these conditions will become part of Purchase Order (P.O) until unless the deviations are specifically agreed by BHEL.

### 2. ORIGIN OF QUOTATION.

A bidder shall not have conflict of interest with other bidders. Such conflict of interest can lead to anti-competitive practices to the detriment of Procuring Entity's interests. **The bidder found to have a conflict of interest shall be disqualified.** A bidder may be considered to have a conflict of interest with one or more parties in this bidding process, if:

- they have controlling partner (s) in common; **or**
- they receive or have received any direct or indirect subsidy/ financial stake from any of them; **or**
- they have the same legal representative/agent for purposes of this bid; **or**
- they have relationship with each other, directly or through common third parties, that puts them in a position to have access to information about or influence on the bid of another Bidder; **or**
- Bidder participates in more than one bid in this bidding process. Participation by a Bidder in more than one Bid will result in the disqualification of all bids in which the parties are involved. However, this does not limit the inclusion of the components/ sub-assembly/ Assemblies from one bidding manufacturer in more than one bid; **or**
- In cases of agents quoting in offshore procurements, on behalf of their principal manufacturers, one agent cannot represent two manufacturers or quote on their behalf in a particular tender enquiry. One manufacturer can also authorise only one agent/dealer. There can be only one bid from the following:
  - The principal manufacturer directly or through one Indian agent on his behalf; and
  - Indian/foreign agent on behalf of only one principal;**or**
- A Bidder or any of its affiliates participated as a consultant in the preparation of the design or technical specifications of the contract that is the subject of the Bid; **or**
- In case of a holding company having more than one independently manufacturing units, or more than one unit having common business ownership/management, only one unit should quote. Similar restrictions would apply to closely related sister companies. Bidders must proactively declare such sister/ common business/ management units in same/similar line of business. "

### 3. SUBMISSION OF TENDER.

- Bid / Quotation must be enclosed in sealed cover on which tender enquiry number and the due date MUST BE written and be invariably sent under REGISTERED POST / SPEED POST / COURIER / Dropped in the Tender Box: addressed as follows:

Quotation against Enquiry No. \_\_\_\_\_

Dated: \_\_\_\_\_

Due on: \_\_\_\_\_

To,

**THE HEAD OF MATERIALS MANAGEMENT,  
Heavy Electrical Equipment Plant,  
Bharat Heavy Electricals Limited,  
HARIDWAR-249403 (Uttarakhand), INDIA.**

- TENDER ROOM is located at: Room No. - 415, 4<sup>th</sup> Floor, Main Admin. Building, BHEL-HEEP, Haridwar.



## BHARAT HEAVY ELECTRICALS LIMITED

HEEP-HARIDWAR, UTTARAKHAND (249403)

General Instructions and Standard Terms & Conditions for bidding against Tender Enquiry (GISTC)

For Indian Bidders (Version May-2024, Rev: 07)

- c) In case of Three / Two Part Bid, technical bid containing technical offer, duly signed and un-priced copy of the Price Bid should be kept in one envelope. Price Bid containing only the price should be kept in a separate envelope. All envelopes indicating Part-1 or Part-2 or Part-3 as the case may be to be put in a bigger envelope. Please note that un-priced bid should be the exact replica of price bid but without prices.
- d) The bid / quotation must be posted before due date, keeping allowance for postal transit time. Quotations sent by any mode but not received in time will be ignored. Tender received through authorized E-mail is also acceptable. However, in time submission of tender in tender box shall be the responsibility of the bidder, sent through any mode. Documents submitted with the offer / bid shall be signed and stamped in each page by authorized representative of the bidder.
- e) Any additional documents submitted by supplier / bidder, during processing of registration application / tender or after placement of order shall not be accepted unless it is submitted with forwarding letter and duly signed and stamped.
- f) The bids of the bidders who are on the banned list and also the bids of the bidders, who engage the services of the banned firms, shall be rejected. The cutting / overwriting in the bid / offer must be duly attested by the signatories to the bid. The list of firms banned by BHEL is available on BHEL web site [www.bhel.com](http://www.bhel.com).
- g) Being PMD vendor, if you are not quoting against this tender enquiry, please send your regret letter positively for our reference with valid reasons for not participating in the tender enquiry. Repeated lack of response on the part of bidder may lead to deletion such PMD vendor from BHEL's approved vendor list.
- h) The bidders will submit Integrity Pact, duly signed by its authorized signatory, along with their bids wherever estimated tender value is Rs. 2 Crore or more.
- i) In case of open tender, technically qualified unregistered bidders may apply online for registration through <http://www.bhel.com/index.php/vender>.
- j) BHEL reserves the right to award tendered quantities among more than one bidder (after acceptance of L1 price by the other bidders). BHEL can also consider awarding of part of the tendered quantity to other than L-1 bidder at L1 counter offered rates, if the quantity offered by the L-1 bidder is less than the quantity tendered for.
- k) In case of e-Tendering (Online bidding through e-portal), offline bid submitted in hard copy or in any other form by the vendor / supplier will not be accepted and will be rejected out rightly. Only e-portal bid will be accepted.

#### 4. TENDER OPENING.

Tender opening is scheduled to start in the Tender Room at 2:00 PM, on the due date. Therefore, bid / quotations must reach this office / tender Box latest by 1:45 PM on due date. Only participating bidders are allowed to attend tender opening. **TENDERS RECEIVED AFTER THE SPECIFIED TIME OF THEIR 'SUBMISSION' WILL BE TREATED AS LATE TENDERS AND SHALL NOT BE CONSIDERED UNDER ANY CIRCUMSTANCES.** The bidders or their authorized representatives may be allowed to attend tender opening if duly authorized by their principals, through a tender specific letter on that particular day. General authorization letter is not acceptable.

***Note: - Foreign bidders willing to attend the bid opening has to provide the requisite documents to the concerned Purchase executives for arranging gate pass for them.***

#### 5. SPECIFICATION, DRAWINGS & STANDARD.

- a) Bidders must give their detailed specification in the quotation along with relevant technical literature / catalogue etc. against the tender enquiry.
- b) The Bid should be accompanied with relevant copies of catalogues, drawings or specification as per tender enquiry.



## BHARAT HEAVY ELECTRICALS LIMITED

HEEP-HARIDWAR, UTTARAKHAND (249403)

General Instructions and Standard Terms & Conditions for bidding against Tender Enquiry (GISTC)

For Indian Bidders (Version May-2024, Rev: 07)

If these documents are not furnished, the offer is liable to be rejected.

- c) Wherever national / international (N/IN) standards are referred, the latest N/IN standards are to be followed. Mention year & date of standard revision that shall be followed for the supply.
- d) All Drawings and Standards are proprietary of BHEL. It must not be used in anyway detrimental to the interest of BHEL or without permission of BHEL.

### 6. PRICE SCHEDULE.

- a) Kindly quote your prices in figures and words both. In case of any discrepancy in value, the prices quoted in words shall be considered for evaluation and establishing L1 status.
- b) Prices quoted should not be more than the prices quoted to any other BHEL units / offices / divisions. Vendor to submit copy of latest Purchase Order placed by any unit of BHEL for similar items in the technical bid. In case no order has been placed on such items, specific confirmation that no order has been placed on such items should be provided.
- c) Prices should be quoted on F.O.R. Destination basis. Transit insurance shall be arranged by BHEL and not to be included in the prices. The offers quoted on other than F.O.R destination basis may result in non-consideration of such bids.
- d) In case BHEL accepts the EX-Works prices, such offers will be loaded by 1.5% of EX-Works value towards freight or with actual freight charges as per BHEL freight rate contract whichever is higher.
- e) In case of Indigenous items covered by DGS & D Rate Contract, the bidders should submit latest valid copy of the rate contract along with bid / quotation
- f) Applicable **IGST / CGST / SGST** and any other statutory levy should be indicated separately and clearly in the bid / quotation.

- g) Bidders can dispatch goods through any Indian Bank Association approved transporters having their branch at HARIDWAR / destination. If material is dispatched through other than Indian Bank Association approved transporter, material to be delivered on door delivery BHEL Stores basis.
- h) In case of dispatch of material through any other unapproved transporter, payment shall be made only after receipt of material and any additional charges payable to the transporter shall be to the bidder's account.
- i) Any demurrage / godown rent payable to the transporter / or to godown's owner due to any delay attributed by the supplier shall be recovered from supplier's account.
- j) Currency of Evaluation shall be INR.

**NB: Financial evaluation of L1, L2 .....Status will be on the basis of Landed Cost to BHEL.**

### 7. REVERSE AUCTION.

**Wherever RA is declared in the special terms and conditions of tender enquiry, following shall be applicable and Bidders to confirm the same:**

"BHEL shall be resorting to Reverse Auction (RA) (Guidelines as available on [www.bhel.com](http://www.bhel.com)) for this tender. RA shall be conducted among all the techno-commercially qualified bidders.

Price bids of all techno-commercially qualified bidders shall be opened and same shall be considered as initial bids of bidders in RA. In case any bidder(s) do(es) not participate in online Reverse Auction, their sealed envelope price bid along with applicable loading, if any, shall be considered for ranking."

### 8. DELIVERY TERMS.

- a) Goods shall be delivered on 'FOR Destination' basis to the named destination unless otherwise called for in the tender enquiry.
- b) Loading on account of 3rd party inspection charges in case of Indian bidders shall be 0.20%.



## BHARAT HEAVY ELECTRICALS LIMITED

HEEP-HARIDWAR, UTTARAKHAND (249403)

General Instructions and Standard Terms & Conditions for bidding against Tender Enquiry (GISTC)

For Indian Bidders (Version May-2024, Rev: 07)

### 9. LIQUIDATED DAMAGES (LD) FOR LATE DELIVERY.

#### a) Where items of Purchase Order are independently usable.

Liquidated Damages (LD) for Late Deliveries shall be applicable @0.5% per week or part thereof on the value of respective delayed supplies subject to a maximum of 10% of the value of respective delayed supplies. Value of delayed supplies will mean the Gross Value payable to the vendor (Before LD) against such supplies excluding taxes and duties.

#### b) **Where the total items are required for a main equipment and items are interdependent.**

Liquidated Damages (LD) for Late Deliveries shall be applicable @0.5% per week or part thereof on total value of Purchase Order subject to maximum of 10% of the total value of Purchase Order. Purchase Order value for this purpose shall be the Total Gross Value payable to the vendor (Before LD) excluding taxes and duties.

c) Bidders are requested to quote the best delivery meeting the delivery requirements. BHEL reserves the right to reject the offers not meeting BHEL's delivery requirement.

d) Commencement of delivery period shall be reckoned from the date of PO / LOI or any other agreed milestone.

e) Bidder shall deliver the goods in the manner and schedule agreed under the terms and conditions of Purchase order.

f) **DELIVERY IN CASE OF REJECTION:** In case the material is rejected, then date of replacement will be considered as the actual date of delivery.

g) **DELIVERY AGAINST BANK DOCUMENTS:** In case payment terms quoted by bidder are documents through bank, and the delivery terms being "FOR Haridwar / FOR Transporter Go-down" then date of delivery will be date of intimation by transporter / bidder of delivery of material at Haridwar for the LD purpose.

h) Where the payments are through bank, the documents may be presented for negotiation to BHEL authorized / nominated bank.

i) Payment of Liquidated Damages (LD) shall not in any way relieve the vendor from any of its obligations & liabilities under the contract.

### 10. PAYMENT TERMS.

a) BHEL's standard payment term is Payment after receipt and acceptance of materials / items at HEEP, BHEL-Store or at desired destination unless otherwise specified in Special Terms attached to the tender enquiry.

b) BHEL reserves the right to accept or reject the offer of the bidder who quotes the payment term other than BHEL's standard payment term.

c) Loading on account of deviation in payment terms shall be done as per extant rules of BHEL-Haridwar.

d) 100% payment along with taxes, freight & insurance will be made after receipt and acceptance of material and within 75 days from the date of invoice subject to submission of non-discrepant documents within 15 days of supply as per terms and conditions of Purchase Order. In case any discrepancy found in the documents, BHEL will notify the same to vendor within 7 days of receipt. Vendor has to clear all the discrepancies in one go within 7 days thereafter else the payment of vendor may get delayed.

e) For MSEs (covered under MSME Act) which are registered and periodically renewed with BHEL, the payment will be made within 45 days or as prescribed in the relevant act.

f) Adherence to the above time schedule of payment is contingent upon Vendor complying with GST Rules w.r.t availment of Input Tax Credit by BHEL.

g) In case GST credit is delayed / denied to BHEL, due to non / delayed receipt of goods and / or tax invoice or expiry of the timeline prescribed in GST Law for availing such ITC, or any other reason not attributable to BHEL, GST amount shall be recoverable from Vendor along with interest levied / leviable on BHEL.

h) The taxes and duties that are reimbursed would be the ones applicable as on the contractual Purchase order delivery date or the amount actually paid whichever is less.



## BHARAT HEAVY ELECTRICALS LIMITED

HEEP-HARIDWAR, UTTARAKHAND (249403)

General Instructions and Standard Terms & Conditions for bidding against Tender Enquiry (GISTC)

For Indian Bidders (Version May-2024, Rev: 07)

**i) The loading criteria for the different payment terms shall be as under;**

Payment Terms	Days of Loading
After Receipt & Acceptance of material within 75 days of supply.	<b>No Loading</b>
Against Delivery at BHEL-Stores Haridwar.	<b>45</b>
Against documents through bank (CAD):	<b>45</b>
Letter of Credit (LC)	<b>120</b>
Usance LC	No Loading if usance period is > 120 Days.
	Loading of days' difference i.e. difference between 120 days and usance period if the usance period is < 75 days.
Advance	Delivery Period + 120 Days - Advance Payment Days.

### 11. TAXES & DUTIES.

- a) The bidder to specify in their offer (part 1 bid) the category of their registration under GST like Registered, Unregistered and composite dealer.
- b) The provisional GST registration number of Bharat Heavy Electrical Ltd, Heavy Electricals Equipment Plant, Ranipur, Haridwar is "05AAACB4146P1ZL" with state Code as "05" and State Name as "Uttarakhand".
- c) Please quote our provisional GST registration number in all invoices raised for supply of goods and services under GST regime and also ensure filing of timely return and payment of tax and compliance of other applicable provisions on supplier under GST regime.
- d) No GST will be reimbursed to unregistered or composite dealer. In the event, any GST is quoted by composite dealer, the same shall be added to the cost of supply in evaluating the bid.
- e) Since, input credit of GST will be available to BHEL-Haridwar only after correct filing of return and payment of applicable GST by supplier, reimbursement of GST shall be made by

BHEL-Haridwar on matching of vendor inputs at GST portal, ensuring availability of input credit to BHEL Haridwar. Payment of GST will be made to vendor after matching of input credit and vendor to ensure submission of their invoices along with consent to accept payment of tax after such matching in all cases where bills are submitted directly to BHEL-Haridwar or through bank or under LC or through any other mode.

- f) In the event of any disallowance of input credit or applicability of interest or any other financial liability arises on BHEL-Haridwar due to any default of supplier under GST, such implication shall be to supplier's account.
- g) In the event of any change in the status of the vendor after the submission of the bid but before the supply, GST applicable at the time of supply or in the bid, based on the registration status of the vendor, whichever is lower shall be payable.
- h) Where ever applicable If PAN (Permanent Account Number) of the recipient is not available, income tax is deductible either at the normal rate or at the rate of 20 percent, whichever is higher as per Section 206AA of Indian Income Tax Act 1961.
- i) The bidder shall clearly indicate HSN (*Harmonised System Nomenclature*) / SAC (*Service Accounting Code*), its description and applicable rate of GST for each item in his techno-commercial bid.
- j) Statutory Variation in Taxes & duties as applicable at the time of supply shall be payable. However, in the event of no change in law but bidder quoting certain tax structure in bid document which is lower than the applicable one, such amount shall be the maximum amount of tax that can be claimed by bidder.
- k) **IMPORTED GOODS OFFERED BY INDIAN BIDDERS AGAINST DEALER INVOICE:** Wherever the material being offered is imported, the bidder must quote the prices inclusive of IGST. The rate and value of IGST as included in the price must be indicated separately. In case quantum of IGST is not mentioned by the bidder the same will not be considered for



## BHARAT HEAVY ELECTRICALS LIMITED

HEEP-HARIDWAR, UTTARAKHAND (249403)

General Instructions and Standard Terms & Conditions for bidding against Tender Enquiry (GISTC)

For Indian Bidders (Version May-2024, Rev: 07)

evaluation. However, bidder will have to pass on the benefit of IGST to BHEL at the time supply.

- l) In case of directly dispatchable items to Customer's Site, BHEL-Haridwar will inform the GST registration number of the respective customer which must be mentioned on the vendor's invoice. Vendor to ensure availability of such information from BHEL-Haridwar before dispatch of any material. However, while filing GSTN-1, BHEL Haridwar GSTN number to be quoted.

Note: - Vendors must ensure compliance of all the applicable rules and procedure as envisaged in the GST Regime. Any loss to BHEL-Haridwar due to fault / non-compliance by the vendor will be to the vendor's account.

### 12. BANK GUARANTEE.

In case the bank guarantees are required to be deposited towards security deposit/performance guarantee or for any other purpose as per the terms of this tender enquiry, such bank guarantees of the requisite value in the denominated currency of the purchase order should be from one of the Indian branch of BHEL consortium banks and the bank guarantee should be in the proforma as prescribed by BHEL. The proforma of bank guarantee and the list of consortium banks are displayed at BHEL website [www.bhelhwr.co.in](http://www.bhelhwr.co.in). However, in case the bank guarantee is not from BHEL consortium banks, then the bidder has to get the bank guarantee confirmed from one of the Indian branch of BHEL consortium banks and the bank charges for such confirmation will be borne by the bidder.

### 13. GUARANTEE / WARRANTY AND CORRESPONDING REPAIRS / REPLACEMENT OF GOODS.

Goods shall comply with the specifications for material, workmanship and performance. Unless otherwise specified, the warranty shall be for a period of 18 months from the date of receipt. If the delivery is found non-compliant during the warranty period, leading to rejection, the Seller shall arrange free replacement / repair of goods, within one month from the date of intimation or any mutually agreed period. The rejected goods shall be taken away by the Seller at his cost and

replaced on Delivered Duty Paid (DDP) (FOR - BHEL Stores / designated destination basis) within such period. In the event of the Seller's failure to comply, Purchaser may take action as appropriate, including Repair / Replenish rejected goods & disposal of rejections, at the risk & cost of the Seller. In case the defects attributable to Seller are detected during processing of the goods at BHEL or at our subcontractor's works, the Seller shall be responsible for free replacement / repair of the goods as required by BHEL.

- b) **RETURN OF REJECTED MATERIAL FOR REPLACEMENT:** The bidder shall have to pay 5% incidental charges while taking back supplied material if it is found rejected on receipt. The rejected material shall be sent back only after receipt of replacement / submission of BG / refund of amount paid.

### 14. QUALITY REQUIREMENT.

Your bid / quotation should have specific confirmation regarding meeting all our quality requirements such as. (i) Test Certificate (TC), (ii) Guarantee Certificate (GC) / Warranty Certificate (WC), (iii) Quality Plan (QP) (if applicable); and (iv) Pre-Dispatch Inspection at your works (if applicable).

### 15. VALIDITY.

The quotation should be valid for a minimum period of 90 days effective from the date of opening of tender, unless otherwise specified in the tender enquiry.

### 16. RIGHT OF ACCEPTANCE.

- a) **BHARAT HEAVY ELECTRICALS LIMITED HARIDWAR** reserves the right to reject any or all the bids / quotations without assigning any reason thereof. BHEL also reserves the right to increase or decrease the tendered quantities. Bidders should be prepared to accept order for reduced quantity without any extra charges.
- b) Any discount / revised offer / bids submitted by a bidder on its own shall be considered, provided it is received on or before the due date and time of offer / bid submission (Part-1). Conditional discounts shall not be considered for evaluation of tenders.



## BHARAT HEAVY ELECTRICALS LIMITED

HEEP-HARIDWAR, UTTARAKHAND (249403)

General Instructions and Standard Terms & Conditions for bidding against Tender Enquiry (GISTC)

For Indian Bidders (Version May-2024, Rev: 07)

- c) Unsolicited discounts / revised offers / bids given after Part-1 bid opening shall not be accepted. No change in price will be permitted within the validity period asked for in the tender enquiry.
- d) In case of changes in scope and / or technical specification and / or commercial terms & conditions having price implication, techno-commercially acceptable bidders shall be asked by BHEL to submit the impact of such changes on their price bids. In case a bidder opts to submit revised price bid instead of impact called for then the latest price bid shall prevail. However, in both situations, original price bid will be necessarily opened.
- e) The bidder whose bid is technically not accepted will be informed & EMD wherever submitted shall be returned after finalization of contract. EMD shall be forfeited in the event of bidder opting out after tender opening.
- f) BHEL reserves the right to short close the existing Purchase Order / Rate Contract / Work Order or any extension thereof at any stage.

### 17. TRANSIT INSURANCE.

- a) Transit Insurance will be covered by BHEL under its open Insurance Policy. Seller shall inform dispatch particulars (Purchase Order, RR /GR, Invoice value etc.) to "Finance department (Store bill Section), BHEL Ranipur, Haridwar (Uttarakhand-India) with value of consignment to the Purchaser within 07 days of dispatch for BHEL to arrange insurance coverage in its policy. Failure on the part of seller to inform dispatch particulars will make him liable to pay for any transit damages / losses suffered by the Purchaser.
- b) If Quoted Prices are inclusive of transit insurance, no weightage shall be given while evaluating the bids for Cost of Insurance, being in BHEL Scope.

### 18. RISK PURCHASE.

In case of abnormal delays (beyond the maximum late delivery period as per LD clause) in supplies / defective supplies or non-fulfillment of any other terms and conditions given in Purchase Order, BHEL may cancel the Purchase Order in full or part thereof, and may also make the purchase of such material from elsewhere / alternative source at the risk and cost of the supplier. BHEL will take all reasonable steps to get the material from alternate source at optimum cost. If bidder does not agree to the above Risk Purchase Clause, BHEL reserves the right to reject the offer. In case for compelling reasons BHEL accepts the offer without acceptance of this clause by the bidder and in the eventuality of Risk Purchase, appropriate action will be taken as per BHEL extant rules. This will be without prejudice to any other right of BHEL under the contract or under General Law.

### 19. FORCE MAJEURE CLAUSE.

Notwithstanding any other thing contained anywhere else in the contract or PO (Purchase Order), In case the discharge of obligation under the contract by either party is impeded or made unreasonably onerous, neither party shall be considered in breach of the contract to the extent that performance of their respective obligation is prevented by an event of Force Majeure that arises after the effective date (PO date).

In the above clause, Force Majeure means an event beyond the control of the parties to the contract which prevents a party from complying with any obligation of the contract including but not limited to:

- Act of God (Such as but not limited to earthquake, drought, tidal waves, floods etc.).
- War (whether war be declared or not), Hostilities Invasion, Act of foreign enemy etc.
- Rebellion, revolution, insurrection, civil war etc.
- Contamination of Radio Activity from any nuclear fuel or from any other nuclear waste or any other hazardous materials.
- Riots, commotions, strike unless restricted to the employees of supplier.
- Acts of terrorism.



## BHARAT HEAVY ELECTRICALS LIMITED

HEEP-HARIDWAR, UTTARAKHAND (249403)

General Instructions and Standard Terms & Conditions for bidding against Tender Enquiry (GISTC)

For Indian Bidders (Version May-2024, Rev: 07)

- g) Other unforeseeable circumstances beyond the control of the parties and which the affected party cannot avoid even by using its best efforts.
- h) Cancellation of contract by customer.
- i) Change in law / government. Regulation making the performance impossible.
- j) Pandemic or Epidemic.

The party claiming to be affected by force majeure shall notify the other party in writing immediately without delay on the intervention and on the cessation of such circumstances.

Irrespective of any extension of time, if an event of force majeure occurs and its effect continues for more than 180 days the affected party shall have right to cancel the contract.

As soon as reasonably practicable following the date of commencement of a Force Majeure Event, and within a reasonable time following the date of termination of a Force Majeure Event, either Party invoking it shall submit to the other Party reasonable proof of the nature of the Force Majeure Event and of its effect upon the performance of the Party's obligations under this Agreement.

The party shall, and shall ensure that its Subcontractors shall, at all times take all reasonable steps within their respective powers and consistent with Good Operating Practices (but without incurring unreasonable additional costs) to:

- a) Prevent Force Majeure Events affecting the performance of the party's obligations under this Agreement.
- b) mitigate the effect of any Force Majeure Event and
- c) Comply with its obligations under this Agreement.

If the war like situation has developed in a country where a seller's works is located in this P.O. or there is political instability and Indian Embassy located in that country forbids or advises for not having any business dealing with the sellers located in such zone / region/ country, then BHEL reserves the right to cancel the order.

### **20. NON-DISCLOSURE AGREEMENT.**

All Drawing and Technical Documents relating to the product or it's manufacture submitted by one party to the other, prior or

subsequent to the formation of contract, shall remain property of the submitting party. Drawing, technical documents or other technical information received by one party, shall not without the consent of the other party, be used for any other purpose than that, for which they were provided. Such technical information shall not without the consent of the submitting party, otherwise be used or copied, reproduced, transmitted or communicated to a third party. Patterns supplied by BHEL will remain BHEL's property which shall be returned by the bidder on demand to BHEL. Bidder shall in no way share or use such intellectual property of BHEL to promote his own business with others or to gain a commercial advantage. BHEL reserves the right to claim damages from the bidder, or take appropriate action as deemed fit against the bidder, for any infringement of the provisions contained herein as available under law or equity.

### **21. SETTLEMENT OF DISPUTES / ARBITRATION.**

In case of any dispute arising out of as in connection with this contract, the same shall be referred to arbitration under Arbitration & Conciliation Act 1996 of a sole arbitrator who shall be appointed by mutual consent of the parties. The seat & venue of arbitration shall be Haridwar.

The proceedings shall be conducted in English. The Governing law of contract shall be the substantive law of India.

### **22. WHARFAGE / DEMURRAGE RESPONSIBILITY.**

In the event of delay in receipt of documents by Manager (Stores-Shipping) BHEL-Haridwar and in case where dispatches are made through Unapproved Transporter the sole responsibility for wharfage / demurrage for such delay shall be that of supplier.

### **23. CONDITIONS FOR AVAILING MICRO & SMALL ENTERPRISES (MSE'S) BENEFITS.**

- a) "MSE Suppliers can avail the intended benefits only if they submit along with the offer, attested copies of either EM II certificate having deemed validity (**five years** from the date of issue of acknowledgement in EM II) or valid NSIC certificate or EM II certificate along with attested copy of a CA certificate



## BHARAT HEAVY ELECTRICALS LIMITED

HEEP-HARIDWAR, UTTARAKHAND (249403)

General Instructions and Standard Terms & Conditions for bidding against Tender Enquiry (GISTC)

For Indian Bidders (Version May-2024, Rev: 07)

(Format enclosed at annexure-1 where deemed validity of EM II certificate of five years has expired) applicable for the relevant financial year (latest audited). Date to be reckoned for determining the deemed validity will be the date of bid opening (Part 1 in case of two-part bid) or vendor has to give Udyog Adhar Memorandum (UAM). Non submission of such documents will lead to consideration of their bid at par with other bidders. No benefit shall be applicable for this enquiry if any deficiency in the above required documents is found or the requisite documents are not submitted before price bid opening. If the tender is to be submitted through e-procurement portal, then the above require document are to be uploaded on the portal. Documents should be notarized or attested by a Gazetted officer. **UAM need not required to be notarized or attested.**

b) Any new supplier will be eligible for registration with BHEL as MSE supplier provided at least any one of the following documents are submitted along with application for registration: -

1. Udyog Adhar Memorandum (UAM).
2. Valid National Small Industries Commission (NSIC) Certificate.
3. Entrepreneurs Memorandum part II (EM II) certificate (valid based on deemed validity of 5 years) or
4. EM II certificate along with attested copy of CA Certificate (as per prescribed format at annexure-A) applicable for the relevant financial year (latest audited), where the deemed validity of EM II is over.
5. However, credentials of all MSE suppliers will be verified before advancing the intended benefits.
6. MSE bidders claiming SC/ST status will have to submit SC/ST certificate of the Proprietor from competent authority. Attested (notarized or attested by Gazetted officer) copy to be submitted along with the offer.
7. In case techno-commercial accepted bidders include MSE source and their prices (based on landed cost – considering quoted prices) are within the price band of 15% w.r.t. L-1 bidder, then BHEL can offer **25%** of quantity of respective item (rounded off to nearest number) to MSE bidders at L-1 price and in case, more than one MSE bidder is in 15 % band and the same is accepted by more than one MSE bidders then **25%** quantities of respective items will be considered for ordering on proportionate basis amongst MSE bidders.

8. There will be minimum of **3%** reservation for women owned MSEs within the above mentioned 25% reservation.
9. The reservation for MSEs owned by SC/ST will be **6.25%** { 25% out of target of 25% - refer para 4 of Public Procurement Policy for the Micro and Small Enterprises(MSEs)}.
10. The definition of MSEs owned by Women Entrepreneurs is clarified as under:
  - a) In case of proprietary MSE, proprietor shall be Woman.
  - b) In case of partnership MSE, the Woman partners shall be holding at least 51% of share in the unit.
  - c) In case of Private Limited companies, at least 51% share shall be held by Women promoters.
11. The definition of MSEs owned by SC/ST is clarified as under:
  - a) In case of proprietary MSE, proprietor(s) shall be SC/ST.
  - b) In case of partnership MSE, the SC/ST partners shall be holding at least 51% of shares in the unit.
  - c) In case of Private Limited companies, at least 51% share shall be held by SC/ST promoters.
12. While distributing the **25%** quantity amongst MSE bidders the decimal points in quantity shall be ignored for all the bidders except the L-1 amongst MSE bidders. Balance quantity after allocating the quantity to other MSE bidders ignoring the quantities in decimal, shall be given to L-1 (amongst MSE) bidder. However, if there are more than one MSE bidder at the same price level than preference for additional quantities due to ignoring off the decimal (as mentioned above) shall be given to the bidder offering favorable terms to BHEL and if the conditions offered are also same then preference will be given to the bidder having high SPR rating.
13. In case there are more than one MSE bidders (with different landed cost to BHEL) within 15% price band of lowest bidder and quantity to be offered is 1 no. only, then preference shall be given to the MSE bidder with lowest landed cost.
14. In case there are more than one MSE bidders (with same landed cost to BHEL) within 15% price band of lowest bidder and quantity to be offered is 1 no. only, then preference shall be given first, based on the favorable terms in the bid and in case terms are also same, the bidder with high SPR rating shall be given preference.
15. If L1 bidder is MSE bidder, entire quantity will be given to such MSE bidder only.



## BHARAT HEAVY ELECTRICALS LIMITED

HEEP-HARIDWAR, UTTARAKHAND (249403)

General Instructions and Standard Terms & Conditions for bidding against Tender Enquiry (GISTC)

For Indian Bidders (Version May-2024, Rev: 07)

16. Note: It may however be noted that MSE guidelines as on date (Date of Technical Bid Opening Part-1) shall prevail.

17. "As per the OM No. F.No. 1(2)(1)/2016-MA dtd. 09.02.2017 issued from the Office of Development Commissioner (Micro, Small & Medium Enterprises), "Traders and agents should not be allowed to avail the benefits extended under the PP Policy."

In view of this, it is clarified that benefits of MSE (such as EMD Waiver, Tender fee exemption, Price preference, Payment preference etc.) will be given only to those MSE Vendors who are manufacturers of offered items against the NIT. No MSE benefits shall be provided to Agents / Stockists / Dealers / Traders etc. for the items offered but not manufactured by themselves."

#### 24. INFORMATION TO THE BIDDERS.

a) Purchase related information is available at our Business-to-Business (B2B) Portal available on our website <https://hwr.bhel.com>. The user ID & password can be obtained by sending a request to concerned purchase executives.

b) Intimate your change in mail address or communication address or changes, if any, by email to AGM (SDX/MM) giving your bidder Code.

c) Please resolve your rejections and unexecuted overdue purchase order immediately which are posted at our B2B Portal, which can be visited through our site <https://hwr.bhel.com>

d) Copy of this Tender Enquiry is being sent through the post.

e) The Bidder declares that they will not enter into any illegal or undisclosed agreement or understanding, whether formal or informal with other bidder(s). This applies in particular to prices, specifications, certifications, subsidiary contracts, submission or non-submission of bids or any other actions to restrict competitiveness or to introduce cartelization in the bidding process.

In case, the bidder is found having indulged in above activities, suitable action shall be taken by BHEL as per extant policies/guidelines.

f) Supplier must upload digitally signed e-Invoice on B2B portal for processing of Bills.

In other cases, inked signed hard copy of Invoice to be submitted for processing of Bills.

#### 25. MAKE IN INDIA (GOVT-NOTIFICATION).

A. This tender enquiry shall be governed by notification no. P-45021/2/2017-PP (BE-II) dated 04.06.2020 of government of INDIA and subsequent circulars issued afterwards. Accordingly, the minimum local content, the margin of purchase preference and the procedure for preference to make in INDIA shall be adhered.

B. The margin of purchase preference shall be 20%.

- 'Class-I local Supplier' means a supplier or service provider, whose goods, services or works offered for procurement, has local content equal to or more than 50%, as defined under this order.
- 'Class-II local Supplier' means a supplier or service provider, whose goods, services or works offered for procurement, has local content more than 20% but less than 50%, as defined under this order.
- 'Non- local Supplier' means a supplier or service provider, whose goods, services or works offered for procurement, has local content less than or equal to 20%, as defined under this order.

C. Vendor to specifically confirm if they are Class-I or Class-II local supplier or not as per above mentioned notification.

Accordingly, the 'Class-I local supplier' / 'Class-II local Supplier' at the time of tender, bidding or solicitation shall be required to indicate percentage of local content and provide self-certification that the item offered meets the local content requirement for 'Class-I local supplier' / 'Class-II local Supplier', as the case may be. They shall also give details of the location(s) at which the local value addition is made.

D. In cases of Procurement for a Value in Excess of Rs. 10 Crores, the 'Class-I local supplier' / 'Class-II local Supplier' shall be required to provide a Certificate from the Statutory Auditor or Cost Auditor of the Company (in the case of companies) or from a practicing Cost Accountant or practicing Chartered Accountant (in respect of suppliers other than companies) giving the percentage of Local Content.



## BHARAT HEAVY ELECTRICALS LIMITED

HEEP-HARIDWAR, UTTARAKHAND (249403)

General Instructions and Standard Terms & Conditions for bidding against Tender Enquiry (GISTC)

For Indian Bidders (Version May-2024, Rev: 07)

### E. Requirement of Purchase Preference:

Purchase preference shall be given to 'Class-I local supplier' in procurements undertaken by procuring entities in the manner specified hereunder -

a. In the procurements of goods or works, which are covered by para 3(b) of mentioned Govt. circular and which are divisible in nature, the 'class-I local supplier' shall get purchase preference over 'Class-II supplier' as well as 'Non-local supplier', as per following procedure:

- i. Among All qualified bids, the lowest bid will be termed as L1. If L1 is 'Class-I local supplier', the contract for full quantity will be awarded to L1.
- ii. If L1 bid is not a 'Class-I local supplier', 50% of the order quantity shall be awarded to L1. Thereafter, the lowest bidder among the 'Class-I local supplier' will be invited to match the L1 price for the remaining 50% quantity subject to the class-I local supplier's quoted price falling within the margin of purchase preference, and contract for that quantity shall be awarded to such 'Class-I local supplier' subject to matching the L1 price. In case such lowest eligible 'Class-I local supplier' fails to match the L1 price or accepts less than the offered quantity, the next higher 'Class-I local supplier' within the margin of purchase preference shall be invited to match the L1 price for remaining quantity and so on, and contract shall be awarded accordingly. In case some quantity is still left uncovered on Class-I local supplier, then such balance quantity may also be ordered on the L1 bidder".

b. In the procurements of goods or works, which are covered by para 3(b) of mentioned Govt. circular and which are not divisible in nature, and in procurement of services where the bid is evaluated on price alone, the 'class-I local supplier' shall get purchase preference over 'Class-II supplier' as well as 'Non-local supplier', as per following procedure:

- i. Among all qualified bids, the lowest bid will be termed as L1. If L1 is 'Class-I local supplier', the contract will be awarded to L1.
- ii. If L1 is not 'Class-I local supplier', the lowest bidder among the 'Class-I local supplier', will be invited to match the L1 price subject to Class-I local supplier's quoted price falling

within the margin of purchase preference, and the contract shall be awarded to such 'Class-I local supplier' subject to matching the L1 price.

iii. In case such lowest eligible 'Class-I local supplier', fails to match the L1 price, the 'Class-I local supplier' with the next higher bid within the margin of purchase preference shall be invited to match the L1 price and so on and contract shall be awarded accordingly. In case none of the 'Class-I local supplier' within the margin of purchase preference matches the L1 prices, the contract may be awarded to the L1 bidder.

c. 'Class-II local supplier' will not get purchase preference in any procurement, undertaken by procuring entities.

F. For this procurement, the local content to categorize a supplier as a Class-I local supplier/ Class-II local supplier/ Non-local supplier and purchase preference to Class-I local supplier, is as defined in Public Procurement (Preference to Make in India), Order 2017 dated 04.06.2020 issued by DPIIT. In case of subsequent orders issued by nodal ministry, changing the definition of local content for the items of the NIT, the same shall be applicable even if issued after issue of this NIT, but before opening of Part-II bids against this NIT.

G. Procurements where estimated value to be procured is less than Rs. 5 lakhs shall be exempted from GOI order No. P-45021/2/2017-PP (BE-II) dated 04.06.2020.

H. For procurement of Goods & Services which are divisible in nature, following shall be operated for **MSE bidders** under Public procurement Policy for the Micro and Small Enterprises (MSEs) Amendment Order, 2019, Ref. No. AA:SSP: MSE: Amndt, dtd. 30.11.2018, Circular No. 44 of 2018-19;-

a. If L1 bid is not from "Class-I local Supplier" and price quoted by MSE bidder falls within the margin of Purchase preference (L1+15% for MSEs), then 25 % of total order quantity of respective item (rounded off to nearest number) shall be awarded to MSE bidder, subject to MSE bidder matching the L1 Price. Out of Remaining 75% quantity, distribution shall be operated as per below sub-clause (2) –

b. If "Class- I Local Supplier" (Next to L1, other than MSE) quoted price falling within the Margin of Purchase Preference, and "Class-I local supplier" matches the L1 price,



## BHARAT HEAVY ELECTRICALS LIMITED

HEEP-HARIDWAR, UTTARAKHAND (249403)

General Instructions and Standard Terms & Conditions for bidding against Tender Enquiry (GISTC)

For Indian Bidders (Version May-2024, Rev: 07)

then 50% of remaining Quantity (after allocation of 25% to MSE) i.e. 37.5% shall be awarded to local supplier and 37.5% shall be awarded to foreign bidder.

*Note: L1 Price refers to lowest evaluated / landed cost to Company.*

For Further details, please refer GOI order no. P-45021 / 2 / 2017 - PP (BE-II) dated 04.06.2020.

### 26. RESTRICTIONS UNDER RULE 144(XI) OF THE GENERAL FINANCIAL RULES (GFRs), 2017

All provisions of Order No. F.No.6/18/2019-PPD of Department of Expenditure (DoE) shall be applicable for this tender enquiry (Order copy is available at <https://doe.gov.in/procurement-policy-divisions>). Accordingly, any bidder from a country which shares a land border with India (except the countries to which the Govt. of India has extended lines of credit or in which the Govt. of India is engaged in development projects for which list is available at <https://www.mea.gov.in/>) will be eligible to bid in this tender only if the bidder is registered with the Competent Authority as specified in Annex I of the said Order of DoE.

Updated list of the countries to which lines of credit have been extended or in which development projects are undertaken are available on the Ministry of External affairs website (<https://www.mea.gov.in/>)

For the purpose of this order, definition of Bidder from a country which shares a land border with India shall be same as defined in the Annex III of the said order.

Registration with the competent authority as stipulated in the said order is responsibility of bidder. Bidder has to submit a certificate certifying following along with offer:

"I have read the clause regarding restrictions on procurement from a bidder of a country which shares a land border with India;

I certify that bidder (... Name of Bidder) is not from such a country or, if from such a country, has been registered with the Competent Authority. I hereby certify that bidder (.....Name of bidder) fulfils all requirements in this regard and is eligible to be considered"

If the bidder is from such country which shares a land border with India evidence of valid registration by the Competent Authority shall also be attached along with offer."

### 27. NOTE.

- a) Special conditions of enquiry, if enclosed by BHEL, will supersede the respective standard / general terms of enquiry.
- b) Any other Standard terms and Conditions of the bidder attached / referred against the tender enquiry will be treated as null and void ab initio.
- c) In order to protect the commercial interests of BHEL, it becomes necessary to take action against suppliers / contractors by way of suspension of business dealings, who either fail to perform or are in default without any reasonable cause, cause loss of business / money / reputation, indulged in malpractices, cheating, bribery, fraud or any other misconducts or formation of cartel so as to influence the bidding process or influence the price etc. Guidelines for Suspension of Business Dealings with Suppliers / Contractors shall prevail over which is available at BHEL website <http://www.bhel.com>
- d) The bidder along with its associate / collaborators / sub-contractors / sub-vendors / consultants / service providers shall strictly adhere to BHEL Fraud Prevention Policy displayed on BHEL website <http://www.bhel.com> and shall immediately bring to the notice of BHEL-Management about any fraud or suspected fraud as soon as it comes to their notice.
- e) "BHEL shall recover the amount of compensation paid to victim(s) by BHEL towards loss of life / permanent disability due to an accident which is attributable to the negligence of contractor, agency or firm or any of its employees as detailed below;
  1. **Victim:** Any person who suffers permanent disablement or dies in an accident as defined below.
  2. **Accident:** Any death or permanent disability resulting solely and directly from any unintended and unforeseen injurious



## BHARAT HEAVY ELECTRICALS LIMITED

HEEP-HARIDWAR, UTTARAKHAND (249403)

General Instructions and Standard Terms & Conditions for bidding against Tender Enquiry (GISTC)

For Indian Bidders (Version May-2024, Rev: 07)

occurrence caused during the manufacturing / operation and works incidental thereto at BHEL factories/ **offices and precincts** thereof , project execution , erection and commissioning, services, repairs and maintenance, trouble shooting, serving , overhaul, renovation and retrofitting , trial operation, performance guarantee testing undertaken by the company or during any works / during working at BHEL Units/ Offices/ townships and premises/ project sites.

### 3. Compensation in respect of each of the victims:

- (i) In the event of death or **permanent disability** resulting from **Loss of both limbs**: Rs. 10,00,000/- (Rs. Ten Lakh).
- (ii) In the event of **other permanent disability**: Rs. 7,00,000/- (Rs. Seven Lakh).

4. Permanent Disablement: A disablement that is classified as a permanent total disablement under the proviso to Section 2(l) of the Employees Compensation Act, 1923.”

f) The bidder shall be in compliance with applicable laws, rules and regulations throughout the terms of the contract for conducting its business generally and to perform its obligations under this contract.

21601870058  
DRAWING NO.

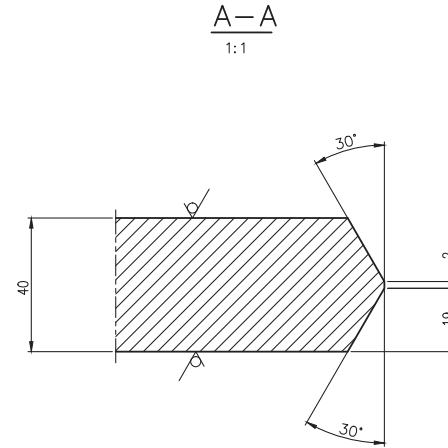
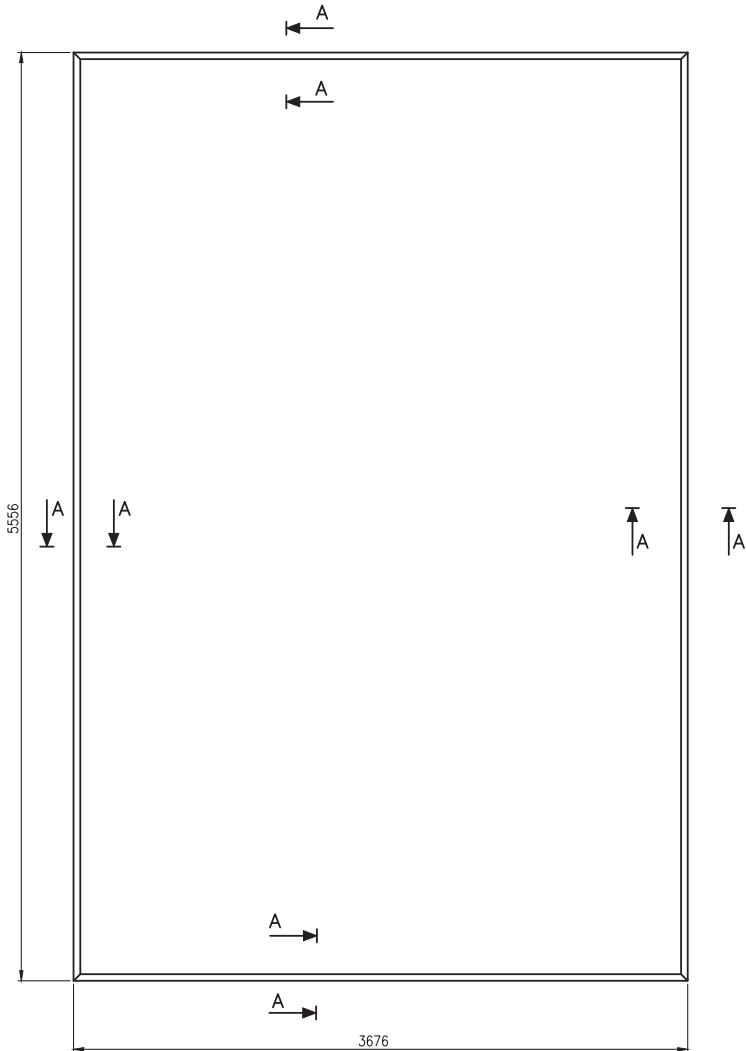

50° THE REST.

**TECH. REQUIREMENTS :-**

1. TUBE HOLES ARE TO BE DRILLED AS PER TUBE LAYOUT DRG.NO. 01600070063.
2. PAINTING & PRESERVATION IS TO BE DONE AS PER HXE PRODUCT STD. NO. HE 77001.

**NOTE:-**

1. WEIGHT OF UNDRILLED TUBE PLATE = 6413.00 Kgs.

COPYRIGHT AND CONFIDENTIAL  
 THE INFORMATION ON THIS DOCUMENT IS THE PROPERTY OF BHARAT HEAVY ELECTRICALS LIMITED  
 IT MUST NOT BE USED DIRECTLY OR INDIRECTLY IN ANY WAY DETRIMENTAL TO THE INTEREST OF THE COMPANY.

REF. DRG. NO.

SIGN. & DATE

INVENTORY NO.

CBOM NO. 11601870038	STATUS OF DRG.
AGREED REV. NAME SIGN DATE	WT. BL. MEENA Sd. 06.2.2020

TYPE OF PRODUCT OR NAME OF CUSTOMER/ PROJECT			
--	--	--	--

GRADE OF UNTOL. DIM.:-			
M/CG- Y/Q/M/P AA 0230208			
WELDING-A/B/C/D-AA621104			
GAS CUTTING-T3'AA0621101			

NAME	SIGN	DATE	NO. OF VAR.
DRN T.BANSAL	Sd.	06.02.2020	
CHD AXAY	Sd.	06.02.2020	
APD N.P.	Sd.	06.03.2020	73, 74

REV.	DATE	ALTERED CHECKED	REV.	DATE	ALTERED CHECKED

DEPT. HXE	SCALE	WEIGHT(Kg.)	REF. TO ASSY. DRG.	ITEM NO.	NO. OF ITEMS
CODE 4222	N.T.S.	4316	11601870038	01	75, 77

TITLE	DRAWING NO.
MAIN TUBE PLATE	21601870058
	SHEET NO. 01   NO. OF SHEETS 01

1:1

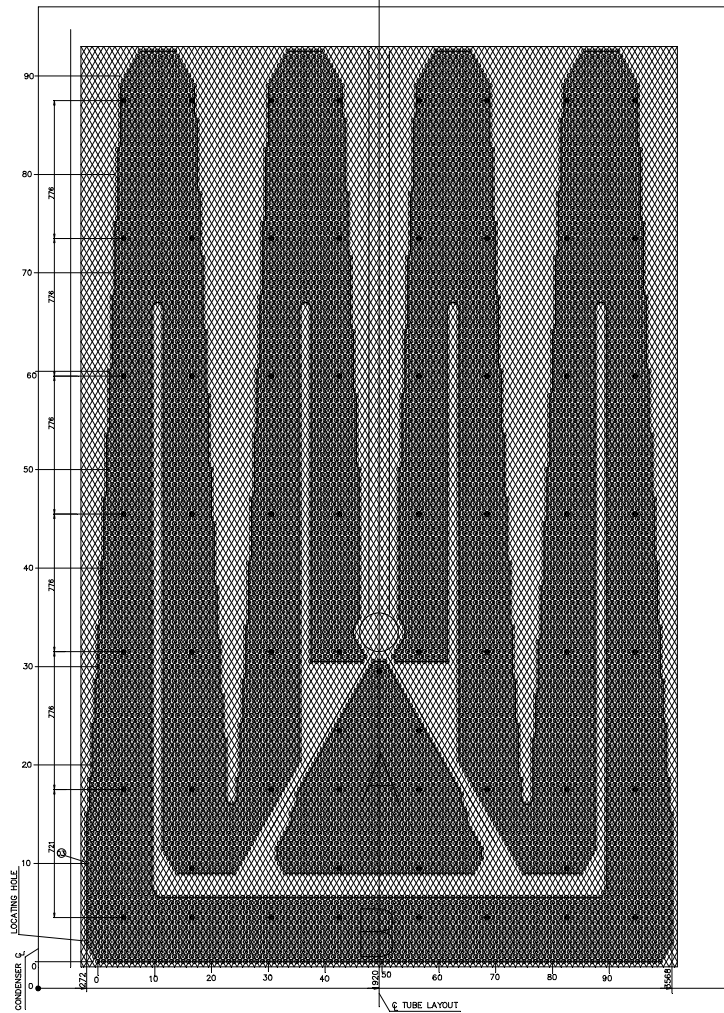

MAIN TUBE PLATE (RS)  
1:2

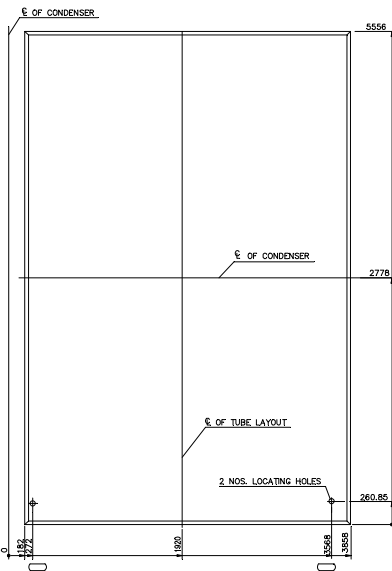

SUPPORT TUBE PLATE  
1:2

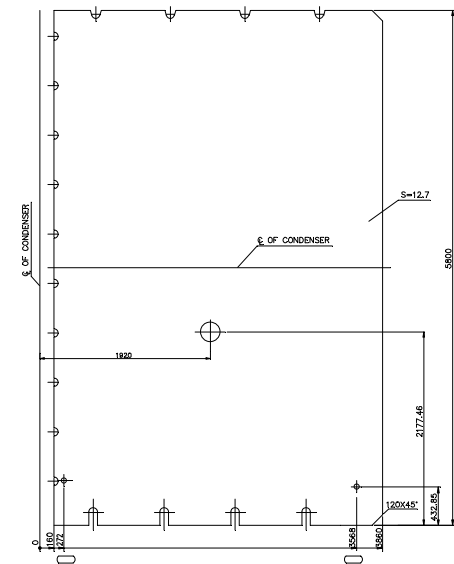

NOTES :-

1. NO. OF TUBE HOLES IN EACH SUPPORT PLATE = 13263 NOS.
2. NO. OF TUBE HOLES IN EACH MAIN TUBE PLATE = 13200 NOS.
3. HOLE SIZES ARE AS SHOWN IN THE DETAIL 1 & II.
4. TUBE SIZE :- 25X0.7112 mm., TOP TWO ROWS DIA 25X0.889 mm (172 NO.)  
= 32 mm.
5. PITCH = 32 mm.
6. TOLERANCE ON PITCH ± 1 mm.
7. CUMULATIVE TOLERANCE ON PITCHES ±2.0 mm
8. MINIMUM LIGAMENT BETWEEN HOLES SHOULD NOT BE LESS THAN 1 mm FROM NOMINAL.
9. NO SPIRAL OR AXIAL GROOVES IN HOLES ARE ALLOWED.
10. UP TO 4% OF HOLES MAY BE ALLOWED WITH MAXIMUM SURFACE FINISH IN TUBE PLATE AND TUBE SUPPORT PLATE RESPECTIVELY.
11. MINIMUM LIGAMENT BETWEEN HOLES SHOULD NOT BE LESS THAN 1 mm FROM NOMINAL.
12. RADIUS OF 1 MM ON BOTH SIDE OF HOLES IS FOR REMOVING BURRS FROM HOLES ONLY.
13. THE LAYOUT SHOWN IS FOR THE RIGHT HAND SIDE. LAYOUT FOR THE OTHER HALF IS THE MIRROR IMAGE OF THIS LAYOUT.
14. HOLES MARKED ◆ ARE NOT TO BE DRILLED ON MAIN TUBE PLATE.
15. □ - THIS INDICATES CRITICAL TO QUALITY (CTQ).
16. DRILLED HOLES OF MAIN TUBE PLATE AND SUPPORT PLATES ARE TO BE MATCHED IN SHOP FOR CONCENTRICITY.
17. FOR THE ROD HOLES ◆ REFER DETAILS-III. THESE HOLES WILL BE DRILLED ONLY ON SUPPORT TUBE PLATE.

REFERENCE DRAWINGS :-

1. MAIN TUBE PLATE 21601670058
2. TUBE SUPPORT PLATE 21602870056-APPLICABLE FOR KHURJIA 660 MW PROJECT
3. TUBE SUPPORT PLATE 21602870057-APPLICABLE FOR SAGARDIGA 660 MW PROJECT

DETAIL OF TUBE HOLES :-

SEGMENT	MAIN TUBE PLATE		SUPPORT TUBE PLATE	
	TOTAL HOLES	PERIPHERAL HOLES	TOTAL HOLES	PERIPHERAL HOLES
A	993	115	1000	115
B	12207	1401	12263	1401
TOTAL	13200	1516	13263	1516

TUBE LAYOUT ARRANGEMENT  
10:1

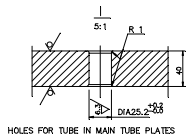
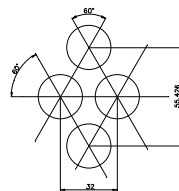

HOLES FOR TUBE IN MAIN TUBE PLATES

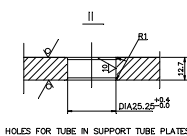

HOLES FOR TUBE IN SUPPORT TUBE PLATES

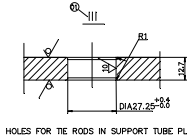

HOLES FOR THE RODS IN SUPPORT TUBE PLATES

GRADE OF UNTOI.DIM		CHECK		NAME OF CUSTOMER/PROJECT	
UN/CS-5/M/F	1402/202008	01602870073	01602870073	BHARAT HEAVY ELECTRICALS LTD.	
WELDING-4/3/2/1	ANGSD104	NO HOLE	NO HOLE	RANPUR, HARDWAR	
GAS CUTTING-13/A0621101					
REV	DATE	ALTERED	BY	DATE	ALTERED
1	12/20/07	1401	12263	1401	12263
DEPT. FHE		SCALE		WEIGHT (KGS)	
CODE 4222		1:1		01602870073	
TITLE		CARD		REF. TO ASSY. DRG.	
TUBE LAYOUT		CODE 4222		01600070063	
		DRAWING NO.		REV.	
		01600070063		04	
		SHEET No.		04	
		OF No. OF SHEETS		04	

THE INFORMATION ON THIS DOCUMENT IS THE PROPERTY OF BHARAT HEAVY ELECTRICALS LIMITED. IT MUST NOT BE REPRODUCED, COPIED, STORED IN A RETRIEVAL SYSTEM OR TRANSMITTED IN ANY FORM OR BY ANY MEANS, WITHOUT THE WRITTEN PERMISSION OF THE COMPANY.



A Maharatna Company

एन टी पी सी लिमिटेड  
(भारत सरकार का उद्यम)  
NTPC Limited  
(A Govt. of India Enterprise)  
(Formerly National Thermal Power Corporation Ltd.)  
(केंद्रीय कार्यालय नोएडा)  
Corporate Center NOIDA

Reference : CC-ENGG-4540-001-110-QVM-Q-201

Date : 16/01/2023

From : CHANDEKAR PRADEEP GOPAL  
DY. GENERAL MANAGER

To : BHARAT HEAVY ELECTRICALS LTD  
NEW DELHI  
110049  
IN

Cc : sisodia@bhel.in

Subject : EPC TTPP3 (2x660MW)

Please find enclosed following drawings/ documents for necessary action at your end.

Vendor Drg. No. : 2.01.02  
Orgn. Drg. No. : 4540-001-110-QVM-Q-201  
Revision No. : 01  
Drg. Title : CONDENSER TUBE PLATES-ENDORSEMENT  
App. Category : CAT-I  
Release Date : 16/01/2023



Scan to verify

Comments : Endorsed in Cat-I for Talcher-III EPC Package



Engineering Division  
ISO 9001:2008 Certified

अभियंत्रिकी कार्यालय परिसर, प्लॉट नं.- ए 8ए, सेक्टर-24, पोस्ट बॉक्स नं.- 13, नोएडा (उ.प.) पिन-201 307  
टेलिफोन नं.- 0120-2410333, 2410116 फैक्स-0120-2410136, 2410137  
पंजीकृत कार्यालय: एनटीपीसी भवन, स्कोप कॉम्प्लेक्स, 7 इंस्टीट्यूशनल एरिया, लोडू रोड, नई दिल्ली-110 003  
टेलिफोन नं.- 011-24361018 फैक्स-011-24361018, वेबसाइट: www.ntpc.co.in  
ENGINEERING OFFICE COMPLEX, Plot No. A-8A, Sector-24, Post Box No: 13, Noida (UP), Pin-201 307  
Telephone No: 0120-2410333, 2410116 Fax-0120-2410136, 2410137  
Registered Office: NTPC Bhawan, Scope Complex, 7 Institutional Area, Lodhu Road, New Delhi-110 003  
Telephone No: 011 24360100 Fax: 011 24361018, Website: www.ntpc.co.in

Endorsed in Cat-I for Talcher-III EPC Package

<b>ENDORSEMENT SHEET FOR QP</b>	
<b>REFERENCE / <del>STANDARD</del> / <del>FIELD</del> QUALITY PLAN (RQP / SQP/RFQP/SFQP)</b>	
<b>TO BE FILLED IN BY SUPPLIER AT TIME OF SUBMISSION</b>	<b>To be filled in by NTPC</b>
<b>PROJECT NAME</b>	<b>REVIEW &amp; ENDORSEMENT BY NTPC</b>
<b>CONTRACT NO.:</b>	<b>PROJECT SPECIFIC QP NUMBER ALLOTTED</b>
<b>MAIN SUPPLIER</b>	<b>QP NO.: 4540-001-110-QVM-Q-201</b>
<b>MANUFACTURER WORKS &amp; ADDRESS</b>	<b>DOC TITLE: CONDENSER TUBE PLATES- ENDORSEMENT</b>
<b>ITEM/EQUIPMENT / SYSTEM/ SUB-SYSTEM DETAILS i.e. MODEL TYPE/SIZE/RATING etc.</b>	<b>REV. NO.: 01      DATE:</b>
<b>APPROVED QP NO.: RQP/SQP/RFQP/SFQP</b>	<b>(TICK APPLICABLE)</b>
<i>Confirmation by Main Supplier (TICK WHICHEVER APPLICABLE)</i>	
<p><input checked="" type="checkbox"/> I. That the item/ component is identical to that considered for QP approval. OR.</p> <p><input type="checkbox"/> II. That there are minor changes in the item/ component with respect to that considered for QP approval, however the same do not affect the contents of QP. OR</p> <p><input type="checkbox"/> III. That there are minor changes in the item/ component with respect to that considered for QP approval, however the same affect the QP slightly, as indicated below / in attached sheet.</p>	
<b>SIGN.: (Main Supplier)</b>	<b>SIGN.: (Manufacturer)</b>
<b>DATE: 05.01.2023</b>	<b>DATE:</b>
<p><b>DISTRIBUTION OF ENDORSEMENT OF</b></p> <p><b>A) RQP/SQP:</b></p> <p>1. MAIN SUPPLIER (WITH A COPY OF QP)</p> <p>2. MANUFACTURER</p> <p>3. RIO</p> <p>4. CQA-SPL</p> <p>5. CQA-O/C</p> <p><b>B) RFQP/SFQP:</b></p> <p>1. MAIN SUPPLIER (with a copy of QP)</p> <p>2. MANUFACTURER</p> <p>3. NTPC FQA (with a copy of QP)</p> <p>4. NTPC Erection (with a copy of QP)</p> <p>5. CQA-SPL</p> <p>6. CQA-O/C</p>	
<b>NTPC (Reviewed /Approved by/ Date &amp; Seal)</b>	



Reference: null371:380

Project: Talcher Thermal Power Project St-III (2x660MW)  
NTPC Doc No:4540-001-110-QVM-Q-201, Rev-1  
Doc Title: CONDENSER TUBE PLATES-ENDORSEMENT

Date:05-02-20

From:	VIVEK P SRIVASTAVA AGM , PE -TF	To:	BHEL BHEL house, Siri Fort New Delhi-110049
		CC:	- -
<b>SUBJECT : KHURJA, TURBINE GENERATOR AND ASSOCIATED PACKAGE</b>			
Please find enclosed following drawings/documents for necessary action at your end as indicated in purpose code.			
VENDOR DRG NO:	null		
NTPC DRG NO:	9915-371-110-HWR-QVM-Q-121		
REVISION NO:	01		
DRG TITLE:	MQP for MAIN TUBE PLATE AND SUPPORT TUBE PLATE		
APP CATEGORY:	I		
RELEASE DATE:	05-02-20		
COMMENTS:	CAT-I		



Engineering Division  
ISO 9001:2008 Certified

अभियांत्रिकी कार्यालय परिसर, प्लॉट नं.- ए 8ए, सेक्टर-24, पोस्ट बॉक्स नं.- 13, नोएडा (उ प्र) पिन-201 307

टेलिफोन नं.- 0120-2410333, 2410116 फैक्स-0120-2410136, 2410137

पंजीकृत कार्यालय: एनटीपीसी भवन, स्कोप कॉम्प्लेक्स, 7 इंस्टीट्यूशनल एरिया, लोधी रोड, नई दिल्ली-110 003

टेलिफोन नं.- 011-24361018 फैक्स-011-24361018, वेबसाइट: www.ntpc.co.in

ENGINEERING OFFICE COMPLEX, Plot No: A-8A, Sector-24, Post Box No: 13, Noida (UP), Pin-201 307

Telephone No: 0120-2410333, 2410116 Fax-0120-2410136, 2410137

Registered Office: NTPC Bhawan, Scope Complex, 7 Institutional Area, Lodhi Road, New Delhi-110 003

Telephone No: 011-24360100 Fax-011-24361018, Website: www.ntpc.co.in

*Chandekar*

## MANUFACTURING QUALITY PLAN

**PROJECT:** KHURJA STPP (2 X 660 MW)  
**PACKAGE:** MAIN PLANT PACKAGE  
**CONTRACT NO.:** 9915-371  
**MAIN SUPPLIER:** BHEL, Haridwar

**ITEM:** CONDENSER MAIN TUBE PLATE AND SUPPORT TUBE PLATE  
**QP NO.:** 2.01.02  
**REV.:** 01  
**DATE:** 03-FEB-2020  
**PAGE 1 OF 1**

**SUB SYSTEM:** 16018, 16019, 16023, 16024, 16028

SL. NO	COMPONENT & OPERATIONS	CHARACTERISTICS	CLASS	TYPE OF CHECK	QUANTUM OF CHECK	REFERENCE DOCUMENT	ACCEPTANCE NORMS	FORMAT OF RECORDS			AGENCY			REMARKS
								S	B	C	S	B	C	
1	2	3	4	5	6	7	8	9	D	10			11	

1.000	Material receiving inspection as per QP clause no. 1.000 of QP no.2.01.01													
2.000	In process inspection													
2.100		Diameter of tube plate holes & ovality	Major	Measurement	As per Logsheet	Drawing	Drawing	Logsheet	✓	P*	P/W*	W	Random witness of 100 holes for each tube plate by customer/customer nominated inspection agency.	
2.200		Ligament thickness	Major	Measurement	As per Logsheet	Drawing	Drawing	Logsheet	✓	P*	P/W*	W		
2.300		Surface finish of holes	Major	Measurement	As per Logsheet	Drawing	Drawing	Logsheet	✓	P*	P/W*	W		
2.400		Dimension and visual inspection of tube plate	Major	Measurement & visual	100%	Drawing	Drawing	Obs. Sheet		P*	P/W*	-		
3.000	Final inspection													
3.100		Predespatch inspection	Major	Visual	100%	Drawing	Drawing	COC		-	P	-		

Note: \*- In case of offloading on BHEL approved sub-contractors.

**Signature Not Verified**  
 by NIRENDRA SONIKAR  
 Date: 2020.02.05 12:19:54 IST  
 Reason: CAT I

			Legend: Records identified with "tick" shall be submitted to customer as a QA Documentation package. S= sub-vendor, B= BHEL/ BHEL nominated inspection agency, C= Customer/customer representative, P= Perform, V= Review of records W= Customer witness (not hold, BHEL to give advance notice and customer to Associate but work will not stop. CHP= Customer Hold Point (work will not proceed unless the clearance from customer)
			Approved By: (A K Swami) <b>MAIN-SUPPLIER</b>
			<b>SIGNATURE</b>
			Location: NTPCEOC DOC.NO. 9915-371-110-HWR-QVM-Q-121 REV 01 CAT. ....
			FOR CUSTOMER USE REVIEWED BY APPROVED BY APPROVAL SEAL