

=====

## TENDER SPECIFICATION

TENDER NO. BHEL/NR/SCT/LALITPUR/STORE SHED/858

**FOR**

**“CONSTRUCTION & DEVELOPMENT OF BHEL SITE OFFICE , CLOSED & SEMI  
CLOSED STORAGE SHEDS AND OPEN YARD FOR 3X660 MW UNITS AT  
LALITPUR STPS AT LALITPUR, UP.”**

### **PART I – TECHNICAL BID**



**Bharat Heavy Electricals Limited**  
(A Govt. Of India Undertaking)  
**Power Sector – Northern Region,**  
**Plot No. 25 , Sector - 16A ,**  
**Distt. Gautam Budh Nagar, NOIDA – 201 301(INDIA)**



ISO 9001, ISO 14001 OHSAS  
18001 and SA 8000 certified  
company  
SubContract and Purchase  
Deptt.

**Bharat Heavy Electricals Limited**

(A Govt. Of India Undertaking)

**Power Sector – Northern Region,**

**Plot No. 25 , Sector - 16A ,**

**Distt. Gautam Budh Nagar, NOIDA – 201 301(INDIA)**

**Phone: 0091-0120-2416273 / 6540**

**Fax 091-0120-2416528/ 2515467**

**Email: [swapan](mailto:swapan@bhel.com)@bhel.com**

**TENDER NO. BHEL/NR/SCT/ LALITPUR/STORE SHED/858**

**IMPORTANT NOTE**

PURCHASER OF THIS TENDER DOCUMENT IS ADVISED TO CHECK AND ENSURE COMPLETION OF ALL PAGES OF TENDER DOCUMENT AND REPORT ANY DISCREPANCY TIMELY FOR CORRECTIVE ACTION, IF ANY, TO THE ISSUING AUTHORITY BEFORE THE BIDS ARE SUBMITTED. ORIGINAL COPY OF TENDER DOCUMENT COMPLETE IN ALL RESPECTS MUST BE SUBMITTED BACK AS PART OF THE BID WITHOUT WHICH THE SAME IS LIABLE TO BE REJECTED BY BHEL.

THIS TENDER SPECIFICATION ISSUED TO:

M/S-----  
-----  
-----  
-----

Rev 00  
6th July  
2010

# NOTICE INVITING TENDER

(Document No. PS: MSX: NIT)

Bharat Heavy Electricals Limited



**NOTE: BIDDER MAY DOWNLOAD FROM WEB SITES  
OR  
PURCHASE TENDERS FROM THIS OFFICE ALSO**

To

Dear Sir/Madam,

**Sub: NOTICE INVITING TENDER**

Sealed offers in two part bid system are invited from reputed & experienced bidders (meeting PRE QUALIFICATION CRITERIA as mentioned in Annexure-I) for the subject job by the undersigned on the behalf of BHARAT HEAVY ELECTRICALS LIMITED as per the tender document. Following points relevant to the tender may please be noted and complied with.

**1.0 Salient Features of NIT**

SL NO	ISSUE	DESCRIPTION	
i	TENDER NUMBER	BHEL/NR/SCT/ LALITPUR/STORE SHED/858	
ii	Broad Scope of job	Construction & Development of BHEL Site Office , Closed & Semi Closed Storage Sheds and Open Yard for 3X660 MW units at Lalitpur STPS at Lalitpur, UP	
iii	<b>DETAILS OF TENDER DOCUMENT</b>		
a	Volume-IA	<i>Technical Conditions of Contract (TCC) consisting of Scope of work, Technical Specification, Drawings, Procedures, Bill of Quantities, Terms of payment, etc</i>	Applicable
b	Volume-IB	<i>Special Conditions of Contract (SCC)</i>	Applicable
c	Volume-IC	<i>General Conditions of Contract (GCC)</i>	Applicable
d	Volume-ID	<i>Forms and Procedures</i>	
e	Volume-II	<i>Price Schedule (Absolute value).</i>	Applicable
iv	Issue of Tender Documents	<ol style="list-style-type: none"> <li><b>Sale from BHEL PSNR,NOIDA office at : Start:21.01.2012,Time:From0900 to 1200 Hrs Close: 27.01.2012, Time :1200 Hrs</b></li> <li>From BHEL website (<a href="http://www.bhel.com">www.bhel.com</a>) Tender documents can however be downloaded from website till due date of submission</li> </ol>	Applicable
v	DUE DATE & TIME OF OFFER SUBMISSION	<b>Date: 27.01.2012, Time: 1500 Hrs. Place : Noida (UP)</b>	Applicable
vi	OPENING OF TENDER	<b>1/2 hour after the latest due date and time of Offer submission</b> Notes: (1) In case the due date of opening of tender becomes a non-working day, tenders shall be opened on next working day at the same time. (2) Bidder may depute representative to witness the opening of tender	Applicable
vii	EMD AMOUNT	<b>Rs 2,00,000/-</b>	Applicable
viii	COST OF TENDER	<b>NIL</b>	Applicable/Not Applicable
ix	LAST DATE FOR SEEKING CLARIFICATION	<b>Date: 24.01.2012.</b> Along with soft version also, addressing to undersigned & to others as per contact address given	Applicable

		<i>below</i>	
x	<b>SCHEDULE OF Pre Bid Discussion (PBD)</b>	<b>Date : -- / -- / -- -- -- , Time : Place :</b>	<i>Applicable/Not Applicable</i>
xi	<b>INTEGRITY PACT &amp; DETAILS OF INDEPENDENT EXTERNAL MONITOR (IEM)</b>	Shri Kanwarjit Singh, IRS (Rtd.) D-6/12, Ground Floor, Vasant Vihar, New Delhi - 110 057	<i>Applicable/Not Applicable</i>
xii	<b>Latest updates</b>	Latest updates on the important dates, Amendments, Correspondences, Corrigenda, Clarifications, Changes, Errata, Modifications, Revisions, etc to Tender Specifications will be hosted in BHEL webpage ( <a href="http://www.bhel.com">www.bhel.com</a> -->Tender Notifications →View Corrigendums) <b>and not in the newspapers</b> . Bidders to keep themselves updated with all such information	

- 2.0 The offer shall be submitted as per the instructions of tender document and as detailed in this NIT. Bidders to note specifically that all pages of tender document, including these NIT pages of this particular tender together with subsequent correspondences shall be submitted by them, duly signed & stamped on each page, as part of offer. **Rates/Price including discounts/rebates, if any, mentioned anywhere/in any form in the techno-commercial offer other than the Price Bid, and shall not be entertained.**
- 3.0 Unless specifically stated otherwise, bidder shall remit cost of tender and courier charges if applicable, in the form of Demand Draft drawn in favour of Bharat Heavy Electricals Ltd, payable at Power Sector Regional HQ at Noida issuing the Tender, along with techno-commercial offer. Bidder may also choose to deposit the Tender document cost by cash at the Cash Office as stated above against sl no iv of 1, on any working day; and in such case copy of Cash receipt is to be enclosed with the Techno Commercial offer. Sale of tender Documents shall not take place on National Holidays, holidays declared by Central or State Governments and BHEL PS HQ at Noida, Sundays and second/ last Saturdays
- 4.0 Unless specifically stated otherwise, bidder shall deposit EMD through Demand Draft/Pay Order in favour of Bharat Heavy Electricals Ltd, payable at Noida. For other details and for 'One Time EMD' please refer General Conditions of Contract.
- 5.0 **Procedure for Submission of Tenders:** The Tenderers must submit their Tenders to Officer inviting Tender, as detailed below:
- PART-I consisting of 'PART-I A (Techno Commercial Bid)' & 'PART-I B (EMD/COST of TENDER)' in two separate sealed and superscribed envelopes (ENVELOPE-I & ENVELOPE-II)
  - PART-II (Price Bid) – in sealed and superscribed envelope (ENVELOPE-III)
- 6.0 The contents for ENVELOPES and the superscription for each sealed cover/Envelope are as given below. **(All pages to be signed and stamped)**

Sl no	Description	Remarks
	<b>Part-I A</b>	
	<b>ENVELOPE – I superscribed as :</b> PART-I (TECHNO COMMERCIAL BID) TENDER NO : NAME OF WORK: PROJECT: DUE DATE OF SUBMISSION:	
	<b>CONTAINING THE FOLLOWING:-</b>	
i.	Covering letter/Offer forwarding letter of Tenderer.	

ii.	Duly filled-in 'No Deviation Certificate' as per prescribed format to be placed after document under sl no (i) above.  <b>Note:</b> a. In case of any deviation, the same should be submitted separately for technical & commercial parts, indicating respective clauses of tender against which deviation is taken by bidder. The list of such deviation shall be placed after document under sl no (i) above. It shall be specifically noted that deviation recorded elsewhere shall not be entertained. b. BHEL reserves the right to accept/reject the deviations without assigning any reasons, and BHEL decision is final and binding. i). In case of acceptance of the deviations, appropriate loading shall be done by BHEL ii). In case of unacceptable deviations, BHEL reserves the right to reject the tender	
iii.	Supporting documents/ annexure/ schedules/ drawing etc as required in line with Pre-Qualification criteria.  It shall be specifically noted that all documents as per above shall be indexed properly and credential certificates issued by clients shall distinctly bear the name of organization, contact ph no, FAX no, etc.	
iv.	All Amendments/Correspondences/Corrigenda/Clarifications/Changes/ Errata etc pertinent to this NIT.	
v.	Integrity Pact Agreement (Duly signed by the authorized signatory)	If applicable
vi.	Duly filled-in annexure, formats etc as required under this Tender Specification/NIT	
vii.	Notice inviting Tender (NIT)	
viii.	Volume – I A : <u>Technical</u> Conditions of Contract (TCC) consisting of Scope of work, Technical Specification, Drawings, Procedures, Bill of Quantities, Terms of payment, etc	
ix.	Volume – I B : Special Conditions of Contract (SCC)	
x.	Volume – I C : General Conditions of Contract (GCC)	
xi.	Volume – I D : Forms & Procedures	
xii.	Volume – II (UNPRICED – without disclosing rates/price, but mentioning only 'QUOTED' or 'UNQUOTED' against each item	
xiii.	Any other details preferred by bidder with proper indexing.	

	<b>PART-I B</b>	
	<b>ENVELOPE – II superscribed as:</b> PART-I (EMD/COST of TENDER) TENDER NO : NAME OF WORK: PROJECT: DUE DATE OF SUBMISSION:  <b>CONTAINING THE FOLLOWING:-</b>	
i.	1. Earnest Money Deposit (EMD) in the form as indicated in this Tender <b>OR</b> Documentary evidence for 'One Time EMD' with the Power Sector Region of BHEL floating the Tender  2. Cost of Tender ( Demand Draft or copy of Cash Receipt as the case may be)	

	<b>PART-II</b>	
	<b>PRICE BID</b> consisting of the following shall be enclosed	
	<b>ENVELOPE-III</b>	

	superscribed as: PART-II (PRICE BID) TENDER NO : NAME OF WORK: PROJECT: DUE DATE OF SUBMISSION:  <b>CONTAINING THE FOLLOWING</b>	
i	Covering letter/Offer forwarding letter of Tenderer enclosed in Part-I	
ii	Volume II – PRICE BID ( Duly Filled in Schedule of Rates – rate/price to be entered in words as well as figures)	

	<b>OUTER COVER</b>	
	<b>ENVELOPE-IV</b> (MAIN ENVELOPE / OUTER ENVELOPE) superscribed as: TECHNO-COMMERCIAL BID, PRICE BID & EMD TENDER NO : NAME OF WORK: PROJECT: DUE DATE OF SUBMISSION:  <b>CONTAINING THE FOLLOWING:</b>	
i	<ul style="list-style-type: none"> <li>○ Envelopes I</li> <li>○ Envelopes II</li> <li>○ Envelopes III</li> </ul>	

**SPECIAL NOTE:** All documents/ annexure submitted with the offer shall be properly annexed and placed in respective places of the offer as per enclosure list mentioned in the covering letter. BHEL shall not be responsible for any missing documents.

- 7.0 No Deviation with respect to tender clauses and no additional clauses/ suggestions/ in Techno-commercial bid/ Price bid shall normally be considered by BHEL. Bidders are requested to positively comply with the same.
- 8.0 BHEL reserves the right to accept or reject any or all Offers without assigning any reasons thereof. BHEL also reserves the right to cancel the Tender wholly or partly without assigning any reason thereof. Also BHEL shall not entertain any correspondence from bidders in this matter (except for the refund of EMD).

#### 9.0 **Assessment of Capacity of Bidders:**

**Bidders capacity for executing the job under tender shall be assessed as per the following:**

- i. **Assigning Weightages (A) for Similar Jobs Under-Execution:** Weightages shall be worked out and assigned based on the average number of Similar Works under execution including works yet to be commenced by the agency, in the following manner:
  - i). **Number of Similar Jobs**
    - a) No. of jobs in BHEL, PSER : Say 'J'
    - b) No. of jobs in BHEL, PSSR : Say 'K'
    - c) No. of jobs in BHEL, PSWR : Say 'L'
    - d) No. of jobs in BHEL, PSNR : Say 'M'
    - e) No. of jobs with other customers\* : Say 'N' (\*: Other than BHEL PSER, PSSR, PSWR & PSNR)
    - f) Average No. of Jobs is 'P' = (J+K+L+M+N) divided by 5
  - ii) **Weightage "A" assigned to bidders based on Average Number of jobs "P":**
    - a) If 'P' = 0-1, "A" will be equal to '3'
    - b) If 'P' = 2-3, "A" will be equal to '2'
    - c) If 'P' = 4-5, "A" will be equal to '1'
    - d) If 'P' is Above 5, "A" will be equal to '0'

- II. **Weightage “B” for Quarterly Performance Reports of Vendors:** This shall be based on the averages of the net weighted score obtained by the bidder for the jobs under execution (excluding works not commenced) for the quarter previous to the last quarter reckoned from the date of latest due date of submission, in all four Regions i.e BHEL PSER, PSSR, PSWR & PSNR, in the following manner.

i). **Ratings by Power Sector Region:**

- a) PS ER's Rating 'Rer' =  $(X_1 + X_2 + \dots + X_n)$  divided by n
- b) PS WR's Rating 'Rwr' =  $(X_1 + X_2 + \dots + X_n)$  divided by n
- c) PS SR's Rating 'Rsr' =  $(X_1 + X_2 + \dots + X_n)$  divided by n
- d) PS NR's Rating 'Rnr' =  $(X_1 + X_2 + \dots + X_n)$  divided by n
- e) **Over all Power Sector Region Rating 'R<sub>BHEL</sub>' = (Rer+ Rwr+ Rsr+ Rnr) divided by 4**

(where “X<sub>1</sub>, X<sub>2</sub>, X<sub>3</sub>,...X<sub>n</sub>” is the net weighted score obtained by the bidder as per the “Evaluation of Contractor Performance (Quarterly)” against the various contracts ‘n’ under execution in the respective Region).

ii) **Weightage “B” assigned to bidders based on Overall Power Sector Rating (R<sub>BHEL</sub>):**

- a) If R<sub>BHEL</sub> is 80% and above, “B” will be equal to ‘6’
- b) If R<sub>BHEL</sub> is > 70% < 80%, “B” will be equal to ‘5’
- c) If R<sub>BHEL</sub> is > 60% < 70%, “B” will be equal to ‘4’
- d) If R<sub>BHEL</sub> is < 60%, “B” will be equal to ‘0’

- III. **Evaluation of Bidders capacity to execute the job under tender:** shall be based on the sum of scores obtained in ‘A’ and ‘B’, as below:

- a) **6 or above : Considered ‘Qualified’ for the job under tender**
- b) **Less than 6: Considered ‘NOT Qualified’ for the job under tender**

IV. **Explanatory note:**

- a) Similar work means Boiler or Turbine or Civil or Electrical or CI, etc irrespective of rating of Plant
- b) Quarter shall be as per the quarter defined in the “Evaluation of Contractor performance (Quarterly)”. For contracts where annexed Quarterly Evaluation performance was not part of the contract, ‘Quarterly Performance Reports’ previous to the last quarter reckoned from the date of latest due date of submission, given by the respective project site against the contract will be the basis for evaluation.
- c) Vendors who are not executing any jobs presently in the Region and first timers to the Region, may be considered subject to satisfying all other tender conditions
- d) ‘Under execution’ shall mean works in progress upto Boiler Steam Blowing (for Boiler and Auxilliaries) or Synchronisation (for all other jobs including Civil) shall be considered.

10.0 Since the job shall be executed at site, bidders must visit site/ work area and study the job content, facilities available, availability of materials, prevailing site conditions including law & order situation etc before quoting for this tender. They may also consult this office before submitting their offers, for any clarifications regarding scope of work, facilities available at sites or on terms and conditions. No additional claim shall be entertained by BHEL in future, on account of non-acquaintance of above.

11.0 For any clarification on the tender document, the bidder may seek the same in writing or through e-mail, as per specified format, within the scheduled date for seeking clarification, from the office of the undersigned. BHEL shall not be responsible for receipt of queries after due date of seeking clarification due to postal delay or any other delays. Any clarification / query received after last date for seeking clarification may not be normally entertained by BHEL and no time extension will be given.

- 12.0 BHEL may decide holding pre-bid discussion [PBD] with all intending bidders as per date indicated in the NIT. The bidder shall ensure participation for the same at the appointed time, date and place as may be decided by BHEL. Bidders shall plan their visit accordingly. The outcome of pre-bid discussion (PBD) shall also form part of tender.
- 13.0 In the event of any conflict between requirement of any clause of this specification/ documents/drawings/data sheets etc or requirements of different codes/standards specified, the same to be brought to the knowledge of BHEL in writing for clarification before due date of seeking clarification (whichever is applicable), otherwise, interpretation by BHEL shall prevail. Any typing error/missing pages/ other clerical errors in the tender documents, noticed must be pointed out before pre-bid meeting/submission of offer, else BHEL's interpretation shall prevail.
- 14.0 Unless specifically mentioned otherwise, bidder's quoted price shall deemed to be in compliance with tender including PBD.
- 15.0 Bidders shall submit Integrity Pact Agreement (Duly signed by authorized signatory who signs in the offer), **if applicable**, along with techno-commercial bid. This pact shall be considered as a preliminary qualification for further participation. **The names and other details of Independent External Monitor (IEM) for the subject tender is as given at point (xi) of 1 above.**
- 16.0 The Bidder has to satisfy the Pre Qualifying Requirements stipulated for this Tender in order to be qualified. The Price Bids of only those bidders will be opened who will be qualified for the subject job on the basis of pre-qualification evaluation/ techno-commercial bids, approval/ acceptance of customer (as applicable), etc. and date of opening of price bids shall be intimated to only such bidders.
- 17.0 In case BHEL decides on a 'Public Opening', the date & time of opening of the sealed PRICE BID shall be intimated to the qualified bidders and in such a case, bidder may depute one authorised representative to witness the price bid opening. BHEL reserves the right to open 'in-camera' the 'PRICE BID' of any or all Unsuccessful/Disqualified bidders under intimation to the respective bidders.
- 18.0 Validity of the offer shall be for **six months** from the latest due date of offer submission (including extension, if any) or specified otherwise in SCC of tender.
- 19.0 BHEL reserves the right to decide the successful bidder on the basis of Reverse Auction process. In such case all qualified bidders will be intimated regarding procedure/ modality for Reverse Auction process prior to Reverse Auction and price will be decided as per the rules for Reverse Auction. .

However, if reverse auction process is unsuccessful as defined in the RA rules/procedures, or for whatsoever reason, then the sealed 'PRICE BIDS' will be opened for deciding the successful bidder. BHEL's decision in this regard will be final and binding on bidder.

- 20.0 On submission of offer, further consideration will be subject to compliance to tender & qualifying requirement and customer's acceptance, as applicable.
- 21.0 In case the bidder is an "Indian Agent of Foreign Principals", 'Agency agreement has to be submitted along with Bid, detailing the role of the agent along with the terms of payment for agency commission in INR, along with supporting documents.
- 22.0 The bidders shall not enter into any undisclosed M.O.U. or any understanding amongst themselves with respect to tender.
- 23.0 In case Consortium Bidding is allowed as per Pre Qualifying Requirement, then Prime Bidder and Consortium Partner shall enter into Consortium Agreement. Validity period of Consortium Agreement shall be 6 months after which the same can be re validated.

'Stand alone' bidder cannot become a **prime bidder' or a 'consortium bidder' in a consortium bidding**. Prime bidder shall neither be a consortium partner to other prime bidder nor take any other consortium partners. However, consortium partner may enter into consortium agreement with other prime bidders. In case of non compliance, consortium bids of such Prime bidders will be rejected. .

- 24.0 The bidder shall submit documents in support of possession of ‘Qualifying Requirements’ duly self certified and stamped by the authorized signatory, indexed and properly linked in the format for PQR. In case BHEL requires any other documents/proofs, these shall be submitted immediately.
- 25.0 The bidder may have to produce original document for verification if so decided by BHEL.
- 26.0 Order of Precedence  
In the event of any ambiguity or conflict between the Tender Documents, the order of precedence shall be in the order below:
- a. Amendments/Clarifications/Corrigenda/Errata etc issued in respect of the tender documents by BHEL
  - b. Notice Inviting Tender (NIT)
  - c. Price Bid
  - d. Technical Conditions of Contract (TCC)—Volume-1A
  - e. Special Conditions of Contract (SCC) —Volume-1B
  - f. General Conditions of Contract (GCC) —Volume-1C
  - g. Forms and Procedures —Volume-1D

For BHARAT HEAVY ELECTRICALS LTD

Sr.DGM/SCT

**Enclosure**

01. Annexure-1: Pre Qualifying criteria.
02. Annexure-2: Check List.
- 03 Other Tender documents as per this NIT.

**ANNEXURE - 1****PRE QUALIFYING CRITERIA**

JOB	Construction & Development of BHEL Site Office , Closed & Semi Closed Storage Sheds and Open Yard for 3X660 MW units at Lalitpur STPS at Lalitpur,UP
TENDER NO.	<b>BHEL/NR/SCT/ LALITPUR/STORE SHED/858</b>

<b>A</b>	<b>Submission of Integrity Pact duly signed (if applicable)</b>	<b>APPLICABLE</b>
<b>B</b>	<b>Assessment of Capacity of Bidder to execute the work as per sl no. 9 of NIT (if applicable)</b>	<b>APPLICABLE</b>
<b>C</b>	<b><u>FINANCIAL CRITERIA</u></b>	
<b>C1</b>	Tenderers should have an average annual turnover of minimum of Rs 315 Lacs (Rupees Three Hundred Fifteen Lacs only) based on the audited accounts of last three financial years (2008-09, 2009-10 & 2010-11). Bidders shall submit audited annual accounts (balance sheets and profit & loss account) in support of this	
<b>C2</b>	<b>NETWORTH</b> Net worth of the Bidder based on the latest Audited Accounts as furnished for 'C1' above should be positive.	
<b>C3</b>	<b>PROFIT</b> Bidder must have earned cash profit in any one of the three Financial Years as applicable in the last three years defined in 'C1' above based on latest Audited Accounts.	
<b>D</b>	<b><u>TECHNICAL CRITERIA</u></b>	
<b>D1</b>	Bidder who wish to participate should have executed similar work (Civil) in the last 7 years of any one of the following.	
	3.1) One single work valuing minimum Rs 840 lacs 'OR' 3.2) Two works valuing each of minimum Rs 525 lacs 'OR' 3.3) Three works valuing each of minimum Rs 420 lacs	
<b>F</b>	<b>Approval of Customer (if applicable)</b> <b>Note: Names of bidders who stand qualified after compliance of criteria A to E shall be forwarded to customer for their approval. Price bid of only those bidders shall be opened who are approved by customer.</b>	<b>NOT APPLICABLE</b>

**NOTES:**

- (1) Time period for achievement of the Qualification Requirement is in the last 7 years ending on the 'latest date of Bid submission'
- (2) 'Executed' means the vendor should have achieved the criteria specified in the QRs even if the Contract has not been completed or closed.
- (3) Similar Works means 'Civil Works'

**ANNEXURE - 2****CHECK LIST****NOTE: - Tenderers are required to fill in the following details and no column should be left blank**

1	Name and Address of the Tenderer		
2	Details about type of the Firm/Company		
3	Details of Contact person for this Tender	Name : Mr./Ms Designation: Telephone No: Mobile No: Fax No:	
4	EMD DETAILS	DD No:                      Date : Bank :                      Amount: <u>Please tick ( √ ) whichever applicable:-</u> ONE TIME EMD / ONLY FOR THIS TENDER	
5	Validity of Offer	TO BE VALID FOR SIX MONTHS FROM DUE DATE	
		APPLICABILITY	BIDDER REPLY
6	Whether the format for compliance with <b>PRE QUALIFICATION CRITERIA</b> (ANNEXURE-I) is understood and filled with proper supporting documents referenced in the specified format	Applicable	YES / NO
7	Audited profit and Loss Account for the last three years	Applicable/Not Applicable	YES/NO
8	Copy of PAN Card	Applicable/Not Applicable	YES/NO
9	Whether all pages of the Tender documents including annexure, appendices etc are read understood and signed	Applicable/Not Applicable	YES/NO
10	Integrity Pact	Applicable/Not Applicable	YES/NO
11	Declaration by Authorized Signatory	Applicable/Not Applicable	YES/NO
12	No Deviation Certificate	Applicable/Not Applicable	YES/NO
13	Declaration confirming knowledge about Site Conditions	Applicable/Not Applicable	YES/NO
14	Declaration for relation in BHEL	Applicable/Not Applicable	YES/NO
15	Non Disclosure Certificate	Applicable/Not Applicable	YES/NO
16	Bank Account Details for E-Payment	Applicable/Not Applicable	YES/NO
17	Capacity Evaluation of Bidder for current Tender	Applicable/Not Applicable	YES/NO
18	Tie Ups/Consortium Agreement are submitted as per format	Applicable/Not Applicable	YES/NO
19	Power of Attorney for Submission of Tender/Signing Contract Agreement	Applicable/Not Applicable	YES/NO
20	Analysis of Unit rates	Applicable/Not Applicable	YES/NO

NOTE: STRIKE OFF 'YES' OR 'NO', AS APPLICABLE

DATE:

**AUTHORISED SIGNATORY**  
(With Name, Designation and Company seal)

Rev 00  
6<sup>th</sup> JULY  
2010

# TECHNICAL CONDITIONS OF CONTRACT (TCC)

(Document No PS:MSX:TCC)

BHARAT HEAVY ELECTRICALS LIMITED



# TECHNICAL CONDITIONS OF CONTRACT (TCC) CONTENTS

---

SI No	DESCRIPTION	Chapter	PAGE No.
<b>Volume- IA</b>	<b>Part-I: Contract specific details</b>		
1	Project Information	Chapter-I	4
2	Scope of Works	Chapter-II	5-12
3	Facilities in the scope of Contractor/BHEL (Scope Matrix)	Chapter-III	13-17
4	T&Ps and MMEs to be deployed by Contractor	Chapter-IV	18-20
5	T&Ps and MMEs to be deployed by BHEL on sharing basis	Chapter-V	21
6	Time Schedule	Chapter-VI	22-23
7	Terms of Payment	Chapter-VII	24
8	Taxes and other Duties	Chapter-VIII	25-27
9	Any other Special Requirements	Chapter-IX	28-30
10	Other Requirements	Chapter-X	31-38
11	Annexures		39-41
<b>Volume- IA</b>	<b>Part-II : Technical Specifications</b>		<b>No. OF PAGES</b>
1	DRG No. LLT/OFF/001-SITE OFFICE LAYOUT	Rev 0	1

# TECHNICAL CONDITIONS OF CONTRACT (TCC) CONTENTS

---

2	DRG No. LLT/EW/009- RCC WORK DETAILS	Rev 0	1
3	DRG No. LLT/EW5/005- TYPICAL STORE LAYOUT	Rev 0	1

# TECHNICAL CONDITIONS OF CONTRACT (TCC)

## Chapter - I : Project Information

---

### PROJECT SYNOPSIS

Name of the Owner	:	<b>BAJAJ HINDUSTAN LTD.</b>
Address		3X660MW SUPER CRITICAL TPP at Mirchwara and Buraugaon near Utari river, Lalitpur, U.P.
New Installation	:	3 x 660 MW
Nearest Railway station		Lalitpur railway station (37 kms from site) on Jhansi – Bhopal line
Nearest Road		Approach to site from NH which about 23 km from Bansi on NH-26 connects Jhansi and Sagar
Nearest City	:	LALITPUR (15 KM)
Nearest Airport	:	GWALIOR AIRPORT (186 km)
Highest Temperature	:	45.1 ° C

# TECHNICAL CONDITIONS OF CONTRACT (TCC)

## Chapter - II : Scope of Works

---

### 2.0 GENERAL SCOPE OF WORK

2.1 The tender specification covers the construction of all works for “**Construction & Development of BHEL Site Office, Closed & Semi Closed Storage Sheds and Open Yard for 3 x 660 MW units at Lalitpur STPP at Lalitpur, UP**”. Work under this tender includes supply & erection of steel trusses, columns etc, Permanently colour coated Galvalume sheet roofing and false ceiling, steel / wooden door, Concrete roads, plumbing, sanitation, sewage, electrical works etc. including supply of all materials, labour, consumables, transportation, sample testing etc.

2.2 The scope of work shall generally include but not limited to the construction of the following. The contractor is required to carry out all the items indicated in the BOQ cum rate schedule.

- Earth work including excavation, filling, compaction, leveling and grading
- Plain & Reinforced cement concrete and Masonry(Full and half brick work)
- Structural & reinforcement steel work, AC/GS sheet roofing/side cladding & partition work
- Scaffolding & Formwork
- Finishing work including plastering, doors/windows, flooring, false ceiling, painting etc.
- Water supply and Sanitary work.
- Electrification of Building by providing Incoming cable, Main Distribution Board, Wiring for all installation Light fixtures, power sockets, Exhaust fans, Energy meter Etc
- Drainage(open and covered)
- MS gates for Entrance/Exit
- Barbed Wire fencing, WBM, Stone Soling.
- Road work, Culverts, Security Cabins, etc.
- Standard & Modular Furniture
- Furnishings like venetian blinds, roller blinds, AC's, etc

The Contractor is required to cut / relocate some of the existing plants / trees and to implant and maintain at least **25 new plants / trees and landscaping with flowers** etc. of approximately 100 Sq. M of assorted type at BHEL office or around within first month of the contract and maintain it till the tenure of the contract. No separate payment will be made for this work.

#### A. SITE OFFICE

The office shed shall be developed having the built up area of Approx. 800 Sq.m on land given by BHEL. The layout plan of the office block is attached for reference. The Site office Plot Area shall be around 2500 m<sup>2</sup>.

The office along with a 5X5 mtr porch on the front side shall be made of Brickwork, truss, bottom ties, wind ties of minimum 25 x 5mm over the roof sheets along the purlins, permanently colour coated profiled GS sheets. The foundation is to rest on firm rock / ground as instructed / approved by Engineer-in-charge and around 900 mm

# TECHNICAL CONDITIONS OF CONTRACT (TCC)

## Chapter - II : Scope of Works

---

below existing ground surface.. The brick masonry foundation is to rest over 75 mm PCC on firm rock / ground as instructed / approved by Engineer-in-charge. **Permanently colour coated profiled GS sheets** of approved colour, shade & pattern shall be provided with polymer coated J or L hooks, 8mm nut bolts for roofing with appropriate anchoring, fixing and drainage arrangements. Approved quality Enamel paint shall be used for painting work to MS. The wall above Finished floor level is of brick masonry of 23cm width course, to a height of 3000 mm minimum, in cement mortar 1:6 and plastered with CM 1:5. Below the Finished floor level brick masonry of 46 cm width course, to a depth of 200 mm minimum, in cement mortar 1:6 is to be laid which shall rest on top of PCC 75 mm thick and 600 mm wide. Above 2 brick wide course shall be 1.5 brick wide masonry of height 600 mm , a plinth beam of size 300x230 mm shall be provided all around ( extra tie beams wherever reqd.) with bottom of plinth beam at 0.00 lvl and 23 cm wide brick masonry thereafter.

The finished floor level of the office shall be at least 400 mm above existing ground level. The main office flooring consists of 100 mm minimum thick PCC over which approved vitrified tiles (600 x 600) are to be laid. The all-round walls, of 230mm thick and inside walls (115mm), partitions over a DPC course of CM 1:5 & 40mm thick with water proof compound (1kg per bag of cement), are to be constructed with brick work in CM 1:6 and plastered with CM 1:5, 12 mm thick minimum on both sides, the inside plastered surface is to be distempered with two coats minimum over a priming coat and the outside plastered surface is to be painted with approved snowcem or equivalent cement paint with two coats minimum over a priming coat.

The doors and window frames and shutters are to be made of approved M.S. frame as per relevant I.S. Main entrance door shall be of powder coated Al section, pivoted and provide with lock, Al safety grill, handles,etc. The decorative flush door shutters minimum 35mm thick, solid core block board, with both side laminated with thick to 0.8 to 1mm. The windows (1500x1200 or as specified)are of steel glazed shutters double leaved and central portion ( fixed with glass panel of 4mm thick). Frames are to be provided with 12mm MS bars @ 120mm intervals. The door & windows are to be properly fixed with the wall using hold faster/anchor grouted of minimum 200mm long. The doors will have flush shutters, with all fixtures like aldrops, tower bolts, handles, locking arrangement, wind stopper etc. and similarly the windows will have fixtures like hook and eye, towel bolts, minimum of two handles, etc. There shall be a lintel beam at +2100 lvl as per instructions.

There will be ceramic wash basins of approved colour & make, one at Construction Manager's room, one at Conference hall toilet and others in general toilet alongwith mirror of size 600 x 450mm minimum, towel rail, soap dish etc. There will be European ceramic water closets of approved colour and make. All required G.I. water lines (min 15mm dia), sewer lines (100mm – 150mm), soak pit of minimum 1.2mm dia and depth to suit at site, fixtures required for proper functioning like traps, chambers wall plugs, clamps, screws, (low height fibre made) Flushing cisterns of minimum 5Ltr capacity each. Taps for water wash basins & toilets along soap dish etc. are in the contractor's scope. Contractor to note no fixtures, specials or any material will be given for any work which are required for the completion of works. The pantry is to be provided with kitchen sink and counter with Granite stone top.

# TECHNICAL CONDITIONS OF CONTRACT (TCC)

## Chapter - II : Scope of Works

---

The false ceiling shall consist of 12mm thick Gypsum board laid over Aluminium Tees and edge angles at a grid size of 600mm x 600mm with arrangements for lighting fixtures, Fans etc as per instructions.

Wiring for light point, fan point etc. are to be with 1.5 sqmm PVC insulated conductor wire. Wiring for a 3 pin 250 volts 5/15 Amp single phase and neutral switch socket outlet, with 2.5 sqmm PVC insulated conductor wire. The wiring is to be done with good and approved quality PVC conduits of 19mm dia, above false ceiling and concealed PVC conduits below false ceiling. The fans of size 52 inch and tube light fittings of approved ISI makes are to be provided. The switches are to be modular switches of approved make are to be used. The three phase distribution with three phase energy meter with reqd. ELCB is in contractor scope. All samples are to be got approved by the Engineer-in-charge before the purchase and installation.

One/Two 500 Ltr. PVC Syntax/ Rotax / Polymer make water tanks is to be provided at side of the building with supporting structure of 3.60m height made with 65 x 65 x 6mm and 50 x 50 x 6mm angles duly painted with 2 coats finish paint over a primer coat provided and the required incoming and outgoing water lines to the services with minimum 20mm dia GI pipe, is in the contractor scope only. The incoming GI line is to be laid from nearby water line source (which is feeding surrounding place) up to overhead tanks and one direct line is to be provided in the pantry.

The Plinth level of the building is to be decided at site to suit the site condition by the Engineer-in-charge. The relevant Indian standards are to be followed for all works.

The entire scope of work is with the contractor and BHEL will not provide any material, manpower etc. for the satisfactory completion of work. The decision of the Engineer-in-charge is final and binding.

Covered parking (5.0x10.0mtr) shall be provided with tubular columns and purlins and AC sheets. PCC as specified in BOQ shall be done under covered parking, porch and approach road as per drawings. Horticulture work as specified shall be completed.

Incoming supply will be drawn from Identified power source with at least 3 ½ core 95 Sq. mm Al Cond Armoured PVC insulated cable will be laid underground & on surface duly supported. Suitable size GI pipe is to be provided for Road crossing. Connections at both the ends will be made by suitable size lugs & double compression glands. The minimum depth of the cable shall be 300 mm where no vehicles or equipment movement is there. Whenever the vehicles or equipment movement is there, the depth of cable should be 800 mm or to be provided through GI pipe of suitable size.

### **B. CLOSED & SEMI CLOSED STORES**

The store sheds shall be developed on land given by BHEL having the built up area of Approx.900 Sqm each.

**Closed Shed (60x15 Mtrs)**

**- 4 no.**

# TECHNICAL CONDITIONS OF CONTRACT (TCC)

## Chapter - II : Scope of Works

---

### Semi Closed Shed (60x15 Mtrs)

- 4 no.

The Store area shall be cleared of all vegetation, scrap and debris. The stores shall be made of ISMB/Pipe columns, tubular/angles truss, tubular/box purlins, side ties, bottom ties, wind ties of minimum 25mm x 5mm over the roof sheets along the purlins, as specified( drawings attached for reference).**The working/shop drgs for Steel structures, trusses, etc shall be got approved before start of work.**

The columns are erected with holding down foundation bolts in the RCC 1:1.5:3 (using 20 mm size coarse aggregate) foundation of pedestal size 1400mm high 500x400 mm minimum and footing size 1500x1500x300 mm. The footing is to be provided with a reinforcement of 10mm bars @ 125mm C/C both ways and the pedestal is to be provided with 4 no.16mm & 4 no. 12 mm re bar vertically with a minimum 'L' of 200mm and with 8mm stirrups @ 150 C/C. The foundation is to rest over 100 mm PCC on firm rock / ground as instructed / approved by Engineer-in-charge. **Permanently colour coated profiled Galvalume** sheets shall be provided with polymer coated self-drilling screws for roofing and side cladding with appropriate anchoring, fixing and drainage arrangements. Approved quality Enamel paint shall be used for painting work to MS. The wall above finished floor level is of brick masonry of 23cm width course, to a height of 2100 mm minimum, in cement mortar 1:6 and plastered with CM 1:5. Below the Finished floor level brick masonry of 23 cm width course, to a depth of 300 mm minimum, in cement mortar 1:6 is to be laid which shall rest on top of 230 x 300 mm plinth beam (5-12 mm dia bars and stirrups 8 mm @ 200 mm c/c). The base course under plinth beam shall be PCC 100 mm thick and 400 mm wide. The top of the plinth beam shall be at the existing ground level . The finished floor level of the stores shall be atleast 300 mm above existing ground level. The Store flooring consists of raising the Ground level by filling good earth and 100 mm PCC over which approved CC flooring is to be laid. Extended roofing shall also be provided as per the instructions of the Engr. I/C. Rolling shutters (5.0x5.0 mtrs)complete with all guides, rollers, anchors, etc shall be provided as per BOQ. The inside and outside plastered surface is to be white washed with two coats minimum over a priming coat. Contractor to note no fixtures, specials or any material will be given for any works which are required for the completion of works. Average 275 mm deep and 250 mm wide drains shall be constructed along the plinth protection as per directions of the Engr I/C.

100 mm thk, 1.0 mtrs wide RCC racks/slabs all along one store wall shall be provided at 1.0 mtr & 2.0 mtr height from FFL. The slabs shall be rested on half brick masonry every 1.2 mtr span of size 2.0 mtrs high. The brickwork shall be plastered to finish and whitewashed as per specs. in BOQ.

It is proposed to electrify the closed shed as follows:

3 to 4 Nos HPSV flood light fittings with lamps of 250 W with Choke & accessories etc.each to be provided on top of each store shed with 2 mtrs. height rigid GI pole provided with adequate brackets for mounting the flood lights and tie rods duly grouted

# TECHNICAL CONDITIONS OF CONTRACT (TCC)

## Chapter - II : Scope of Works

---

or welded to permanent structure. Two lights should be provided with independent MCB switch.

The connection to all HPSV fittings is to be provided by 2.5 Sq. mm PVC insulated copper conductor in PVC conduit for fittings mounted on store shed.

Providing 15/5Amps Single phase socket and 20Amps – 3 phase socket as per instructions.

Providing common main panel to cater requirement of all total layout, laying incoming cable for the above panel from the outside nearest source, providing feeder panel, lights & sockets requirement etc., laying interconnecting panel between common main panel and feeder main panel, providing MCB distribution board to cater lights, sockets & fans requirement. Providing earth electrode and earth conductors as per requirement.

The scope of work has to be completed in all the manner to meet the functional requirement by covering all the left out allied work in BOQ thereby to commission the system as a whole.

Complete Electrification alongwith necessary lighting-fixtures, fans, necessary cables, MCB, ELCB, Main switch, Energy meter, Junction box, switches, switch boards, Plug points etc. are in the contractor's scope so that installation is fully safe & meets local authorities statutory requirement. The necessary covers required for the MCB, energy meter etc., are to be provided by the contractor. Necessary earthing alongwith earth pit required as per the standards are to be provided by the contractor.

All the material used to be approved by Engineer-in-charge and in case of non-availability of approved make of material; BHEL Engineer-in-charge is authorized to substitute the same.

### C. STORAGE YARD AND ROADS

The Storage yards and roads shall be developed on land given by BHEL having the built up area of Approx. **150000** Sqm. The yard area shall be leveled, watered and compacted with at least 10 passes of 8-10 T roller to the entire satisfaction of BHEL.

Entire storage yard is to be leveled first by making good the undulations , watered, compacted and rolled with road rollers to required slope (1: 300) towards the drains/periphery so that no waterlogging is present. The road area, subgrade shall be prepared after dressing to camber and consolidation with 8-12 T Road rollers, over which 150-200mm water bound macadam, is to be laid with stone aggregate 63 mm to 45 mm, stone screenings, moorum, red bajri, binding earth etc and is to be compacted and rolled with road roller. A leveling/finishing course of 1" consolidated thickness of approved quarry dust/Moorum shall be provided to make the yard ready for material storage. Appropriate approaches shall be made to Closed and open storage areas from

# TECHNICAL CONDITIONS OF CONTRACT (TCC)

## Chapter - II : Scope of Works

---

the roads. The internal road of storage yard is to be connected with existing approach road. This is in the contractor's scope. **Open and covered PCC/Brick drains** as specified shall be provided and terminated at Existing drains as per the attached sketch for proper and sufficient rainwater drainage.

Contractor to note no machinery, tools & plants, material, manpower shall be provided by BHEL.

### D. FENCING

Barbed wire fencing work : Pits of size 300x300 and 600 deep shall be excavated for MS angle posts at 3 mtrs c/c. Atleast 1.5 m high **GI barbed wire** fencing with 2.0 m angle iron 50 x 50x 6 mm posts placed every 3 m centre to centre embedded in cement concrete block (1:3:6), every 15th post last but one end post and corner post shall be strutted on both sides and end post on one side only and provided with 8 horizontal lines and two diagonals inter woven with horizontal wires of barbed wire 9.38 Kg per 100 m (min) between the two posts and fixed with GI staples , turn buckles etc. complete shall be provided by the contractor.

### E. APPROVED MAKE OF MATERIALS

- |    |                         |   |  |
|----|-------------------------|---|--|
| 1. | STRUCTURAL/REINF. STEEL | : | SAIL<br>TATA<br>RATHI  |
| 2. | CEMENT                  | : | ACC<br>BIRLA<br>JAYPEE   |
| 3. | ENAMEL PAINTS           | : | JOHNSON & NICHOLSON<br>BERGER<br>ICI<br>ASIAN PAINT<br>NEROLAC |
| 4. | GI & MS PIPES           | : | SURYA,<br>PRAKASH<br>JINDAL-HISSAR<br>TATA                     |
| 5. | ELECTRICAL ACCESSORIES  |   |  |

# TECHNICAL CONDITIONS OF CONTRACT (TCC)

## Chapter - II : Scope of Works

---

- a) SWITCHES AND SOCKETS : ANCHOR, MK, LK  
(MODULAR TYPE SWITCHES)

### 6. ELECTRICAL EQUIPMENT:

- a) EXHAUST FANS : ALSTOM / CROMTON/ GC/ Nutech  
b) LIGHT FITTINGS : CROMPTON/PHILIPS /WIPRO.  
c) WALL MOUNTING FANS : ORIENT/ CROMPTON/ GC/USHA  
d) CFL & FL LAMPS : PHILIPS/ OSRAM/WIPRO/BAJAJ  
e) KWH METERS ETC : BHEL/ GE/ L&T /HAVELS  
f) MCBs & MCB DBs (10 KA) : MDS/ L&T-HAGGER/ RAJ.L/ HAVELS  
g) EARTH LEAKAGE CIRCUIT : MDS/ L&T-HAGGER/ RAJ.L/  
BREAKER HAVELS EURO

Note: Approval of BHEL engineer is to be obtained before procurement of materials specified above. The make of material mentioned if not available in the market or is not suiting the site conditions or the make of material is not mentioned in the above list, equivalent make may be used after the approval from BHEL engineer.

2.3 The scope of work will also include such other related works although they may not be specifically mentioned in the above paragraph and all such incidental items not specified but reasonably implied and necessary for completion of the job as a whole all as desired and as directed by the engineer.

The detail scope of work covered above is not a comprehensive list of items of work involved. The detail scope of work may vary considerably depending on the actual construction requirements.

2.4 The work under this contract shall be carried out as per BOQ Cum Rate Schedule. In case the description / specifications as per BOQ are found to be incomplete Indian standard specifications shall be followed. Quantities mentioned in the rate schedules are approximate only and liable for variation due to change of scope of work / variation in schedule of quantities, changes in design etc. The tenderers shall undertake to execute actual quantities as per advice of BHEL Engineer and accordingly the final contract price

# TECHNICAL CONDITIONS OF CONTRACT (TCC)

## Chapter - II : Scope of Works

---

shall be worked out on the basis of quantities actually erected at site and payments will also be regulated for the same. The quantities indicated against each item may vary to any extent and no compensation will be payable in variation of Individual quantity.

### 2.5 **ALSO INCLUDED IN THE SCOPE**

Unless otherwise specified, the work to be provided by the contractor for the items mentioned in the "Bill of Quantities" shall include but not be limited to the following.

- a) Furnishing all labour, materials, supervision, construction plans, equipment, supplies, transport, to and from the site, fuel, electricity, compressed air, water, transit and storage insurance and all other incidental items and temporary works not shown on specified but reasonably implied or necessary for the proper completion, maintenance and handling over the works, except in accordance with the stipulations laid down in the contract documents and additional stipulations as may be provide by the engineer during the course of works.
- b) Furnishing samples of all materials required by the engineers for testing / inspection and approval for use in the works. The samples may be retained by the engineer for final incorporation in the works.
- c) Furnishing test reports for the products used or intended to be used, if called for the specifications or if so desired by the engineer.
- d) Giving all notices, paying all fees, taxes etc., in accordance with the general conditions of contract, that are required for all works including temporary works.
- e) Arranging manufacturer's supervision for items of work done as per manufacturer's specifications when so specified.
- f) Carrying out topographic survey of the work area and establish levels and coordinates at suitable intervals from existing grid levels and coordinates furnished by the owner established bench marks, setting out the locations and levels of proposed structures, constructions and marking of reference pillars and other identification works etc., The contractor shall provide the owner/BHEL such a assistance, instruments, machines, labour and materials as are normally required for examining, measuring and testing any work and the quality, weight or quantity of any material used.
- g) Providing all incidental items not shown or specified but reasonably implied or necessary for the successful completion of the work in accordance with contract.

**TECHNICAL CONDITIONS OF CONTRACT (TCC)**  
**Chapter – III : Facilities in the scope of Contractor/BHEL**

---

Sl.No	Description	Scope / to be taken care by		Remarks
		BHEL	Bidder	
1.1.0	<b>ESTABLISHMENT</b>			
1.1.1	FOR CONSTRUCTION PURPOSE:			
A	Open space for office	Yes		BHEL shall provide free of charge limited open space for office and store as and where made available by its customer
B	Open space for storage	Yes		
C	Construction of bidder's office, canteen and storage building including supply of materials and other services		Yes	
D	Bidder's all office equipments, office / store / canteen consumables		Yes	
E	Canteen facilities for the bidder's staff, supervisors and engineers etc		Yes	
F	Fire fighting equipments like buckets, extinguishers etc		Yes	
G	Fencing of storage area, office, canteen etc of the bidder		Yes	
1.1.2	<b>FOR LIVING PURPOSES OF THE BIDDER</b>			
A	Open space		Yes	
B	Living accommodation		Yes	
1.2.0	<b>ELECTRICITY</b>			

**TECHNICAL CONDITIONS OF CONTRACT (TCC)**  
**Chapter – III : Facilities in the scope of Contractor/BHEL**

---

Sl.No	Description	Scope / to be taken care by		Remarks
		BHEL	Bidder	
1.2.1	<u>Electricity For construction purposes</u> <b>(to be specified whether chargeable or free)</b>		Yes	Contractor shall have to deploy the DG sets for carrying out the tender works
1.2.1.1	Single point source			
1.2.1.2	Further distribution for the work to be done which include supply of materials and execution		Yes	
1.2.2	Electricity for the office, stores, canteen etc of the bidder which include:		Yes	
1.2.2.1	Distribution from single point including supply of materials and service		Yes	
1.2.2.2	Supply, installation and connection of material of energy meter including operation and maintenance		Yes	
1.2.2.3	Duties and deposits including statutory clearances for the above		Yes	
1.2.2.4	Living facilities for office use including charges		Yes	
1.2.2.5	Demobilization of the facilities after completion of works		Yes	
1.2.3	Electricity for living accommodation of the bidder's staff, engineers, supervisors etc on the above lines.		Yes	
1.3.0	<b>WATER SUPPLY</b>			
1.3.1	<b>For construction purposes:</b>			
1.3.1.1	Making the water available at single point		Yes	

**TECHNICAL CONDITIONS OF CONTRACT (TCC)**  
**Chapter – III : Facilities in the scope of Contractor/BHEL**

---

Sl.No	Description	Scope / to be taken care by		Remarks
		BHEL	Bidder	
1.3.1.2	Further distribution as per the requirement of work including supply of materials and execution		Yes	
1.3.2	<b><u>Water supply for bidder's office, stores, canteen etc</u></b>		Yes	
1.3.2.1	Making the water available at single point			
1.3.2.2	Further distribution as per the requirement of work including supply of materials and execution		Yes	
1.4.0	<b>LIGHTING</b>			
1.4.1	For construction work (supply of all the necessary materials) 1. At office storage area 2. At the preassembly area 3. At the construction site /area		Yes	
1.4.2	For construction work (execution of the lighting work/ arrangements ) 1. At office storage area 2. At the preassembly area 3. At the construction site /area		Yes	
1.4.3	Providing the necessary consumables like bulbs, switches, etc during the course of construction		Yes	
1.4.4	Lighting for the living purposes of the bidder at the colony / quarters		Yes	
1.5.0	<b>COMMUNICATION FACILITIES FOR SITE OPERATIONS OF THE BIDDER</b>			

**TECHNICAL CONDITIONS OF CONTRACT (TCC)**  
**Chapter – III : Facilities in the scope of Contractor/BHEL**

---

SI.No	Description	Scope / to be taken care by		Remarks
		BHEL	Bidder	
1.5.1	Telephone, fax, internet, intranet, e-mail etc		Yes	
1.6.0	<b>COMPRESSED AIR SUPPLY</b>			
1.6.1	Supply of Compressor and all other equipments required for compressor and compressed air system including pipes, valves, storage systems etc		Yes	
1.6.2	Installation of the above system and operation and maintenance of the same.		Yes	
1.6.3	Supply of the all the consumables for the above system during the contract period		Yes	

SI.No	Description	Scope / to be taken care by		Remarks
		BHEL	Bidder	
	<b>CONSTRUCTION FACILITIES</b>			
2.1.0	Engineering works for construction:			
2.1.1	Providing the construction drawings for all the equipments covered under this scope	Yes		
2.1.2	Drawings for construction methods		Yes	In consultation with BHEL
2.1.3	As-built drawings – where ever deviations observed and executed and also based on the decisions taken at site– routing of small bore pipes		Yes	”

**TECHNICAL CONDITIONS OF CONTRACT (TCC)**  
**Chapter – III : Facilities in the scope of Contractor/BHEL**

---

SI.No	Description <b>CONSTRUCTION FACILITIES</b>	Scope / to be taken care by		Remarks
		BHEL	Bidder	
2.1.4	Shipping lists etc for reference and planning the activities			”
2.1.5	Preparation of site construction schedules and other input requirements		Yes	”
2.1.6	Review of performance and revision of site construction schedules in order to achieve the end dates and other commitments	Yes	Yes	”
2.1.7	Weekly construction schedules based on SI No 2.1.5		Yes	”
2.1.8	Daily construction / work plan based on SI No 2.1.7		Yes	”
2.1.9	Periodic visit of the senior official of the bidder to site to review the progress so that works are completed as per schedule. It is suggested this review by the senior official of the bidder should be done once in every two months.		Yes	
2.1.10	Preparation of preassembly bay		Yes	
2.1.11	Laying of racks for gantry crane if provided by BHEL or brought by the contractor/bidder himself			NA

**TECHNICAL CONDITIONS OF CONTRACT (TCC)**  
**Chapter – IV: T&Ps and MMEs to be deployed by Contractor**

---

**LIST OF TOOL & PLANTS TO BE DEPLOYED BY THE CONTRACTOR -**

INDICATIVE LIST OF T & P TO BE ARRANGED BY THE CONTRACTOR AT HIS OWN  
COST

Sl. No.	EQUIPMENT	QTY
1	CONCRETE MIXER M/C of SUITABLE CAPACITY	4 NO ( minimum)
2	CONCRETE VIBRATORS	4 NO ( minimum)
3	JCB, Excavator, Dozer, Jack Hammers with compressor, Equipment for controlled blasting	MIN. 2 JCB/EXCAVATORS AS PER WORK REQUIREMENT
4	Trucks/lorries/Tractors/Dumpers	AS PER WORK REQUIREMENT
5	WATER TANKER	2 NO. Minimum
6	DEWATERING PUMP	AS PER WORK REQUIREMENT
7	WINCHES	AS PER WORK REQUIREMENT
8	WELDING MACHINES	AS PER WORK REQUIREMENT
9	ROAD ROLLERS	MIN. 2 NO. AS PER WORK REQUIREMENT

**NOTES:**

- 1 The above list specifies only major T&P (may not be complete to be deployed by the contractor). All additional / other tools and plants including trucks & devices, tackles, machines, measuring instruments etc. in good and safe working conditions which are required for satisfactory & timely completion of work shall also be deployed by the contractor within finally accepted rate / price. **Contractor has to mobilize / maintain**

# TECHNICAL CONDITIONS OF CONTRACT (TCC)

## Chapter – IV: T&Ps and MMEs to be deployed by Contractor

---

### **adequate numbers of equipments for meeting the Concreting and Structural Fabrication and Erection**

- 2 Other terms and conditions regarding above items please also refer clause for T&P/IMTEs).
- 3 All the tools and plants required for this scope of work, except the Tools & Plants provided by BHEL are to be arranged by the contractor within the quoted rates. The list is suggestive in nature. Any additional T & P required to be arranged by the contractor.
- 4 IF ABOVE MENTIONED T&P ARE NOT DEPLOYED IN SPECIFIED TIME BHEL WILL CHARGE TO CONTRACTOR CURRENT MARKET RATE + 30 % OVERHEADS FOR NON AVAILABILITY OF T&P or levy a day wise penalty for non deployment for delayed deployment.
- 5 If work gets delayed due to non availability of T&P, BHEL reserves the right to get the work done at the risk and cost of contractor without prejudice to rights of BHEL as in GCC

**TECHNICAL CONDITIONS OF CONTRACT (TCC)**  
**Chapter – IV: T&Ps and MMEs to be deployed by Contractor**

---

**B: INSPECTION, MEASURING AND TESTING EQUIPMENTS (IMTE's):**

**INDICATIVE LIST OF IMTEs TO BE ARRANGED BY THE CONTRACTOR AT HIS OWN COST**

SL NO	EQUIPMENT	QTY
1	TOTAL STATION	1 NO
2	AUTO LEVEL	1 NO
3	MEASURING TAPE	AS PER REQUIREMENT

NOTES:

1. The above list specifies only major IMTEs (may not be complete to be deployed by the contractor). Contractor has to set up the field laboratory with facilities required for material & concrete testing. All additional / other IMTEs / measuring instruments etc. in good and safe working conditions which are required for satisfactory & timely completion of work shall also be deployed by the contractor within finally accepted rate / price.
2. Other terms and conditions regarding above items please also refer clause for T&P/IMTEs).
3. All the tools and plants required for this scope of work, except the Tools & Plants provided by BHEL are to be arranged by the contractor within the quoted rates. The list is suggestive in nature. Any additional T & P required to be arranged by the contractor.
4. IF ABOVE MENTIONED T&P ARE NOT DEPLOYED IN SPECIFIED TIME BHEL WILL CHARGE TO CONTRACTOR CURRENT MARKET RATE + 30 % OVERHEADS FOR NON AVAILABILITY OF T&P or levy a day wise penalty for non deployment for delayed deployment.
5. If work gets delayed due to non availability of T&P, BHEL reserves the right to get the work done at the risk and cost of contractor without prejudice to rights of BHEL as in GCC

TECHNICAL CONDITIONS OF CONTRACT (TCC)  
Chapter – V: T&Ps and MMEs to be deployed by BHEL on sharing  
basis

---

NA

# TECHNICAL CONDITIONS OF CONTRACT (TCC)

## Chapter – VI: Time Schedule

---

### TIME SCHEDULE

#### 6.0 MOBILIZATION, TIME SCHEDULE, CONTRACT PERIOD AND GRACE PERIOD

#### 6.1 INITIAL MOBILIZATION

After receipt of fax LOI, Contractor shall discuss with Project Manager / Construction Manager regarding initial mobilisation. Contractor shall mobilize necessary resources within 2 weeks of issue of fax letter of intent or as per the directive of Project Manager / Construction Manager. However, the actual date of start of work will be certified by BHEL Engineer after adequate mobilisation of materials, manpower and T&Ps by the contractor.

Such resources shall be progressively augmented to match the schedule of milestones and commissioning.

#### 6.2 COMMENCEMENT OF CONTRACT PERIOD AND TENTATIVE SCHEDULE

6.3 Entire work as detailed in tender specification **shall be completed within 9 months from the scheduled date of start of work**. Contractor has to mobilise adequate resources to meet BHEL's commitments to their customer as indicated from time to time.

6.4 Detailed Work completion Schedule will be submitted for approval by the successful bidder within 2 weeks of issue of LOI.

6.5 In case due to reasons not attributable to the contractor, the work gets delayed and scheduled completion gets extended, time extension will be accordingly granted by BHEL.

6.6 The work under the scope of this contract is deemed to be completed in all respects, only when all the works are carried out as per satisfaction of BHEL. The decision of BHEL on completion date shall be final and binding on the contractor.



# TECHNICAL CONDITIONS OF CONTRACT (TCC)

## Chapter-VII: Terms of Payment

---

### 7.1 TERMS OF PAYMENT

- 7.1 The 'Engineer' will certify regarding the actual work executed in the measurement books and bills, which shall be accepted by the contractor in measurement book.
- 7.2 **The Contractor shall be paid monthly running bill as per Chapter – X of SCC and Clause Nos. 2.22 & 2.23 of GCC.** The format for billing shall be approved by BHEL before raising invoices.
- 7.3 The contractor on certification of the engineer at site be entitled for payments of his running bills which shall be subject to any deduction/retention specifically under clauses 2.22 of GCC and 10.0 of SCC.
- 7.3.1 **Interest bearing recoverable advance. : Not Applicable**  
**(as per Clause No. 2.13 of GCC)**

# TECHNICAL CONDITIONS OF CONTRACT (TCC)

## Chapter-VIII: Taxes and Other Duties

---

### 8.0 TAXES & DUTIES

The contractor shall pay all (save the specific exclusions as enumerated in this contract) taxes, fees, license charges, deposits, duties, tools, royalty, commissions or other charges which may be levied on the input goods & services consumed and output goods & services delivered in course of his operations in executing the contract. In case BHEL is forced to pay any of such taxes, BHEL shall have the right to recover the same from his bills or otherwise as deemed fit.

However, provisions regarding **Service Tax** and **Value Added Tax (VAT)** on output services and goods shall be as per following clauses.

#### 8.1 Service Tax & Cess on Service Tax

Service Tax and Cess on Service Tax as applicable on output Services are excluded from contractor's scope; therefore contractor's price/rates shall be **exclusive** of Service Tax and Cess on Output Services.

Contractor shall obtain prior written consent of BHEL before billing the amount towards such taxes. The Service Tax Rules permit more than one option or methodology for discharging the liability of tax/levy/duty and BHEL will have the right to adopt the appropriate one considering the amount of tax liability on BHEL/Client as well as procedural simplicity with regard to assessment of the liability. The option chosen by BHEL shall be binding on the Contractor for discharging the obligation of BHEL in respect of the tax liability to the Contractor. Contractor shall submit to BHEL documentary evidence of Service Tax registration certificate specifying name of services covered under this contract.

For the purpose of claiming any Service Tax from BHEL, the following procedure shall be adopted :

Contractor shall submit serially numbered Service Tax and Cess Invoices, signed by him or a person authorized by him in respect of taxable service provided, and shall contain the following, namely:

The name, address and registration number of the contractor

The name and address of the party receiving taxable service (BHEL)

Description, classification and value of taxable service provided and

The Service Tax payable thereon.

All the four conditions shall be fulfilled in the invoice for payment of Service Tax by BHEL. Where more than one nature of Service under Service Tax Rules is involved, the invoice mentioned above shall contain the break up of all values for each nature of Service.

#### **VAT (Sales Tax /WCT)**

# TECHNICAL CONDITIONS OF CONTRACT (TCC)

## Chapter-VIII: Taxes and Other Duties

---

### **Civil Works:**

As regards Value Added Tax (VAT) on transfer of property in goods involved in Works Contract (previously known as Works Contract Tax) applicable as per local laws, the price quoted by the contractor shall be **exclusive** of the same. Contractor shall obtain prior written consent of BHEL before billing the amount towards such taxes. In case contractor opts for composition, it will be with the prior express consent of BHEL. The VAT Rules permit more than one option or methodology for discharging the liability of tax/levy/duty and BHEL will have the right to adopt the appropriate one considering the amount of tax liability on BHEL/Client as well as procedural simplicity with regard to assessment of the liability. The option chosen by BHEL shall be binding on the Contractor for discharging the obligation of BHEL in respect of the tax liability to the Contractor. BHEL also reserves the right to demand "Tax Invoice" under the relevant VAT Act, from the Contractor. Where such taxes are required to be paid by the contractor subject to the above, this will be reimbursed on production of proof of payment made to the authorities by the Contractor. The contractor has to take all necessary steps to **minimize tax on input goods** by purchasing the materials from any registered dealer of the concerned state only.

### **Works other than Civil Works:**

The rates quoted by the Contractor shall be inclusive of VAT/Sales Tax and BHEL shall not reimburse any amount on this account due to any reason whatsoever.

### **Common to all Works (Both Civil and Other than Civil)**

The Contractor shall register himself with the respective Sales Tax authorities of the state and submit proof of such registration to BHEL along with the first RA bill.

Deduction of tax at source shall be made as per the provisions of law unless otherwise found exempted. In case tax is deducted at source as per the provisions of law, this is to be construed as an advance tax paid by the contractor and no reimbursement thereof will be made unless specifically agreed to.

Contractor has to make his own arrangement at his cost for completing the formalities, if required, with Sales Tax/VAT Authorities, for bringing all their material, plant and equipment etc at site for the execution of the work, including arrangement of Road Permits if and as applicable under the relevant VAT Act.

#### **8.2.1 Modalities of Tax Incidence on BHEL**

Wherever the relevant tax laws permit more than one option or methodology for discharging the liability of tax/levy/duty, BHEL will have the right to adopt the appropriate one considering the amount of tax liability on BHEL/Client as well as procedural simplicity with regard to assessment of the liability. The option chosen by BHEL shall be binding on the Contractor for discharging the obligation of BHEL in respect of the tax liability to the Contractor.

### **New Taxes/Levies**

# TECHNICAL CONDITIONS OF CONTRACT (TCC)

## Chapter-VIII: Taxes and Other Duties

---

In case the Government imposes any new levy/tax on the output service/ goods/work after award of the contract, the same shall be reimbursed by BHEL at actual.

In case any new tax/levy/duty etc. becomes applicable after the date of Bidder's offer, the Bidder/Contractor must convey its impact on his price duly substantiated by documentary evidence in support of the same before opening of Price Bid. Claim for any such impact after opening the Price Bid will not be considered by BHEL for reimbursement of tax or reassessment of offer.

No reimbursement/recovery on account of increase/reduction in the rate of taxes, levies, duties etc. on input goods/services/work shall be made. Such impact shall be taken care of by the Price Variation/Adjustment Clause (PVC) if any. In case PVC is not applicable for the contract, Bidder has to make his own assessment of the impact of future variation if any, in rates of taxes/duties/ levies etc. in his price bid.

# TECHNICAL CONDITIONS OF CONTRACT (TCC)

## Chapter-IX : Any other Special requirements

---

### 9.0 MATERIALS

- 9.1 The contractor shall, at his own expenses (Inclusive of Taxes), provide all materials required for the work.
- 9.2 All stores and materials to be provided by the Contractor shall be of the best kind in conformity with the specifications laid down in the contract or as per relevant Indian standard and the Contractor shall, if requested by the **BHEL** Engineer, furnish proof to the satisfaction of **BHEL** Engineer that the materials so comply.
- 9.3 **The Contractor shall, at his own expense and without delay, supply to the BHEL Engineer samples of materials proposed to be used in the works. The BHEL Engineer shall within seven days of supply of samples or within such further period as he may require will intimate to the Contractor in writing, whether samples are approved by him or not. If samples are not approved, the Contractor shall forthwith arrange to supply to the BHEL Engineer for his approval fresh samples complying with the specifications laid down in the Contract. Any delay in approval of samples (original or fresh ones) shall not make the contractor eligible for any compensation.**
- 9.4 The **BHEL** Engineer shall have full powers for removal of any or all of the materials brought to site by the Contractor which are not in accordance with the Contract specifications or do not conform in character or quality to samples approved by him. In case of default on the part of the Contractor in removing rejected materials, the Engineer shall be at liberty to have them removed by other means. The **BHEL** Engineer shall have full powers to procure other proper material to be substituted for rejected materials and in the event of the Contractor refusing to comply, he may cause the same to be supplied by other means. All costs, which may attend upon such removal and / or substitution shall be borne by the Contractor.
- 9.5 The Contractor shall indemnify BHEL, its representatives or employees against any action, claim or proceeding relating to infringement or use of any patent or design or any alleged patent or design rights and shall pay any royalties or other charges which may be payable in respect of any article or material or part thereof included in the Contract. In the

# TECHNICAL CONDITIONS OF CONTRACT (TCC)

## Chapter-IX : Any other Special requirements

---

event of any claim being made or action being brought against BHEL or any agent, servant or employee of BHEL in respect of any such matters as aforesaid, the Contractor shall immediately be notified thereof, provided that such indemnity shall not apply when such infringement has taken place in complying with the specific directions issued by BHEL but the Contractor shall pay any royalties or other charges payable in respect of any such use, the amount so paid being reimbursed to the Contractor only if the use was the result of any drawings / specifications issued after submission of the tender.

- 9.6 The **BHEL** Engineer shall be entitled to have tests carried out as specified in the Contract for any materials supplied by the Contractor other than those for which, as stated above, satisfactory proof has already been furnished, at the cost of the Contractor and the Contractor shall provide at his expense all facilities which the Engineer may require for the purpose. If no tests are specified in the Contract, and such tests are required by the Engineer, the Contractor shall provide all facilities required for the purpose and the charges for these tests shall be borne by the Contractor only. The cost of materials consumed in tests shall be borne by the Contractor in all cases except when otherwise provided.
- 9.7 In addition, the Contractor shall perform / submit at his own cost such tests / samples as may be required by the **BHEL** Engineer out of the materials used by the company except for the costs of materials used in such tests/ samples.
- 9.8 After acceptance of the Contract, if Contractor desires BHEL to supply any other materials, such material may be supplied by BHEL, if available, at rates to be fixed by the **BHEL** Engineer along with prevailing departmental charges (current rate of 30%). BHEL reserve the right not to issue any material. The non-issue of such material will not entitle the Contractor for any compensation whatsoever either in time or in cost.
- 9.9 Material required for the works, whether brought by the Contractor or supplied by BHEL, shall be stored by the Contractor only at places approved by the Engineer. Storage and safe custody of material shall be the responsibility of the contractor.
- 9.10 BHEL's officials concerned with the Contract shall be entitled at any time to inspect and examine any materials intended to be used in or on the works, either on the Site or at factory or workshop or other place(s) where such materials are assembled, fabricated,

## TECHNICAL CONDITIONS OF CONTRACT (TCC)

### Chapter-IX : Any other Special requirements

---

manufactured or at any place (s) where these are lying or from which these are being obtained and the Contractor shall give such facilities as may be required for such inspection and examination.

- 9.11 All materials brought to the Site shall become and remain the property of BHEL and shall not be removed off the Site without the prior written approval of the Engineer. But whenever the Works are finally completed and advance, if any, in respect of any such material is fully recovered, the Contractor shall at his own expense forthwith remove from the Site all surplus material originally supplied by him and upon such removal, the same shall re-vest in and become the property of the Contractor.

# TECHNICAL CONDITIONS OF CONTRACT (TCC)

---

## Chapter-X: OTHER REQUIREMENTS

---

### 10.0 EXECUTION OF WORK

10.1 The work shall be executed in a workman like manner and to the entire satisfaction of the Engineer and as per technical specification issued with tender, IS codes, CPWD specifications as applicable. In case of conflict, the decision of the **BHEL** Engineer shall be final & binding.

10.2 **The BHEL Engineer will communicate or confirm his instructions to the Contractor in respect of the execution of the work in a "Work Site Order Book" maintained at his office and the Contractor shall visit this office daily and shall confirm receipt of such instructions by signing the relevant entries in this book. Such entries will rank as order or notices in writing within the intent and meaning of these conditions.**

### 11.0 SETTING OUT

11.1 All the works shall be set out to the true lines, grades and elevation indicated on the drawing. The contractor shall be responsible to locate and set out the works. Only one grid reference line and bench mark **shall** be made available for setting out the works under the contract. This reference lines shall be used as datum for the works under the contract and the contractor has to establish for his work area at available points horizontal and vertical control points. The contractor shall inform BHEL well in advance of the times & places at which he wishes to do work in the area allotted to him so that suitable datum points established by him are checked by BHEL / Customer to enable the contractor to proceed with the works. Any work done without being properly located may be removed and / or dismantled by BHEL / Customer at contractor's expenses.

11.2 The contractor shall at his own expense take all proper and responsible precautions to preserve and maintain these datum marks to its true position. In the event of these marks being disturbed or obliterated by accident or due to any other cause whatsoever, the same may be deemed necessary placed by BHEL / Customer at contractor's expenses.

# TECHNICAL CONDITIONS OF CONTRACT (TCC)

---

## **12.0 SITE DRAINAGE**

12.1 All water including sub-soil water which may accumulate on the Site during the progress of the works or in trenches and excavations, including monsoon period shall be removed by the contractor from the Site to the satisfaction of the Engineer. It will also be responsibility of the contractor to de-water all the foundation pits, trenches with suitable de-watering methods like, pumping out, well point system etc. considering the depth of water table at plant site. All such expenditure on de-watering shall be deemed to be included in quoted rates.

## **13.0 INSPECTION AND STAGE APPROVAL OF THE WORK**

13.1 The owner or his duly authorised representative shall have at all reasonable times access to the contractor's premises or works and shall have the power to inspect drawings or any portion of the work, examine the materials and workmanship and shall have the authority to reject any work. This would be implemented through joint inspection by the representative of the owner and BHEL and in the form of joint protocols without any extra claims and loss of time and amount.

13.2 All work embracing more than one process shall be subject to examination and approval at each stage thereof and the Contractor shall give due notice in writing to the Engineer when each stage is ready. In default of such notice being received, the Engineer shall be entitled to approve the quality and extent thereof at any time he may choose and in the event of any dispute, the decision of the Engineer thereon shall be final and conclusive.

## **14.0 UNCOVERING AND MAKING GOOD**

14.1 The Contractor shall uncover any part of the Works and/or make openings in or through the same as the Engineer may from time to time direct for his verification and shall reinstate and make good such part to the satisfaction of the Engineer. If any such part has been covered up or put out of view after being approved by the Engineer and is subsequently found on uncovering to be executed in accordance with the Contract, the expenses of uncovering and / or making opening in or through, reinstating and making good the same shall be borne by BHEL. In any other case all such expenses shall be borne by the Contractor.

## TECHNICAL CONDITIONS OF CONTRACT (TCC)

---

14.2 If neither drawing nor specification contain any mention of minor details of construction which in the opinion of the Engineer whose decision shall be final and conclusive, are reasonable and obviously and fairly intended for satisfactory completion of work, such details shall be provided by the contractor without any extra cost, as if they were specially mentioned and shall be deemed to be included in the **scope**.

### 15.0 NUISANCE

15.1 The Contractor shall not at any time do, cause or permit any nuisance on Site or do anything which shall cause unnecessary disturbance or inconvenience to owners, tenants or occupiers of other properties near the Site and to the public generally.

### 16.0 MATERIAL OBTAINED FROM EXCAVATION

16.1 Materials of any kind obtained from excavation on the Site shall remain the property of BHEL / its client and shall be disposed of as the Engineer may direct, at no extra cost.

### 17.0 TREASURE, TROVE, FOSSILS etc.

17.1 All fossils, coins, articles of value or antiquity and structures and other remains or things of geological or archaeological interest discovered on the site shall be the absolute property of BHEL / BHEL's client and the Contractor shall take reasonable precautions to prevent his workmen or any other person from removing or damaging any such article or thing, shall immediately upon discovery thereof and before removal acquaint the Engineer with such discovery and carryout the Engineer's directions as to the disposal of the same.

### 18.0 PROTECTION OF WORKS

18.1 Trees designated by the Engineer shall be protected from damage during the course of the Works and earth level within 1 meter of each such tree shall not be charged. Where necessary, such trees shall be protected by providing temporary fencing.

18.2 The contractor shall provide and maintain at his own expense all lights, guards, fencing and watching when and where necessary or required by the Engineer for the protection of the Works or for the safety and convenience of those employed on the Works or the public.

## TECHNICAL CONDITIONS OF CONTRACT (TCC)

---

18.3 The contractor shall have total responsibility for protecting his works till it is finally taken over by the Engineer. No claim will be entertained by the Engineer for any damage or loss to the contractor's works and the contractor shall be responsible for the complete restoration of the damaged works to its original condition to comply with the specifications and drawings. Should any such damage to the contractor's works occur because of other party not under his supervision or control, the contractor shall make his claim directly with the party concerned. The contractor shall not cause any delay in the repair of such damaged works because of any delay in the resolution of such disputes. The contractor shall proceed to repair the work immediately and no cause thereof will be assigned pending resolution of such disputes.

### **19.0 PROTECTION OF EMBEDMENTS BOLTS ETC.**

19.1 The contractor shall ensure proper protection to the satisfaction of the Engineer, of all bolts, inserts, embedments etc. from weather etc/ by greasing, rapping them with gunny bags or canvas or by any other means as directed by Engineer. Cost of such protections shall be deemed to be included in the rates quoted for the item.

### **20.0 CLEARANCE OF SITE AND REPAIRS.**

20.1 Contractor has to clear the site / area where mechanical and electrical erection work is to be commenced / or in progress. The contractor shall remove construction materials and equipment lying in the vicinity and causing obstruction in the erection work within 24 hrs. notice. In case, he fails to clear the site, this will be done at his risk & cost by BHEL.

### **21.0 QUALITY ASSURANCE**

21.1 **The contractor has to establish / arrange at site the field testing facilities for testing of civil construction materials and concrete cubes for ensuring the proper quality, grade and strength of the materials used in the construction in line with approved field quality check list of BHEL/ its client. Contractor has to submit detailed report for testing of all material used etc. All testing shall be done as per IS code specifications/ BHEL's quality plan. If further test is required by the engineer to be carried from outside laboratory, the cost of the same shall be borne by the contractor.**

# TECHNICAL CONDITIONS OF CONTRACT (TCC)

---

## 22.0 COMPLETION OF WORK

- 22.1 The works shall be completed to the entire satisfaction of the Engineer and in accordance with the completion schedule as specified in the Contract, and all unused stores and materials, tools, plant, equipment, temporary buildings, site office, labour hutments and other things shall be removed and the site and work cleared of rubbish and all waste materials and delivered up clean and tidy to the satisfaction of the Engineer at the Contractor's expenses.
- 22.2 BHEL shall have power to take over from the Contractor from time to time such sections of the work as have been completed to the satisfaction of the Engineer. Such work however shall not be treated as have been completed until the extra works are executed to the satisfaction of Engineer. The Guarantee period shall commence only after handing over of the entire works.
- 22.3 The Engineer shall certify to the contractor the date on which the work is completed and the date thereof.

## 23.0 METHOD OF MEASUREMENT

23.1 **Method of measurements if not specified in the tender, shall be as per relevant IS Codes / CPWD codes.**

24.0 **The contractor shall comply with following towards Safety and Social Accountability;**

24.1 Besides provision with regard to SAFETY under Clause 27 of GCC, the contractor will be responsible for Health, Safety & Environment management at site for the construction activities to be carried out by them in accordance with requirements **given under section I(a) of GCC of this document**. The contractor shall continuously take special care to ensure the safety and prevention of human and equipment accidents and maintain good sanitary conditions in and around the site. All the construction work and plant operation must be carried out in the safest possible manner. The Engineer reserves the right to stop any process which, in the Engineer's opinion, is being performed dangerously. In this case the contractor must immediately adhere the requisite safety precautions and any delays attributed to the work stoppage on this account shall not affect the agreed contractual finishing dates.

24.2 The contractor shall appoint dedicated full-time Qualified Safety Officers who shall have full authority to ensure that all necessary safety precautions are observed by the

## TECHNICAL CONDITIONS OF CONTRACT (TCC)

---

Contractor's employees and sub-contractors. These appointees shall have full responsibility for the safety of all personnel within the contractor's area of the works.

24.3 Some of the common safety rules to be followed during working are as follows :-

- Nobody is allowed to enter at construction site without Safety Shoe.
- Never enter work area without Safety helmet & chin strap in place.
- No climbing/working allowed without proper safety belt above 2 m. height.
- Do not exceed the speed limit 25 Kmph within premises.
- No debris obstacles allowed on the roads & passages.
- Do not walk on pipelines or false ceiling.
- Maintain good Housekeeping at work site.
- No photography/ Videography allowed without permission
- All Site supervisors & engineers (including subcontractor's) must be imparted structured training on construction safety before start of the job & record to be maintained.
- Availability of qualified & trained Site Engineer at site during all working hours.
- Site Safety training to be imparted to all workers & plan to be made to cover every worker.
- Tools box talk (5-15 minutes) by supervisor prior to commencement of any job.
- All accident / incidents(Near Miss) to be reported & investigated.(formats & procedure should be finalized)
- Daily Safety Checking by Each Site Engineer along with Safety engineer.
- Weekly co-ordination meeting of all Safety engineers with BHEL safety officer.
- Monthly safety meeting with Site In-charges.
- All Safety equipment must be ISI marked & checked by Safety officer before use.
- Tag system for erection & use of scaffoldings.
- Bamboo/wooden Scaffolding material not allowed.
- LPG cylinders not allowed for gas cutting.
- Good Housekeeping. Separate waste bins to be used for flammable & non flammable material.
- Safety awareness programs for workers by display of boards, posters, competitions, talks etc.
- Deployment of Safety Supervisors for every 250 workers and part thereof at work site.
- Display of List of First Aid trained persons.
- Testing certificates for lifting tools & tackle.
- Provision & maintenance of fire extinguishers at construction site & material stores.
- Display of emergency telephone numbers at various locations.
- For work in confined space use 24 V lamp fitting & use tools with air motors or electric tools with max. 24 V.
- For confined space entry Gas test must be done before & at regular intervals.
- Checking & tag of equipment like grinding machine, welding machine, gas cutting set etc. by supervisors before use.

24.4 **Contractor shall ensure following:**

1. Contractor has to maintain contact with local hospital having scanning & other ultra-modern medical facilities required during emergency including Ambulance.

## TECHNICAL CONDITIONS OF CONTRACT (TCC)

---

2. Contractor has to ensure pre employment medical check for all staff & workers.
  
3. Contractor has to ensure that adequate First Aid facilities with trained nurse & ambulance are available at work site for emergency purpose. This emergency set-up should include, but not limited to, following
  - Male nurse (in shifts)
  - Oxygen set up
  - Breathing apparatus
  - Eye wash facility
  - Stretcher
  - Trauma blanket
  - Medicines.

In addition to above, BHEL may arrange ambulance at work site for emergency purpose, which can be utilized, free of cost, by contractor in case of emergency. In case, under unavoidable circumstances, if the ambulance is not available/ being used elsewhere, the contractor will have to arrange for the same. as under clause 24.4 SI No. 1.

- 24.5 The Contractor shall be fully responsible for accidents caused due to him or his agents or workmen's negligence or carelessness in regard to the observance of the safety requirements and shall be liable to pay compensation for injuries. **It may be noted that non-compliance to HSE requirements will result in penal action. In case of violations of safety requirements, the Contractor shall be liable for a penalty of Rs. 500/- for the first violation and Rs. 1000/- for the subsequent violations. For serious lapses, as decided by BHEL Engineer, fines upto Rs. 5000/- at a time can be imposed.**

The amount towards penalties as above will be deducted from running bills of the Contractor. The amount so collected above will be utilized for supporting the safety activities at site. The decision of BHEL on above will be final and binding on the Contractor.

- 24.6 **The contractor shall comply with following towards Social Accountability;**
- (a) The contractor shall not employ any employee less than 15 years of age in pursuant to ILO convention. If any child labour were found to have been engaged , the Contractor shall be levied with expenses of bearing his education expenditure which will include stipend to substantiate appropriate education or employ any other member of family enabling to bear the child education expenditure.
  - (b) The contractor shall not engage Forced/Bonded Labour and shall abide by abolition of Bonded Labour System (Abolition) Act, 1976.
  - (c) The contractor shall maintain Health & safety requirement as stipulated in the Contract and Contract Labour (Regulation & Abolition) Act,1970.

## TECHNICAL CONDITIONS OF CONTRACT (TCC)

---

- (d) The Contractor shall abide by UN convention w.r.t Human Rights and shall be liable for Discrimination/Corporal punishment for failure in meeting with relevant requirements.
- (e) The Contractor shall abide the requirement of Contract Labour (Regulation & Abolition) Act, 1970 for working hours.
- (f) The Contractor shall abide by the statutory requirement of Minimum Wages Act 1948, payment of Wages Act 1936.
- (g) The Contractor shall arrange potable drinking water to its employees & workers.

### **25.0 DISCREPANCIES AND ADJUSTMENT OF ERRORS**

25.1 The several documents forming the Contract are to be taken as mutually explanatory of one another, detailed drawings being followed in preference to small scale drawings and figures dimensions in preference to scale and special conditions in preference to general conditions.

25.2 In case of discrepancies between schedule of quantities, the specification and / or the drawings, the following order of preference shall be observed.

- (a) Description in schedule of quantities.
- (b) Technical Conditions of Contract
- (c) Drawings
- (d) Technical Specifications
- (e) Special Conditions of Contract
- (f) General conditions of contract

If there are varying or conflicting provisions made in any one document forming part of the contract, the Engineer shall be the deciding authority with regard to the document.

25.3 Any error in description, quantity in schedule of quantities or any omission therefrom shall not vitiate the contract or release the contractor from the execution of the whole or any part of the works comprised therein according to the drawings and specifications or from any of his obligations under the contract.

**26.0** Clause No. 4.1 & 4.2.2 of SCC shall not be applicable.

# TECHNICAL CONDITIONS OF CONTRACT (TCC)

---

## Chapter-XI: ANNEXURES

### **ANNEXURE -I** **GENERAL TERMS AND CONDITIONS OF REVERSE AUCTION (RA)**

---

Against this enquiry for the subject item / system with detailed scope of supply as per our tender specification, BHEL-PSNR, NOIDA may resort to “REVERSE AUCTION PROCEDURE” i.e. ONLINE BIDDING on INTERNET.

1. For the proposed reverse auction, technically and commercially acceptable bidders only shall be eligible to participate.
2. BHEL will engage the services of a service provider who will provide all necessary training and assistance before commencement of on line bidding on Internet.
3. In case BHEL decides to conduct reverse auction, BHEL's service provider shall contact the vendor directly and impart them the training.
4. Business rules like event date, time, start price, bid decrement, extensions, etc. also will be communicated through service provider for compliance.
5. Vendors have to fax the compliance form in the prescribed (provided by service provider) before start of Reverse auction. Without this the vendor will not be eligible to participate in the event.
6. Total Price quoted shall be inclusive of all taxes except service tax in line with the NIT conditions for the subject work in Indian Rupees (INR), which is to be worked out as per the BOQ (Rate Schedule) given in tender enquiry and subsequent changes made, if any. EXCEL Sheet shall be provided, if applicable.
7. Reverse auction will be conducted on schedule date & time.
8. At the end of reverse auction event, the lowest bidder value will be known on the network.
9. The lowest bidder has to fax the duly signed filled-in prescribed format as provided on case-to-case basis to BHEL through service provider after completion of event on the same day preferably.
10. Any variation between the on-line bid value and signed document will be considered as sabotaging the tender process and may invite disqualification of vender to conduct business with BHEL as per prevailing procedure.
11. In case BHEL decides not to go for Reverse auction procedure for this tender enquiry, the price bids and price impacts, if any already submitted and available with BHEL shall be opened as per BHEL standard practice.

# TECHNICAL CONDITIONS OF CONTRACT (TCC)

---

## ANNEXURE - II

### **Authorization of representative who will participate in the on line Reverse Auction Process;**

1	NAME & DESIGNATION OF OFFICIAL	
2	POSTAL ADDRESS (COMPLETE)	
3	TELEPHONE NOS. (LAND LINE & MOBILE BOTH)	
4	FAX NO.	
5	E-MAIL ADDRESS	
6	NAME OF PLACE/ STATE/ COUNTRY, WHEREFROM S/HE WILL PARTICIPATE IN THE REVERSE AUCTION	

# TECHNICAL CONDITIONS OF CONTRACT (TCC)

---

## ANNEXURE - III

### FORMAT FOR E-PAYMENT DETAILS : - BHEL-PSNR-NOIDA

(To be given in Company letterhead)

**Beneficiary Name** :

**Bank Name & Branch** :

**MICR Code (9 Digits)** :

**IFSC CODE** :

**(VALID FOR NEFT)**

**Beneficiary Account No.** :

**Beneficiary E-mail ID** :

**(For payment confirmation)**

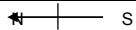

# LALITPUR STPP SITE OFFICE LAYOUT

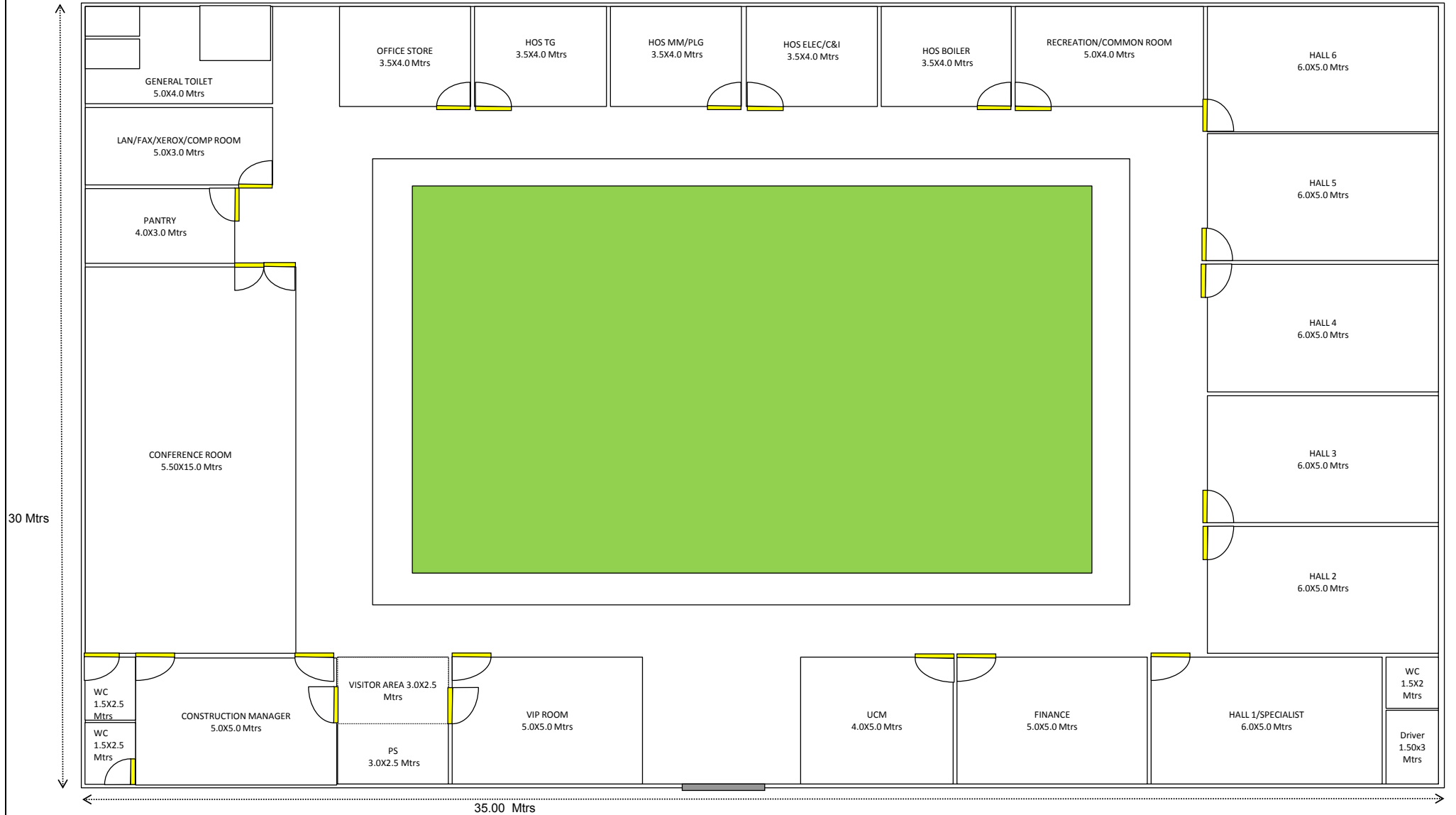

- AL glazed doors
- Fire extinguisher
- MS glazed windows(2.0x1.2,1.5x1.2,1.0x1.2)
- Ventilators (0.5 mtr ht.)
- Doors(2.40x2.40,2.0x2.1,1.5x2.1,1.0x2.1,0.75x2.1)

All dimensions c/c UNO

<b>PROJECT:</b> INFRASTRUCTURE FACILITIES AT LALITPUR STPS		<b>TITLE:</b> LALITPUR SITE OFFICE LAYOUT		<b>REVISION</b>	<b>DATE</b>
<b>DRG. NO.:</b> LLT/OFF/001		Made by	KSB	OO	01.09.2011
Rev	0	Checked by			
		Approved by			

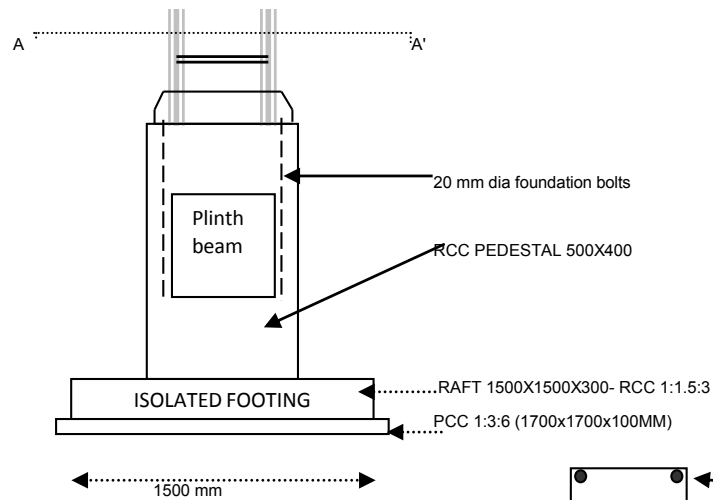

COLUMN FOOTING/PEDESTAL

Half brick drain clear width = 250 mm  
Avg Clear depth above 75 mm PCC = 275 mm

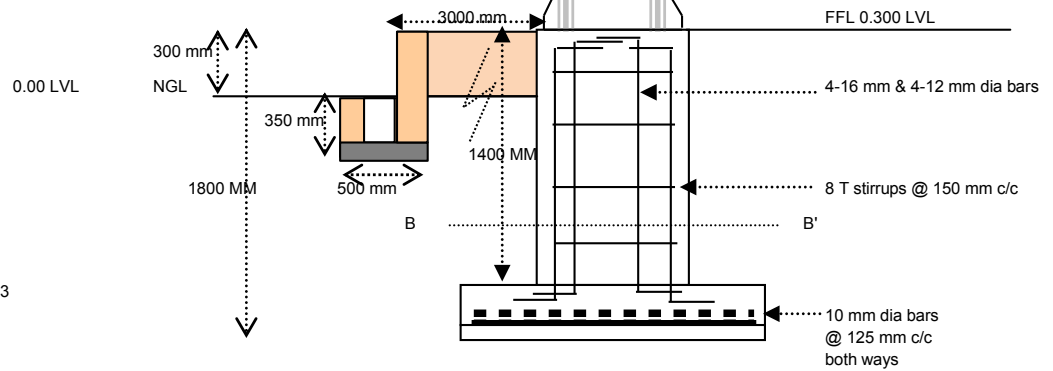

REINFORCEMENT DETAILS

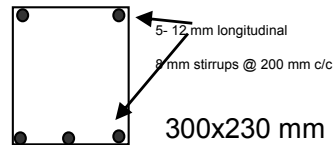

300x230 mm Plinth beam details

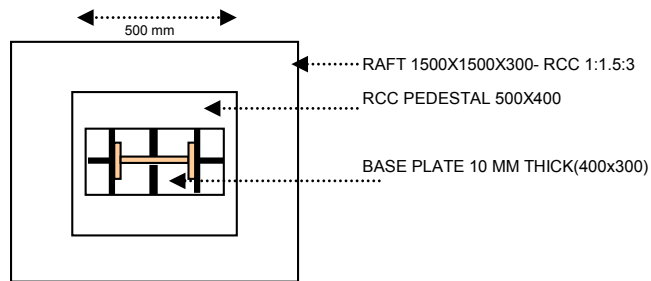

SECTION A-A'

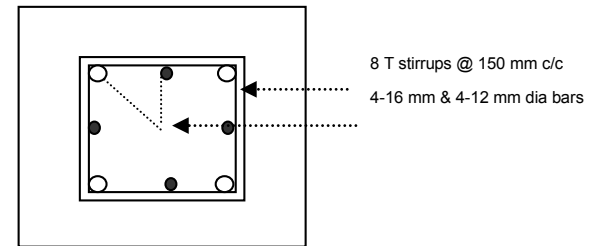

SECTION B-B'



Power Sector - Northern Region  
Bharat Heavy Electricals Ltd.

PROJECT:			TITLE: RCC WORK DETAILS		REV	DATE
ENABLING WORKS AT LALITPUR STPP			Made by	KSB	OO	01.09.2011
DRG. NO.:LLT/EW/009	Rev	oo	Checked by			
			Approved by			

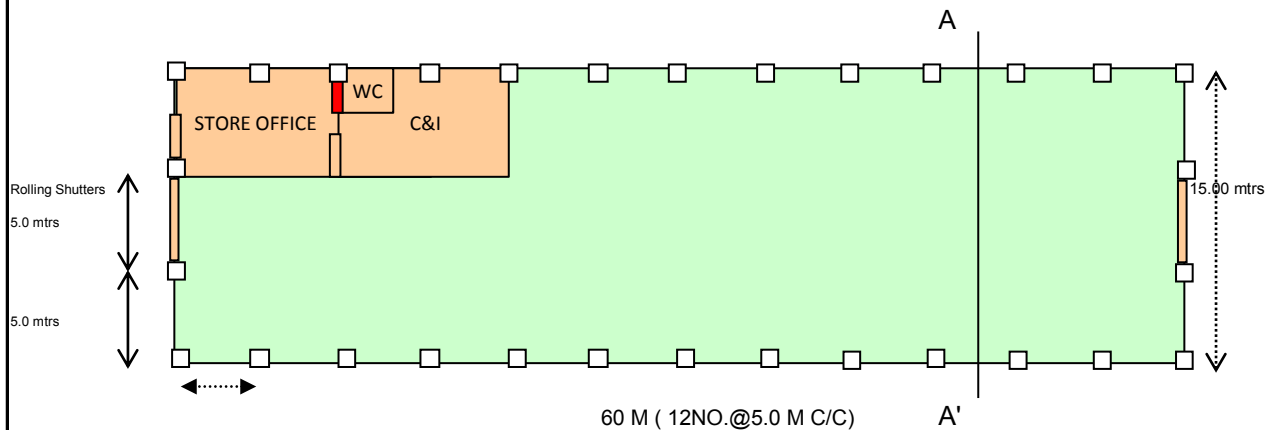
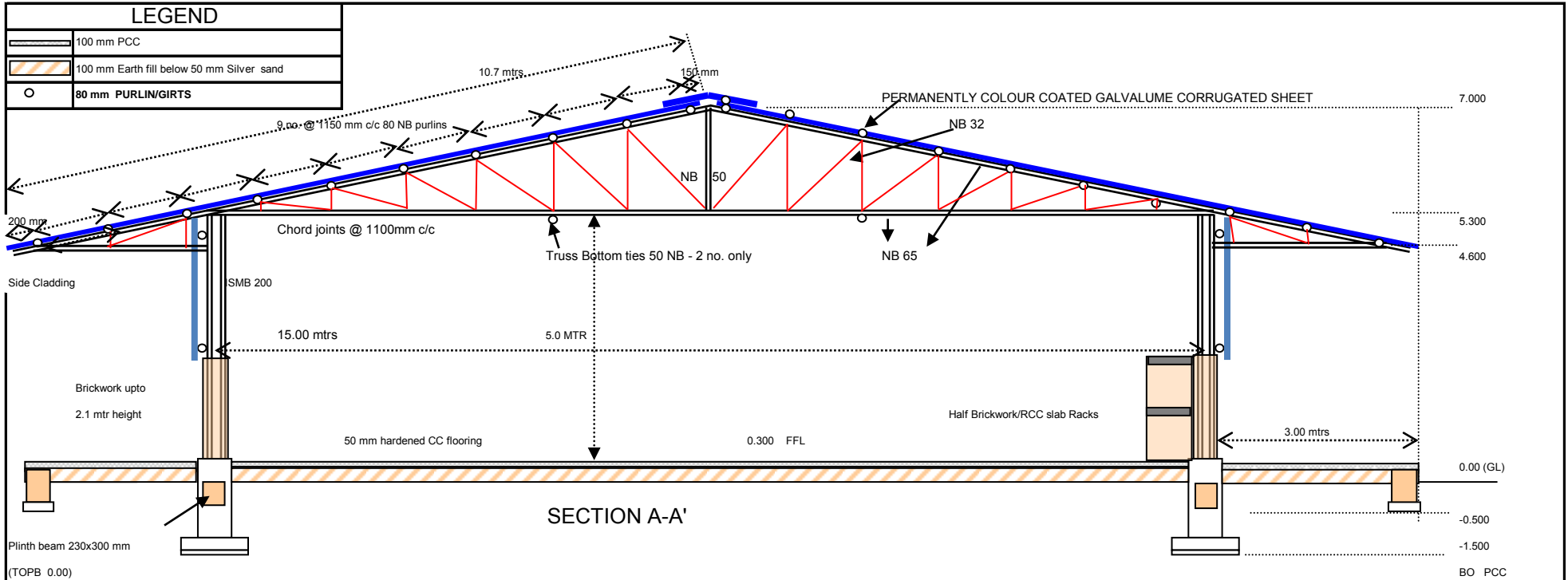

Note:

All dimensiond shall be c/c UNO  
Drains for Store shed area shall be decided as/site

	PROJECT: ENABLING WORKS AT LALITPUR STPP			TITLE: GA DRG FOR CLOSED STORE		REV	DATE
	DRG. NO.:BAM/EW/005			Made by	KSB	OO	01.09.2011
	Rev	oo	Checked by				
			Approved by				