



Bharat Heavy Electricals Limited

(A Govt. Of India Undertaking)

Power Sector, Eastern Region

BHEL Bhawan, Plot No. DJ-9/1, Sector- II,
Salt Lake City, Kolkata, WEST BENGAL, INDIA

Phone: 033-23398220, 23211690, FAX: 033-
23211960

NOTICE INVITING TENDER (NIT)

OFFERS ARE INVITED FROM REPUTED & EXPERIENCED BIDDERS (MEETING PRE-QUALIFICATION CRITERIA AS MENTIONED) **THROUGH NIC E-PROCUREMENT PORTAL <https://eprocurebhel.co.in> ONLY** for THE SUBJECT JOB BY THE UNDERSIGNED ON BEHALF OF BHARAT HEAVY ELECTRICALS LIMITED AS PER THE TENDER DOCUMENT. ISSUE OF TENDER TO ANY BIDDER SHALL NOT CONSTRUCT THAT THE BIDDER IS CONSIDERED TO BE QUALIFIED. FOLLOWING POINTS RELEVANT TO THE TENDER MAY PLEASE BE NOTED AND COMPLIED WITH.

Salient Features of NIT

SL NO	ISSUE	DESCRIPTION	
i	E-TENDER NUMBER	PSER:PUR:PAL-S518:23 (ENQ:23:PP:0015:PUR:14) Date 26/05/2023.	
ii	BROAD SCOPE OF JOB	"IN-SITU MACHINING & POLISHING OF EXCITER ROTOR SLIP RING OF GAS TURBINE GENERATOR-1 AT 2X363.3 MW GAS BASED COMBINED CYCLE POWER PLANT, PALATANA, OTPCL, TRIPURA".	
iii	ISSUE OF TENDER DOCUMENTS	a) <i>Online through e-procurement platform at https://eprocurebhel.co.in</i> b) In BHEL website (www.bhel.com & CPP Portal) : For tender view purpose only Start date of the tender: 26/05/2023	1. <i>Applicable</i> 2. <i>Applicable</i>
iv	DUE DATE & TIME OF OFFER SUBMISSION	<i>Date: 29/05/2023, Time: 14-00 Hrs. IST</i> <i>(Offer to be submitted online only through e-procurement platform at https://eprocurebhel.co.in)</i>	<i>Applicable</i>
v	TECHNO-COMMERCIAL BID OPENING OF TENDER	<i>Date: 29/05/2023, Time: 16-30 Hrs. IST</i> <i>(online only through e-procurement platform at https://eprocurebhel.co.in, participating bidders may witness the same online only)</i>	<i>Applicable</i>
vi	EMD AMOUNT	<i>INR 15,500.00 (Indian Rupees Fifteen Thousand Five Hundred Only)</i> <i>[To be submitted in the form and manner as mentioned below]</i>	<i>Applicable</i>
vii	COST OF TENDER	--	<i>Not Applicable</i>
viii	LAST DATE FOR SEEKING CLARIFICATION	<i>Date: 29/05/2023 (UP TO 11:00 Hrs. IST)</i>	<i>Applicable</i>
ix	SCHEDULE OF Pre Bid Discussion (PBD)	If any, shall be intimated through Tender Change Notice (TCN)	<i>Not Applicable</i>
x	INTEGRITY PACT & DETAILS OF INDEPENDENT EXTERNAL MONITOR (IEM)	--	<i>Not Applicable</i>

xi	LATEST UPDATES	Latest updates on the important dates, Amendments, Correspondences, Corrigenda, Clarifications, Changes, Errata, Modifications, Revisions, etc. to Tender Specifications will be hosted in BHEL webpage (www.bhel.com →Tender Notifications →View Corrigendum & CPP Portal →Tender Notice & E-PROCUREMENT PORTAL https://eprocarebhel.co.in). Bidders to keep themselves updated with all such information.	<i>Shall be intimated to bidder</i>
xii	EVALUATION CURRENCY	INDIAN RUPEES (INR)	

The offer shall be submitted as per the instructions of tender document. Only One set of tender document (**in original, downloaded from website**) signed by authorised company rep. of bidder and stamped on each page shall be submitted as detailed further, as given below. Bidders to note specifically that all pages of tender document, including these NIT pages etc. appearing in the website for this particular tender shall be submitted by them (after signing/stamping on each page) as a part of their offer. **Price shall not be mentioned by them anywhere in the techno-commercial portion of offer. Price shall be mentioned in the relevant price schedule only and to be submitted in e-procurement portal/platform in the form and manner mentioned in tender.**

For E-PROCUREMENT ASSISTANCE & TRAINING, NIC PORTAL HELPDESK CONTACTS AS PER FOLLOWING: -

For any technical related queries please call at 24 x 7 Help Desk Number
0120-4001 002

0120-4200 462

0120-4001 005

0120-6277 787

Email Support

Address: A) For any Issues or Clarifications relating to the published tenders, bidders are requested to contact the respective Tender Inviting Authority

Technical - support-eproc@nic.in

or for any difficulty in downloading the tender from internet website, they should contact this office (Dy. Engineer, Purchase or Manager, Purchase or DGM, Purchase or SDGM, Purchase Phone no. 033-23398261/8223/8221/8220). No alteration/changes by bidders is permitted in the tender/NIT appeared in the website.

- 1.0 Successful bidder shall have to submit additional set of tender/sign on tender document provided by BHEL, if so decided by BHEL.
- 2.0 **Earnest Money Deposit (EMD)** of **INR 15,500.00 (Indian Rupees Fifteen Thousand Five Hundred Only)** in the form & manner prescribed in tender, shall be submitted by bidder as mentioned below, failing which the bidder's offer is liable for rejection.

SCAN COPY OF DOCUMENTS IN SUPPORT OF SUBMISSION OF EMD TO BE UPLOADED ALONG WITH TECHNO-COMMERCIAL OFFER IN NIC E-PROCUREMENT PORTAL/PLATFORM. IN CASE OF EMD SUBMISSION THROUGH BANKER'S CHEQUE/PAY ORDER/DEMAND DRAFT, SAME TO BE SUBMITTED IN SEALED ENVELOPE (SUPERSCRIBING TENDER REFERENCE) TO SDGM-PURCHASE/DGM-PURCHASE/MANAGER-PURCHASE/DY. ENGINEER-PURCHASE, BHEL BHAWAN, DJ-

**9/1, SECTOR-2, KARUNAMOYEE, SALT LAKE CITY, KOLKATA-700091, WEST BENGAL
PRIOR TO LATEST DUE DATE OF SUBMISSION OF OFFER.**

One time EMD of Rs. 5,00,000/- (Rupees Five Lakh only) for BHEL-PSER, SAS jobs will also be valid for all such PSER-SAS jobs. Parties/bidders who have submitted/submits One Time EMD (OEMD) in this Power Sector Region (i.e. BHEL-PSER) for Service After Sales (SAS) a sum of amount Rs. 5,00,000/- (Rupees Five Lakh only) are exempted from payment of E.M.D. on each such tender in that unit on case to case basis. (evidence of deposit must be submitted in scanned copy and to be uploaded along with techno-commercial offer in NIC E-PROCUREMENT portal/platform) will be exempted from submission of EMD with this tender. The followings may be noted:

In case the bidder deposits separate EMD as mentioned above, there will be no change

- a) In existing clauses of this tender.
- b) In case of bidders having one time EMD; one time EMD can not be used for SD purpose.
- c) Security deposit shall be submitted as per provision of tender. **Security deposit shall cover the entire duration of work plus the performance guarantee period plus three months notice period prior to release of the same.**
- d) **The EMD shall be enclosed with the Techno-Commercial Bid in the form and manner as mentioned above.**

3.0 This is an E-tender floated online through our E-Procurement Site <https://eprocurebhel.co.in>. The bidder should respond by submitting their offer online only in our e-Procurement platform at <https://eprocurebhel.co.in>. Offers are invited in two-parts only. No Hard copy bid or bids through email/ fax shall be accepted. Bids are invited in two parts & shall be submitted as described below:

OFFER DESCRIPTION	DOCUMENTS TO BE UPLOADED & MODALITY OF UPLOADING
TECHNICAL OFFER	1.Scanned copy of Covering letter of offer (To be attached in relevant Attachment section) 2. Scanned copy of Entire tender documents signed & stamped in each page by authorized representative of the bidder except price bid (To be attached in relevant Attachment section). 3. Scanned copy of Techno-Commercial Offer (To be attached in relevant Attachment section) 4. Duly filled all annexures except price & unpriced format (To be attached in relevant Attachment section). 5. Copy of records notes of Pre-Bid Conference, if applicable/ pre-bid MOM. (To be attached in relevant Attachment section) 6. Copy of Tender change notice (TCN), if applicable (To be attached in relevant Attachment section) 7. All supporting documents/ Annexures etc. as applicable (To be attached in relevant Attachment section). 8. No deviation certificate in bidder's letterhead as per format given in Tender (To be attached in relevant Attachment section).
PRE-QUALIFICATION PART	9. Pre-qualifying documents with all credentials as per tender. (To be attached in relevant Attachment section)
UNPRICED PRICE BID	10. Price schedule – Unpriced but mentioning only quoted / unquoted against each item as per tender. (To be attached in Unpriced bid Attachment section)
PRICE BID	11. Duly filled in Price Schedule as per tender. (To be attached in price bid Attachment section) Any other document uploaded in the price bid, apart from tendered Price schedule, shall not be taken into cognizance for evaluation of offer.

SPECIAL NOTE:

- A)** Offer & documents submitted with the offer shall be signed and stamped in each page by authorised representative of the bidder. No overwriting/correction in tender documents by bidders shall be allowed. However, if correction is unavoidable, the same may be signed by authorized signatory.
- B)** All documents / Annexures submitted with the offer shall be properly annexed and placed in respective places of the offer as per enclosure list mentioned in the covering letter. BHEL shall not be responsible for any missing documents.
- 4.0 No deviation with respect to tender clauses and no additional clauses/ suggestions/clarification in Techno-commercial bid/Price bid shall normally be considered by BHEL. Bidders are requested to positively comply with the same. Offers with deviation are liable for rejection.
- 5.0 BHEL reserves the right to accept or reject any or all offer without assigning any reasons thereof. BHEL also reserve the right to cancel the tender wholly or partly without assigning any reason thereof. BHEL also reserve the right to split/part award the job. Also, BHEL shall not entertain any correspondence from bidders in this matter (except for the refund of EMD).
- 6.0 Since the job shall be executed at site, the bidders must visit site/ work area and study the job content, facilities available, availability of materials, prevailing site conditions including Law and Order situation, applicable Wage structure, Wage rules, present condition of machines etc. before quoting for this tender. They may also consult this office before submitting their offers, for any clarifications regarding scope of work, facilities available at sites or on terms and conditions. No additional claim shall be entertained by BHEL in future, on account of non-acquaintance of site/machine conditions at the time of bidding.
- 7.0 For any clarification on the tender document, you may seek the same in writing or through e-procurement portal/platform as per specified format within the last date of seeking clarification as per tender. BHEL shall not be responsible for receipt of queries after due date of seeking clarification due to postal delay, and receipt of any query after due date shall not be entertained.
- 8.0 BHEL may decide holding Pre-bid Discussion [PBD] with all intending bidders. On such communication from BHEL, the bidder shall ensure participation for the same at the appointed time, date and place as may be decided by BHEL. Outcome of PBD (if any) shall also form part of tender.
- 9.0 In case of absence of any queries from bidder(s), their quoted price will be PRESUMED to be final and complete with reference to the tender documents (including Tender change notes (TCNs), clarifications, corrigendum issued by BHEL, if any). Bidders are requested to study the tender documents in detail and prepare their queries/clarifications accordingly. All such queries / clarifications shall be cleared/replied by BHEL. Such clarification letters, corrigendum and/or Tender change notes (TCNs), if issued by BHEL, shall form part of tender document.
- 10.0 In the event of any conflict between requirement of any clause of this specification/ documents /drawings /data sheets etc. or requirements of different codes/ standards specified/ contradictions between any two clauses of tender document, the same to be brought to the knowledge of BHEL by bidders in writing for clarification before due date of seeking clarification, otherwise, more stringent requirement as may be interpreted by BHEL shall prevail and shall be binding on you. Any typing error/missing pages/ other clerical errors in the tender documents, noticed by you must be pointed out before submission of offer, or else, BHEL's interpretation shall prevail & binding on you.
- 11.0 Unless specifically mentioned otherwise, bidder's quoted price shall deemed to be in compliance with tender including PBD.

- 12.0 Tender document containing above mentioned volumes shall be signed & stamped in all pages including this covering letter. Price bid shall be furnished in the specified format enclosed with the tender. Any additional copy, if required, may be taken by photocopying from the tender document given in the web.
- 13.0 **The Bidder has to satisfy the Pre-Qualifying Requirements stipulated for this Tender in order to be qualified. The Price Bids of only those bidders will be opened, who will qualify for the subject job on the basis of pre-qualification evaluation & Techno-Commercial bids etc. BHEL reserves the right to reject the bidders with unsatisfactory past performance in the execution of a contract. BHEL's decision in this regard shall be final & binding.**
- 14.0 While BHEL reserve the right to open the price bid of the offers in camera, the date & time to open the PRICE BID, tender opening shall be intimated to the bidders in case BHEL decides it to be 'Public opening' and in such a case, one authorised representative of the bidder shall be allowed to attend.
- 15.0 **Validity of the offer shall be for Six months from the due date of offer submission (including extension, if any) unless specified otherwise.**
- 16.0 **Firm prices are to be quoted in whole rupees, in the place meant for price or on the price schedule enclosed as applicable for the full scope of work given in tender. The rates quoted must be in figures and words as well (Prices quoted must be workable too for the job involved). Prices quoted by the bidders should be inclusive of all taxes and duties leviable by any Statutory Authority for this job as on the date of the tender opening (excluding GST & BOCW Cess).**
- 17.0 Price Bids shall be evaluated in the manner as prescribed in Price Schedule. However, Unit Rates shall also be furnished if applicable in the Price Schedule.
- 18.0 ***Bid should be free from correction, overwriting, using corrective fluid, etc. Any interlineation, cutting, erasure or overwriting shall be valid only if they are attested under full signature(s) of person(s) signing the bid else bid shall be liable for rejection.***
- 19.0 **Bidders are required to submit their BEST price as per tender Price Schedule format in e-procurement portal/platform in the form & manner as mentioned in tender.**
- 20.0 ***"BHEL shall be resorting to Reverse Auction (RA) (Guidelines as available on www.bhel.com) for this tender. RA shall be conducted among the techno-commercially qualified bidders.***
- Price bids of all techno-commercially qualified bidders shall be opened and same shall be considered for RA. In case any bidder(s) do(es) not participate in online Reverse Auction, their sealed envelope price bid along with applicable loading, if any, shall be considered for ranking."***
- 21.0 *Bidders are requested to note that the accepted / agreed tender terms (technical, commercial or on Reverse Auction) in their original offer can not be altered / withdrawn by their own during the processing of tender.*
- 22.0 **The Bidder along with its associate/collaborators/sub-contractors/sub-vendors/consultants/service providers shall strictly adhere to BHEL Fraud Prevention Policy displayed on BHEL website <http://www.bhel.com> and shall immediately bring to the notice of BHEL management about any fraud or suspected fraud as soon as it comes to their notice.**

23.0 "The offers of the bidders who are under suspension as also the offers of the bidders, who engage the services of the firms debarred across BHEL, shall be rejected. The list of firms debarred across BHEL is available on BHEL web site www.bhel.com.

1.0 Integrity commitment, performance of the contract and punitive action thereof:

1.1 Commitment by BHEL:

BHEL commits to take all measures necessary to prevent corruption in connection with the tender process and execution of the contract. BHEL will during the tender process treat all Bidder(s) in a transparent and fair manner, and with equity.

1.2 Commitment by Bidder/ Supplier/ Contractor:

1.2.1 The bidder/ supplier/ contractor commit to take all measures to prevent corruption and will not directly or indirectly influence any decision or benefit which he is not legally entitled to nor will act or omit in any manner which tantamount to an offence punishable under any provision of the Indian Penal Code, 1860 or any other law in force in India.

1.2.2 The bidder/ supplier/ contractor will, when presenting his bid, disclose any and all payments he has made, and is committed to or intends to make to agents, brokers or any other intermediaries in connection with the award of the contract and shall adhere to relevant guidelines issued from time to time by Govt. of India/ BHEL.

1.2.3 The bidder/ supplier/ contractor will perform/ execute the contract as per the contract terms & conditions and will not default without any reasonable cause, which causes loss of business/ money/ reputation, to BHEL.

If any bidder/ supplier/ contractor during pre-tendering/ tendering/ post tendering/ award/ execution/ post-execution stage includes in mal-practices, cheating, bribery, fraud or and other misconduct or formation of cartel so as to influence the bidding process or influence the price or acts or omits in any manner which tantamount to an offence punishable under any provision of the Indian Penal Code, 1860 or any other law in force in India, then, action may be taken against such bidder/ supplier/ contractor as per extant guidelines of the company available on www.bhel.com and/ or under applicable legal provisions".

24.0 The bidder shall submit documents in support of possession of 'Qualifying Requirements' duly self certified and stamped/ digitally signed (as applicable) by the authorized signatory, indexed and properly linked in the format for PQR. In case BHEL requires any other documents/proofs, these shall be submitted immediately.

25.0 The bidder may have to produce original document for verification if so decided by BHEL.

26.0 Suspension of Business dealings with Suppliers/ Contractors: BHEL reserves the right to take action against contractors who fail to perform or indulge in malpractices, by suspending business dealings with them as detailed in [Annexure-A](#).

27.0 PREFERENCE TO MAKE IN INDIA:

For this procurement, the local content to categorize a supplier as a Class-I local supplier/ Class-II local supplier/ Non-Local supplier and purchase preference to Class-I local supplier, is as defined in Public Procurement (Preference to Make in India), Order 2017 dated 04-06-2020 issued by DPIIT. In case of subsequent orders issued by the Nodal Ministry, changing the definition of local content for the items of the NIT, the same shall

be applicable even if issued after issue of this NIT, but before opening of Part-II bids against this NIT.

Duly filled & signed Form-1 (Format for local content), as applicable, to be submitted by bidders along with their techno-commercial offer.

- 28.0 MSE suppliers can avail the intended benefits in respect of the procurements related to the Goods and Services only (Definition of Goods and Services as enumerated by Govt. of India vide Office Memorandum F. No. 21(8)/2011-MA dtd. 09/11/2016 office of AS & DC, MSME) if they submit along with the offer, attested copies of either Udyam Registration Certificate or EM II certificate having deemed validity (five years from the date of issue of acknowledgement in EM II) or valid NSIC certificate or Udyog Aadhar Memorandum (UAM) & Acknowledgement or EM II certificate along with attested copy of a CA certificate (Format enclosed at Annexure – B where deemed validity of EM II certificate of five years has expired) applicable for the relevant financial year (latest audited). Date to be reckoned for determining the deemed validity will be the date of bid opening (Part 1 in case of two part bid). Non submission of such documents will lead to consideration of their bid at par with other bidders. No benefit shall be applicable for this enquiry if any deficiency in the above required documents are not submitted before price bid opening. If the tender is to be submitted through e-procurement portal, then the above required documents are to be uploaded on the portal. Documents should be notarized or attested by a Gazetted officer.

Any Bidder falling under MSME category, shall furnish the following details & submit documentary evidence/Govt. Certificate etc. in support of the same along with their techno-commercial offer: -

Type under MSME	SC/ST owned	Women owned	Others (excluding SC/ ST & Women Owned)
Micro			
Small			
Medium			

Note: - If the bidder does not furnish the above, offer shall be processed construing that the bidder is not falling under MSME category.

29.0 Compliance to Restrictions under Rule 144 (xi) of GFR 2017

- I. Any bidder from a country which shares a land border with India will be eligible to bid in this tender only if the bidder is registered with the Competent Authority. The Competent Authority for the purpose of this Clause shall be the Registration Committee constituted by the Department for Promotion of Industry and Internal Trade (DPIIT).
- II. "Bidder" (including the term 'tenderer', 'consultant' or 'service provider' in certain contexts) means any person or firm or company, including any member of a consortium or joint venture (that is an association of several persons, or firms or companies), every artificial juridical person not falling in any of the descriptions of bidders stated hereinbefore, including any agency branch or office controlled by such person, participating in a procurement process.
- III. "Bidder from a country which shares a land border with India" for the purpose of this Clause means: -
 - a. An entity incorporated established or registered in such a country; or
 - b. A subsidiary of an entity incorporated established or registered in such a country; or
 - c. An entity substantially controlled through entities incorporated, established or registered in such a country; or
 - d. An entity whose beneficial owner is situated in such a country; or

- e. An Indian (or other) agent of such an entity; or
 - f. A natural person who is a citizen of such a country; or
 - g. A consortium or joint venture where any member of the consortium or joint venture falls under any of the above
- IV. The beneficial owner for the purpose of (III) above will be as under:
1. In case of a company or Limited Liability Partnership, the beneficial owner is the natural person(s), who, whether acting alone or together, or through one or more juridical person, has a controlling ownership interest or who exercises control through other means.
- Explanation
- a. "Controlling ownership interest" means ownership of or entitlement to more than twenty-five per cent of shares or capital or profits of the company;
 - b. "Control" shall include the right to appoint majority of the directors or to control the management or policy decisions including by virtue of their shareholding or management rights or shareholders agreements or voting agreements;
2. In case of a partnership firm, the beneficial owner is the natural person(s) who, whether acting alone or together, or through one or more juridical person, has ownership of entitlement to more than fifteen percent of capital or profits of the partnership;
 3. In case of an unincorporated association or body of individuals, the beneficial owner is the natural person(s), who, whether acting alone or together, or through one or more juridical person, has ownership of or entitlement to more than fifteen percent of the property or capital or profits of the such association or body of individuals;
 4. Where no natural person is identified under (1) or (2) or (3) above, the beneficial owner is the relevant natural person who holds the position of senior managing official;
 5. In case of a trust, the identification of beneficial owner(s) shall include identification of the author of the trust, the trustee, the beneficiaries with fifteen percent or more interest in the trust and any other natural person exercising ultimate effective control over the trust through a chain of control or ownership.
- V. An Agent is a person employed to do any act for another, or to represent another in dealings with third person.
- VI. The successful bidder shall not be allowed to sub-contract works to any contractor from a country which shares a land border with India unless such contractor is registered with the Competent Authority.

Note:

- (i) The bidder shall provide undertaking for their compliance to this Clause, in the Format provided in Form-2.
- (ii) Registration of the bidder with Competent Authority should be valid at the time of submission as well as acceptance of the bids.

30.0 GeMAR and PTS ID: GEM/GARPTS/24052023/ZZVBA4WE4LWS

31.0 The Bidder declares that they will not enter into any illegal or undisclosed agreement or understanding, whether formal or informal with other Bidder(s). This applies in particular to prices, specifications, certifications, subsidiary contracts, submission or non-submission of bids or any other actions to restrict competitiveness or to introduce cartelization in the bidding process.

In case, the Bidder is found having indulged in above activities, suitable action shall be taken by BHEL as per extant policies/ guidelines.

Bidder shall submit duly filled & signed Annexure-VII along with their techno-commercial offer.

- 32.0 In the course of evaluation, if more than one bidder happens to occupy L-1 status, effective L-1 will be decided by soliciting discounts from the respective L-1 bidders.

In case more than one bidder happens to occupy the L-1 status even after soliciting discounts, the L-1 bidder shall be decided by a toss / draw of lots, in the presence of the respective L-1 bidder(s) or their representative(s).

Ranking will be done accordingly. BHEL's decision in such situations shall be final and binding.

- 33.0 "A bidder shall not have conflict of interest with other bidders. Such conflict of interest can lead to anti-competitive practices to the detriment of Procuring Entity's interests. **The bidder found to have a conflict of interest shall be disqualified.** A bidder may be considered to have a conflict of interest with one or more parties in this bidding process, if:

- a) they have controlling partner (s) in common; **or**
- b) they receive or have received any direct or indirect subsidy/ financial stake from any of them; **or**
- c) they have the same legal representative/agent for purposes of this bid; **or**
- d) they have relationship with each other, directly or through common third parties, that puts them in a position to have access to information about or influence on the bid of another Bidder; **or**
- e) Bidder participates in more than one bid in this bidding process. Participation by a Bidder in more than one Bid will result in the disqualification of all bids in which the parties are involved. However, this does not limit the inclusion of the components/ sub-assembly/ Assemblies from one bidding manufacturer in more than one bid, **or**
- f) In cases of agents quoting in offshore procurements, on behalf of their principal manufacturers, one agent cannot represent two manufacturers or quote on their behalf in a particular tender enquiry. One manufacturer can also authorize only one agent/dealer. There can be only one bid from the following:
 1. The principal manufacturer directly or through one Indian agent on his behalf; and
 2. Indian/foreign agent on behalf of only one principal,**or**
- g) A Bidder or any of its affiliates participated as a consultant in the preparation of the design or technical specifications of the contract that is the subject of the Bid; **or**
- h) In case of a holding company having more than one independently manufacturing units, or more than one unit having common business ownership/management, only one unit should quote. Similar restrictions would apply to closely related sister companies. Bidders must proactively declare such sister/ common business/ management units in same/ similar line of business. "

- 34.0 The GeM Seller ID shall be mandatory before placement of order / award of contract for goods and services to the successful bidder(s).

- 35.0 **Order of Precedence: In the event of any ambiguity or conflict between the Tender Documents, the order of precedence shall be in the order below: -**

- i) Amendments/Clarifications/Corrigenda/Errata/Tender change notice (TCN) etc. issued in respect of the tender documents by BHEL
- ii) Notice Inviting Tender (NIT)

- iii) Price Schedule
- iv) Scope of work & other details - Annexure-I, Annexure-BOCW, Annexure-SAS-I, Annexure-II, Annexure-III, Annexure for HSE and Special note to bidders
- v) SPECIFIC TERMS AND CONDITIONS FOR SERVICES JOBS
- vi) GENERAL & SPECIAL CONDITIONS OF CONTRACT FOR SERVICES JOB

All the bidders are requested to note that all the errata / technical clarifications / corrigendum / extension etc. shall be published THROUGH E-PROCUREMENT PORTAL <https://eprocurebhel.co.in> and in website www.bhel.com & <http://eprocure.gov.in> . As such, all the bidders are requested to be in continuous touch with these websites.

for BHARAT HEAVY ELECTRICALS LTD.

MANAGER (PURCHASE)

Agency	Contact details	
BHEL, PSER, Kolkata	Address	BHARAT HEAVY ELECTRICALS LIMITED, POWER SECTOR – EASTERN REGION 2ND FLOOR, BLOCK-DJ, PLOT- 9/1, SECTOR, SALT LAKE CITY, KOLKATA – 700 091
	Phone no.	033-23398261, 23398223, 23398221, 23398220, 23211690
	FAX no.	033-23211960
	E-mail ID	anima@bhel.in , anupriya.mundu@bhel.in , a_sarkar@bhel.in , smandol@bhel.in
NIC E-PROCUREMENT PORTAL	<p>For E-PROCUREMENT ASSISTANCE & TRAINING, NIC HELPDESK CONTACTS AS PER FOLLOWING: -</p> <p>For any technical related queries please call at 24 x 7 Help Desk Number 0120-4001 002 0120-4200 462 0120-4001 005 0120-6277 787</p> <p>Email Support Address: A) For any Issues or Clarifications relating to the published tenders, bidders are requested to contact the respective Tender Inviting Authority</p> <p>Technical - support-eproc@nic.in</p>	

ANNEXURE - IV

FORMAT FOR NO DEVIATION CERTIFICATE
(To be submitted in the bidder's letter head)

To,
Bharat Heavy Electricals Limited,
POWER SECTOR – EASTERN REGION
2nd FLOOR, Block-DJ, Plot- 9/1, SECTOR II
SALT LAKE CITY, KOLKATA – 700 091
FAX – 033-2321-1960

Job: “IN-SITU MACHINING & POLISHING OF EXCITER ROTOR SLIP RING OF GAS TURBINE GENERATOR-1 AT 2X363.3 MW GAS BASED COMBINED CYCLE POWER PLANT, PALATANA, OTPCL, TRIPURA”.

E-Tender No.: PSER:PUR:PAL-S518:23 (ENQ:23:PP:0015:PUR:14) Date 26/05/2023

Dear Sir/Madam,

With reference to above, this is to confirm that as per tender conditions, we have visited site before submission of our offer and noted the job content & site conditions etc. We also confirm that we have not changed/modified the tender documents as appeared in the websites and in case of observance at any stage, it shall be treated as null and void.

We hereby confirm that we have not taken any deviation from tender clauses together with other references as enumerated in the above referred NIT *and confirm our acceptance to reverse auctioning process* and we hereby convey our unqualified acceptance to all terms and conditions as stipulated in the tender and NIT.

In the event of observance of any deviation in any part of our offer at a later date whether implicit or explicit, the deviations shall stand null & void.

We confirm to have submitted offer strictly in accordance with tender instructions.

Thanking you,

Yours faithfully,

(Signature, date & seal of authorized
representative of the contractor)

ANNEXURE - V**PRE – QUALIFICATION CRITERIA**

Job: “IN-SITU MACHINING & POLISHING OF EXCITER ROTOR SLIP RING OF GAS TURBINE GENERATOR-1 AT 2X363.3 MW GAS BASED COMBINED CYCLE POWER PLANT, PALATANA, OTPCL, TRIPURA”.

E-Tender No.: PSER:PUR:PAL-S518:23 (ENQ:23:PP:0015:PUR:14) Date 26/05/2023.

SL NO	CRITERIA
	PRE-QUALIFICATION CRITERIA - FINANCIAL
1.0 (a)	BIDDER SHOULD HAVE AVERAGE ANNUAL TURNOVER OF MINIMUM Rs 2.33 LAKHS DURING LAST 3 (THREE) FINANCIAL YEARS, ENDING ON 31-03-2022 AND SHOULD HAVE POSITIVE NET WORTH AS ON LATEST AUDITED ACCOUNTS AS SUBMITTED FOR PARA 1(c).
(b)	BIDDER MUST HAVE EARNED PROFIT IN ANY ONE OF THE LAST THREE FINANCIAL YEARS ENDING ON 31-03-2022. AUDITED BALANCE SHEET AND PROFIT & LOSS ACCOUNT OF THE COMPANY FOR LAST 3 (THREE) FINANCIAL YEARS, ENDING ON 31-03-2022 NEED TO BE SUBMITTED IN SUPPORT OF ABOVE.
(c)	IN CASE AUDITED BALANCE SHEET AND PROFIT & LOSS ACCOUNT HAS NOT BEEN SUBMITTED FOR ALL THREE YEARS INDICATED ABOVE THEN APPLICABLE FINANCIAL AUDITED STATEMENTS SUBMITTED BY THE BIDDER AGAINST THE REQUISITE THREE YEARS WILL BE AVERAGED FOR THREE YEARS.
(d)	IF FINANCIAL STATEMENTS ARE NOT REQUIRED TO BE AUDITED STATUTORILY, THEN INSTEAD OF AUDITED FINANCIAL STATEMENTS, FINANCIAL STATEMENTS ARE REQUIRED TO BE CERTIFIED BY CHARTERED ACCOUNTANT.
	PRE-QUALIFICATION CRITERIA - TECHNICAL
2.0	BIDDER SHOULD HAVE EXECUTED AT LEAST ONE JOB OF “ERECTION & COMMISSIONING OR OVERHAULING OF GENERATOR” OR “IN-SITU MACHINING OF GENERATOR / EXCITER ROTOR SLIP RING” OF AN UNIT OF RATING 60 MW OR ABOVE IN ANY UTILITY/ INDUSTRIAL PROJECT IN LAST 7 (SEVEN) YEARS, ENDING ON LATEST DUE DATE OF SUBMISSION OF OFFER. RELEVANT SUPPORTING DOCUMENTS FROM PURCHASER / END USER SHALL BE SUBMITTED.
	NOTE FOR SL NO 2.0 ABOVE
	THE WORD EXECUTED MEANS: THE WORK SHALL HAVE BEEN COMPLETED UPTO SYNCHRONISATION (FIRST SYNCHRONISATION DATE SHALL BE CONSIDERED FOR EVALUATION) EVEN IF THE CONTRACT HAS NOT BEEN COMPLETED OR CLOSED.
3.0	BIDDER SHOULD HAVE VALID PAN. RELEVANT SUPPORTING DOCUMENTS SHALL BE SUBMITTED.
4.0	NO CONSORTIUM / JV BIDDING IS ALLOWED FOR THIS TENDER.
5.0	CONSIDERATION OF OFFER WILL BE SUBJECT TO CUSTOMER’S APPROVAL OF BIDDER.
6.0	BIDDER MUST NOT BE UNDER BANKRUPTCY CODE PROCEEDINGS (IBC) BY NCLT OR UNDER LIQUIDATION / BIFR, WHICH WILL RENDER HIM INELIGIBLE FOR PARTICIPATION IN THIS TENDER, AND SHALL SUBMIT UNDERTAKING TO THIS EFFECT.
Note	AFTER SATISFACTORY FULFILLMENT OF ALL THE ABOVE CRITERIA, OFFER SHALL BE CONSIDERED FOR FURTHER EVALUATION AS PER NIT AND ALL OTHER TERMS OF THE TENDER.

GENERAL INFORMATION:

VENDOR SHOULD FURNISH INFORMATION REGARDING PROJECTS IN HAND, DETAILS OF CURRENT LITIGATION AND ARBITRATION CASES, ORDERS REGARDING EXCLUSION/EXPULSION OR BLACK LISTING, IF ANY.

CORRIGENDUM/EXTENSION (IF ANY) OF THIS TENDER WILL BE PUBLISHED IN WEBSITES.

INTERESTED BIDDERS MEETING THE ABOVE QUALIFYING REQUIREMENTS MAY DOWNLOAD TENDER DOCUMENTS FROM AFORESAID WEBSITE(S).

i)	DOWNLOAD OF TENDER DOCUMENT STARTS	26/05/2023
ii)	TENDER DOWNLOAD CLOSING ON	29/05/2023 AT 14:00 HRS. IST
iii)	LAST DATE OF SEEKING CLARIFICATIONS	29/05/2023 UP TO 11:00 HRS. IST
iv)	PRE-BID DISCUSSION (IF REQUIRED) ON	N.A.
v)	LAST DATE OF SUBMISSION OF OFFER	29/05/2023 UP TO 14:00 HRS. IST
vi)	DATE OF TECHNO-COMMERCIAL BID OPENING	29/05/2023 AT 16:30 HRS. IST

BHEL RESERVE THE RIGHT TO ACCEPT/REJECT ANY OR ALL THE BIDS WITHOUT ASSIGNING ANY REASON THEREOF.

NOTE: PRE-BID DISCUSSION, IF TAKE PLACE, SHALL FORM PART OF THE TENDER DOCUMENT. NO CLARIFICATIONS/QUIERIES FROM THE TENDERERS AFTER **29/05/2023 (UP TO 11:00 HRS. IST) OR AFTER PRE-BID DISCUSSION (IF TAKES PLACE) SHALL BE ENTERTAINED BY BHEL.**

ENCLOSURES: -

- i) SCOPE OF WORK, TAXES AND DUTIES & OTHER DETAILS: (ANNEXURE-I: 04 PAGES)
- ii) SPECIFIC CLAUSE WITH RESPECT TO BOCW ACT & CESS ACT: (ANNEXURE-BOCW: 02 PAGES)
- iii) ESSENTIAL CONDITIONS TO BE FULFILLED BY SUCCESSFUL BIDDER (ANNEXURE-SAS-I: 01 PAGE)
- iv) TENTATIVE LIST OF T & P (ANNEXURE-II: 04 PAGES)
- v) LIST OF CONSUMABLES TO BE ARRANGED BY THE CONTRACTOR IN ADDITION TO THE NORMAL CONSUMABLES (ANNEXURE-III: 01 PAGE)
- vi) SPECIAL NOTE TO BIDDERS: 02 PAGES
- vii) ANNEXURE FOR HSE PLAN VIDE DOC. NO. HSEP14 (REV. 02): 131 PAGES
- viii) GENERAL & SPECIAL CONDITIONS OF CONTRACT FOR SERVICES JOB (24 PAGES)
- ix) SPECIFIC TERMS AND CONDITIONS FOR SERVICES JOB (14 PAGES)
- x) NO DEVIATION CERTIFICATE AS PER PRESCRIBED FORMAT (ANNEXURE-IV)
- xi) PRE-QUALIFICATION CRITERIA (ANNEXURE-V)
- xii) DECLARATION OF THE BIDDERS (ANNEXURE-VI)
- xiii) DECLARATION OF RELATED FIRMS AND THEIR AREA OF ACTIVITIES (ANNEXURE-VII)
- xiv) PRICE SCHEDULE
- xv) GENERAL TERMS & CONDITIONS OF REVERSE AUCTION (PART – D)
- xvi) FORMAT FOR BANK GUARANTEE FOR PERFORMANCE SECURITY
- xvii) FORMAT FOR PROFORMA OF BANK GUARANTEE (in lieu of SECURITY DEPOSIT)
- xviii) RTGS FORMAT (REAL TIME GROSS SETTLEMENT)
- xix) SUSPENSION OF BUSINESS DEALING WITH SUPPLIERS/CONTRACTORS - ANNEXURE-A
- xx) FORMAT FOR CERTIFICATE BY CHARTERED ACCOUNTANT ON LETTER HEAD - ANNEXURE-B
- xxi) BANKRUPTCY/ LIQUIDATION UNDERTAKING-ANNEXURE-C
- xxii) FORMAT FOR DECLARATION FOR RELATION IN BHEL
- xxiii) FORMAT FOR SEEKING CLARIFICATION
- xxiv) FORMAT FOR DETAILS OF BIDDER
- xxv) FORM-1 (FORMAT FOR LOCAL CONTENT)
- xxvi) FORM-2
- xxvii) RTGS DETAILS OF BHEL-PSER FOR EFT BY BIDDER/CONTRACTOR

ALL THE PAGES OF NIT SHALL BE DULY SIGNED BY THE BIDDER WHILE SUBMITTING THE OFFER.

For & on behalf of
BHARAT HEAVY ELECTRICAL LIMITED

MANAGER (PURCHASE)

PARTICULARS OF THE TENDER

- A) E-TENDER NUMBER : **PSER:PUR:PAL-S518:23 (ENQ:23:PP:0015:PUR:14) Date 26/05/2023.**
- B) WORK : **“IN-SITU MACHINING & POLISHING OF EXCITER ROTOR SLIP RING OF GAS TURBINE GENERATOR-1 AT 2X363.3 MW GAS BASED COMBINED CYCLE POWER PLANT, PALATANA, OTPCL, TRIPURA”.**
- C) TENDER SUBMISSION DUE DATE : **ON 29/05/2023 UP TO 14:00 HRS. IST**
- D) TECHNICAL BID OPENING DATE : **ON 29/05/2023 AT 16:30 HRS. IST**
- E) PRICE BID OPENING :
- F) VALIDITY OF OFFER : Six months from the due date of offer submission (Including extension, if any)
- G) MOBILIZATION TIME : **As per Annexure-I**
- H) COMPLETION PERIOD : **As per Annexure-I**
- I) TARGET COMPLETION DATE :
- J) The vendors should furnish the following documents for our scrutiny along with papers for pre-qualification for qualifying for price bid opening.
- 1) Credential / Experience certificates in line with Pre-Q & requirements in line with tender specifications
 - 2) PAN NO & Photo Copy of PAN CARD.
 - 3) Photo Copy of GSTN Registration Certificate.
 - 4) Latest Banker’s certificate for financial soundness.
 - 5) Balance sheets & P&L Accounts for the preceding three years
 - 6) Organizational chart
 - 7) Relevant list of T&P held by the vendor earmarked for the tendered job
 - 8) List of concurrent contracts held by the Contractor.

Particulars of Tender (Continued)

Facilities to be provided to contractors as described below: -

All T&P required / recommended for the work against this tender shall have to be mobilized by the contractor fully at their expense within the quoted price.

Any special T&P i.e. T&P made available by the manufacture of the equipment to the customer can be made available to the contractor free of charges subject to availability at site.

Any consumables required / recommended for the work against this tender shall have to be mobilized by the contractor fully at their expenses within the quoted price.

Regarding other facilities for the contractors the following table clarifies adequately. Vendors are expected to quote considering these without any deviations from the provisions of “Notice Inviting Tender”.

Deviated offers are liable for rejection of price bid opening

a)	Water	Free of Charges
b)	Power	Free of Charges
c)	Storage Space	Free of Charges
d)	Covered Space	Free of Charges
e)	Uncovered Space	Free of Charges
f)	E.O.T. Crane (limited approach)	Free of Charges
g)	Operators for the above	Cannot be provided
h)	Residential accommodation	Cannot be provided
i)	Compressed air	Free of Charges
j)	Work shop facilities	Cannot be provided

k)	i) Mobile Crane/Pick & carry tyre mounted Front cabin mobile crane (FX or TRX/NextGen series of 'ESCORT' or equivalent make) if available	Cannot be provided
	ii) Operator for K (i)	Cannot be provided
	iii) Fuel for K (i)	Cannot be provided
l)	Other material handling equipment	Cannot be provided
m)	Trailor	Cannot be provided
n)	Sleepers	Cannot be provided
o)	Tarpaulins	Cannot be provided
p)	Scaffolding materials	Cannot be provided

No advance is payable to the contractors for mobilizing the site. Any payment can be made only against running bills as per payment terms.

For & on behalf of
BHARAT HEAVY ELECTRICALS LIMITED

MANAGER (PURCHASE)

ANNEXURE-VI

DECLARATION OF THE BIDDERS

Job: "IN-SITU MACHINING & POLISHING OF EXCITER ROTOR SLIP RING OF GAS TURBINE GENERATOR-1 AT 2X363.3 MW GAS BASED COMBINED CYCLE POWER PLANT, PALATANA, OTPCL, TRIPURA".

01. I,hereby certify that all the information and data furnished by me with regard to this **E-Tender No. PSER:PUR:PAL-S518:23 (ENQ:23:PP:0015:PUR:14) Date 26/05/2023** are true and complete to the best of my knowledge.
02. I have gone through the tender specifications, scope of work, terms and conditions mentioned in Annexure as well as General and Special conditions of contract and various stipulations in detail and agree to abide by them and comply with the requirements and intent of specifications.
03. I also certify that there have been no deviations from the tender requirements in the bid submitted against this tender.
04. I further certify that I am duly authorized representative of the under mentioned tenderer and hold a valid power of attorney to this effect, a copy of which is enclosed.

Signature:

Name :

Date :

Designation :

Seal :

Tenderers Name and address

ANNEXURE-VII
DECLARATION

Date: -----

Job: "IN-SITU MACHINING & POLISHING OF EXCITER ROTOR SLIP RING OF GAS TURBINE GENERATOR-1 AT 2X363.3 MW GAS BASED COMBINED CYCLE POWER PLANT, PALATANA, OTPCL, TRIPURA".

E-Tender No.: PSER:PUR:PAL-S518:23 (ENQ:23:PP:0015:PUR:14) Date 26/05/2023.

To: -----
Address: BHEL, -----

Email: -----

Sub: **Details of related firms and their area of activities**

Dear Sir/Madam,

Please find below details of firms owned by our family members that are doing business/registered for same item with BHEL, -----(NA, if not applicable)

1	Material Category/ Work Description	
	Name of Firm	
	Address of Firm	
	Nature of Business	
	Name of Family Member	
	Relationship	
2	Material Category/ Work Description	
	Name of Firm	
	Address of Firm	
	Nature of Business	
	Name of Family Member	
	Relationship	
...		

Note: I certify that the above information is true and I agree for penal action from BHEL in case any of the above information furnished is found to be false.

Regards,

(-----)

From: M/s-----
Supplier Code: -----
Address: -----

PART-D:
General Terms & Conditions of Reverse Auction

Against this enquiry for the subject item/ system with detailed scope of supply/service as per tender specifications, BHEL *shall be resorting* to "REVERSE AUCTION PROCEDURE" i.e., ON LINE BIDDING (THROUGH A SERVICE PROVIDER). The philosophy followed for reverse auction shall be English Reverse (No ties).

1. For the proposed reverse auction, technically and commercially acceptable bidders only shall be eligible to participate.
2. *Price bids of all techno-commercially qualified bidders shall be opened and same shall be considered for RA.*
3. BHEL will engage the services of a service provider who will provide all necessary training and assistance before commencement of on line bidding on internet.
4. In case of reverse auction, BHEL will inform the bidders the details of Service Provider to enable them to contact & get trained for participation in the reverse auction.
5. Business rules like event date, time, bid decrement, extension etc. also will be communicated through service provider for compliance.
6. Bidders have to fax *le-mail* the Compliance form (annexure III) before start of Reverse auction. Without this, the bidder will not be eligible to participate in the event.
7. In line with the NIT terms, BHEL will provide the calculation sheet (e.g., EXCEL sheet) which will help to arrive at "Total Cost to BHEL" which is inclusive of all cost elements in line with terms & conditions of the tender for each of the bidder to enable them to fill-in the price and keep it ready for keying in during the Auction.
8. Reverse auction will be conducted on scheduled date & time.
9. At the end of Reverse Auction event, the lowest bidder value will be known on auction portal.
10. The lowest bidder has to fax/e-mail the duly signed and filled-in prescribed format for price breakup including that of line items, if required, (Annexure VI) as provided on case-to-case basis to Service provider within two working days of Auction without fail.
11. *Bidders shall be required to read the "Terms and Conditions" section of the auctions site of Service provider, using the Login IDs and passwords given to them by the service provider before reverse auction event. Bidders should acquaint themselves of the "Business Rules of Reverse Auction", which will be communicated before the Reverse Auction.*
12. The Bidder shall not divulge either his Bids or any other exclusive details of BHEL to any other party. If the Bidder or any of his representatives are found to be involved in Price manipulation/ cartel formation of any kind, directly or indirectly by communicating with other bidders, action *as per extant BHEL guidelines for suspension of business dealings (as available on www.bhel.com)*, shall be initiated by BHEL and the results of the RA scrapped/ aborted.
13. Reverse Auction will be conducted if two or more bidders are techno-commercially qualified. In case of two or three qualified bidders, there shall be no elimination of H1 bidder (whose quote is highest in sealed envelope price bid). In case of four qualified bidders, the H1 bidder shall be eliminated whereas in case of five qualified bidders, H1 & H2 bidders shall be eliminated. However, in case of six or *more qualified bidders are available, RA would be conducted amongst first 50% of the bidders arranged in the order of prices from lowest to highest. Number of bidders eligible for participating in RA would be rounded off to next higher integer value if number of qualified bidders is odd (e.g. if 7 bids are qualified, then RA will be conducted amongst lowest four bidders). However, there will be no elimination of qualified bidders who are MSE or qualifying under PPP-MII, Order 2017, irrespective of the number of bidders qualifying techno-commercially.*

In case of multiple H1 bidders, all H1 bidders (excluding MSEs and bidders qualifying under PPP-MII, Order 2017) shall be removed provided minimum two bidders remain in fray, else no H1 removal.

Annexure-ISCOPE OF WORK

Job Description: In-Situ machining & polishing of Exciter Rotor Slip Ring of Gas Turbine Generator-1, at 2 x 363.3 MW Gas Based Combined Cycle Power Plant at Palatana, Tripura

JOB DURATION: 5 DAYS from START OF WORK TO BG IN. Start of work shall be certified by BHEL site engineer and shall commence from date of BG out or within 3 day from date of intimation by BHEL, whichever is later.

Mobilisation Time: within 3 days from date of intimation by BHEL

The scope under this specification is not exhaustive but indicative only. However, any activity covered under the normal course of overhauling job shall be deemed to be within the scope. The scope shall also include, manpower assistance during trim balancing as may be required including post overhauling vibration signature analysis. Time is the essence of this contract. Hence contractor must mobilize site with adequate manpower for round the clock 12 hours shifts work during the entire duration. Workmen will not be allowed to work more than 12hrs a day. Also adequate T&P, Consumables and inspection/measuring and monitoring devices are to be mobilized at site for two shift operations to avoid any hold up during execution of the work. Post overhauling and synchronization of the unit, observation for 72 hrs at stable load and attending all works to rectify defects if any, is included within the scope of work. Prior to mobilization of site list of work men shift wise with the concerned work area supervisor shall be finalized in BHEL-PSER, HQ.

In case any part of the job is not required to be carried out, a deduction will be effected as per percentage shown against those items.

NOTE:

- 1) NECESSARY SCAFFOLDING MATERIAL TO BE ARRANGED BY VENDOR TO MAKE PLATFORMS.

	Total	(100.00%)
	SECTION-I (EXCITER ROTOR SLIP RING)	
A.	In-Situ machining of Exciter Rotor Slip Ring of Gas Turbine Generator-1	(92.00%)
1.	Dismantling and Removal of acoustic enclosure	8.00%
2.	Removal of Brush holder and all Excitation cable.	5.00%
3.	Dismantling and Removal of Brush carrier assembly.	4.00%
4.	Thorough cleaning of slip ring and recording Run out of slip ring.	4.00%
5.	Measurement of OD and ID of slip ring, groove depth measurement.	2.00%
6.	Removal of top cover of Brg-7 pedestal and recording reading.	3.00%
7.	Fitting of slip ring machining tools and fixtures. Special tools for machining to be arranged by vendor. (if required fabrication of required fixture is in vendor scope).	15.00%
8.	In-situ machining of exciter rotor slip ring along with polishing to achieved the run out within allowable limits.	40.00%
9.	Assembly of brush gear and complete box up of dismantled parts.	8.00%
10.	Putting machining on barring gear.	3.00%
	SECTION-II:SYNCHRONISATION & SAFETY COMPLIANCE	(8.00%)
1	Deployment of safety officers (2 nos) having qualification of Diploma in Safety / customer requirement for round the clock operation, arrangement of safety equipment, safety & HSE compliance (customer & BHEL) at site. Housekeeping at BHEL site office and work place.	5.00%
2	ASSISTANCE DURING COMMISSIONING/SYNCHRONIZATION OF THE UNIT AND OBSERVATION FOR 72 HRS AFTER SYNCRONIZATION OF MACHINE	3.00%

General scope of work and terms:

01. Transportation of spares from CUSTOMER store to site and return to store if not used.
02. Transportation of special T& Ps, lifting tackles etc from CUSTOMER store to site and return to store after job completion.
03. Issuing and returning of materials from CUSTOMER store and returning back & material reconciliation.
04. General illumination is available but for carrying out overhauling job any illumination is required is to be arranged.
05. After completion of work, the area shall be cleared up to the satisfaction of BHEL Site Engineer in charge/CUSTOMER. Disposal of scrap/ waste/ insulation / debris generated while overhauling work to be disposed off at predetermined place as indicated by CUSTOMER by the bidder including transportation of the waste.
06. The contractor shall have to bear for the loss of any damage to the items belonging to CUSTOMER due to Improper handling / storing or improper fitting etc. and necessary recoveries will be made from the Contractor.
07. The contractor shall erect approach platform as per requirement and dismantle the same. Scaffolding material shall be brought by the contractor.
08. The contractor shall be fully responsible for maintenance of records of his employees.
09. Contractor shall engage his personnel round the clock and shall submit detailed work plan, bar chart, manpower deployment plan (in nos. and skill level only) round the clock and work progress and these shall be discussed and agreed prior to award of contract.
10. Housekeeping: Maintaining proper cleanliness around the work area is the contractor's responsibility. The contractor has to depute separately identified persons exclusively for area cleaning.
11. Safety Requirements: All persons working shall strictly follow the CUSTOMER safety norms. Contractor shall be solely responsible for ensuring the safety of his all worker / employees.
12. Contractor shall provide and ensure the proper use of all safety gadgets to / by his all employees / workers engaged for this work. Contractor shall provide following safety gadgets confirming to the IS norms: safety helmets, safety goggles, safety shoes, hand gloves, & safety belts. Failing to the issue or use of the safety gadgets based on the requirement (abiding to the safety norms) a penalty of Rs. 2000/-shall be imposed.
13. The contractor shall ensure that safety related awareness training has been given to his all workers / employees at the time of start of contract and it is mandatory to obtain identity card for the same from CUSTOMER safety department.
14. Qualified safety supervisor(s) must be engaged by the contractor to take care of safety exclusively of his workers / employees engaged for the subject work. Contractor shall also ensure that there shall not be any safety hazard to the persons / machines in the vicinity due to his activities.
15. All lifting tools and tackles to be used shall be having the valid test certificate (with proper identification mark on the tools) from government approved agency and the same shall be produced to Engineer before start of work.
16. Other Requirements: Contractor shall ensure that environmental related awareness training has been given to his workers / employees at the time of start of contract.
17. **Agency has to arrange their own incoming / outgoing Road permit for the T&Ps, materials, consumables etc required for the work.**
18. **Deployment of one Safety Officer (round the clock) having qualification of Diploma in Safety for entire duration of the job & vendor shall comply safety provisions of the customer.**

For all the above cases arrangement of necessary Material handling equipment will be in vendor's scope

TAXES AND DUTIES:

	TAXES, DUTIES ETC
1	All taxes excluding GST & BOCW Cess (as specified elsewhere in the tender) but including, Charges, Royalties, any State or Central Levy and other taxes for materials if any obtained for the work and for execution of the contract shall be borne by successful bidder and shall not be payable extra by BHEL. Any increase of above at any stage during execution of contract, including extension of the contract, shall have to be borne by successful bidder contractor. Bidder's quoted/ accepted rates/ price shall be inclusive of all such requirements.
2	GST along with Cess (as applicable) legally leviable & payable by successful bidder as per GST Law shall be paid by BHEL, extra. Hence, bidder shall not include GST along with Cess (as applicable) in their quoted rates/ price.

3	Successful bidder shall furnish proof of GST registration with GSTN Portal covering the services under this contract. Registration should also bear endorsement for the premises from where the billing shall be done by successful bidder on BHEL for this project / work.
4	Since GST on output will be paid by BHEL separately as enumerated above, bidder's your quoted rates / price should be after considering the Input Credit under GST law at bidder's end.
5	TDS under Income Tax Act shall be deducted as per prevailing IT rules from the bills.
6	TDS under GST shall be deducted as per prevailing GST rules from the bills.
7.1	You may collect TCS under section 206C(1H) of Income Tax Act, 1961 if applicable.
7.2	In case, you collect TCS under section 206C(1H) of Income Tax Act, 1961, following compliance is required.
7.2.1	TAN and PAN of vendor should appear in all invoices/claims. Copy of TAN /TCS registration is to be submitted.
7.2.2	Amount of TCS and Assessable value on which TCS has been calculated should be specified clearly in the invoice.
7.2.3	You shall be required to submit certificate of TCS in Form no. 27D within 15 days from the due date for furnishing the statement of tax collected at the source.
7.3	In case, you do not collect TCS under section 206C(1H) of Income Tax Act, 1961, following declaration is to be submitted alongwith each invoice: - "I/We hereby declare that I/We are not required to collect TCS under section 206C(1H) of Income Tax Act, 1961, on this bill.
7.4	In event of failure to comply with the provisions of the Act, or proper certificate not issued, or if tax collected but not remitted to the Government, or for any other reason and thereby causing loss to BHEL, the same shall be recoverable from the vendor with applicable interest.
7.5	You shall comply with all statutory amendment/notifications in this respect.
8	Bidder shall note that GST Tax Invoice complying with GST Invoice Rules (Section 31 of GST Act & Rules referred thereunder) wherein the 'Bill To' details shall encompass following. BHEL GSTN – 16AAACB4146P1ZI NAME: Bharat Heavy Electricals Limited ADDRESS: BHEL-PSER Site office OTPCL-PALATANA Site 2X363.3 MW UNIT TRIPURA, INDIA
9	Successful bidder to intimate immediately on the day of removal of goods (in case of any supply of goods) to BHEL along with all relevant details and send a scanned copy of Tax Invoice to BHEL through following communication mode for enabling BHEL to meet its GST related compliances. Portal address. and Email address – Shall be intimated later. Specific details of above shall be intimated to successful bidder by BHEL at appropriate juncture.
10	In case of delay in submission of above mentioned documents on the date of despatch, BHEL may incur penalty / interest for not adhering to Invoicing Rules under GST Law. The same will be liable to be recovered from successful bidder, in case such delay is not attributable to BHEL.
11	In case of raising any Supplementary Tax Invoice (Debit / Credit Note), successful bidder shall issue the same containing all the details as referred to in Section 34 read with Section 31 of GST Act & Rules referred there under.
12	Successful bidder shall comply with the Time Limit prescribed under the GST Law and rules thereof for raising of the Tax Invoice. If any supply of goods is applicable, successful bidder shall also ensure prompt delivery of goods after despatch.
13	Bidder shall note that in case GST credit is delayed / denied to BHEL due to delayed / non receipt of goods and / or Tax Invoice or expiry of the timeline prescribed in GST Law for availing such ITC, or any other reasons, not attributable to BHEL, GST amount shall be recoverable from successful bidder along with interest levied/ leviable on BHEL, as the case may be.

14	Successful bidder shall upload the invoices raised on BHEL in GSTR-1 within the prescribed time as given in the GST Act, and the same shall be available to BHEL in FORM GSTR-2A/2B electronically through the common portal. Bidder shall note that in case of delay in declaring such invoice in your return and GST credit availed by BHEL is denied or reversed subsequently as per GST Law, GST amount paid by BHEL towards such ITC reversal as per GST law shall be recoverable from the successful bidder along with interest levied / leviable on BHEL.
15	Way Bill: Successful bidder to arrange for way bill / e-waybill for any transfer of goods for the execution of the contract. Successful bidder has to make their own arrangement at their cost for completing the formalities, if required, with Issuing Authorities, for bringing materials, plants & machinery at site for execution of the works under this contract, Road Permit / Way Bill, if required, shall be arranged by successful bidder and BHEL will not supply any Road Permit/ Way Bill for this purpose.
16	Any new taxes & duties, if imposed subsequent to due date of offer submission as per NIT & TCN, by statutory authority during contract period (including extension, if the same is not attributable to you), shall be reimbursed by BHEL on production of relevant supporting document to the satisfaction of BHEL. However, you shall obtain prior approval from BHEL before depositing new taxes and duties.
17	Benefits and / or abolition of all existing taxes must be passed on to BHEL against new taxes, if any, proposed to be introduced at a later date.

-----X-----

Annexure –BOCWSpecific clause wrt BOCW Act & Cess Act

1. It shall be the sole responsibility of the contractor as employer to ensure compliance of all the statutory obligations under the Building and other Construction Workers' (Regulation of Employment and Conditions of Service) Act, 1996 and the Building and other Construction Workers' Welfare Cess Act, 1996 and the rules made thereunder.
2. It shall be sole responsibility of the contractor engaging Building Workers in connection with the building or other construction works in the capacity of employer to apply and obtain registration certificate specifying the scope of work under the relevant provisions of the Building and Other Construction Workers' (Regulation of Employment and Conditions of Service) Act, 1996 from the appropriate Authorities.
3. It shall be responsibility of the contractor to furnish a copy of such Registration Certificate within a period of one month from the date of commencement of Work.
4. It is responsibility of the contractor to register under the Building and other Construction Workers' Welfare Cess Act, 1996 and deposit the required Cess for the purposes of the Building and other Construction Workers' (Regulation of Employment and Conditions of Service) Act, 1996 at such rate as the Central Government may, by notification in the Official Gazette, from time to time specify. However, before registering and deposit of Cess under the Building and other Construction Workers' Welfare Cess Act, 1996, the contractor will seek written prior approval from the Construction Manager.
5. In case where the contractor has been accorded written approval by the Construction Manager and the contractor is required to furnish information in Form I and deposit the Cess under the Building and other Construction Workers' Welfare Cess Act, 1996, fails to do so, BHEL reserves right to impose penalty at the rate of 30% of Cess Amount.
6. It shall be sole responsibility of the contractor as employer to get registered every Building Worker, who is between the age of 18 to 60 years of age and who has been engaged in any building or other construction work for not less than ninety days during the preceding twelve months as Beneficiary under the Building and other Construction Workers' (Regulation of Employment and Conditions of Service) Act, 1996.
7. It shall be sole responsibility of the contractor as employer to maintain all the registers, records, notices and submit returns under the Building and other Construction Workers' (Regulation of Employment and Conditions of Service) Act, 1996 and the Building and other Construction Workers' Welfare Cess Act, 1996 and the rules made thereunder.
8. It shall be sole responsibility of the contractor as employer to provide notice of poisoning or occupation notifiable diseases, to report of accident and dangerous occurrences to the concerned authorities under the Building and other Construction Workers' (Regulation of Employment and Conditions of Service) Act, 1996 and the rules made thereunder and to make payment of all statutory payments & compensation under the Employees' Compensation Act, 1923.

Annexure –BOCWSpecific clause wrt BOCW Act & Cess Act

9. It shall be responsibility of the Contractor to furnish BHEL on monthly basis, Receipts/ Challans towards Deposit of the Cess under the Building and other Construction Workers' Welfare Cess Act, 1996 and the rules made thereunder along with following statistics :
 - (i) Number of Building Workers employed during preceding one month.
 - (ii) Number of Building workers registered as Beneficiary during preceding one month.
 - (iii) Disbursement of Wages made to the Building Workers for preceding wage month.
 - (iv) Remittance of Contribution of Beneficiaries made during the preceding month
10. BHEL shall reimburse the contractor the Cess amount deposited for the purposes of the Building and other Construction Workers' (Regulation of Employment and Conditions of Service) Act, 1996 under the Building and other Construction Workers' Welfare Cess Act, 1996 and the rules made thereunder. However, BHEL shall not reimburse the Fee paid towards the registration of establishment, fees paid towards registration of Beneficiaries and Contribution of Beneficiaries remitted.
11. It shall be responsibility of the Building Worker engaged by the Contractor and registered as a beneficiary under the Building and other Construction Workers' (Regulation of Employment and Conditions of Service) Act, 1996 to contribute to the Fund at such rate per mensem as may be specified by the State government by notification in the Official Gazette. Where such beneficiary authorizes the contractor being his employer to deduct his contribution from his monthly wages and to remit the same, the contractor shall remit such contribution to the Building and other construction Workers' Welfare Board in such manner as may be directed by the Board , within the fifteen days from such deduction.
12. If any point of time during the contract period, non-compliance of the provisions of the Building and other Construction Workers' (Regulation of Employment and Conditions of Service) Act, 1996 and the Building and other Construction Workers' Welfare Cess Act, 1996 and the rules made thereunder is observed, BHEL reserves the right to withhold a reasonable amount from the payables to discharge any obligations on behalf of Contractors. The reasonable amount shall be decided by the Construction Manager in consultation with Resident Accounts Officer & Head HR and shall be final.
13. The contractor shall declare to undertake any liability or claim arising out of employment of building workers and shall indemnify BHEL from all consequences / liabilities / penalties in case of non compliance of the provisions of the Building and other Construction Workers' (Regulation of Employment and Conditions of Service) Act, 1996 and the Building and other Construction Workers' Welfare Cess Act, 1996 and the rules made thereunder.

ANNEXURE – SAS-I

ESSENTIAL CONDITIONS TO BE FULFILLED BY SUCCESSFUL BIDDER

01. Successful bidder has to arrange 6 copies of overhauling reports which will include various protocols with necessary data / MOMs / important correspondences / log sheets/ colour photographs etc. and the books shall be spiral bound with thick acetate papers in front and back along with BHEL logo printed suitably on thick art paper at the front.
02. Bidder has to arrange to provide PC with internet connection, with colour printer and Xerox paper as required for taking print out compatible with WINDOW vista version or, latest version loaded with necessary software, during entire period of execution of job at site , for preparing /maintaining / up keeping of various correspondences/ protocols/log shts. etc. . PC shall be operated by PC operator conversant with AUTOCAD and other softwares to be arranged by the successful bidder within the scope. All data thus stored during the execution of job shall be handed over to Resident Manager at site after the Overhauling for submission to Customer. In case vendor fails to provide the PC operator, Rs 8000/- per month shall be deducted from vendor's bill.
03. Successful bidder is to render services for proper up-keepment of BHEL site office as required. Full time office boy is required to be provided by the successful bidder at site for up keepment of site office.
04. After dismantling and during execution of the job, successful bidder has to suitably tag the components and sub-assemblies for trace ability and store properly before final assembly. This is as per instruction of BHEL Site in charge.
05. Process control of Special Processes like Welding and Heat Treatment shall be carried by successful bidder as per instruction of BHEL Site in charge.
06. Proper segregation, identification, tagging and up-keep of all dismantled items at work site during job execution have to be done by successful bidder.
07. Successful bidder is to obtain necessary "No Dues" certificates before de- mobilisation from site.
08. Successful bidder is to comply with all the statutory and regulatory norms, rules and practices as applicable for the job/site.
09. Successful bidder shall provide valid calibration certificates for IMTEs, fitness certificates for T&Ps and Construction Equipment (e.g. wire ropes, hand operated chain pulley blocks, pulling and lifting machines, electric welding generators, arc welding transformers etc.). Calibration of IMTEs is to be arranged from the accredited agencies. Calibration certificates should have the traceability as per national/international standards. At work site the IMTEs, T&Ps and Construction Equipment shall be checked/tested/inspected by BHEL engineers. The procedure for fitness testing and storage preservation and maintenance of Construction Equipment and T&Ps shall be as per instruction of BHEL site engineers.
10. Successful bidder should follow all safety norms at work site as per instruction of BHEL engineer at site.
11. Any NDT within the scope shall be as per instruction of BHEL site engineer.
12. Provision of packaged drinking water facility at BHEL site office.
13. The successful bidder is to arrange a full set of First Aid kit for attending to manpower deployed by him at site as per requirement.
14. The successful bidder is to arrange extra illumination at work site to augment the existing site illumination if required to enable round-the-clock safe working.
15. Vendor shall submit daily job plan & progress report to the concerned BHEL Engineer, review the programme from time to time.
16. Special barricading is to be done for working area. Entry of persons to working area is to be controlled during O/H.

ANNEXURE-II**TENTATIVE LIST OF T & P**

Tentative List T&Ps for the job is mentioned below. Vendor has to arrange T&Ps as may be required for successful completion of the job. T&Ps are to be mobilized by vendor as and when required to match the work schedule & complete the job on time. BHEL has the authority to penalize the contractor suitably including termination of contract if the required/necessary T&P's are not mobilized in time for successful completion of job.

Sl. No.		Quantity
	MEASURING TOOLS	
1.01	Dial Indicator with Magnetic Base	6 sets
1.02	Dial indicator – button type and LASTWARD (3 mm travel, 25 mm dia dial with links for coupling alignment)	2 set each
1.03	Slip gauge up to 10 mm	1 set
1.04	Micro-head level, accuracy 0.1 mm per metre, 150 mm long	1 no.
1.05	Square level for leveling major parts for installation (accuracy 0.1 mm, 150 mmX150 mm)	1 no.
1.06	Vernier Caliper 150 mm and 300 mm	1 no. each
1.07	Set of spring caliper and divider(150 mm)	1 set
1.08	Zenith caliper for marking (150 mm)	1 no.
1.09	Steel Scale 150 mm, 300 mm, 1000 mm	2 nos each
1.10	Telescopic gauge up to 150 mm	1 set
1.11	Bore dial gauge up to 75 mm	1 set
1.12	Inside micrometer up to 1500 mm	1 set
1.13	Outside micrometer	2 nos
	0-25 mm	
	0-50 mm	1 no.
	50-200 mm	1 no.
	200-300 mm	1 no.
	300-400 mm	1 no.
	400-500 mm	1 no.
1.14	Taper Gauge up to 20 mm	1 no.
1.15	Taper gauge 0.1 – 10 mm	1 no
1.16	Feeler gauge 100 mm, 200 mm, 300 mm long (from 0.03 to 1.0 mm thick)	1 set each
1.17	Feeler strip 0.03 mm, 0.04 mm, 0.05 mm, 0.10 mm X 300 mm long	5 each
1.18	Thread Gauge M4 to M56	1 set
1.19	Depth micrometer 0-25 mm	1 no.
1.20	Surface plate 300 mm X 300 mm	1 no.
1.21	Combination set	1 no.
1.22	Ball pen gauge for 3 to 10 mm bore	1 set
1.23	Measuring steel tape 3 M, 15 M	2 each
1.24	500 V hand / motorized megger	1 no.
1.25	1000 V hand / motorized megger	1 no.
1.26	250 V megger	1 no.
1.27	3 1/2 Digit digital multimeter	1 no.
1.28	Lever type dial gauge for centering	1 no.

CUTTING TOOL

2.01	Tap set M 5 to M42 (including M27 & m 33)		1 set each
2.02	Die set M 14 to M 65		1 set each
2.03	Pistol Drill	6 mm	2 nos.
	-Do-	15 mm	1 no.
	-Do- with magnetic stand	19 mm	1 no.
2.04	Straight grinder GQ 4		3 nos.
2.05	Angle grinder AG 7 and AG 5		2 nos. each
2.06	Pistol grinder		1 no.
2.07	Flexible grinder with necessary accessories		2 nos.
2.08	Bench grinder 150 mm		1 no.
2.09	Hole punch up to 32 mm		1 set
2.10	Easy out up to M 24		1 set
2.11	Taper reamer up to 18 mm		1 set
2.12	Hand ratchet		2 nos.

LIFTING TOOL

3.01	Sling- 8 mm, 2.5 metre long tip to tip along with 150 mm eye at both end		1 pair
3.02	Sling 12 mm, eye at both end of 300 mm,	1.5 metre long	1 pair
		2.5 metre long	1 pair
		3.5 metre long	1 pair
3.03	Sling 19 mm, eye at both end of 450 mm,	2.0 metre long	1 pair
		3.0 metre long	1 pair
3.04	Sling 25 mm, eye at both end of 450 mm,	3.0 metre long	1 pair
		6.0 metre long	1 pair
3.05	Eye bolt 10, 12, 14 & 16		4 nos. each
3.06	Eye bolt 20, 24, 27, 36 & 42		2 nos. each
3.07	D-shackles pin dia. 10 mm, 12 mm		5 pairs each
	D-shackles pin dia. 20 mm, 25 mm, 32 mm, 36 mm & 44 mm		1 pair each
3.08	Ratchet hoist 0.5 T		1 no.
3.09	Chain block 2 T, 5 T		1 no. each
3.10	Manila rope 25 mm, 30 metre long		1 pair
3.11	Cotton rope 25 mm, 10 metre long		1 no.

OTHER T & P

4.01	Gas welding machine		1 set
4.02	Hand lamp with 30 metre cable		6 nos.
4.03	Switch board with 50 metre cord		2 nos.
4.04	Scissors-300 mm		1 set
4.05	Shim cutter – 350 mm		1 set
4.06	Magnifying glass – 75 mm dia		1 no.

4.07	Mirror with handle	1 no.
4.08	Vacuum cleaner	1 no.
4.09	Carpenter's saw	1 no.
4.10	Carpenter's chisel	3 nos.
4.11	Open "D" D.E. spanner 36X41, 41X46	2 nos. each
4.12	S.E. span "D" spanner 46, 50, 55, 65, 70, 75, 80, 85, 90, 95, 100, 105	1 no each
4.13	Slogging spanners 36, 41, 55, 65	2 nos. each
4.14	Slogging spanner 46 mm	4 nos.
4.15	Slogging spanners 50, 60, 70, 75, 80, 85, 90, 95, 100, 105	1 each
4.16	Box spanner set with straight handle, ratchet handle, universal extension piece – all heavy duty, up to 46 mm	1 set
4.17	Tubular spanner 20 to 46 mm	1 set
4.18	Allen key set 4 to 27	2 sets
4.19	Pipe wrench 150, 350 & 450 mm	1 no. each
4.20	Slide wrench 200 mm, 300 mm	2 nos. each
4.21	Spray gun for generator varnishing / painting with necessary high pressure hose	1 no.
4.22	High pressure air hose at least 30 metre long	1 no.
4.23	Tubular spanner	1 set
4.24	Gland packing remover	1 set

HAND TOOLS

5.01	Chisels (Chrome-Vanadium) 1 mm	6 nos.
5.02	Center punch (Chrome-Vanadium) small & big	1 each
5.03	Letter punch – 4 mm size	1 set
5.04	Number punch – 6 mm size	1 set
5.05	Bearing scrapper – half round and triangular	2 nos. each
5.06	Flat scrapper (made out of 1.5 inch power saw blades and pipes)	8 nos.
5.07	Hammer 250 gms., 500 gms.	1 no. each
5.08	Hammer 1 kg., 2 kg.	3 nos. each
5.09	Hammer 5 kg.	2 nos.
5.10	Hammer 8 kg.	1 no.
5.11	Copper Hammer 2 kg.	1` no.
5.12	Lead Hammer 2 kg.	1 no.
5.13	Nylon mallet	3 nos.
5.14	Needle file	2 sets
5.15	Assorted file	4 dozens
5.16	Screw driver 150 mm, 300 mm, 450 mm (Taparia make)	2 nos. each
5.17	Tommy bar 32 mm X 1 metre	1 no.
5.18	Crow bar – big and small	2 nos. each
5.19	Hole bar (Assorted size)	4 nos.
5.20	Hacksaw frame (good quality)	2 nos.
5.21	Pliers, cutting nose, grip, O/S circlip, I/S circlip	2 nos. each

5.22	Magnetic needle for dust in small holes	1 no.
5.23	Oil stone (rough and smooth)	6 nos. each
5.24	H.S.S. 12 mm square section X 100 mm parallel bits (accurate with 0.01 mm in section)	2 nos.
5.25	Copper rod 12 mm dia., 25 mm dia., 50 mm dia., 300 mm length	1 pc. Each
5.26	Bench vice 150 mm	2 nos.
5.27	Channel lock 150 mm	2 nos.
5.28	Vice grip 150 mm	1 no.
5.29	Cutogen gas cutting set with hose, jubilee clamps and regulators	1 set
5.30	Hydraulic jacks (50 tons capacity)	4 nos.
5.31	Welding generators (with lead holder)	1 no.
5.32	Brazing torch set	2 no.
5.33	Cutting nozzle no 19, 20	2 no each
5.34	Hydraulic jacks (25 tons and 100 tons capacity)	4 nos. each

The above list of T&P's are not exhaustive but indicative only .Any shortage may be made up by the vendor as may be required for overall job completion.

ANNEXURE – III

LIST OF CONSUMABLES TO BE ARRANGED BY THE CONTRACTOR IN ADDITION TO THE NORMAL CONSUMABLES.

The following consumable to be arranged by Vendor as per requirement.

1. Dye penetration test kit
2. Emery paper (fine and coarse)
3. Emery clothes sheets
4. Eutectic electrode L & T – 670/680
5. Nicro- 82 welding electrode & filler rod
6. All consumables as may be required for welding, brazing, gas cutting etc.
7. Petrol, Diesel
8. Rustolene, WD 40/ pen oil- 6030
9. 25 mm thick planks X 200mm wideX 3000 mm long for keeping dismantled parts
10. Ceramic cloth
11. Acetone
12. Stag B, Holdtite, M seals, Hylomar, Araldite, Silastic (RTV-732), tite seal, Teflon tape, medical tape, PVC tape, Klueber paste HEL 46-450, Tiodize T8E_H, Locktight-243, Lock tight 401/495, etc.

Any other consumables, supplementary requirement has to be provided by the vendor for successful completion of the job.

SPECIAL NOTE TO BIDDERS

01. **LUMPSUM PRICE:**
The bidders should quote lump sum price for the total scope of work mentioned in ANNEXURE– I Compliance to Annexure SAS – I is mandatory. If successful bidder fails for compliance of Annexure SAS I, then total expenditure towards the said items shall be deducted from the successful bidder's bill.
02. Successful bidder has to submit the following documents on and during execution of the job:
- Labour license for the subject work.
 - Insurance coverage of the total workers engaged for the job.
 - Monthly wage certificate of the total work force.
 - EPF for the workers engaged.
 - Submit safety plan.
 - Submit bar chart / job completion schedule as & when asked for.
 - No due certificate from Customer's personnel dept.
- Successful bidder has to obtain "No Objection Certificates" from concerned depts. and P&A dept. of customer.
- The scope under the specification (as per Annexure –I of scope of work) is not exhaustive but indicative only. However, any activity covered under the normal course of **works mentioned in Annexure-I** shall be deemed to be within the scope.
Transportation of materials, T & Ps including Special T & Ps, lifting tackles etc. from customer's site stores to work spot as per requirement along with material reconciliation and also transportation of the T&P's / Instruments etc. from BHEL-KOL HQ / OTHER Eastern Region Sites to site & back, is included in the scope of the vendor at their own cost. In case any part of the job is not carried out, a deduction will be effected as per percentage shown against those items.
03. Any related work not detailed under the above schedule of work but found essential for completion of the job has to be executed by vendor free of cost.
04. The vendor has to strictly comply with the SAFETY RULES & procedures of the customer. It is suggested that the prospective bidders may visit site to know further details of their safety rules before quoting their price.
05. Disposal of scrap/ waste/ insulation generated while overhauling work to be disposed off at predetermined place as indicated by customer by the bidder including transportation of the waste.
06. Defect liability period against bad workmanship shall be 6 (six) months from the date of commissioning/synchronization of the unit. During this period if any re work are required to be carried out, then the same are to be done by the successful bidder. The successful bidder shall be responsible for timely execution and quality of overhauling job and stand guarantee against any defect due to bad workmanship. Once defect is registered within defect liability period, the successful bidder has to rectify the same free of cost during next available opportunity.
07. **Security Deposit:** Vendor shall furnish security deposit as per clause no. 1.8 of GENERAL & SPECIAL CONDITIONS OF CONTRACT [FOR SERVICES JOB] and clause no (D) of SPECIFIC TERMS AND CONDITIONS FOR SERVICES JOBS. Security Deposit shall be released to vendor after successful completion of defect liability period of six (06) months and this shall be read in conjunction with clause no.1.8.9 of GENERAL & SPECIAL CONDITION OF CONTRACT [FOR SERVICE JOB].
08. **Terms of Payment:**
- 80% of the contract value plus BOCW cess (as applicable) but excluding the amount of GST shall be payable against submission of **progressive** running bills. Each of the billed amount shall correspond to the quantum of job actually completed and to that effect the claim can be preferred based on percentage allotments (to be given in the work order) made. This, however, has to be certified by the resident manager / engineer of the site.
 - 10% of contract value plus BOCW cess (as applicable) but excluding the amount of GST shall be payable on submission of statutory documents & 'no due certificate from customer's personnel department / receipt of final payment by BHEL from customer"

- c) Balance 10% of contract value plus BOCW cess (as applicable) but excluding the amount of GST shall be payable after completion of job / synchronization / commissioning of the unit (as applicable certified the resident manager / engineer of the site) and on receipt of final payment by BHEL from Customer & after confirmation of full GST Credit to BHEL. Any Interest if levied thereon for reasons elaborated in Tax clause of the tender which is not attributable to BHEL will be recovered for the Final Payment / Retention.
- d) Payment will be made within **45 days** after receiving of complete bill along with relevant documents

BHEL at its discretion may further split up the percentage break up given in billing schedule and effect payment to suit site condition, cash flow requirement etc. according to progress of work.

- e) Applicable GST shall be released to the vendor upon compliance of following: -
 - i. Vendor declaring such Invoice in his GSTR-1 and the same is available to BHEL in FORM GSTR-2A/2B.
 - ii. Material Receipt Certificate (MRC)/ Engineering Protocol
 - iii. Confirmation of payment of GST thereon by vendor on GSTN Portal
 - iv. Above is subject to receipt of goods / service and tax invoice thereof along with vendor declaring invoice in his return and paying GST within timeline prescribed for availing ITC by BHEL.

09. EXTRA WORK RATES CURRENTLY BEING ADMITTED BY BHEL, PS-ER [Page-10, SPECIFIC TERMS AND CONDITIONS FOR SERVICES JOBS] shall be read as below: -

EXTRA WORK RATES CURRENTLY BEING ADMITTED BY BHEL, PS-ER

MAN-HOUR RATE FOR ELIGIBLE EXTRA WORKS: Single composite average labour man-hour rate, including overtime if any, supervision, use of tools and tackles and other site expenses and incidentals, consumables for carrying out any major rework/ repairs/ rectification/ modification/ fabrication as certified by site as may arise during the course of erection, testing, commissioning or extra works arising out of transit, storage and erection damages, payment, if found due will be at Rs 108/- per man hour.

PRICE SCHEDULE (UNPRICED)

PLEASE REFER

E-PROCUREMENT PORTAL <https://eprocurebhel.co.in>

PRICE SCHEDULE

PLEASE REFER

E-PROCUREMENT PORTAL <https://eprocurebhel.co.in>

ANNEXURE-A

1.0	<u>Suspension of Business dealings with Suppliers/ Contractors</u>
1.1	BHEL reserves the right to take action against Suppliers/ Contractors who fail to perform or indulge in malpractices, by suspending business dealings with them.
1.2	<p>Suspension of business dealings with Suppliers/ Contractors could be in the form of following:</p> <p>a. Debarment within the unit for specific item(s)/ material category(ies)/ type of work(s) for six months.</p> <p>b. Debarment within the unit for all item(s)/ material category(ies)/ type of work(s) for one year.</p> <p>c. Debarment across BHEL for all items/ material category(ies)/ type of work(s) for two years.</p> <p>The Supplier may be debarred, as detailed hereinafter on the basis of one or more of the category wise reasons as enumerated hereunder:</p>
1.2.1	<p>Debarment within the unit for a specific item(s)/ material category(ies)/ type of work(s) shall be imposed for six months in the following cases, if</p> <p>i. In the last three consecutive supplies of a specific material category, average quality rating, as provided in the supplier performance rating (SPR) as per SEARP, falls below 80% of the quality weightage. This is irrespective of supplies against PO(s) having single/ multiple delivery schedules.</p> <p>Note: Not applicable in cases for erection works of Power Sector Regions, where separate guidelines for evaluation of capacity of bidders is being followed.</p> <p>ii. Two consecutive delays, for reasons of delay attributed to the Supplier, in execution of the contracts where delay occurred is such that</p> <p>a. prescribed maximum LD time limits of the contracts is exceeded or</p> <p>b. delay period has equaled/ exceeded half the original delivery period specified in the contracts</p> <p>whichever among the above is earlier.</p> <p>iii.</p> <p>a. Overall SPR (Supplier Performance Rating) in that particular Unit in line with SEARP falls below 60% of the specific material category.</p> <p>b. Bids of contractors (in PS-MSX portal) shall not be considered (if average score of last six months falls 60% or below as per guidelines for evaluation of capacity of bidders formula).</p> <p>Note: – for (b), No specific period of Debarment shall be applicable.</p> <p>iv.</p> <p>a. Supplier works are under strike/ lockout for a period of more than three months.</p> <p>b. Contractor has resorted to wanton stalling of work, strikes, picketing etc. during currency of the contract.</p>

1.2.2	<p>Debarment within the unit for all item(s)/ material category(ies)/ type of work(s) shall be imposed for One year in the following cases, if</p> <ul style="list-style-type: none"> i. Supplier tampers with tendering procedure affecting ordering process. ii. Supplier has misused BHEL documents/ drawings/ technical information or has breached the confidentiality agreement with BHEL. iii. after placement of order, Supplier fails to execute the contract. iv. within warranty period as per contract, Supplier continues to supply low/ less/ non-performing equipment/ services, repetitive failures, remains non-responsive. v. Wherever any part or full scope of supply/ work/ service has been awarded at the Risk and Cost of the defaulting vendor and the unexecuted value of scope for which the Risk and Cost action taken is more than 5% of the contract value. vi. After price bid opening but before placement of order, Supplier withdraws his offer or varies it in any manner within the validity period. vii. In spite of warnings, the Supplier persistently violates or circumvents the provisions of labour laws/ regulations/ rules or other statutory requirements. viii. Violation of Section 2, read with Section 3 of Integrity Pact, which are not covered in the list of defaults as per guidelines.
1.2.3	<p>Debarment across BHEL shall be imposed for two years in following cases, if</p> <ul style="list-style-type: none"> i. Supplier has made false declaration and/ or provided false information and/ or forged documents or has forged BHEL documents, certificates etc. for securing business, meeting PQR or for enlistment in BHEL or with other customers. ii. Supplier is found to be involved in cartel formation or in any other act so as to influence the bidding process or influence the price of the tender. iii. The Supplier has indulged in malpractices or misconduct such as bribery, corruption and fraud, pilferage, coercion, etc. iv. The Supplier is found guilty by any court of law for criminal activity/ offences involving moral turpitude in relation to business dealings. v. Supplier is found to have obtained any internal information/ documentation of BHEL by unauthorized means. vi. The foreign Principals along with the representing Agent shall be debarred together if information submitted jointly by them about their precise relationship, commission/ remuneration etc. payable/ receivable and other particulars as asked by BHEL, as per the extant guidelines regarding dealing with Agents of Foreign Suppliers is found false/ incorrect, at any stage. vii. Supplier has, damaged, failed to return free issue materials/tools etc. of BHEL, for which recovery could not be affected against such materials, or substituted free issue materials/ tools etc. of BHEL. viii. Supplier has been declared insolvent or is under dissolution/ insolvency proceedings so as to affect the execution of work. ix. The Supplier has tarnished/ maligned the image of BHEL or unfairly acted in a manner prejudicial to the commercial interest of BHEL or breached the confidentiality of the vital information with an intent to prejudice the interest of BHEL.
1.2.4	<p>A Supplier can also be debarred with the approval of Director (E, R&D) provided a direction to this effect has been received from the administrative ministry of the Government.</p>

Note: Above shall be applicable along with [Guidelines for “Suspension of Business dealings with Suppliers/ Contractors”](http://www.bhel.com) available in BHEL website <http://www.bhel.com>. These shall form part of tender documents.

ANNEXURE-B

Certificate by Chartered Accountant on letter head

This is to Certify that M/S ,
(hereinafter referred to as 'company') having its registered office at
.....
..... is registered under MSMED Act 2006, (Entrepreneur
Memorandum No (Part—II)/ Udyam Registration Certificate No.
..... dtd:
....., Category: (Micro/Small/Medium)). (Copy enclosed).

Further verified from the Books of Accounts that the investment of the company as per the latest audited financial year..... as per MSMED Act 2006 is as follows:

1. **For Manufacturing Enterprises:** Investment in plant and machinery (i.e. original cost excluding land and building and the items specified by the Ministry of Small Scale Industries vide its notification No. S.O.1722(E) dated October 5, 2006:
Rs Lacs
2. **For Service Enterprises:** Investment in equipment (original cost excluding land and building and furniture, fittings and other items not directly related to the service rendered or as may be notified under the **MSMED** Act, 2006:
Rs Lacs
3. **For Enterprises** (having EM-II Certificate/ valid NSIC Certificate or Udyog Aadhar Memorandum): Investment in plant and machinery or equipment is Rs..... Lacs and turnover is Rs. Lacs (as notified in MSME notification no. S.O. 2119 (E) dated 26.06.2020)
4. **For Enterprises** (Udyam registered under Udyam Registration Portal): Investment in plant and machinery or equipment is Rs..... Lacs and turnover is Rs. Lacs (as notified in MSME notification no. S.O. 2119 (E) dated 26.06.2020)

(Strike off whichever is not applicable)

The above investment of RsLacs is within permissible limit of RsLacs forMicro / Small/ Medium (*Strike off which is not applicable*) Category under MSMED Act 2006.

Or

The enterprise has been graduated upward from its original category (micro/small/medium) (*strike off which is not applicable*), the enterprise shall maintain its prevailing status till expiry of one year from the close of year of registration, as notified vide S.O. No. 2119 (E) dated 26.06.2020 & S.O. 2347 (E), dated 16.06.2021 published in the gazette notification dated 26.06.2020 & 16.06.2021 by Ministry of MSME.

Or

The enterprise has been reverse-graduated from its original category (micro/small/medium) (*strike off which is not applicable*), the enterprise will continue in its present category till the closure of the financial year and it will be given the benefit of the changed status only with effect from 1st April of the financial year following the year in which such change took place, as notified vide S.O. No. 2119 (E) dated 26.06.2020 & S.O. 2347 (E), dated 16.06.2021 published in the gazette notification dated 26.06.2020 & 16.06.2021 by Ministry of MSME.

Date:

(Signature)

Name:

Membership Number:

Seal of the Chartered Accountant

ANNEXURE-C

UNDERTAKING

(To be typed and submitted in the Letter Head of the Company/Firm of Bidder)

To,

(Write Name & Address of Officer of BHEL inviting the Tender)

Dear Sir/Madam,

Sub: DECLARATION REGARDING INSOLVENCY/ LIQUIDATION/ BANKRUPTCY PROCEEDINGS

Ref: NIT/Tender Specification No:

I/We,

_____ declare that, I/We am/are not under insolvency resolution process or liquidation / BIFR or Bankruptcy Code Proceedings (IBC) as on date, by NCLT or any adjudicating authority/authorities, which will render us ineligible for participation in this tender.

**Sign. of the Authorised Signatory
(With Name, Designation and Company seal)**

Place:

Date:

DECLARATION FOR RELATION IN BHEL

(To be typed and submitted in the Letter Head of the Company/Firm of Bidder failing which the offer of Bidder is liable to be summarily rejected)

To,

(Write Name & Address of Officer of BHEL inviting the Tender)

Dear Sir,

Sub: **Declaration for relation in BHEL**

Ref: 1) NIT/Tender Specification No:

I/We hereby submit the following information pertaining to relation/relatives of Proprieter/Partner(s)/Director(s) employed in BHEL.

Tick (√) any one as applicable:

1. The Proprietor, Partner(s), Director(s) of our Company/Firm DO NOT have any relation or relatives employed in BHEL

OR

2. The Proprietor, Partner(s), or Director(s) of our Company/Firm HAVE relation/relatives employed in BHEL and their particulars are as below:

(i)

(ii)

Signature of the Authorized Signatory

Note:

1. Attach separate sheet, if necessary.
2. If BHEL Management comes to know at a later date that the information furnished by the Bidder is false, BHEL reserves the right to take suitable against the Bidder/Contractor.

FORMAT FOR SEEKING CLARIFICATION

(To be typed and submitted in the Letter Head of the Company/Firm of Bidder)

To,

(Write Name & Address of Officer of BHEL inviting the Tender)

Dear Sir,

Sub: **Request for Clarification**

Ref: 1) NIT/Tender Specification No:,
2) All other pertinent issues till date

Sl No	Reference clause of Tender Document	Existing provision	Bidder's query	BHEL's clarification
1				
2				
3				

Yours faithfully,

(Signature, date & seal of Authorized Representative of the Bidder)

FORMAT FOR DETAILS OF BIDDER

NAME OF BIDDER	
ADDRESS OF BIDDER	
Company Registration Number*	
Name of Partners / Directors	
Bidder Type Indian/ Foreign*	
City*	
State*	
Country*	
Postal Code*	
PAN/TAN Number*	
Company's Establishment Year	
Company's Nature of Business*	
Company's Legal Status* {limited company/undertaking/joint venture/partnership/other}	
Company Category* {micro unit as per MSME/small unit as per MSME/medium unit as per MSME/ UAN as per Udyog Aadhaar Memorandum/ Udyam Registration No. / Ancillary unit/project affected person of this company/SSI/ other} Relevant documents to be submitted as applicable.	
Enter Company's Contact Person Details Title(Mr. / Mrs. / Ms. / Dr. / Shri)*	
Contact Name*	
Date Of Birth*	
Correspondence Email* (Correspondence Email ID can be same as your Login ID. All the mail correspondence will be sent only to the Correspondence Email ID.)	
Designation	
Phone*	
FAX NO.	
Mobile*	

Form-1 (Format for local content)

**DECLARATION REGARDING MINIMUM LOCAL CONTENT IN LINE WITH
REVISED PUBLIC PROCUREMENT (PREFERENCE TO MAKE IN INDIA), ORDER 2017
DATED 04TH JUNE, 2020 AND SUBSEQUENT ORDER(S)**

(To be typed and submitted in the Letter Head of the Entity/Firm providing certificate as applicable)

To,

(Write Name & Address of Officer of BHEL inviting the Tender)

Dear Sir,

Sub: Declaration reg. minimum local content in line with Public Procurement (Preference to Make in India), Order 2017-Revision, dated 04th June, 2020 and subsequent order(s).

Ref.: 1) NIT/Tender Specification No:,
2) All other pertinent issues till date

We hereby certify that the items/works/services offered by.....
(Specify the name of the organization here) has a local content of _____ % and this meets the local content requirement for '**Class-I local supplier**' / '**Class II local supplier**' ** as defined in Public Procurement (Preference to Make in India), Order 2017-Revision dated 04.06.2020 issued by DPIIT and subsequent order(s).

The details of the location(s) at which the local value addition is made are as follows:

- | | |
|----------|----------|
| 1. _____ | 2. _____ |
| 3. _____ | 4. _____ |

...
...
...

Thanking you,
Yours faithfully,

(Signature, Date & Seal of Authorized Signatory of the Bidder)

**** Strike out whichever is not applicable.**

Note:

1. Bidders to note that above format Duly filled & signed by authorized signatory, shall be submitted along with the techno-commercial offer.
2. In case the bidder's quoted value is in excess of Rs. 10 crores, the authorized signatory for this declaration shall necessarily be the statutory auditor or cost auditor of the company (in the case of companies) or a practising cost accountant or practicing chartered accountant (in respect of suppliers other than companies).
3. In the event of false declaration, actions as per the above order and as per BHEL Guidelines shall be initiated against the bidder.

FORM – 2

**DECLARATION REGARDING COMPLIANCE TO RESTRICTIONS UNDER RULE 144 (xi) OF
GFR 2017**

(To be submitted in the bidder's letter head)

To,

(Write Name & Address of Officer of BHEL inviting the Tender)

Dear Sir,

Sub: Declaration regarding compliance to Restrictions under Rule 144 (xi) of GFR 2017

Ref: 1) NIT/Tender Specification No:,
2) All other pertinent issues till date

I have read the clause regarding restrictions on procurement from a bidder of a country which shares a land border with India and on sub-contracting to contractors from such countries. I certify that _____ *(specify the name of the organization here)*, is not from such a country / has been registered with the Competent Authority** *(attach valid registration by the Competent Authority, i.e., the Registration Committee constituted by the Dept. for Promotion of Industry and Internal Trade (DPIIT))*; and will not sub-contract any work to a contractor from such countries unless such contractor is registered with the Competent Authority. *(attach relevant valid registration, if applicable)*

I hereby certify that we fulfil all requirements in this regard and is eligible to be considered.

Thanking you,
Yours faithfully,

(Signature, Date & Seal of Authorized Signatory of the Bidder)

**** Strike out whichever is not applicable.**

Note: Bidders to note that in case above certification given by a bidder, whose bid is accepted, is found to be false, then this would be a ground for immediate termination and for taking further action in accordance with law and as per BHEL guidelines.



HSEP14

Health, Safety & Environment Plan for Site Operations by Subcontractors

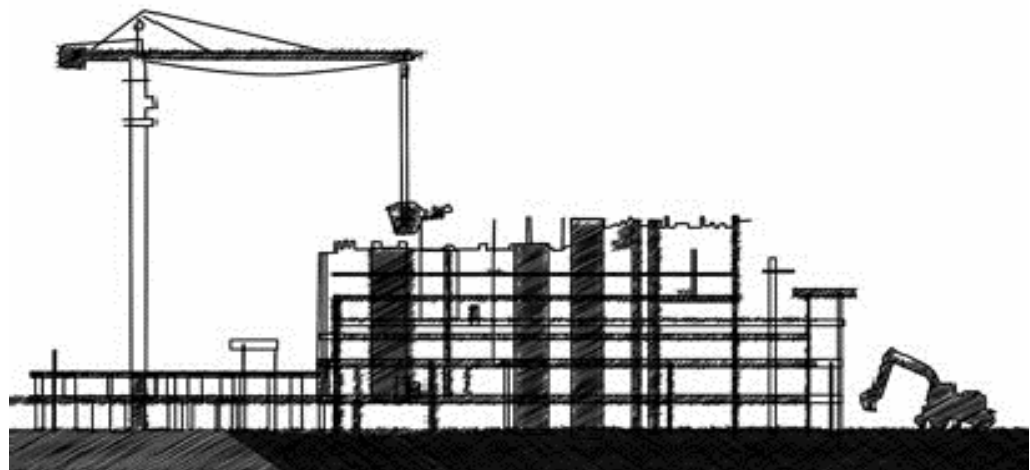

INDEX OF CONTENTS

SN	Description	Page No.
SECTION A: CRITICAL RESOURCES FOR HSE IMPLEMENTATION		
1	SHARING OF OPERATING COSTS OF FACILITIES	5
2	RESOURCES TO BE SOLELY PROVIDED BY CONCERNED SUBCONTRACTOR	5
3	ESTABLISHMENT OF COMMON FACILITIES	5
4	CRITICAL REQUIREMENTS W.R.T. EQUIPMENT & PPES	6
5	HSE PERSONNEL TO BE SOLELY PROVIDED BY THE SUBCONTRACTOR	8
6	COMPETENCY OF OPERATORS/ DRIVERS OF CRANE, WINCH, LIFTING/ CONSTRUCTION EQUIPMENT ETC.	11
7	STRINGENT REQUIREMENT OF BHEL'S CUSTOMER	11
8	REFERENCES	11
9	BHEL POWER SECTOR HSE MANAGEMENT SYSTEM	12
10	CLEARANCE OF MONTHLY RUNNING BILLS SUBJECT TO SAFETY COMPLIANCE	13
11	HSE PERFORMANCE EVALUATION	13
12	HSE PENALTIES	13
13	PUNITIVE ACTIONS ON WORKERS FOR CRITICAL SAFETY VIOLATIONS	16
14	LEGAL IMPLICATIONS	17
15	HSE REVIEW MEETING	17
16	OTHER REQUIREMENTS	18
17	MEMORANDUM OF UNDERSTANDING	19
SECTION B: OPERATIONAL REQUIREMENTS		
1	PURPOSE	22
2	SCOPE	22
3	OBJECTIVES AND TARGETS	22
4	BHEL HEALTH, SAFETY & ENVIRONMENT POLICY	23
5	ILLUSTRATIVE HSE RESPONSIBILITIES OF VARIOUS SUBCONTRACTOR OFFICIALS	24
6	HSE PLANNING BY SUBCONTRACTOR	27
7	MOBILIZATION OF MACHINERY/EQUIPMENT/TOOLS BY SUBCONTRACTOR	28
8	MOBILIZATION OF MANPOWER BY SUBCONTRACTOR	28
9	PROVISION OF PERSONAL PROTECTIVE EQUIPMENT (PPES)	29
10	ARRANGEMENT OF INFRASTRUCTURE	31
11	HSE TRAINING & AWARENESS	35
12	HSE COMMUNICATION AND PARTICIPATION	39
13	SAFETY DURING WORK EXECUTION	

14	ENVIRONMENTAL CONTROL & SOCIAL RESPONSIBILITY	43
15	HOUSEKEEPING	44
16	WASTE MANAGEMENT	44
17	TRAFFIC MANAGEMENT SYSTEM	45
18	EMERGENCY PREPAREDNESS AND RESPONSE	48
19	HSE INSPECTION	49
20	TERMS AND DEFINITIONS	52
	ANNEXURES	
A	ANNEXURE A: Specification of Ambulance	
A.1	ANNEXURE A.1: Typical calculation for sharing of operational cost of common facilities	
B	ANNEXURE B: Specifications of HSE Displays	
C	ANNEXURE C: HSE Tools, Equipment and Devices to be Provided by the Subcontractor	
D	ANNEXURE D: Specifications of Rest Sheds	
E	ANNEXURE E: Minimum Requirements of Labor Accommodation/ Colony	
F	ANNEXURE F: Specifications & Availability for Toilets at Site	
G	ANNEXURE G: Specifications for Numbers and Types of Fire Extinguishers	
H	ANNEXURE H: HSE Compliance Certificate Sample	
I	ANNEXURE I: Detailed Safety Requirements/ Precautions for Various Hazardous Activities/ Conditions	
J	ANNEXURE J: Details & Contents of First-Aid Box	
K	ANNEXURE K: Vertigo Test Procedure	

SECTION A

CRITICAL RESOURCES FOR HSE IMPLEMENTATION

1. SHARING OF OPERATING COSTS OF FACILITIES

TABLE A.1

SN	FACILITY
1	Ambulance with 24 hr. First Aid Trained Driver (Specs in Annexure A)
2	Operation of Medical center, Nurses, Medical Consumables etc. (Specs in Annexure A)
3	Training Center Consumables
4	Water sprinkling for dust suppression
	(Others:)

Note:

- i. Responsibility of operation of above facilities shall rest with BHEL
- ii. Operating cost of the above shall be deducted from subcontractors on 'proportional to contract' value basis. Sample deduction table enclosed as Annexure A.1
- iii. "Contract value" defined above & subsequently in the document shall be considered as "Awarded contract value".
- iv. No overhead cost/ enabling cost of BHEL shall be levied on the contractors for common facilities.
- v. These running costs shall be recovered from all the available subcontractors at site for the complete operational duration of the site
- vi. No overheads shall be charged on shared operating costs

2. RESOURCES TO BE PROVIDED SOLELY BY THE SUBCONTRACTOR

TABLE A.2

SN	ITEM	SPECIFICATIONS
1.	HSE DISPLAYS, Posters and signage	Annexure B
2.	HSE Tools/ Equipment/ Devices	Annexure C
3.	Rest Sheds for Workers	Annexure D
4.	Labor Colony	Annexure E
5.	Toilets (Latrines & Urinals) - in Site and Labor Colony	Annexure F
6.	Fire Extinguishers	Annexure G

Note:

In case subcontractor fails to provide the required resources, same will be procured and deployed by BHEL with applicable overhead on total procurement cost

3. ESTABLISHMENT OF COMMON FACILITIES

In green field projects BHEL shall arrange and provide the following facilities which shall be used by all subcontractors for their employees and workers. These shall be

- i. Medical Centre
- ii. Safety park with facilities of audio-visual training & vertigo test center.
- iii. No cost shall be deducted from the subcontractors for the structure part only.
- iv. The running cost with basic inputs already mentioned at Point 1 above shall be shared by all contractors.
- v. The sub-contractors shall be required to ensure participation in trainings, medical checkup and vertigo test as per the guidelines laid in this document and required as per statutory HSE requirements.

- vi. However, in projects where in these facilities are not provided by BHEL, subcontractors shall ensure the training, medical/ vertigo test of all workers at site in consultation and guidance of BHEL HSE team at site in line with provisions of this document.
- vii. The overall onus of compliance to HSE practices pertaining to training, medical checkup including vertigo test shall lie on the subcontractor only.

4. CRITICAL REQUIREMENTS W.R.T. EQUIPMENT & PPES

- i. Conventional Hydra crane with carriage in front shall not be permitted. Pick & carry tyre mounted Front Cabin mobile crane (FX or TRX/ NextGen series of 'ESCORT' or equivalent make) shall only be permitted.
- ii. Any Heavy equipment (cranes, winch machines, etc.) shall be deployed only after pre-safety Inspection by safety dept. Valid AMCs/ Fitness/ other statutory clearances as per local rules shall be required to be submitted before mobilizing the equipment at site.
- iii. All other Hand tools and power tools should not be older than 5 years.
- iv. For Chimney passenger lift, winch to have double drum rope for passenger and double safety devices must be used. Winch should not more than 3 years old and winch rope must be inspected with valid certificate from competent authority within 6 months and should meet the IS standard 9507 provision of OLR and push back button arrangement or dead man switch.
- v. Gate pass for all the lifting T&Ps and construction machinery/ equipment shall be made after obtaining written acceptance (Pre-entry Safety Clearance) from BHEL Site Safety Department after physical verification and checking all requisite documents/ compliance to Safety norms
- vi. All motor vehicles should have valid registration certificate, insurance, Pollution under control (PUC) and fitness certificate as per Motor Vehicle Act 2020. The certificates should be pasted in the glass from inside.
- vii. PPEs shall be from reputed manufactures viz. 3M, Udyogi, Karam, Frontier, Freedom, Honeywell, Liberty, Bata, Nomex, Acme, Unicare, Life Gear or equivalent. In case Subcontractor recommends any other name the same can be approved at site level by the Construction manager & Site HSE
- viii. For height work, where fall could result in death or disability, a secondary means of fall protection (Safety Net, Retractable Fall Arrestor etc.) shall be mandatorily provided by the subcontractor, failing which, a penalty of INR 10000 per case will be imposed. In addition, there should be constant supervision for such critical height work. Any non-erection activities at height eg. Housekeeping etc. shall also fall under the category of height work
- ix. **Scaffold Tagging**

Scaffolds being erected, modified or dismantled must be tagged as suitable for use. Tagging shall be done with standard tag holder. Scaffolding tag should be certified by scaffolding inspector having valid certificate.

- **GREEN** scaffold tag- shall be fixed when scaffold is complete and safe for use, signed and dated by the scaffolding competent person daily.
- **RED** scaffold tag – to be fixed if scaffold is in some way defective and cannot be used or is still under erection.
- **YELLOW** scaffold tag – to be fixed if scaffold is in under construction/ maintenance.



FIG. A.4.1 SAMPLE SCAFFOLD TAGS AND TAG HOLDER

x. **T&P Color Coding:**

- a. Inspections and tests shall be documented by means of color coding which shall verify that inspections or testing are current and that all receptacles, portable Power tools, Lifting Tools & Tackles have been inspected and tested as required. The color codes used on the project shall be:

GREEN	BLUE	YELLOW	PURPLE
January	April	July	October
February	May	August	November
March	June	September	December

TABLE. A.4.2: T&P COLOR CODES

- b. The cycle of colors shall be Quarterly as a minimum or as decided by BHEL. The color code tape / Sticker shall be clearly visible to designate the period for which the inspections and tests were conducted.
- c. Following the initial inspection, the equipment must be color-coded quarterly as per color-coding instructions that will be issued by the subcontractor.
- d. Fire extinguisher with the current month color-coding inspection sticker must be provided and secured in the platform.
- e. All slings shall be regularly inspected in accordance with the requirement of the project for frequent and periodic inspections and discard immediately if they fail to meet the minimum requirements of the project.
- f. The Subcontractor’s HSE Officer shall ensure that all PPE is inspected prior to its issue. He is to ensure all subcontractor personnel are using safe and proper PPE equipment.

inspections on the PPE shall be carried out and personnel not adhering to those inspections shall be removed immediately from the site.

- g. A Ten (10) day interval period shall be given into each monthly color code change. During this Ten (10) day period either color shall be acceptable.

xi. **T&P Tagging:**

All deployed Wire Rope Slings, Chain Pulley Blocks, Hooks, slings etc. shall be Tagged using aluminum or any other metal tag with punching.

5. HSE PERSONNEL TO BE PROVIDED SOLELY BY THE SUBCONTRACTOR

5.1. NUMBERS OF HSE PERSONNEL (APPLICABLE FOR EACH WORK SHIFT)

Number of HSE Officers and Supervisors shall be in proportion to number of workers as per Table A.6 below

TABLE A.5

No. of Workers	No. of HSE Supervisors	No. of HSE Officers
Up to 100	1	1
101 to 250	2	1
251 to 500	4	1
501 to 1000	6	2
1000 to 2000	6+ One additional supervisor up to every additional 250 workers	3
2000-3000	10+ One additional supervisor up to every additional 250 workers	4
3000-4000	14+ One additional supervisor up to every additional 250 workers	5

5.1.1. DEPLOYMENT PLAN

- i. Above requirement is for every shift for each unit.
- ii. The dynamic deployment plan of Safety manpower at various locations containing names, areas, time periods, shifts etc. shall be submitted to BHEL for approval by subcontractor
- iii. BHEL may modify the deployment plan based on nature and volume of jobs, Risks and hazards associated etc.
- iv. For less than 20 workers HSE Officer is not mandatory. In case the number of workers exceed 20 for 3 consecutive months, HSE Officer is to be engaged. The HSE Officer shall be deployed for a minimum period of 6 months even if the number of workers fall below 20 in any month subsequent to deployment. If within that 6-month period, the number of workers is more than 20 for at least 3 months, the deployment duration of HSE Officer will extend further 6 months after completion of previous 6-month period.
- v. For Site Material Management/ Handling (Loading/ Unloading) contracts, 1 no. HSE Officer shall be required irrespective of the total manpower deployed.
- vi. HSE Officers/Supervisors of all the vendors may be required to report directly to BHEL HSE Officer at site & shall comprise as a total team for handling all HSE issues. However, each safety officer/ agency shall be individually responsible for the safe execution of work in their respective areas.

Bharat Heavy Electricals Limited, Power Sector

Regd. Office: BHEL House, Siri Fort, New Delhi-110049



5.2. QUALIFICATION & EXPERIENCE REQUIREMENTS OF HSE PERSONNEL

5.2.1. HSE OFFICER

First HSE Officer to be mandatorily as per Option I as under and shall be designated Senior HSE Officer. In case of non-availability of HSE Officers with Option I configuration, the subsequent HSE Officers can be as per Option II below with recorded reasons and approval of Site Construction Manager of BHEL. All these deviations should be reported to Region HSE and PSHQ HSE.

A. Option I

- i. possesses a recognized degree in any branch of engineering or technology or architecture and had a practical experience of working in a building or other construction work in a supervisory capacity for a period of not less than two years or possesses a recognized diploma in any branch of engineering or technology and has had practical experience of building or other construction work in a supervisory capacity for a period of not less than five years;
- ii. possesses a recognized degree or diploma in industrial safety with at least one paper in construction safety (as an elective subject/ part thereof);
- iii. has adequate knowledge of the language spoken by majority of building workers from the construction site in which he is to be appointed.

B. Option II:

Graduation Degree in Science with Physics & Chemistry and degree or diploma in Industrial Safety (All Degrees/ Diploma from any Indian institutes recognized by AICTE or State Council of Technical Education of any Indian State) with practical experience of working in a building, plant or other construction works (as HSE Officer, in line with Indian Factories Act, 1958 or BOCW Act, 1996) for a period of not less than five years

Note:

- i. HSE Officer as per Option II shall be valid only on availability of Senior HSE Officer as per Option I at site.
- ii. In case of resignation of the Senior HSE Officer, the same has to be replaced within 15 days else all subsequent HSE Officers as per Option II (in case of multiple HSE Officers with a single agency) shall not be considered as valid.
- iii. The penalty shall be deducted considering non-availability of any HSE Officer at site.

5.2.2. HSE SUPERVISOR: EITHER OF X OR Y BELOW

X. Recognized Degree in any branch of Engineering OR Diploma in any branch of engineering with at least one-year construction experience

OR

Y. A recognized graduation Degree in Science (with Physics & Chemistry) or a recognized diploma in Engg. or Tech.

Additional requirements for option (Y) above

Bharat Heavy Electricals Limited, Power Sector

Regd. Office: BHEL House, Siri Fort, New Delhi-110049



- i. Trained in fire-fighting as well as in safety / occupational health related subjects, with:
- ii. Minimum Two years of practical experience in construction work environment or in the field of safety and

Note:

- i. Option a above is by default, b is under special approval from Site HSE & Construction manager
- ii. In both cases the candidate should possess requisite skills to deal with construction & fire safety related day-to-day issues.

5.3. HSE IN-CHARGE

In case there is more than one HSE Officer with any subcontractor, one of them, who is senior most by experience & meets qualification as per option 1 as mentioned in clause 2.1 A above (in HSE discipline), may be designated as HSE In-charge who will be the nodal point of contact on HSE matters.

5.4. SUPPORTING STAFF TO HSE TEAM

- i. Supporting Staff shall include scaffolders, scaffolding inspectors, riggers, skilled and unskilled manpower
- ii. Subcontractor shall provide adequate number of workers as and when required, in order to attend and comply to Safety observations raised by BHEL/ Customer.

5.5. AVAILABILITY AND PENALTY FOR NON-DEPLOYMENT

- i. The subcontractor shall submit the certificates of qualification & experience of HSE manpower before deployment for BHEL to assess suitability as per requirement detailed in this document
- ii. In case of rejection, subcontractor shall arrange additional candidates and submit resume to BHEL. Penalties will be applicable during the period of non-deployment in such cases as well.
- iii. Subcontractor shall ensure physical availability of safety personnel at the place of specific work locations.
- iv. The Subcontractor shall deploy the HSE Officers as per the site's requirement. Non-deployment shall lead to stoppage of the work and final decision shall rest with Site HSE & Construction manager.
- v. The Subcontractor shall prepare an organization chart identifying the areas of operations, responsibilities and reporting structure of all safety personnel for each shift and submit the same to BHEL.
- vi. The subcontractor shall deploy sufficient HSE Officers, supervisors, as per numbers & qualifications mandated in this Section since mobilization of first batch of manpower and add more in proportion to the added strength in work force. Any delay in deployment will attract a penalty at following rates:

Non-deployment of HSE Officer –	Rs. 75,000 per man-month
Non-deployment of HSE Supervisor –	Rs. 50,000 per man-month

- vii. Penalty shall be collected for the period of non-availability of safety personnel after allowing a grace period of 15 days for finding a replacement. The same shall be deducted on pro-rata basis till the required manpower is deployed.
- viii. In case of abnormal delay & frequent rejections of candidates proposed by the subcontractor, BHEL shall exercise the right to deploy the safety manpower & deduct the amount from subcontractor's running bill with applicable overheads. In such cases also, the provision of logistics, transportation, food and other logistical support to the HSE personnel shall be in the scope of subcontractor in addition to the salary. After deployment of manpower by BHEL, the penalty for non-deployment specified above shall not be applicable.

6. COMPETENCY OF OPERATORS/ DRIVERS OF CRANE, WINCH, LIFTING/ CONSTRUCTION EQUIPMENT ETC.

- i. The Operators/ Drivers of crane, winch, construction/ lifting equipment etc. shall be experienced and have valid driving license for the class of vehicle / machinery as applicable (like Crane/ Forklift/ Rig, Construction equipment driving license etc.).
- ii. Minimum HMV driving license is required for all heavy equipment/ heavy vehicle (trailer/ Hyva /dumper /TM) operators at site.
- iii. The subcontractor shall certify competence of these persons in writing as and when they are posted at site.
- iv. Crane, Winch, Construction & lifting equipment operator should have certificate on subject course or experience certificate in employer letterhead.
- v. Where state is providing license for operating crane, tractor and other construction vehicles, same to be ensured.

Note: In case the statutory requirements i.e. State or Central Acts and / or Rules as applicable like the Building and Other Construction Workers' Regulation of Employment and Conditions of Service- Act,1996 or State Rules (wherever notified), the Factories Act, 1948 or Rules (wherever notified), etc. are more stringent than above, the same shall be followed.

7. In case of any stringent requirement of BHEL's customer over and above the specifications mentioned in current document, the same shall also be required to be complied at site by subcontractor.

8. REFERENCES

The Safety Rules for Construction & Erection as outlined hereunder, while setting out a broad parameter of safety norms, are not exhaustive. The subcontractor and his agencies are advised to refer to the following statutory provisions as amended from time to time for details and strict compliance therewith.

8.1. FOR GREENFIELD PROJECTS

- a) Building and Other Construction Workers (regulation of employment and conditions of service) Act, 1996 (briefly referred to as BOCW Act),
- b) Building and other construction workers (regulation of employment and conditions of service) Central Rules, 1998 (briefly referred to as BOCW Rules) as adopted by the various State Governments,

8.2. FOR EXPANSION, MODIFICATION, ALTERATION AND, OR CONSTRUCTION ACTIVITY WITHIN AN EXISTING PLANT OPERATING AS PER APPROVED SITE PLAN UNDER THE FACTORIES ACT

- a) Factories Act, 1948,
- b) Factories Rules, as adopted by the various State Governments
- c) BOCW Act
- d) BOCW Rules
- e) In case a new act/ statutory guideline/ modification/ consolidation of acts is implemented the same shall be required to be adhered by the subcontractor.
- f) The latest amendment of the above-mentioned acts/ rules shall be followed at site.

9. BHEL POWER SECTOR HSE MANAGEMENT SYSTEM

The Systems and procedures of BHEL Power Sector HSE Management System shall be implemented by the subcontractor, including:

- HSE PROCEDURE FOR REGISTER OF OHS HAZARDS AND RISKS
- HSE PROCEDURE FOR REGISTER OF ENVIRONMENTAL ASPECTS AND IMPACTS
- HSE PROCEDURE FOR REGISTER OF REGULATIONS
- HSE PROCEDURE FOR TRAINING AND AWARENESS
- HSE PROCEDURE FOR EMERGENCY PREPAREDNESS AND RESPONSE PLAN
- HSE PROCEDURE FOR PERMIT TO WORK
- HSE INSPECTION AND OTHER FORMATS

Note:

- i. BHEL reserves the right to revise/ update these systems and procedure as per requirement to address any changing HSE needs
- ii. BHEL will provide hard / soft copies of applicable HSE Procedures, Work Permits, Operational Control Procedures, Inspection/ Other Formats etc. that are necessary for ensuring safe work to the successful bidder at Site. It is the responsibility of the subcontractor to ensure availability of these documents before commencing work at site.
- iii. The subcontractor can get soft copies of these documents from respective Region SCT/ HSE for reference. The signed hard copies of the same shall not be required to be submitted along with tender document
- iv. Subcontractor shall use the Digital (Web & App-Based) HSE management Software Systems provided by BHEL whenever provided. In case not provided, hard copy systems will continue to be used. All information technology resources (Computers, mobile phones, mobile data, internet access etc.) for the use of such systems shall be ensured by the subcontractor.

10. CLEARANCE OF MONTHLY RUNNING BILLS SUBJECT TO SAFETY COMPLIANCE

- i. The monthly running Bills of the subcontractor shall be released subject to compliance to HSE requirements as per checklist in Annexure H
- ii. BHEL site HSE Head and Package In-charge shall be authorized to issue the clearance
- iii. Site Construction Manager of BHEL shall be the final authority on the matter.

11. HSE PERFORMANCE EVALUATION

- i. Subcontractor shall be assessed on monthly basis for HSE Compliance by BHEL Safety In-charge at site.
- ii. The HSE evaluation shall be based on HSE Performance Evaluation System of BHEL covering the contractual, statutory and regulatory requirements of HSE.
- iii. BHEL shall reserve the right to use these performance scores for evaluating bidder's capacity for future tenders
- iv. If safety record of the subcontractor in execution of the awarded job is to the satisfaction of safety department of BHEL, issue of an appropriate certificate to recognize the safety performance of the subcontractor may be considered by BHEL after completion of the job, provided the execution performance is satisfactory.

12. HSE PENALTIES

- i. Nonconformity of safety rules and safety appliances will be viewed seriously and BHEL has right to impose fines on the subcontractor for every instance of violation noticed.
- ii. As per contractual provision HSE penalties shall be imposed on subcontractors for non-compliance on HSE requirement as per following format.
- iii. Following are the applicable penalties for various Safety violations:

Sub: MEMO for Penalty for non-compliances in Safety

Following lapse (tick marked) was observed and penalty (in Rs.) is imposed as stated at the bottom of this memo. It is requested that such occurrences be please avoided in future.

S. No	Nature of Non - Compliance	Penalty (in INR)	Remarks
A. System Violations			
1	Working without valid Work Permit/ HIRA/ Method Statement / JSA	2000	Per case
2	Controls as per Work Permit/ HIRA/MS/JSA not ensured	2000	Per case
3	Reported Safety Violations Not Closed within Stipulated Time	1000-10000	Per case
4	Absence of required Subcontractor Officials (Site Head, HS Head) in Safety Reviews/Meetings	5000	Per case
5	Not providing required PPEs (Safety Harness, Lifeline, Safety Net, Fall arrestor, Safety Helmet, Gloves, Shoes etc.) for the work by subcontractor	2000	Per case
B. Competency/ Training/ Induction Violations			

1	Incompetent personnel deployed for specialized jobs like height work, hot work, rigging, vehicle operation etc. (without valid license/ certificate etc.)	3000	Per case
2	Work without induction training & medical check	2000	Per case
3	Height Work without Vertigo Test and height work training	2000	Per case
C. PPE Violations – Height Work			
1	Not wearing/ hooking Double Lanyard Safety Harness while working at height (> 1.2 meters) or not anchoring to lifeline	1000	Per case
2	Not Providing Lifeline for height work	3000	
3	Unsafe platforms – without Top, Mid Rails and Toe-Guards for Height Work	3000	
4	Not providing secondary means of fall protection for height work (Safety Nets, Retractable Fall Arrestors etc.)	3000	Per case
D. PPE Violations – General			
1	Not wearing safety helmet	1000	Per case
2	Wearing of helmets without chin straps	1000	Per case
3	Not Wearing safety shoes	500	Per case
4	Not wearing gloves	500	Per case
6	Not using grinding goggles/ face shield during grinding/ cutting	2000	Per case
E. Electrical Safety Violations			
1	Broken/ exposed wires/ cables	2000	Per case per day
2	Electrical plug not used for connection/ hand machines	1000	Per case per day
3	Not using proper ELCBs for electrical equipment	2000	Per case per day
4	Improper earthing of welding & Other electrical machines (Lack of double earthing, improper/ untested earth pit etc.)	2000	Per case per day
5	Not using 24 V supply for lighting in confined spaces	2000	Per case
6	Cables haphazard/ blocking way/ not organized properly	1000	Per case per day
F. Lifting & Rigging Violations			
1	Using Sling/ Chain Pulley Block and other Small T&Ps without proper, traceable Tag and Test Certificate	2000	Per T&P per day
2	Using damaged slings or not slinging properly	2000	Per T&P per day
3	Use of lifting equipment without having valid Test certificate	5000	Per equipment per seven days
4	Lifting hooks used without latches	2000	Per hook per day
5	Not effectively barricading area below lifting activity	5000	Per case
6	Using untrained/ unqualified rigger	5000	Per case
G. Housekeeping			
1	Non-removal of scrap from platforms	5000	Per Event Per location per 7 days
2	Not conducting scheduled housekeeping drives	5000	Per drive
H. Hot Work Safety Violations			
1	Gas cutting without flash back arrestor at both ends	5000	Per machine per incidence
2	Gas cutting at height without fire blanket	2000	Per event

3	Not keeping gas cylinders vertically	2000	Per event
4	Lifting cylinders without cage or rolling of cylinders	2000	Per incidence
5	Leakage in gas cylinder	2000	Per incidence
I. Vehicle Safety/ Operation			
1	Not having valid driving license for the type of vehicle/ T&P	2000	Per driver per incidence
2	Two-wheeler entry in construction area	2000	Per vehicle
3	Using Hydra for material movement at site in unsafe manner	2000	Per case
4	Using Two Hydra in Tandem for material movement without proper precautions as per OCP	2000	Per case
5	Vehicles, Hydras, Cranes, Dumpers and Earth Movers not having automatic back horns linked to gear	2000	Per Equipment per day
6	Not providing proper hard barricades around excavations/ unpermitted areas	5000	Per location per day
7	Not using guide rope while transporting material using Hydra or Cranes	2000	Per event
8	Over speeding	5000	Per case
9	Using Conventional Hydra crane	50000	Per day /crane
J. Accidents/ Incidents/ Near Misses			
1	Non-reporting of Near Miss/ Incident	20000	Per case
2	Major Accident – Worker unable to resume work within 48 hrs	100000	Per incident
3	Fatal Accident	500000	Per incident
K. Miscellaneous			
1.	Not providing the facility (drinking water, rest shed, labor colony etc. as per the specifications/ requirement)	5000	Per month per violation
2.	Not nominating the required number of workers for training as per plan	5000	Per incidence
3.	Lack of proper arrangement for disposal of sewage/ waste water/ effluents etc.	10000	Per incidence

Details (if any) related to non- compliance (Name of persons, Nature of deficiency, etc.):

Penalty Amount:

1. Rate as per above chart
2. No. of Persons/ machine/ event/ labor
3. No. of times the same error is repeated: Repetition factor
4. Total Penalty= 1. X 2. X 3. =

Witnessed by:

(Sub- Subcontractor representative)
 representative)

(BHEL

Signature

Name

Distribution: 1 Copy: to Sub- subcontractor Site In-charge,
1 Copy to Site Construction Manager (BHEL)
1 Copy to Site Finance

Note:

- i. In case the amount of penalty imposed by BHEL's Client on BHEL for Safety violation/ incident due to or in the area of the subcontractor is more than those indicated above, same shall be imposed back-to-back on the subcontractor. However, in case such an amount is less than the specified above, penalty amount indicated above shall be imposed on the subcontractor.
- ii. For same violation only one penalty (higher of the two mentioned below) shall be applicable
 - a. Penalty imposed by BHEL's Customer over BHEL.
 - b. Penalty as indicated in current document.
- iii. For repeated violation for the same equipment/ location, the penalty would be double of the previous penalty. Date of "Repeated violation" will be counted from subsequent days.
- iv. For repeated fatal incident in the same Unit incremental penalty shall be imposed: The subcontractor will pay 2 times the previously paid penalty in case there is repeated major/ fatal incident under the same subcontractor for the same package in the same unit.
- v. Any other non-conformity noticed not listed above will also be fined as deemed fit by BHEL. The decision of BHEL engineer is final on the above.
- vi. If principal customer/statutory and regulatory bodies impose some penalty on HSE due to the non-compliance of the subcontractor the same shall be passed on to them.
- vii. The penalty amount shall be recovered by BHEL Finance department from subcontractors from the RA/Final bill.

13. PUNITIVE ACTIONS FOR "CRITICAL SAFETY VIOLATIONS":**"Critical Safety Violations" include:**

- i. Not wearing required PPEs when provided and not following safe work procedure
- ii. Taking unnecessary risks especially in height work, hot work, radiation work, lifting activity
- iii. Coming to work under influence of sedatives like alcohol, drugs etc.
- iv. Coming to work without ID Card/ Gate Pass (if provided)
- v. Intimidating/ threatening at work
- vi. Using cell phones during height work, hot work, lifting activity, driving.

In case any worker carries out any of the critical safety violations as above, BHEL reserves the right to enforce punitive action in following manner:

First Offence:	1 Punch on Gate Pass/ Induction Card/ ID Card etc. and 1-hour HSE Training. With one day off from duty
Second Offence:	2 Punches and 2-hours HSE Training with one day off from duty

Third Offence:	3 Punches and the worker will be dismissed. Gate pass to be confiscated
-----------------------	---

In case any employee of subcontractor carries out any of the critical safety violations as above, subcontractor Site In-charge shall issue warning letter to concerned employee with copy to BHEL

Note:

- i. For above violations, guilt of the worker/ employee has to be established through appropriate evidences and records maintained.
- ii. If worker/ employee has not been given the required PPEs and safety equipment by the agency and/or not facilitated by the agency to follow safety rules, he/ she will not be considered liable but the agency will be penalized as per penalty provision in this document. In such cases, the subcontractor shall not pass the penalty over to the worker/ employee through wage deduction etc.
- iii. These critical safety violations and their consequences shall be shared with all workers and employees during induction and other training programs/ meetings, toolbox talks etc.
- iv. Gate Pass shall have provision of Tagging as indicated above
- v. The appellate authority (only for final dismissal) in this case shall be the BHEL Site In-charge whose decision shall be final on the matter and binding on all parties.

14. LEGAL IMPLICATIONS

Any legal Costs incurred by BHEL, on account of accidents taking place in the activities of the subcontractor, shall be debited to the subcontractor on actual cost basis.

For any accident occurring at site to any worker/ employee of the subcontractor leading to legal implications to BHEL Employee/ Management shall be safeguarded by BHEL legal department. All legal expenses incurred by BHEL on this account shall be recovered from the subcontractor. The accident also includes fire, loss of property or life at site.

15. HSE REVIEW MEETING

- i. Subcontractor Site In-charge and HSE In-charge shall attend the HSE Review Meeting as and when called by BHEL.

The indicative agenda points are given below:

- a) Implementation of earlier MOM points
- b) Compliance Status of HSE Observations
- c) Incidents & Near Misses, their Root Causes and Actions Taken
- d) HSE performance review
- e) HSE inspection findings
- f) HSE audit and CAPA
- g) HSE training
- h) Health check-up camp
- i) HSE planning for the erection and commissioning and installation activities in the coming month

- j) HSE reward and promotional activities
- ii. MOM on the discussion along with HSE observations will be circulated to the subcontractor for action.
- iii. The subcontractor shall close the observations to the satisfaction of BHEL within stipulated time frame

16. OTHER REQUIREMENTS

- i. If the subcontractor fails to improve the standards of safety in its operation to the satisfaction of BHEL after being given reasonable opportunity to do so and/or if the subcontractor fails to take appropriate safety precautions or to provide necessary safety devices and equipment or to carry out instruction regarding safety issued by BHEL, BHEL shall have the right to take corrective steps and the cost shall be debited to the subcontractor with applicable overheads.
- ii. If the subcontractor succeeds in carrying out its job in time without any fatal or disabling injury incident and without any damage to property BHEL may, at its sole discretion, favorably consider to reward the subcontractor suitably for the performance.
- iii. In case of any damage to property due to lapses by the subcontractor, BHEL shall have the right to recover the cost of such damages from the subcontractor after holding an appropriate enquiry.
- iv. The subcontractor shall take all measures at the sites of the work to protect all persons from incidents and shall be bound to bear the expenses of defense of every suit, action or other proceeding of law that may be brought by any persons for injury sustained or death owing to neglect of the above precautions and to pay any such persons such compensation or which may with the consent of the subcontractor be paid to compromise any claim by any such person, should such claim proceeding be filed against BHEL, the subcontractor hereby agrees to indemnify BHEL against the same.
- v. The subcontractor shall not employ men below the age of 18 years and women on the work of painting with products containing lead in any form. Wherever men above the age of 18 are employed on the work of lead painting, overalls shall be supplied by the subcontractor to the workmen and adequate facilities shall be provided to enable the working painters to wash during the cessation of work.
- vi. The subcontractor shall notify BHEL of his intention to bring to site any equipment or material which may create hazard.
- vii. BHEL shall have the right to prescribe the conditions under which such equipment or materials may be handled and the subcontractor shall adhere to such instructions.
- viii. BHEL may prohibit the use of any construction machinery, which according to the organization is unsafe. No claim for compensation due to such prohibition will be entertained by BHEL.

17. MEMORANDUM OF UNDERSTANDING:

After award of work, subcontractors are required to enter into a memorandum of understanding as given below:

Memorandum of Understanding

BHEL, Power Sector Region is committed to Health, Safety and Environment Policy (HSE Policy).

M/s.....do hereby also commit to comply with the same HSE Policy while executing the Contract Number _____

M/s.....have gone through and understood all the HSE requirements of the contract including HSE manpower, tools & equipment, systems & procedures, and agree to fulfill the same as a minimum. Any additional resources and support required for ensuring fulfillment of HSE Objectives shall be provided by subcontractor at no extra cost.

M/s..... agree that in case they fail to comply to the HSE requirements as stipulated in the contract, BHEL shall have the right to implement the same and the cost shall be recovered from the subcontractor with applicable overheads.

M/s..... shall ensure that safe work practices as per the HSE plan. Spirit and content therein shall be imbibed in all workers and supervisors for compliance.

In addition to this, M/s.....shall comply to all applicable statutory and regulatory requirements which are in force in the place of project and any special requirement specified in the contract document of the principal customer.

M/s.....shall co-operate in HSE audits/inspections conducted by BHEL /customer/ third party and ensure to close any non-conformity observed/reported within prescribed time limit.

M/s..... agree that the subcontractor shall seek HSE clearance as per BHEL format before each RA bill as mentioned in clause no. 9. The penalty amounts for not providing Safety manpower and various Safety violations have also been reviewed and agreed.

M/s..... agree to share the HSE Costs (running costs) of common facilities created by BHEL on proportional to contract value basis as calculated at Site by BHEL.

Signed by authorized representative of M/s -----

Name :

Place & Date:

SECTION B

OPERATIONAL REQUIREMENTS

1. PURPOSE:

- 1.1. The purpose of this HSE Plan is to provide for the systematic identification, evaluation, prevention and control of general workplace hazards, specific job hazards, potential hazards and environmental impacts that may arise from foreseeable conditions during installation and servicing of industrial projects and power plants.
- 1.2. This document shall be followed by BHEL's subcontractors at all installation and servicing sites. In case customer specific documents are to be implemented, this document will be followed in conjunction with customer specific documents in complementary manner.
- 1.3. Although every effort has been made to make the procedures and guidelines in line with statutory requirements, in case of any discrepancy wherein the relevant statutory guidelines supersedes this document, the same shall be followed.
- 1.4. In case there's any specific HSE requirement from BHEL's Client, not explicitly indicated in this document the same shall be required to be fulfilled as per the decision of BHEL Site construction manager.

2. SCOPE:

The document is applicable to BHEL's Subcontractors at all installation / servicing activities of BHEL Power Sector as per the relevant contractual obligations

3. OBJECTIVES AND TARGETS:

- i. To achieve "Zero Incident at Site"
- ii. 100% compliance to all legal/statutory requirements related to EHS.
- iii. 100% Health, Safety and Environmental Induction training attendance for all workers.
- iv. 100% High Risk activities to be carried out only after approved Method Statement, HIRA / Aspect-Impact / JSA / OCP and Permit to Work are implemented.
- v. 100% PPEs compliance in high and medium risk activities.
- vi. 100% incident reporting, recording and reviewing for corrective actions.
- vii. Regular Safety Reviews to assess HSE program compliance and closure of any recognized gaps to improve safety management and incident prevention
- viii. Prevent injury and ill health of all workers at site ('Workers' refers to all personnel including managerial, supervisory, professional, technical, clerical and other workers including contract laborers)
- ix. Prevent pollution to environment
- x. Ensure the Health and Safety of all persons at work site is not adversely affected by the work.
- xi. Ensure protection of environment of the work site.
- xii. Comply at all times with the relevant statutory and contractual HSE requirements.
- xiii. Provide trained, experienced and competent personnel. Ensure medically fit personnel only are engaged at work.
- xiv. Provide and maintain plant, places and systems of work that are safe and without risk to health and the environment.

- xv. Provide all personnel with adequate information, instruction, training and supervision on the safety aspect of their work.
- xvi. Effectively control, co-ordinate and monitor the activities of all personnel on the Project sites including subcontractors in respects of HSE.
- xvii. Establish effective communication on HSE matters with all relevant parties involved in the Project works.
- xviii. Ensure that all work planning considers all persons that may be affected by the work.
- xix. Ensure fitness testing of all T&Ps/Lifting appliances like cranes, chain pulley blocks etc. are to be certified by competent person.
- xx. Ensure timely provision of resources to facilitate effective implementation of HSE requirements.
- xxi. Ensure continual improvements in HSE performance.
- xxii. Ensure conservation of resources and reduction of wastage.
- xxiii. Capture the data of all incidents including near misses, process deviation etc. Investigate and analyze the same to find out the root cause.
- xxiv. Ensure timely implementation of correction, corrective action and preventive action.
The subcontractor shall also comply with HSE Targets stipulated by BHEL from time to time.

4. BHEL HEALTH, SAFETY & ENVIRONMENT POLICY:

In BHEL, Health, Safety and Environment (HSE) responsibilities are driven by our commitment to protect our employees and people we work with, community and environment. BHEL believes in zero tolerance for unsafe work/non-conformance to safety and in minimizing environmental footprint associated with all its business activities. We commit to continually improve our HSE performance by:

- ❖ Developing safety and sustainability culture through active leadership and by ensuring availability of required resources.
- ❖ Ensuring compliance with applicable legislation, regulations and BHEL systems.
- ❖ Taking up activities for conservation of resources and adopting sound waste management by following Reduce/Recycle/Reuse approach.
- ❖ Continually identifying, assessing and managing environmental impacts and Occupational Health & Safety risks of all activities, products and services adopting approach based on elimination/ substitution/reduction/control.
- ❖ Incorporating appropriate Occupational Health, Safety and Environment criteria into business decisions, design of products & systems and for selection of plants, technologies and services.
- ❖ Imparting appropriate structured training to all persons at workplace and promoting awareness amongst customers, subcontractors and suppliers on HSE issues.
- ❖ Reviewing periodically this policy and HSE Management Systems to ensure its relevance, appropriateness and effectiveness.
- ❖ Communicating this policy within BHEL and making it available to interested parties.

Chairman & Managing Director

Bharat Heavy Electricals Limited, Power Sector

Regd. Office: BHEL House, Siri Fort, New Delhi-110049



5. ILLUSTRATIVE RESPONSIBILITIES OF SUBCONTRACTOR EMPLOYEES

5.1 HSE - A LINE RESPONSIBILITY

- i. HSE is a "Line Responsibility".
- ii. The term "Line" includes management, Executives, Supervisors, Foremen, and Workers who are part of the workforce. Line is to be fully involved in HSE Planning & Implementation with the aid and advice of HSE organization.
- iii. "Line", having control of resources and manpower is responsible for overall implementation of HSE Systems and closure of HSE observations.

5.2 SITE IN -CHARGE:

- i. Shall sign Memorandum of Understanding (MoU)
- ii. Shall ensure availability of all necessary resources required for implementation of HSE at Site
- iii. Shall engage qualified HSE Officer(s) and supervisors (s)
- iv. Shall adhere to the rules and regulations mentioned in this code, practice very strictly in area of work in consultation with concerned engineer and the safety coordinator.
- v. Shall screen all workmen for health and competence requirement before engaging for the job and periodically thereafter as required.
- vi. Shall not engage any employee below 18 years.
- vii. Shall arrange for all necessary PPEs like safety helmets, belts, full body harness, shoes, face shield, hand gloves etc. before starting the job.
- viii. Shall ensure that all T&Ps engaged are tested for fitness and have valid certificates from competent person.
- ix. Shall ensure closure of all HSE non-conformities reported by BHEL or observed during internal inspection by providing appropriate resources in a timely manner.
- x. Shall ensure the implementation of provisions of applicable acts and rules pertaining to HSE.
- xi. Shall ensure availability of updated (Hazard Identification and Risk Assessment) Register for the area of activity
- xii. Shall ensure availability of Method Statements & Job Safety Analysis for all hazardous activities
- xiii. Shall ensure necessary controls to minimize risk in all applicable hazardous activities including Height Work, Hot Work, Lifting & Rigging, Confined Space, Maintenance, excavation, Radiography, Loading/ Unloading, Drilling/ Blasting etc.
- xiv. Shall ensure implementation of HSE requirements mentioned in this document and as specified in the BHEL HSE management System including training, inspection, awareness, reporting etc.
- xv. Shall ensure that person working above 2.0 meter should use Safety Harness tied to a life line/stable structure.
- xvi. Shall ensure a secondary means of fall protection (Safety Net, Retractable Fall Arrestor etc.) for preventing fall from height
- xvii. Shall ensure that materials are not thrown from height. Cautions to be exercised to prevent fall of material from height.

- xviii. Shall report all incidents (Fatal/Major/Minor/Near Miss) to the Site engineer /HSE officer of BHEL.
- xix. Shall ensure that Horseplay is strictly forbidden.
- xx. Shall ensure that adequate illumination is arranged during night work.
- xxi. Shall ensure that all personnel working under subcontractor are working safely and do not create any Hazard to self and to others.
- xxii. Shall ensure display of adequate signage/posters on HSE.
- xxiii. Shall ensure that mobile phone is not used by workers while working.
- xxiv. Shall ensure conductance of HSE audit, mock drill, medical camps, induction training and training on HSE at site.
- xxv. Shall ensure full co-operation during HSE audits.
- xxvi. Shall ensure submission of look-ahead plan for procurement of HSE equipment's and PPEs as per work schedule.
- xxvii. Shall ensure good housekeeping.
- xxviii. Shall ensure adequate valid fire extinguishers are provided at the work site.
- xxix. Shall ensure availability of sufficient number of toilets (preferably bio-toilets) /restrooms and adequate drinking water at work site and labor colony.
- xxx. Shall ensure adequate emergency preparedness.
- xxxi. Shall be member of site HSE committee and attend all meetings of the committee
- xxxii. Power source for hand lamps shall be maximum of 24 v.
- xxxiii. Temporary fencing should be done for open edges if Hand – railings and Toe-guards are not available
- xxxiv. To record all incidents including near miss and report to BHEL and to ensure analysis & corrective actions for the same
- xxxv. Shall conduct weekly Safety Walks in the work area and record the findings.
- xxxvi. Construction of Canteen at Site, Office Infrastructure: Printer, PC, Fire Extinguishers etc.
- xxxvii. Shall analysis HSE Performance regularly in work area and take steps to improve the same
- xxxviii. Shall ensure stoppage of work in case of unacceptable Safety hazards

5.3 HSE OFFICER:

- i. Carry out safety inspection of Work Area, Work Method, Men, Machine & Material, P&M and other tools and tackles.
- ii. Facilitate inclusion of safety elements into Work Method Statement and creation of Job Safety Analysis (JSA)
- iii. (HSE Head) To prepare deployment plan of HSE personnel for all shifts, so as to ensure constant supervision of all areas. The plan to be submitted to BHEL
- iv. Highlight the requirements of safety through Tool-box / other meetings.
- v. Help concerned HOS to prepare Job Specific instructions/ JSA for critical jobs.
- vi. Conduct investigation of all incident/dangerous occurrences & recommend appropriate safety measures.
- vii. Advice & co-ordinate for implementation of HSE Systems & Procedures.
- viii. To stop work in case of any critical safety violation until the violation is cleared
- ix. Convene HSE meeting & minute the proceeding for circulation & follow-up acti

- x. Plan procurement of PPE & Safety devices and inspect their healthiness.
- xi. Report to BHEL on all matters pertaining to status of safety and promotional program at site level.
- xii. Facilitate administration of First Aid
- xiii. Facilitate screening of workmen and safety induction.
- xiv. Conduct fire Drill and facilitate emergency preparedness
- xv. Design campaigns, competitions & other special emphasis programs to promote safety in the workplace.
- xvi. Apprise BHEL on safety related problems.
- xvii. Notify site personnel non-conformance to safety norms observed during site visits / site inspections.
- xviii. Recommend to Site In charge, immediate discontinuance of work until rectification, of such situations warranting immediate action in view of imminent danger to life or property or environment.
- xix. To decline acceptance of such PPE / safety equipment that do not conform to specified requirements.
- xx. Encourage raising Near Miss Report on safety along with, improvement initiatives on safety.
- xxi. Shall work as interface between various agencies such customer, package-in-charges, subcontractors on HSE matters.

5.4 HSE SUPERVISOR:

- i. All requirements as per 5.1
- ii. To monitor allotted area for Safety violations, take required action and inform the concerned Safety Supervisor / Officer
- iii. To assist HSE Officer

5.5 PACKAGE IN-CHARGES, ENGINEERS & ALL EMPLOYEES:

- i. To be aware of, get involved in and ensure implementation of all HSE related Systems and Procedures including but not limited to:
 - a. BHEL HSE Management System including HSE Procedures and OCPs, HIRA, JSA etc.
 - b. Work Permit System
 - c. Emergency Preparedness Response Plans
 - d. Contractual HSE requirements
 - e. Legal Requirements
 - f. Penalty System
 - g. Training requirements
- ii. To ensure that the persons engaged in respective area follow the safety rules like using appropriate PPEs.
- iii. To develop Method Statements and ensure availability of Job Safety Analysis for all activities in scope
- iv. To ensure that the reported HSE non-conformities in the work area are resolved immediately before resuming work
- v. To record all incidents including near miss and report to BHEL.

- vi. To adopt safe working practices at all times and act as role model for Safety
- vii. To take immediate corrective action actions in case any non-conformity is observed on product / process / system with respect to Occupational Health, Safety and Environment.
- viii. In case any particular activity / work has extremely high consequential risk or high environmental impact, same shall be brought to the notice of BHEL Package In-charge before starting the work.
- ix. To interfere/ stop work as & when identified unsafe.
- x. To maintain & promote improved level of house-keeping all the time at site.
- xi. To support/co-operate with audit team members as & when safety audits are carried out.
- xii. To involve in investigation, if any incident occurs in his work area.
- xiii. To participate in safety promotional programs
- xiv. To attend the safety committee meeting, if member/invitee
- xv. To ensure that only fit T&Ps and qualified persons are engaged for all activities.
- xvi. Shall ensure that person working above 2.0 meter should use Safety Harness tied to a life line/stable structure.
- xvii. Shall ensure that materials are not thrown from height. Cautions to be exercised to prevent fall of material from height.
- xviii. Shall ensure that all T&Ps engaged are tested for fitness and have valid certificates from competent authorities.

6. HSE PLANNING BY SUBCONTRACTOR:

6.1 HAZARD ANALYSIS & RISK ASSESSMENT (HIRA), METHOD STATEMENT (MS) & JOB SAFETY ANALYSIS (JSA):

- i. Subcontractor shall identify all OHS Hazards and Risks applicable to all activities in scope and plan & implement the required control measures. HIRA Register shall be maintained.
- ii. Subcontractor shall develop Method Statements & Job Safety Analysis documents for all hazardous activities in scope and ensure the required control measures. Job Safety Analysis is to be attached along with any Work Permit request

6.2 REGISTER OF REGULATIONS:

Subcontractor shall prepare a register of applicable rules and regulations in the scope and plan to ensure compliance.

HIRA Register, Method Statements, Job Safety Analysis and Register of Regulations are dynamic documents and shall be revised (as applicable):

- i. At fixed frequency of 3 months
- ii. Addition/ deletion/ modification of a process/ activity
- iii. After an accident/ incident
- iv. After any change in applicable rules/ regulations/ laws.

6.3 MONTHLY HSE PLAN COVERING THE FOLLOWING AS A MINIMUM SHALL BE PREPARED AND SUBMITTED TO BHEL FOR APPROVAL:

- i. HSE Trainings covering all activities/ hazards/ workers
- ii. HSE Inspection Plan covering all areas/ activities/ equipment/ hazards
- iii. HSE Activities: Safety walks, Awards, housekeeping, reviews etc.

Note: Online/ App-based system shall be used for HSE Planning and Implementation/ Update whenever provided by BHEL otherwise Hard-copy based system shall continue

6.4 MONTHLY HSE PLANNING & REVIEW OF HSE ACTIVITIES ALONG WITH BHEL:

Monthly planning and review of HSE activities shall be carried out by subcontractor as per provided **format** jointly along with BHEL

7. MOBILIZATION OF MACHINERY/EQUIPMENT/TOOLS BY SUBCONTRACTOR:

- i. Subcontractor shall notify the engineer, of his intention to bring on to site any equipment or any container, with liquid or gaseous fuel or other substance which may create a hazard. The Engineer shall have the right to prescribe the condition under which such equipment or container may be handled and used during the performance of the works and the subcontractor shall strictly adhere to such instructions. The Engineer shall have the right to inspect any construction tool and to forbid its use, if in his opinion it is unsafe. No claim due to such prohibition will be entertained.
- ii. As a measure to ensure that machinery, equipment and tools being mobilized to the construction site are fit for purpose and are maintained in safe operating condition and complies with legislative and owner requirement, inspection shall be arranged by in-house competent authority for acceptance as applicable. Inspection by Third Party competent person shall be arranged:
 - a. Before first time use at site
 - b. After carrying out any modification
 - c. After repairs subsequent to involvement in any accident/ incident
- iii. As a further measure to ensure that machinery, equipment and tools being mobilized to the construction site are fit for purpose and are maintained in safe operating condition and comply with legislative and owner requirement, inspection as per provided format shall be arranged by in-house expert / competent authority (preferable) for acceptance. The equipment considered for this purpose shall include all those in the T&P list in the tender document.

8. MOBILIZATION OF MANPOWER BY SUBCONTRACTOR:

- i. As a measure to ensure that manpower being mobilized to the construction site is fit and competent for safe working, screening arrangement shall be made by the sub-subcontractor to ensure competency and fitness through following measures:
 - a) **Medical Checkup:** Examination of medical fitness shall be conducted through qualified medical professional for all workers to be deployed as per provided **format**. For height workers, vertigo (height phobia) test to be carried out as qualification criteria as per Annexure K and recorded in provided **format**.

- b) **Induction Training:** Induction training of all workers to be ensured as per **provided procedure and format**. Training evaluation to be carried out and training to be repeated if not passed
- c) Only on successfully meeting above criteria, permanent gate passes to be issued
- ii. The subcontractor shall arrange induction and regular health check of their employees as per schedule VII of BOCW rules by a registered medical practitioner.
- iii. The subcontractor shall take special care of the employees affected with occupational diseases under rule 230 and schedule II of BOCW Rules. The employees not meeting the fitness requirement should not be engaged for such job.
- iv. Ensure that the regulatory requirements of excessive weight limit (to carry/lift/ move weights beyond prescribed limits) for male and female workers are complied with.
- v. Appropriate accommodation to be arranged for all workmen in hygienic condition.
- vi. Cost of contractual, statutory and regulatory requirements like Training, medical checks, PPEs etc. shall not be transferred to the workers and such activities shall be considered as part of the job.

9. PROVISION OF PERSONAL PROTECTIVE EQUIPMENT (PPEs):

- i. Personnel Protective Equipment (PPEs), shall be provided by the subcontractor to all workers as per requirement of the job.
- ii. The choice of PPEs to ensure multiple (at least more than 1) means of protection against any hazard. All applicable safety precautions for a job shall be ensured notwithstanding the duration or perceived importance of the task.
- iii. The applicability of PPEs shall be as per the concept of Hierarchy of controls, i.e.:
- iv. Elimination->Substitution->EngineeringControls->AdministrativeControls-PPEs
- v. Relying solely on PPEs without ensuring necessary controls to be strictly avoided.
- vi. The following matrix recommends usage of minimum PPEs against the respective job.

Activity	Type of Protection						Remarks, if any
	Hand	Eye	Ear	Body	Respiratory	Others	
Gas Welding & Cutting	LG	WG	-	LA	*SCBA/ OLBA	-	* for confined space
Electric Arc Welding	LG	HMWS	-	LA	*SCBA/ OLBA	-	* for confined space
Rigging	CG	SG	-				--
Working at Height	-	SG	-	DLFBH	-	*FAS	* for vertical columns
Grinding & Chipping	CG	FS / SG	-	LA	-	-	--
Working in High Noise	-	-	EP / EM	-	-	-	--
Handling of Cement Concrete	RG	SG	-	-	DM	-	

Blasting	CG	SG	EP*	-	-	-	* at noise area
Excavation	CG	SG	-	-	DM	-	*Gum boot in place of Safety shoe for foot
Chemical Handling	PVCG	CSG	-	PVCA	-	-	*Full body rubber suit with hood
Electrical and C&I	ERG*	SG	-	-	-	-	*For high voltages
Sand/shot blasting	CG	-	EP/ EM	CA	SAMH	-	

ABBREVIATIONS: FS: Face Shield, CSG: Chemical splash goggles, HMWS: Helmet mounted welder's shield, GB: gum boot, DLFBH: Double lanyard full body harness, SG: Safety goggles, DM: Dust mask, SAMH L Supplied air mask/hood, EP/EM: Ear plug/Ear Muff, CG: Cotton hand gloves, LG: Leather hand gloves, LA: Leather apron, RG: Rubber gloves, PVCG: PVC Gloves, PVCA: PVC Apron, SCBA: Self-contained breathing apparatus, WG: Welding goggles, ERG: Electrical Rubber Gloves. OLBA: Online breathing apparatus

The list is not exhaustive. Additional PPEs to ensure Safe Work may need to be deployed as per the requirement of the task at no additional cost.

- vii. The PPEs shall conform to the relevant standards as below (illustrative list) and bear ISI mark.

RELEVANT IS-CODES FOR PERSONAL PROTECTION

PPEs	IS Codes
Industrial Safety Helmets.	IS: 2925 – 1984
Rubber gloves for electrical purposes.	IS: 4770 – 1968
Industrial Safety Gloves (Leather & Cotton Gloves).	IS: 6994 – 1973 (Part-I)
Leather safety boots and shoes.	IS: 1989 – 1986 (Part-I-II)
Industrial and Safety rubber knee boots.	IS: 5557 – 1969
Code of practice for selections care and repair of Safety footwear.	IS: 6519 – 1971
Leather Safety footwear having direct molding sole.	IS: 11226 – 1985
Eye protectors.	IS: 5983 – 1978
Ear protectors.	IS: 9167 – 1979
Eye & Face protection during welding	IS: 1179-1967
Industrial Safety Belts and Harness	IS: 3521 – 1983
Guide for selection of industrial Safety equipment for body protection	IS:8519 -1977
Respiratory Protective Devices	IS:9473-2002,14166-1994,14746-1999

- viii. Where workers are employed in sewers and manholes, which are in use, the subcontractor shall ensure that the manhole covers are opened and ventilated at least for an hour before the workers are allowed to get into manhole, and the manholes so opened shall be cordoned off with suitable railing and provided with warning signals or boards to prevent incident to the public

Bharat Heavy Electricals Limited, Power Sector

Regd. Office: BHEL House, Siri Fort, New Delhi-110049



- ix. All the personnel and visitors shall mandatorily use safety helmet (with company logo), safety shoe and reflective vests, in addition to any other PPEs as deemed appropriate for the area of work/ visit.
- x. Following Color scheme for Helmets shall be followed:
 - a. Workmen: Yellow
 - b. Safety staff: Green or white with green band
 - c. Electrician: Red
 - d. Others including visitors: White
 - e. For height workers, special marking on helmets besides indication on Gate Pass/ ID Card
- xi. The subcontractor shall maintain register for issue and receipt of PPEs.
- xii. All the PPEs shall be checked for quality before issue and the same shall be periodically re-checked. The users shall be advised to check the PPEs themselves for any defect before putting on. The defective ones shall be replaced.
- xiii. The Helmets shall have logo or name (abbreviation of agency name permitted) affixed or printed on the front.
- xiv. The body harnesses shall be serial numbered.

10. ARRANGEMENT OF INFRASTRUCTURE:

10.1 DRINKING WATER:

- i. Drinking water shall be provided and maintained at suitable places at different elevations such that minimum quantity of 5 liters is available for each worker during the day.
- ii. Drinking water tank shall be so installed so as to be available within 200 meters of each working area
- iii. Container should be labeled as "Drinking Water" in languages understood by the workers
- iv. Cleaning of the container shall be ensured at least once in a week. Mild cleaning detergents as used for cleaning vessels shall be applied and scrubbers (3M or equivalent) shall be used for removing scales and deposits on the inside surface. The tank shall be thoroughly cleaned with potable water only before it is refilled (also applicable to labor colony).
- v. Suitability of water source for drinking to be tested as per IS10500 at least once in six months.

10.2 WASHING FACILITIES:

- i. In every workplace, adequate and suitable facilities for washing shall be provided and maintained.
- ii. Separate and adequate cleaning facilities shall be provided for the use of male and female workers. Such facilities shall be conveniently accessible and shall be kept in clean and hygienic condition and dully illuminated for night use.
- iii. Water suitable for washing and not for drinking shall be clearly indicated as "Not for Drinking" in language understood by workers.
- iv. Overalls shall be supplied by the subcontractor to the workmen and adequate facilities shall be provided to enable the painters and other workers to wash during the cessation of work.

10.3 LATRINES AND URINALS:

- i. Latrines and urinals shall be provided in every work place as indicated in Section A
- ii. Urinals shall also be provided at different elevations.
- iii. They shall be adequately lighted and shall be maintained in a clean and sanitary condition at all times, by appointing designated person.
- iv. Separate facilities shall be provided for the use of male and female worker if any.

10.4 PROVISION OF REST SHEDS FOR WORKERS DURING REST PERIOD:

Proper Rest Shed (s) with shelter shall be provided for rest during break so as to accommodate all workers as indicated in Section A

10.5 MEDICAL FACILITIES:

10.5.1 GENERAL

- i. Provision of Medical Center, Ambulance etc. shall be as per Section A of this document
- ii. Medical waste shall be disposed as per prevailing legislation (Bio-Medical Waste – Management and Handling Rules, 1998)
- iii. Every injury shall be treated, recorded and reported.
- iv. All First Aid injuries shall be recorded as per provided Format
- v. List of qualified first aiders and their contact numbers to be displayed at conspicuous places.

10.5.2 FIRST AIDER/ FIRST AID BOX

- i. The first aider along with facilities should be available at a point nearest to the work location wherein majority of the workers are working.
- ii. The subcontractor shall provide necessary first aid facilities as per schedule III of BOCW. At every work place first aid facilities shall be provided and maintained.
- iii. The first aid box shall be kept by first aider who shall always be readily available during the working hours of the work place. His name and contact no to be displayed on the box.
- iv. The first aid boxes should be placed at various elevations so as to make them available within the reach and at the quickest possible time.
- v. The first aid box shall be distinctly marked with a Green Cross on white background.
- vi. Details of contents of first aid box is given in Annexure J
- vii. A slip of contents shall be pasted on the First Aid Box with following details
- viii. Monthly inspection of First Aid Box shall be carried out by the owner as per provided format
- ix. The subcontractor should conduct periodical first –aid classes to keep his supervisor and Engineers properly trained for attending to any emergency.

10.5.3 HEALTH CHECK UP

The persons engaged at the site shall undergo health check-up as per provided format before induction. In addition, the persons engaged in the following works shall undergo health check-up at least once in a year:

- i. Height workers
- ii. Drivers/crane operators/riggers
- iii. Confined space workers
- iv. Shot/sand blaster
- v. Welding and NDE personnel

10.5.4 HEIGHT PHOBIA/ VERTIGO TEST:

- i. The persons engaged in working at heights (above 2 meters) to be assessed for Vertigo and associated conditions and recorded as per provided format. Suggested Vertigo Test Procedure is given in Annexure K
- ii. Such workers are to be allowed only on successful completion of test, otherwise shall be allocated ground-based jobs.
- iii. IDs / Height passes shall be issued to such workers, besides special markings on helmets for easy identification.

10.5.5 PROVISION OF CANTEEN FACILITY:

- i. Canteen facilities shall be provided for the workmen of the project inside the project site where worker strength is 250 or more.
- ii. Proper cleaning and hygienic condition shall be maintained.
- iii. Proper care should be taken to prevent biological contamination.
- iv. Adequate drinking water should be available at canteen.
- v. Fire extinguisher shall be provided inside canteen.
- vi. Regular health check-up and medication to the canteen workers shall be ensured as per applicable regulations.
- vii. Canteen waste to be disposed of in hygienic manner

10.6 PROVISION OF ACCOMMODATION/LABOR COLONY FOR WORKFORCE:

- i. Proper accommodation for workforce to be provided in line with minimum requirements indicated in Section A
- ii. Labor colony shall be inspected each week by HSE Officer and report submitted to BHEL as per provided format

10.7 PEST CONTROL:

Regular pest control should be carried out at all offices, mainly laboratories, canteen, labor colony and stores.

10.8 SCRAPYARD:

- i. In consultation with customer, scrapyard shall be developed to store metal scrap, wooden scrap, waste, hazardous waste.
- ii. Scrap/Waste shall be segregated as Bio-degradable and non-bio-degradable and stored separately.

10.9 ILLUMINATION:

- i. The subcontractor shall arrange at his cost adequate lighting facilities e.g. flood lighting, hand lamps, area lighting etc. at various levels for safe and proper working operations at dark places and during night hours at the work spot as well as at the pre-assembly area.
- ii. Lamp (hand held) shall not be powered by mains supply but either by 24V or dry cells.
- iii. Lamps shall be protected by suitable guards where necessary to prevent danger, in case of breakage of lamp.
- iv. Emergency lighting provision for night work shall be made to minimize danger in case of main supply failure.
- v. Adequate and suitable light shall be provided at all work places & their approaches including passage ways as per IS: 3646 (Part-II).

SUITABLE ILLUMINATION LEVELS FOR VARIOUS AREAS SHALL BE DECIDED BASED ON BROAD GUIDELINES INDICATED BELOW:

S. No.	Location	Lux Level (lumens/sqm)
A. Construction Site		
1	Outdoor areas like store yards, entrance and exit roads	20
2	Platforms	50
3	Entrances, corridors and stairs	100
4	General illumination of work area	150
5	Rough work like fabrication, assembly of major items	150
6	Medium work like assembly of small machined parts	300
7	Fine work like precision assembly, precision measurements etc.	700
8	Sheet metal works	200
9	Electrical and instrument labs	450
B. Office		
1	Outdoor area like entrance and exit roads	20
2	Entrance halls	150
3	Corridors and lift cars	70
4	Lift landing	150
5	Stairs	100
6	Office rooms, conference rooms, library reading tables	300
7	Drawing table	450
8	Manual telephone exchange	200

- vi. Illuminations shall be inspected on weekly basis as per provided **format** using a calibrated lux meter.

11. HSE TRAINING & AWARENESS:

11.1 TRAINING PLAN:

- i. All training programs to be carried out in a planned manner. Monthly/ Annual Training Calendar to be submitted to BHEL for approval and shall cover HSE Training requirements of all activities, workers, hazards applicable to the area(s) of work.
- ii. Subcontractor shall nominate workers as per the schedule of specific training plan, failing which, penalty shall be imposed.
- iii. Training records of all workers along with attendance, signatures, faculty details etc. shall be maintained in soft/ hard copy as per provided **formats**.
- iv. Each labor should undergo at least 0.5% of total man-hours worked in HSE training.

11.2 HSE INDUCTION TRAINING

- i. All persons entering into project site shall be given HSE induction training by the HSE officer of BHEL /subcontractor before being assigned to work.
- ii. The induction training shall be imparted through audio-visual medium (Classroom specialized training), and shall be minimum of 1 Complete Day.
- iii. Evaluation to be carried out after training and training shall be repeated in case of failure.
- iv. Safety Induction Card shall be printed by Subcontractor and provided to all trained workers. A Safety induction book shall also be printed and issued to each worker after induction training (Format for the same may be provided by BHEL).
- v. Induction training subjects shall include but not limited to:
 - a. Briefing of the Project details.
 - b. Safety objectives and targets.
 - c. Site HSE rules.
 - d. Critical Safety Violations and consequences
 - e. Site HSE hazards and aspects.
 - f. First aid facility.
 - g. Emergency Contact No.
 - h. Incident & Near Miss reporting.
 - i. Fire prevention and emergency response.
 - j. Rules to be followed in the labor colony (if applicable)
 - k. Accident case studies
- vi. General:
 - a. Proper safety wear & gear must be issued to all the workers being registered for the induction (i.e., Shoes/Helmets/Goggles/Leg guard/Apron etc.)
 - b. They must arrive fully dressed in safety wear & gear to attend the induction.
 - c. Any one failing to conform to this safety wear& gear requirement shall not qualify to attend.

- d. On completing attending subcontractor's in-house HSE induction, each employee shall sign an induction training form to declare that he had understood the content and shall abide to follow and comply with safe work practices.
- e. They may only then be qualified to be issued with a personal I.D. card, for access to the work site subject to clearing the medical fitness test.

SAFETY INDUCTED	
Name :	
Date :	
Sign By Trainer :	

ABOVE STICKER SHALL BE PASTED ON HELMET OF WORKERS AFTER SAFETY INDUCTION TRAINING

11.3 JOB-SPECIFIC SKILL BASED HSE TRAINING

The contracting agency shall also impart job specific skill-based safety training to all its employees (Minimum one day) on various related safety topics using internal/external safety professionals/consultants as per the matrix given below. Record of such trainings and attendance particulars shall be maintained in a register for ready reference to statutory authorities/engineer-in charge as per provided format.

TRAINING MATRIX

Name of topic	Executives	Supervisors	Skilled Workmen	Other Workers
Safety Induction	Y	Y	Y	Y
Accident_ Causes, factors, cost	Y	Y	Y	-
Industrial hazards & Accident Prevention	Y	Y	Y	-
Investigating, reporting, records	Y	Y	-	-
Personal Protective Equipment	-	Y	Y	Y
Construction Safety & Role of Supervisory personnel	-	Y	-	-
Permit to Work (PTW)	-	Y	Y	y
Statutory Provisions (BOCW Act/Rules, Factories Act 1948 etc.)	Y	Y	y	y
Material handling	-	y	Y	Y
Emergency Management	Y	Y	Y	-
Electrical Safety	-	Y	Y	-
Fire safety	Y	Y	Y	Y
First Aid & CPR (cardio pulmonary resuscitation)	-	Y	Y	Y (Selected)
Safety in Welding & Cutting	-	-	Y	-
Safety Audit	Y	Y	-	-
Safety in Lifting Tools & Tackles	-	Y	Y	y

Safety in Working at height	-	Y	Y	Y
Safety in Confined space work	-	Y	Y	Y
Defensive Driving	-	Y*	Y*	Y*

*for construction vehicle operators, helpers & crane operators

Y=YES

Note:

- i. Subcontractor shall prepare a training plan/ matrix covering all hazards and implement the same after approval of BHEL.
- ii. It is to be ensured that every worker undergoes Job-Specific training once every 3 months.
- iii. Records of training programmes along with attendance shall be maintained by the subcontractor
- iv. Each worker to be issued a Card indicating the types of trainings undergone.

11.4 HSE TOOL-BOX TALK:

- i. HSE tool Box talk shall be conducted by frontline foreman/supervisor of subcontractor to specific work groups prior to the start of work and shall be randomly attended by subcontractor engineers/ officials. The agenda shall consist of the following:
 - a. Details of the job being intended for immediate execution.
 - b. The relevant hazards and risks involved in executing the job and their control and mitigating measures.
 - c. Specific site condition to be considered while executing the job like high temperature, humidity, unfavorable weather etc.
 - d. Recent non-compliances observed.
 - e. Appreciation of good work done by any person.
 - f. Any doubt clearing session at the end.
- ii. Tool box talk to be conducted before start of work in every shift.
- iii. During toolbox talk, visual check-up of workers regarding health, any signs of fatigue, intoxication etc. shall be conducted and any suspected workers to be acted upon.
- iv. Record of Tool box talk shall be maintained as per provided **format**

11.5 TRAINING ON HEIGHT WORK:

- i. Training on height work shall be imparted to all workers working at height by in-house/external faculty at least once every 3 months.
- ii. For Height Workers Separate pass shall be provided by the subcontractor.
- iii. The training shall be of minimum 2-hour duration, through audio-visual medium and followed by evaluation. In case of poor scoring, training shall be repeated.
- iv. The training shall include following topics:
 - a. Proper use of PPEs – safety harness, lanyard, fall arrester, retractable fall arrester, life line, safety nets etc.
 - b. Provision of secondary means of fall protection

- c. Safe climbing through monkey ladders.
- d. Inspection of PPEs.
- e. Medical fitness requirements.
- f. Mock drill on rescue at height.
- g. Dos & Don'ts during height work.
- h. Accident case Studies

11.6 RE-INDUCTION TRAINING

The induction training shall be repeated for every worker after at least 1 year and shall be a pre-requisite for renewal of Gate Pass/ ID card.

11.7 PENALTY TRAINING

The personnel involved in Safety Violations/ Incidents shall mandatorily undertake penalty training pertaining to the violation/ incident. Penalty training shall be at least half-day duration.

11.8 HSE PROMOTION-SIGNAGE, POSTERS, COMPETITION, AWARDS ETC.:

- i. HSE Displays shall be installed as indicated in Section A
- ii. Contracting agencies shall arrange for display of safety hoardings depicting suitable safety cartoons/messages/ cautionary notices at appropriate places of project site to remind the workers to perform their duties safely.
- iii. Apart from safety hoardings, each agency should maintain a safety bulletin board at all their work locations. Such safety bulletin boards should depict the activities being planned for the day, good practices, permit details etc.
- iv. Safety suggestion boxes shall be kept at each subcontractor's office at site for obtaining safety suggestions from the workers. Best suggestions should be implemented and may be rewarded suitably to encourage the workers for safety.
- v. Safety awareness campaigns, competitions, plays, movie shows, songs etc. to be organized for workers at Site and Labor colony from time to time to enhance Safety Awareness

11.9 HSE REWARDS & INCENTIVE SCHEME

Subcontractor shall implement a reward & incentive scheme for workers & supervisors displaying adherence to safety principles. Such workers shall be felicitated in a monthly function, attended by Subcontractor top management and BHEL representatives. Suitable gift shall be given to such workers for encouragement.

11.10 HSE AWARENESS PROGRAM FOR OFFICIALS:

Subcontractor shall arrange monthly HSE awareness program on different topics including medical awareness for all engineers/ supervisors / officials working at site. This program can be part of progress/ safety review meetings.

12. HSE COMMUNICATION AND PARTICIPATION:

12.1 HSE INCIDENT REPORTING, INVESTIGATION & CORRECTIVE ACTION:

- i. All incidents (near misses, property damage, first-aid cases, minor, major and fatal incidents) shall be reported to BHEL as they happen immediately through SMS and Hard/Soft copy as per provided format
- ii. All incidents including near miss, minor, major and fatal incidents shall be recorded
- iii. All incidents shall be investigated for Root Causes and corrective actions ensured to prevent recurrence shall be implemented.
- iv. Work shall be put on hold in the area till corrective actions are verified by BHEL
- v. The Root Cause Analyses and Corrective actions taken shall be recorded

12.2 HSE EVENT REPORTING:

- i. Important HSE events like HSE training, Medical camp etc. organized at site shall be reported to BHEL site management in detail with photographs for publication in different in-house magazines
- ii. Celebration of important days like National Safety Day, World Environment Day etc. shall also be reported as mentioned above.

12.3 MONTHLY HSE REPORTING:

- i. All routine and non-routine HSE activities shall be reported to BHEL on monthly basis by the subcontractor as per provided format. The reporting medium can be hard/soft as per BHEL requirement.
- ii. The period of reporting shall be 25th of the preceding month to 24th of the present month and shall be submitted by the end of the calendar month.
- iii. Report shall include good quality images of HSE Activities

12.4 DAILY HSE ACTIVITY REPORTING:

Daily HSE activities shall be reported by subcontractor to BHEL as per provided format

12.5 HSE SUGGESTIONS:

All workers and employees shall be encouraged to provide suggestions for improvement in Health, Safety & Environment performance at site. The suggestions shall be recorded in a "Suggestions Register" as per provided format. Suggestions found suitable for implementation shall be implemented and recognition / reward to be given to the submitter.

Suggestion Register to be placed at Site and Labor Colony and shall be reviewed on periodic basis

12.6 CLIENT COMMUNICATION:

All HSE related communication from BHEL, customer / external statutory and regulatory agencies to be handled on priority. Same to be recorded and issues to be resolved in expeditious manner

13. SAFETY DURING WORK EXECUTION:

Safety during work execution shall be ensured by following appropriate Safety Rules, providing adequate resources, deploying competent and trained manpower, regular training & inspection and non-conformity resolution. Main aspects are indicated as under:

13.1 OPERATIONAL CONTROL PROCEDURES:

In order to reduce the risk associated with hazardous activities, applicable OCPs (Operational control procedures) will be followed by subcontractor as per BHEL instructions, outcomes of Hazard Analysis & other requirements. This will be done as part of normal scope of work. Illustrative list of reference OCPs is given below.

TABLE 13.1 ILLUSTRATIVE LIST OF REFERENCE OCPs

No.	Topic	No.	Topic	No.	Topic
0	General Safety	22	Steam blowing	44	Material preservation
1	Handling of chemicals	23	Working in confined area	45	Electro-resistance heating
2	Electrical safety	24	Operation of passenger lift, material hoists & cages	46	Blasting
3	Energy conservation	25	Vehicle/ Crane maintenance	47	Transformer charging
4	Welding and gas cutting operation	26	Radiography	48	Handling of battery system
5	Fire safety	27	Waste disposal	49	DG set
6	Use of hand tools	28	Handling & storage of mineral wool	50	Sanitary maintenance
7	First aid	29	Working at night	51	Piling rig operation
8	Food safety at canteen	30	Computer operation	52	Passivation
9	Use of cranes	31	Storage in open yard	53	EDTA Cleaning
10	Storage and handling of gas cylinders	32	Drilling, reaming and grinding(machining)	54	Chemical cleaning of Pre boiler system
11	Manual arc welding	33	Stress relieving	55	Boiler Light up
12	Use of helmets	34	Hydraulic test	56	Rolling and Synchronization
13	Good house keeping	35	Trial run of rotary equipment	57	Loading of Unit

14	Safe excavation	36	Batching	58	Air compressor
15	Working at height	37	Cable laying/tray work	59	Hydra Operation
16	Filling of hydrogen in cylinder	38	Spray insulation	60	Duct Pre-assembly
17	Illumination	39	Compressor operation	61	Resumption of construction activities after lockdown and prevention of coronavirus infection during site operations
18	Handling and erection of heavy metals	40	Gas distribution test		
19	Acid cleaning	41	Cleaning of Hot well / Deaerator		
20	Oil flushing	42	Electrical maintenance	61A	Prevention of Covid-19 infection in labour colony
21	Alkali boil out	43	O&M of control of AC plant & system	62	Truss/ Structure fit-up and alignment

- a. The reference OCPs shall be suitably modified by subcontractor as per specific requirements to control the hazards.
- b. In case any other OCP is found to be applicable during the execution of work at site, then subcontractor will prepare and follow those as well.

13.2 WORK PERMIT SYSTEM:

- i. The following activities shall be carried out by the subcontractor strictly after obtaining Permit to Work from BHEL
 - a) Height working
 - b) Hot working
 - c) Confined space Work
 - d) Excavation more than 2-meter depth
 - e) Radiography
 - f) Heavy / Complex / Critical Lifting Activity
 - g) Night / Holiday Work
 - h) Material Loading / Unloading
 - i) Grating, Safety Net, Safety Facility Removal
 - j) Live Electrical Maintenance etc. - Lockout / Tagout
 - k) Beam / truss/ duct/ structure alignment
- ii. The Work Permit Formats shall be provided by BHEL at Site. It is the responsibility of the subcontractor to ensure their availability
- iii. The above list is not exhaustive. BHEL reserves right to introduce additional Permits or modify requirements for usage of existing Permits. The conditions for using the Permit are specified in the Format (General Requirements).
- iv. Where customer is having separate Work Permit System the same shall be followed in conjunction / merged to ensure all activities and checks are covered in all systems.
- v. Details of working Group to be attached along with work permit request.

- vi. All the Permits along with JSA/HIRA must be initiated by Agency Execution Team
- vii. Permit applicant shall apply for work permit of particular work activity at particular location before starting of the work with Job Hazard Analysis.
- viii. All Permit signatories (including subcontractor’s package in-charge and HSE Officer) shall physically visit the work area and check that all the safety control measures necessary for the activity are in place. Only then the permit shall be issued.
- ix. Signatory shall physically visit the area of work and ensure all required safeguards before signing the Permit
- x. Signatory shall periodically visit the area to confirm the availability of required safeguards throughout the currency of the permit
- xi. In case any Permit requirement is not available, work will be stopped till it is made available
- xii. Permit holder shall implement and maintain all control measures during the period of permit. The permit will be closed after completion of the work.
- xiii. Online Work Permit System shall be used whenever provided by BHEL, otherwise hard copy shall be used

13.3 ACTIVITY-SPECIFIC PRECAUTIONS/ CONTROLS

Detailed HSE precautions for various activities undertaken at Site by the subcontractors are specified in **Annexure I**. Same are to be ensured by the Sub-subcontractor while carrying out respective activities at Site

Index of **Annexure I** is given as under

SN	Description	Page No.
1.	General	2
2.	Work at height	2
2.1	Personnel fall protection system must include	3
2.2	Working Platform	4
2.3	Scaffolding	5
2.4	Ladder Safety	7
3.	Excavation & Civil Works	8
3.1	Excavation	8
3.2	Piling	9
3.3	Batching Plant Operation	9
3.4	Mobile Plant	10
3.5	Concrete Vibrators	11
3.6	Concrete Mixers	11
4.	Welding & Gas Cutting Safety (Hot Work)	11
5.	Lifting & Rigging Safety	13
5.1	Cranes & Hoisting Equipment	15
6.	Demolition Work	20
7.	T&Ps General	20
8.	Chemical Handling	20
9.	Electrical Safety	

10.	Use of Hand Tools and Power-Operated Tools	25
11.	Start Up, Commissioning and Testing:	27
12.	Fire Safety	27
13.	Painting	28
14.	Hazardous Energy” Control Procedure/ Lockout/Tagout (LOTO)	29
15.	Risk Assessment	36
16.	HSE Preparedness for Adverse Climates and Weather	37
16.1	Summer	37
16.2	Monsoon	38
16.3	Emergency Weather Conditions	40
16.4	Prevention of Covid-19 At Project Site & Labor Colony	41
16.5	Noise Mitigation	43

14. ENVIRONMENTAL CONTROL & SOCIAL RESPONSIBILITY

- i. Environment protection has always been given prime importance by BHEL. Environmental damage is a major concern of the principal subcontractor and every effort shall be made, to have effective control measures in place to avoid pollution of Air, Water and Land and associated life. Banned substances like asbestos and Chlorofluorocarbons such as carbon tetrachloride and trichloroethylene shall not be used. Waste disposal shall be done in accordance with the guidelines laid down in the project specification.
- ii. Any chemical including solvents and paints, required for construction shall be stored in designated bonded areas around the site as per Material Safety Data Sheet (MSDS).
- iii. In the event of any spillage, the principle is to recover as much material as possible before it enters drainage system and to take all possible action to prevent spilled materials from running off the site. The subcontractor shall use appropriate MSDS for clean-up technique
- iv. All subcontractors shall be responsible for the cleanliness of their own areas
- v. Regular dust suppression using sprinklers shall be carried out in respective area
- vi. The subcontractors shall ensure that noise levels generated by plant or machinery are as low as reasonably practicable. Where the subcontractor anticipates the generation of excessive noise levels from his operations the subcontractor shall inform to Construction Manager of BHEL accordingly so that reasonable & practicable precautions can be taken to protect other persons who may be affected.
- vii. It is imperative on the part of the subcontractor to join and effectively contribute in joint measures such as tree plantation, environment protection, contributing towards social upliftment, conversion of packing woods to school furniture, enhancing good relation with local populace etc.
- viii. The subcontractor shall carry out periodic air and water quality check and illumination level checking in his area of work place and take suitable control measure.

15. HOUSEKEEPING

- i. Keeping the work area and access roads clean/ free from debris, removed scaffoldings, scraps, insulation/sheeting wastage /cut pieces, temporary structures, packing woods etc. will be in the scope of the subcontractor. Such cleanings have to be done by subcontractor within quoted rate, on daily basis.
- ii. If such activity is not carried out by subcontractor / BHEL is not satisfied, then BHEL may get it done by other agency and actual cost along with BHEL overheads will be deducted from subcontractor's bill. Such decisions of BHEL shall be binding on the subcontractor
- iii. Dedicated Housekeeping gangs shall be deployed, who shall be provided all required PPEs and safety training
- iv. Mass housekeeping shall be carried out for half a day in a week
- v. Proper housekeeping to be maintained at work place and the following are to be taken care of on daily basis.
- vi. All surplus earth and debris are removed/disposed off from the working areas to identified locations.
- vii. Unused/Surplus cables, steel items and steel scrap lying scattered at different places/elevation within the working areas are removed to identified locations.
- viii. All wooden scrap, empty wooden cable drums and other combustible packing materials, shall be removed from workplace to identified locations.
- ix. Sufficient waste bins shall be provided at different work places for easy collection of scrap/waste. Scrap chute shall be installed to remove scrap from high locations.
- x. Access and egress (stair case, gangways, ladders etc.) path should be free from all scrap and other hindrances.
- xi. Workmen shall be educated through tool box talk about the importance of housekeeping and encourage not to litter.
- xii. Labor camp area shall be kept clear and materials like pipes, steel, sand, concrete, chips and bricks, etc. shall not be allowed in the camp to obstruct free movement of men and machineries.
- xiii. Fabricated steel structures, pipes & piping materials shall be stacked properly.
- xiv. No parking of trucks/trolleys, cranes and trailers etc. shall be allowed in the camp, which may obstruct the traffic movement as well as below LT/HT power line.
- xv. Utmost care shall be taken to ensure over all cleanliness and proper upkeep of the working areas.

16. WASTE MANAGEMENT

- i. Take suitable measures for waste management and environment related laws/legislation as a part of normal construction activities. Compliance with the legal requirements on storage/ disposal of paint drums (including the empty ones), Lubricant containers, Chemical Containers, and transportation and storage of hazardous chemicals will be strictly maintained.
- ii. Details of E-Waste, Hazardous Waste, biomedical waste etc. and their disposal plan, shall be submitted to BHEL every 6 months as per provided **formats**.

16.1 BINS AT WORK PLACE

- i. Sufficient rubbish bins shall be provided close to workplaces.
- ii. Bins should be painted yellow and numbered.
- iii. Sufficient nos. of drip trays shall be provided to collect oil and grease.
- iv. Sufficient qty. of broomsticks with handle shall be provided.
- v. Adequate strength of employees should be deployed to ensure daily monitoring and service for waste management.

16.2 STORAGE AND COLLECTION

- i. Different types of rubbish/waste should be collected and stored separately.
- ii. Paper, oily rags, smoking material, flammable, metal pieces should be collected in separate bins with close fitting lids.
- iii. Rubbish should not be left or allowed to accumulate on construction and other work places.
- iv. Do not burn construction rubbish near working site.

16.3 SEGREGATION

- i. Earmark the scrap area for different types of waste.
- ii. Store wastes away from building.
- iii. Oil spill absorbed by non-combustible absorbent should be kept in separate bin.
- iv. Clinical and first aid waste stored and incinerated separately.

16.4 DISPOSAL

- i. Sufficient containers and scrap disposal area should be allocated.
- ii. All scrap bin and containers should be conveniently located.
- iii. Provide self-closing containers for flammable/spontaneously combustible material.
- iv. Keep drainage channels free from choking.
- v. Make schedule for collection and disposal of waste.

16.5 WARNING AND SIGNS

- i. Appropriate sign to be displayed at scrap storage area
- ii. No toxic, corrosive or flammable substance to be discarded into public sewage system.
- iii. Waste disposal shall be in accordance with best practice.
- iv. Comply with all the requirements of Pollution Control Board (PCB) for storage and disposal of hazardous waste.

17. TRAFFIC MANAGEMENT SYSTEM

17.1 SAFE WORKPLACE TRANSPORT SYSTEM

- i. Traffic routes in a work place shall be suitable for the persons or vehicles using them. This shall be sufficient in number and of sufficient size. This shall reflect the suitability of traffic routes for vehicles and pedestrians.

- ii. Where vehicles and pedestrians use the same traffic routes there shall be sufficient space between them. Where necessary all traffic routes must be suitably indicated. Pedestrians or vehicles must be able to use traffic routes without endangering those at work. There must be sufficient separation of traffic routes from doors, gates and pedestrian traffic routes.
- iii. For internal traffic, lines marked on roads / access routes and between buildings shall clearly indicate where vehicles are to pass.
- iv. Temporary obstacles shall be brought to the attention of drivers by warning signs or hazard cones.
- v. Speed limits shall be clearly displayed for each kind of vehicle.
- vi. Speed ramps preceded by a warning signs or marker are necessary.
- vii. The traffic route should be wide enough to allow vehicles to pass and re-pass oncoming or parked traffic and it may be advisable to introduce on-way system or parking restrictions.
- viii. Safest route shall be provided between places where vehicles have to call or deliver.
- ix. Avoid vulnerable areas/items such as fuel or chemicals tanks or pipes, open or unprotected edges and structures likely to collapse
- x. Safe areas shall be provided for loading and unloading.
- xi. Avoid sharp or blind bends. If this is not possible hazards should be indicated e.g. blind corner.
- xii. Ensure road crossings are minimum and clearly signed.
- xiii. Entrance and gateways shall be wide enough to accommodate a second vehicle without causing obstruction.
- xiv. Set sensible speed limits which are clearly sign posted.
- xv. Where necessary ramps should be used to retard speed. This shall be preceded by a warning sign or mark on the road.
- xvi. Forklift trucks shall not pass over road hump unless of a type capable of doing so.
- xvii. Overhead electric cable, pipes containing flammable hazardous chemical shall be shielded by using goal posts height gauge posts or barriers.
- xviii. Road traffic signs shall be provided on prominent locations for prevention of incidents and hazards and for quick guidance and warning to employees and public. Safety signs shall be displayed as per the project working requirement and guideline of the state in which project is done. Vehicles hired or used shall not be parked within the 15m radius of any working area. Any vehicle, that is required to be at the immediate/near the vicinity, shall be approved by the person in-charge of the site.

17.2 TRAFFIC ROUTE FOR PEDESTRIANS

- i. Where traffic routes are used by both pedestrians and vehicles road shall be wide enough to allow vehicles and pedestrians safely.
- ii. Separate routes shall be provided for pedestrians to keep them away from vehicles. Provide suitable barriers/guard at entrances/exit and the corners or buildings.
- iii. Where pedestrian and vehicle routes cross, appropriate crossing shall be provided.

- iv. Where crowd is likely to use roadway e.g. at the end of shift, stop vehicles from using them at such times.
- v. Provide high visibility clothing for people permitted in delivery area.

17.3 WORK VEHICLE

Work vehicle shall be as safe stable efficient and roadworthy as private vehicles on public roads. Site management shall ensure that drivers are suitably trained. All vehicle e.g. heavy motor vehicle forklift trucks dump trucks mobile cranes shall ensure that the work equipment conforms to the following:

- i. A high level of stability.
- ii. A safe means of access/egress.
- iii. Suitable and effective service and parking brakes.
- iv. Windscreens with wipers and external mirrors giving optimum all round visibility.
- v. Provision of horn, vehicle lights, reflectors, reversing lights, reversing alarms.
- vi. Provision of seat belts.
- vii. Guards on dangerous parts.
- viii. Driver protection - to prevent injury from overturning and from falling objects/materials.
- ix. Driver protection from adverse weather.
- x. No vehicle shall be parked below HT/LT power lines.
- xi. Valid Pollution Under Control certification for all vehicles
- xii. Wheel stopper shall be use during the parking of vehicle
- xiii. Helper to be deployed in each vehicle as per site requirement.

17.4 DAILY CHECK BY DRIVER

1. There should also be daily safety checks containing below mentioned points by the driver before the vehicle is used.

Brakes	Mirrors	Warning signals
Tires	Windscreen waters	Specific safety systems i.e. controls & interlocks
Steering	Wipers	

2. Management should ensure that drivers carry out these checks.

17.5 TRANSPORTATION OF PERSONNEL AND MATERIALS BY VEHICLES

- i. All drivers shall hold a valid driving License for the class of vehicle to be driven and be registered as an authorized BHEL driver with the Administration Department.
- ii. Securing of the load shall be by established and approved methods, i.e. chains with patented tightening equipment for steel/heavy loads. Sharp corners on loads shall be avoided when employing ropes for securing.
- iii. All overhangs shall be made clearly visible and restricted to acceptable limits
- iv. Load shall be checked before moving off and after traveling a suitable distance.
- v. On no account is construction site to be blocked by parked vehicles Drivers of vehicles shall only stop or park in the areas designate by the stringing foreman.

Bharat Heavy Electricals Limited, Power Sector

Regd. Office: BHEL House, Siri Fort, New Delhi-110049



- vi. Warning signs shall be displayed during transportation of material.
- vii. All vehicles used by BHEL shall be in worthy condition and in conformance to the Land Transport requirement.
- viii. Wheel stopper shall be use during the parking of vehicle
- ix. Helper to be deployed in each vehicle as per site requirement.

17.6 MAINTENANCE

All Vehicles used for transportation of man and material shall undergo scheduled inspections on frequent intervals to secure safe operation. Such inspections shall be conducted in particular for steering, brakes, lights, horn, doors etc. Site management shall ensure that work equipment is maintained in an efficient, working order and in good repair. Inspections and services carried out at regular intervals of time and or mileage. No maintenance shall be carried below HT/LT power lines.

18. EMERGENCY PREPAREDNESS AND RESPONSE

- i. Emergency preparedness and response capability of site shall be developed as per Emergency Preparedness and Response plan issued by BHEL
- ii. Availability of adequate number of first aiders and fire warden shall be ensured with BHEL and its subcontractors
- iii. All the subcontractor's supervisory personnel and sufficient number of workers shall be trained for fire protection systems. Enough number of such trained personnel must be available during the tenure of contract. Subcontractor should nominate his supervisor to coordinate and implement the safety measures.
- iv. Assembly point shall be earmarked and access to the same from different location shall be shown
- v. Fire exit shall be identified and pathway shall be clear for emergency escape.
- vi. Appropriate type and number of fire extinguisher shall be deployed as per Fire extinguisher deployment plan and validity shall be ensured periodically through inspection
- vii. Adequate number of first aid boxes shall be strategically placed at different work places to cater emergency need. Holder of the first aid box shall be identified on the box itself who will have the responsibility to maintain the same.
- viii. First aid center shall be developed at site with trained medical personnel and ambulance
- ix. Emergency contact numbers (format given in EPRP) of the site shall be displayed at prominent locations.
- x. Tie up with fire brigade shall be done in case customer is not having fire station.
- xi. Tie up with hospital shall be done in case customer is not having hospital.
- xii. Disaster Management group shall be formed at site
- xiii. Mock drill shall be arranged at regular intervals. Monthly report of the above to be given to BHEL HSE Officer as per prescribed BHEL formats
- xiv. Mock drill shall be conducted on different emergencies periodically to find out gaps in emergency preparedness and taking necessary corrective action

19. HSE INSPECTION

Inspection on HSE for different activities being carried out at site shall be done to ensure compliance to HSE requirements. The subcontractor shall maintain and ensure necessary safety measures as required for inspection and tests HV test, Pneumatic test, Hydraulic test, Spring test, Bend test as applicable, to enable inspection agency for performing Inspection. If any test equipment is found not complying with proper safety requirements then the Inspection Agency may withhold inspection, till such time the desired safety requirements are met.

Online/ App-based HSE Inspection system shall be used for inspection whenever provided by BHEL otherwise Hard-copy based system shall continue

 <input checked="" type="checkbox"/> OK	<input type="checkbox"/> NOT OK
Contractor Name:	
Equipment Identification No :	
Inspection Date :	
Next Inspection Date :	
Inspected By :	

Every Inspected Equipment shall display above sticker

19.1 INSPECTION PLAN

Subcontractor shall prepare an inspection plan covering all areas/ activities/ equipment/ hazards and implement the same after getting approval of BHEL. Responsibility to ensure coverage of all areas/ activities rests with the subcontractor.

All Inspections shall be witnessed by BHEL – only then they shall be considered as valid

19.2 INSPECTION REPORTS

Monthly inspection reports as per plan shall be submitted to BHEL HSE Head

19.3 NON-CONFORMANCES

Any non-conformances identified during inspection observed shall be addressed on priority.

The responsibility of resolution shall rest with the Subcontractor Site In-charge

In case immediate closure of non-conformities is not possible:

- work to be halted in the area
- non-conformance to be generated and submitted to responsible person and BHEL
- non-conformance to be resolved through responsible agency / person

Only after closure of non-conformances, work to be allowed to resume

19.4 DAILY HSE CHECKS

Both the Site Supervisors and HSE Officer of Subcontractor are to conduct daily site Safety inspection around work activities and premises to ensure that work methods and the sites

are maintained to an acceptable standard. The following are to form the common subjects of a daily safety inspection:

- i. Personal Safety wears & gear compliance.
- ii. Complying with site safety rules and permit-to-work (PTW).
- iii. Positions and postures of workers.
- iv. Use of tools and equipment etc. by the workers.

The inspection should be carried out just when work starts in beginning of the day, during peak activities period of the day and just before the day's work ends.

19.5 INDICATIVE LIST OF INSPECTIONS AND PERIODICITIES

Indicative list & periodicity of Inspections is given as under. It is the responsibility of the subcontractor to develop an inspection plan covering all areas & activities in the scope.

SL. No.	Format Name	Frequency of check (if applicable)
01	Inspection of First Aid Box	Weekly
02	Inspection of PPE	Weekly
03	Inspection of T&Ps	Monthly
04	Inspection of Cranes	Monthly
05	Inspection of Winches	Monthly
06	Inspection on Height Working	Weekly
07	Inspection on Welding & Gas Cutting	Monthly
08	Inspection on Electrical Installation	Monthly
09	Inspection on Elevator	Weekly
10	Inspection of Excavation	Weekly
11	Inspection of Labor Colony	Monthly
12	Inspection of Illumination Levels	Weekly

The checklists shall be provided by BHEL at Site. It is the responsibility of the subcontractor to ensure their availability before start of work

19.5.1 INSPECTION OF PPE

- i. PPEs shall be inspected by HSE officer at random once in a week as per provided **format** for its compliance to standard and compliance to use and any adverse observation shall be recorded in the PPE register.
- ii. The applicable PPEs for carrying out particular activities are listed below.

19.5.2 INSPECTION OF TOOLS & PLANTS (T&Ps)

- i. A master list of T&Ps shall be maintained by each subcontractor in provided **format**.
- ii. All T&Ps being used at site shall be inspected by HSE officer once in a month as per provided **format** for its healthiness and maintenance.
- iii. The T&Ps which require third party inspection shall be checked for its validity during inspection. The third-party test certificate should be accompanied with a copy of the concerned competent person's valid qualification record.

- iv. BHEL shall be given advance intimation of Third-Party Inspection. BHEL shall associate with Inspection as per discretion.
- v. The validity of T&P shall be monitored as per provided **format**

19.5.3 INSPECTION OF CRANES AND WINCHES

- i. Cranes and winches shall be inspected by the operator through a daily checklist for its safe condition (as provided by the equipment manufacturer) before first use of the day.
- ii. Cranes and Winches shall be inspected by HSE officer once in a month as per provided **format** for healthiness, maintenance and validity of third-party inspection.
- iii. The date of third-party inspection and next due date shall be painted on cranes and winches.
- iv. The operators/drivers shall be authorized by sub-subcontractor based on their competency and experience and shall carry the I-card.
- v. The operator should be above 18 years of age and should be in possession of driving license of HMV man & goods), vision test certificate and should have minimum qualification so that he can read the instructions and check list.

19.5.4 INSPECTION OF HEIGHT WORKING

- i. Any activity carried out at more than 2 m height is classified as height work.
- ii. Inspection of height working shall be conducted daily by Supervisors before start of work to ensure safe working condition including provision of
 - a. Fall arrestor
 - b. Lifelines – connected to rigid & independent structure
 - c. Safety nets deployed below all height work activities
 - d. Fencing and barricading
 - e. Warning signage
 - f. Covering of opening
 - g. Proper scaffolding with access and egress.
 - h. Illumination
- iii. For full duration of height work, constant supervision to be maintained by dedicated HSE personnel
- iv. Inspection on height working shall be conducted once in a week by HSE officer as per provided **format**.
- v. Medical fitness of height worker shall be ensured.
- vi. Height working shall not be allowed during adverse weather.

19.5.5 INSPECTION OF WELDING AND GAS CUTTING OPERATION

- i. Supervisor shall ensure that no flammable items are available in near vicinity during welding and gas cutting activity.
- ii. Gas cylinders shall be kept upright.
- iii. Use of Flash back arrestor shall be ensured at both ends.

- iv. Inspection during welding and gas cutting operations shall be carried out by HSE officer once a month as per provided **format**.
- v. Use of fire blanket to be ensured to avoid falling of splatters during welding or gas cutting operation at height.
- vi. Availability of fire extinguisher at vicinity shall be ensured.

19.5.6 INSPECTION OF ELECTRICAL INSTALLATION / APPLIANCES

- i. Ensure proper earthing in electrical installation
- ii. Use ELCB at electrical booth
- iii. Electrical installation shall be properly covered at top where required
- iv. Use appropriate PPEs while working
- v. Use portable electrical light < 24 V in confined space and potentially wet area.
- vi. Inspection shall be carried out as per provided **format**.

19.5.7 INSPECTION OF ELEVATOR

- i. Elevators shall be inspected by concerned supervisors once in a week as per provided **format**
- ii. All elevators shall be inspected by competent person and validity shall be ensured.
- iii. The date of third-party inspection and next due date shall be painted on elevator.

19.5.8 INSPECTION OF EXCAVATION

Excavation activities shall be inspected as per provided **format**

19.5.9 INTERNAL/ EXTERNAL HSE AUDITS/INSPECTIONS

- i. All non-conformities and observations on HSE identified during internal or external HSE audit shall be disposed of by site in a time bound manner and reported back the implementation status.
- ii. Corrective action and Preventive action on HSE issues raised by certification body issued by BHEL shall be implemented by site and reported to Site management.

20. TERMS AND DEFINITIONS:

1. Incident

Work- related or natural event(s) in which an injury, or ill health (regardless of severity), damage to property or fatality occurred, or could have occurred.

2. Near Miss:

An incident where no ill health, injury, damage or other loss occurs, but it had a potential to cause, is referred to as "Near-Miss".

3. Man-Hours Worked:

The total number of man hours worked by all employees including subcontractors working in the premises. It includes managerial, supervisory, professional, technical, clerical and other workers including contract labors. Man-hours worked shall be calculated from the payroll or time clock recorded including overtime. When this is not feasible, the same shall be estimated by multiplying the total man-days worked

period covered by the number of hours worked per day. The total number of workdays for a period is the sum of the number of men at work on each day of period. If the daily hours vary from department to department separate estimate shall be made for each department and the result added together.

4. First Aid Cases:

First aids are not essentially all reportable cases, where the injured person is given medical treatment and discharged immediately for reporting on duty, without counting any lost time.

5. Lost Time Injury:

Any work injury which renders the injured person unable to perform his regular job or an alternative restricted work assignment on the next scheduled work day after the day on which the injury occurred.

6. Medical Cases:

Medical cases come under non-reportable cases, where owing to illness or other reason the employee was absent from work and seeks Medical treatment.

7. Type of Incidents & Their Reporting:

The three categories of Incident are as follows:

8. Non-Reportable Cases:

An incident, where the injured person is given medical help and discharged for work without counting any lost time.

9. Reportable Cases:

In this case the injured person is disable for 48 hours or more and is not able to perform his duty.

10. Injury Cases:

These are covered under the heading of non-reportable cases. In these cases, the incident caused injury to the person, but he still continues his duty.

11. Total Reportable Frequency Rate

Frequency rate is the number of Reportable Lost Time Injury (LTI) per one Million Man hours worked. Mathematically, the formula read as:

Number of Reportable LTI x 1,000,000/ Total Man Hours Worked

12. Severity Rate:

Severity rate is the Number of days lost due to Lost Time Injury (LTI) per one Million Man hours worked. Mathematically, the formula reads as:

Days lost due to LTI x 1,000,000/ Total Man Hours Worked

13. Incidence Rate:

Incidence Rate is the Number of LTI per one thousand manpower deployed. Mathematically, the formula reads as:

Number of LTIx1000/Average number of manpower deployed

14. HIRA:

Hazard Identification and Risk Assessment (HIRA) is a process of identifying Hazards in work area and then assessing them properly

15. Method Statement:

A method statement is prepared by the Execution/ Engineering Department detailing the steps, equipment, competencies and safety precautions required for carrying out any activity

16. Job Safety Analysis:

A job safety analysis (JSA) is a procedure which helps integrate accepted safety and health principles and practices into a particular task or job operation. In a JSA, each basic step of the job is to identify potential hazards and to recommend the safest way to do the job. Other terms used to describe this procedure are job hazard analysis (JHA) and job hazard breakdown.

17. Safety Walk:

It's conducted periodically by an official - it's a walk through a portion or whole of a site as a HSE officer who notes down HSE observations, speak to concerned workmen and supervisor on observation, get the same corrected with personal follow up- this sends out a strong message on Management's commitment to safety.

18. Heavy & Complex Lifting:

A heavy and complex lifting activity includes:

1. Lifting above 20 Tons
2. Tandem Lifting using multiple cranes
Total load exceeding 75% of capacity of crane. Depending up the condition of cranes, hydra cranes, winch machines & other lifting accessories
3. Lift of unusual difficulty or geometry or rigging
4. Lift over operating units
5. Any other lift as decided by site HSE / Erection

19. Safety Committee:

As per the BOCW, Safety Committee shall be constituted if there are more than five hundred or more construction workers are employed at any site. As per the Factories Act, 1948 it is for 250 workers. It shall be represented by equal number of representatives of employer and construction workers.

20. Night Work:

Work conducted after sunset when only a fraction of total manpower is available





ANNEXURES

Rk



ANNEXURE A

Medical Centre & Ambulance

Rk

A. Medical Centre

1. Paramedical staff
 - a. When < 500 workers, 1 Trained Male Nurse (round the clock deployment)
 - b. When >=500 workers*:
 - i. Registered Medical Practitioner (Qualified MBBS) to be deployed for at least 8 hours in a day, 5 days per week
 - ii. 2 Trained Male Nurses (round the clock deployment)
 2. All articles as per Schedule IV of BOCW Central Rules, 1998 to be made available in the Medical Centre (given under for convenience)
 3. Basic Facilities/ Requirements to be provided as per location eg. Refrigerator, Air Conditioner, Anti Venom Serums etc.
 4. Tie-ups with speciality hospitals to be ensured for referring serious patients
- * In case the number of workers is envisaged to exceed 500, a medical practitioner is to be engaged.

SCHEDULE IV (BOCW CENTRAL RULES, 1998) ARTICLES FOR AMBULANCE ROOM [SEE RULE 226 (C)]

- i. A glazed sink with hot and cold water always available.
- ii. A table with a smooth top at least 180 cm x 105 cm.
- iii. Means for sterilising instruments.
- iv. A couch.
- v. Two stretchers.
- vi. Two buckets or containers with close fitting lids.
- vii. Two rubber hot water bags
- viii. A kettle and spirit stove or other suitable means of boiling water.
- ix. Twelve plain wooden splints 900 cm x 100 cm x 6 cm.
- x. Twelve plain wooden splints 350 cm x 75 cm x 6 cm.
- xi. Six plain wooden splints 250 cm x 50 cm x 12 cm.
- xii. Six woollen blankets.
- xiii. Three pairs of artery forceps.
- xiv. One bottle of spiritus annemia aremations (120 ml).
- xv. Smelling salt (60 gm).
- xvi. Two medium size sponges.
- xvii. Six hand towels.
- xviii. Four kidney trays.
- xix. Four cakes of toilet, preferably antiseptic soap.
- xx. Two glass tumblers and two wine glasses.
- xxi. Two clinical thermometers.
- xxii. Two tea spoons.
- xxiii. Two graduated (120 ml) measuring glasses.
- xxiv. Two minimum measuring glasses.
- xxv. One wash bottle (1000 cc) for washing eyes.
- xxvi. one bottle (one litre) carbolic lotion 1 to 20.
- xxvii. Three chairs.
- xxviii. One screen.
- xxix. One electric hand torch.
- xxx. Four first-aid boxes or cupboards stocked to the standards prescribed in
- xxxi. An adequate supply of tetanus toxoid.
- xxxii. Injections—morphia, pethidine, atrophine, adrenaline, coramine, novocaine (6 each).
- xxxiii. Cramine liquid (60 ml).
- xxxiv. Tablets—antihistaminic antispasmodic (25 each).
- xxxv. Syringes with needles—2 cc, 5 cc, 10 cc and 500 cc.

- xxxvi. Three surgical scissors.
- xxxvii. Two needle holders, big and small.
- xxxviii. Suturing needles and materials.
- xxxix. Three dissecting forceps
 - xl. Three dressing forceps
 - xli. Three scalpels.
 - xlii. One stethoscope and a B. P. apparatus.
- xliii. Rubber bandage—pressure bandage.
- xliv. Oxygen cylinder with necessary attachments.
- xlv. Atropine eye ointments.
- xlvi. I. V. Fluids and sets 10 nos.
- xlvii. Suitable, foot operated, covered, refuse containers.
- xlviii. Adequate number of sterilised, paired, latex hand gloves.

B. Ambulance

1. When number of workers is <500:
If the distance to a major hospital capable of handling critical injuries expected at Site is <= 50 KM from Site, then 1 BLS (Basic Life Support)/ Type B Ambulance otherwise ALS* (Advanced Life Support)/ Type D Ambulance
2. If no. of workers increases to >2000 workers one additional BLS Ambulance to be deployed
3. Minimum Articles as per Schedule V of BOCW Central Rules to be ensured in each Ambulance. (given under for convenience)

*Final call to be taken at Site in consultation with all the contractors

**SCHEDULE V (BOCW CENTRAL RULES, 1998)
CONTENTS OF AMBULANCE VAN OR CARRIAGE
[SEE RULE 227]**

The Ambulance Van shall have equipment prescribed as under:

- a) General—a portable stretcher with folding and adjusting devices with the Head of the stretcher capable of being tilted upward. Fixed suction unit with equipment. Fixed oxygen supply with equipment. Pillow with case, sheets, blankets, towels, emergency bag, bed pan, urinal glass.
- b) Safety Equipment—Flaros with life of three thousand minutes, floor lights, flash lights, fire extinguishers (dry power type), insulated guntlets.
- c) Emergency Care Equipment—
 - i. **Resuscitation**—Portable suction unit, portable oxygen unit, bag valve mask, hand operated artificial ventilation unit, airways, mouth gag tracheostomy adapters, short spine board, I.V. FLUIDS with administration unit, B. P. manometer cuff stethoscope.
 - ii. **Immobilisation**—Long and short padded boards, wire ladder splints, triangular bandage—long and short spine boards.
 - iii. **Dressing**—Gauze pads—100 m x 100 mm universal dressing 250 x 1000 mm, roll of aluminium foils—soft roller bandages 150 mm x 5 mm yards adhesive tape in 75 mm roll safety pins, bandage sheets, burn sheets.
 - iv. **Poisoning**—Syrup of Ipecac, activated charcoal pre packeted dose, snake bit kit, drinking water.
 - v. **Emergency Medicines**—As per requirement (under the advice of construction Medical Officer).



ANNEXURE A.1

Sample calculation for deduction of operational cost of facilities

Rk

Annexure A.1**Cost Calculation Methodology of Operation of Facilities (Data is indicative only)**

(Period of 48 months is considered - shall be on actual basis)

A. Project Info:

Total time of Project	48 months
Project cost	1000 Crore
No. of packages	10 (A1-A10)

B. Item-wise Calculation:

Item	Nos.	Rate	Unit	Amount
Ambulance with Driver	2		Monthly/Unit	170000
Nurse/First aider	2 X 2 shifts	15000	Per month	30000
Training center one time cost	1	100000	Once	100000
Medical center one time cost	1	200000	Once	200000
Medicines at medical center	1	10000	Monthly	10000
Dust supression water tank	2	2000	Monthly	4000
Doctor	1	70000	Monthly	70000
Cleaning staff	1	12000	Monthly	12000
Recurring monthly expenditure				296000
Total one-time expenditure				300000

C. Package-wise Deduction Plan for a period of 48 months

Period (In Months)	6	36	6
	For 1-6 months	For 7-42 months	For 43-48 months
Cost to be incurred from contractors	7%	81%	12%
	1.17% per month	2.25% per month	2.00% per month

D. Calculation For One-Time Running Cost

Packages/ Contracts	A1	A2	A3	A4	A5	A6	A7	A8	A9	A10				
Contract Values (in Thousands)	100000	250000	2000000	200000	500000	1500000	1000000	1000000	250000	200000	7000000			
Share of common facilities one time running cost (in Thousands)	4	11	86	9	21	64	43	43	11	9	Individual Pkg value X Total one time running cost / All Pkg award values			
Timeline of work	1-6	1-8	2-48	6-36	7-15	10-48	6-48	7-40	40-48	41-48				
Month Count of work	6	8	47	31	9	39	43	34	9	8				
Deduction per month (in Thousands)	1	1	2	0	2	2	1	1	1	1	Total of One time Running cost (in thousands)	% deduction share of one time running cost per month	Nos. of active packages in month	
Month No.														
1	1	1									2	1%	2	
2	1	1	2								4	1%	3	
3	1	1	2								4	1%	3	
4	1	1	2								4	1%	3	
5	1	1	2								4	1%	3	
6	1	1	2	0			1				5	2%	5	
7		1	2	0	2		1	1			8	3%	6	
8		1	2	0	2		1	1			8	3%	6	
9			2	0	2		1	1			7	2%	5	
10			2	0	2	2	1	1			8	3%	6	
11			2	0	2	2	1	1			8	3%	6	
12			2	0	2	2	1	1			8	3%	6	
13			2	0	2	2	1	1			8	3%	6	
14			2	0	2	2	1	1			8	3%	6	
15			2	0	2	2	1	1			8	3%	6	
16			2	0		2	1	1			6	2%	5	
17			2	0		2	1	1			6	2%	5	
18			2	0		2	1	1			6	2%	5	
19			2	0		2	1	1			6	2%	5	
20			2	0		2	1	1			6	2%	5	
21			2	0		2	1	1			6	2%	5	
22			2	0		2	1	1			6	2%	5	
23			2	0		2	1	1			6	2%	5	
24			2	0		2	1	1			6	2%	5	
25			2	0		2	1	1			6	2%	5	
26			2	0		2	1	1			6	2%	5	
27			2	0		2	1	1			6	2%	5	
28			2	0		2	1	1			6	2%	5	
29			2	0		2	1	1			6	2%	5	
30			2	0		2	1	1			6	2%	5	
31			2	0		2	1	1			6	2%	5	
32			2	0		2	1	1			6	2%	5	
33			2	0		2	1	1			6	2%	5	
34			2	0		2	1	1			6	2%	5	
35			2	0		2	1	1			6	2%	5	
36			2	0		2	1	1			6	2%	5	
37			2			2	1	1			6	2%	4	
38			2			2	1	1			6	2%	4	
39			2			2	1	1			6	2%	4	
40			2			2	1	1	1		7	2%	5	
41			2			2	1		1	1	7	2%	5	
42			2			2	1		1	1	7	2%	5	
43			2			2	1		1	1	7	2%	5	
44			2			2	1		1	1	7	2%	5	
45			2			2	1		1	1	7	2%	5	
46			2			2	1		1	1	7	2%	5	
47			2			2	1		1	1	7	2%	5	
48			2			2	1		1	1	7	2%	5	
Total	4	11	86	9	21	64	43	43	11	9	300	100%		

D. Calculation For Recurring Running Cost

Packages/ Contracts	A1	A2	A3	A4	A5	A6	A7	A8	A9	A10		
Contract Values (in Thousands)	100000	250000	2000000	200000	500000	1500000	1000000	1000000	250000	200000	7000000	
Timeline of work	1-6	1-8	2-48	6-36	7-15	10-48	6-48	7-40	40-48	41-48	Total of Recurring cost (in thousands)	Nos. of active packages in month
Month No.	6	8	47	31	9	39	43	34	9	8		
1	85	211									296	2
2	13	31	252								296	3
3	13	31	252								296	3
4	13	31	252								296	3
5	13	31	252								296	3
6	8	21	167	17			83				296	5
7		15	120	12	30		60	60			296	6
8		15	120	12	30		60	60			296	6
9			126	13	31		63	63			296	5
10			95	10	24	72	48	48			296	6
11			95	10	24	72	48	48			296	6
12			95	10	24	72	48	48			296	6
13			95	10	24	72	48	48			296	6
14			95	10	24	72	48	48			296	6
15			95	10	24	72	48	48			296	6
16			104	10		78	52	52			296	5
17			104	10		78	52	52			296	5
18			104	10		78	52	52			296	5
19			104	10		78	52	52			296	5
20			104	10		78	52	52			296	5
21			104	10		78	52	52			296	5
22			104	10		78	52	52			296	5
23			104	10		78	52	52			296	5
24			104	10		78	52	52			296	5
25			104	10		78	52	52			296	5
26			104	10		78	52	52			296	5
27			104	10		78	52	52			296	5
28			104	10		78	52	52			296	5
29			104	10		78	52	52			296	5
30			104	10		78	52	52			296	5
31			104	10		78	52	52			296	5
32			104	10		78	52	52			296	5
33			104	10		78	52	52			296	5
34			104	10		78	52	52			296	5
35			104	10		78	52	52			296	5
36			104	10		78	52	52			296	5
37			108			81	54	54			296	4
38			108			81	54	54			296	4
39			108			81	54	54			296	4
40			103			77	51	51	13		296	5
41			120			90	60		15	12	296	5
42			120			90	60		15	12	296	5
43			120			90	60		15	12	296	5
44			120			90	60		15	12	296	5
45			120			90	60		15	12	296	5
46			120			90	60		15	12	296	5
47			120			90	60		15	12	296	5
48			120			90	60		15	12	296	5
Total	143	388	5676	329	235	3102	2334	1772	132	96	14208	



ANNEXURE B

HSE Displays

Rk

A. Types of Displays**1. Based on Content**

SN	Type
1.	HSE Hazards & Precautions Height Work, Housekeeping, Fire Safety, PPEs, Hot Work, Lifting & Rigging Activity, Site-specific Hazards – eg. for Refineries, Nuclear plants etc.; COVID Precautions; Environment Protection etc.
2.	Other Displays, Signage etc. HSE Policy, ISO Certificate, Safety Statistics, Assembly Area Location/ Route, Emergency Contact Numbers, Site Safety Rules & Regulations, Speed Limit, Work in Progress, Lock-Out Tag-Out (LOTO) Boards etc.

2. Based on Mounting

[Type 1]	[Type 2]	[Type 3]
Flex Sign Boards of Wooden Frame – directly mounted on Structures (walls, stairs, railings etc.)	Flex Sign Boards with Wooden Frame – mounted on metallic/ wooden legs – preferably double-sided	Coloured weather-proof Paintings on Walls (after due concurrence of BHEL/ Customer – Type 1 in case of no concurrence/ space)

B. General Requirements:

- Displays should be weather-proof as per installation location, i.e. rain-proof, wind-proof and sun-proof.
- Installation location and size to ensure visibility for the intended viewers (workers and moving personnel)
- Displays to have at least 50% graphical elements preferably (as applicable). Language should be understandable by majority of the workers
- Displays to be relevant to the hazards in the area
- Proper installation to ensure boards don't obstruct activities and should not be prone to fall so as to pose danger
- In case of multiple elevations (eg. Boiler, Power-house etc.), each elevation to have displays for applicable hazards including Height-Work, Housekeeping
- For temporary work locations, posters/ boards may be erected and shifted after task is over
- Minimum size of displays should be A1 unless otherwise specified
- In case of damage, displays shall be reviewed and repaired/ replaced
- In areas where night work is envisaged, fluorescent displays shall be installed and these should comprise of at least 20-30% of total displays
- Total Number of displays to be not less than 1 per 10 workers and are to be dynamically updated based on number of workers

C. Area-wise Displays

Below is list of Area-wise displays that are to be installed at Sites (Numbers, locations may be adjusted for specific requirements)

SN	Area	Suggested Subjects	Minimum Size	Minimum Quantity	Locations
1	Walls/ Foundations/ Cement Structures etc. belonging to the package area	Safety Hazards Prevention and other HSE Awareness content	[Type 3]	As per BHEL assessment from time to time	
2	Site Interior Roads belonging to the package area	At least every 20 meters: 1. Speed Limit Indication, Safe Driving board 2. Boards for hazard awareness	1.As needed [Type 2] 2. A1 or equivalent each [Type 2]	As indicated	Sides of Roads; Height to ensure good visibility
3	Specific Package Areas	<p>A. Common At entry to respective Package/ Work Area, each contractor to put up daily updated board with following for each shift:</p> <ol style="list-style-type: none"> 1. Scope of work and start date 2. Emergency Contact Numbers 3. Emergency Assembly Location, Escape Plan 4. Locations and supervisors of various gangs in the area, 5. Current Work permit Details 6. Safety Supervisor Location assignments - Names, Mobile Nos., Assigned Locations 7. Details (Name, Contact No. etc.) of Package In-charge - Contractor & BHEL 8. Details (Name, Contact No. etc.) of Safety In-charge - Contractor & BHEL 9. LTI Free Man-days & details of last LTI also to be indicated <p>In addition, Area-Specific Displays as indicated in Table 1</p>	A0 [Type 2]	1 per Package Area	Entry/ Ground Level

Table 1
(Area/ Package-wise HSE Display Plan – As applicable)

Prepared By (Subcontractor)				
S. No.	Area	Suggested Minimum No. of Displays & Types	Type	Numbers Installed
1	Boiler	3 per working elevation	[Type 1]	
2	Powerhouse	5 per elevation	[Type 1]	
3	ESP	5 Per Pass	[Type 1]	
4	Buildings	5 per elevation	[Type 1]	
5	Cooling Tower (NDCT/ IDCT/ ACC)	20 per Structure	[Type 1]	
6	Chimney	20 per Structure	[Type 1]	
7	Fabrication Yard	10 per Yard	[Type 2]	
8	Batching Plant	5 per Plant	[Type 1]	
9	Material Storage Yard – Open	20 per Yard	[Type 2]	
10	Material Storage Shed – Semi-Closed/ Closed	10 per Shed	[Type 1]	
11	Electrical Booths	2 per booth + Line diagram, Emergency contact details	[Type 1]	
12	Medical & First Aid Centre	2 per Centre	[Type 1]	
13	Rest Shed	2 per Shed	[Type 1]	
14	Canteen	2 per Canteen	[Type 1]	
15	Drinking Water Area	1 Per Outlet	[Type 1]	
16	Washing Water Area	1 Per Outlet	[Type 1]	
17	Training Centre	10 per room	[Type 1/2]	
18	Assembly Area	5	[Type 1/2]	
19	Stairs	1 per landing elevation	[Type 1]	
20	Cylinder Storage Area	5 + Signage: Type of Gas, Empty, Filled etc.	[Type 1/2]	
21	Labor Colony	Electrical Safety with Distribution Plan/ Line Diagram - 1 COVID Precautions Posters – 5 Safety Awareness Posters – 10 Hygiene awareness posters - 2	[Type 1]	
22	Others	As per requirement	[Type 1/2]	

Date:

Sign (Contractor)

Sign (BHEL)



ANNEXURE C

HSE Tools/ Equipment/ Devices

Rk

Following equipment conforming to relevant IS/ISO/BS Codes/ Standards in indicated quantities shall be ensured by subcontractor. This list is tentative, not exhaustive. Quantity and date/ period of deployment shall be as per site requirement.

A. HSE Tools/ Equipment/ Devices

SN	Item
1	Lifelines
2	Retractable Fall Arrestors
3	Safety Nets (10m X 5m) fire proof double mesh
4	Sky Climbers
5	Fire Blanket
6	Honey Bee Removal Suit & Kit
7	Scaffolding Pipes
8	Flashback Arrestors
9	Barricading Tape
10	Binoculars
11	Walkie-Talkies
12	LOTO kit
13	24-Volt light
14	Sand Buckets
15	Hard barricading Pipes
16	Standby Fire kits
17	Hand-held Megaphone
18	Small Public Address System
19	Foldable Stretcher
20	Height Rescue Kit (Non-Motorized)
	(Others:)

B. Test & Measurement Devices

SN	Device
1	ELCB Tester
2	Multi meter (Light cables)
3	Earth Resistance Meter
4	Lux Meter
5	Sound Meter
6	Anemometer
7	Breath Analyzer (Alcohol)
8	Multi-gas dozi-meter/ detector
9	Gas leakage detector / alarm
10	Gas monitor (confined space)
11	Radiation meter & Badges
12	Blood Pressure Monitor
13	Fire detectors
14	Hand held signaling light
	(Others:)



ANNEXURE D

Rest Sheds

Rk

1. Determining the Number, Sizes and Locations of Rest Shelters

i. **Numbers:**

The number of rest shelters shall be determined based on maximum number of workers at any one time (across all shifts). Formula is:

W_{max} = Maximum number of workers at any time in the Site

Space per worker = 1.1 sq meter

Total space required, T_{space} = $W_{max} \times 1.1$

Based on total space requirement calculated above, the number of rest sheds can be decided according to availability of locations and concentration of workers – so as to ensure the required space.

ii. **Locations:**

The rest sheds should be so located so as to minimize the distance to be travelled by the workers from their locations of work considering all the practical constraints

iii. **Other:**

The Rest shelter should be fenced so that it cannot be used as parking area.

2. Design & Construction of Rest Sheds

a. **Permanent/ Long duration Rest Sheds**

- i. For locations where, permanent rest sheds can be constructed without possibility of removal for relatively long period of time, a semi-closed shed can be constructed covered with tin roof and supported with well-grouted beams. The floor of the shed to be preferably cemented/ solidified.
- ii. Adequate structural requirements suitable to the local weather (wind/ rain etc.) to be ensured.
- iii. The design of the rest shed to be approved by Civil Engineering Department of BHEL Site before commencing work

b. **Temporary/ Movable/ Portable Rest Sheds**

- i. For locations where, permanent rest sheds cannot be constructed either due to non-availability of permanent location or other reasons, temporary rest shed shall be constructed.
- ii. Temporary rest sheds shall comprise of Tent arrangement carried out by professional agencies

3. Amenities in Rest Sheds

a. **Essential Amenities**

Following amenities shall be essentially ensured in a rest shed:

- i. Hygienic environment with regular cleaning and housekeeping (with records)
- ii. Adequate illumination
- iii. Adequate ventilation/ heating as per weather conditions
- iv. Clean Drinking water source
- v. Hand Washing area
- vi. Toilets & Urinals
- vii. Benches/ mats for sitting/ lying
- viii. Any other essential requirement deemed necessary by the Site
- ix. Dust bins of sufficient quantity/ size that are vacated each day/ as per requirement

b. **Additional/ Optional Amenities**

Following amenities are optional but are recommended to enhance the level of satisfaction of work force:

- i. Hot/ Cold drinks (Tea, Coffee, Glucose etc.) as per requirement
- ii. Snacks
- iii. Fans/ Coolers/ Heating arrangements as per requirement and weather conditions
- iv. A nice, welcoming interior design, music etc.
- v. Water cooler

4. Health & Safety Requirements of Rest Sheds

Use of asbestos in construction is banned and shall not be used.

In addition, following essential Safety features shall be ensured in Rest sheds:

- i. Availability of Fire extinguishers (preferably CO2 type)
- ii. Display of Safety Posters
- iii. Pest/ reptile protection
- iv. Mosquito prevention measures

5. Note:

Any suitable closed spaces/ newly constructed buildings etc. available at project may also be used for the purpose of rest shed with due concurrence of BHEL



ANNEXURE E

Labor Colony

Rk

1. These Guidelines suggest minimum requirements. However, additional requirements based on feasibility and circumstances, while adhering to directions of GOI/District Administration/Local Authority guidelines to be considered
2. Norms for social distancing, training/ awareness, face masks, disinfection, sanitization, gate entry, quarantine, medical, action in case of suspect cases of COVID and other communicable diseases etc. to be followed as per Govt. and BHEL guidelines issued from time to time
3. Labor colony to be developed as close to the Site as possible to avoid lengthy commute
4. A "Suggestion Register" shall be made available at the labor colony for residents. The feedback shall be reviewed on weekly basis and acted upon by concerned Contractor. Same shall be reviewed periodically by authorized BHEL Site Official.
5. **Canteens, Latrines & Urinals, Washing Facilities, Creches, Residential Accommodation and other infrastructure/ facilities:**
Numbers/ Quantities and Features of these facilities shall be in line with the following as applicable:
 - a. BOCW Act & State Rules
 - b. The Inter-State Migrant Workmen (Regulation of Employment and Conditions of Service) Act & State Rules
 - c. Factories Act & State Rules
 - d. Other Relevant Acts & Rules
6. **Cleanliness & Hygiene/ Housekeeping:**
 - a. Regular cleaning of the labor colony to be ensured.
 - b. Daily cleaning of Sanitary facilities.
 - c. Proper drainage system to prevent water-logging
 - d. Regular fogging to prevent spread of mosquitoes
 - e. Prevention of foul smell through necessary interventions
 - f. Dust suppression as per requirement
 - g. Cutting of Grass at regular intervals and other necessary measures to prevent pests & reptiles
 - h. Stray animals to be banned from labor colony.
 - i. Outside every common facility, eg. Toilet, washroom, food hall/ canteen etc., provision of washbasin with flowing water and soap (preferably liquid soap) to be ensured
7. **Power Supply Layout:**
Electrical supply Layout of Labor Colony shall have the provision of Safety devices like MCBs, ELCBs etc. and to be clearly displayed
8. **Washing & Drinking Water Availability**
 - a. Adequate water to be provided in line with: "Estimation of Water Requirements for Drinking and Domestic Use (Source: National Building Code 2016, BIS)"
 - b. Drinking water tank to be cleaned every week and sticker for the same pasted on the tank
 - c. Drinking water source should be tested as per IS 10500
9. **Waste Disposal:** Separate bins for dry, wet and biomedical waste to be installed. These bins to be evacuated regularly
10. **Training & Awareness/ Displays**
 - a. **HSE Awareness Displays:** Posters/ banners/ boards to be displayed in labor colony. Subjects of displays shall be precautions for applicable hazards at work site.
 - b. **Emergency Contact Numbers** including that of Doctor, Hospital, Labor Colony Supervisor, HSE Officials to be displayed prominently

11. Doctor Visits:

Regular and need-based visits by Doctors to be ensured through tie-ups etc.

12. Inspection & Review: Regular inspection of labor accommodation to be carried out by the Contractor as per prescribed format. Last inspection date, inspector and next due date to be prominently indicated near main gate

13. Provision of a Fair Price shop in the premises to be ensured as per requirement

14. Adequate arrangements to be ensured in case of children/ families



ANNEXURE F

Toilets

Rk

Toilets (Latrines and urinals shall be ensured at Site and Labor Colony in accordance with the Inter-State Migrant Workmen Act, 1979 as given below:

LATRINES	URINALS
<p>1. Latrines shall be provided in every establishment on the following scale, namely: -</p> <p>a. Where females are employed, there shall be at least one latrine for every 25 females;</p> <p>b. Where males are employed, there shall be at least one latrine for every 25 males:</p> <p>Provided that where the number of males or females exceeds 190, it shall be sufficient if there is one latrine for 25 males or females, as the case may be, up to the first 100, and one for every 30 thereafter</p> <p>2. Every latrine shall be under cover and so partitioned off as to secure privacy, and shall have a proper door and fastenings.</p>	<p>1. There shall be at least one urinal for male workers up to fifty and one for female up to fifty employed at a time:</p> <p>Provided that where the number of male or female workmen, as the case may be, exceeds 500 it shall be sufficient if there is one urinal for every fifty females up to the first 500 and one for every 100 or part thereof thereafter.</p> <p>2. The urinals shall be designed and located so as to ensure privacy.</p>

Important:

1. Where workers of both sexes are employed there shall be displayed outside each block of latrine and urinal a notice in the language understood by the majority of the workers '**For Men Only**', or '**For Women Only**', as the case may be.
2. The notice shall also bear the figure of a man or of a woman, as the case may be.
3. The latrines and urinals shall be conveniently situated and accessible to workers at all times at the establishment.
4. The latrines and urinals shall be adequately lighted and shall be maintained in a clean and sanitary condition at all times.
5. Latrines and urinals other than those connected with a flush sewage system shall comply with the requirements of the public health authorities.
6. Water shall be provided by the means of tap or otherwise so as to be conveniently accessible in or near the latrines and urinals.
7. At Site, on ground, **Modular Bio-toilets** as per industry standard specifications and regular professional cleaning shall be ensured. The toilets should be sufficient in number and easily accessible to workers from every work area
8. At Site, in various elevations, suitable urinals with proper drainage to be ensured at each elevation in line with IS 2064 (1993). Same to be cleaned regularly



ANNEXURE G

Fire Extinguishers

Rk

SN	Type of Fire Risk (Class of Fire)	Extinguishing Medium & Relevant INDIAN STANDARD	Scale of Equipment (Minimum recommended)
1.	CLASS 'A' Fires involving ordinary combustible materials like wood, paper, textiles, rubber etc. (Ordinary hazard or low fire load)	WATER Soda acid type, water type (gas pressure) and water type (constant air pressure) IS: 934 -1976; IS: 940 -1976; IS: 6234 -1971	For every 600 square meter floor area or part, one 9-litre capacity. Minimum 4 numbers per floor or room; should not be required to travel more than 15 meter to reach any extinguisher.
2.	CLASS 'A' (Extra hazard & high fire load)	-do	-do – (Also, consult local fire authority).
3.	CLASS 'A' (Special hazards)	-do	-do – Extra provision For every 100 square meter floor area or part, one 4.5 Kg. CO ₂ ; minimum 2 numbers per room; should not be required to travel more than 10 meter to reach any extinguisher.
4.	CLASS 'B' (Fires in flammable liquids like oils, solvents, petroleum, products, varnishes, paints, etc. where blanketing effect is essential) (Storage and handling in small quantities)	FOAM / CARBON DIOXIDE / DRY CHEMICAL POWDER IS: 933 -1976; IS: 2878 1976; IS: 2171 1976; IS: 4308 -1982	For every 50 square meter floor area or part, 2 numbers 9 -liters foam or 5 kg dry powder; should not be required to travel more than 10 m in the area of storage to reach any extinguisher.
5.	CLASS 'B' (Bulk storage other than in tank form))	-do -	-do- (but minimum 3 numbers per room)
6.	CLASS 'C' (Fires involving gaseous substances under pressure where it is necessary to dilute the burning gas at a very fast rate with an inert gas or powder) (storage and handling of gas cylinders)	CARBON DIOXIDE / DRY CHEM. POWDER. The best way to extinguish such fire is by stopping the flow of fuel gas to the fire. Container is kept cool with water spray. IS: 2878 1976; IS: 2171 -1976; IS: 4308 -1982	For every 100 square meter floor area or part; 2 numbers, 10 kg powder extinguisher or 6 kg CO ₂ ; minimum 3 nos. per room; should not be required to travel more than 10 meter to reach any extinguisher.
7.	CLASS 'D' Fires involving metals like magnesium, aluminum, zinc, potassium etc. where the burning metal is reactive to water and which require special extinguishing media or technique	SPECIAL DRY POWDER IS: 2171 -1976 IS: 4861 -1968	For every 50 square meter floor area or part, 2 nos. 5 kg special dry powder; minimum 3 nos. per room; should not be required to travel more than 10 meter to reach any extinguisher.
8.	MIXED OCCUPANCY (electrical); Generators; Transformers; etc.	CARBON DIOXIDE DRY POWDER, IS: 2878 1976; IS: 2171 -1976	For every 100 square meter floor area or part one 10 kg CO ₂ . Minimum 2 numbers for every location should not be required to travel more than 10 meter to reach an extinguisher.

Note: Due to peculiarities of the power plant construction sites, there would be locations in the construction areas of Boiler, Turbine, Generator, Transformer, etc. where different types of fire risk (classes of fire) may co-exist. Special care shall be taken while selecting and installing portable fire extinguishers for such locations so that all types of fire risk that may co-exist, are adequately covered. Similar special care shall be taken for storage areas.

- a. All Electrical welding booths shall be equipped with appropriate Fire Extinguisher

- b. Appropriate Fire Extinguishers shall be made within easy reach of all welding operations
- c. Fire extinguishers shall be regularly tested and last checked date to be indicated on each. Master list shall be prepared with location and details
- d. Providing appropriate fire-fighting equipment at designated work place and nominate a fire officer/warden adequately trained for his job.
- e. Subcontractor shall provide enough fire protecting equipment of the types and numbers at his office, stores, temporary structure in labour colony etc. Such fire protection equipment shall be easy and kept open at all times.
- f. The fire extinguishers shall be properly refilled and kept ready which should be certified at periodic intervals. The date of changing should be marked on the Cylinders.
- g. All other fire safety measures as laid down in the “codes for fire safety at construction site” issued by safety coordinator of BHEL shall be followed.
- h. Non-compliance of the above requirement under fire protection shall in no way relieve the subcontractor of any of his responsibility and liabilities to fire incident occurring either to his materials or equipment or those of others.
- i. Emergency contacts nos. must be displayed at prominent locations
- j. Tarpaulin being inflammable should not be used (instead, only non-infusible covering materials shall be used) as protective cover while preheating, welding, stress relieving etc. at site.



ANNEXURE H
HSE Compliance Certificate

Rk

Bill Ref no: _____ Date: _____

NAME OF THE AGENCY: _____ Work-Area/Package: _____

Sl. No.	Description	Remarks
1	<u>HOUSE KEEPING:</u>	
1.1	All working areas at site (specific to the agency) are free from garbage's, scraps & any other undesired non-plant materials. There is no encroachment in safe passage of man, material & T&P to carry out activities safely	
1.2	All the plant materials under the custody of the agency are stacked & stored properly.	
2	<u>GENERAL ILLUMINATION:</u>	
2.1	ALL the working areas at site & office of the agency including passages are having proper & sufficient illumination.	
3	<u>STATUTORY & REGULATORY REQUIREMENT:</u>	
3.1	Sufficient water for drinking & other purposes and sanitation in work area and labour colony are available.	
3.2	Periodical Medical check-up of workers & staff done regularly & report submitted to BHEL	
3.3	Regular EYE testing is done for Crane operators/Welders and data's are available with agency	
3.4	All the T&P, Cranes etc used by the agency are having proper T.Cs & Fitness certificate available from competent authority.	
4	<u>SAFETY COMPLIANCE:</u>	
4.1	Number of Tool box meetings between Safety officers, erection staff & workers of the agency held in this month with location mentioned	
4.2	All precautions & Safety measures including PPE compliances are taken before working at HEIGHT	
4.3	Permit for working at Height is taken & complied accordingly	
4.4	ELCB is used in Construction Power Supply source by the agency & Proper Distribution board and electrical cabling has been used by the agency and regularly checked by electrician & safety officer of the agency	
4.5	Unsafe areas barricaded properly & unsafe opening closed properly	
4.6	Proper Platforms & Hand-rails used In areas earmarked earlier	
4.7	Proper safety signage's, Slogans & Emergency contact phone numbers including FIRE contact nos. are made available by the agency in locations mentioned	
5	Whether any penalty imposed by BHEL towards non-compliance of above points.	

<u>VENDOR'S SIGNATURE</u>	
Erection Engineer	
HSE Officer	
Site-in-Charge	

<u>BHEL'S SIGNATURE</u>	
Erection Engineer	
HSE Officer	
Package-in-Charge	



ANNEXURE I

Activity-Specific Safety Precautions/ Controls

Rk

INDEX OF CONTENTS

S. No.	Description	Page No.
1.	General	2
2.	Work at height	2
2.1	Personnel fall protection system must include	3
2.2	Working Platform	4
2.3	Scaffolding	5
2.4	Ladder Safety	7
3.	Excavation & Civil Works	8
3.1	Excavation	8
3.2	Piling	9
3.3	Batching Plant Operation	9
3.4	Mobile Plant	10
3.5	Concrete Vibrators	11
3.6	Concrete Mixers	11
4.	Welding & Gas Cutting Safety (Hot Work)	11
5.	Lifting & Rigging Safety	13
5.1	Cranes & Hoisting Equipment	15
6.	Demolition Work	20
7.	T&Ps General	21
8.	Chemical Handling	21
9.	Electrical Safety	21
10.	Use Of Hand Tools And Power-Operated Tools	25
11.	Start Up, Commissioning And Testing:	27
12.	Fire Safety	27
13.	Painting	28
14.	Hazardous Energy" Control Procedure/ Lockout/Tagout (LOTO)	30
15.	Risk Assessment	37
16.	HSE Preparedness For Adverse Climates And Weather	38
16.1	Summer	38
16.2	Monsoon	39
16.3	Emergency Weather Conditions	41
16.4	Prevention Of Covid-19 At Project Site & Labor Colony	42
16.5	Noise Mitigation	44

General

The philosophy of hierarchy of controls as below shall be followed

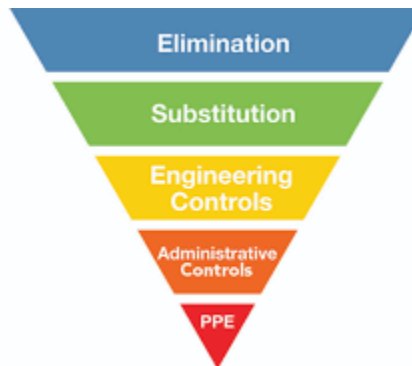

Fig. 1.1

It shall be ensured that there are multiple protections against any accident/ incident. For example, for height work there shall be safe platforms and walkways, Safety Nets and Lifelines for hooking double lanyard Safety harness by workers.

Monitoring and modifying worker behavior shall be part of ensuring safety. All personnel should be competent and trained for the job

Brief Safety guidelines for various hazardous activities are indicated below, besides the mandatory requirements based on Hazard Identification studies, HSE Procedures, Operational Control Procedures, Work Permits, applicable Indian Standard Codes and other provisions detailed in this document. Constant supervision at all times to be maintained by Execution & Safety Team to ensure implementation of these provisions.

1. WORK AT HEIGHT:

- a. All work at height above 2 meter above ground level without complete platforms, handrails and other related fall protection shall require a work permit in the prescribed form. This shall require approval by the competent authority. The HSE officer of sub-contractors shall follow the checklist religiously by physically verifying the condition of the work area before recommending for approval.
- b. Prior to the start of work at elevation, the HSE Officer involved with the work must meet the work supervisor to review the scope of work, and must review all the possible fall hazards and effective safety responses. The evaluation / analysis must be documented and kept on file and on site by the HSE Officer.
- c. Whenever a fall hazard or other exposure exists for working at heights more than 2.0m/6ft, the nature and scope of work will be evaluated for conditions and environmental factors before selecting the appropriate fall protection system (active, passive or a combination of measures, as appropriate).
- d. All Engineering and Administrative Controls including barricading, safe platform, Safety Nets etc. shall be made available at work location. Under no circumstances, there shall be total reliance on PPEs only
- e. **Safety Nets**
 - i. Contractor shall maintain sufficient stock of Safety Nets for deployment
 - ii. Safety Nets as per IS: 11057:1984 should be used extensively for prevention / arrest men and materials falling from height.
 - iii. The safety nets shall be fire resistant, duly tested and shall be of ISI marked.

- iv. Safety Nets shall be deployed below all platforms where height work is envisaged. Duration of work, delay shall be no excuses for non-installation of Safety Net
- f. Reaching beyond barricaded area without lifeline support, moving with support of bracings, walking on beams without support, jumping from one level to another, throwing objects and taking shortcut must be discouraged.
- g. Monkey Ladder shall be fitted with cages. Rope ladder should be discouraged.
- h. In case of pipe-rack, persons should not walk on pipes and walk on platforms only.
- i. In case of roof work, walking ladder/ platform should be provided along with lifeline and/ or fall arrestor.
- j. For chimney or structure painting, both hanging platform and men should be anchored separately to a firm structure along with separate fall arrestor.
- k. The procedures for the safety response to identified fall hazards developed and rescue plans must be reviewed with all individuals exposed to the hazards.
- l. The HSE Officer must establish an inspection process of fall protection systems. Some equipment requires documented inspections by its manufacture on a regular schedule. Such equipment must have evidence of the inspection and re-certification process on it. This information must be reviewed before the equipment is actually used. Individuals must visually inspect the fall protection equipment before each use. Failure to complete this inspection process could result in serious injury or death.
- m. Immediately remove from service any fall protection equipment that is identified as defective, damaged, or has been subjected to an impact. Damaged fall protective equipment must be destroyed to prevent re-use and not be discarded into trash containers, as the worn or damaged equipment could be unintentionally re-used.
- n. Aerial lifting devices, excluding scissor lifts require the use of full body harnesses and lanyards in any elevated position.
- o. Where Height related works are applicable then rescue team (consist of 5- 10 person) shall be identified and trained for potential rescue.

1.1 Personnel fall protection system must include:

a. Safety Harness

All height workers must use Full Body Safety harness with double lanyards with shock absorber (only). The primary lanyard is never unhooked until the secondary lanyard is secure. The design of the working platform should be such that under no circumstances, worker should have both lanyards unhooked while at height.

b. Lanyard

- i. The type of work and the environment conditions determine lanyard and lifeline selection. If welding, chemical cleaning that may damage lanyards, connectors or lifelines, sandblasting, etc., either protect the components or use more appropriate type of system.
- ii. Lanyards and lifelines must incorporate, or be used with, an appropriate deceleration (shock absorbing) device. Deceleration devices include rope grabs, rip-stitch lanyards, specially woven lanyards, tearing, or deforming lanyards, automatic self-retracting lifelines and lanyards which dissipate or limit the energy imposed on the employee during fall arrest.
- iii. Once in use, the system's effectiveness is to be monitored. In some cases, a program for cleaning and maintaining the system may be necessary. Lanyard and lifelines must use locking snap hooks only and under

no circumstances must two lanyard snap hooks be connected.

c. Lifeline

All lifelines in general are to be made of min 12mm dia. steel rope (plastic coated) and tied to columns with 3 clamps at each end. Wherever columns are not available to tie the lifelines, the vertical posts as per the design below are to be provided after carrying out drop load test initially. A load of 240kg to be dropped off the mid-point of lifeline in this test.

d. Lifeline Post

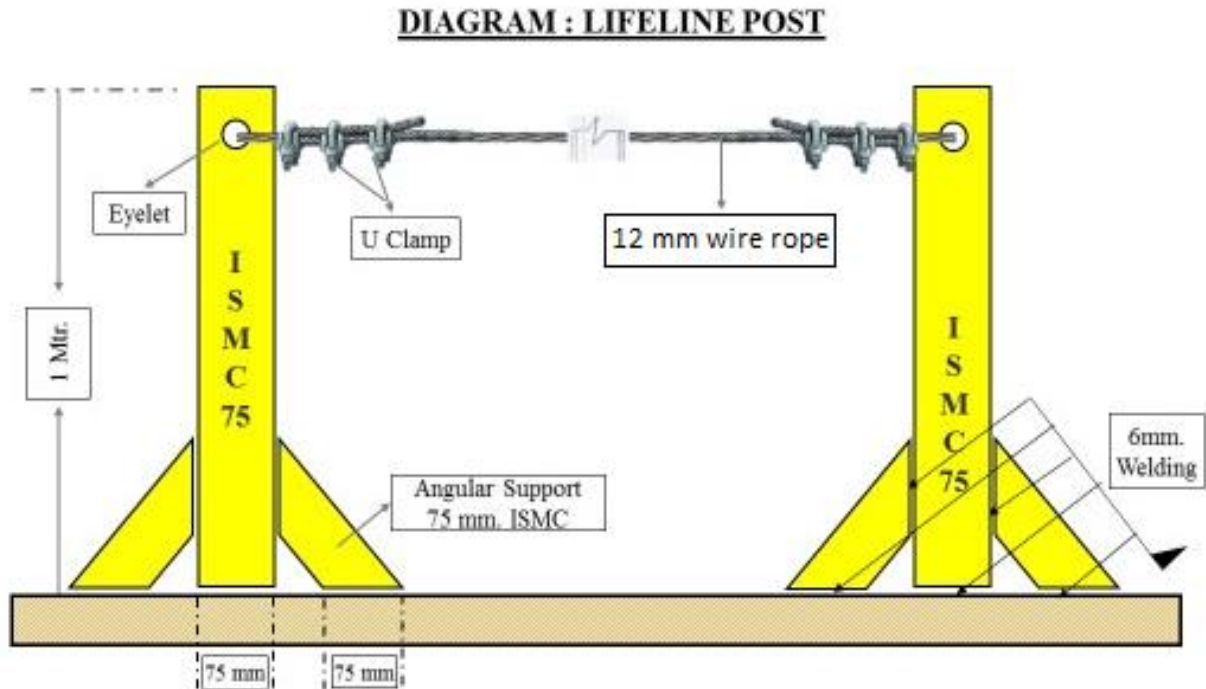

Fig. 2.1 Lifeline Post

- i. The support at vertical post shall be fixed at end-to-end (welded/ bolted). The maximum length of one end to another end shall be 6 meters
- ii. If the length of a lifeline is more than 6 meters, then intermediate vertical post(s) are to be used. Such intermediate post(s) will act as supports and the lifeline rope should simply pass through the eyelets (holes) of such supports without being anchored
- iii. The lifeline need not be wrapped / clamped to any intermediate post
- iv. Such intermediate posts must be used at an interval of every 6 meters
- v. The post(s) in which the original lifeline is to be installed should be capable of sustaining a tensile stress of 2268 Kgs.
- vi. In a horizontal lifeline installation, maximum allowable sagging is 500-600 mm
- vii. For a single spun lifeline, no more than 3(Three Nos.) persons are allowed to work; for more than two workers, another lifeline should be installed
- viii. Horizontal lifeline should be so installed that it does not impede safe movement of workers
- ix. All the installation work must be carried out by competent person with adequate knowledge

1.2 Working Platform

- a. Working platforms, gangways and stairways shall be so constructed that they do not sag unduly or unequally and if the height of the platform gangways provided is more than 3.6 m above ground level or

floor level, they shall be closely boarded and shall have adequate width, which shall not be less than 750 mm and be suitably fenced.

b. Precautions against the fall of Materials, Persons and Collapse of Structures:

- i. Every opening in the floor or a building or in a working platform shall be suitably barricaded to prevent the fall of persons by providing suitable fencing or railing whose minimum height shall be 90 cm.
- ii. Adequate precautions should be taken such as the provision of fencing, or barriers to protect any person who might be injured by the fall of materials, or tools or equipment being raised or lowered. Hard barricading shall be made at such places made of scaffolding pipe & clamps covered with reflective net. Cradle may be used for lifting materials - however this shall be made of MS angles and flats only and duly certified by the HSE officer. Operators may also use designed containers for lifting small tools.
- iii. Guardrails (including scaffolding) erected over/adjacent working areas must have the guardrails screened (opening < 0.5), to prevent material from falling outside the platform/decking.
- iv. Guardrails must be able to withstand a 200-pound force exerted in any one direction.
- v. Where necessary to prevent danger, guys, stays or supports should be used or other effective precautions should be taken to prevent the collapse of structures or parts of structures that are being erected, maintained, repaired, dismantled or demolished.
- vi. All openings through which workers are liable to fall should be kept effectively covered or fenced and indicated in the most appropriate manner.
- vii. Guardrails and toe-board/barricades and sound platform conforming to IS: 4912-1978 and other Indian laws and regulations as depicted below should be provided.

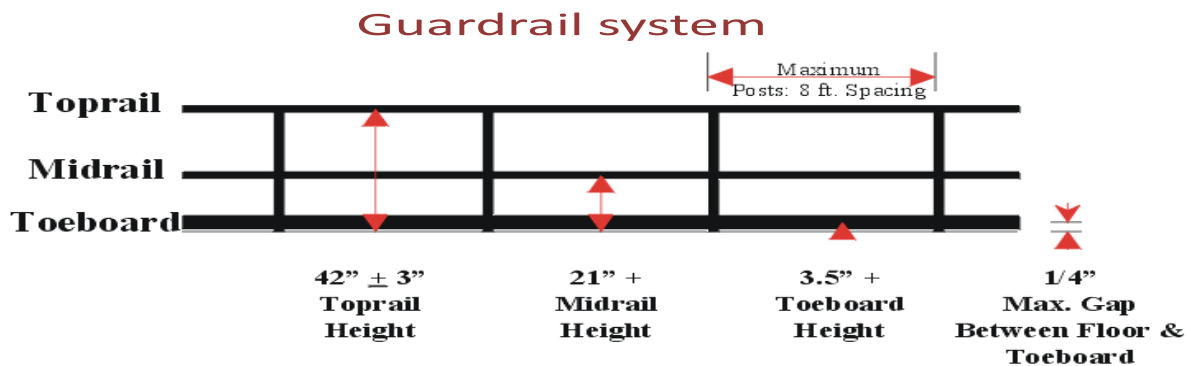

Fig. 2.2 Guard Rail System

- viii. Guardrails shall be provided to protect workers from falling from elevated work places. The rails are generally made of MS pipes of suitable dia. Rebar shall not be used for any handrails, ladder or cover purpose. Wherever the guard-rails and toe-boards cannot be provided:
 - a. adequate safety nets or safety sheets shall be erected and maintained; or
 - b. adequate safety harnesses shall be provided and used and / or
 - c. adequate fall arrestor shall be provided and used.

As mentioned under PPE clause, all these PPEs shall be defect free and regularly inspected for any defect. The full body safety harness shall have double lanyard only with max 1.8m length.

- ix. The monkey ladders shall have sufficient fall arrestors. Adequate lifelines of 8mm steel wire rope shall be provided across the work area.
- x. The HSE officer shall recommend appropriate PPEs after analyzing hazards and risks involved.

1.3 Scaffolding

All scaffolds shall be conformant to the relevant standards including IS 3696 and IS 4014 as applicable. A sketch of the scaffolds proposed to be used shall be prepared and approval of the BHEL Engineer obtained prior to construction / use. Only cup lock type scaffoldings will be allowed in site. Where cup lock type scaffolding arrangement is not feasible by the virtue of the location, in that case only pipe and clamp type scaffolding will be allowed.

- a. The scaffolding work must be carried out by a competent person, who shall train the scaffold users on safety aspects
- b. All scaffolds shall be erected / dismantled by scaffolding crew under direct supervision of competent scaffolding supervisors.
- c. All scaffolds shall be capable of supporting 4 times maximum intended load and erected on sound, rigid footing, capable of carrying the maximum intended load without settling or displacement. Bamboo scaffolding is not permitted for use on site.
- d. Each employee on the scaffold shall use an approved safety harness attached to an independent lifeline. The lifeline is to be securely attached to substantial members of the structure (not the scaffold itself) or to securely rigged lines, which shall safely suspend a worker in event of a fall.
- e. Guard rails and toe boards shall be installed on all open sides and ends of platforms more than (2) meters above ground or floor
- f. Scaffold planks must be at least 5 cm x 25 cm (2" x 10") full thickness lumber scaffold grade or better.
- g. Scaffold planks shall not span distances greater than 2.5 meters (8 feet).
- h. Scaffold planks shall extend over end supports not less than 6 inches nor more than 12 inches and be secured to the scaffold. Scaffolding and accessories with defective parts shall be immediately repaired or replaced.
- i. All scaffolding must be a minimum of two planks wide. No one may work from a single plank.
- j. Scaffold planks must be inspected before use. Planks that have been damaged must be removed from the site.
- k. Access ladders must be provided for each scaffold. Climbing the end frames is prohibited unless the design incorporates an approved ladder.
- l. Adequate mudsills or other rigid footing capable of withstanding the maximum intended load must be provided.
- m. Scaffolds more the 6 meters (20 feet) in height must be tied to the building or structure at intervals which do not exceed 4 meters (13 feet) vertically and 6 meters (20 feet) horizontally.
- n. Do not overload scaffolds. Material should be brought up as needed. Scaffolding must not be loaded in excess of its rated capacity.
- o. Barrels, boxes, kegs, blocks or similar unstable object must never be used as work platforms or to support scaffold.
- p. Where persons must work under or pass under a scaffold then a 18 gauge wire mesh screen must be installed between the toe board and guard rail.
- q. Employees exposed to overhead hazards while working on a scaffold will be protected by 5 cm (2") thick planks.
- r. Wooden/bamboo ladders shall not be allowed at any cost. Ladder's rungs shall be fitted /welded

properly. Before every use the rungs should be checked for safe use.

- s. Wooden scaffolds shall not be used in areas where fire / fire products are expected
- t. Ropes made of jute / Plastic and other fire prone material shall not be used to tie up scaffolding components together
- u. The platform should have permanent hand rail and mid rail with Toe board without fail.
- v. All platforms are to be tightly planked for the full width of the scaffold, except as may be necessary for entrance openings. Platforms shall be secured in place.
- w. On suspension scaffolds designed for a working load of 500 pounds, no more than two workers are permitted to work on the scaffold simultaneously. On suspension scaffolds with a working load of 750 pounds, no more than three workers are permitted on the scaffold simultaneously.
- x. **Requirements for different types of Scaffolds:**

A. Suspended Scaffold

- i. Suspended scaffolds are platforms suspended by ropes, or other non-rigid means, from an overhead structure.
- ii. Requirements for use are to be preapproved by HSE Head, under a specific Permit to Work.

B. Rolling Scaffolds

- i. The height of rolling scaffolds shall not exceed three times the minimum base dimension.
- ii. The minimum base dimension of rolling scaffold will be 1.25 meters (4 feet).
- iii. Adequate help must be provided when moving a rolling scaffold.
- iv. Secure or remove all loose materials, equipment and tools before moving a rolling scaffold.
- v. No one is permitted to ride a rolling scaffold when it is being moved. Castor brakes must be locked-on when the scaffold is not being moved.

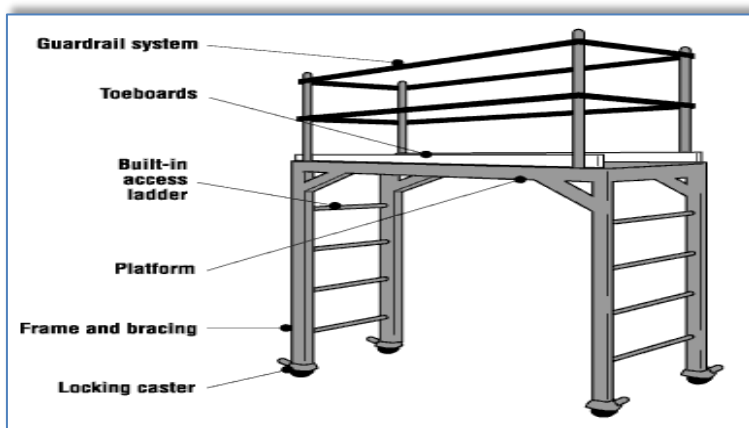

Rolling Scaffold

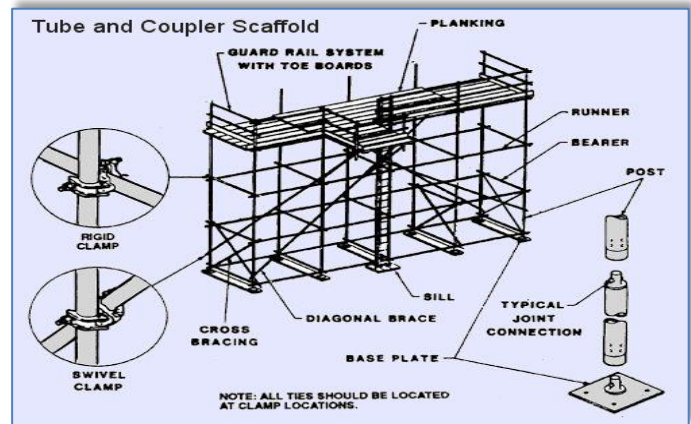

Tube & Coupler Scaffold

Fig. 2.3 Types of Scaffolds

1.4 Ladder Safety

A sketch of the ladders proposed to be used shall be prepared and approval of the BHEL Engineer obtained prior to construction / use

a. Safe Use of Ladders:

- i. Fall protection is required when working on a ladder above 2 meters and when climbing above nearby guardrails.

- ii. Ladders must be inspected prior to use and by a competent person quarterly, with documentation.
- iii. Use portable ladders for height up to 4 M only
- iv. Provide fixed ladders for height above 4 M
- v. Place the ladder at an angle of 75 degrees (approx.) from the horizontal (1:4)
- vi. Extend ladder at least 1 M above the top landing
- vii. Secure top and bottom of the ladder firmly to prevent displacement- anti skid lining at the bottom
- viii. Ensure that the width of the ladder is not less than 300 mm and distance between rungs is not more than 300 mm
- ix. Provide landings of minimum size 600 x 600 mm at intervals not more than 6 M for fixed ladders. Check the ladders daily for any defects
- x. Ensure that the areas around base and top of the ladder are clear. Getting on and off the ladder is more hazardous than using it. Use a mudsill if the ladder is to rest on soft, loose or rough soil
- xi. Do not use ladders of conducting material near power lines, and only use ladders near power line or other energize system with exposed parts if they are confirmed locked-out and de-energized.
- xii. Stand no higher than the fourth rung from the top for carrying out any job standing on a ladder.
- xiii. Never reach out from a ladder to perform work where your belt buckle protrudes past the ladder rung.
- xiv. Always face the ladder while climbing up or down
- xv. Maintain three-point contact while climbing up or down a ladder i.e. two hands and one foot or two feet and one hand on the ladder at all the times.
- xvi. Avoid climbing up or down a ladder while carrying anything in hands. Lift tools, equipment and materials with a rope.
- xvii. Work from portable and extension ladders near guardrail where fall expose exists over the guardrail regardless of height, and above 2.0 mtr. heights from the working/walking surface will require the use of personal fall arrest equipment

2. EXCAVATION & CIVIL WORKS

All safety precautions shall be taken for foundation and other excavation marks as per IS-3764.

2.1 Excavation

The following safety measures are to be ensured before and during excavation:

- a. All Excavation activities more than with depth of 1.22 meter or more shall require and Excavation Work Permit
- b. Check for underground utilities like electrical / telephone cables, sewage, water lines and proper care has to be exercised to protect and prevent damage to it.
- c. Electrical cables and service lines to be identified using cable detector/locator device before carrying out the excavation work
- d. Proper and adequate slope is maintained while excavating
- e. Adequate shoring or sheeting is done wherever require to prevent soil sliding
- f. Safe access through ladder or steps for exit & entry to excavation
- g. No material /excavated soil is kept within one meter from the edge
- h. Safe way is planned and provided for movement of HEM /transport equipment near excavation
- i. Safety helmet and shoes/gum boots are provided and worn by the workmen at excavation works

- j. Dewatering arrangement is made where water seepage is prevailed.
- k. Stop blocks are provided to avoid vehicles reversing into the excavated trenches
- l. Danger signs /Caution boards are displayed at work spot
- m. Hard Barricading is provided at excavated pits. It should be made of scaffolding pipe and clamp with reflective nets.
- n. All Excavated area of depth 3mtr or more is to be hard barricaded with pipe.

Soil Type	Height/Depth ratio	Slope Angle
Stable Rock	Vertical	90 deg.
Type A	¾ : 1	53 deg.
Type B	1 : 1	45 deg.
Type C	1½ : 1	34 deg.

Determining Soil Type		
Type	Description	Examples
A	Cohesive soils with an unconfined compressive strength of 1.5 tons per square foot or greater.	Clay, silty clay, sandy clay, clay loam and in some cases: silty clay loam and sandy clay loam.
B	Cohesive soils with unconfined compressive strength greater than 0.5 tsf but less than 1.5 tsf.	Angular gravel (similar to crushed rock), silt, silt loam, sandy loam and, in some cases silty clay loam and sandy clay loam.
C	Cohesive soils with unconfined compressive strength greater than 0.5 tsf or less.	Granular soils such as gravel, sand and loamy sand; submerged soil or soil from which water is freely seeping; submerged rock that is not stable.

Fig. 3.1 Excavation Reference

2.2 Piling

Ensure the following precautionary measures before starting piling works:

- a. Inspection of piling equipment by responsible person for its condition before initiating piling operation.
- b. Checklist and OCP for piling to be prepared using manufacturer’s instructions and used
- c. Testing and its certification wire rope, slings, D-shackles, chain pulley blocks using in the process of piling work by competent person
- d. Adequate support and secured foundation of the piling equipment to avoid toppling
- e. Hoses should be lashed and adequately secured
- f. Proper work platform is to be provided on piling frame
- g. Safe work procedures and close supervision to prevent unsafe acts of operators/any unsafe conditions that may arise
- h. Only experienced and trained operators are engaged for the piling operation
- i. Provision of Personal Protective Equipment (PPE) like safety shoes/gumshoes/safety helmet/safety belt etc. and its use by their workmen.
- j. Special care and precautions If work is near electrical live cables/ electrical equipment
- k. Cordoning of work area to prevent un authorized entry
- l. Guarding of revolving parts
- m. Specific measures to prevent over turning of pile driver/missing of hammer/ hammer movement out of range

2.3 Batching Plant Operation

Following Safety considerations for batching plant are to be ensured:

- 1. Modern type batching plant should be used in which all the moving parts are protected and emergency

and safety features are incorporated.

2. Installation of external Electric moto-vibrators in the feeding hopper of all batching plants to reduce human intervention.
3. Installation of safety devices like pull-chord on both the sides of conveyor for stopping the conveyor in emergency
4. Workers carrying cement / sand to be given appropriate PPEs like respiratory masks & gloves.
5. Conveyor belt/rotating parts must be guarded properly.
6. Safety awareness shall be inculcated in workmen about the risk involved in rotating parts.
7. The agency shall ensure to erect the batching plant as per drawing including installation of all safety devices as provided by manufacturer and witnessed by BHEL Engineer in charge before starting of machine in future.
8. Safety audit to also focus on Batching plant.
9. The site shall impose penalty on the agency who has violated the safety norms as per contract.

2.4 Mobile Plant

Mobile plant includes tractors, trailers, dumpers, excavators, bulldozers, road rollers etc. for earthmoving purpose and concrete mixers, concrete transit mixtures, concrete pumps etc for concreting purpose. Due to the very nature of their function and movement in difficult terrains, congested areas, working in tandem with manual work and other operations the danger is inherent.

Automatic reverse camera with reverse horn connected with reverse gear is compulsory for all moving machineries.

Following Safety measures to be ensured for Mobile Plant:

- a. Where movement around site is involved, routes should be planned, obstruction free and well maintained
- b. Observe specified speed limits
- c. Operating personnel should be aware of associated risks and its preventive measures
- d. Only experienced, trained and authorized persons with valid license (wherever applicable) should operate the mobile equipment/vehicles
- e. Provide and use Warning lights and reverse horn for cautioning the people around
- f. Operation should be on level and stable ground with adequate working clearance.
- g. Loading of out riggers/stabilizers should be well within safe ground bearing capacity
- h. No person should be on equipment or vehicle during loading and unloading of material
- i. Operators should be protected by warning barriers or switching off power when working in close proximity of overhead power lines
- j. The equipment /vehicles should be well maintained and provided with effective brake system and other safety devices (wherever require)
- k. Rotating parts of equipment should be adequately guarded
- l. Provide necessary personal protective appliances and ensure its use by the operating personnel Ensure effective measures at source to control harmful emissions, dust, fumes contaminating atmosphere and cause health hazards to the operators and people in the vicinity.
- m. No overloading/over stressing of vehicles/plant is allowed
- n. Hoses, pipes, receivers, gauges and valves involved in carrying out hydraulic fluid/ compressed air should be checked for leaks and tested prior to operation.

- o. Adequate safe clearance for swing and movement is to be judged during operation of Concrete mixer
- p. Setting of machines on firm and level ground with wheel locked to prevent movement of machine
- q. Proper instructions and Special precautions are to be ensured to prevent entry in to the danger zone of projectile of bucket while dropping bucket
- r. Operator leaving work spot should ensure that the equipment/vehicle is kept in neutral position and place on firm and level ground.
- s. The hand brake should be kept in position and block road wheels as additional safety measure
- t. Blades/buckets should be kept low while moving
- u. The dozer blades should not be used as brakes except in emergency
- v. The ground should be examined for its bearing capacity and general safety especially when operating road roller at the edges of slopes, embankments.
- w. The roller should not be moved downhill with the engine out of gear
- x. If operating near excavations the following precautionary measures are to be ensured
- y. Barricading, edge protection to prevent fall of persons/vehicles over running while reversing etc.
- z. Suitable support system and adequate allowance to avoid the danger of side collapsing
- aa. Experienced signaller /attendant should be always accompanied with operator/driver for proper direction /signal and also to caution others in the working Zone during operation of mobile plant

2.5 Concrete Vibrators

- a. Revolving parts/belt drives should be adequately guarded and Vibrating unit shall be completely enclosed and have suitable overload relays and effectively earthed
- b. Ensure sufficient length of cable to the Vibrator.
- c. Ensure electric starters and other accessories are firmly fixed adequately supported
- d. Ensure locking of needle load while inserting needle in to the vibrator,
- e. Ensure periodical lubrication and maintenance

2.6 Concrete Mixers

- a. Setting of machines on firm and level ground with wheel locked to prevent movement of machine
- b. Proper instructions and Special precautions are to be ensured to prevent entry in to the danger zone of projectile of bucket while dropping bucket

3. WELDING & GAS CUTTING SAFETY (HOT WORK)

- a. All Hot Work shall require a Hot Work Permit
- b. Inbuilt Voltage Reduction Device (VRD) equipped arc welding machine will only be allowed for work.
- c. There shall be flash-back arrestors conforming to IS-11006 at both cylinder and burner ends. Damaged tube and regulators must be immediately replaced.
- d. All safety precautions shall be taken for welding and cutting operations as per IS-818.
- e. When possible, items to be welded, cut, heated, etc. shall be moved to a safe location free of combustible or flammable material. If this is not possible, then all combustibles/ flammables that can be removed from the area shall be removed within a 35-foot circumference and a positive means of confining arcs and sparks generated by the process shall be ensured and additional person(s) shall be stationed as fire-watch for the area(s) still exposed, along with obtaining the Hot Work Permit as applicable.
- f. Appropriate fire-fighting equipment is to be available in close proximity of any welding and gas cutting operations at all times suitable for the type of Fire.

- g. Drums, tanks, and similar containers that have contained flammable or toxic material shall not be welded, cut, or heated until they have been made safe by water filling, thorough cleansing or similar accepted practices. The container shall also be ventilated during the welding, cutting, or heating process.
- h. Proper ventilation is required for any welding or torch operations performed in a confined space.
- i. Any welding or gas cutting operations performed on metals of toxic compounds or coating such as zinc, stainless steel, lead, cadmium, chromium, and beryllium shall be properly ventilated and/or proper respiratory protection shall be worn by any person that could be exposed to fumes, vapors, and gasses created by the welding and gas cutting processes.
- j. Wherever it is practical, all arc welding operations shall be shielded to prevent direct light rays or sparks from contacting persons in the vicinity or from reaching areas normally used to travel through or into the vicinity. Where this is not practical, persons who shall be in the area are to use proper eye and skin protection. Other persons who are not participating in the welding or gas cutting operations are not to be allowed into the hazard zone.
- k. Welders and other employees who are exposed to arc welding radiation shall wear suitable clothing and protective apparel to prevent burns and other types of ultraviolet radiation damage to the skin.
- l. Arc welding machines shall be shut down when being moved or when they are not in continuous use. Electrode holders left unattended shall have electrodes removed and shall not be left where they might contact employees or conducting objects.
- m. Arc welding power supply cable shall be of proper rating and material, e.g. copper.
- n. Welders shall guard against allowing materials adjacent to or behind them to reflect radiation back toward them or towards others in the area. Reflected radiation can cause skin burns and eye flash burns.
- o. Valve caps shall be in place when cylinders are not in use. Valve caps shall never be used for lifting the cylinder vertically.
- p. Torches shall only be lit by approved strikers; never with matches, cigarette lighters, or hot-work.
- q. **Splatter / Slag Collector:**

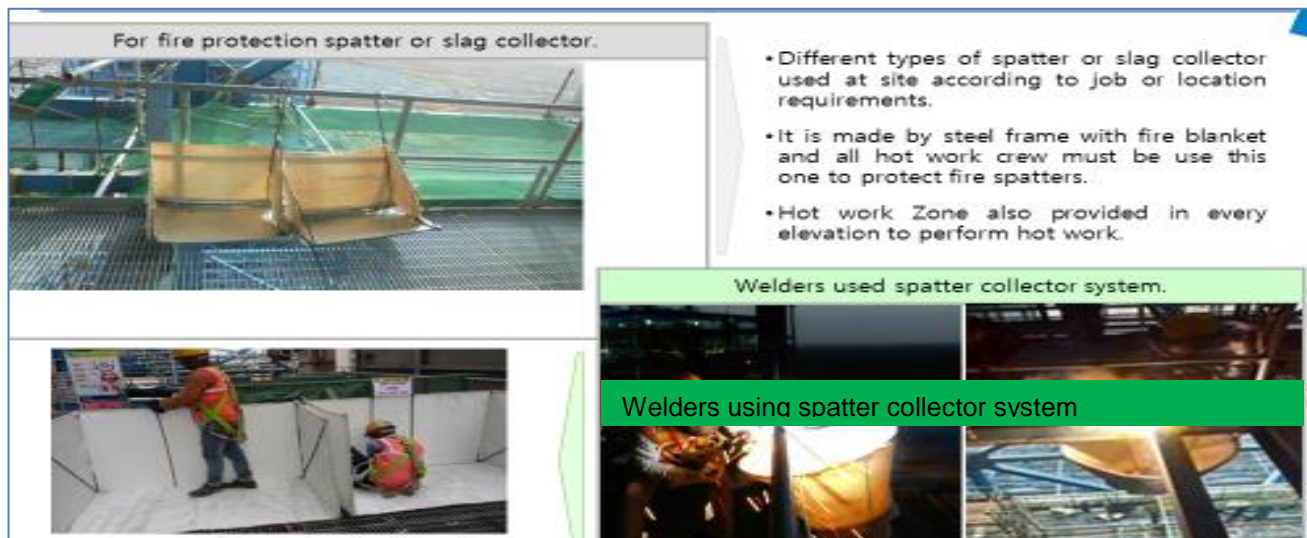

Fig. 4.1 Splatter / Slag Collector

While carrying out job at height, the sparks or molten slag shall be prevented from falling down by putting a fire-resistant (non-asbestos) sheet or pattrer/ slag collector or even MS Sheet. The passage of falling sparks

or molten slag shall be barricaded till ground floor and any cable/ tubes/ any other objects interfering in the passages hall either be removed or covered with Fire-resistant sheet or MS Sheet.

r. COMPRESSED GAS

- i. All cylinder valves shall be closed when any work is finished and when any Cylinders are empty or being moved. Valve protection caps shall be placed and secured properly before gas cylinders are transported, moved or stored.
- ii. Compressed gas cylinders shall be secured in an upright position with chain or appropriate means during storage & use. However, a trolley shall be used for transportation.
- iii. Compressed gas cylinders shall always be secured from tipping or falling, whether in use, in storage or in transit. The cylinders shall always be secured upright, except during times when actually being hoisted or carried.
- iv. When cylinders are transported by powered vehicle they shall be secured in a vertical position.
- v. Regulators shall be removed when cylinders are not in use or are in transit, unless the cylinder is firmly secured on a special carrier designed for this purpose.
- vi. Gas cylinders are not allowed to be used in man-basket when occupied.
- vii. Cylinders containing oxygen or fuel gasses shall not be taken into confined spaces.
- viii. Oxygen cylinders shall be stored a minimum of 6 meters from fuel gas cylinders or shall have an approved firewall between them.
- ix. All cylinders shall be kept at a safe distance from welding or cutting operations or shielded from arc/sparks / slag.
- x. All cylinders shall be placed where they cannot become part of the electrical circuit.
- xi. Oxygen and acetylene shall not be stored together. Oxygen must be separated from acetylene (or ANY fuel gas) or combustible material by at least 20ft or a barrier with a 30-minute fire resistance rating.
- xii. All Cylinders should be stored upright in a designated area with labels for the type of gas. All applicable precautions to be ensured during storage
- xiii. Oxygen and fuel gas regulators, hoses and associated equipment shall not be altered and shall be in proper working order while in use.
- xiv. Compressed air can be extremely dangerous if allowed to penetrate the skin. As such, the use of compressed air to clean off yourself or other workers shall be strictly prohibited.
- xv. All gas cylinders shall be stored in upright position. Suitable trolley shall be used for cylinder movement, the design of which shall be submitted to BHEL Engineer for approval.
- xvi. No of cylinders shall not exceed the specified quantity as per OCP
- xvii. Cylinders shall be moved by tilting and rolling them on their bottom edges. They shall not be intentionally dragged, struck or permitted to strike each other violently.
- xviii. All cylinder should be kept only in cylinder trolley.
- xix. Cylinder shall be transported in upright vertical position by suitable mean.

4. LIFTING & RIGGING SAFETY

- a. All Heavy / Complex Lifting operations as defined in Clause 6.12 shall require a Lifting Work Permit. A written rigging procedure and plan must be prepared for all individual heavy/ complex lifting operations.

- b. All the cranes and lifting tools & tackles shall be inspected on daily / weekly basis as well as monthly by expert as per applicable formats.
- c. In addition, inspection / certification as mandated by law shall be carried out wherein these shall be tested and certificates of fitness shall be obtained from 3rd party State Govt. approved competent agency before deploying at site and later periodically. BHEL shall be given advance intimation of any such inspections
- d. The last date of Third-Party Inspection and the next Due date shall be conspicuously displayed on all cranes. A copy of certificate shall be pasted on operator's cabin of all the lifting equipment.
- e. Specifically designed heavy steel plates lifting clamps shall be used for lifting heavy metal sheets. Manmade lifting clamp chapa shall not be used for lifting/shifting of plates.
- f. Following requirements shall be mandatorily followed, wherever applicable:
 - i. The manufacturer's instruction for maintenance shall also be followed. All safety measures shall be followed.
 - ii. All tools tackles, lifting appliances; material-handling equipment etc. used by the subcontractor shall be of safe design and construction.
 - iii. The operators, slingers and signalers shall be qualified as per IS 13367 (part-1):2003 "Safe use of cranes- code of practices".
 - iv. There shall be a person responsible for co-ordination among cranes where multiple cranes are used, and lifting over load chart of the crane to be avoided.
 - v. Mobile phone should be banned for crane operator and lifting operation. Only walkie talkie shall be allowed in rigging/Lifting purpose.
- g. Lifts/Movements between 5 Tons and 20 Tons:
 - i. Shall include a rigging plan, detailing schematic representation of the handling/lifting operations that must be included on the Method Statement.
 - ii. When performing similar lifts of identical items, only one rigging plan need be prepared, provided each of the lifts can be performed in accordance with the rigging plan.
- h. Lifts/Movements Less Than 5 Tons:
 - i. An equipment rigging plan is not required for lifts less than 5 tons, safety measures are covered in the JSA. This could change as per BHEL requirement

i. Personnel Lifts (Man-Basket / Jhoola):

The design of personnel man basket shall be submitted to BHEL Engineer for approval before use. Relevant permit (Height work & others as applicable) shall be completed prior to lifting any people, along with a rigging plan.

- i. A separate Lifeline / fall arrestor anchored to a fixed structure outside of Jhoola shall be provided for the workers inside the basket. All occupants of the basket shall have Safety Harnesses equipped with rope grabs, which are to be hooked to the vertical lifeline.
- ii. Man-basket shall be used where access through ladders or scaffolding is not feasible.
- iii. Man-baskets shall be designed and engineered by a manufacturer (job made man-baskets are not allowed, unless designed and tested by a certified engineer), and built robust with MS Angles and flats or plates or channels only.
- iv. Guard rails top and mid, must be in place and screened-in to avoid material from falling out of

- basket. The factor of safety shall be 200%.
- v. It shall have a door with double latches and shall open inside. Anchor points shall be identified within the man-basket.
 - vi. The man-basket shall be thoroughly inspected and load tested and a trial run performed without personnel before being put to job.
 - vii. It shall be treated as a lifting tool (T&P Item) and shall undergo same certification cycle and inspection as other lifting equipment.
 - viii. An additional sling of required lifting capacity shall be fixed the man-basket main lifting point and attached to the crane above the ball or block.
 - ix. While lifting man-basket, the crane shall maintain a uniform speed of lift without any swing.
 - x. Once man-basket reaches the destination, the lift brakes shall be locked as long as the basket
 - a. remains at that point. The same care shall be taken in its descent.
 - xi. As for hanging man-basket, the same shall be hung off a rigid structure with help U-shaped handle welded to man-basket. This shall be tested once in a year by a competent person.
 - xii. Use of Rebar steel for making and monkey-ladder must be avoided.

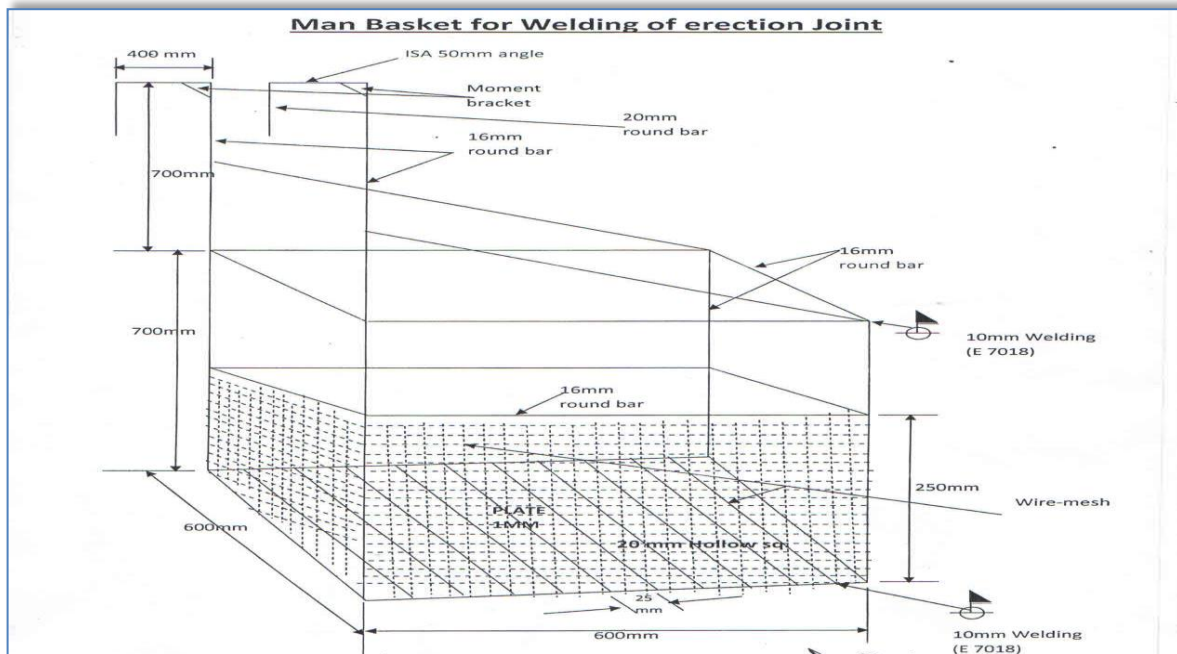

Fig. 5.1 Man Basket for Welding Erection Joint

4.1 Cranes & Hoisting Equipment:

This section provides the guidelines to ensure proper rigging and lifting activities are accomplished safely and in accordance with applicable specifications, codes, and regulations.

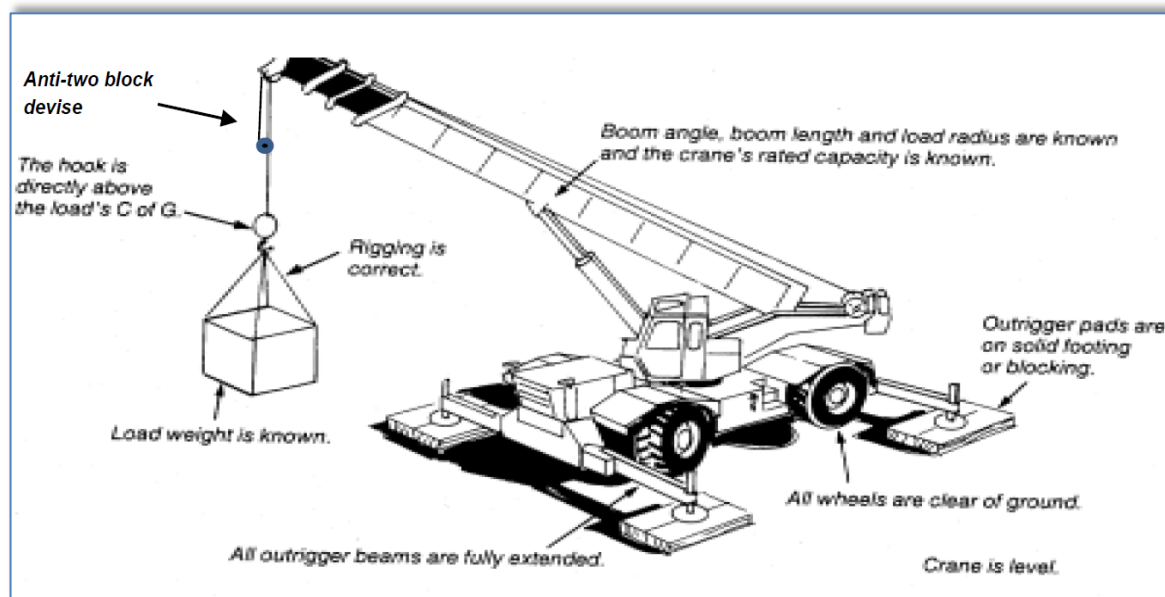

Fig. 5.2 Proper Crane Setup

- a. On every crane or piece of hoisting equipment notices of all rated load capacities, recommended operating speeds, and any hazard warnings or special instructions shall be conspicuously posted. All instructions and warning shall be visible from the equipment operator 's station.
- b. Cranes shall have an Anti-Two-block safety device installed
- c. All mobile cranes shall have overload and backup alarms, load angle indicators and limit switches
- d. All areas within swing radius of cranes that are potentially accessible by pedestrian, vehicular, or equipment movement shall be barricaded to prevent anyone or any vehicle or equipment from being struck by the crane or hoisting equipment, or its load(s).
- e. No part of the lifting equipment or its load shall be within the distance as specified in the Indian Electricity Act from an energized power line
- f. Cranes shall have annual certified third-party inspection and be inspected before use by the operator. Any defects shall be corrected before use. Logs of crane inspection shall be kept with the crane.
- g. Make certain that the rigging personnel, material, and equipment have the necessary capabilities for the job and are in safe condition.
- h. Communicate with person(s) directly responsible for accomplishing the work and / or work area to establish requirements/responsibilities and make certain that all preparatory work is complete.
- i. Mats/Pads must be used on all lifting equipment, equipped with out riggers.
- j. Pick and carry must have the load secured to the rig in front.
- k. Only BHEL Approved Plate Lifting Spreader Beam configuration shall be used (Sample in Fig. 11.3.5.3)
- l. Crane operators must follow the following:
 - i. Pass an annual Operator's Physical examination
 - ii. Carry a valid training certification card at all time while operating issued by the Govt. or other recognized institute.

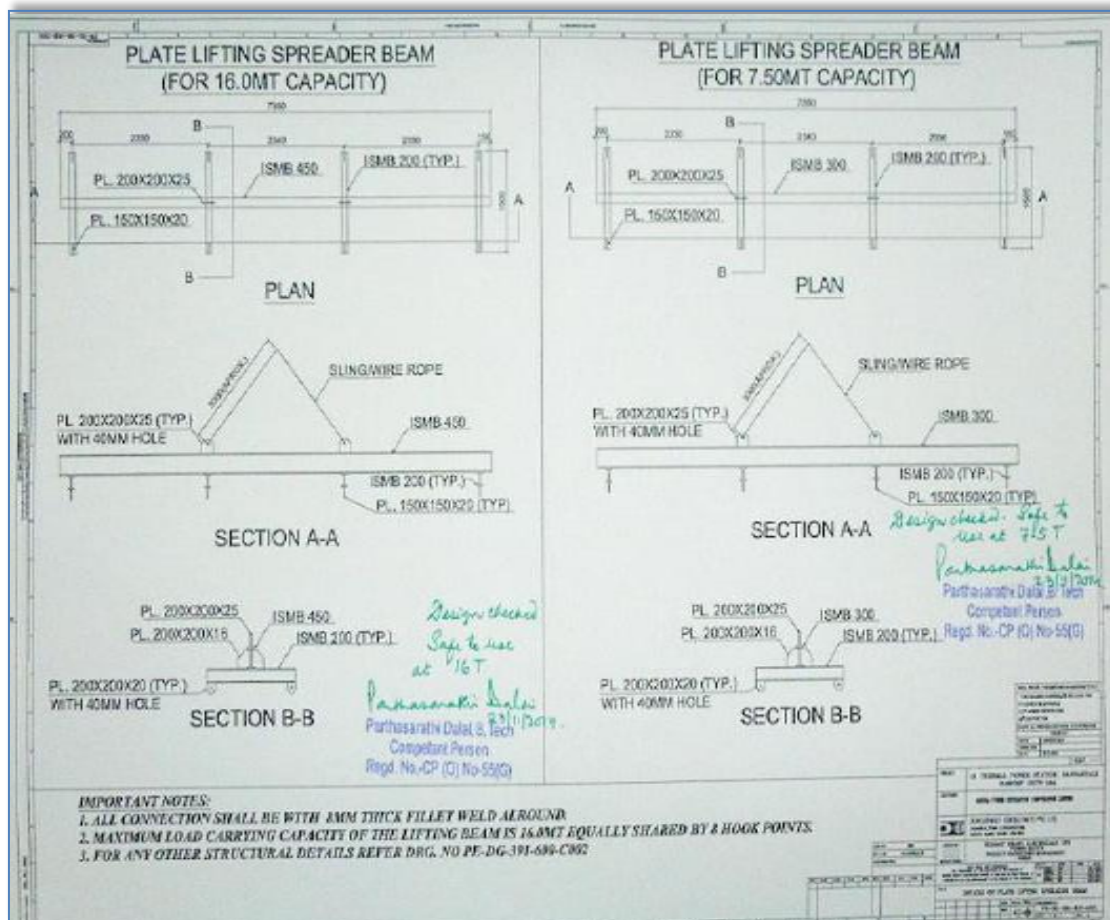

Fig. 5.3 Typical Plate Lifting Spreader Beam Configuration for 7.5 MT and 15 MT Loads

m. Safe Rigging Practices

- i. Review the planned operation and requirements with the operator and rigging crew.
- ii. Ensure a pre-lift meeting is conducted with crane operator, tagline operator, signal personnel, and Safety Manager.
- iii. Designate a qualified person from the rigging crew to observe clearance of the equipment and give timely warning for all operations where it is difficult for the operator to maintain the desired clearance by visual means.
- iv. Clear the lift area of all unnecessary personnel.
- v. Hydras shall only be allowed for loading & unloading works & shall not be allowed to move with load

n. Rules for Safe Rigging

- i. Use loops, thimbles and corner pads to prevent damage to slings when used around corners or on cutting edges.
- ii. Never allow wire rope to lie on the ground for any length of time or on rusty steel or near solvents, chemicals or corrosive substances.
- iii. Slings must not be pulled from between or under loads with load resting on the sling.
- iv. Keep all rope away from flame cutting or welding operations.
- v. Never use rope as sling material.
- vi. Never wrap a wire rope completely around a hook.

- vii. Do not bend wire rope near any attached fitting.
- viii. The sling must be selected to suite the most heavily loaded leg rather than the total weight when using multi-legged sling to lift loads in which one end is heavier than the other.
- ix. When using 3 and 4-legged sling configurations, any two legs must be capable of supporting the entire load.
- x. Where possible, wire rope choker hitches must include a shackle with the eye around the shackle pin to prevent breaking wires of the choke. The choker hitch must be “snugged down” prior to lifting, not after tension is applied.
- xi. Unless authorized by the hook manufacturer when more than two rope eyes are placed over a hook, install a shackle, pin resting in the hook, and place the rope eyes in the bowl of the shackle.
- xii. Properly rig all loads to prevent dislodgment of any part.
- xiii. Use guide ropes or tag lines to prevent the rotation or uncontrolled motion of the load when necessary.
- xiv. Loads must be safely landed and properly blocked before being unhooked and unslung. Tag lines must not be used in situations that jeopardize the safety of the lift.
- xv. Lifting beams must be plainly marked with their weight and designed working load and must only be used in the manner for which they were designed.
- xvi. The hoist rope or chain must never be wrapped around the load. The load must be attached to the hook by slings or other rigging devices that are adequate for the load being lifted.
- xvii. Multiple part lines must not be twisted around each other.
- xviii. The hook must be brought over the center of gravity of load before the lift is started.
- xix. If there has been a slack rope condition, determine that the rope is properly seated on the drum and in the sheaves prior to lifting.
- xx. Keep hands away from pinch points as the slack is being taken up.
- xxi. Leather gloves are recommended when handling wire rope.
- xxii. Avoid impact loading caused by sudden jerking when lifting or lowering. Lift the load gradually until the slack is eliminated.
- xxiii. Never ride on a load that is suspended.
- xxiv. Avoid allowing the load to be carried over the heads of any personnel.
- xxv. Never work under a suspended load until the load has been adequately supported from the floor and all conditions have been approved by the supervisor in charge of the operation.
- xxvi. Never leave a load suspended unless emergency evacuation is required.
- xxvii. Never make temporary repairs to sling.
- xxviii. The capacity of a sling is determined by its angle, construction, type of hitch and size.
- xxix. Never lift loads with one leg of a multi-leg sling until the unused legs are made secure.
- xxx. Never point load a hook unless it is especially designed and rated for such use.
- xxxi. Make certain that the load is broken free before lifting and that all legs are taking the load.
- xxxii. When using two or more slings on a load make certain all slings are made from the same materials.
- xxxiii. Lower the loads on to adequate blocking to prevent damage to the slings.
- xxxiv. Materials and equipment being hoisted must be loaded and secured to prevent any movement which could create a hazard in transit.

- xxxv. The weight of the hook, load block and any material handling devices must be included when determining crane capacity.
- xxxvi. Calculated weights cannot exceed load chart without written approval.
- xxxvii. Personnel must be completely clear of loads being picked up or set down by crane. Tag lines will be used to control the loads. Loads must not be touched by hand while placing/ moving.

o. Slings

The following are rules for safe use of synthetic slings:

- i. Synthetic slings must be marked to show the rated capacity for each type of hitch and type of web material.
- ii. Nylon web slings must not be used where fumes, vapors, sprays or mists or liquids of acids or phenolic are present. Web slings with aluminum fittings must apply in this category.
- iii. **Synthetic web slings must be removed from service and destroyed if any of the following conditions are present:**
 - a. Acid or caustic burns
 - b. Melting or charring of any part of the sling surface
 - c. Snags, punctures, tears or cuts
 - d. Broken stitches
 - e. Distortion of fittings
 - f. Synthetic web slings of polyester or nylon must not be used at or come in contact with temperatures in excess of 82°C
 - g. Polypropylene web slings must not be used at or come in contact with temperatures in excess of 93°C
 - h. Insulated hooks must be tested yearly to ensure insulation integrity to at least manufacturer's specifications.
- p. **Wire Rope Slings must be removed from service and destroyed if any of the following conditions are present:**
 - i. In (10) randomly distributed wires broken in one (1) rope lay, or five (5) broken wires in one (1) strand in one (1) rope lay.
 - ii. Wear or scraping of one-third the original diameter of outside wires.
 - iii. Kinking, crushing, bird caging or any other damage resulting in distortion of the wire rope structure such as:
 - iv. Evidence of heat damage.
 - v. End attachments that are cracked, deformed worn.
 - vi. Corrosion of the rope or end attachments.
- q. **Metal mesh slings must be immediately removed from service if any of the following conditions are present:**
 - i. A broken weld or broken brazed joint along the sling edge.
 - ii. Reduction in wire diameter of 25 percent due to abrasion or 15 percent due to corrosion.
 - iii. Lack of flexibility due to distortion or corrosion.
- r. **Requirements of Plate Clamps:**
 - i. The rated load of the plate clamp must be marked on the main structure.

- ii. Care must be taken to make certain the load is correctly distributed for the plate clamp being used.
- iii. Do not allow load or plate clamp to come into contact with any obstruction.
- iv. The plate clamp must not be used for side pulls or sliding the load.
- v. When lifting stainless steel or special alloys, ensure plate clamp is designed for use on the specific metal.

s. Signaling Practices:

- The "slinger" is responsible for attaching and detaching the load to and from the crane. He shall:
 - have received appropriate training on general safe lifting operations;
 - be capable of selecting lifting gears suitable for the loads;
 - liaise with the operator and direct the movement of the crane safely.
- The "signaller" is responsible for relaying the signal from the slinger to the crane operator. He shall:
 - have received appropriate training on general safe lifting operations;
 - be able to direct the movement of the crane and loads.

Suggested hand signals



Note: During the lifting operation, either the slinger or signaller shall communicate with the operator. Other communication methods (e.g., wireless walkie-talkies, telephones, etc.) may also be used.

Fig. 5.4 Recommended Signaling Practices

5. DEMOLITION WORK

Before any demolition work is commenced and also during the process of the work the following shall be ensured, besides using the Work Permit:

- a. All roads and open areas adjacent to the work site shall either be closed, suitably protected or restricted for movement
- b. No electric cable or apparatus which is liable to be a source of danger nor a cable or an apparatus used by the operator shall remain electrically charged.

- c. All practical steps shall be taken to prevent danger to persons employed from the risks of fire or explosion or flooding. No floor, roof or other part of the building shall be so overloaded with debris or materials as to render them unsafe.

6. T&PS GENERAL

- a. All T&Ps/ MMEs should be of reputed brand/appropriate quality & must have valid test /calibration certificates bearing endorsement from competent authority of BHEL.
- b. Subcontractor to also submit monthly reports of T&Ps deployed and validity test certificates to BHEL safety Officer as per the format/procedure of BHEL.
- c. Tagging and punching in all lifting tool is compulsory with SWL, sr. no. and due date.
- d. All T&Ps shall be inspected by authorized Third Party agency as per applicable frequency. BHEL shall be kept informed of any such scheduled inspection
- e. All T&Ps shall be internally inspected in each quarter and colour coded.

7. CHEMICAL HANDLING

- a. Displaying safe handling procedures & MSDS for all chemicals such as lube oil, acid, alkali, sealing compounds etc. at work place.
- b. Where it is necessary to provide and/or store petroleum products or petroleum mixture & explosives, the subcontractor shall be responsible for carrying out such provision / storage in accordance with the rules & regulations laid down in the relevant petroleum act, explosive act and petroleum and carbide of calcium manual, published by the chief inspector of explosives of India. All such storage shall have prior approval if necessary from the chief inspector of explosives or any other statutory authority. The subcontractor shall be responsible for obtaining the same.
- c. The used containers of chemicals shall be segregated and disposed of suitably
- d. In case the used containers need to be re-used, all traces of the chemical to be removed by thorough cleaning with detergents etc. under trained supervision

8. ELECTRICAL SAFETY

- a. Only electricians licensed by appropriate statutory authority shall be employed by the subcontractor to carry out all types of electrical works. The subcontractor shall maintain adequate number of qualified electricians to maintain his temporary electrical installations.
- b. No PDB or any other distribution board shall be more than 03 (three) years of purchase. Only modern PDB with industrial sockets as shown in layout below to be allowed to use at site.
- c. Power supply to all equipment at site to be routed through MCBs of appropriate rating. A 'Power Supply Distribution Plan' shall be prepared and submitted to BHEL Engineer for approval
- d. All power supplies through cables shall be underground or overhead with height > 3mtrs.
- e. All power distribution boxes shall be locked and the key controlled by site management of concerned subcontractor.
- f. All individual equipment & tools at site shall be powered through Earth Leakage Circuit Breakers of 30 mA sensitivity.
- g. These MCBs and ELCBs shall be regularly tested as per Clause 14
- h. All fuses and fuse wires shall be of standard size and rating.
- i. All electrical appliances used in the work shall be in good working condition and shall be properly double earthed other than armour earthing.

- j. All extension boards shall have separate switches for all sockets / connections.
- k. All portable electric tools used by the subcontractor shall have safe plugging system (industrial top & socket) to source of power and be appropriately earthed.
- l. Providing adequate no. of 24 V sources and ensure that no hand lamps are operating at voltage level above 24 Volts especially in confined spaces like inside water boxes, turbine casings, condensers etc.
- m. Electrical appliance shall have proper earthing and for appliances equal to & more than 415V shall have two separate earthing (as per IS-3043-1987)
- n. Portable Electric Lights**
 - i. Portable electric lights used in wet or potentially wet locations must be either low voltage type (24 volts or less) or protected by a GFI (ground fault interrupter).
 - ii. They must be visually checked before each use and periodically while in use to assure their original integrity is maintained.
 - iii. Cords with cuts, breaks, deep abrasions, etc. shall be taken out of service immediately.
 - iv. Repairs to extension cords shall only be performed by qualified/ licensed electricians.
 - v. Must not be allowed to lie in wet or potentially wet areas.
- o. Underground Cables:**
 - i. Every electric line or cable of unknown origin that is discovered or exposed during a digging, drilling, probing, or similar operation is to be considered as energized and life threatening.
 - ii. The senior company employee on the site will ensure that all necessary safety precautions are taken in order to isolate the line from all workers and the public.
 - iii. Such precautions may include halting the operation if appropriate.
 - iv. The senior company employee on the site is to then contact the proper authorities to have the line identified and either confirmed to be abandoned and/or made safe for continuing the work.
 - v. Any and all underground lines that are discovered or become severed must be considered energized on both sides, and be treated accordingly.
- p. Details of earth resource and their test date to be given to BHEL safety officer as per the prescribed formats of BHEL
- q. The subcontractor shall use only properly insulated and armoured cables and conform to the requirement of Indian Electricity Act and Rules for all wiring, electrical applications at site.
- r. BHEL reserves the right to replace any unsafe electrical installations, wiring, cabling etc. at the risk & cost of the subcontractor.
- s. No maintenance work shall be carried out on live equipment
- t. Adequate precautions shall be taken to prevent danger for electrical equipment. No materials on any of the sites of work shall be so stacked or placed as to cause danger or inconvenience to any person or the public
- u. The subcontractor shall carefully follow the safety requirement of BHEL/ the purchaser with the regard to voltages used in critical areas.
- v. Wiring and Branch Circuits Must be protected by a proper amperage over-current device such as a HRC fuse or circuit breaker. Such installations must be located so as to prevent physical damage to the wire conductors & panels.

- w. The sub-contractor shall supply modern power distribution board of different combination (1-phase & 3-phase). All the distribution of power should be through modern PDB. Equipment drawing is mentioned below.

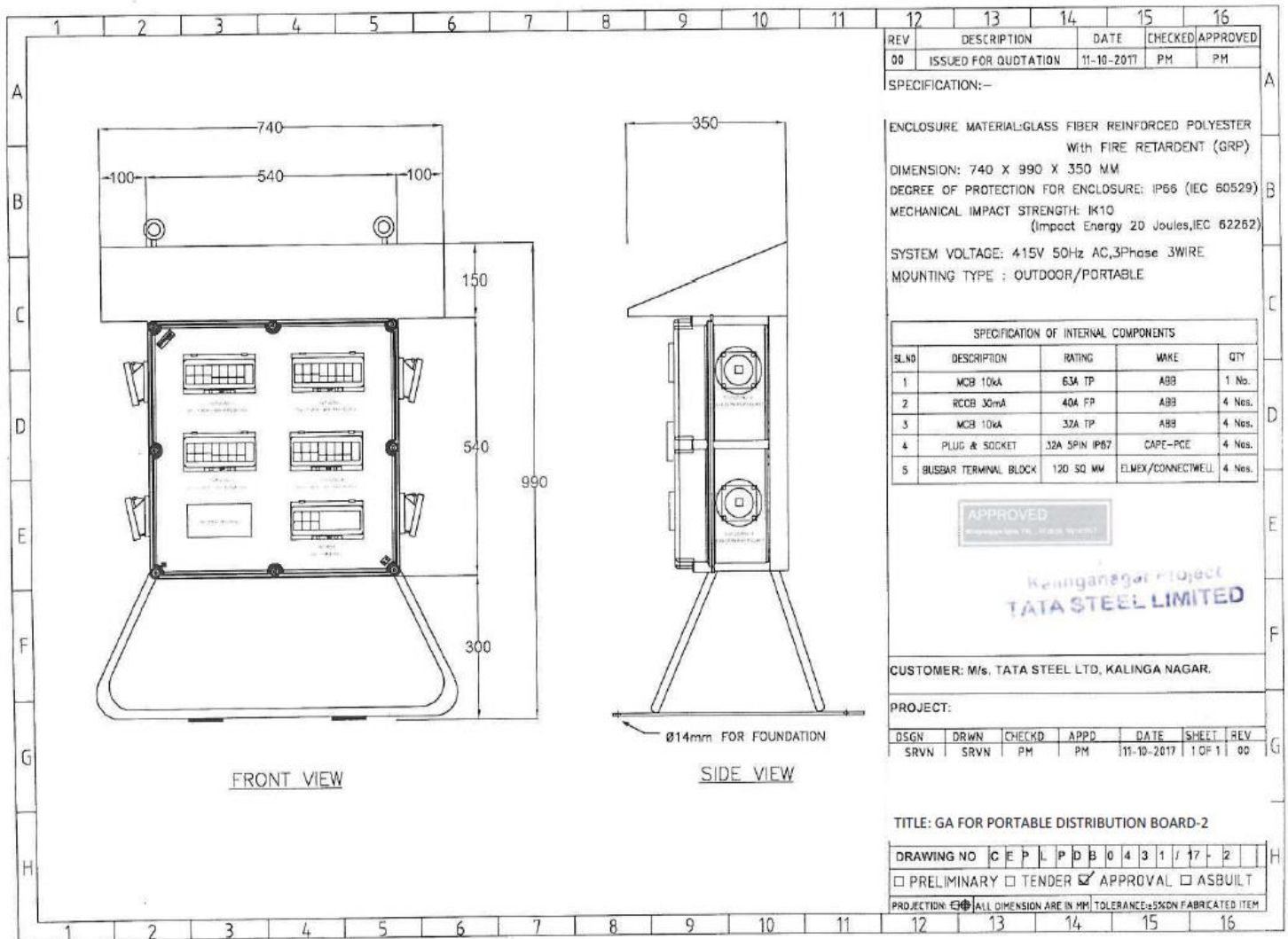

Fig. 9.1 Layout of a modern Power Distribution Board

x. General Electrical Safety

- i. In general, equipment or machinery being moved or transported must maintain minimum clearances of 25 ft. to all power lines.
- ii. TAG IN/ TAG OUT must be in force in Switch Room and all Distribution Boxes for live power line. The authorized person's name and contact no shall be displayed
- iii. Ensure "double insulated" three - core cables and three pin connectors are used and are properly ground "all insulated" types, all electrical tools and appliances must be manufactured for industrial use.
- iv. All connections shall be electrically and mechanically sound and properly insulated. Taped joints are not permitted. Connections to socket outlets must be made with proper plugs (industrial top and socket).
- v. Splices in electrical cords are not permitted. Repairs must be made at the socket connection and retain the same mechanical and dielectric condition of the original connection.

- vi. Damaged or defective electric tools, equipment and extension cords, etc. must not be used and shall be tagged out of service, removed from the work area and taken back to stores.
- vii. Only licensed electricians are authorized to repair and work on electrical equipment. Tampering with electric tools or equipment by others could result in termination.
- viii. Temporary electric cabling should be elevated 2.2 meters above the floor/ground or covered for protection. It must be kept clear of walkways and other locations where it may be exposed to damage or create a tripping hazard.
- ix. Energized wiring in junction boxes, circuit breaker panels and similar places must be covered and locked at all times.
- x. Areas with live high voltage wires or terminals must be barricaded against entry and warning signs posted Danger – High Voltage and Authorized Personnel Only.
- xi. Personnel should never work on energized equipment, de-energizing (lockout/tag out) the equipment is always the first requirement.
- xii. The lockout and tag out procedure will be used when testing or working on, or around, energized installation.
- xiii. Working around energized equipment should never be done alone. A second electrician must always be available for assistance.
- xiv. If lockout/tag out of the work is infeasible (must be demonstrated), work on energized electrical circuits must be approved by the Site In-charge. All safety precautions necessary must be taken, PPE use must be evaluated per the exposure and used, i.e high/low voltage gloves, insulated shoes, overcoats/aprons, face shields, and other protective equipment like insulated tools, blankets, mats, etc. must be used.
- xv. The welding machines earth leads shall be properly fixed without loose contacts. The earth cable only has to be used. No steel members shall be used as earth leads.
- xvi. Electrical crews must be qualified for the equipment and tools they work on, including being trained in Cardio-Pulmonary Resuscitation (CPR) methods and First Aid for rendering help in the event of electric shock.

y. Qualified Persons for Electrical Works

(One who is trained and wiremen licensed to Govt. of Respective State and familiar with the construction, operation and safety hazards of the equipment upon which they are permitted to work.)

- i. Qualified persons are intended to be only those who are well acquainted/experienced with and thoroughly conversant in the electric equipment and electrical hazards involved with work being performed.
- ii. Only qualified persons may be permitted to work on or near exposed energized parts. Such persons are required to have been trained in three specific areas:
- iii. Qualified persons must be capable of working safely on energized circuits;
- iv. Must be familiar with the proper use of special precautionary techniques and procedures bases on equipment and exposure; and
- v. Must be familiar with required personal protective equipment, insulating and shielding materials, and insulated tools.

- vi. Qualified persons are expected to be able to evaluate unknown situations and adjust their activities in such a way that only safe work practices are used. Such behavior is the responsibility of the qualified person.
- vii. It is possible and likely for an individual to be 'qualified' with regard to certain equipment in the work place, and unqualified on other equipment they must know their limitation and stop work if not qualified on what equipment they were to work on.
- viii. An employee who is undergoing on-the-job training, who, in the course of such training, has demonstrated an ability to perform duties safely at his or her level of training, and who is under the direct supervision of a qualified person is considered to be a qualified person for the performance of those duties. The process must be documented as proof.

z. Mandatory PPEs of electrical work on LV & HV

- i. HV arc flash suit with protective hood (for protection of face and head) as specified for hazard risk category-4 in NFPA-70E or similar IS specification for working on HT switch gear (for all voltage >690 V) to the concerned licensed electrician or competent person.
- ii. LV arc flash jacket/FR as specified for hazard risk category-4 in NFPA-70E or similar IS specification having ATPV rating of 8.5 to 9 cal/cm² for working on LV (>260V and ≤690V) to the concerned licensed electrician or competent person.



- iii. The LV arc flash jacket as shown above shall be worn continuously while working on LV (>260V and ≤690V). The color specification of LV arc flash jacket should be blue.
- iv. Electrical hand gloves should have following specification: Flame resistance, arc flash and cut protection of voltage rating (>260V and ≤690V).
- v. Electrical safety over shoe of relevant IS make for foot protection of licensed electrician or competent person while working in HV & LV line or equipment.

9. USE OF HAND TOOLS AND POWER-OPERATED TOOLS

a. General Provisions

- i. All hands and power tools and similar equipment, shall be maintained in safe condition.
- ii. When power operated tools are designed to accommodate guards, they shall be equipped
- iii. with such guards, when in use;
- iv. Belts, gears, shafts, pulleys, sprockets, spindles, drums, fly wheels, chains and other reciprocating, rotating or moving parts of the equipment shall be similarly guarded;
- v. Personnel using hand and power tools and exposed to the hazard of falling, flying, abrasive, and splashing objects, or exposed to harmful dusts, fumes, mists, vapors, or gases shall be provided with the particular personal protective equipment necessary to protect them from the hazards;

- vi. All hand-held powered platen sanders, grinders, grinders with wheels of 5 cm or less, routers, planers, laminate trimmers, nibblers, shears, scroll saws and jigsaws with blade shanks of 0.5 cm wide or less shall be equipped with only a positive on-off control.
- vii. All hand-held powered drills, tappers, fastener drivers, horizontal, vertical or angle grinders with wheels greater than 5 cm in diameter, disc sanders, belt sanders, reciprocating saws, saber saws and other operating powered tools shall be equipped with a momentary contact on control provided that turnoff can be accomplished by a single motion of the same finger or fingers that turn it on.

b. Hand Tools

- i. The subcontractor shall not issue or permit the use of unsafe hand tools;
- ii. Wrenches including adjustable pipe end and socket wrenches shall not be used when saws are sprung to the point that slippage occurs;
- iii. Impact tools such as drift pins, wedges and chisels shall be kept free of mushroomed heads;
- iv. The wooden handles of tools shall be kept free of splinters or cracks and shall be kept tight on the tools.

c. Power Operated Tools

- i. Electric power operated tools shall be either of the approved double-insulated type or shall be grounded;
- ii. The use of electric cords for hoisting or lowering loads shall not be permitted;
- iii. Pneumatic power tools shall be secured to the hose or whip by some positive means to prevent the tool from becoming incidentally disconnected;
- iv. Safety clips or retainers shall be securely installed or maintained on pneumatic impact (percussion) tools to prevent attachments from being incidentally expelled;
- v. All pneumatically riveting machine staplers and other similar equipment provided with automatic fastener feed, which operate at more than 7 kg/cm² pressure at the tool a safety device on the muzzle to prevent the tool from ejecting the fasteners unless the muzzle is in contact with the work surface;
- vi. Compressed air shall not be used for cleaning purposes except when the pressure is reduced to less than 2 kg/cm² and that too with effective chip guarding. The 2 kg/cm² pressure requirement does not apply to concrete form, mill scale and similar cleaning purposes;
- vii. The manufacturer's safe operating for hoses, pipes, valves, filters and other fittings shall not be exceeded;
- viii. Only personnel who has been trained in the operation of the particular tool shall be allowed to operate power-actuated tools;
- ix. The tool shall be tested each day before loading to see that the safety devices are in proper working condition. The method of testing shall be accordance with the manufacturer's recommended procedure;
- x. Any tool found not in proper working order, or that which develops a defect during use, shall be immediately removed from service and not used until properly repaired;
- xi. Tools shall not be loaded until just prior to the intended firing time. Neither loaded nor empty tools are to be pointed at any other person. Hands shall be kept clear of the open barrel end;
- xii. Loaded tools shall not be left unattended;
- xiii. Fasteners shall not be driven into very hard or brittle materials including, but not limited to, cast iron, glazed tiles, surface hardened steel, glass block, live rock, face brick or hollow tiles;

- xiv. Driving into materials that can be easily penetrated shall be avoided unless backed by a
- xv. substance that will prevent the pin or fastener from passing completely through and creating a flying missile hazard on the other side;
- xvi. No fastener shall be driven into a palled area caused by an unsatisfactory fastening;
- xvii. Only non-sparking tools shall be used in an explosive or flammable atmosphere;
- xviii. All tools shall be used with the correct shield, guard or attachment as recommended by the manufacturer.

d. Abrasive Wheels and Tools

- i. All grinding wheel must be ISO certified only.
- ii. All grinding machines shall be supplied with sufficient power to maintain the spindle speed at safe levels under all conditions of normal operation;
- iii. Grinding machines shall be equipped with suitable safety guards;
- iv. The maximum angular exposure of the grinding wheel periphery and sides shall not be more than 900, except that when the work requires contact with the wheel below the horizontal plane of the spindle, the angular exposure shall not exceed 1200. In either case, the exposure shall begin not more than 8.650 above the horizontal plane of the spindle. Safety guards shall be strong enough to withstand the bursting of the wheel;
- v. Floor and bench-mounted grinders shall be work-rests, which shall be rigidly supported and readily adjustable. Such work-rests shall be kept at a distance not to exceed 5 mm from the surface of the wheel;
- vi. Cup type wheels used for external grinding shall be protected by either revolving cup guard or a band type guard;
- vii. When safety guards are required, they shall be mounted as to maintain proper alignment with the wheel and the guard and the guard and its fastening shall be adequate strength to retain the fragments of the wheel in case of incidental breakage. The maximum angular exposure of the grinding wheel periphery and sides shall not exceed 1800;
- viii. Portable abrasive wheel used for internal grinding shall be provided with suitable safety flanges;
- ix. When safety flanges are required, they shall be used only with wheels designed to fit the flanges. Only safety flanges, of a type and design and properly assembled so as to ensure that the pieces of the wheel will be retained in case of incidental breakage, shall be used;
- x. All abrasive wheels shall be closely inspected and ring tested before mounting to ensure that they are free from cracks or defects;
- xi. Grinding wheels shall fit freely on the spindle and shall not be forced on. The spindle nut shall be tightened only enough to hold the wheel in place;
- xii. All employees using abrasive wheels shall be protected by suitable eye protection equipment.

e. Wood Working Tools

- i. All fixed power-driven woodworking tools shall be provided with a disconnect switch that can either be locked or tagged in the off-position;
- ii. The operating speed shall be attached or otherwise permanently marked on all circular saws over 0.5 m in diameter or operating at over 3000 peripheral rpm. Any saw so marked shall not be operated at a speed other than that marked on the blade. When a marked saw is re-tensioned for a different speed,

- the marking shall be corrected to show the new speed;
- iii. Automatic feeding devices shall be installed on machines wherever the nature of the work will permit. Feeder attachments shall have the feed rolls or other moving parts covered or guarded so as to protect the operator from hazardous points;
 - iv. All portable power-driven circular saws shall be equipped with guards above and below the base plate or shoe. The upper guard shall cover the saw to the depth of the teeth, except for the minimum arc required to permit the base to be tilted for bevel cuts. The lower guard shall cover the saw to the depth of the teeth, except for the minimum arc required to allow proper retraction and contact with the work. When the tool is withdrawn from the work, the lower guard shall automatically and instantly return to the covering position.

10. START UP, COMMISSIONING AND TESTING:

There are various activities involved prior to commissioning- the major ones are -Hydraulic Test, Steam Blowing, Transformers Charging, Boiler Light Up, Rolling and Synchronisation and Full loading of unit.

- a. These activities shall be personally supervised by the site executive along with the commissioning engineer.
- b. Appropriate Work Permits shall be taken as applicable
- c. The readiness of upstream and downstream system shall be ensured before taking up.
- d. These shall be handled strictly by the authorized persons only and the team shall be suitably briefed about the activity including hazards & risks involved and control plan by the concerned executive-in-charge before start.
- e. Entry of persons to the area of activity shall be suitably restricted and the emergency functions like Ambulance, first aid center and Fire station shall be intimated about the plan well in advance.
- f. Tag-in/ Tag-out shall be in place while charging transformer and whenever necessary.
- g. Electricians with valid wiremen license only shall be permitted to work on power lines.
- h. The area and the passage shall be adequately illuminated.

11. FIRE SAFETY

- a. The Fire Prevention, Protection and Preparedness Program is an integral part of the overall HSE Program. Effort and consideration must be given to safety, life and potential for delays in construction schedules and plant startup, as well as protection of property on a given project. The purpose of which is to prevent
 - i. Inception of fire
 - ii. Loss of life or personal injury
 - iii. Loss of Property
 - iv. Interruption of operations
- b. Site-in-charge / Safety Officer will make periodical review of the site Fire Protection, Prevention Preparedness Programme, Site conditions and available fire protection equipment. It is very imperative that the Sub-contractors along with BHEL to establish good contact with Local fire station for availability of Fire tender in case of emergencies, in addition to their own fire equipment.
- c. Fire Protection, Prevention and Preparedness Inspections - The Contractor /Sub-Contractor will be required to make frequent fire prevention inspections of his work site and operating facilities. Deficiencies will be corrected at once.
- d. Area where Hot work activities are carried out (Gas cutting / Welding/ any other spark producing work)

- above a working spot, a GI / fire-resistant non-asbestos sheet or suitable material shall be placed to prevent the fall of hot sparks. A bucket of water shall be kept nearby while doing hot work
- e. Hot work shall be preferably carried out in a designated area with a standing Hot Work Permit, to be renewed monthly. The designated area shall have fire extinguishers.
 - f. Any hot work outside designated area shall require a Hot Work permit and fire watch. No flammable material shall be stored within 35 feet from any fire load.

12. PAINTING:

- a. Requirements provide a detailed procedure to be implemented by all concerned employees and sub-contractors involved in painting activities.
- b. Significant Environmental Hazards:
 - i. Chemical hazard due to inhalation of lead fumes (lead containing paint)
 - ii. Chemical hazard due to inhalation of VOC's from painting operations
 - iii. VOC's from painting and coating operation
 - iv. Disposal of paints and coats drums
- c. Control Procedure for Painting:
 - i. Chemical products used in painting and coating operation shall have proper MSDS sheet in place. Whenever any doubt arises with respect to handling and safety point of view it should be accessed to all concerned.
 - ii. Toxic substances and hazards relate the toxic chemicals shall be identified.
 - iii. Proper PPE shall be used including plastic gloves appropriate overall etc.,
 - iv. Arrangement for cleaning of spillage shall be ensured
- d. Only trained workers shall be allowed and proper training should be imparted to the works.
- e. Exposure limits of the toxic substances shall be checked before starting the work and nobody shall be allowed to carry the work beyond the permissible limit.
- f. Ventilation or exhaust facility shall be provided at place where painting and coating operations are carried out.
- g. Overalls shall be supplied by the contractors/subcontractors to the workmen and adequate facilities shall be provided to enable the painters to wash at the cessation of work.
- h. Smoking, open flames or sources of ignition shall not be allowed in places where paints and other flammable substances are stored.
- i. A caution board in national /regional language "**smoking strictly prohibited**" shall be displayed in the vicinity.
- j. Suitable fire extinguishers/sand buckets shall be kept available at places where flammable paints are stored, handled or used.
- k. In case of indoor painting or painting in confined spaces, exhaust ventilating shall be provided. If adequate ventilation is not provided a proper respirator shall be provided and used by persons who are trained and fit tested.
- l. The VOC's from painting and coating operations shall not exceed the permissible level of CPCB/ SPCB norms. The paints and coats must be selected as per the guidelines.
- m. Workers shall thoroughly wash their hands and feet before leaving the work.

13. "HAZARDOUS ENERGY" CONTROL PROCEDURE/ LOCKOUT/TAGOUT (LOTO)

Hazardous Energy Control Procedures, known as "Lockout/Tagout (LOTO)" refers to specific practices and procedures to safeguard employees from the unexpected energization or startup of machinery and equipment, or the release of hazardous energy during service or maintenance activities.

Contractors must develop and submit a written LOTO program. This requires that a designated qualified individual turns off and disconnects the machinery or equipment from its energy source(s) before performing service or maintenance and that the authorized employee(s) either lock and tag the energy-isolating device(s) to prevent the release of hazardous energy and test the machine or equipment to verify that the energy has been isolated effectively.

a. Minimum Requirements:

The following are minimum requirements that must be included in the Contractor's LOTO program:

- i. Inspection of equipment by a trained individual who is thoroughly familiar with the equipment operation and associated hazards.
- ii. Identification and labeling of lockout devices. Purchase of locks, tags, and blocks. Development of a standard written operating procedure, permitted through a controlling authority that is followed by all workers.

b. General Requirements

The following steps must be taken to protect workers that install or service equipment and systems:

Follow the hazardous energy procedures and statutory regulations. Follow the manufacturer's service/repair instructions. Identify and label all sources of hazardous energy. Before beginning work, accomplish the following:

- i. De-energize all sources of hazardous energy:
 - ii. Disconnect or shut down engines or motors.
 - iii. De-energize electrical circuits.
 - iv. Block fluid (gas or liquid) flow in hydraulic or pneumatic systems.
 - v. Block or secure machine parts against motion.
 - vi. Block or dissipate stored energy.
 - vii. Discharge capacitors.
 - viii. Release or block springs that are under compression or tension.
 - ix. Vent fluids from pressure vessels, tanks, or accumulators—but never vent toxic, flammable, or explosive substances directly into the atmosphere.
- c. Lockout and tag out all forms of hazardous energy including electrical breaker panels, control valves, etc. Make sure that only one key exists for each of your assigned locks and that access to the key is controlled. Verify by test and/or observation that all energy sources are de-energized.
- d. After completion of the work, accomplish the following:
- i. Inspect repair work before removing the lock and activating the equipment.
 - ii. Make sure that only the worker that installed the lock removes his/her assigned lock.
 - iii. Make sure that all workers are clear of danger points before re-energizing the system.

e. LOTO Procedure

PURPOSE AND SUMMARY

This procedure provides the requirements and responsibilities of Hazardous Energy Control and the process for Lockout / Tag out (LOTO) of energy isolating devices (valves, circuit breakers, disconnect, etc.). Its use

shall ensure that machinery, equipment, or systems are isolated from all potentially hazardous energy to prevent unexpected energization, startup, or release of stored energy which may cause personnel injury or property damage.

This procedure applies to all BHEL personnel and subcontractors working on the WBPDC (1X660MW) STAGE-III projects where equipment must be taken out of service for the performance of work activities such as installation, maintenance, repair, construction, or equipment removal. The procedure may also be used to isolate equipment of which the energization or operation may present danger to personnel or property.

Lockout / tag out are not required for electrical equipment that can be unplugged from the source and the person performing the work has control of the plug.

This procedure shall be applied to prevent injury or damage caused by the unexpected release of active or stored energy. Hazardous energy sources could be in the form of the following:

- Electrical
- Hydraulic
- Chemical
- Thermal
- Mechanical
- Pneumatic

Preplanning of work activities includes the identification of all potential hazardous energy sources so that they may be properly controlled and isolated, locked, and tagged out.

Prior to initiating work activities on or around locked out / tagged out equipment, the equipment must be tested and tried by or in the presence of the person(s) performing the work activities.

RESPONSIBILITIES

- The Engineers in Charge is responsible for implementing and enforcing this procedure and approving lockouts /tag outs that impact the operation of the project.
- The Engineer in Charges responsible for authorizing Lockout /Tag out Requests.
- The Lockout / Tag out Coordinator is responsible for maintaining the Lockout / Tag out Log. Each shift should have a designated Lockout / Tag out Coordinator.
- The Isolator is responsible for determining the proper isolation devices and device positions required to isolate all potential energy sources so that the work stated on the Lockout /Tag out Request Permit may be safely performed. The Isolator must be familiar with the equipment and energy type(s) that require isolation. For this reason, in some cases the Isolator may be more than one person (i.e. Engineer, System Operator and/or Electrician). The Isolator shall position the specified device points, and apply locks and tags, and sign the tags and the LOTO Permit isolation point blocks.
- The Safety Manager is responsible for conducting an annual audit that is documented to ensure all procedures and requirements are current and being followed as written.

DEFINITIONS

Affected Employee: -

An employee whose job requires him/her to operate or use machinery or equipment on which servicing or maintenance is being performed under a lock out/tag out procedure or whose job requires him/her to work in an area in which servicing or maintenance is being performed under a lockout/tag out procedure

Authorized Employee: -

An employee who implements a lockout/tag out procedure on machinery, equipment, or systems in order that servicing or maintenance may be performed. Often an authorized employee and an affected employee may be the same person.

Danger “Do Not Operate” Tag

A tag used to identify energy isolation devices and specify the required position of the device. The tag should be affixed to the isolation device such that it is in plain view of anyone attempting to operate the device. The tags shall be sequentially numbered and shall specify the lockout/ tag out request number. The tag shall also state the purpose, and the expected duration of the lockout /tag out

Isolation Device

A device that is designed and intended to prevent the passage of energy. These devices, usually located at the energy source, are typically valves, circuit breakers, etc. Isolation devices should have a means of being locked in position

Lockout Device

A device that uses a positive physical means such as a lock, either key or combination type to maintain an energy isolation device in the safe position and prevent the inadvertent energization of machinery, equipment, or systems. Device locks should serve no other purpose other than hazardous energy control isolation

Lockout Tag out Request Permit

A pre-numbered form used to request that machinery, equipment or systems be taken out of service. A Lockout/Tagout Request Permit may be initiated by any one requiring energy isolation for work activities or for taking faulty equipment out of service

Lockout / Tag out Request Log

A record of all Lockout /Tag out Request Permits shall be maintained by the Lockout /Tag out Coordinator.

PROCEDURE

1. REQUESTING A LOCKOUT / TAGOUT PERMIT

When machinery, equipment, or systems are partially or completely taken out of service for work activities or equipment protection, a lockout / tag out shall be requested. The requestor shall be familiar with scope of work required and shall provide a brief description of the work on the Lockout / Tag out Request Permit. The requestor shall also provide the proposed start time and estimated duration of lockout / tag out. If familiar with the machinery, equipment, or system to be taken out of service, the requestor may identify the devices that are required to be isolated. The LOTO Request Permit shall be forwarded to the Authorized Lockout / Tag out Coordinator for reviewed and signature, along with Permit to Work number to be entered on the LOTO Request Permit.

- a. The Lockout / Tag out Coordinator shall record the necessary information on the Lockout / Tag out Request Log and forward the request to the Engineer in Charge for approval.
- b. The Safety Manager or Engineer in Charge shall review the Lockout / Tagout Request Permit for impact on project operations. Project operations could be impacted by the equipment being taken out of service or by the required isolation to take the equipment out of service. If project operations are impacted by the Lockout / Tagout, the request shall be forwarded to the Engineer in Charge for approval.
- c. The Engineer in Charge shall provide the lockout / tag out isolation points necessary to perform the task stated on the request. The device identification, device location, device position, and locking mechanism

shall be entered into the appropriate blocks on the Lockout / Tag out Request Permit.

- d. The Engineer in Charge indicates approval of the Lockout / Tagout Request Permit by signing in the appropriate space on the request. If the Lockout /Tag out Request Permit is rejected, the Engineer in Charge shall return it to the requestor, via the Lockout / Tagout Coordinator with a written explanation of the rejection.
- e. Once approved, the Lockout / Tag out Request Permit shall be forwarded to the Lockout / Tag out Coordinator to assign tags and locks.
- f. The log shall show current status of all Lockout / Tag out Request Permits from submittal to approval, through lifting of locks and tags to final closeout. The log shall be maintained by the Lockout / Tag out Coordinator in their office.

2. PLACEMENT OF LOCKS AND TAGS

- a. The tags shall be filled out to match the information on the LOTO Request Permit. Appropriate locks for the types of isolation devices specified shall be collected and placed with the tags and the Lockout / Tag out Request Permit.
- b. The isolator(s) shall take the device locks, tags, and the Lockout / Tagout Request Permit to position the specified isolation devices, sign and hang the tags, and place the locks. If the isolator does not agree with or understand the Lockout / Tagout Request Permit, or has a problem performing the isolation, the problem should be brought to the attention of the Safety Representative or Area Supervisor immediately and the lockout / tag out should be postponed until the situation is resolved.
- c. Once the Isolator has placed all "locks" on isolation points, they will "test "and "try" the machinery, equipment, or system to ensure all hazardous energy has been completely removed and the isolation is one totally accomplished, and has initialed and signed the Lockout /Tag out Request Permit indicating all isolation points have been confirmed. Examples of "lock", "test" and "try":
 - by checking that all locks on the LOTO Request Permit have been applied and are in the specified position open/closed, on/off, etc.; metering test of electrical circuits, opening of drain valves, checking pressure gauges or indicators; and try by pushing start buttons and on/off switches, etc.
 - Testing shall be performed by person(s) knowledgeable of the energy source(s) being isolated (e.g., an electrician should meter electrical circuits).
- d. A copy of the completed Lockout /Tag out Request Permit shall remain with the Work Package and used as part of the daily Pre-Job Briefings

3. WORKING UNDER A LOCKOUT / TAGOUT REQUEST

- a. Prior to starting the work activity, the person(s) performing the work shall review the Lockout / Tag out Request Permit and place the necessary tags and personal locks on the identified isolation devices. Personal locks may be placed only on devices that have already been locked and tagged in accordance with the Lockout / Tag out Request Permit.
 - All personal locks shall be accompanied by a tag that is signed and dated by the worker(s) and specifies the work activity being performed.
 - Personal locks should be of a different color than device locks for ready identification.
- b. Verification of the effectiveness of the isolation by the Isolator shall be performed for Worker's working under the lockout / tag out, by demonstrating the checks on "lock", "test" and "try",
- c. When the work activity is finished, personal locks and tags shall be removed and the Safety Representative

shall be notified that the Lockout / Tagout is no longer required. If work under a lockout / tag out is to be delayed or interrupted for a period in excess of 24 hours, personal locks shall be removed until the work restarts. Personal locks shall be removed prior to the worker(s) leaving the project at the end of shift unless the key(s) are maintained at the project.

4. REMOVAL OF LOCKS AND TAGS

- a. When the lockout / tag out is no longer required, the Safety Representative or Area Supervisor shall obtain the Lockout / Tagout Request Permit from the work package for LOTO removal. Prior to removing locks or tags that may allow equipment to be energized, a check shall be made to verify that the equipment is free to safely operate (i.e., will not cause damage or injury). The locks and tags shall be removed and returned to the Lockout / Tagout Coordinator. Isolation devices may be repositioned at the discretion of the Engineer in Charge according to operational requirements. The Isolator shall complete the Lockout / Tagout Request Permit indicating each lock and tag has been removed and the Safety Representative or Area Supervisor forward to the Lockout / Tagout Coordinator.
- b. The Lockout / Tagout Coordinator shall discard the tags and maintain the completed Lockout / Tagout Request Permit for future reference.
- c. In the event that an employee leaves the job site without removing the personal lock I tag, the following measures shall be taken and documented. The measures listed below are a minimum set of guidelines and under all circumstances, refer to the site-specific safe work plan for detailed procedures:
 - Attempt calling / contacting the employee to return to the site for removal.
 - In the event an employee cannot be contacted, the Site Manager and Safety Manager shall sign an Emergency Lockout/Tagout Removal Form, which has been completed by the Area Supervisor.
 - Employee shall be notified upon returning to the site, prior to beginning any work.

5. INTERRUPTION OF A LOCKOUT / TAGOUT

Operational Emergency

The Engineer in Charge / Safety Manager /Area Supervisor may deem it necessary to temporarily remove the locks and tags from isolation devices, prior to the end of the work activity. The standard procedure for removal of locks and tags shall be followed. Extreme caution shall be taken by the Isolator removing the locks and tags to prevent personnel injury.

Testing

When the performance of a work activity requires the functional testing of a machine, component, or system, the locks and tags may be temporarily removed in accordance with the tag removal, to perform the test. As a result of the testing, if it is determined that the equipment needs further work, the locks and tags shall be positioned back on to the device. If it is not necessary to replace all the locks and tags, then the unnecessary locks and tags may be returned to the Lockout / Tagout Coordinator. The Engineer in Charge shall initial the Lockout / Tag out Request Permit in the removal block to indicate that these locks and tags have been removed. When testing has been satisfactorily completed, the locks and tags shall be removed.

ISOLATION DEVICES

- In most industrial applications, there are isolation devices that were not designed to accommodate a locking device. In these instances, an acceptable alternative that physically obstructs or prevents the use of the isolation device shall be found. Chains shall be placed on valves or electrical panels. Wires shall be determinate, pulled back, taped, and secured.

- If an isolation device does not accept a lock, a tag only is acceptable; however, all possible precautions shall be undertaken to provide a level of safety for the workers. The tag shall be readily visible to anyone attempting to operate the device.
- If more than one Lockout / Tagout Request Permit requires that a single isolation device be locked and tagged, a lock and tag for each request shall be placed. Each lock in itself prevents the inadvertent operation of the device.

GROUP / COMPLEX LOCKOUT

In a multiple lockout / tag out procedure, each person working on the machinery or equipment must place a lock or tag on the energy isolating device. If the energy isolating device will not accept multiple locks or tags, a hasp (a multiple lockout device, may be used. The locks or tags must be placed in such a way that energy cannot be restored to the machinery or equipment until every lock or tag is removed. As each employee involved no longer needs to maintain lockout / tag out protection that employee removes his - her lock and/or tag. The employee attaching the lock or tag is the only person authorized to remove the lock or tag.

6. TRAINING

The training must include recognition of hazardous energy source, type and magnitude of energy available, methods and means necessary for energy isolation and control. Each authorized employee shall receive adequate training. The training should address that all affected employees are instructed in the purpose and use of the energy control procedure. There should be training provisions included for any other employee whose work operations are or may be in an area where energy control procedures may be utilized. The employee training should also address when tag out systems are used including the limitations of a tag (tags are warning devices and do not provide physical restraint). The training should also include that a tag is not to be removed without authorization. The tag is never to be ignored or defeated in any way. Retraining is required when there is a change in job assignments, in machines, a change in the energy control procedures, or a new hazard is introduced. All training and I or retraining must be documented with employee's name and dates of training.

7. PROGRAM REVIEW

The lockout / tag out program must be reviewed at least annually. The review must ensure that procedures are being followed and that they are effective. A documented review of the inspection must include the date, the equipment, employees involved & the inspector. The inspector must be someone other than those actually using the lockout / tag out in progress.

ATTACHMENTS

#1. Danger (DO NOT OPERATE) Tags



#2. Device & Personal Locks and Multi Lock Hasp:



#3. Lockout / Tagout Request Permit

		LOCKOUT / TAGOUT REQUEST PERMIT			LOTO Request Permit No.:		
					Work Permit No.:		
Equip. Out of Service:	LOTO Date Required by: _____/_____/_____	Estimated Duration:	LOTO Requested Date:				
Scope of Work:				LOTO Authorization			
				Signed by:			
				Date:			
				LOTO Removal Authorization			
				Signed by:			
				Date:		Time:	
Tag No.	Device to be Tagged / Locked I.D. No.	Device Location	Device Position OPEN / CLOSE D -	Lock No.	Tag/Lock Placed by Print/Sign - Date/Time	Tag /Lock Removed by Print/Sign - Date/Time	
Comments Instructions: Attachment 3.Lockout / Tag out Request Permit:							

#4. Lockout / Tag out Request Log

LOTO Permit No.	Request or Name	Equipment & Location	Est. Work Completed Date	Approval Date	LOTO Placed Date	LOTO Removed Date	Comments

14. RISK ASSESSMENT

Risk and Hazard Analysis

In order to produce an overall Project EHS Plan, a project must be assessed for its risks. There are two components to the risk and hazard analysis. The procedure used to examine and plan for the identified risks and hazards is called a General Hazard and Risk Assessment.

JSA/HIRA review

Prior to commence the following activities Method statement and JSA/HIRA to be prepared by the concern engineer in coordination with EHS officer and submit to the client for review and approval. After getting approval the work will be started under PTW after clearance. For HIRA and criteria for the defining the high, medium & low risk the relevant annexure be referred. In case any deviations required in the approved method statement the concerned engineer/supervisor has to prepare additional HIRA/JSA to cover the new activities and associated risk. Following activities to be covered,

- Deep excavation (more than 5 feet)
- Significant concrete pouring (like heavy foundation, TG deck, Slab casting etc.)
- Confined entry
- Blasting
- Working on electrical/ energized equipment's
- Steel erection more than 5-Ton weight
- Working at height prior to completion of stairs/ladders/hand railing etc.

Definition:

HAZARD - Any potential or present danger to persons or property within the project site, e.g., oil on the floor is a hazard.

INCIDENT - An unintended happening that may result in injury, loss or damage, e.g., Slipping on the oil is an Incident.

INJURY – Physical harm, the result of an Incident, e.g., a sprained wrist from the fall would be an injury.

Hazard Analysis Document

- For high risk and dangerous work identified, the Applicant shall complete and submit a Hazard Analysis Document together with the PTW request. It will be a JSA (Job Safety Analysis) or Preliminary Hazard Analysis Checklist. And it shall be reviewed and approved by respective Construction and HSE Representatives.
- Issues such as work interface, coordination, drawings, toolbox meetings and work type/duration shall be detailed and included with supporting documentation for the Applicant's request for PTW.
- If applicable, Hazard Analysis Document shall be used as the foundation for development of Safe Work Method Statement. Each hazard identified shall be addressed in the Safe Work Method Statement and be submitted as part of the Applicant's submittal package.

Evaluation of Sub-contractor Risk Assessments includes

- Experience and expertise in performing similar type work.
- Duration of work performed
- Location of the work to be performed.

- Nature of the work to be performed.
- Potential for a subcontractor performing the work to expose themselves, other persons or employees, to hazards.
- Potential for exposure to work site hazards.

Review of Subcontractor specific issues

Preventive and protective measures must be introduced according to the following order of priority

- Eliminating the hazard by removing the activity from the work process. Examples include substitution with less hazardous chemicals, using different manufacturing processes, etc.
- Controlling the hazard at its source through use of engineering controls. Examples include local exhaust ventilation, isolation rooms, machine guarding, acoustic insulating, etc.
- Minimizing the hazard through design of safe work systems and administrative or institutional control measures. Examples include job rotation, training safe work procedures, lock-out and tag-out, workplace monitoring, limiting exposure or work duration, etc.
- Providing appropriate personal protective equipment (PPE) in conjunction with training, use, and maintenance of the PPE.

15. HSE PREPAREDNESS FOR ADVERSE CLIMATES AND WEATHER

All Preventive and Precautionary measures to ensure Health & Safety of workers in all possible adverse weather conditions based on the analysis of the local area conditions to be taken by the subcontractor

15.1 SUMMER

1. The Working Time and Lunch Hour will be as per instruction of Statutory Authorities (no work between 11am to 3:30pm). However, in case temp comes down due to rain/cloudy weather work will continue as per normal routine.
2. During long lunch break, worker will be allowed to go back home for rest. Those who will like to stay back will avail at the facility of rest shed or other designed area.
3. They will be allowed to take small break during work as per their need.
4. Water sprinkling will be done on roads to reduce dust concentration.
5. Workers will be provided with adequate cool drinking water and Butter milk/Lemon water etc.
6. Adequate ORS stock will be made available at the work location in the First-Aid Box for use as needed and at First-aid Centre for emergency need.
7. Fire prevention shall be on high alert, with removal of dry grass and bushes, etc, inside and outside the surrounding work areas. No smoking, and control of open flame/sparks shall be maintained and monitored.
8. Worker will be informed about the Do's and Don'ts to be followed during summer in the Pre Job Brief.

Dos & Don'ts

1. Drink plenty of cool water and other non-alcoholic fluid and keep body well hydrated.
2. Eat salt in food to replenish loss of salt through sweating.
3. Avoid over physical exercise.
4. Have adequate sleep at night.
5. Eat light and less spicy food
6. Avoid eating food which was cooked long time ago.

7. Nobody should use small water bodies such as pits, running rain water through crevices etc. for drinking and cleaning purpose as it may be unhygienic.

Emergency Handling

In case of emergency due to heat disorder:

1. Rescue the victim from workplace and place under shed.
2. If to be rescued from height, use stoke basket or rescue kit.
3. Inform Ambulance immediately.
4. If nearby any air conditioned room/shed is available, place him inside the room/shed.
5. Administer First aid by trained First aider for Heat Disorder
6. If conscious, give him ORS solution to drink.
7. If required send the victim hospital immediately.

15.2 MONSOON

A. Height Work & Structural Safety:

1. Ensure that all height work platforms are barricaded and avoid any highly hazardous
2. Height work.
3. Ensure that all personnel have good quality and intact safety shoes
4. Stop all dangerous height work during rain
5. Explain Do's and Don'ts to workers during Tool Box Meetings
6. Ensure that there are no weak structures, boards etc. that can fall during high winds
7. Do not allow any loose material (e.g. GI sheet, Ply board, empty cement bag, aluminium foil, foam sheets etc.) on roof sheds or top of structures.
8. Do not permit any one to ride up or come down scaffolds frame work during heavy wind or rain.
9. Provide "anchor" of adequate strength to scaffolds and other high-rise structures.
10. All rest sheds and GI sheds will be anchored into the round and wall and roof panels will be secured with J hook to prevent shed from blowing over or parts/pieces becoming airborne. Proper earthing per IS standard is also to be installed.
11. Do not go alone nor permit anyone to stay at tower-tops, roof-tops, high structures or on electrical poles during the course of stormy weather or heavy rain.

B. Electrical:

1. All electrical connections / loads have to be routed through ELCB / RCCB (residual current circuit breaker) whose rating should be 30mA.
2. RCCB operational checks need to be done DAILY / WEEKLY during monsoon season.
3. Avoid joints on power cables which need to be laid over-head or under-ground, better not to have any joint at all. In case joints become essential, such cables must be housed rigidly and insulation must be provided as per approved standard. The joint shall be suitable for outdoor use.
4. All electrical distribution board shall be properly covered at top and sides to protect from rain water. Extension boards shall be protected from rain water.
5. Ensure proper "earthing" for each and every electrical appliance.
6. Double earthing need to be provided for 3-phase power supply and for voltage more than 220V.

7. Provide lightening arrestors at the top of Boiler 3 and boiler 4 and rest sheds which are not covered by existing lightening arrestor of other installation.

C. Others:

1. Maintain smooth flow on open drains. i.e. no obstruction or blockade shall be made on storm water drains. If required, make temporary drains.
2. Arrange back-filling of excavated pits on war-footing basis.
3. Arrange bringing down booms of all cranes, hydra machines during stormy weather (wind speed 40-50 km/hr)
4. Confirm that all gantry cranes are effectively choked to prevent rolling and toppling.
5. Do not forget to deep ready a dew battery operated lights at site-offices during rainy season.
6. Avoid using wet damp clothes.
7. Hard Barricade excavated zone filled with water with scaffolding pipe & clamp with reflective net
8. Engage diesel operated water pump to dewater work area. For electrically operated water pump, the starter shall be protected from rain water. All rotating parts shall be guarded. Ensure availability of sufficient water pumps.

D. Health and hygiene:

1. Monsoon reduces the immunity of our body and makes us vulnerable to many diseases which are commonly associated with this season. It is time for us to keep our body challenging against disease by boosting our immunity and taking safety measures against these diseases.
2. The diseases associated with monsoon are Malaria, Jaundice, Gastro-intestinal infections, like typhoid, cholera etc. apart from these viral infections like cold and cough also make their presence felt. Majority of above said diseases are on account of:
3. Puddle of water formed due to rain become breeding grounds for mosquitoes which spread disease like, malaria and dengue fever. As a precautionary measure against mosquito-bite disease one can use mosquito net around the end which is better choice to mosquito repellents like mats and coils.
4. Pollution of drinking water during monsoon is very common. It is very necessary to drink clean and pure water when water-borne monsoon diseases like diarrhoea and gastro-intestinal infections threaten us.
5. Walking in dirty water during rainy season leads of numerous fungal infection which affect toes and nails. Diabetic patients have to take a special care about their feet. Keeping feet always dry and clean is very necessary. Avoid walking in dirty water. Keep shoes socks and raincoats dry and clean.

E. Workmen will be made aware of following Do's and Don'ts:

1. Do not sleep in daytime.
2. Avoid over physical exertion.
3. During lightning and thunder storm, do not take shelter under tree. Take shelter inside rest shed or store room.
4. Wash vegetables with clean water and steam them well to kill germs.
5. Avoid eating un-cooked foods and salads should be washed properly before consumption.
6. Drink plenty of water and keep body well-hydrated.
7. Always keep the surrounding area dry and clean. Don't allow to get water accumulated around.
8. Keep body warm as viruses attack immediately when body temperature goes down.

9. Do not enter air conditioned room with wet hair and damp cloths.
10. Dry your feet and webs with soft dry cloth whenever they are wet.
11. Eat light and less spicy food.
12. Avoid eating food which was cooked long time ago.
13. Eat salt in food to replenish loss of salt through sweating.

15.3 EMERGENCY WEATHER CONDITIONS

Cyclone/Severe thunder storm

In the event of Cyclone/Severe thunder storm, alert will be issued by subcontractor on notification received by Govt. authorities/Metrological departments Customer or BHEL.

The actions required during cyclone/rough weather:

1. Check and advice subcontractors to clean-up work area. Pick up all loose and unused material of respective supervisor's area.
2. Tie to secure all gas cylinders to avoid displacement and unsafe conditions which could be due to wind pressure.
3. Secure portable electricity generating sets and other equipment, pumps, hoses etc.
4. Make preparation for removal of water logging.
5. Take review of work activity and make preparation for removal of equipment and material from vulnerable areas.
6. Isolate/turn off all electrical power form the main panel/switches. Secure and anchor panels properly.
7. Recheck anchorage/tie of all temporary structures/sheds, tall objects, cranes, rigs, scaffolds etc. to avoid toppling due to wind force.
8. Cranes boom shall be secured, either locked or lowered the booms as reasonably and practicably possible and rigs to safe position for the safety point of view.
9. Group up all trash barrels, wooden pallets, forms; wooden decks etc. and anchor properly.
10. Welding machines, air compressors and such equipment are to be grouped together and secured to the stable objects. Welding leads, electrical cables, hoses are to be rolled up and secured properly.
11. Set on site vehicles on high ground in the site area with brakes set firmly.
12. Anchor all tanks, vessels, gas cylinders that may be moved by high wind and water.
13. Evacuate job site.

Personnel Evacuation:

1. Personnel Evacuation will be required if predicted wind speed and storm surge heights are beyond acceptable limits as per the instructions from Govt. Authorities/ Metrological departments or Customer.
2. Once the warning is received for personnel evacuation, an emergency response team shall be formed. The team will work with local authorities and other agencies formed/deployed to evacuate and transport all personnel involved in the project to the cyclone shelter.
3. Cyclone may be followed by the calm "EYE", be aware of it. If the wind suddenly drops, don't assume the cyclone is over. Violent wind may resume from the opposite side direction. Wait for the official "All clear Signal".

4. After the cyclone, do not go outside until officially communicated about safe situation outside. Use recommended routes for returning. Do not panic or rush while returning.
5. Checking of gas leaks and well-being of electrical appliances is essential before leaving the site.
6. Follow local communications for official warning and advice. The construction Manager shall also obtain updates from customer/metrological departments and communicate to the personnel on project site.

15.4 PREVENTION OF COVID-19 (COVID-19 HERE TO BE READ AS COVID-19 AND OTHER PANDEMICS/ COMMUNICABLE DISEASES) AT PROJECT SITE & LABOUR COLONY:

Resumption of Construction Activities after Lock Down and Prevention of Coronavirus Infection during Site Operations and OCP 61A: Prevention of COVID-19 Infection in Labor Colony will be strictly followed.

A. Preventive measures at project site:

- BHEL and Agencies shall nominate COVID Marshalls, who will be responsible for monitoring the COVID prevention measures and apprising management on the same.
- Mandatory health check-up for every worker/ official joining the site
- All activities to be carried out using least amount of paperwork and physical proximity as far as possible.
- **HSE Observer App** to be used to monitor HSE Activities and follow up with agencies for closure of non-conformities.

a. Strict Control at the Gate/ Banning Entry to Anyone Not Wearing Masks

- i. Security personnel at the gate may erect a barricade preferably approx. 10 meters from the gate and only allow personnel who are wearing proper masks inside.
- ii. Public address system may be used to warn any non-compliant visitors
- iii. Near entry gate, round markers at minimum 1-meter distance to be ensured so that distancing is ensured
- iv. A hand-wash or hand sanitiser facility is preferable at the gate to allow entry after hand wash or hand sanitisation. These are also to be provided at key locations to enable hand wash / hand sanitisation before starting work, before eating, etc.
- v. Gutkha, Paan, tobacco etc. to be banned from the site. Spitting to be strictly prohibited.

b. Screening at Gate with Contactless Thermometer & Action on Suspected Cases

- i. Security Personnel at the Gate to screen each person entering the premises using a non-contact infrared thermometer, which is duly serial numbered and calibrated.
 - ii. In case any site worker/ official is found to have fever more than 99 Degrees Fahrenheit or found coughing/ sneezing, he/she may be advised rest till recovery and entry to be permitted after obtaining clearance from medical officer/assistance/attendants.
- Parcel to be collected from gate by concerned person preferably with provision of Special Box
 - Any construction material received at site, unless properly sanitized, to be kept undisturbed for at least 3 days and to be used only after that period.
 - During Toolbox Talks, minimum 1-meter distance between any two workers to be ensured

c. During site execution activities:

For all site execution activities, social distancing is to be maintained. In case this is not possible due to nature of work, speciality of work, etc, ensure sensitisation of the labour/staff involved and use of appropriate PPEs, especially mandatory face mask. In any case, close working to be allowed only in special

circumstances and ensuring these activities are preferably time staggered to the extent possible

d. In office premises:

- i. Sharing of items like pens, water bottles etc. in office premises to be avoided
- ii. Doors preferably to be in open condition to avoid contact
- iii. All common touch points to be frequently disinfected in a day.

e. Regular disinfection of all Areas, Equipment and facilities

- i. A dedicated disinfectant gang to be identified for the task by each agency. The disinfectant gang to be provided full body suits for the task.
- ii. All areas (including office premises, site areas, chairs, tables, furniture etc.), tools & equipment to preferably be disinfected by dedicated gang every day before resumption of work.
- iv. Common touch points like handrails, lift buttons, door/window knobs or handles, vehicle door handles, taps, conference room & dining hall tables/chairs, common sofas/chairs, visitor sofa/chairs, files & folders, etc to preferably be disinfected regularly at frequent intervals every day.
- v. Pool vehicles, to be disinfected after every use. Social distancing to be maintained inside the common pool vehicles as per Govt./ statutory body guidelines.

f. Disinfecting the operator/driver touch points of Vehicles/cranes, T&Ps etc.

Disinfection to also be carried out for all Cranes, Vehicles, Equipment, consoles, T&Ps etc. which come into contact with operating personnel.

g. Posters on COVID-19

Sufficient Posters on COVID-19 to be ensured across the site in languages understood by most workers.

h. Brief guidelines for hand washing are as below:

- i. Soap to be provided at each wash basin and replenished regularly.
- ii. Washing with soap for at least 20 seconds is recommended.
- iii. As a general guideline, for every 100 workers, 1 wash-basin may be provided at site areas.
- iv. Close queue to be avoided near wash-basins and 1-meter distance to be maintained. Round markers at 1-meter distance can be ensured as guidance

Composition of Disinfectant:

- i. Readily available 1% hypochlorite solution or 4%
- ii. Liquid chlorine-1% solution
- lii. Surgical spirit-95% alcohol content
- iv. Hand sanitizer should have: Isopropyl alcohol-75%, Glycerol-1.45%, Hydrogen Peroxide-0.125%

B. Prevention of COVID-19 Infection in Labor Colony:

- Spacing of minimum 2 meters between living areas of workers inside a room may be maintained. Preferably, the living area of each worker may be partitioned using sheet of cloth, plastic etc.
- Rooms to be properly ventilated as far as possible
- Sanitation to be given prime importance and personal hygiene to be promoted
- Face masks shall be worn by everyone inside the colony premises
- Spitting of Pan. Gutkha etc. inside the colony and urinating etc. outside the toilets to be strictly avoided
- Regular visits by Doctors to the labor colony can be arranged on non-working day for check-up of all workers
- **Identification of "COVID Wardens" (CWs) by each agency for maintaining the following:**
 - i. Keeping an eye on the health of workers and report any suspected cases of fever, coughing etc. to the

management

ii. Keeping an eye on the social distancing measures in the labor colony and report any non-conformances to the management.

iii. Educate the workers about social distancing and COVID prevention measures.

- Training/ Awareness regarding COVID-19 to be provided to workers regularly.
- Workers to be instructed to maintain social distancing of minimum 1 m at all time
- **Posters on COVID-19:** Sufficient Posters on COVID-19 to be ensured across the labor colony in languages understood by most workers.
- All workers to be instructed to inform any suspected cases of illness (individual or others) to an emergency contact number of CW, the emergency contact numbers and CW contact numbers to be displayed at prominent locations
- **Inspection & Review**
 - i. Daily Inspection by concerned COVID Wardens and reporting to Agency
 - ii. Regular inspection by Agency & BHEL

15.5 Noise Mitigation

High noise is harmful to the human health and it can cause impairment if exposed for long duration at regular intervals, and also cause disruption in nearby communities.

- Noise monitoring shall be carried out in all construction locations periodically.
- Use of silent DG is allowed at site during construction.
- Low noise generation equipment's to be preferred.
- Work areas where noise levels exceed the 85db shall be posted as hearing protection required.
- Use of PPEs / ear plug/ear muff for personnel entering into high noise area.
- Activities generation High noise will be planned in day shift.

Noise Level Chart

Parameter	Night Noise level dBA	Daytime Noise Level dBA
At 1-meter from each piece of equipment	85	85
At Property boundary	70	70



ANNEXURE J

First-Aid Box

Rk

Details & Contents of First Aid Box as per Contract Labor (Regulation & Abolition Act), Central Rules, 1971

- (1) The first-aid box shall be distinctively marked with a Red Cross on a white background and shall contain the following items, namely:

(a) For establishments in which the number of contract labor employed does not exceed fifty, each first aid box shall contain the following equipment:

(i)	6 small sterilized dressings
(ii)	3 medium size sterilized dressings
(iii)	3 large size sterilized dressings
(iv)	6 pieces of sterilized eye pads in separate sealed packets.
(v)	6 roller bandages 10 cm wide.
(vi)	6 roller bandages 5 cm wide.
(vii)	One tourniquet
(viii)	A supply of suitable splints
(ix)	Three packets of safety pins.
(x)	Kidney tray.
(xi)	3 large sterilized burn dressings.
(xii)	1 (30ml) bottle containing a two percent alcoholic solution of iodine
(xiii)	1 (30 ml) bottle containing Sal volatile having the dose and mode of administration indicated on the label
(xiv)	1 snake bite lancet
(xv)	1 (30gms) bottle of potassium permanganate crystals.
(xvi)	1 pair scissors
(xvii)	1 copy of the First-Aid leaflet issued by the Director General, Factory Advice Service and Labor Institutes, Government of India.
(xviii)	A bottle containing 100 tablets (each of 5 grains) of aspirin
(xix)	Ointment for burns
(xx)	A bottle of suitable surgical anti-septic solution

(b) For establishment in which the number of contract labor exceeds fifty each first-aid box shall contain the following equipment:

(i)	12 small sterilized dressings
(ii)	6 medium size sterilized dressings
(iii)	6 large size sterilized dressings.
(iv)	6 large size sterilized burn dressings
(v)	6 (15 grams) packets sterilized cotton wool
(vi)	12 pieces of sterilized eye pads in separate sealed packets.
(vii)	12 roller bandages 10 cm wide.
(viii)	12 roller bandages 5 cm wide.
(ix)	One tourniquet.
(x)	A supply of suitable splints.
(xi)	Three packets of safety pins.
(xii)	Kidney tray.
(xiii)	Sufficient number of eye washes bottles filled with distilled water or suitable liquid clearly indicated by a distinctive sign which shall be visible at all times.
(xiv)	4 per cent Xylocaine eye drops, and boric acid eye drops and soda by carbonate eye drops.
(xv)	1 (60ml) bottle containing a two percent alcoholic solution of iodine
(xvi)	One (two hundred ml) bottle of mercurochrome (2 per cent) solution in water.
(xvii)	1 (120ml) bottle containing Sal volatile having the dose and mode of administration indicated on the label.
(xviii)	1 roll of adhesive plaster (6 cmX1 meter)
(xix)	2 rolls of adhesive plaster (2 cmX1 meter)
(xx)	A snake bite lancet.
(xxi)	1 (30 grams) bottle of potassium permanganate crystals.
(xxii)	1 pair scissors
(xxiii)	1 copy of the First-Aid leaflet issued by the Director-General, Factory Advice service and labor Institutes, Government of India.
(xxiv)	a bottle containing 100 tablets (each of 5 grains) of aspirin
(xxv)	Ointment for burns
(xxvi)	A bottle of a suitable surgical anti septic solution.

- (2) Adequate arrangement shall be made for immediate recoupment of the equipment when necessary.



ANNEXURE K

Vertigo Test

Rk

Vertigo Test Procedure/ Guidelines

This document specifies minimum requirements for vertigo test. These may be supplemented by any additional requirements deemed fit by the medical examiner/ HSE department)

Fear of height may be physiological or psychological. Therefore, to rule out any possibility of physiological factor, detailed medical check-up of workers is carried out before vertigo test. Medical check-up of workers includes the following:

history of past illnesses (like epilepsy, drug allergy, diabetics/ hypertension, unconsciousness etc.), general physical examination (like height, weight, BMI, build and nourishment etc.), measurement of pulse rate, Blood Pressure, respiratory rate.

After this check-up, those who are found suitable for height work by examining doctor, are allowed to undergo vertigo test.

During this health check-up, psychology of workers is also studied. If any worker finds it extremely difficult/ frightening to climb the monkey ladder & walk on the beam, during/after performing vertigo test or even before performing, then he is treated as disqualified.

As per standard, during vertigo test, worker is allowed to climb on a foundation through monkey ladder, walk on a beam, then steps down at the other end of beam, through monkey ladder. Height of the beam should be at least six feet from ground level. All necessary safety precautions are taken during this test. Worker has to wear full body harness with double lanyard. A horizontal lifeline is run parallel to the beam and worker has to put his lanyards into the lifeline. Additionally, a safety net is also put below the beam for rescue of the victim in case of a fall from beam.

Following activities are suggested to be carried out during testing:**1. Walking Bench Training:**

- a. Person should walk over the channel. He should maintain balance & walk without much problem.
- b. If the person has problem to balances himself on repeated chances, he may be having flat foot or some other problem. So, he may not be fit for height work.

2. Rope Climb Training:

Person should be able to climb the rope up to the top channel for ensuring that in case of fall, a person hanging on the safety harness, will be able to safely climb back to the platform within minimum time period before the safety harness start breaking down under the load.

3. Height Work Training:

Person should walk freely on the middle channel while holding the top channel with the help of safety harness.

4. Ladder for Vertical fall arrestor Training:

Vertical fall arrestor rope is fixed from top to bottom of the ladder. It will ensure:

- Usage of vertical fall arrestor.
- Usage of two lanyards of a safety harness.
- Ensure 3-point contact on the ladder while climb.

5. Chair for work at height Training:

- Climb through vertical ladder with two lanyard ropes.
- Hooking of two lanyard ropes to life line. With this safe arrangement, he can walk to chair.
- Sits in the chair safely, comes out & walks back to the vertical ladder & come down from vertical ladder. After completion of vertigo test, blood pressure of worker is again measured. If it is not within acceptable limits for any worker, concerned worker is denied height pass.

Only those who pass the above training are to be considered as fit for height work.

PROFORMA OF BANK GUARANTEE (in lieu of SECURITY DEPOSIT)

In consideration of the Bharat Heavy Electricals Limited (hereinafter referred to as the 'Employer' which expression shall unless repugnant to the context or meaning thereof, include its successors and permitted assigns) incorporated under the Companies Act, 1956 and having its registered office at BHEL House, Siri Fort, Asiad, New Delhi – 110049 through its Unit at Bharat Heavy Electricals Limited, Power Sector Eastern Region, BHEL Bhawan, Plot No 9/1, DJ Block, Sector-II, Salt lake City, Kolkata – 700091 having agreed to exempt (Name of the Vendor / Contractor / Supplier) having its registered office at _____¹ (hereinafter called the said Contractor which term includes supplier), from demand under the terms and conditions of the Contract reference No. _____² dated _____² valued at Rs.....² (Rupees -----)² for <Nature of the Work>³ (hereinafter called the said Contract) of Security Deposit for the due fulfilment by the said contractor of the terms and conditions contained in the said Contract, on production of a Bank Guarantee for Rs. _____⁴ (Rupees _____ only), we ____ (indicate the name and address of the Bank) having its Head Office at _____ (address of the head Office) (hereinafter referred to as the Bank) at the request of _____ [Name of Contractor(s)] do hereby undertake to pay to the Employer an amount not exceeding Rs. _____ in the event of any breach by the said Contractor(s) of any of the terms and conditions contained in the said Contract.

We, _____ (indicate the name of the Bank), do hereby undertake to pay the amounts due and payable under this guarantee without any demur, merely on a demand from the Employer. Any such demand made on the bank, shall be conclusive as regards the amount due and payable by the Bank under this guarantee. However, our liability under this guarantee shall be restricted to an amount not exceeding Rs. _____.

We undertake to pay to the Employer any money so demanded notwithstanding any dispute or disputes raised by the Contractor(s) in any suit or proceeding pending before any Court or Tribunal relating thereto our liability under this present being absolute and unequivocal.

The payment so made by us under this guarantee shall be a valid discharge of our liability for payment hereunder and the Contractor(s) shall have no claim against us for making such payment.

We, further agree that the guarantee herein contained shall remain in full force and effect during the period that would be taken for the performance of the said Contract and that it shall continue to be enforceable till all the dues of the Employer under or by virtue of the said Contract have been fully paid and its claim satisfied or discharged or till _____⁵ or till the office/Department/Division of Bharat Heavy Electricals Limited certifies that the terms and conditions of the said Contract have been fully and properly carried out by the said contractor(s) and also including the satisfactory performance of the equipment during guarantee period and accordingly discharges this guarantee. Unless a demand or claim under this guarantee is made on us in writing on or before the _____⁶, (3 months more than the present date of validity of Bank Guarantee) we shall be discharged from all the liability under this guarantee thereafter.

We, _____ (indicate the name of the Bank) _____ further agree with the Employer that the Employer shall have the fullest liberty without our consent and without affecting in any manner our obligations hereunder to vary any of the terms and conditions of the said Contract or to extend time of performance by the said contractor(s) from time to time or to postpone for any time or from time to time any of the powers exercisable by the Employer against the said contractor(s) and to forbear or enforce any of the terms and conditions relating to the said Contract and we shall not be relieved from our liability by any reason of any such variation or extension being granted to the said contractor(s) or for any forbearance, act or omission on the part of the Employer or any indulgence by the Employer to the said contractor(s) or by any such matter or thing whatsoever which under the law relating to sureties would but for this provision have effect of so relieving us.

This guarantee will not be discharged due to the change in the constitution of the Bank or the Contractor(s).

We,..... BANK lastly undertake not to revoke this guarantee during its currency except with the previous consent of the Employer in writing.

Notwithstanding anything to the contrary contained hereinabove:

- a) The liability of the Bank under this Guarantee shall not exceed.....⁷
- b) This Guarantee shall be valid up to⁸
- c) Unless the Bank is served a written claim or demand on or before _____⁹ (3 months more than the present date of validity of Bank Guarantee) all rights under this guarantee shall be forfeited and the Bank shall be relieved and discharged from all liabilities under this guarantee irrespective of whether or not the original bank guarantee is returned to the Bank.

We, _____ (indicate the name of the Bank) _____ lastly undertake not to revoke this guarantee during its currency except with the previous consent of the Employer in writing.

Any claim or dispute arising under the terms of this document shall only be enforced or settled in the courts of at Kolkata only.

Date _____ Day of _____
for _____ (indicate the name of the Bank) _____

(Signature of Authorised signatory)

¹ NAME AND ADDRESS OF THE VENDOR /CONTRACTOR / SUPPLIER .

² DETAILS ABOUT THE NOTICE OF AWARD/CONTRACT REFERENCE

³ PROJECT/SUPPLY DETAILS

⁴ BG AMOUNT IN FIGURES AND WORDS

⁵ VALIDITY DATE

⁶ DATE OF EXPIRY OF CLAIM PERIOD

⁷ BG AMOUNT IN FIGURES AND WORDS.

⁸ VALIDITY DATE

⁹ DATE OF EXPIRY OF CLAIM PERIOD

Note:

1. Units are advised that expiry of claim period may be kept 2/3 months after validity date.
2. In Case of Bank Guarantees submitted by Foreign Vendors-
 - a. **From Nationalized/Public Sector / Private Sector/ Foreign Banks (BG issued by Branches in India)** can be accepted subject to the condition that the Bank Guarantee should be enforceable in the town/city or at nearest branch where the Unit is located i.e. Demand can be presented at the Branch located in the town/city or at nearest branch where the Unit is located.
 - b. **From Foreign Banks (wherein Foreign Vendors intend to provide BG from local branch of the Vendor country's Bank)**
 - b.1 In such cases, in the Tender Enquiry/ Contract itself, it may be clearly specified that Bank Guarantee issued by **any of the Consortium Banks only** will be accepted by BHEL. As such, Foreign Vendor needs to make necessary arrangements for issuance of Counter-Guarantee by Foreign Bank in favour of the Indian Bank (BHEL's Consortium Bank). It is

advisable that all charges for issuance of Bank Guarantee/ counter- Guarantee should be borne by the Foreign Vendor. The tender stipulation should clearly specify these requirements.

- b.2** In case, Foreign Vendors intend to provide BG from Overseas Branch of our Consortium Bank (e.g. if a BG is to be issued by SBI Frankfurt), the same is acceptable. However, the procedure at **sl.no. b.1** will required to be followed.
- b.3** The BG issued may preferably be subject to Uniform Rules for Demand Guarantees (URDG) 758 (as amended from time to time). In case, of Foreign Vendors, the BG Format provided to them should clearly specify the same.
- b.4** The BG should clearly specify that the demand or other document can be presented in electronic form.

BANK GUARANTEE FOR PERFORMANCE SECURITY

Bank Guarantee No:

Date:

To

NAME

& ADDRESSES OF THE BENEFICIARY

Dear Sirs,

In consideration of the Bharat Heavy Electricals Limited (hereinafter referred to as the 'Employer' which expression shall unless repugnant to the context or meaning thereof, include its successors and permitted assigns) incorporated under the Companies Act, 1956 and having its registered office at BHEL House, Siri Fort, Asiad, New Delhi – 110049 through its Unit at Bharat Heavy Electricals Limited, Power Sector Eastern Region, BHEL Bhawan, Plot No 9/1, DJ Block, Sector-II, Salt lake City, Kolkata – 700091 having awarded to (Name of the Vendor / Contractor / Supplier) having its registered office at _____¹ hereinafter referred to as the 'Contractor/Supplier', which expression shall unless repugnant to the context or meaning thereof, include its successors and permitted assigns), a contract Ref No.....dated² valued at Rs.....² (Rupees -----)for <Nature of Work>³ (hereinafter called the 'Contract') and the Contractor having agreed to provide a Contract Performance Guarantee, equivalent to% (... Percent) of the said value of the Contract to the Employer for the faithful performance of the Contract,

we,, (hereinafter referred to as the Bank), having registered/Head office at and inter alia a branch at being the Guarantor under this Guarantee, hereby, irrevocably and unconditionally undertake to forthwith and immediately pay to the Employer a maximum amount Rs ----- (Rupees -----)⁴ without any demur, immediately on a demand from the Employer, . Any such demand made on the Bank shall be conclusive as regards the amount due and payable by the Bank under this guarantee. However, our liability under this guarantee shall be restricted to an amount not exceeding Rs. _____.

We undertake to pay to the Employer any money so demanded notwithstanding any dispute or disputes raised by the Contractor/ Supplier in any suit or proceeding pending before any Court or Tribunal relating thereto our liability under this present being absolute and unequivocal.

The payment so made by us under this Guarantee shall be a valid discharge of our liability for payment thereunder and the contractors/supplier shall have no claim against us for making such payment.

We thebank further agree that the guarantee herein contained shall remain in full force and effect during the period that would be taken for the performance of the said Contract and that it shall continue to be enforceable till all the dues of the Employer under or by virtue of the said Contract have been fully paid and its claims satisfied or discharged.

We BANK further agree with the Employer that the Employer shall have the fullest liberty without our consent and without affecting in any manner our obligations hereunder to vary any of the terms and conditions of the said Contract or to extend time of performance by the said Contractor/Supplier from time to time or to postpone for any time or from time to time any of the powers exercisable by the Employer against the said Contractor/Supplier and to forbear or enforce any of the terms and conditions relating to the said Agreement and we shall not be relieved from our liability by reason of any such variation, or extension being granted to the said Contractor/Supplier or for any forbearance, act or omission on the part of the Employer or any indulgence by the Employer to the said Contractor/Supplier or by any such matter or thing whatsoever which under the law relating to sureties would but for this provision have effect of so relieving us.

The Bank also agrees that the Employer at its option shall be entitled to enforce this Guarantee against the Bank as a principal debtor, in the first instance without proceeding against the Contractor and notwithstanding any security or other guarantee that the Employer may have in relation to the Contractor's liabilities.

This Guarantee shall remain in force upto and including.....⁵ and shall be extended from time to time for such period as may be desired by Employer.

This Guarantee shall not be determined or affected by liquidation or winding up, dissolution or change of constitution or insolvency of the Contractor/Supplier but shall in all respects and for all purposes be binding and operative until payment of all money payable to the Employer in terms thereof.

Unless a demand or claim under this guarantee is made on us in writing on or before the⁶ (3 months more than the present date of validity of Bank Guarantee) we shall be discharged from all liabilities under this guarantee thereafter.

We, BANK lastly undertake not to revoke this guarantee during its currency except with the previous consent of the Employer in writing.

Notwithstanding anything to the contrary contained hereinabove:

- a) The liability of the Bank under this Guarantee shall not exceed.....⁷
- b) This Guarantee shall be valid up to⁸
- c) Unless the Bank is served a written claim or demand on or before _____⁹ (3 months more than the present date of validity of Bank Guarantee) all rights under this guarantee shall be forfeited and the Bank shall be relieved and discharged from all liabilities under this guarantee irrespective of whether or not the original bank guarantee is returned to the Bank.

We, _____ Bank, have power to issue this Guarantee under law and the undersigned as a duly authorized person has full powers to sign this Guarantee on behalf of the Bank.

Any claim or dispute arising under the terms of this document shall only be enforced or settled in the courts of at Kolkata only.

For and on behalf of
(Name of the Bank)

Dated.....

Place of Issue.....

¹ NAME AND ADDRESS OF THE VENDOR /CONTRACTOR / SUPPLIER.

² DETAILS ABOUT THE NOTICE OF AWARD/CONTRACT REFERENCE

³ PROJECT/SUPPLY DETAILS

⁴ BG AMOUNT IN FIGURES AND WORDS

⁵ VALIDITY DATE

⁶ DATE OF EXPIRY OF CLAIM PERIOD

⁷ BG AMOUNT IN FIGURES AND WORDS.

⁸ VALIDITY DATE

⁹ DATE OF EXPIRY OF CLAIM PERIOD

Note:

1. Units are advised that expiry of claim period may be kept 2/3 months after validity date.

2. In Case of Bank Guarantees submitted by Foreign Vendors-

a. From Nationalized/Public Sector / Private Sector/ Foreign Banks (BG issued by Branches in India) can be accepted subject to the condition that the Bank Guarantee should be enforceable in the town/city or at nearest branch where the Unit is located i.e. Demand can be presented at the Branch located in the town/city or at nearest branch where the Unit is located.

b. From Foreign Banks (wherein Foreign Vendors intend to provide BG from local branch of the Vendor country's Bank)

b.1 In such cases, in the Tender Enquiry/ Contract itself, it may be clearly specified that Bank Guarantee issued by **any of the Consortium Banks only** will be accepted by BHEL. As such, Foreign Vendor needs to make necessary arrangements for issuance of Counter- Guarantee by Foreign Bank in favour of the Indian Bank (BHEL's Consortium Bank). It is advisable that all charges for issuance of Bank Guarantee/ counter- Guarantee should be borne by the Foreign Vendor. The tender stipulation should clearly specify these requirements.

b.2 In case, Foreign Vendors intend to provide BG from Overseas Branch of our Consortium Bank (e.g. if a BG is to be issued by SBI Frankfurt), the same is acceptable. However, the procedure at **sl.no. b.1** will required to be followed.

- b.3** The BG issued may preferably be subject to Uniform Rules for Demand Guarantees (URDG) 758 (as amended from time to time). In case, of Foreign Vendors, the BG Format provided to them should clearly specify the same.
- b.4** The BG should clearly specify that the demand or other document can be presented in electronic form.

List of Consortium Banks *			
	Nationalised Banks		Nationalised Banks
1	Allahabad bank	19	Vijaya Bank
2	Andhra bank		Public Sector Banks
3	Bank of Baroda	20	IDBI
4	Canara Bank		Foreign banks
5	Corporation bank	21	CITI Bank N.A
6	Central bank	22	Deutsche Bank AG
7	Indian Bank	23	The Hongkong and Shanghai Banking Corporation Limited
8	Indian Oversea Bank	24	Standard Chartered Bank
9	Oriental bank of Commerce	25	J P Morgan
10	Punjab National Bank		
11	Punjab & Sindh Bank		Private banks
12	State Bank of India	26	Axis Bank
13	State Bank of Hyderabad	27	The Federal Bank Limited
14	Syndicate Bank	28	HDFC
15	State Bank of Travancore	29	Kotak Mahindra Bank
16	UCO Bank	30	ICICI
17	Union Bank of India	31	Indusind Bank
18	United Bank of India	32	Yes Bank

* wef 22.03.2016

RTGS FORMAT

Form for getting payment through RTGS (Real Time Gross Settlement)

01. NAME OF VENDOR
02. ADDRESS
03. VENDOR'S BANK A/C NAME
04. VENDOR'S BANK A/C NO.
05. NAME OF BANK
06. NAME OF BRANCH
07. BRANCH PH. NO.
08. CITY
09. IFSC CODE OF THE BRANCH

THE CHARGES IF ANY FOR PAYMENT THROUGH RTGS MAY BE RECOVERED FROM THE BILL SUBMITTED BY US.

SIGNATURE OF AUTHORISED REPRESENTATIVE
OF VENDOR WITH DATE & SEAL

CONFIRMATION BY BANKER WITH
OFFICE SEAL

Note : Incorrect information will crate accounting complications and payment will be delayed.

RTGS DETAILS OF BHEL-PSER FOR EFT BY BIDDER/CONTRACTOR

Form for getting payment through RTGS (Real Time Gross Settlement)

01. Name of Vendor **BHARAT HEAVY ELECTRICALS LTD.**
 02. Address **~~BHEL~~ BHEL HOUSE, SIRI FORT, N.DELHI**
 03. Vendors Bank A/c Name **BHARAT HEAVY ELECTRICALS LTD.**
 04. Vendors Bank A/c No. **11107800029**
 05. Name of Bank **STATE BANK OF INDIA**
 06. Name of Branch **COMMERCIAL BR., SALT LAKE, SECTOR-V**
 07. Branch Phone No. **KOLKATA**
 08. City **033-23575666**
 09. IFSC Code of the Branch **KOLKATA**
SBIN 0004289

The charges if any for payment through RTGS may be recovered from the Bill submitted by us.

Signature of Authorised Representative of Vendor
के. के. कोआरी / K. K. Coari
 उप महाप्रबंधक (वित्त) / Dy. General Manager (Fin)
 बी. एच. ई. एल. : पी.एस.ई.आर : कोलकाता - 700 091
 BHEL:PSER / Kolkata-700 091

Confirmation by Banker with office seal



Note : Incorrect information will create Accounting complications and payment will be delayed



**GENERAL & SPECIAL CONDITIONS
OF CONTRACT [FOR SERVICES JOB]**

**PSER
KOLKATA**

SECTION – I
Instructions to Tenderers
GENERAL INSTRUCTION TO TENDERERS

1.1 Submission of Tender in “Three Parts”.

- (1) Technical Tender: All particulars asked for from the Vendor except the Price Bid & E.M.D in an envelope.
- (2) EMD in a sealed envelope clearly superscribing on the envelope “E.M.D”, the Tender Number, Name of Work, addresses of Vendor and addressee. One time EMD holders needn’t enclose this provided that proof of EMD remittance is enclosed in the technical tender.
- (3) Price Bid in the price schedule enclosed in the tender, in sealed envelope, clearly superscribing “Price Bid”, Tender Number, Name of Work, Name of the Vendor and addressee.

All the above “Parts” can be placed in an sufficiently large outer envelope for submission.

1.1.1a This Tender specification as a whole, duly furnishing the following details shall be duly signed and sent in a sealed cover superscribing :

TENDER		FOR
TENDER	SPECIFICATION	NO.
DUE ON _____		

1.1.1b DURATION OF JOB

1.1.1.1 Earnest Money Deposit.

1.1.1.2 Income Tax & Sales Tax Clearance Certificate.

1.1.1.3 Detailed organisation chart for manpower resources available with the tenderer and to be employed for the present jobs.

1.1.1.4 Time to be taken for commencement and completion of Work.

1.1.1.5 A list of experience as mentioned in the tender document.

1.1.1.6 The details of the present jobs being handled.

1.1.1.7 Certificate from the BHEL’s scheduled Banks to establish financial capability of the tenderer as per format enclosed at Annexure-I.

1.1.1.8 Attested copies of partnership deed, power of attorney and tender specifications duly signed as mentioned in the tender documents.

1.1.1.9 Price schedule and other relevant information.

NOTE: All Xerox copies enclosed by the Vendor should be attested and sealed for authenticity.



**GENERAL & SPECIAL CONDITIONS
OF CONTRACT [FOR SERVICES JOB]**

**PSER
KOLKATA**

- 1.1.2 The tender shall be addressed to:
**HEAD, PURCHASE DEPARTMENT
 BHARAT HEAVY ELECTRICALS LIMITED,
 POWER SECTOR, EASTERN REGION, (2ND FLOOR),
 PLOT-9/1, BLOCK-DJ, SECTOR-II, SALT LAKE,
 KOLKATA – 700091.**
- 1.1.3 Tenders submitted by post shall be sent “REGISTERED POST ACKNOWLEDGEMENT DUE” and shall be posted with the due allowance for any postal delay. The tenders received after the due date and time of opening are liable to be rejected. Telegraphic offers and offers received by telex may not be considered unless confirmed in writing by a detailed offer.
- 1.1.4 Tenders shall be opened by the authorised officer of BHEL at his office at the time and date as specified in the tender notice in the presence of such of those tenderers or their authorised representatives who may be present.
- 1.1.5 The Tenderer shall closely peruse all the clauses, specifications and drawings indicated in the Tender Documents before quoting. Should the tenderer have any doubt about the meaning of any portion of the Tender Specifications or find discrepancies or omission in the drawings or the tender documents issued are incomplete or shall require clarification on any of the technical aspect, scope of work etc., he shall at once contact the authority inviting the tender for clarification before the submission of the offer.
- 1.1.6 Before tendering, the tenderer is advised to inspect the site of work and the environments and be well acquainted with the actual working and other prevalent conditions, facilities available, position of material and labour. No claim will be entertained later on the ground of lack of knowledge.
- 1.1.7 Tenderers must fill up all the schedules and furnish all the required information as per the instructions given in various sections of the tender specification. Each and every page of the Tender Specification & deceleration must be signed bearing seal and submitted along with the offers by the Tender in token of complete acceptance thereof. The information furnished shall be complete by itself. The booklet of G.S.C.C may be retained by the bidder if deceleration is enclosed along with the bid duly filled in and signed and sealed.
- 1.1.8 The tender shall quote the rates in English language and international numerals. The rates shall be in whole rupees. These rates shall be entered in figures as well as in words. For the purpose of the tender, the metric system of units shall be used.
- 1.1.9 All entries in the tender shall either be typed or be in ink. Erasures and overwriting are not permitted and may render such tenders liable to summary rejection. All cancellations and insertions shall be duly attested by the tenderer.
- 1.2 Qualifications of Tenderers:
 Only tenderers who have previous experience in work of this nature and description detailed in this tender specification and/or registered with BHEL, PS-ER-SAS for such works are expected to quote for this work duly detailing their experience along with the offer. Offers from tenderers who do not have established experience in the field are not likely to be considered.



**GENERAL & SPECIAL CONDITIONS
OF CONTRACT [FOR SERVICES JOB]**

**PSER
KOLKATA**

1.3 Data to be enclosed:

Full information shall be given by the tender in respect of following. Non-submission of this information may lead to rejection of the offer/tender.

1.3.1 Financial Status:

- a) A certificate from BHEL's scheduled Bank to prove his financial capacity/capability to undertakes the work of solvency certificate from the concerned Government Authority.
- b) Contractors other than those who are registered in ER, should submit their audited annual accounts for three years preceding the financial year in which tenders are called for.

1.3.2 Income Tax / Sales Tax Certificate :

A certificate of Income Tax / Sales Tax verification from the appropriate authority in the forms prescribed therefor duly indicating annual turnover. The certificates shall be valid for one year from the date of issue or for the period prescribed therein for all tenders submitted during the period.

1.3.3 Previous Experience:

A statement giving particulars duly supported by documentary evidence of the various services rendered for each similar work by the tenderer indicating the particulars and value of each work, the site location and the duration and date of completion and also a list of site locations and particulars and value of various services that are under progress.

1.3.4 Organisation Chart:

The organisation pattern that is totally available with the tenderer and that will be employed by the tenderer for this work duly indicating the number of Engineers and Supervisors, their qualification and experience in the line, the number of skilled and unskilled workmen etc.

- 1.3.5** An attested copy of the Power of Attorney, in case the tender is signed by an individual other than the sole proprietor, shall also be attached.

1.3.6 In case of an individual:

His full name, address and place and nature of business.

1.3.7 In case of Partnership firms:

The name of all the partners and their addresses. A copy of the Partnership Deed (Instrument of partnership) duly certified by the Notary Public shall be enclosed.

1.3.8 In case of Companies:

Date and place of registration including Date of Commencement Certificate in case of public companies (certified copies of Memorandum and Articles of Associations are also to be furnished).



**GENERAL & SPECIAL CONDITIONS
OF CONTRACT [FOR SERVICES JOB]**

**PSER
KOLKATA**

- 1.3.9 Nature of business carried on by the Company and the provision of the Memorandum relating thereof.
- 1.3.10 Names and particulars including addresses of all the Directors and their previous experience.
- 1.3.11 A list of tools and tackles that the tenderer is having and those that will be earmarked for this job.
- 1.3.12 In addition to the above, the particulars required in various annexures.

1.4 EARNEST MONEY DEPOSIT (EMD):

- 1.4.1 Every tender Must be accompanied by the prescribed amount of Earnest Money Deposit in any one of the following forms:
- 1.4.1.1 **Cash deposit as permissible under the extant Income Tax Act** (Before tender opening) - The amount should be remitted by the party to the Cashier of Bharat Heavy Electricals Limited, PS-ER, Kolkata between 14.00 hours and 16.00 hours on working days and cash receipt issued by him shall be enclosed along with the tender.
- 1.4.1.2 **Electronic Fund Transfer** credited in Bharat Heavy Electricals Limited, PS-ER' account (before tender opening). RTGS details of BHEL-PSER is available in tender.
- 1.4.1.3 **Banker's Cheque/Pay Order/Demand Draft** payable at Kolkata duly pledged in Favour of Bharat Heavy Electricals Limited, Kolkata (along with offer).
- 1.4.1.4 **Fixed Deposit Receipt (FDR)** issued by Scheduled Banks/ Public Financial Institutions as defined in the Companies Act (FDR should be in the name of the Contractor, a/c BHEL).
- 1.4.1.5 **Any other mode as per latest guidelines issued by Govt. of India.**

In addition to above, the EMD amount in excess of Rs. 2 Lakh may also be accepted in the form of Bank Guarantee from scheduled bank. The Bank Guarantee in such cases shall be valid for atleast six months.

- 1.4.1.6 Parties/bidders who have submitted/submits **One Time EMD (OEMD) in this Power Sector Region (i.e. BHEL-PSER) for Service After Sales (SAS) a sum of amount Rs. 5,00,000/- (Rupees Five Lakh only)** are exempted from payment of E.M.D. on each such tender in that unit on case to case basis.
- 1.4.2 Tenders received without Earnest Money in full in the manner prescribed above are liable to be rejected. EMD shall not carry any interest.
- 1.4.3 The Earnest Money Deposit of the successful tenderer will be retained as part of Security Deposit.
- 1.4.4 EMD given by all unsuccessful tenderers shall be refunded normally within 15 days of award of work.
- 1.4.5 BHEL reserves the right of forfeiture of Earnest Money Deposit submitted by the tenderer if:-
- a) After opening the tender and within the offer validity period, the tenderer revokes his tender or makes any modification in his tender which is not acceptable to BHEL.
 - b) The Contractor fails to deposit the required Security Deposit or commence the work within the period as per LOI/Contract.

EMD by the tenderer shall be withheld in case any action on the tenderer is envisaged under the provisions of extant "Guidelines on Suspension of business dealings with suppliers/contractors" and forfeited/released based on the action as determined under these guidelines".



**GENERAL & SPECIAL CONDITIONS
OF CONTRACT [FOR SERVICES JOB]**

**PSER
KOLKATA**

1.5 Authorisation and Attestation:

1.5.1 Tenders shall be signed by persons duly authorised/empowered to do so. Certified copies of such authority and relevant documents shall be submitted along with the tenders.

1.6 Validity of Offer:

The rates in the tender shall be kept open for acceptance for a minimum period of six months from the due date of opening of tenders. If a tenderer withdraws or revokes his tender or increases the tender rates and/or conditions for any item within the aforesaid period, his Earnest Money Deposit is liable to be forfeited. In case the Bharat Heavy Electricals Limited calls for negotiations, such negotiation shall not amount to cancellation or withdrawal of the original offer which shall be binding on the tenderers.

1.7 Execution of Contract:

The successful tender's responsibility under this contract commences from the date of issue of the Letter of Intent by Bharat Heavy Electricals Limited. The successful tenderer may be required to execute an agreement in the prescribed form with the BHEL within a reasonable time after the acceptance of his tender and in any case before submitting first RA bill for payment. The expenses for completing and stamping the agreement shall be borne by the tenderer.

1.8 Security Deposit (SD):

1.8.1 Security Deposit means the security provided by the contractor towards fulfilment of any obligations in terms of the provisions of the contract. Upon acceptance of tender, the successful tenderer within the time specified in the Letter of Intent must deposit the required amount towards Security Deposit before start of the work. The Security Deposit shall not carry any interest.

1.8.2 The total amount of **Security Deposit will be 5% (Five percent) of the contract value.** EMD of the successful tenderer shall be converted and adjusted towards the required amount of Security Deposit.

1.8.3 If the value of the work done at any time exceeds the accepted agreement value, the Security Deposit shall be correspondingly enhanced and the additional Security Deposit shall immediately be deposited by the contractor or recovered from payments due to the contractor.

1.8.4 Regarding adjustment of Earnest Money Deposit towards part of Security Deposit, refer clause 1.8.2 above, the successful tenderer shall not commence any work under the contract before remitting the Security Deposit except as directed by BHEL.

1.8.5 Failure to deposit the Security within the stipulated time may lead to forfeiture of Earnest Money and cancellation of the award of work.

1.8.6 The balance amount to make up the required Security Deposit of 5% of the contract value may be furnished in any one of the following forms:

- i) Cash (as permissible under the Income Tax Act)
- ii) Local cheques of scheduled banks (subject to realization)/Pay Order/Demand Draft/Electronic Fund Transfer credited in Bharat Heavy Electricals Limited, PS-ER' account.



**GENERAL & SPECIAL CONDITIONS
OF CONTRACT [FOR SERVICES JOB]**

**PSER
KOLKATA**

iii) Bank Guarantee from Scheduled Banks / Public Financial Institutions as defined in the Companies Act. The Bank Guarantee format should have the approval of BHEL. Bank Guarantee for S.D. must be posted by the Bank by registered post directly to us, and it should not be submitted by the bidder directly to us.

iv) Fixed Deposit Receipt issued by Scheduled Banks / Public Financial Institutions as defined in the Companies Act (FDR should be in the name of the contractor, A/C BHEL).

v) Securities available from Indian Post Offices such as National Savings Certificates, Kisan Vikas Patras etc. (held in the name of Contractor furnishing the security and duly endorsed/hypothecated/ pledged, as applicable, in favour of BHEL).

vi) Any other mode as per latest guidelines issued by Govt. of India.

Note: BHEL will not be liable or responsible in any manner for the collection of interest or renewal of the documents or in any other matter connected therewith.

1.8.7 Collection of Security Deposit:

1.8.7.1 At least 50% of the required Security Deposit, including EMD, should be collected before start of work. Balance of the Security Deposit can be collected by deducting 10% of the gross amount progressively from each of the running bills of the contractor till the amount of the required Security Deposit is collected.

1.8.7.2 If the value of the work done at any time exceeds the accepted agreement value, the Security Deposit shall be correspondingly enhanced and the additional Security Deposit shall immediately be deposited by the contractor or recovered from payments due to the contractor.

1.8.7.3 The recoveries made from running bills (cash deduction towards balance SD amount) can be released against submission of equivalent Bank Guarantee in acceptable form, but only once, before completion of work, subject to approval of BHEL.

1.8.7.4 Security Deposit should cover up to the period of guarantee also.

(Note: In case of SAS jobs, work can be started before the required Security Deposit is collected. However, payment can be released only after collection/ recovery of initial 50% Security Deposit).

1.8.8 BHEL reserves the right of forfeiture of Security Deposit in addition to other claim and penalties in the event of the contractor's failure to fulfil any of the contractual obligations including statutory or in the event of termination of contract as per terms and conditions of contract.

1.8.9 Return of Security Deposit:

If the contractor duly performs and completes the contract in all respects to the entire satisfaction of BHEL, and presents an absolute "No Demand Certificate" in the prescribed form and return properties belonging to BHEL handed over, lent or hired by him for carrying out the said works the security deposit will be released to the contractor after deducting all costs or expenses or other contracts entered into with the contractor, only after the satisfactory completion or guarantee period as per clause 2.13.

1.8.10 No interest shall be payable by BHEL on Earnest Money / Security Deposit or any money due to the contractor from BHEL.

1.8.11 In no case Security Deposit can be released before settling all claims under this contract.



**GENERAL & SPECIAL CONDITIONS
OF CONTRACT [FOR SERVICES JOB]**

**PSER
KOLKATA**

1.9 Rejection of Tender and other conditions:

1.9.1 The acceptance of tender will rest with BHEL which does not bind itself to accept the lowest tender or any tender and reserves to itself full rights for the following without assigning any reasons whatsoever:

- a) to reject any or all of the tenders.
- b) To split up the work amongst two or more tenderers.
- c) To award the work in part.
- d) Either of the contingencies stated in (b) and (c) to modify the time for completion suitably.
- e) To modify the scope of work after mutual agreement.

1.9.2 Conditional and unwitnessed tenders:

Tenders containing absurd or unworkable rates and amounts and tenders which are incomplete and otherwise considered defective and tenders not in accordance with the tender conditions, specifications etc. are liable to be rejected.

1.9.3 If a tenderer expires after his submission of the tender or after the acceptance of his tender, BHEL may at their discretion, cancel such tender. If a partner of a firm expires after the submission of the tender or after the acceptance of the tender, BHEL may cancel such tender at their discretion unless the firm retains its character.

1.9.4 BHEL will not be bound by any Power of Attorney granted by the tenderer or by changes in the compositions of the firm made subsequent to the execution of the contract. They may, however, recognise such power of Attorney and changes after obtaining proper legal advice, the cost of which will be chargeable to the contractor concerned.

1.9.5 If the tenderer deliberately gives wrong information in his tender, BHEL reserves the right to reject such tender at any stage or to cancel the contract, if awarded and forfeit the Earnest Money/Security Deposit.

1.9.6 Canvassing in any form in connection with the tenders is strictly prohibited and the tenders submitted by the contractor who resort to canvassing are liable to rejection.

1.9.7 Should a tenderer or contractor or in the case of a firm or Company of Contractors one or more of its Partners/shareholders/Directors have a relation or relations employed in the capacity of an officer of BHEL, the authority inviting tender shall be informed of the fact along with the offer, failing this, BHEL may at its sole discretion, reject the tender or cancel the contract and forfeit the Earnest Money/Security Deposit.

1.9.8 The successful tenderer should not sub-contract the part or complete work detailed in this tender specification undertaken by him without permission of BHEL. The tenderer is solely responsible to BHEL for the work awarded to him. Any deviation in this regard will entail termination of such contract by BHEL at the risk and responsibility of contractor.

1.9.9 The successful tenderer shall inform/keep BHEL informed if he has already undertaken any work/is likely to be awarded any job with the same customer with whom BHEL is entering into contract.



**GENERAL & SPECIAL CONDITIONS
OF CONTRACT [FOR SERVICES JOB]**

**PSER
KOLKATA**

SECTION – II

GENERAL TERMS & CONDITIONS OF THE CONTRACT

2.1 Definition:

The following terms and expressions shall have the meaning hereby assigned to them except where they context otherwise requires:

- 2.1.1 'BHEL' (or B.H.E. Ltd.) shall mean Bharat Heavy Electricals Limited, a company registered under Indian Companies Act., 1956, with its Registered Office at BHEL House, SIRI FORT, NEW DELHI-110049, Power Sector, Eastern Region, Service After Sales – Services, DJ-9/1, Salt Lake, Kolkata – 700091 or its Administrative officers or its site Engineer or the employees authorised to deal with any matters with which these persons are concerned on its behalf.
- 2.1.2 "GENERAL MANAGER"/DEPUTY IN CHARGE" shall mean the Officer in Administrative charge of BHEL, PS-ER, SAS – Services, Kolkata or their other regional offices.
- 2.1.3 "ENGINEER" or "ENGINEER IN CHARGE" shall mean Engineer deputed by BHEL. The terms include "SITE ENGINEER", "RESIDENT ENGINEER" and "ASSISTANT SITE ENGINEER" of BHEL at the site as well s the officers in-charge at Kolkata office.
- 2.1.4 "SITE" shall mean the place or places at which the plants/equipment are to be overhauled and services are to be performed as per the specification of this contract.
- 2.1.5 "CLIENTS OF BHEL" or "CUSTOMER" shall mean the Project authorities to whom BHEL is supplying the equipment/services.
- 2.1.6 "CONTRACTOR" shall mean the individual, firm or company who enters into this contract with BHEL and shall include their executors, administrators, successors and permitted assigns.
- 2.1.7 "CONTRACT" or "CONTRACT DOCUMENT" shall mean and include the agreement or work order, the accepted appendices of rates, schedule of quantities, if any and general condition of contract, the special conditioning of contract instructions of the tenderers, the drawings, the specifications, the special specification, if any, the tender specifications, the special specification, if any, the tender documents and the Letter of Intent/Accepting Letter issued by BHEL. Any conditions or terms stipulated by the contractor in the tender documents or supporting letters shall not form part of the contract unless specifically accepted in writing by BHEL and incorporated in the agreement.
- 2.1.8 "GENERAL CONDITIONS OF CONTRACT" shall mean the instructions to tenderers and general conditions of contract pertaining to the work detailed.
- 2.1.9 "TENDER SPECIFICATION" shall mean the "Specific Conditions, technical specifications, appendices, site information and drawings, "pertaining to the work for which the tenderers are required to submit their offer. Also this will include the specifications detailed in NIT of client of BHEL for overhauling, erection, testing and commissioning of plant. Individual specification no. will be assigned to each tender specification.



**GENERAL & SPECIAL CONDITIONS
OF CONTRACT [FOR SERVICES JOB]**

**PSER
KOLKATA**

- 2.1.10 "TENDER DOCUMENTS" shall mean the General conditions of contract (2.1.8) and tender specification (2.1.9)
- 2.1.11 "LETTER OF INTENT" shall mean the intimation by a letter to the tenderer that the tender has been accepted in accordance with provisions contained in that letters. The responsibility of the contractor commences from the date of issue of this letter and all the terms and conditions of contract are applicable from this date.
- 2.1.12 "COMPLETION TIME" shall mean the period by date specified in the acceptance of tender for handing over the overhauled equipment/plant which are found acceptable by the engineer being of required standard and conforming to the specification of the contract or recommissioning of the machine successfully whichever is later. Completion time will be reckoned from the date of LOI with the period for mobilisation as prided with LOI, added to the same.
- 2.1.13 "PLANT" shall mean and cannot the entire assembly of the plant and equipments covered by the contract.
- 2.1.14 "EQUIPMENT" shall mean all equipments, machineries, materials, structurals, electricals and other components of the plant covered by the contract.
- 2.1.15 "TESTS" shall mean and include such test or tests to be carried out on the part of the contractor as are prescribed in the contract or considered necessary by BHEL, in order to ascertain the quality workmanship, performance and efficiency of the contract work or part thereof.
- 2.1.16 "APPROVED" "DIRECTED" or "INSTRUCTED" shall mean approved, directed or instructed by BHEL.
- 2.1.17 "WORK OR CONTRACT WORK" shall mean and include supply of all categories of labour, specified consumables, tools and tackles required for complete and satisfactory site transportation, handling, stacking, storing, overhauling erection, testing and commissioning of the equipment to the entire satisfaction of BHEL.
- 2.1.18 "SINGULAR AND PLURAL ETC" words carrying singular number shall also include plural and vice versa, where the context so requires, words importing the masculine gender shall be taken to include any company or Association or body of individuals, whether incorporated or not.
- 2.1.19 "HEADINGS" The Leadings in these general conditions are solely for the purpose of facilitating reference and shall not be deemed to be part thereof or be taken into consideration in interpretation or construction thereof or of the contract.
- 2.1.20 "MONTH" shall mean calendar month.
- 2.1.21 "WRITING" shall include any manuscript, type written or printed statement under the signature or seal as the case may be.
- 2.2 Law governing the contract and Court Jurisdiction:

The contract shall be governing by the Law for the time being in force in the Republic of India. The Civil Court having ordinary original civil jurisdiction, Kolkata shall alone have exclusive Jurisdiction in regard to all claims in respective of this contract.



**GENERAL & SPECIAL CONDITIONS
OF CONTRACT [FOR SERVICES JOB]**

**PSER
KOLKATA**

2.3 Issue of Notice:

The contractor shall furnish to the BHEL Engineer the name, designation and address of his authorised agent and all complaints, notices, communications and reference shall be deemed to have been duly given to the contractor if delivered to the contractor or his authorised agent or left at or posted to the address either of the contractor or of his representative and shall be deemed to have been so given in the case of posting on the day on which they would have reached such address in the ordinary course of past or on which they were so delivered or/or left.

2.4 Use of Land:

No land belonging to BHEL or their customer, under temporary possession of BHEL shall be occupied by the contractor without the written permission of BHEL.

2.5 Commencement of Work:

2.5.1 The contractor shall commence the work within the time indicated in the Letter of Intent from BHEL and shall proceed with the same with due expedition without delay. For computing the scheduled completion date, commencement, of work will be reckoned from the date of complete mobilisation as per LOI, unless specifically amended by Head (Services), BHEL, Kolkata.

2.5.2 If the successful tenderer fails to start the work within the stipulated time, BHEL as its discretion will have the right to cancel the contract. His Earnest Money and / or Security Deposit with BHEL will stand forfeited without any further reference to him, without prejudice to any and all of BHEL's other rights and remedies in this regard.

2.5.3 All the works shall be carried out under the direction and to the satisfaction of BHEL.

2.5.4 The erected overhauled plant or work performed under the contract shall be taken over when it has been completed in all respects and or satisfactorily put into operation at site.

2.6 Mode of payment and measurement of the work completed.

2.6.1 "All payment due to the contractor shall be paid only by Account payee Cheques"

2.6.2 The contractor shall present his bill on the format prescribed by BHEL for every payment. After verification of such bills by BHEL, all items having financial value shall be entered and certified in BHEL Measurement Book by BHEL Engineer and the bills prepared based on the same and connected technical documents which form part of this tender specification.

2.6.3 Lump sum omission will be entered for deduction. Measurement shall be restricted to that for which it is required to ascertain the financial liability of BHEL under this Contract.

2.6.4 Work which is to be measured in details shall be measured as per standard procedure without reference to any local procedures without reference to any local procedures excepting where it is otherwise stated in the tender documents. The measurement shall be taken jointly by person duly authorised on the part of BHEL and by the contractor.



**GENERAL & SPECIAL CONDITIONS
OF CONTRACT [FOR SERVICES JOB]**

**PSER
KOLKATA**

- 2.6.5 If, at any time due to reason whatsoever, it becomes necessary to remeasure the work done in full or in part, the expenses towards such remeasurement shall be borne by the contractor.
- 2.6.6.1 The contractor shall bear the expenditure involved, if any, in making the measurement. The Contractor shall, without extra charges, provide all the assistance with appliances with appliance and other things necessary for measurement.
- 2.6.7 The measurement entered in the Measurement Books and the bills prepared shall be signed and dated by both the contracting parties.
- 2.6.8 The Contractor will be intimated in writing by the site Engineer, the proposed date of measurement. If the contractor, representative fails to participate in the joint measurement, the BHEL engineer shall have the power to proceed by himself to take measurement in which case the measurement shall be accepted by the contractor as final.
- 2.6.9 Passing of measurement as per bills does not amount to acceptance of the completion of work mentioned. Any left out work has to be completed if pointed out at a later date by BHEL.

2.7 Rights of BHEL:

- 2.7.1 To withdraw any portion of work and/or to restrict / alter the quantum of work as indicated in the contract during the progress of work and get it done through other agency and/or by departmental labour to suit BHEL's commitment to its customer or in case BHEL decides to advance the date of completion due to other emergency reasons / BHEL's obligation to its customer.
- 2.7.2 To terminate the contract or withdraw portion of work and get it done through other agency, at the risk and cost of the contractor after due notice of a period of 14 days' by BHEL in any of the following cases:
- i) Contractor's poor progress of the work vis-à-vis execution timeline as stipulated in the Contract, backlog attributable to contractor including unexecuted portion of work does not appear to be executable within balance available (#) period considering its performance of execution.
 - ii) Withdrawal from or abandonment of the work by contractor before completion of the work as per contract.
 - iii) Non-completion of work by the Contractor within scheduled completion period as per Contract or as extended from time to time, for the reasons attributable to the contractor.
 - iv) Termination of Contract on account of any other reason (s) attributable to Contractor.
 - v) Assignment, transfer, subletting of Contract without BHEL's written permission.
 - vi) Non-compliance to any contractual condition or any other default attributable to Contractor.
- (#) In-case inputs from BHEL/Customer are likely to be delayed or are actually delayed, this delay may also be taken into account while considering balance period available for execution of Contract.

Risk & Cost Amount against Balance Work:

Risk & Cost amount against balance work shall be calculated as follows:

$$\text{Risk \& Cost Amount} = [(A-B) + (A \times H/100)]$$

Where,

A= Value of Balance scope of Work (*) as per rates of new contract

B= Value of Balance scope of Work (*) as per rates of old contract being paid to the contractor at the time of termination of contract i.e. inclusive of PVC & ORC, if any.

H = Overhead Factor to be taken as 5

In case (A-B) is less than 0 (zero), value of (A-B) shall be taken as 0 (zero).



**GENERAL & SPECIAL CONDITIONS
OF CONTRACT [FOR SERVICES JOB]**

**PSER
KOLKATA**

(* Balance scope of work (in case of termination of contract):

Difference of Contract Quantities and Executed Quantities as on the date of issue of Letter for 'Termination of Contract', shall be taken as balance scope of Work for calculating risk & cost amount. Contract quantities are the quantities as per original contract. If, Contract has been amended, quantities as per amended Contract shall be considered as Contract Quantities.

Items for which total quantities to be executed have exceeded the Contract Quantities based on drawings issued to contractor from time to time till issue of Termination letter, then for these items total Quantities as per issued drawings would be deemed to be contract quantities.

Substitute/ extra items whose rates have already been approved would form part of contract quantities for this purpose. Substitute/ extra items which have been executed but rates have not been approved, would also form part of contract quantities for this purpose and rates of such items shall be determined in line with contractual provisions.

However, increase in quantities on account of additional scope in new tender shall not be considered for this purpose.

NOTE: In-case portion of work is being withdrawn at risk & cost of contractor instead of termination of contract, contract quantities pertaining to portion of work withdrawn shall be considered as 'Balance scope of work' for calculating Risk & Cost amount.

LD against delay in executed work in case of Termination of Contract:

LD against delay in executed work shall be calculated in line with LD clause as per GCC/SCC/TCC/Special note/any other annexure of tender document (in compliance with order of precedence), for the delay attributable to contractor. For limiting the maximum value of LD, contract value shall be taken as Executed Value of work till termination of contract.

Method for calculation of "LD against delay in executed work in case of termination of contract" is given below.

- i) Let the time period from scheduled date of start of work till termination of contract excluding the period of Hold (if any) not attributable to contractor = T1
- ii) Let the value of executed work till the time of termination of contract = X
- iii) Let the Total Executable Value of work for which inputs/fronts were made available to contractor and were planned for execution till termination of contract = Y
- iv) Delay in executed work attributable to contractor i.e. $T2 = [1 - (X/Y)] \times T1$
- v) LD shall be calculated in line with LD clause [as per GCC/SCC/TCC/Special note/any other annexure of tender document (in compliance with order of precedence)] of the Contract for the delay attributable to contractor taking "X" as Contract Value and "T2" as period of delay attributable to contractor.

2.7.3 Recoveries arising out of Risk & Cost and LD or any other recoveries due from Contractor

Following sequence shall be applicable for recoveries from contractor:

- a) Dues available in the form of Bills payable to contractor, SD, BGs against the same contract.
- b) Demand notice for deposit of balance recovery amount shall be sent to contractor, if funds are insufficient to effect complete recovery against dues indicated in (a) above.
- c) If contractor fails to deposit the balance amount to be recovered within the period as prescribed in demand notice, following action shall be taken for balance recovery:
 - i) Dues payable to contractor against other contracts in the same Region shall be considered for recovery.
 - ii) If recovery cannot be made out of dues payable to the contractor as above, balance amount to be recovered, shall be informed to other Regions/Units for making recovery from the Unpaid Bills/Running Bills/SD/BGs/Final Bills of contractor.
 - iii) In-case recoveries are not possible with any of the above available options, Legal action shall be initiated for recovery against contractor.

2.7.4 To terminate the contract or to restrict the quantum of work and pay for the portion of work executed in case BHEL's contract with their customers are terminated for any reason.



**GENERAL & SPECIAL CONDITIONS
OF CONTRACT [FOR SERVICES JOB]**

**PSER
KOLKATA**

- 2.7.5 While every endeavour will be made by BHEL they cannot guarantee uninterrupted work due to conditions beyond their control. Contractor will not be entitled to any compensation / extra payment on this account.
- 2.8 Responsibilities of the Contractor:
The following are the responsibilities of the contractor in respect of observation of local laws, employment of personnel, payment of taxes and execution of job etc.
- 2.8.1 As far as possible, unskilled workers shall be engaged from the local areas in which the work is being executed.
- 2.8.2 The Contractor at all times during the continuance of this contract, shall in all his dealing with local labour for the time being employed on or in connection with the work, have due regard to all local festivals and religious and other customs.
- 2.8.3 The contractor shall comply with all state and central Laws, Statutory Rules, Regulations etc., such as:
The payment of wages Act, Minimum Wage Act, Workmen compensation Act, Employers Liability Act, Industrial Disputes Act, Employees Provident Fund Scheme, Employees Insurance Scheme, Contract Labour (Regulation & Abolition) Act 1970 and other Acts, Rules & Regulations for labour as may be enacted by the Government during the tenure of the Contract and having force or jurisdiction at site. The Contractor shall give to the local Governing Body, Police and other relevant authorities all such notices as may be required by law.
- 2.8.4 The Contractor shall pay all taxes, fees, licence charges, deposits duties, tools, royalty, commission or other charges which may be leviable on account of any of his operations in executing the contract. In case, BHEL is forced to pay any of such taxes, BHEL shall have the right to recover the same from the contractor either from his bills or otherwise as deemed fit.
- 2.8.5 The Contractor shall be responsible for provision of health and sanitary arrangements, more particularly described in contract Labour (Regulation & Abolition Act) safety precautions etc., as may be required of same and satisfactory execution of the contract.
- 2.8.6 The contractor shall fulfil all his obligation in respect of accommodation including proper medical facilities for the personnel employed by him.
- 2.8.7 The contractor shall be responsible for the proper behaviour at site and observance of all regulations by the staff employed by him.
- 2.8.8 The Contractor shall ensure that no damage is caused to any person / property of other parties working at site. If any such damages is caused, it is the responsibility of the contractor to make the losses or compensate for the same.
- 2.8.9 All the properties / equipments / components of BHEL / their client loaned with or without deposit to the contractor in connection with the contract shall remain the properties of BHEL / their client. The Contractor shall use such properties for the purpose of execution of this contract. All such properties / equipment / components shall be deemed to be in good condition when received by the contractor unless he notified within 48 hours to the contrary. The Contractor shall return them in good conditions as and when required by BHEL / their client. In case of non-return, loss damage, repairs, etc. the cost thereof, as may be fixed by the site Engineer, will be recovered from the contractor.



**GENERAL & SPECIAL CONDITIONS
OF CONTRACT [FOR SERVICES JOB]**

**PSER
KOLKATA**

- 2.8.10 It is not obligatory on the part of BHEL to supply any tools and tackles or other materials other than those specifically agreed to do so by BHEL. However, depending upon the availability / possibility BHEL's customers' handling equipment and other plants may be made available to the contractor on payment of the hire charges / free of charges as fixed, subject to the condition laid down by BHEL. Customer form time to time, Unless paid in advance, such hire charges if applicable shall be recovered from contractor's bill / security Deposit in one instalment.
- 2.8.11 The contractor shall not claim any compensation of the scope of the work, due to changes in design which curtails quantum.
- 2.8.12 The Contractor shall fully indemnify BHEL against all claims of whatsoever nature arising during the course of erection / overhauling / performing work under the contract.
- 2.8.13 In case the contractor is required to undertake any major work outside the scope of this contract the rates payable shall be decided by BHEL Resident Engineer.
- 2.8.14 The contractor shall keep the area of work clean and shall remove debris etc., while executing day to day work. Upon completion of work, the contractor shall remove from the vicinity of work, all scrap, packing materials, rubbish, unused and other materials and deposit them in places to be specified by the BHEL Engineer. The contractor will also demolish all hutments, sheds, partitions, offices, constructed and used by him and shall clean the debris. In the event of his failure to do so, the same will be arranged to be removed by the BHEL. The expenses thereof will be recovered from contractor.
- 2.8.15 The contractor shall arrange and co-ordinate his work in such a manner as to cause no inconvenience to other agencies working in the area.
- 2.8.16 All safety rules and codes applied by the client / BHEL at site shall be observed by the contractor without exception. The contractor shall be responsible for the safety of the equipment / material and work to be performed by him and shall maintain all light, fencing guards, signs etc. or other protection necessary for the purpose. Contractor shall also take such additional precautions as may be indicated from time to time by the Engineer with a view to prevent pilferage, accidents, fire hazards and atmospheric conditions. Suitable number of electrical staff, watch and ward, store keepers to take care of the equipment, materials and construction tools and tackles, shall be posted at site by the contractor till completion of the work under this contract. The contractor shall arrange for such safety devices as are necessary for such type of work and carry out the requisite tests of handling equipment, lifting tools, tackles etc, as per prescribed standards and practices.
- 2.8.17 The contractor will be directly responsible for payment of wages to his workmen. A pay roll sheet giving all the payments given to workers and duly signed by the contractor's representative should be furnished to BHEL site office for record purpose. BHEL site In-charge may be intimated the date of disbursement of wages to the workmen engaged for the work, so that his representative can witness the same.
- 2.8.18 The intent of specification, is to provide services according to most modern and proven techniques and codes. The omission of specific reference to any method, requirement or material necessary for the proper and efficient performance of work shall not relieve the contractor of the responsibility of providing such facilities to complete the work.



**GENERAL & SPECIAL CONDITIONS
OF CONTRACT [FOR SERVICES JOB]**

**PSER
KOLKATA**

- 2.8.19 In case of any clause of the work for which there is no such specification as laid down in the contract, such work shall be carried out in accordance with the instructions and requirements of the BHEL Engineer.
- 2.8.20 No levy or payment or charge made or imposed shall be impeached by reason of any clerical error or by reason of any mistake in the amount levied or demanded or charged.
- 2.8.21 The details drawings, specifications, instructions manual, if any available with the BHEL Engineer will form part of tender specification. These documents will be made available for reference only to the contractor during execution of work.
- 2.8.22 Should any error or ambiguity be discovered in the specification or information, the contractor shall forthwith bring the same to the notice of BHEL before commencement of work. BHEL's interpretation in such cases shall be final and binding on the contractor.
- 2.8.23 No idle labour charges will be admissible in the event of any stoppage caused in the work resulting in contractor's labour being rendered idle due to any cause of any type.
- 2.8.24 **No over run charges shall be paid in the event of the completion period being extended for any reason whatsoever.**
- 2.8.25 It is possible that some repair/rectification, modification may be needed on the equipments to be overhauled / work to be performed under this specification, for reasons not attributions to the contractor. All such repair / rectification / modification work which can be done, with the available facilities at site shall be carried out by the contractor free of cost and no extra charges shall be paid to contractor.
- 2.8.26 The quality and progress of work will be regularly reviewed. The schedule and progress of work will be given to the contractor in advance and it will be the obligation / responsibility of the contractor to achieve the desired quality and progress of work by suitably reinforcing their labour force and/or by working extra hours or in more than one shift without any extra cost. Workmen found unsuitable for the work will be replaced immediately by the contractor on being informed by BHEL.
- 2.8.27 During the overhauling work under the contract it is very essential that proper and adequate inspection should made constantly to maintain the quality or workmanship so that any deviation from design dimension does not exceed permissible limits. The proper functioning of the unit, while in operation, depends to a great extent on the above factors. The fact that effective supervision and inspection at the execution stage is less costly than any down time of running unit even for a short period need not be over emphasized. For the details regarding alignment and permissible dimensional deviations in the sub-assemblies BHEL Engineer may be consulted.
- 2.8.28 The contractor shall be furnish fortnightly labour report showing by classification of number of employees engaged in various categories or work date wise and submit a progress report of work as required by BHEL Engineer.
- 2.8.29 The contractor shall execute the work in the most substantial and workmen-like manner in stipulated time. Accuracy of work and timely execution are the essence of this contract. The contractor shall be responsible to ensure that the assembly and workmanship conform to the dimensions and clearances given in the drawings and/or as per instructions of BHEL Engineers.
- 2.8.30 The contractor shall take all responsible care to protect the materials and work till such time the plant/equipment has been taken over by BHEL / their client. Where necessary, suitable temporary fencing and lighting shall have to be provided by the contractor as a safety measure against accident and damage of property of BHEL. Suitable caution notice shall be displayed where access to any part may be deemed to be unsafe and hazardous.
- 2.8.31 It will be the responsibility of the contractor to ensure safe lifting of the equipments taking due precautions to avoid any accidents and damage to other equipments and personnel.
- 2.9 **Void**



**GENERAL & SPECIAL CONDITIONS
OF CONTRACT [FOR SERVICES JOB]**

**PSER
KOLKATA**

- 2.10 Insurance:
- 2.10.1 BHEL / their customer shall arrange for insuring the materials / properties of BHEL/customer covering risks during transit, storage, overhauling, erection and commissioning.
- 2.10.2 It is the sole responsibility of the contractor to Insure his workman against accident and injury while at work as required by relevant rules and to pay compensation, if any, to workmen as per workmen's compensation Act. Contractor shall insure his staff against accidents. The work will be carried out in a protected area and all the rules and regulations of the client / BHEL in the area of project which are in force from time to time, will have to be followed by the contractor.
- 2.10.3 If due to negligence and /or non-observations of safety and other precautions, any accident / injury occurs to any other person/public, the Contractor shall have to pay necessary compensation and other expenses, if so decided by the appropriate authorities. Third party insurance coverage is to be made by the contractor.
- 2.10.4 If due to contractor's carelessness, negligence or non-observance of safety precautions damage to BHEL's /Customer's property and personnel should occur, and if BHEL is unable to recover, in full, cost from the Insurance Company, the balance will be recovered from the Contractor.
- 2.11 Strikes & Lockouts :
- The contractor will be fully responsible for all the disputes and other issues connected with his labour. In the event of the contractor's labour resorting to strike or the lockout declared is not settled within a period of one week BHEL shall have the right to get the work executed employing the own labour or through any other agencies or both and the cost so incurred by BHEL, shall be deducted from the contractor's bills as per clause 2.7. For all purposes whatsoever, the employees of the contractor shall not be deemed to be in the employment of BHEL.
- 2.12. Force Majeure :
- 2.12.1 The following shall amount to Force Majeure :
- Acts of God, Acts of any Government, war, sabotage, riots, civil commotion, police action, revolution, flood, fire, cyclones, earthquake and epidemic and other similar causes over which the contractor has no control.
- 2.12.2 If the contractor suffers delay in the due execution of the contractual obligation due to delays caused by Force Majeure as defined above, the agreed time of completion of the job covered by this contract or the obligations of the Contractor shall be extended by a period of time equal to the period of delay provided that on the occurrence of any such contingency the Contractor immediately reports to BHEL in writing the causes of delay and the contractor shall not be eligible for any compensation.
- 2.13 Performance Guarantee:
- Even though the work will be carried out under supervision of BHEL Engineers. The contractor shall guarantee against defects attributable to faulty workmanship or procedure adopted in the overhaul for items covered in the contract for a period of six months from the date of re-commissioning of the set after the capital overhaul. The guarantee should cover all defects notified during this period and shall have to be attended to free of cost immediately or at the time our clients are able to give shut down of the set for the required period. when necessary. In case of failure of contractor to attend to such defects as and when required in time, BHEL shall arrange to attend the defects and the charges shall be levied to contractor's account and shall be recoverable from the security deposit / progressive payments.



**GENERAL & SPECIAL CONDITIONS
OF CONTRACT [FOR SERVICES JOB]**

**PSER
KOLKATA**

2.14. ARBITRATION & CONCILIATION:

2.14.1 ARBITRATION:

2.14.1.1 Except as provided elsewhere in this Contract, in case Parties are unable to reach amicable settlement (whether by Conciliation to be conducted as provided in Clause 2.14.2 herein below or otherwise) in respect of any dispute or difference; arising out of the formation, breach, termination, validity or execution of the Contract; or, the respective rights and liabilities of the Parties; or, in relation to interpretation of any provision of the Contract; or, in any manner touching upon the Contract (hereinafter referred to as the 'Dispute'), then, either Party may, commence arbitration in respect of such Dispute by issuance of a notice in terms of section 21 of the Arbitration & Conciliation Act, 1996 (hereinafter referred to as the 'Notice'). The Notice shall contain the particulars of all claims to be referred to arbitration in sufficient detail and shall also indicate the monetary amount of such claim. The arbitration shall be conducted by a sole arbitrator to be appointed by the Head of the BHEL Power Sector Region issuing the Contract within 60 days of receipt of the complete Notice. The language of arbitration shall be English.

The Arbitrator shall pass a reasoned award.

Subject as aforesaid, the provisions of Arbitration and Conciliation Act 1996 (India) or statutory modifications or re-enactments thereof and the rules made thereunder as in force from time to time shall apply to the arbitration proceedings under this clause. The seat of arbitration shall be Kolkata (the place from where the contract is Issued). The Contract shall be governed by and be construed as per provisions of the laws of India. Subject to this provision 2.14.1.1 regarding ARBITRATION, the principal civil court exercising ordinary civil jurisdiction over the area where the seat of arbitration is located shall have exclusive jurisdiction over any DISPUTE to the exclusion of any other court.

2.14.1.2 In case of Contract with Public Sector Enterprise (PSE) or a Government Department, the following shall be applicable:

In the event of any dispute or difference relating to the interpretation and application of the provisions of commercial contract(s) between Central Public Sector Enterprises (CPSEs)/ Port Trusts inter se and also between CPSEs and Government Departments/Organizations (excluding disputes concerning Railways, Income Tax, Customs & Excise Departments), such dispute or difference shall be taken up by either party for resolution through AMRCD (Administrative Mechanism for Resolution of CPSEs Disputes) as mentioned in DPE OM No. 4(1)/2013-DPE(GM)/FTS-1835 dated 22-05-2018 as amended from time to time.

2.14.1.3 The cost of arbitration shall initially be borne equally by the Parties subject to the final allocation thereof as per the award/order passed by the Arbitrator.

2.14.1.4 Notwithstanding the existence of any dispute or differences and/or reference for the arbitration, the Contractor shall proceed with and continue without hindrance the performance of its obligations under this Contract with due diligence and expedition in a professional manner unless the dispute inter-alia relates to cancellation, termination or short-closure of the Contract by BHEL.



**GENERAL & SPECIAL CONDITIONS
OF CONTRACT [FOR SERVICES JOB]**

**PSER
KOLKATA**

2.14.2 CONCILIATION:

If at any time (whether before, during or after the arbitral or judicial proceedings), any Disputes (which term shall mean and include any dispute, difference, question or disagreement arising in connection with construction, meaning, operation effect, interpretation or breach of the agreement, contract), which the Parties are unable to settle mutually, arise inter-se the Parties, the same may, be referred by either party to Conciliation to be conducted through Independent Experts Committee (IEC) to be appointed by competent authority of BHEL from the BHEL Panel of Conciliators.

Notes:

1. No serving or a retired employee of BHEL/Administrative Ministry of BHEL shall be included in the BHEL Panel of Conciliators.
2. Any other person(s) can be appointed as Conciliator(s) who is/are mutually agreeable to both the parties from outside the BHEL Panel of Conciliators.

The proceedings of Conciliation shall broadly be governed by Part-III of the Arbitration and Conciliation Act 1996 or any statutory modification thereof and as provided in Procedure 2.3 : "Procedure for conduct of conciliation proceedings" (as available in www.bhel.com). The Procedure 2.3: "Procedure for conduct of conciliation proceedings" (as available in www.bhel.com) together with its Formats (as available in www.bhel.com) will be treated as if the same is part and parcel hereof and shall be as effectual as if set out herein in this GCC.

The Contractor hereby agrees that BHEL may make any amendments or modifications to the provisions stipulated in the Procedure 2.3 : "Procedure for conduct of conciliation proceedings" (as available in www.bhel.com) from time to time and confirms that it shall be bound by such amended or modified provisions of the Procedure 2.3 : "Procedure for conduct of conciliation proceedings" (as available in www.bhel.com) with effect from the date as intimated by BHEL to it.

2.14.3 NO INTEREST PAYABLE TO CONTRACTOR:

Notwithstanding anything to the contrary contained in any other document comprising in the Contract, no interest shall be payable by BHEL to Contractor on any moneys or balances including but not limited to the Security Deposit, EMD, Retention Money, RA Bills or the Final Bill, or any amount withheld and/or appropriated by BHEL etc., which becomes or as the case may be, is adjudged to be due from BHEL to Contractor whether under the Contract or otherwise.



**GENERAL & SPECIAL CONDITIONS
OF CONTRACT [FOR SERVICES JOB]**

**PSER
KOLKATA**

SECTION – III
SPECIAL CONDITIONS OR CONTRACT

3.1 Quantum of Work:

3.1.1 The scope of work given in the tender specification is only approximate and is liable to variation and alternation at the discretion of BHEL Resident Engineer. No compensation on this account shall be payable to the contractor unless specifically recommended by BHEL Resident Engineer as the variation forming major additions to the original scope of work. All repair / rectification work arising out of normal wear and tear, seizure of parts etc. have to be done by the contractor and the same will be covered by the scope of work of the contract.

3.1.2 The scope of work details out the major activities only. However, as per the general maintenance requirement and site condition, certain related activities may have to be carried out without any extra cost.

3.2 Commencement and completion of work :

3.2.1 The starting time and completion time is the essence of the of the tender. As the time bound programme is firmly committed to customer, the starting time and completion time should be strictly adhered to. It will be not be possible to grant extension in completion time except in extraordinary circumstance, which will be decided entirely at the discretion of BHEL Resident Engineer. Work should normally be carried out in two shifts and sometimes also in three shifts in consultation with BHEL Resident Engineer.

A detailed programme of the various activities covered under this contract with specific time period to fall in the overall frame work of the above dates should be prepared and got approved by BHEL Resident Engineer. The progress against this programme shall be reviewed with BHEL Resident Engineer at the end of each day and critical areas identified and suitable steps taken in time.

If during the review, at any stage of overhauling, BHEL Resident Engineer feels that the delays are not likely to be made up, BHEL reserves the right to take corrective steps as considered necessary by BHEL Resident Engineer to complete work in scheduled time and debit the cost incurred thereon to the contractor. This does not however absolve the contractor of his own efforts in consultation with BHEL Resident Engineer. Every endeavour will be made to see that work proceeds uninterruptedly.

3.2.2 The tenderers should indicate the time required for starting the work once the letter of intent is issued and the time required for completion. The work may have to commence immediately after opening of the tenders. Hence, preference may be given to those tenderers who can commence the work earlier, and also ensure early completion.

3.2.3 The Contractor shall ensure completion of the job in all respects within the day from the date of commencement of work as given in contract.

3.3 Penalty for delay:

3.3.1 In the event of failure to complete the work in given time, an amount equal to ½% [half percent] of the contract value per day subject to a maximum of 10% [ten percent] of the contract value will be levied as penalty, in case the balance work is allowed to be completed by the contractor beyond the scheduled time of completion, which is at the discretion of BHEL. In case of delays on contractor's part, at any stage during the scheduled period or after, BHEL shall have the option of ensuring completion of the job by any other means at its disposal and the charges on this account shall be levied on the contractor. These shall be adjusted against contractor's bills or Security Deposit.

In case of LD recovery, the applicable GST shall also be recovered from vendor, (if any).



**GENERAL & SPECIAL CONDITIONS
OF CONTRACT [FOR SERVICES JOB]**

**PSER
KOLKATA**

3.4 Terms of Payment:

A minimum time of 15 days will be required for processing the bills and release of payment after the bills are presented to BHEL.

3.4.1 As per STC

All payments are subjects to income tax deductions @1% of the bill amount at source or as per Central Government Laws. No request for advance payment will be entertained by BHEL.

3.5 Inspection and Completion:

The work being carried out by the contractor will be supervised and inspected by our Site Engineers under the overall supervision of BHEL Resident Engineer.

3.6 The work will be deemed as complete when it is finally accepted by BHEL Resident Engineer and job completion certificate is issued. No extra payment will be made for any rework carried out by the contractor to rectify any defective work.

3.6 The contractor shall not be entitled for labour idling charges under any circumstances.

3.6 Tools, Tackles, Test Equipments & Consumables:

3.6.1 All tools and tackles and consumables required for day-to-day work like gas and gas cutting sets with accessories, AC/DC welding sets, TIG welding kits, welding cables, electrodes, all necessary power connection at his own cost. However, in case of emergency, BHEL may supply certain items if available, to contractor at actual cost plus handling charges, these will be deducted from contractors' running bills, testing equipment for conducting various tests, during the progress of overhauling / re-commissioning shall have to be provided by the contractor. Spare parts going into permanent installation shall only be provided by BHEL.

3.7 Accommodation for site staff and store space:

3.7.1 Contractor has to arrange for the stores and office at site; space for the same shall be made available as per the availability at site. The contractor shall be responsible to provide all necessary facilities like residential accommodation with sanitary facilities, transport, electricity, water, medical bonus etc. as required under various labour laws and statutory rules and regulations framed thereunder to the personnel employed by him.

3.8 Responsibilities of the contractor:

3.9 Supervisory staff and labour:

The contractor shall employ, specially skilled labour, supervisor and engineers thoroughly conversant with particular type of work to ensure quality work. BHEL reserves the right to decide on the suitability of the workers and other staff employed by the contractor. BHEL reserves the right to insist on removal of any employees of the contractor at any time if they find him unsuitable and the contractor should forthwith remove him.

3.9 Planning and Execution:

Contractor shall submit a job planning in form of Bar Chart or PERT Chart. A List of manpower category wise, indicating individuals responsibility job activity wise, shall have to be submitted. Daily programme of job shall be displayed on board near work site on day in advance. A daily progress report along with Manpower utilities has to be submitted and backlog of the work, if any, shall be covered up in consultation with BHEL Resident Engineer.



**GENERAL & SPECIAL CONDITIONS
OF CONTRACT [FOR SERVICES JOB]**

**PSER
KOLKATA**

3.9 Safety and Accident Coverage

Contractor shall ensure safety of all his employees at site of work. All employees shall be covered by insurance (workmen compensation) against accident, failing which proper action will be taken against the contractor.

Contractor shall ensure proper safety of the equipments under overhauling by deputing personnel to guard the equipments round the clock. Open oil spaces, steam spaces shall be covered properly against ingress of foreign materials while working.

RESPONSIBILITIES OF THE CONTRACTOR IN RESPECT OF SAFETY OF MAN, EQUIPMENT, MATERIAL AND ENVIRONMENT

3.8.3.1 Before commencing the work, contractor shall submit a 'SAFETY PLAN" to the authorised BHEL official. The 'Safety Plan' shall indicate in detail the measures that would be taken by the contractor to ensure safety of men, equipment, material and environment during execution of the work. The plan shall take care to satisfy all requirements specified here under. The contractor shall submit safety plan along with his offer. During negotiations before placing or work order and during execution of the contract, BHEL shall have right to review and suggest modifications in the safety Plan. Contractor shall abide by BHEL decision in this respect.

3.8.3.2 The contractor shall take all necessary safety precautions and arrange for appropriate appliances as per direction of BHEL or it's authorised officials to prevent loss of human lives, injuries to personnel engaged, and damage to property and environment.

3.8.3.3 The contractor shall provide to it's work force and ensure the use of the following personal protective equipment as found necessary and as directed by the authorised BHEL officials:

- a. Safety Helmets conforming to IS-2925 : 1984
- b. Safety Belts confirming to IS – 3521 : 1983
- c. Safety shoes conforming to IS-1989 : 1978
- d. Eye & Face Protection devices conforming to IS-8520 : 1987 and IS-8940 : 1978
- e. Hand & body protection devices conforming to :
 - IS – 2573 : 1975
 - IS – 6994 : 1973
 - IS – 8807 : 1973
 - IS – 8513 : 1977

3.8.3.4 All tools tackles, lifting appliances, material handling equipment scaffolds, cradles, safety nets, ladders, equipment etc. used by the contractor shall be of safe design and construction. These shall be tested and certificate of fitness obtained before putting them to use and from time to time as instructed by authorised BHEL official who shall have the right to ban the use of any item.

3.8.3.5 All electrical equipment, connections and wiring for construction power, its distribution and use shall conform to the requirements of Indian Electricity Act & Rules. Only electricians licensed by the appropriate statutory authority shall be employed by the contractor to carry out all types of electrical works. All electrical appliance including portable electrical tools used by the contractor shall have safe plugging system to source of power and be appropriately earthed.



**GENERAL & SPECIAL CONDITIONS
OF CONTRACT [FOR SERVICES JOB]**

**PSER
KOLKATA**

- 3.8.3.6 The contractor shall not use any hand – lamp energised by electric power with supply voltage of more than 24 volts. For work in confined spaces, lighting shall be arranged with power source not more than 24 volts.
- 3.8.3.7 The contractor shall adopt all fire safety measures as laid down in the “Code for Fire Safety at Construction Sites’ issued by the safety Department of the Construction Management (HQ) of BHEL and as per directions of the authorised BHEL official. A copy of the above referred “Code for Fire Safety at Construction Sites” shall be made available by BHEL to the contractor for reference, on demand by the contractor, during tendering stage itself.
- 3.8.3.8 Where it become necessary to provide and / or store petroleum products, explosives, chemicals, and liquid or gaseous fuel or any other substance that may cause fire or explosion, the contractor shall be responsible for carrying out such provisions and / or storage in accordance with the rules and regulations laid down in the relevant government acts, such as Petroleum Act, Explosives Act, Petroleum & Carbides of Calcium Manual of the Chief Controller of Explosives, Govt. of India, etc. Prior approval of the authorised BHEL official at the site shall also be taken by the contractor in all such matters.
- 3.8.3.9 The contractor shall arrange at his cost (wherever not specified) appropriate illumination at all work spots for safe working, when natural daylight may not be adequate for clear visibility.
- 3.8.3.10 The contractor shall be held responsible for any violation of statutory regulations (local, state or central) and BHEL instructions, that may endanger safety of men, equipment, material and environment in his scope of work or another contractor’s or agency’s Cost of damage if any, to life and property arising out of such violation of statutory regulations and BHEL instructions shall be borne by the contractor.
- 3.8.3.11 In case of a fatal or disabling injury, accident to any person at construction site due to lapses by the contractor, the victim and / or his / her dependents shall be compensated by the contractor as per statutory requirements. However, if considered necessary, BHEL shall have the right to impose appropriate financial penalty on the contractor and recover the same from payments due to the contractor for suitably compensating the victim and / or his/her dependents. Before imposing any such penalty, appropriate enquiry shall be held by BHEL giving opportunity to the contractor to present his case.
- 3.8.3.12 In case of any damage to property due to lapses by the contractor, BHEL shall have the right to recover cost of such damages from payments due to the contractor after holding an appropriate enquiry.
- 3.8.3.13 In case of any delay in the completion of a job due to mishaps attributable to lapses by the contractor, BHEL shall have right to recover cost of such delay from payments due to the contractor, after notifying the contractor suitably and giving him opportunity to present his case.
- 3.8.3.14 If the contractor fails to improve the standards of safety in its operation to the satisfaction of BHEL after being given a reasonable opportunity to do so, and/or if the contractor fails to take appropriate safety precautions or to provide necessary safety devices and equipment or to carry out instructions regarding safety issued by the authorised BHEL official, BHEL shall have the right to take corrective steps at the risk and cost of the contractor after giving a notice of not less than seven days indicating the steps that would be taken by BHEL.



**GENERAL & SPECIAL CONDITIONS
OF CONTRACT [FOR SERVICES JOB]**

**PSER
KOLKATA**

3.8.3.15 The contractor shall submit report of the accidents, fires and property damage, dangerous occurrences, to the authorised BHEL official immediately after such occurrence, but in any case not later than twelve hours of the occurrence. Such reports shall be furnished in the manner prescribed by BHEL. In addition, periodic reports on safety shall also be submitted by the contractor to the authorised BHEL official from time to time as prescribed.

3.8.3.16 Before commencing the work, the contractor shall appoint / nominate a responsible officer to supervise implementation of all safety measures and liaison with his counterpart of BHEL.

3.8.3.17 If safety record of the contractor in execution of the awarded job is to the satisfaction of safety Department of BHEL, issue of an appropriate certificate to recognise the safety performance of the contractor may be considered by BHEL after completion of the jobs.

3.9 Housekeeping and preservation:

3.9 Work floor/area shall be cleaned every day and be kept absolutely clean. A regular cleaning gang may be engaged for the purpose.

All dismantled components of the equipments under overhauling should be tag marked and stored properly according to type of components, namely all loose/small parts shall be kept in boxes bearing and matching components shall be kept on wooden planks. A list of such components shall be maintained to identify / locate be preserved properly against probable damages.

No floor shall be damaged while working and necessary steps shall be taken by the contractor for repair in case of any damage.

3.9 Tools stores and Consumables:

Tools & tackles, other than special tools and tackles supplied along with the equipments, shall be arranged and kept properly by the contractor. A register must be maintained and updated regularly.

All consumables, other than those going permanently into the equipment, shall be stored by the contractor for daily use. Regular check shall be made at end of each day's work and exhausted consumables shall be replenished immediately.

The store may be visited by BHEL Engineers without notice for verification.

3.9 The contractor shall make all necessary arrangement to receive spares from BHEL/Customer's stores, as and when required. The unused and scrap materials shall be returned to BHEL / Customer's stores on completion of the work.

A detailed account shall be submitted by the contractor to this effect at the end of the work certifying no dues remained against them duly signed by Resident Engineer BHEL/Customer.



**GENERAL & SPECIAL CONDITIONS
OF CONTRACT [FOR SERVICES JOB]**

**PSER
KOLKATA**

3.9 General:

- 3.9.1 Standard printed conditions if enclosed with the offer by the tenderers will not be accepted and only those in main body of the offer will be considered for acceptance.
- 3.9.2 The tenders are likely to be rejected if the tendered is not acceptable to the ultimate customer.
- 3.9.3 It will be the responsibility of the contractor to carry out trial run of all the equipments overhauled and confirm the satisfactory operation of equipment. The contractor's personnel shall also be present at time of final commissioning and attend to any defects that shall occur during this time.



SPECIFIC TERMS AND CONDITIONS
FOR SERVICES JOBS

PSER
KOLKATA

Annexure – V

A) TENDERING

1. Tenders may be submitted through Registered post with acknowledgement due, in the name of the addressee only indicated, or by hand delivery or by courier service obtaining acknowledgements of receipt. Telegraphic / Telex offers received in time can be considered, if only followed by acceptable written tender documents in accordance with the telex / telegram and does not result in any advantage over other tenderers because of any possible manipulation in price or date of completion etc.
2. Each and every page of tender documents from declaration of bidders to Annexure VI enclosed should be signed by the tenderer providing his / their seal and date as taken of their full acceptance of the scope of work, terms and conditions etc., and should be returned along with the tender offers.
3. The tenders should be quoted in English language and international numbers.
4. All entries in the tender shall be typed in ink legibly written without ambiguity.
5. Qualifications of Tenderers : for open tenders only, the tenderers who have previous experience in the similar nature of work as detailed in this tender specifications are expected to quote duly detailing their relevant experience / credentials along with the offer. Offers of other than the above are not likely to be considered. (List of similar jobs done)
- Enclosure – 1
6. Financial Status : A current / valid certificate from a scheduled bank to provide the financial soundness / capability of the bidder to undertake the work, is required to be submitted along with offer.
- Enclosure – 2
7. Income Tax / Sales Tax certificates : A certificate of income tax / sales tax clearance from the appropriate authority, is to be submitted in the form prescribed therefor, valid for the period of contract.
- Enclosure - 3
8. Organization Chart : The organization pattern and that will be deployed by the tenderer for this work duly indicating the number of supervisors, their qualifications and experience in the line, the number of skilled and unskilled persons / etc. is required to be indicated in the offer.
- Enclosure – 4
9. THE FOLLOWING DOCUMENTS SHOULD ALSO BE ENCLOSED.
 - a) An attested copy of the power of attorney in case the tender is signed by an individual other than the sole proprietor.
 - b) In case of an individual his full name, address, nature of business and valid trade licence.



**SPECIFIC TERMS AND CONDITIONS
FOR SERVICES JOBS**

**PSER
KOLKATA**

- c) In case of partnership firm, the names of all partners and their addresses. (A copy of the partnership deed / instrument of partnership, duly attested by the Notary public shall be enclosed.)
- d) In case of companies, date and place of incorporation / registration including date of commencement certificate (for public companies). (Certified copies of Memorandum and articles of association are also to be furnished).

B) EARNEST MONEY DEPOSIT :

For this, please refer article 1.4 (page 4 of 23) of the General and special conditions of contract – 1991 (GSCC) enclosed / supplied with the form issued for empanelment.

C) VALIDITY OF OFFER :

The rates in the tender shall be kept open for acceptance for a minimum period of six months from the due date of opening of tenders. For details, please refer article 1.6 (page 7) of GSCC enclosed.

D) SECURITY DEPOSIT:

As per clause no. 1.8 of GENERAL & SPECIAL CONDITIONS OF CONTRACT [FOR SERVICES JOB].

Return of Security Deposit:

If the contractor duly fulfils the contractual obligations as per contract in all respects to the entire satisfaction of BHEL, and presents an absolute “No Demand Certificate” in the prescribed form and return properties belonging to BHEL handed over, lent or hired by him for carrying out the said works the security deposit will be released to the contractor after deducting all costs or expenses or other contracts entered into with the contractor, only after the satisfactory completion of guarantee period irrespective of release of last 10% payment. In no case Security Deposit can be released before settling all claims of BHEL on contractor under this contract.

No interest shall be payable by BHEL on Earnest Money / Security Deposit or any money due to the contractor from BHEL.

E) ACCEPTANCE / REJECTION OF TENDERS :

For this, please refer article 1.9 (pages 6 to 10) of GSCC enclosed. Also acceptance of customer is pre-requisite for consideration of bid, wherever applicable.

F) ADDITIONAL SPECIFIC TERMS AND CONDITIONS :

01. EXECUTION.

- i) If the site in question is subjected to industrial relations unrest / disturbances / problems, then the successful bidder should take adequate precautionary measures against dislocation of the job on account short problems. Any liability on this account, lies entirely with the contractor.



**SPECIFIC TERMS AND CONDITIONS
FOR SERVICES JOBS**

**PSER
KOLKATA**

- ii) The contractor shall commence the work at site with full manpower, T&P etc. and complete as specified in the particulars of the tender. In case of any delay on the completion of work attributable to the contractor BHEL reserves full rights to cancel the contract fully or partly and to award the job in full or part to an alternate agency and recover the costs towards the same including BHEL's overheads from the contractor.
- iii) In the event of termination of contract or restriction of quantum of job by our client, before or during the execution of contract, BHEL reserves the right to terminate the contract or restrict the quantum of work of sub-contractors accordingly without paying any compensation.
- iv) **Manpower:** For various category of manpower and their numbers recommended, please refer to the Annexure IV of the tender enquiry. The contractor shall engage proper skilled / qualified personnel and ensure the expected quality of work. If any of their personnel has been found to be unsuitable, by BHEL / or their client, the contractor shall withdraw them and provide suitable replacement immediately, failing which BHEL reserves full rights to get the job done by alternate suitable persons at risk and cost of the contractor. The delay on this account is attributable to the contractor.
- v) **TOOLS (TACKLES & PLANTS) :** All tools, tackles and plants including precision measuring instruments, lifting devices shall have to be arranged by the contractor. (List of recommended T&P, for guidance, is provided in Annexure II of the tender enquiry). All lifting tackles and pulling devices to be used must bear valid / latest test certificates for their suitability, and the sales tax furnished along with the offer itself.
- Also certificates of test / calibration with date of validity for various measuring / test instruments have to be submitted by the tenderer preferably along with the offer itself, or else the same is required to be produced at site before start of job failing which the LOI / W.O. is liable to be cancelled without any compensation.
- Successful bidder shall provide valid calibration certificates for IMTEs, fitness certificates for T&Ps and Construction Equipment (e.g. wire ropes, hand operated chain pulley blocks, pulling and lifting machines, electric welding generators, arc welding transformers etc.). Calibration of IMTEs is to be arranged from the accredited agencies. Calibration certificates should have the traceability as per national/international standards. At work site the IMTEs, T&Ps and Construction Equipment shall be checked/tested/inspected by BHEL engineers. The procedure for fitness testing and storage preservation and maintenance of Construction Equipment and T&Ps shall be as per Doc. Nos. PSER:FEX:001:94, PSER:SAS(CAL):016:95 and PSER:FEX:002:94 available with BHEL site engineers.
- vi) **CONSUMABLES:** All consumables required (list for guidance is given in Annexure III of the tender enquiry) for the job shall be arranged by the contractor



**SPECIFIC TERMS AND CONDITIONS
FOR SERVICES JOBS**

**PSER
KOLKATA**

at his cost. However, any spares / components / consumables / materials going permanently into the clients equipment shall be provided to the contractor.

- vii) Successful bidder has to arrange proper storing facilities at site with traceabilities for IMTEs, T&Ps, construction equipments and consumables used during job execution.
- viii) All the T&Ps, consumables etc. must be mobilized at site at least three days prior to actual start of the job. They must be in accordance with those recommended in the Annexure – II and III respectively of the Tender Enquiry and must be got verified to that effect. Formal clearance in writing must be obtained from BHEL's resident engineer before the contractor starts the job.

T&P found defective / improper / insufficient or not having valid test / calibration certificate should be made good immediately.

If the contractor fails to mobilize at least 90% of the recommended T&P and manpower within the stipulated period, the order on the contractor is liable to be cancelled without paying any compensation on to him.

- viii) Storage : The contractor shall be responsible for proper storing of all dismantled components, spares, T&P etc., identify them properly and preserve them throughout the execution of the job. Any loss or damage of the components caused due to the lapses attributable to the contractor or his personnel, shall be chargeable to the contractor.

- ix) Transportation of Spares / materials / consumables :

Any material / components / spares required for the work must be collected by the vendor and carried safely to the work site from the point of issue in our clients premises, through his own resources and cost.

Similarly, excess materials / spares etc. must be returned to the client's stores / any other place, within the client's premises, indicated by site-in-charge of BHEL.

Any debris, rubbish at the work spot must be cleared very day by the contractor using his own resources and cost, and disposed off at a placement for, as to be informed to him.

- x) Space / Accommodation :

The contractor will be allowed to have his site office, stores etc. by erecting temporary partitions / chambers / sheds etc. at the work spot according to the availability of space, which will have to be vacated and dismantled at the end of the jobs to restore the space to the client. The contractor should make his own arrangements for the security / watch and ward.



**SPECIFIC TERMS AND CONDITIONS
FOR SERVICES JOBS**

**PSER
KOLKATA**

No residential accommodation / spare can be provided by BHEL to the contractor for any residential accommodation of his personnel. Contractor has to make arrangements/accommodation at site at his cost.

xi) The contractor shall ensure responsible execution of the job and proper behavior of their personnel and observance of all the rules and regulations of our clients.

xii) Safety :

a) Standard safety norms/ regulations shall be conserved by the contractor during the execution of the job. The contractor should provide the necessary / stipulated safety devices to his personnel deputed to the site, such as grinding / welding goggles, masks, safety belts, helmets etc. No worker will be permitted to work without necessary safety appliances. Delay of work due to work without necessary safety appliances. Delay of work due to these lapses are attributable to the contractor.

b) All norms related to Health, Safety & Environmental (HSE) norms conforming to ISO-14001 & OHSAS-18001 shall be followed by successful bidder. Bidders may contact SAS-PSER office for getting detailed norms to be followed by bidder at Site

c) The contractor shall comprehensively insure all his site personnel against any hazard / accident and submit a copy of the insurance certificate covering all his site personnel to our resident engineer before commencement of work.

d) In case of any accident / hazard, the contractor shall arrange for medical attendance immediately shall compensate the personnel concerned in accordance with the workmen's compensations act in force and shall keep BHEL indemnified against any provisions of the act.

e) The successful bidder is to arrange a full set of First Aid kit for attending to manpower deployed by him at site as per requirement.

f) Successful bidder should follow all safety norms at work site. The Doc. No. PSER:PMX:004:94 in this regard is available with BHEL engineer at site.

02. STATUTORY COMPLIANCE :

i) The contractor shall comply with all state and central laws, statutory rules regulations etc. such as :



**SPECIFIC TERMS AND CONDITIONS
FOR SERVICES JOBS**

**PSER
KOLKATA**

The payment of wages act, maximum wages act, workmen's compensation act., industrial disputes act, employees provident funds act / scheme, Employees' state insurance scheme, contract labour (Regulation & abolition) act, 1970 etc. and all other acts, rules & regulations for employment of labour as may have been and as may be enacted by the Government during the tenure of the contract and having force or jurisdiction at site. The contractor shall give to the local government body, police, labour authorities and other relevant authorities and all such intimation and notices as may be required by law and appraise BHEL site-in-charge of such compliance.

- ii) The contractor shall pay all taxes, fees, licence charges, deposits, duties, fines, royalty commissions or other charges which may be leviable on account of any of his operations in executing the contract. In case, BHEL is forced to pay any of such taxes, BHEL shall have the right to recover the same from the contractor either form his bills or other issue as deemed fit.
- iii) The contractor shall obtain requisite licence from appropriate authority of the ministry of labour under the provision of the contract labour (Regulation and abolition) Act as soon as the work is avoided to him and indemnify BHEL against the application of any provisions of the act.
- iv) The contractor shall be responsible for provision of welfare and health of his employees / workmen, more particularly described in the contract labour (Regulation & abolition) act / rules, and safety precautions etc., as may be required for satisfactory execution of the contract.
- v) The contractor shall fulfil all his obligations in respect of canteens, rest rooms, accommodation including proper medical facilities etc. for the personnel employed by him, more particularly described in the contract labour (regulation & abolition) act / rules.
- vi) The contractor will be directly responsible for payment of wages to his workmen more specifically described in the contract labour (regulation and abolition) act / rules. A pay roll sheet showing all the wage payments representative should be furnished to BHEL site office for record purpose. BHEL site in-charge may be intimated the date of disbursement of wages to the workmen engaged for the work; so that his representative can witness the same. The contractor shall indemnify BHEL against any statutory liability on account of dues to his workmen.
- vii) The bidders should be having appropriate licence from the local Boiler Inspectorate if the job involves welding of pressure parts. Also they should be having alloy steel / carbon steel high pressure welders (for PIG and submerged arc welding approved by the local Boiler Inspectorate for welding the pressure parts. The bidders should clearly indicate the same in the offer.



**SPECIFIC TERMS AND CONDITIONS
FOR SERVICES JOBS**

**PSER
KOLKATA**

03. TERMS OF PAYMENT:

- i) No advance shall be payable to the contractor unless specifically spelt out in the tender enquiry.
- ii) A minimum time of fifteen days will be required for the processing of bills presented and for their payment.
- iii)
 - a) **80% of the contract value shall be payable against submission of three progressive running bills. Each of the billed amount shall correspond to the quantum of job actually completed and to that effect the claim can be preferred based on percentage allotments (to be given in the work order) made. This, however, has to be certified by the resident manager / engineer of the site.**
 - b) **10% of contract value shall be payable on submission of statutory documents & 'no due certificate from customer's personal department/receipt of final payment by BHEL from customer'.**
 - c) **Balance 10% of contract value shall be payable after successful synchronization / commissioning and on receipt of final payment by BHEL from Customer.**

BHEL at its discretion may further split up the percentage break up given in billing schedule and effect payment to suit site condition, cash flow requirement etc. according to progress of work.
- iv) The bidder should be financially sound to maintain the site establishment with regard to timely payment of wages to his workmen, arrangements of other inputs viz. T&P consumables etc.
Non-receipt of progressive payment from BHEL due to any reasons should not be a constraint for the smooth execution of the job at site.
- v) The bidder should make all out efforts to provide all inputs in consultation with BHEL engineers at site for completing the job in the specified time frame.
- vi) No over run/escalation / idle charges are payable against any services job under any circumstances. (in exceptional cases such claims may be considered provided BHEL's customer admits of such payment).
- vii) Extra work rate being admitted off by BHEL for other similar contracts have been stated on the page no.10 of this annexure.

For any additional work not envisaged in the scope of work or quantities exceeding the stated quantities, these rates shall be applicable.
- viii) All claims for extra works should be settled before claiming the final (10%) bill. The contractor should prefer the final claim with the certificate that 'no other claim is due from BHEL against this contract', without which final bill cannot be processed for payment.
- ix) For reduction / deletion / withdrawal in the scope of work proportionate deduction in contract value will be made.



**SPECIFIC TERMS AND CONDITIONS
FOR SERVICES JOBS**

**PSER
KOLKATA**

4. PERFORMANCE:

- i) As soon as job is awarded, the contractor has to submit a barchart to the resident engineer nominated showing the detailed schedule for all activities.

This schedule will be reviewed by the resident engineer from time to time to enable the contractor to recast the barchart matching the planned completion of the job.

- ii) It shall be the responsibility of the contractor's supervisor to distribute the work among his workmen deployed at site and get day to day activities executed as per BHEL's requirement.

BHEL's engineers / supervisors will check the correctness of the job done and will also give the daily programme of work to the contractors supervisor. The contractor has to ensure completion of daily programme and if there is any spill over, the same has to be completed by putting in same additional resources. (Technical guidance wherever required will be provided by BHEL).

- iii) The scope of work mentioned in this tender enquiry gives the broad outline of the actual work involved and it not is possible to mention all minute details of the work. For proper evaluation, the bidders may seek clarifications from this office. Or else, they may visit site and study the job content before submitting offers and be well informed and acquainted with the actual working and other prevalent conditions of the site, facilities available etc.

No claim will be entertained later on the ground of lack of knowledge. iv)

The bidders have to furnish the bio-data and experience details of the site-in-charge, other key workmen, supervisors, senior technicians etc. to be deployed. In case of award of contract, the key members of the contractor's team may be interviewed at site by BHEL's resident engineer to ascertain their suitability. Replacement of non-acceptable personnel will have to be arranged by the contractor immediately at his own cost.

- v) Penalty for the delay in job completion will be 0.5% per day of delay, limiting to maximum 10% of the contract value, to be imposed on the contractor in case the delay in work completion is attributable to the lapses on the part of the contractor.

In case of LD recovery, the applicable GST shall also be recovered from vendor, (if any).

- vi) Performance Guarantee: Even though the work will be carried out under supervision of BHEL Engineers, the contractor shall guarantee against defects attributable to faulty workmanship or procedure



**SPECIFIC TERMS AND CONDITIONS
FOR SERVICES JOBS**

**PSER
KOLKATA**

adopted in the overhaul for items covered in the contract for a period of Six months from the date of re-commissioning of the set after the overhaul. The guarantee should cover all defects notified during this period and shall have to be attended free of cost immediately or at the time our clients are able to give shutdown of the set for the required period, when necessary. In case of failure of contractor to attend to the defect as and when required in time, BHEL shall arrange to attend the defects and the charges shall be levied to the contractor's account and shall be recoverable from the security deposit / progressive payments.

5. MISCELLANEOUS:

- i) The bidders shall submit a list of jobs being carried out by them or expected to be taken up by them during the period as called for in the participation of the tender.

Enclosure – 6.

- ii) The contractor has to engage a cleaning gang at site to ensure continuous cleaning of the floor at work site to protect the parts and to give safe access at the work site.
- iii) Obtaining licenses / permits / road permits in connection with the fulfillment of the contractual obligations is entirely the contractors responsibility. However, wherever applicable BHEL can only offer support to the extent possible.
- iv) For all matters bearing on the execution of the job at site, the decisions of the resident engineer are final and binding upon the contractor.
- v) The contractor has to retain suitable minimum work force at site for a period of one month from the date of completion or work / commissioning, to attend any small / miscellaneous problems, as leakage etc.
- vi) The contractor has to mobilize on a short notice (within 4 days) to attend any troubles encountered in the equipment worked on, during warranty period of six months.
- vii) After dismantling and during execution of the job, successful bidder has to suitably tag the components and sub-assemblies for traceability and store properly before final assembly. This is as per Doc. Nos. PSER:PMX:002:94 & PSER:PMX:001:94.
- viii) Process control of Special Processes like Welding and Heat Treatment shall be carried by successful bidder as per Doc. Nos. PSER:QLY:001:99, PSER:QLY:001:94 (3 VOL) and PSER:QLY: 003:99.
- ix) Proper segregation, identification, tagging and up-keep of all dismantled items at work site during job execution have to be done by successful bidder.



SPECIFIC TERMS AND CONDITIONS
FOR SERVICES JOBS

PSER
KOLKATA

- x) Successful bidder is to obtain necessary "No Dues" certificates before demobilisation from site.
- xi) Any NDT within the scope shall be as per Non-Destructive Examination manual (Doc. No. PSER:QLY:002:99 available with BHEL site engineer).
- xii) Unless otherwise mentioned specifically in this tender elsewhere, the storage & preservation of components, sub-assemblies, IMTEs, T&Ps, Construction Equipments etc, maintenance of stores, watch and ward of stores and BHEL site office is in the scope of the successful bidder.
- xiii) The successful bidder is to arrange extra illumination at work site to augment the existing site illumination if required to enable round-the-clock safe working.

Note: Any of the documents mentioned above can be referred before submission of tender at the office of PSER:SAS(CAL).

EXTRA WORK RATES CURRENTLY BEING ADMITTED BY BHEL, PS-ER

- A. **MAN-HOUR RATE FOR ELIGIBLE EXTRA WORKS:** Single composite average labour man-hour rate, including overtime if any, supervision, use of tools and tackles and other site expenses and incidentals, consumables for carrying out any major rework/repairs/rectification/modification/fabrication as certified by site as may arise during the course of erection, testing, commissioning or extra works arising out of transit, storage and erection damages, payment, if found due will be at Rs.108/- per man hour.
- B. The following all inclusive rates will be applicable for modification work involving welding of high pressure butt joints only. Extra work involving other types of joints will be done on the above manpower basis.

Unit rate per equivalent joint of size OD 63.5 mm x 6.3 mm thick

Average unit rate per equivalent joint,
including NDT and stress relieving.



**SPECIFIC TERMS AND CONDITIONS
FOR SERVICES JOBS**

**PSER
KOLKATA**

Carbon Steel

Rs.200/- (Rs. Two hundred only)

Alloy Steel

Rs.250/- (Rs. Two hundred fifty only)



SPECIFIC TERMS AND CONDITIONS
FOR SERVICES JOBS

PSER
KOLKATA

List of enclosure to be furnished by the bidder along with tender documents.

- | | | |
|----|---|----------------|
| a) | Experience certificate | Enclosure 1 * |
| b) | Banker's certificate of financial soundness as per BHEL' format | Enclosure 2 * |
| c) | IT / ST clearance certificate | Enclosure 3. |
| d) | Organisation Chart | Enclosure 4. * |
| e) | List of concurrent jobs held by the contractor / bidder. | Enclosure 5. |
- (* Vendors registered with BHEL should submit documents in support of sl. no. c only.)

List of documents to be furnished by the contractor to the resident engineer before commencement of the jobs / during the execution.

- i) Barchart (if not furnished in the offer)
- ii) List of T&P being mobilized. Test / Calibration certificate with date of validity for lifting / pulling devices and measuring / test instrument (if not furnished in the offer).
- iii) Category wise list of manpower being mobilized. iv)
List of consumables being mobilized.
- v) Licence from the department of Labour under contract Labour (Regulation & Abolition) Act / Proof of Application for Licence.
- vi) ESI coverage, if applicable.
- vii) Insurance certificate covering the site personnel.
- viii) Proof of remittance of provident fund to the concerned authorities, for all workmen employed for this job.
- ix) Third party insurance coverage.



**SPECIFIC TERMS AND CONDITIONS
FOR SERVICES JOBS**

**PSER
KOLKATA**

ANNEXURE - VI

QUESTIONNAIRE TO BE FILLED IN BY THE BIDDER, SIGNED WITH DATE AND
SEAL, AND TO BE RETURNED ALONG WITH TECHNICAL TENDER.

BIDDER'S NON-ACCEPTANCE OF TENDER REQUIREMENTS CAN DISQUALIFY HIS BID FOR OPENING OF "PRICE BID"

TENDER NO: PSER:SCT:

DATE:/...../20.....

- 01 NAME OF THE ORGANISATION.
ADDRESS, TELEPHONE / FAX NO. :
-
.....
.....
.....
- 02 MODE AND PARTICULARS OF EMD
ENCLOSED
- 03 BANKER'S CERTIFICATE FOR FINANCIAL : Enclosed / Not enclosed.
SOUNDNESS / CAPABILITY TO
UNDERTAKE WORK.
04. IS THE FIRM HAVING VALID TESTED / : YES / NO.
CALIBRATED TOOLS AND MEASURING
INSTRUMENT REQUIRED FOR THIS TYPE
OF JOB AND EQUIPMENT.
05. ORGANISATION CHART / MANPOWER : Enclosed / Not enclosed.
06. STATUTORY REQUIREMENTS AS PER :
RELEVANT ACTS WITH LATEST
AMENDMENT (Pl. tick out)
- i) LICENCE FOR EMPLOYING : Will be complied with
CONTRACT LABOUR
- ii) MINIMUM WAGES ACT : - do -
- iii) INSURANCE OF SITE PERSONNEL : - do -
EMPLOYED.
- iv) WORKMEN'S COMPENSATION ACT : - do -
- v) THIRD PARTY INSURANCE : Will be complied with
- vi) EMPLOYEE'S LIABILITY ACT
- vii) INDUSTRIAL DISPUTES ACT : - do -
- viii) EMPLOYEE'S PROVIDENT FUNDS : - do -
ACT



**SPECIFIC TERMS AND CONDITIONS
FOR SERVICES JOBS**

**PSER
KOLKATA**

- ix) CONTRACT LABOUR : - do -
(REGULATION AND ABOLITION)
ACT / RULES
- x) SAFETY APPLIANCES / DEVICES : - do -
FOR WORKMEN
- xi) BOILER INSPECTORATE : - do -
- xii) ARBITRATION ACT : - do -
07. **AGREEABILITY TO “NO OVERRUN : Agreeable
CHARGES” CLAUSE**
08. **AGREEABILITY TO “NO IDLE TIME : Agreeable
CHARGES” CLAUSE**
09. **AGREEABILITY TO EXECUTE FULL : Agreeable
SCOPE OF WORK OF TENDER ENQUIRY
(INCLUDING RELATED MINOR
ACTIVITIES).**

Signature of the bidder :

Date :

Name of the person signing :

Designation :

SEAL
