



Tender Enquiry No. B/4222/0/0858/V1 for the requirement of Pressure Transmitter for Vacuum Pump System(1 ST)

LIST OF ENCLOSURES

<u>Commercial Documents</u>		
	<u>Document</u>	<u>Number of pages</u>
1.	MATERIAL DETAILS & INSTRUCTION TO BIDDERS	03
2.	PRE-QUALIFICATION REQUIREMENT (TECHNICAL)	01
3.	BUYER SPECIFIC TERMS & CONDITIONS OF THE TENDER (ANNEXURE-2)	03
4.	GENERAL INSTRUCTIONS & STANDARD TERMS & CONDITIONS (GISTC) REV.06 FOR INDIGINOUS SUPPLIER	13
	TOTAL PAGES	20

<u>Technical Documents</u>		
	<u>Document</u>	<u>Number of pages</u>
1.	SPECIFICATION-ST48010 Rev-04	8
	Drawing No. 31611770071	1
2.	NTPC Approved QP	03
	TOTAL PAGES	12



PPX-BOI DEPARTMENT
BHARAT HEAVY ELECTRICALS LIMITED
HEEP: HARDWAR-249 403 (Uttarakhand)
FAX: +91 1334 226084/226462
TEL: +91 1334 28 1707/5773

Enquiry No.: B/4222/0/0858/V1
Item : Pressure Transmitter for
Vacuum Pump
Project : Gadarwara 800 MW

INSTRUCTION TO BIDDERS AND SPECIAL TERMS OF THE ENQUIRY

1. SCOPE OF ENQUIRY

Sealed Bids are invited from bidders to supply, fabrication, pre-shipment testing at manufacturer's works, proper packing for transportation, delivery at plant site as per detailed specifications of Pressure Transmitter (as per spec -ST48010 REV 04, Drg no. 31611770071 rev 00) for Vacuum Pump for Gadarwara 800 MW Project.

2. PROJECT INFORMATION

1.Project Name	Consignee Address
GADARWARA STPP, 800 MW, STAGE-I	AGM (PROJ) GADARWARA STPP, KHASRA NO 24&25; PO GANGAI, TEHSIL - GADARWARA DISTT. NARSINGHPUR (MP)-487770
Tax Structure	GST Applicable

3. Brief Description of the requirement (For details refer price checklist)

Sl. No.	Project	Material Code & Item Description	Total Quantity	Date for Supply Completion
01	NTPC Gadarwara, 800 MW	Mat code: W-96716155597 Pressure Transmitter (as per spec -ST48010 REV 04, Drg no. 31611770071 rev 00) for Vacuum Pump	01 ST	Immediate after placement of PO

4.0 PRE-QUALIFICATION REQUIREMENT (PQR):

Pre-Qualification requirement is mentioned in Annexure-A. Kindly ensure submission of documents in support of PQR (As applicable). Offer submitted by bidders will be scrutinized with respect to pre-qualification requirement first. Technical offer of the bidders not meeting Pre-qualification requirement will not be scrutinized.

Important Note: Bidders should ensure completeness and correctness of all supporting documents of PQR along with their offer. Not more than 30 days (After Opening of Techno-commercial offers) will be allowed to bidders for completing PQR documents. PQR review will be closed within 30 days of opening of techno-commercial Bids. Offers of Bidder / Bidders, who do not meet PQR i.e. do not complete the PQR documentation within 30 days of opening of techno-commercial bid, are likely to be ignored and no-further correspondence may be entertained thereafter.

5.SUBMISSION OF OFFER

- Bidders are advised to study all the tender documents carefully. Any submission of tender by the bidder shall be deemed to have been done after careful study and examination of the tender documents and with full understanding of the implications thereof. The specifications and terms & conditions shall be deemed to have been accepted unless otherwise specifically commented upon in 'Deviation' sheets by the bidder in his offer. Non-compliance with any of the requirements and instructions in the Tender Enquiry may result in rejection of the tender.
- Name of vendor's dealing person with Contact No(s), Email ID and Address of correspondence shall be provided in the bid.
- Tenders are to be submitted in **Two Parts** and **Part-I** (Techno-Commercial Bid) will be opened first. The offers are to be submitted on or before the Due Date and time, as per NIC enquiry.



PPX-BOI DEPARTMENT
BHARAT HEAVY ELECTRICALS LIMITED
HEEP: HARDWAR-249 403 (Uttarakhand)
FAX: +91 1334 226084/226462
TEL: +91 1334 28 1707/5773

Enquiry No.: B/4222/0/0858/V1
Item : Pressure Transmitter for
Vacuum Pump
Project : Gadarwara 800 MW

1. Evaluation Criteria

Evaluation will be done on total landed cost of project basis i.e. considering total landed cost of complete requirement of both project up to site.

2. OFFER VALIDITY

The offer is to be submitted with a validity of 120 days from the date of opening of techno-commercial offers. BHEL will reserve the right to reject the offer, quoting validity less than 120 days.

3. PRE BID CLARIFICATION/ PRE BID MEETING

- Please note that as per BHEL's Policy, we cannot allow Price impact for the requirement / scope of supply, which is a part of specifications of our tender enquiry. Hence please read all specification / documents thoroughly and submit your offer as per specifications of tender enquiry.
- In case of any confusion / non-clarity on any of the clause / requirement of specification, please clarify the same from BHEL before submission of offer. Pre-bid meeting can also be arranged on bidder's request for clarification of techno-commercial scope.
- No deviation & request regarding non-clarity / contradictory conditions / ambiguity of specifications would be entertained after opening of techno-commercial offers. Further no price impact would be allowed for the requirement which is already part of the specifications of the tender enquiry, after opening of techno-commercial offers.
- The prices are to be quoted on firm basis. BHEL will reserve the right to reject the offer of the vendors not quoting the prices on Firm basis.
- Bidders shall submit their techno-commercial queries within 10 days of floating the NIT. Clarifications would be arranged within next one week. Bidders may also request for pre-bid meeting for techno-commercial clarification within one weeks of floating the NIT.

4. DEALING WITH BANNED SUPPLIERS/ CONTRACTORS IN BHEL

Offers of the bidders, who are on the banned/hold list, as also the offers of the bidders who engage the services of the banned/hold firms, shall be rejected. The list of banned/hold firms is available on BHEL website www.bhel.com.

5. Offer shall be submitted in two parts- Part-1 & Part-2

PART-I: PRE-QUALIFICATION REQUIREMENT (PQR)/ TECHNICAL/ COMMERCIAL BID (IN ONE ORIGINAL AND INK SIGNED ON EACH PAGE OF THE OFFER)

Comprising of following documents:

- a. Bidders are required to furnish requisite details in the formats specified in bidding documents for meeting the stipulated **Pre-Qualification Requirements (PQR)** along with all supporting documents like copies of End User Certificates, Purchase Orders and Contract Agreements etc.
- b. Complete Technical offer with relevant drawings/ documents /QP etc. (as per detailed specifications)
- c. Endorsed copy of this document (i.e. **Instruction to bidders & special conditions of the NIT, General Instructions and Standard Terms & Conditions for bidding against Tender Enquiry (GISTC), Quality Plan and Additional terms & condition-** in original duly signed and stamped by the bidder.
- d. Commercial Terms & Conditions.
- e. Any Deviation with reference to NIT to be laid down on separate sheet.
- f. Un-Priced replicas of Price Bid without prices.
- g. **Supplier Registration Form:** Online Registration Portal is operational in BHEL. Bidders not registered at BHEL, Hardwar for this item, have to apply through Online Registration portal, <https://supplier.bhel.in/>. All credentials and/or documents duly signed and stamped related to registration has to be uploaded on the website and submit the application for registration. Application reference number of BHEL supplier registration portal shall be mentioned in bid documents.



PPX-BOI DEPARTMENT
BHARAT HEAVY ELECTRICALS LIMITED
HEEP: HARDWAR-249 403 (Uttarakhand)
FAX: +91 1334 226084/226462
TEL: +91 1334 28 1707/5773

Enquiry No.: B/4222/0/0858/V1
Item : Pressure Transmitter for
Vacuum Pump
Project : Gadarwara 800 MW

- Note: Suppliers who are already registered at BHEL, Haridwar in the PMD for this item are exempted for submitting the Supplier registration form.

PART-II: PRICE-BID:

The price Bid (with prices) for the complete scope as specified in price schedule Annexure-I shall be submitted. The Part-I & Part-II bids shall be uploaded at NIC procurement portal before due date of enquiry: Vendor's full name and address should be clearly mentioned on the part-II envelope/ file.

6. IMPORTANT NOTE:

INSTRUCTION TO BIDDERS & SPECIAL TERMS OF ENQUIRY are to be read and complied along with GISTC (for Indian Bidders as applicable). A signed & stamped copy of these documents as a token of acceptance is to be submitted along with the offer. In the event of contradiction of terms and conditions mentioned, the order of preference shall be INSTRUCTION TO BIDDERS & SPECIAL TERMS OF ENQUIRY followed by GISTC (General Instructions and Standard Terms & Conditions against Tender Enquiry).

Deviations (if any) are to be listed separately in deviation sheet. Please note that in case, no- deviation sheet is received along with the offer, it will be considered that all terms and conditions mentioned in above documents are acceptable to the bidder and your offer will be processed accordingly.

PART-I (as per clause 6 above) (Techno-Commercial bid with PQR) will be opened on Due Date and time specified in the Enquiry, or extension thereof, in presence of bidders who may like to attend. Incomplete offers are liable to be rejected.

Techno-Commercial offer of only those bidders shall be evaluated who meet the Pre-Qualification Requirements mentioned in our Enquiry as stipulated in clause 4 above (If applicable)

Offers of only those vendors will be considered whose approval shall receive from customer before opening of price-bids.

All correspondence thereof, shall be addressed to the following persons:

<p>Mr. Manoj Kumar Designation: Manager (PPX-BOI) 4th Floor, Main Administrative Building HEEP, BHEL Hardwar- 249403 Uttarakhand, India Email ID: manojy@bhel.in Tel: +91 1334 28 5773</p>	<p>Mr. ADESH Designation: Addl Engineer (PPX-BOI) 4th Floor, Main Administrative Building HEEP, BHEL Hardwar- 249403 Uttarakhand, India Email ID: adesh@bhel.in Tel: +91 1334 28 1707</p>
---	--

PRE QUALIFICATION REQUIREMENT FOR PROCUREMENT OF PRESSURE TRANSMITTER

(a) Bidder/ vendor should have successfully supplied Pressure Transmitter covering pressure range from 30 kPa to 80 kPa for any application, fulfilling the following conditions:

- i) One Order for minimum 1 number confirming to above details.
- ii) Purchase Order (PO) date for the order should be within 7 years from the date of enquiry.

(b) In support of the above Clause (a), bidder/ vendor to submit following documents:

- i) Un-priced copy of Purchase Order (PO) and drg/ datasheet of the ordered instrument.
- ii) Any suitable Dispatch document for the referred PO.

L.S. Pangtey
15/09/2021

(Lokesh Singh Pangtey)
Manager, HXE

Axay K
15/09/2021
(Axay Kumar)
Manager, HXE

Item Name Pressure Transmitter for Vacuum Pump (Spares)

Projects: Gadarwara STPP, Stage-I 800 MW, Project

Additional Terms and conditions of tender enquiry (In addition to General instructions and standard terms & conditions as enclosed).

E-PROCUREMENT: Please note that this tender enquiry has been issued through BHEL’s e-procurement portal developed by NIC (<https://eprocurebhel.co.in/>), hence **PAPER BID or BID THROUGH e-MAIL SHALL NOT BE ENTERTAINED FOR THIS TENDER. Please upload your e-bid in BHEL’s e-procurement portal developed by NIC (<https://eprocurebhel.co.in/>).**

Sl. No.	Terms	Description	Confirmation of vendors
1.	Confirmation to General Instructions and standard terms & conditions	<p>Please submit signed and stamped copy of Confirmation to General Instructions and standard terms & conditions (enclosed) as your acceptance to these terms and conditions.</p> <p>Deviation to “General Instructions and standard terms & conditions”, if any, shall be submitted along with offer in separate documents.</p> <p>Please note that in case no- deviation sheet of “General Instructions and standard terms & conditions”, is received along with offer, it will be presumed that all terms and conditions mentioned in “General Instructions and standard terms & conditions” shall be acceptable to you and your offer will be processed accordingly.</p>	
2.	Evaluation criteria	<p>The evaluation would be done on the basis of total landed cost to BHEL up respective Project sites (i.e. Gadarwara Project site), considering all items and services covered in enquiry taken together.</p> <p>Total landed cost up site includes Material Value, freight charges up to site, Insurance, Taxes & Duties etc.</p>	
3.	Offer Validity	<p>Confirm that the validity of the offer shall be 120 days from the due date of opening of Techno-Commercial offers.</p> <p>Please note that BHEL reserves the right to ignore the offers quoting validity less than 120 days from EOD (Enquiry Opening Date).</p>	
4.	Basis of Quotation	<p>Please quote your firm prices on Ex-works freight prepaid basis up to BHEL respective project site (i.e. Gadarwara Project site). Inland freight from Works to respective project site should necessarily be quoted separately.</p>	
5.	Payment Terms	<p>100% payment will be made after receipt and acceptance of material and within 75 days from the date of invoice subject to submission of non-discrepant documents within 15 days of supply as per terms and conditions of Purchase Order. In case any discrepancy found in the documents, BHEL will notify the same to vendor within 7 days of receipt. Vendor has to clear all the discrepancies in one go within 7 days thereafter else the payment of vendor may get delayed.</p> <p>For MSEs (covered under MSME Act) which are registered and periodically renewed with BHEL, the payment will be made within 45 days or as prescribed in the relevant act. Adherence to the above time schedule of payment is contingent upon Vendor complying with GST Rules w.r.t availment of Input Tax Credit by BHEL.</p> <p>In case GST credit is delayed / denied to BHEL, due to non / delayed receipt of goods and / or tax invoice or expiry of the timeline prescribed in GST Law for availing such ITC, or any other reason not attributable to BHEL, GST amount shall be recoverable from Vendor along with interest levied / leviable on BHEL.</p> <p>The taxes and duties that are reimbursed would be the ones applicable as on the contractual Purchase order delivery date or the amount actually paid whichever is less.</p> <p>In case of deviation in payment terms w.r.t. tender conditions, offer shall be evaluated after loading on account of deviation in payment terms as per extended rules of BHEL.</p>	

Item Name Pressure Transmitter for Vacuum Pump (Spares)

Projects: Gadarwara STPP, Stage-I 800 MW,Project

6.	Penalty Clause	In case of delay in supply of material beyond the agreed contractual delivery, Penalty for Late Delivery would be applicable @ 0.5 % of the undelivered portion per week of delay or part thereof subject to a maximum of 10% of the total order value. Please confirm.	
		In case of any deviation to the above penalty clause, BHEL reserves the right to load the offers to the extent to which it is not agreed by vendors (at offered value).	
7.	Technical Requirements	Material specification as per Spec ST 48010 rev 04 & datasheet No. 31611770071 rev 0 only.	
		Required quantity is defined as set (ST).	
		Comply PQR dated 15.09.2021.	
		Vendor to submit material specification, data, drawing / details or catalog for BHEL review.	
8.	Quality requirements & third-party inspection	<ol style="list-style-type: none"> 1. Please confirm acceptance for QAP No. "000-999-QOI-S-008, rev 00"and submit endorsed copy of this QAP along with offer. 2. Please confirm that inspection shall be by BHEL Nominated inspection agency (TUV) and end customer as per customer's approved quality plan. 3. Please note that BHEL will pay directly to BHEL's nominated TPI. 4. However, all coordination with TPI for arranging inspection shall be done by supplier. Please confirm. 	
9.	Interchangeability	Vendor to confirm that quoted item shall be interchangeable with original supplied equipment (Rosemount Inc) as per specification ST48010 and datasheet No. 31611770071. Please Confirm	
10.	Customer approval Condition	<p>Please note that procurement shall be done only from the vendors approved by end customer. Bidders are required to submit following documents along with their offer. BHEL will propose name of PQR qualified bidder (Along with the documents submitted by the bidders) to end customer for their approval.</p> <ol style="list-style-type: none"> a. Complete Supply Experience Including Experience with BHEL (if available) b. Details of Manufacturing and testing facilities. c. ISO Certificate like ISO 9001:2015 etc. if available. d. Company Profile e. Audited Balance Sheet for last three Financial Years f. Any other supporting document to Bidder's presentation against customer. <p>BHEL will propose name of PQR qualified vendors along with credentials to end customer for their approval, however, approval of vendors is sole discretion of end customer.</p> <p>Offers of only those vendors will be considered whose approval shall receive from customer before opening of price-bids.</p>	
11.	MDCC clause	Please note that, material shall be dispatched only after issue of Material dispatch clearance certificate (MDCC) end customer. For issue of MDCC, vendors are required to submit all test certificates (TC) and inspection report of third party (IR) to BHEL. After review & acceptance of the quality document, BHEL will forward the same to end customer for issuance of MDCC. Material shall be dispatched within 7 days from the the date of issuance of MDCC.	
12.	Delivery	Please note that material is required as per the deliveries mentioned in lot date of enquiry. Please quote your deliveries accordingly in no. of weeks from the date of PO including the time required for approval of documents.	
		Please confirm date of LR/GR/RR shall be considered as date of delivery.	
13.	Guarantee/ Warranty	Guarantee/ Warranty Period: 12 months from the date of commissioning or 24 months from dispatch, whichever is earlier. Guarantee certificate is to be provided along with shipping / dispatch documents. Please confirm.	
		In case of any failure or trouble reported from site during Guarantee period, the supplier should depute their representative immediately to attend the problem and replace the	

Item Name Pressure Transmitter for Vacuum Pump (Spares)

Projects: Gadarwara STPP, Stage-I 800 MW, Project

		defective component/part if required. Please confirm.	
		Supplier shall be responsible for free replacement of defective equipment / material at our site without any additional cost to BHEL during Guarantee period. Please confirm.	
14.	Packing Instruction / Details	PACKING SHALL BE MEET THE SAFE TRANSPORTATION OF MATERAIL & STORAGE AT PROJECT SITE AS THESE MATERAIL IS MANDATORY SPARES. MANDATORY SPARES SHOULD BE WRITTEN ON ALL FOUR SIDE OF BOX WITH PROPER MATERIAL CODE & DESCRIPTION AS PER BHEL PURCHASE ORDER. PLEASE CONFIRM.	
15.	Documents requirement	GUARANTEE CERTIFICATE REQUIRED. TEST CERTIFICATE REQUIRED.	
16.	Arbitration:	In case of any dispute arising out of as in connection with this contract, the same shall be referred to arbitration and conciliation act 1996 of a sole arbitrator who shall be appointed by mutual consent of the parties. The seat & venue of arbitration shall be Haridwar. The proceedings shall be conducted in English. The governing law of contract shall be the substantive law of india.	
17.	Risk Purchase:	In case of abnormal delays (beyond the maximum late delivery period as per Penalty clause) in supplies /defective supplies or non-fulfillment of any other terms and conditions given in Purchase Order, BHEL may cancel the Purchase Order in full or part thereof, and may also make the purchase of such material from elsewhere /alternative source at the risk and cost of the supplier. BHEL will take all reasonable steps to get the material from alternate source at optimum cost. If bidder does not agree to the above Risk Purchase Clause, BHEL reserves the right to reject the offer. In case for compelling reasons BHEL accepts the offer without acceptance of this clause by the bidder and in the eventuality of Risk Purchase, appropriate action will be taken as per BHEL extant rules. This will be without prejudice to any other right of BHEL under the contract.	



BHARAT HEAVY ELECTRICALS LIMITED

HEEP-HARIDWAR, UTTARAKHAND (249403)

General Instructions and Standard Terms & Conditions for bidding against Tender Enquiry (GISTC)

For Indian Bidders (Version June-2021, Rev: 06)

Table of Contents

1. GENERAL	1
2. ORIGIN OF QUOTATION	1
3. SUBMISSION OF TENDER	1
4. TENDER OPENING	2
5. SPECIFICATION, DRAWINGS & STANDARD	2
6. PRICE SCHEDULE	3
7. REVERSE AUCTION	3
8. DELIVERY TERMS.....	3
9. LD FOR LATE DELIVERY.....	4
10. PAYMENT TERMS	4
11. TAXES & DUTIES	5
12. BANK GUARANTEE	6
13. GUARANTEE / WARRANTY AND CORRESPONDING REPAIRS / REPLACEMENT OF GOODS	6
14. QUALITY REQUIREMENT	6
15. VALIDITY.....	6
16. RIGHT OF ACCEPTANCE.....	6
17. TRANSIT INSURANCE.....	7
18. RISK PURCHASE	7
19. FORCE MAJEURE CLAUSE	7
20. NON-DISCLOSURE AGREEMENT.....	8
21. SETTLEMENT OF DISPUTES / ARBITRATION	8
22. WHARFAGE / DEMURRAGE RESPONSIBILITY.....	8
23. CONDITIONS FOR AVAILING MICRO & SMALL ENTERPRISES (MSE'S) BENEFITS.....	8
24. INFORMATION TO THE BIDDERS.....	10
25. MAKE IN INDIA (GOVT-NOTIFICATION).....	10
26. RESTRICTIONS UNDER RULE 144(XI) OF THE GENERAL FINANCIAL RULES (GFRs), 2017.....	12

27. NOTE..... 12

1. GENERAL.

These general terms & conditions shall apply to all the Tender Enquiries, notice inviting tenders, request for quotations concerning the supply of goods and / or rendering of services to Bharat Heavy Electricals Ltd., HEEP, Haridwar (hereinafter referred to as BHEL or the Purchaser). In case of placement of order these conditions will become part of Purchase Order (P.O) until unless the deviations are specifically agreed by BHEL.

2. ORIGIN OF QUOTATION.

- a) The quotation should preferably be from the principal bidder. However tender specific authorized registered dealer/agent can also submit the bid on their behalf, failing which the quotation is liable to be ignored. BHEL prefers to deal directly with the principal manufacturers.
- b) An agent cannot quote on behalf of more than one principal in the same Tender Enquiry.

3. SUBMISSION OF TENDER.

- a) Bid / Quotation must be enclosed in sealed cover on which tender enquiry number and the due date MUST BE written and be invariably sent under REGISTERED POST / SPEED POST / COURIER / Dropped in the Tender Box: addressed as follows:

Quotation against Enquiry No. _____

Dated: _____

Due on: _____

To,

**THE HEAD OF MATERIALS MANAGEMENT,
Heavy Electrical Equipment Plant,
Bharat Heavy Electricals Limited,
HARIDWAR-249403 (Uttarakhand), INDIA.**

- b) TENDER ROOM is located at: Room No. - 415, 4th Floor, Main Admin. Building, BHEL-HEEP, Haridwar.

Quotations / Bids not in accordance with General Instructions and Standard Terms & Conditions are likely to be ignored.



BHARAT HEAVY ELECTRICALS LIMITED

HEEP-HARIDWAR, UTTARAKHAND (249403)

General Instructions and Standard Terms & Conditions for bidding against Tender Enquiry (GISTC)

For Indian Bidders (Version June-2021, Rev: 06)

- c) In case of Three / Two Part Bid, technical bid containing technical offer, duly signed and un-priced copy of the Price Bid should be kept in one envelope. Price Bid containing only the price should be kept in a separate envelope. All envelopes indicating Part-1 or Part-2 or Part-3 as the case may be to be put in a bigger envelope. Please note that un-priced bid should be the exact replica of price bid but without prices.
- d) The bid / quotation must be posted before due date, keeping allowance for postal transit time. Quotations sent by any mode but not received in time will be ignored. Tender received through authorized E-mail is also acceptable. However, in time submission of tender in tender box shall be the responsibility of the bidder, sent through any mode. Documents submitted with the offer / bid shall be signed and stamped in each page by authorized representative of the bidder.
- e) Any additional documents submitted by supplier / bidder, during processing of registration application / tender or after placement of order shall not be accepted unless it is submitted with forwarding letter and duly signed and stamped.
- f) The bids of the bidders who are on the banned list and also the bids of the bidders, who engage the services of the banned firms, shall be rejected. The cutting / overwriting in the bid / offer must be duly attested by the signatories to the bid. The list of firms banned by BHEL is available on BHEL web site www.bhel.com.
- g) Being PMD vendor, if you are not quoting against this tender enquiry, please send your regret letter positively for our reference with valid reasons for not participating in the tender enquiry. Repeated lack of response on the part of bidder may lead to deletion such PMD vendor from BHEL's approved vendor list.
- h) The bidders will submit Integrity Pact, duly signed by its authorized signatory, along with their bids wherever estimated tender value is Rs. 2 Crore or more.
- i) In case of open tender, technically qualified unregistered bidders may apply online for registration through <http://www.bhel.com/index.php/vender>.
- j) BHEL reserves the right to award tendered quantities among more than one bidder (after acceptance of L1 price by the other bidders). BHEL can also consider awarding of part of the tendered quantity to other than L-1 bidder at L1 counter offered rates, if the quantity offered by the L-1 bidder is less than the quantity tendered for.
- k) In case of e-Tendering (Online bidding through e-portal), offline bid submitted in hard copy or in any other form by the vendor / supplier will not be accepted and will be rejected out rightly. Only e-portal bid will be accepted.

4. TENDER OPENING.

Tender opening is scheduled to start in the Tender Room at 2:00 PM, on the due date. Therefore, bid / quotations must reach this office / tender Box latest by 1:45 PM on due date. Only participating bidders are allowed to attend tender opening. **TENDERS RECEIVED AFTER THE SPECIFIED TIME OF THEIR 'SUBMISSION' WILL BE TREATED AS LATE TENDERS AND SHALL NOT BE CONSIDERED UNDER ANY CIRCUMSTANCES.** The bidders or their authorized representatives may be allowed to attend tender opening if duly authorized by their principals, through a tender specific letter on that particular day. General authorization letter is not acceptable.

Note: - Foreign bidders willing to attend the bid opening has to provide the requisite documents to the concerned Purchase executives for arranging gate pass for them.

5. SPECIFICATION, DRAWINGS & STANDARD.

- a) Bidders must give their detailed specification in the quotation along with relevant technical literature / catalogue etc. against the tender enquiry.
- b) The Bid should be accompanied with relevant copies of catalogues, drawings or specification as per tender enquiry.

Quotations / Bids not in accordance with General Instructions and Standard Terms & Conditions are likely to be ignored.



BHARAT HEAVY ELECTRICALS LIMITED

HEEP-HARIDWAR, UTTARAKHAND (249403)

General Instructions and Standard Terms & Conditions for bidding against Tender Enquiry (GISTC)

For Indian Bidders (Version June-2021, Rev: 06)

If these documents are not furnished, the offer is liable to be rejected.

- c) Wherever national / international (N/IN) standards are referred, the latest N/IN standards are to be followed. Mention year & date of standard revision that shall be followed for the supply.
- d) All Drawings and Standards are proprietary of BHEL. It must not be used in anyway detrimental to the interest of BHEL or without permission of BHEL.

6. PRICE SCHEDULE.

- a) Kindly quote your prices in figures and words both. In case of any discrepancy in value, the prices quoted in words shall be considered for evaluation and establishing L1 status.
- b) Prices quoted should not be more than the prices quoted to any other BHEL units / offices / divisions. Vendor to submit copy of latest Purchase Order placed by any unit of BHEL for similar items in the technical bid. In case no order has been placed on such items, specific confirmation that no order has been placed on such items should be provided.
- c) Prices should be quoted on F.O.R. Destination basis. Transit insurance shall be arranged by BHEL and not to be included in the prices. The offers quoted on other than F.O.R destination basis may result in non-consideration of such bids.
- d) In case BHEL accepts the EX-Works prices, such offers will be loaded by 1.5% of EX-Works value towards freight or with actual freight charges as per BHEL freight rate contract whichever is higher.
- e) In case of Indigenous items covered by DGS & D Rate Contract, the bidders should submit latest valid copy of the rate contract along with bid / quotation
- f) Applicable **IGST / CGST / SGST** and any other statutory levy should be indicated separately and clearly in the bid / quotation.

- g) Bidders can dispatch goods through any Indian Bank Association approved transporters having their branch at HARIDWAR / destination. If material is dispatched through other than Indian Bank Association approved transporter, material to be delivered on door delivery BHEL Stores basis.
- h) In case of dispatch of material through any other unapproved transporter, payment shall be made only after receipt of material and any additional charges payable to the transporter shall be to the bidder's account.
- i) Any demurrage / godown rent payable to the transporter / or to godown's owner due to any delay attributed by the supplier shall be recovered from supplier's account.
- j) Currency of Evaluation shall be INR.

NB: Financial evaluation of L1, L2Status will be on the basis of Landed Cost to BHEL.

7. REVERSE AUCTION.

Wherever RA is declared in the special terms and conditions of tender enquiry, following shall be applicable and Bidders to confirm the same:

"BHEL shall be resorting to Reverse Auction (RA) (Guidelines as available on www.bhel.com) for this tender. RA shall be conducted among all the techno-commercially qualified bidders.

Price bids of all techno-commercially qualified bidders shall be opened and same shall be considered as initial bids of bidders in RA. In case any bidder(s) do(es) not participate in online Reverse Auction, their sealed envelope price bid along with applicable loading, if any, shall be considered for ranking."

8. DELIVERY TERMS.

- a) Goods shall be delivered on 'FOR Destination' basis to the named destination unless otherwise called for in the tender enquiry.
- b) Loading on account of 3rd party inspection charges in case of Indian bidders shall be 0.20%.



BHARAT HEAVY ELECTRICALS LIMITED

HEEP-HARIDWAR, UTTARAKHAND (249403)

General Instructions and Standard Terms & Conditions for bidding against Tender Enquiry (GISTC)

For Indian Bidders (Version June-2021, Rev: 06)

9. LIQUIDATED DAMAGES (LD) FOR LATE DELIVERY.

a) Where items of Purchase Order are independently usable.

Liquidated Damages (LD) for Late Deliveries shall be applicable @0.5% per week or part thereof on the value of respective delayed supplies subject to a maximum of 10% of the value of respective delayed supplies. Value of delayed supplies will mean the Gross Value payable to the vendor (Before LD) against such supplies excluding taxes and duties.

b) Where the total items are required for a main equipment and items are interdependent.

Liquidated Damages (LD) for Late Deliveries shall be applicable @0.5% per week or part thereof on total value of Purchase Order subject to maximum of 10% of the total value of Purchase Order. Purchase Order value for this purpose shall be the Total Gross Value payable to the vendor (Before LD) excluding taxes and duties.

c) Bidders are requested to quote the best delivery meeting the delivery requirements. BHEL reserves the right to reject the offers not meeting BHEL's delivery requirement.

d) Commencement of delivery period shall be reckoned from the date of PO / LOI or any other agreed milestone.

e) Bidder shall deliver the goods in the manner and schedule agreed under the terms and conditions of Purchase order.

f) **DELIVERY IN CASE OF REJECTION:** In case the material is rejected, then date of replacement will be considered as the actual date of delivery.

g) **DELIVERY AGAINST BANK DOCUMENTS:** In case payment terms quoted by bidder are documents through bank, and the delivery terms being "FOR Haridwar / FOR Transporter Go-down" then date of delivery will be date of intimation by transporter / bidder of delivery of material at Haridwar for the LD purpose.

h) Where the payments are through bank, the documents may be presented for negotiation to BHEL authorized / nominated bank.

i) Payment of Liquidated Damages (LD) shall not in any way relieve the vendor from any of its obligations & liabilities under the contract.

10. PAYMENT TERMS.

a) BHEL's standard payment term is Payment after receipt and acceptance of materials / items at HEEP, BHEL-Store or at desired destination unless otherwise specified in Special Terms attached to the tender enquiry.

b) BHEL reserves the right to accept or reject the offer of the bidder who quotes the payment term other than BHEL's standard payment term.

c) Loading on account of deviation in payment terms shall be done as per extant rules of BHEL-Haridwar.

d) 100% payment along with taxes, freight & insurance will be made after receipt and acceptance of material and within 75 days from the date of invoice subject to submission of non-discrepant documents within 15 days of supply as per terms and conditions of Purchase Order. In case any discrepancy found in the documents, BHEL will notify the same to vendor within 7 days of receipt. Vendor has to clear all the discrepancies in one go within 7 days thereafter else the payment of vendor may get delayed.

e) For MSEs (covered under MSME Act) which are registered and periodically renewed with BHEL, the payment will be made within 45 days or as prescribed in the relevant act.

f) Adherence to the above time schedule of payment is contingent upon Vendor complying with GST Rules w.r.t availment of Input Tax Credit by BHEL.

g) In case GST credit is delayed / denied to BHEL, due to non / delayed receipt of goods and / or tax invoice or expiry of the timeline prescribed in GST Law for availing such ITC, or any other reason not attributable to BHEL, GST amount shall be recoverable from Vendor along with interest levied / leviable on BHEL.

h) The taxes and duties that are reimbursed would be the ones applicable as on the contractual Purchase order delivery date or the amount actually paid whichever is less.



BHARAT HEAVY ELECTRICALS LIMITED

HEEP-HARIDWAR, UTTARAKHAND (249403)

General Instructions and Standard Terms & Conditions for bidding against Tender Enquiry (GISTC)

For Indian Bidders (Version June-2021, Rev: 06)

i) **The loading criteria for the different payment terms shall be as under;**

Payment Terms	Days of Loading
After Receipt & Acceptance of material within 75 days of supply.	No Loading
Against Delivery at BHEL-Stores Haridwar.	45
Against documents through bank (CAD):	45
Letter of Credit (LC)	120
Usance LC	No Loading if usance period is > 120 Days.
	Loading of days' difference i.e. difference between 120 days and usance period if the usance period is < 75 days.
Advance	Delivery Period + 120 Days - Advance Payment Days.

11. TAXES & DUTIES.

- a) The bidder to specify in their offer (part 1 bid) the category of their registration under GST like Registered, Unregistered and composite dealer.
- b) The provisional GST registration number of Bharat Heavy Electrical Ltd, Heavy Electricals Equipment Plant, Ranipur, Haridwar is "05AAACB4146P1ZL" with state Code as "05" and State Name as "Uttarakhand".
- c) Please quote our provisional GST registration number in all invoices raised for supply of goods and services under GST regime and also ensure filing of timely return and payment of tax and compliance of other applicable provisions on supplier under GST regime.
- d) No GST will be reimbursed to unregistered or composite dealer. In the event, any GST is quoted by composite dealer, the same shall be added to the cost of supply in evaluating the bid.
- e) Since, input credit of GST will be available to BHEL-Haridwar only after correct filing of return and payment of applicable GST by supplier, reimbursement of GST shall be made by

BHEL-Haridwar on matching of vendor inputs at GST portal, ensuring availability of input credit to BHEL Haridwar. Payment of GST will be made to vendor after matching of input credit and vendor to ensure submission of their invoices along with consent to accept payment of tax after such matching in all cases where bills are submitted directly to BHEL-Haridwar or through bank or under LC or through any other mode.

- f) In the event of any disallowance of input credit or applicability of interest or any other financial liability arises on BHEL-Haridwar due to any default of supplier under GST, such implication shall be to supplier's account.
- g) In the event of any change in the status of the vendor after the submission of the bid but before the supply, GST applicable at the time of supply or in the bid, based on the registration status of the vendor, whichever is lower shall be payable.
- h) Where ever applicable If PAN (Permanent Account Number) of the recipient is not available, income tax is deductible either at the normal rate or at the rate of 20 percent, whichever is higher as per Section 206AA of Indian Income Tax Act 1961.
- i) The bidder shall clearly indicate HSN (*Harmonised System Nomenclature*) / SAC (*Service Accounting Code*), its description and applicable rate of GST for each item in his techno-commercial bid.
- j) Statutory Variation in Taxes & duties as applicable at the time of supply shall be payable. However, in the event of no change in law but bidder quoting certain tax structure in bid document which is lower than the applicable one, such amount shall be the maximum amount of tax that can be claimed by bidder.
- k) **IMPORTED GOODS OFFERED BY INDIAN BIDDERS AGAINST DEALER INVOICE:** Wherever the material being offered is imported, the bidder must quote the prices inclusive of IGST. The rate and value of IGST as included in the price must be indicated separately. In case quantum of IGST is not mentioned by the bidder the same will not be considered for



BHARAT HEAVY ELECTRICALS LIMITED

HEEP-HARIDWAR, UTTARAKHAND (249403)

General Instructions and Standard Terms & Conditions for bidding against Tender Enquiry (GISTC)

For Indian Bidders (Version June-2021, Rev: 06)

evaluation. However, bidder will have to pass on the benefit of IGST to BHEL at the time supply.

- l) In case of directly dispatchable items to Customer's Site, BHEL-Haridwar will inform the GST registration number of the respective customer which must be mentioned on the vendor's invoice. Vendor to ensure availability of such information from BHEL-Haridwar before dispatch of any material. However, while filing GSTN-1, BHEL Haridwar GSTN number to be quoted.

Note: - Vendors must ensure compliance of all the applicable rules and procedure as envisaged in the GST Regime. Any loss to BHEL-Haridwar due to fault / non-compliance by the vendor will be to the vendor's account.

12. BANK GUARANTEE.

In case the bank guarantees are required to be deposited towards security deposit/performance guarantee or for any other purpose as per the terms of this tender enquiry, such bank guarantees of the requisite value in the denominated currency of the purchase order should be from one of the Indian branch of BHEL consortium banks and the bank guarantee should be in the proforma as prescribed by BHEL. The proforma of bank guarantee and the list of consortium banks are displayed at BHEL website www.bhelhwr.co.in. However, in case the bank guarantee is not from BHEL consortium banks, then the bidder has to get the bank guarantee confirmed from one of the Indian branch of BHEL consortium banks and the bank charges for such confirmation will be borne by the bidder.

13. GUARANTEE / WARRANTY AND CORRESPONDING REPAIRS / REPLACEMENT OF GOODS.

Goods shall comply with the specifications for material, workmanship and performance. Unless otherwise specified, the warranty shall be for a period of 18 months from the date of receipt. If the delivery is found non-compliant during the warranty period, leading to rejection, the Seller shall arrange free replacement / repair of goods, within one month from the date of intimation or any mutually agreed period. The rejected goods shall be taken away by the Seller at his cost and

replaced on Delivered Duty Paid (DDP) (FOR - BHEL Stores / designated destination basis) within such period. In the event of the Seller's failure to comply, Purchaser may take action as appropriate, including Repair / Replenish rejected goods & disposal of rejections, at the risk & cost of the Seller. In case the defects attributable to Seller are detected during processing of the goods at BHEL or at our subcontractor's works, the Seller shall be responsible for free replacement / repair of the goods as required by BHEL.

- b) **RETURN OF REJECTED MATERIAL FOR REPLACEMENT:** The bidder shall have to pay 5% incidental charges while taking back supplied material if it is found rejected on receipt. The rejected material shall be sent back only after receipt of replacement / submission of BG / refund of amount paid.

14. QUALITY REQUIREMENT.

Your bid / quotation should have specific confirmation regarding meeting all our quality requirements such as. (i) Test Certificate (TC), (ii) Guarantee Certificate (GC) / Warranty Certificate (WC), (iii) Quality Plan (QP) (if applicable); and (iv) Pre-Dispatch Inspection at your works (if applicable).

15. VALIDITY.

The quotation should be valid for a minimum period of 90 days effective from the date of opening of tender, unless otherwise specified in the tender enquiry.

16. RIGHT OF ACCEPTANCE.

- a) **BHARAT HEAVY ELECTRICALS LIMITED HARIDWAR** reserves the right to reject any or all the bids / quotations without assigning any reason thereof. BHEL also reserves the right to increase or decrease the tendered quantities. Bidders should be prepared to accept order for reduced quantity without any extra charges.
- b) Any discount / revised offer / bids submitted by a bidder on its own shall be considered, provided it is received on or before the due date and time of offer / bid submission (Part-1). Conditional discounts shall not be considered for evaluation of tenders.



BHARAT HEAVY ELECTRICALS LIMITED

HEEP-HARIDWAR, UTTARAKHAND (249403)

General Instructions and Standard Terms & Conditions for bidding against Tender Enquiry (GISTC)

For Indian Bidders (Version June-2021, Rev: 06)

- c) Unsolicited discounts / revised offers / bids given after Part-1 bid opening shall not be accepted. No change in price will be permitted within the validity period asked for in the tender enquiry.
- d) In case of changes in scope and / or technical specification and / or commercial terms & conditions having price implication, techno-commercially acceptable bidders shall be asked by BHEL to submit the impact of such changes on their price bids. In case a bidder opts to submit revised price bid instead of impact called for then the latest price bid shall prevail. However, in both situations, original price bid will be necessarily opened.
- e) The bidder whose bid is technically not accepted will be informed & EMD wherever submitted shall be returned after finalization of contract. EMD shall be forfeited in the event of bidder opting out after tender opening.
- f) BHEL reserves the right to short close the existing Purchase Order / Rate Contract / Work Order or any extension thereof at any stage.

17. TRANSIT INSURANCE.

- a) Transit Insurance will be covered by BHEL under its open Insurance Policy. Seller shall inform dispatch particulars (Purchase Order, RR /GR, Invoice value etc.) to "Finance department (Store bill Section), BHEL Ranipur, Haridwar (Uttarakhand-India) with value of consignment to the Purchaser within 07 days of dispatch for BHEL to arrange insurance coverage in its policy. Failure on the part of seller to inform dispatch particulars will make him liable to pay for any transit damages / losses suffered by the Purchaser.
- b) If Quoted Prices are inclusive of transit insurance, no weightage shall be given while evaluating the bids for Cost of Insurance, being in BHEL Scope.

18. RISK PURCHASE.

In case of abnormal delays (beyond the maximum late delivery period as per LD clause) in supplies / defective supplies or non-fulfillment of any other terms and conditions given in Purchase Order, BHEL may cancel the Purchase Order in full or part thereof, and may also make the purchase of such material from elsewhere / alternative source at the risk and cost of the supplier. BHEL will take all reasonable steps to get the material from alternate source at optimum cost. If bidder does not agree to the above Risk Purchase Clause, BHEL reserves the right to reject the offer. In case for compelling reasons BHEL accepts the offer without acceptance of this clause by the bidder and in the eventuality of Risk Purchase, appropriate action will be taken as per BHEL extant rules. This will be without prejudice to any other right of BHEL under the contract or under General Law.

19. FORCE MAJEURE CLAUSE.

Notwithstanding any other thing contained anywhere else in the contract or PO (Purchase Order), In case the discharge of obligation under the contract by either party is impeded or made unreasonably onerous, neither party shall be considered in breach of the contract to the extent that performance of their respective obligation is prevented by an event of Force Majeure that arises after the effective date (PO date).

In the above clause, Force Majeure means an event beyond the control of the parties to the contract which prevents a party from complying with any obligation of the contract including but not limited to:

- Act of God (Such as but not limited to earthquake, drought, tidal waves, floods etc.).
- War (whether war be declared or not), Hostilities Invasion, Act of foreign enemy etc.
- Rebellion, revolution, insurrection, civil war etc.
- Contamination of Radio Activity from any nuclear fuel or from any other nuclear waste or any other hazardous materials.
- Riots, commotions, strike unless restricted to the employees of supplier.
- Acts of terrorism.



BHARAT HEAVY ELECTRICALS LIMITED

HEEP-HARIDWAR, UTTARAKHAND (249403)

General Instructions and Standard Terms & Conditions for bidding against Tender Enquiry (GISTC)

For Indian Bidders (Version June-2021, Rev: 06)

- g) Other unforeseeable circumstances beyond the control of the parties and which the affected party cannot avoid even by using its best efforts.
- h) Cancellation of contract by customer.
- i) Change in law / government. Regulation making the performance impossible.
- j) Pandemic or Epidemic.

The party claiming to be affected by force majeure shall notify the other party in writing immediately without delay on the intervention and on the cessation of such circumstances.

Irrespective of any extension of time, if an event of force majeure occurs and its effect continues for more than 180 days the affected party shall have right to cancel the contract.

As soon as reasonably practicable following the date of commencement of a Force Majeure Event, and within a reasonable time following the date of termination of a Force Majeure Event, either Party invoking it shall submit to the other Party reasonable proof of the nature of the Force Majeure Event and of its effect upon the performance of the Party's obligations under this Agreement.

The party shall, and shall ensure that its Subcontractors shall, at all times take all reasonable steps within their respective powers and consistent with Good Operating Practices (but without incurring unreasonable additional costs) to:

- a) Prevent Force Majeure Events affecting the performance of the party's obligations under this Agreement.
- b) mitigate the effect of any Force Majeure Event and
- c) Comply with its obligations under this Agreement.

If the war like situation has developed in a country where a seller's works is located in this P.O. or there is political instability and Indian Embassy located in that country forbids or advises for not having any business dealing with the sellers located in such zone / region/ country, then BHEL reserves the right to cancel the order.

20. NON-DISCLOSURE AGREEMENT.

All Drawing and Technical Documents relating to the product or it's manufacture submitted by one party to the other, prior or

subsequent to the formation of contract, shall remain property of the submitting party. Drawing, technical documents or other technical information received by one party, shall not without the consent of the other party, be used for any other purpose than that, for which they were provided. Such technical information shall not without the consent of the submitting party, otherwise be used or copied, reproduced, transmitted or communicated to a third party. Patterns supplied by BHEL will remain BHEL's property which shall be returned by the bidder on demand to BHEL. Bidder shall in no way share or use such intellectual property of BHEL to promote his own business with others or to gain a commercial advantage. BHEL reserves the right to claim damages from the bidder, or take appropriate action as deemed fit against the bidder, for any infringement of the provisions contained herein as available under law or equity.

21.SETTLEMENT OF DISPUTES / ARBITRATION.

In case of any dispute arising out of as in connection with this contract, the same shall be referred to arbitration under Arbitration & Conciliation Act 1996 of a sole arbitrator who shall be appointed by mutual consent of the parties. The seat & venue of arbitration shall be Haridwar.

The proceedings shall be conducted in English. The Governing law of contract shall be the substantive law of India.

22. WHARFAGE / DEMURRAGE RESPONSIBILITY.

In the event of delay in receipt of documents by Manager (Stores-Shipping) BHEL-Haridwar and in case where dispatches are made through Unapproved Transporter the sole responsibility for wharfage / demurrage for such delay shall be that of supplier.

23. CONDITIONS FOR AVAILING MICRO & SMALL ENTERPRISES (MSE'S) BENEFITS.

- a) "MSE Suppliers can avail the intended benefits only if they submit along with the offer, attested copies of either EM II certificate having deemed validity (**five years** from the date of issue of acknowledgement in EM II) or valid NSIC certificate or EM II certificate along with attested copy of a CA certificate



BHARAT HEAVY ELECTRICALS LIMITED

HEEP-HARIDWAR, UTTARAKHAND (249403)

General Instructions and Standard Terms & Conditions for bidding against Tender Enquiry (GISTC)

For Indian Bidders (Version June-2021, Rev: 06)

(Format enclosed at annexure-1 where deemed validity of EM II certificate of five years has expired) applicable for the relevant financial year (latest audited). Date to be reckoned for determining the deemed validity will be the date of bid opening (Part 1 in case of two-part bid) or vendor has to give Udyog Adhar Memorandum (UAM). Non submission of such documents will lead to consideration of their bid at par with other bidders. No benefit shall be applicable for this enquiry if any deficiency in the above required documents is found or the requisite documents are not submitted before price bid opening. If the tender is to be submitted through e-procurement portal, then the above require document are to be uploaded on the portal. Documents should be notarized or attested by a Gazetted officer. **UAM need not required to be notarized or attested.**

b) Any new supplier will be eligible for registration with BHEL as MSE supplier provided at least any one of the following documents are submitted along with application for registration: -

1. Udyog Adhar Memorandum (UAM).
2. Valid National Small Industries Commission (NSIC) Certificate.
3. Entrepreneurs Memorandum part II (EM II) certificate (valid based on deemed validity of 5 years) or
4. EM II certificate along with attested copy of CA Certificate (as per prescribed format at annexure-A) applicable for the relevant financial year (latest audited), where the deemed validity of EM II is over.
5. However, credentials of all MSE suppliers will be verified before advancing the intended benefits.
6. MSE bidders claiming SC/ST status will have to submit SC/ST certificate of the Proprietor from competent authority. Attested (notarized or attested by Gazetted officer) copy to be submitted along with the offer.
7. In case techno-commercial accepted bidders include MSE source and their prices (based on landed cost – considering quoted prices) are within the price band of 15% w.r.t. L-1 bidder, then BHEL can offer **25%** of quantity of respective item (rounded off to nearest number) to MSE bidders at L-1 price and in case, more than one MSE bidder is in 15 % band and the same is accepted by more than one MSE bidders then **25%** quantities of respective items will be considered for ordering on proportionate basis amongst MSE bidders.

8. There will be minimum of **3%** reservation for women owned MSEs within the above mentioned 25% reservation.
9. The reservation for MSEs owned by SC/ST will be **6.25%** { 25% out of target of 25% - refer para 4 of Public Procurement Policy for the Micro and Small Enterprises(MSEs)}.
10. The definition of MSEs owned by Women Entrepreneurs is clarified as under:
 - a) In case of proprietary MSE, proprietor shall be Woman.
 - b) In case of partnership MSE, the Woman partners shall be holding at least 51% of share in the unit.
 - c) In case of Private Limited companies, at least 51% share shall be held by Women promoters.
11. The definition of MSEs owned by SC/ST is clarified as under:
 - a) In case of proprietary MSE, proprietor(s) shall be SC/ST.
 - b) In case of partnership MSE, the SC/ST partners shall be holding at least 51% of shares in the unit.
 - c) In case of Private Limited companies, at least 51% share shall be held by SC/ST promoters.
12. While distributing the **25%** quantity amongst MSE bidders the decimal points in quantity shall be ignored for all the bidders except the L-1 amongst MSE bidders. Balance quantity after allocating the quantity to other MSE bidders ignoring the quantities in decimal, shall be given to L-1 (amongst MSE) bidder. However, if there are more than one MSE bidder at the same price level than preference for additional quantities due to ignoring off the decimal (as mentioned above) shall be given to the bidder offering favorable terms to BHEL and if the conditions offered are also same then preference will be given to the bidder having high SPR rating.
13. In case there are more than one MSE bidders (with different landed cost to BHEL) within 15% price band of lowest bidder and quantity to be offered is 1 no. only, then preference shall be given to the MSE bidder with lowest landed cost.
14. In case there are more than one MSE bidders (with same landed cost to BHEL) within 15% price band of lowest bidder and quantity to be offered is 1 no. only, then preference shall be given first, based on the favorable terms in the bid and in case terms are also same, the bidder with high SPR rating shall be given preference.
15. If L1 bidder is MSE bidder, entire quantity will be given to such MSE bidder only.



BHARAT HEAVY ELECTRICALS LIMITED

HEEP-HARIDWAR, UTTARAKHAND (249403)

General Instructions and Standard Terms & Conditions for bidding against Tender Enquiry (GISTC)

For Indian Bidders (Version June-2021, Rev: 06)

16. Note: It may however be noted that MSE guidelines as on date (Date of Technical Bid Opening Part-1) shall prevail.

17. "As per the OM No. F.No. 1(2)(1)/2016-MA dtd. 09.02.2017 issued from the Office of Development Commissioner (Micro, Small & Medium Enterprises), "Traders and agents should not be allowed to avail the benefits extended under the PP Policy."

In view of this, it is clarified that benefits of MSE (such as EMD Waiver, Tender fee exemption, Price preference, Payment preference etc.) will be given only to those MSE Vendors who are manufacturers of offered items against the NIT. No MSE benefits shall be provided to Agents / Stockists / Dealers / Traders etc. for the items offered but not manufactured by themselves."

24. INFORMATION TO THE BIDDERS.

a) Purchase related information is available at our Business-to-Business (B2B) Portal available on our website <https://hwr.bhel.com>. The user ID & password can be obtained by sending a request to concerned purchase executives.

b) Intimate your change in mail address or communication address or changes, if any, by email to AGM (SDX/MM) giving your bidder Code.

c) Please resolve your rejections and unexecuted overdue purchase order immediately which are posted at our B2B Portal, which can be visited through our site <https://hwr.bhel.com>

d) Copy of this Tender Enquiry is being sent through the post.

e) The Bidder declares that they will not enter into any illegal or undisclosed agreement or understanding, whether formal or informal with other bidder(s). This applies in particular to prices, specifications, certifications, subsidiary contracts, submission or non-submission of bids or any other actions to restrict competitiveness or to introduce cartelization in the bidding process.

In case, the bidder is found having indulged in above activities, suitable action shall be taken by BHEL as per extant policies/guidelines.

f) Supplier must upload digitally signed e-Invoice on B2B portal for processing of Bills.

In other cases, inked signed hard copy of Invoice to be submitted for processing of Bills.

25. MAKE IN INDIA (GOVT-NOTIFICATION).

A. This tender enquiry shall be governed by notification no. P-45021/2/2017-PP (BE-II) dated 04.06.2020 of government of INDIA and subsequent circulars issued afterwards. Accordingly, the minimum local content, the margin of purchase preference and the procedure for preference to make in INDIA shall be adhered.

B. The margin of purchase preference shall be 20%.

- 'Class-I local Supplier' means a supplier or service provider, whose goods, services or works offered for procurement, has local content equal to or more than 50%, as defined under this order.
- 'Class-II local Supplier' means a supplier or service provider, whose goods, services or works offered for procurement, has local content more than 20% but less than 50%, as defined under this order.
- 'Non- local Supplier' means a supplier or service provider, whose goods, services or works offered for procurement, has local content less than or equal to 20%, as defined under this order.

C. Vendor to specifically confirm if they are Class-I or Class-II local supplier or not as per above mentioned notification. Accordingly, the 'Class-I local supplier' / 'Class-II local Supplier' at the time of tender, bidding or solicitation shall be required to indicate percentage of local content and provide self-certification that the item offered meets the local content requirement for 'Class-I local supplier' / 'Class-II local Supplier', as the case may be. They shall also give details of the location(s) at which the local value addition is made.

D. In cases of Procurement for a Value in Excess of Rs. 10 Crores, the 'Class-I local supplier' / 'Class-II local Supplier' shall be required to provide a Certificate from the Statutory Auditor or Cost Auditor of the Company (in the case of companies) or from a practicing Cost Accountant or practicing Chartered Accountant (in respect of suppliers other than companies) giving the percentage of Local Content.



BHARAT HEAVY ELECTRICALS LIMITED

HEEP-HARIDWAR, UTTARAKHAND (249403)

General Instructions and Standard Terms & Conditions for bidding against Tender Enquiry (GISTC)

For Indian Bidders (Version June-2021, Rev: 06)

E. Requirement of Purchase Preference:

Purchase preference shall be given to 'Class-I local supplier' in procurements undertaken by procuring entities in the manner specified hereunder -

a. In the procurements of goods or works, which are covered by para 3(b) of mentioned Govt. circular and which are divisible in nature, the 'class-I local supplier' shall get purchase preference over 'Class-II supplier' as well as 'Non-local supplier', as per following procedure:

- i. Among All qualified bids, the lowest bid will be termed as L1. If L1 is 'Class-I local supplier', the contract for full quantity will be awarded to L1.
- ii. If L1 bid is not a 'Class-I local supplier', 50% of the order quantity shall be awarded to L1. Thereafter, the lowest bidder among the 'Class-I local supplier' will be invited to match the L1 price for the remaining 50% quantity subject to the class-I local supplier's quoted price falling within the margin of purchase preference, and contract for that quantity shall be awarded to such 'Class-I local supplier' subject to matching the L1 price. In case such lowest eligible 'Class-I local supplier' fails to match the L1 price or accepts less than the offered quantity, the next higher 'Class-I local supplier' within the margin of purchase preference shall be invited to match the L1 price for remaining quantity and so on, and contract shall be awarded accordingly. In case some quantity is still left uncovered on Class-I local supplier, then such balance quantity may also be ordered on the L1 bidder".

b. In the procurements of goods or works, which are covered by para 3(b) of mentioned Govt. circular and which are not divisible in nature, and in procurement of services where the bid is evaluated on price alone, the 'class-I local supplier' shall get purchase preference over 'Class-II supplier' as well as 'Non-local supplier', as per following procedure:

- i. Among all qualified bids, the lowest bid will be termed as L1. If L1 is 'Class-I local supplier', the contract will be awarded to L1.
- ii. If L1 is not 'Class-I local supplier', the lowest bidder among the 'Class-I local supplier', will be invited to match the L1 price subject to Class-I local supplier's quoted price falling

within the margin of purchase preference, and the contract shall be awarded to such 'Class-I local supplier' subject to matching the L1 price.

- iii. In case such lowest eligible 'Class-I local supplier', fails to match the L1 price, the 'Class-I local supplier' with the next higher bid within the margin of purchase preference shall be invited to match the L1 price and so on and contract shall be awarded accordingly. In case none of the 'Class-I local supplier' within the margin of purchase preference matches the L1 prices, the contract may be awarded to the L1 bidder.

c. 'Class-II local supplier' will not get purchase preference in any procurement, undertaken by procuring entities.

F. For this procurement, the local content to categorize a supplier as a Class-I local supplier/ Class-II local supplier/ Non-local supplier and purchase preference to Class-I local supplier, is as defined in Public Procurement (Preference to Make in India), Order 2017 dated 04.06.2020 issued by DPIIT. In case of subsequent orders issued by nodal ministry, changing the definition of local content for the items of the NIT, the same shall be applicable even if issued after issue of this NIT, but before opening of Part-II bids against this NIT.

G. Procurements where estimated value to be procured is less than Rs. 5 lakhs shall be exempted from GOI order No. P-45021/2/2017-PP (BE-II) dated 04.06.2020.

H. For procurement of Goods & Services which are divisible in nature, following shall be operated for **MSE bidders** under Public procurement Policy for the Micro and Small Enterprises (MSEs) Amendment Order, 2019, Ref. No. AA:SSP: MSE: Amndt, dtd. 30.11.2018, Circular No. 44 of 2018-19;-

a. If L1 bid is not from "Class-I local Supplier" and price quoted by MSE bidder falls within the margin of Purchase preference (L1+15% for MSEs), then 25 % of total order quantity of respective item (rounded off to nearest number) shall be awarded to MSE bidder, subject to MSE bidder matching the L1 Price. Out of Remaining 75% quantity, distribution shall be operated as per below sub-clause (2) –

b. If "Class- I Local Supplier" (Next to L1, other than MSE) quoted price falling within the Margin of Purchase Preference, and "Class-I local supplier" matches the L1 price,



BHARAT HEAVY ELECTRICALS LIMITED

HEEP-HARIDWAR, UTTARAKHAND (249403)

General Instructions and Standard Terms & Conditions for bidding against Tender Enquiry (GISTC)

For Indian Bidders (Version June-2021, Rev: 06)

then 50% of remaining Quantity (after allocation of 25% to MSE) i.e. 37.5% shall be awarded to local supplier and 37.5% shall be awarded to foreign bidder.

Note: L1 Price refers to lowest evaluated / landed cost to Company.

For Further details, please refer GOI order no. P-45021 / 2 / 2017 - PP (BE-II) dated 04.06.2020.

26. RESTRICTIONS UNDER RULE 144(XI) OF THE GENERAL FINANCIAL RULES (GFRs), 2017

All provisions of Order No. F.No.6/18/2019-PPD of Department of Expenditure (DoE) shall be applicable for this tender enquiry (Order copy is available at <https://doe.gov.in/procurement-policy-divisions>). Accordingly, any bidder from a country which shares a land border with India (except the countries to which the Govt. of India has extended lines of credit or in which the Govt. of India is engaged in development projects for which list is available at <https://www.mea.gov.in/>) will be eligible to bid in this tender only if the bidder is registered with the Competent Authority as specified in Annex I of the said Order of DoE.

Updated list of the countries to which lines of credit have been extended or in which development projects are undertaken are available on the Ministry of External affairs website (<https://www.mea.gov.in/>)

For the purpose of this order, definition of Bidder from a country which shares a land border with India shall be same as defined in the Annex III of the said order.

Registration with the competent authority as stipulated in the said order is responsibility of bidder. Bidder has to submit a certificate certifying following along with offer:

"I have read the clause regarding restrictions on procurement from a bidder of a country which shares a land border with India; I certify that bidder (.... Name of Bidder) is not from such a country or, if from such a country, has been registered with the Competent Authority. I hereby certify that bidder (.....Name of bidder) fulfils all requirements in this regard and is eligible to be considered"

If the bidder is from such country which shares a land border with India evidence of valid registration by the Competent Authority shall also be attached along with offer."

27. NOTE.

- a) Special conditions of enquiry, if enclosed by BHEL, will supersede the respective standard / general terms of enquiry.
- b) Any other Standard terms and Conditions of the bidder attached / referred against the tender enquiry will be treated as null and void ab initio.
- c) In order to protect the commercial interests of BHEL, it becomes necessary to take action against suppliers / contractors by way of suspension of business dealings, who either fail to perform or are in default without any reasonable cause, cause loss of business / money / reputation, indulged in malpractices, cheating, bribery, fraud or any other misconducts or formation of cartel so as to influence the bidding process or influence the price etc. Guide- lines for Suspension of Business Dealings with Suppliers / Contractors shall prevail over which is available at BHEL website <http://www.bhel.com>
- d) The bidder along with its associate / collaborators / sub-contractors / sub-vendors / consultants / service providers shall strictly adhere to BHEL Fraud Prevention Policy displayed on BHEL website <http://www.bhel.com> and shall immediately bring to the notice of BHEL-Management about any fraud or suspected fraud as soon as it comes to their notice.
- e) "BHEL shall recover the amount of compensation paid to victim(s) by BHEL towards loss of life / permanent disability due to an accident which is attributable to the negligence of contractor, agency or firm or any of its employees as detailed below;
 1. **Victim:** Any person who suffers permanent disablement or dies in an accident as defined below.
 2. **Accident:** Any death or permanent disability resulting solely and directly from any unintended and unforeseen injurious

Quotations / Bids not in accordance with General Instructions and Standard Terms & Conditions are likely to be ignored.



BHARAT HEAVY ELECTRICALS LIMITED

HEEP-HARIDWAR, UTTARAKHAND (249403)

General Instructions and Standard Terms & Conditions for bidding against Tender Enquiry (GISTC)

For Indian Bidders (Version June-2021, Rev: 06)



occurrence caused during the manufacturing / operation and works incidental thereto at BHEL factories/ **offices and precincts** thereof , project execution , erection and commissioning, services, repairs and maintenance, trouble shooting, serving , overhaul, renovation and retrofitting , trial operation, performance guarantee testing undertaken by the company or during any works / during working at BHEL Units/ Offices/ townships and premises/ project sites.

3. Compensation in respect of each of the victims:

- (i) In the event of death or **permanent disability** resulting from **Loss of both limbs**: Rs. 10,00,000/- (Rs. Ten Lakh).
- (ii) In the event of **other permanent disability**: Rs. 7,00,000/- (Rs. Seven Lakh).

4. Permanent Disablement: A disablement that is classified as a permanent total disablement under the proviso to Section 2(I) of the Employees Compensation Act, 1923.”

f) The bidder shall be in compliance with applicable laws, rules and regulations throughout the terms of the contract for conducting its business generally and to perform its obligations under this contract.

दिनांक एवं हस्ताक्षर SIGN & DATE		उत्पाद मानक PRODUCT STANDARD	ST48010 मुख पृष्ठ PREFACE SHEET
संपत्ती सूची संख्या INVENTORY NO. संपत्ती सूची संख्या को अधिकारिता प्रदान है	केवल आंतरिक प्रयोग हेतु प्रदायक को देने से पूर्व इस मुखपृष्ठ को निकाल दें । FOR INTERNAL USE ONLY REMOVE THIS PREFACE BEFORE ISSUE TO SUPPLIERS.		
COPYRIGHT AND CONFIDENTIAL <small>The information on this document is the property of Bharat Heavy Electricals Limited. It must not be used directly or indirectly in any way detrimental to the interest of the Company.</small>	समतुल्य मानक/सूची आदि COMPARABLE STANDARDS / CATALOGUES ETC. } : NO		
स्वत्वाधिकार गोपनीय <small>इस दस्तावेज में दी गई सूचना भारत भारती भारतीभारत की सम्पत्ति है इसका प्रयोग एवं प्रकाशक बन से किसी भी तरह प्रयोग, जो कि कंपनी के हित में प्रतिकारक छे न किया जाए ।</small>	सुझाए/सम्भावित प्रदायक एवं श्रेणी SUGGESTED / PROBABLE SUPPLIERS AND GRADES. 1. Fisher Rose Mount. (Model- 3051) 2. ABB. 3. Fuji. 4. Tata Honeywell.		
दिनांक एवं हस्ताक्षर SIGN & DATE संपत्ती सूची संख्या INVENTORY NO. P-5731	कोई अन्य जानकारी ANY OTHER INFORMATIONS } : NONE		
दिनांक एवं हस्ताक्षर SIGN & DATE 07.04.16	संपत्ती सूची संख्या INVENTORY NO. REV.NO. 04 DL 07.04.16	स्वीकृति APPROVED : Sd/-  (A.K. MITTAL) तैयारी PREPARED : STE	जारी ISSUED : TSX दिनांक : DATE : 20.5.88

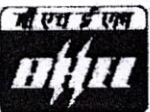
दिनांक एवं हस्ताक्षर SIGN & DATE		उत्पाद मानक PRODUCT STANDARD	ST 48010 पृष्ठ 8 का 1 Page 1 of 8
-------------------------------------	---	---	--

SUPERSEDES INVENTORY NO.
 धारणी पूर्ण संख्या को अधिस्थिति अर्थात्

PRESSURE/DIFFERENTIAL PRESSURE TRANSMITTER/
TRANSMITTER FOR FLOW
(SMART TYPE)

1.0 SCOPE:

This specification covers the technical requirements of Electronic Pressure Transmitter used for gauge pressure, absolute pressure, differential pressure and flow measurements. The transmitter shall be complete with sensing element, amplifier etc. To suit the input pressure, output signal range, power supply and other technical requirements.

1.1 APPLICATION:

It shall be suitable for power plant applications for steam water and oil services. The transmitter shall be of proven performance & highest reliability.

1.2 DESIGNATION:

A pressure transmitter to this standard of range 0-025 Kg/Cm2 and size no. 005 shall be designated as follows :

On Drawing

- i) Drg. No. Column : ST 48010.007
- ii) Description Column : Press. Transmitter 0-025 Kg/Cm2
- iii) Material Specification column : ST 48010
- iv) Material Code column : W97372651069

For placing Purchase Indents:

- i) Pressure transmitter 0-025 Kg/Cm2. ST 48010.005



2.0 COMPLIANCE WITH NATIONAL STANDARD:

There is no Indian standard on the above subject. However assistance has been taken from BS6447 and data sheets of various Manufacturers.

COPYRIGHT AND CONFIDENTIAL
 The information on this document is the property of Bharat Heavy Electrical Limited. It must not be used directly or indirectly in any way detrimental to the interest of the company

स्वत्वाधिकार एवं गोपनीय
 इस दस्तावेज में दी गई सूचना भारत भारी भारी विद्युत निगम की संपत्ति है। इसका प्रयोग एवं प्रसारण के बिना भारत भारी विद्युत निगम के हितों को नुकसान पहुंचाने के लिए न किया जाए



दिनांक एवं हस्ताक्षर SIGN & DATE 23/8/07	TSX	D.L.OBEROI	नाम NAME		दिनांक एवं हस्ताक्षर SIGNATURE & DATE
	QAX	S.K.ARORA			
	MEMBER P.4.	N.R.DEX	अनुवादक TRANSLATED BY		
			निर्माणाकर्ता WORKED BY	S.K. SHARMA	21/8/07
			जांचकर्ता CHECKED BY	K.B. BATRA	21/8/07
			पर्यवेक्षणकर्ता SUPERVISED BY		
धारणी पूर्ण संख्या INVENTORY NO. P-5731	सहमत विभाग AGREED DEPT.	नाम NAME	दिनांक एवं हस्ताक्षर DATE & SIGNATURE	स्वीकृति APPROVED :	GR 3.50
	WORKED BY	J.S.B		(S.K. BHALLA)	
	AGREED BY	V.KUMAR			
	REV.NO. 04	BRIJ LAL RAO	07/04/16	निर्माण PREPARED : STE	दिनांक DATE : 20-8-88
	Dt.			जारी ISSUED : TSX	

दिनांक एवं हस्ताक्षर SIGN & DATE		उत्पाद मानक PRODUCT STANDARD	ST 48010 पृष्ठ 8 का 2 Page 2 of 8	
SUPERSEDES INVENTORY NO. अगली सूची संख्या में परिवर्तित करने के लिए	<p>3.0 TECHNICAL REQUIREMENTS</p> <p>3.1 MEASURING PRINCIPLE : Variable capacitance or any other principle well proven for power plant application involving <u>electromagnetic noise</u>. Bidder shall furnish all details required to establish the provenness.</p> <p>3.2 TYPE: The Transmitter shall be intelligent (SMART) two-wire type. It shall have the capability of remote ranging and self-diagnostics and shall be able to communicate digitally with a higher order control system through suitable interfaces.</p> <p>3.3 OUTPUT: Linear 4-20mA D.C.with a superimposed digital signal. Digital signal shall be as per latest version of Highway Addressable Remote Transducer (HART) protocol. Digital communication with the transmitter shall in no way affect the analog output.</p> <p>3.4 POWER SUPPLY: Transmitter shall be capable of operation at a dc voltage from +15 to +30 Volt. Load-voltage curve shall be furnished along with the offer. Minimum load shall be 600 ohm at 24 V DC</p> <p>3.5 FIELD COMMUNICATOR: It shall be possible to diagnose, calibrate and adjust all transmitter parameters from a hand held field communicator and from a remote PC. The field communicator and the PC based configuration software shall be offered as an optional item. Field communicator shall be battery operated.</p> <p>3.6 DIGITAL COMMUNICATION: Necessary Protocol and configuration details shall be furnished by the supplier, if desired by BHEL, to establish a digital link with BHEL's DDC system/ PC based configuration station.</p> <p>3.7 LOCAL ADJUSTMENTS: Local span and zero adjustments shall also be provided. Which shall be lockable.</p> <p>3.8 FLOW MEASUREMENT: If the requirement of Flow Transmitter is specified in the enquiry, The output shall be Square root extracted.</p> <p>3.9 LOCAL INDICATOR: Transmitter shall have local digital indication</p>			
COPYRIGHT AND CONFIDENTIAL The information on this document is the property of Bharat Heavy Electricals Limited. It must not be used directly or indirectly in any way detrimental to the interest of the company.				
दिनांक एवं गोपनीयता इस दस्तावेज़ में दी गई सूचना केवल शक्ति प्रणाली के लिए है। इसका प्रयोग अन्य किसी अन्य उद्देश्य के लिए नहीं किया जाना चाहिए।				
दिनांक एवं हस्ताक्षर SIGN & DATE 2/11/04				
अगली सूची संख्या INVENTORY NO. P-5731	REV. NO. 04		निर्माणकर्ता WORKED BY S.K. SHARMA  Sd/-	8.9.04
			जांचकर्ता CHECKED BY K.B. BATRA Sd/-	8.9.04





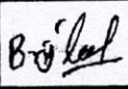

रिजर्व पद प्रमाणित Reserve pd pramanit		उत्पाद मानक PRODUCT STANDARD	ST 48010 पृष्ठ 8 का 3 Page 3 of 8
सुपरसेडेड इन्वेंटरी नं. SUPERSEDES INVENTORY NO.	<p>4.0 PERFORMANCE SPECIFICATIONS:</p> <p>4.1 ACCURACY: $\pm 0.075\%$ or better of calibrated span (inclusive of hysteresis, linearity & repeatability) at turn down ratio of 10:1 or less. (For Absolute Pressure Range $\pm 0.1\%$ or Better)</p> <p>4.2 ENVIROMENTAL CONDITIONS:</p> <p>Ambient temp. : -20 to + 80° C. Storage temp. : -20 to +80° C. Humidity. : Continuous operation at RH of 95%.</p> <p>4.3 DRIFT (LONG TERM): Less then $\pm 0.15\%$ of span in <u>three years</u>. (For Absolute Pressure Range Less than 10% ^{of} Span in one year)</p> <p>4.4 SUPPLY VOLTAGE EFFECT. : Less than 0.005 % per volt.</p> <p>4.5 TEMPERATURE EFFECT. : Less than $\pm 0.05\%$ of span per 100° C.</p> <p>4.6 ZERO ELEV.AND SUPPRESS: Anywhere within the range limits maintaining minimum allowable span.</p> <p>4.7 TURN ON TIME: Max. 10 sec after power is applied to the transmitter.</p> <p>4.8 DAMPING: Min 0-16 second, selectable in steps.</p> <p>4.9 VIBRATION EFFECT: +/- 0.2 % of span per g at 200 Hz in any axis.</p> <p>4.10 RESPONSE TIME: Transmitter response time (63 % as per BS6447) shall be <150 ms. This shall include the dead time. Response time for output to reach 1% of the final value shall also be informed by the supplier.</p> <p>4.11 OVER RANGE PRESSURE: The Transmitter shall be capable of withstanding the over range pressure as given in BS 6447.</p> <p>4.12 Transmitter shall be immune to interference from electromagnetic noise. When a 1V, 50 m Hz alternating voltage is superimposed on the o/p signal, the change in mean dc level of output current shall not exceed 0.1% of output span.</p> <p>4.13 UPDATE TIME: Worst case output update time shall be 50 m sec.</p> <p>4.14 MOUNTING POSITION EFFECT: Zero shift should be able to be calibrated out by zero adjustment.</p>		
कॉपीराइट एंड कॉन्फिडेंशियल COPYRIGHT AND CONFIDENTIAL The information on this document is the property of Bharat Heavy Electricals Limited. It must not be used directly or indirectly in any way detrimental to the interest of the company.	<p style="text-align: center;"> रिजर्व पद गोपनीय Reserve pd gopnigya इस दस्तावेज में दी गई सूचनाएं केवल ही भारतीय विद्युत प्राधिकरण की संपत्ति हैं। इनका प्रयोग केवल ही भारतीय विद्युत प्राधिकरण के लिए ही किया जाना चाहिए। अन्य किसी भी उद्देश्य के लिए इस दस्तावेज का उपयोग नहीं किया जाना चाहिए। </p>		
रिजर्व पद दिनांक SIGN & DATE 3/11/04	REV. NO. 04		
इन्वेंटरी नं. INVENTORY P-5731		निर्माता/कार्यकर्ता WORKED BY S.K. SHARMA	8.9.04
		जांचकर्ता CHECKED BY K.B. BATRA	Sd/- 8.9.04

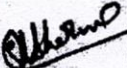
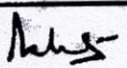
Rev. सं. संख्या SIGN & DATE		उत्पाद मानक (हीप : हरिद्वार)		ST48010
		PRODUCT STANDARD (HEEP: HARIDWAR)		पृष्ठ 8 का 4 Page 4 Of 8

SUPERSEDES INVENTORY	जारी की गयी संख्या अधिकतम संख्या	<p>5.0 <u>PHYSICAL SPECIFICATIONS:</u></p> <p>5.1 <u>HOUSING:</u> Cast Aluminum Stoving enamel painted weather proof.</p> <p>5.2 <u>PROTECTION CLASS:</u> IP 67</p> <p>5.3 <u>WETTED PARTS:</u> SS 316</p> <p>5.4 <u>PROCESS CONNECTION:</u> G 1/2" Male. In case an adopter is used to provide G 1/2" connection, it shall be factory fitted on the Transmitter. (REF.FIG.-1,SH-8).</p> <p>5.5 <u>FLANGE MATERIAL:</u> SS (In case of DPT).</p> <p>5.6 <u>ELECTRICAL CONNECTION:</u> Three Pin Plug receptacle connector (Amphetronics/Allied make Or equivalent). Male part of the connector will be fixed with the Transmitter.</p> <p>5.7 <u>MOUNTING BRACKET:</u> Transmitter shall be supplied with bracket for panel mounting along with Necessary fastners to mount the transmitter on the bracket. 04 Nos. mounting studs of size M10x70 With fine threads (material CS) shall be supplied for DPT and Flow transmitters only.</p> <p>6.0 <u>TURN DOWN RATIO:</u> Minimum turn down ratio shall be 100:1 (for absolute pressure range minimum turn down ratio shall be 25:1). By using turndown ratio of the Transmitter, minimum variety of models shall be selected to cover all the ranges mentioned in the enquiry. It may be noted that specified accuracy is to be maintained for the calibrated rated range in each case.</p> <p>7.0 <u>IDENTIFICATION TAG:</u> A blank stainless steel tag of size 60x20 mm shall be fastened with each Transmitter.</p> <p>8.0 <u>TESTS:</u> Following tests shall be carried out by the supplier on each transmitter.</p> <p>8.1 <u>ROUTINE TESTS:</u> a) Visual and dimensional check, b) Pressure range versus output signal test. c) Accuracy test. d) Test for adjustability of range. e) Process and electrical connection.</p>	COPYRIGHT AND CONFIDENTIAL The information on this documents is the property of Bharat Heavy Electrical Limited. It must not be used directly or indirectly in any way detrimental to the interest of the company
जारी की गयी संख्या अधिकतम संख्या	जारी की गयी संख्या अधिकतम संख्या		Rev. सं. संख्या SIGN & DATE

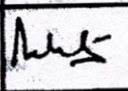
जारी की गयी संख्या INVENTORY NO. P-5731	REV. NO. 04	(SUPERSEDES)	निर्मापकता WORKED BY	BRIJ LAL RAM		06.04.16
			जांचकर्ता CHECKED BY	MAYURI		06.04.16

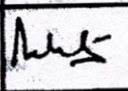
दिनांक एवं हस्ताक्षर SIGN & DATE		उत्पाद मानक PRODUCT STANDARD	ST 48010 पृष्ठ 8 का 5 Page 5 of 8					
सप्लायर की सूची संख्या को संश्लेषित करना है SUPERSEDES INVENTORY	<p>8.2 TYPE TESTS:</p> <p>a). Enclosure protection as per IS 13974 or equivalent international Standard.</p> <p>b). Test for performance characteristics as per specified in clauses 4.3,4.4,4.5,4.9,4.10,4.11,4.12. Method of tests shall be carried out as per BS 6447.</p> <p>9.0 TEST CERTIFICATES:</p> <p>9.1 3 copies of the tests certificate shall be furnished along with each transmitter giving following details:</p> <p>i) Name of instrument. ii) Name of manufacturer. iii) Serial no of the instrument. iv) Date of testing. v) BHEL PO NO. vi) Results of tests detailed in clause 8.0.</p> <p>9.2 Certificate of compliance to specification ST48010.</p> <p>10.0 GUARANTEE :</p> <p>A guarantee certificate of trouble free performance for 24 months from the date of shipment or 12 months from the date of commissioning, which ever is earlier, shall be furnished by the supplier.</p> <p>11.0 DOCUMENTS:</p> <p>Data sheet (<u>Mentioning all the clauses 3.0 to 6.0</u>) of offered transmitters shall be furnished by the bidder for BHEL/Owner's approval. Two copies of detail technical literatures, operation and maintenance manuals shall be furnished with the offer . Complete technical literature is also to be furnished in "<u>SOFT FORM</u>" in a <u>CDROM</u> after placement of order.</p> <p>12.0 DEVIATIONS:</p> <p>Deviations from these specifications, if any, shall be clearly brought out in the offer.</p>							
COPYRIGHT AND CONFIDENTIAL The information on this documents is the property of Bharat Heavy Electrical Limited. It must not be used directly or indirectly in any way detrimental to the interest of the company		स्वत्वधिकार एवं गोपनीय इस प्रलेख में दी गई सूचना भारत हेवी इलेक्ट्रिकल्स की संपत्ति है इस्तेमाल के बिना अनुमति के प्रसारण करना या इस सूचना को किसी भी तरह प्रयोग, जो कि कंपनी के हित में हानिकारक हो न किया जाए						
		दिनांक एवं हस्ताक्षर SIGN & DATE 23/8/03						
सप्लायर की सूची संख्या INVENTORY NO. P-5731	REV. NO. 04		निर्माककर्ता WORKED BY S.K. SHARMA		21/8/03	जांचकर्ता CHECKED BY K.B. BATRA		21.8.03

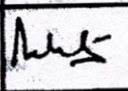
दिनांक एवं हस्ताक्षर SIGN & DATE		उत्पाद मानक PRODUCT STANDARD	ST 48010 पृष्ठ 8 का 6 Page 6 of 8								
सुपरसेडेस इन्वेंटरी नम्बर SUPERSEDES INVENTORY NO.	सामग्री सूची संख्या को संदर्भित करना है	<p>13.0 PACKING : Each instrument with dehydrating agent shall be sealed individually in a polythene sheet and packed in a thermo Cole box. Such boxes shall be packed in a carton or case with adequate cushioning material to withstand transit risks without damage.</p> <p>14.0 Supplier shall enclose the list of spare parts required for 3 years normal operation and quote for the same separately.</p> <p>15.0 QUALITY PLAN: Detail quality plan for the tests and checks to be carried out during material induction, manufacturing and at final stage shall be submitted in BHEL's Format along with in house standard procedures/ norms for BHEL's approval.</p> <p>16.0 MARKING : The following details shall be marked on the packing case. (a) Manufacturer's name or trademark. (b) B H E L order number. (c) BHEL standard NO. - ST48010.</p> <p>17.0 NAME PLATE: Each instrument shall have a name plate with the Following details marked on it : (a) Manufacturer's name or trademark. (b) Type of the Instrument. (c) Model Number of the Manufacturer. (d) Maximum Range. (e) Calibrated Span. (f) Accuracy.</p> <p>18.0 CROSS - REFERRED STANDARDS : (1) IS 13974 (2) BS 6447</p>									
COPYRIGHT AND CONFIDENTIAL The information on this document is the property of Bharat Heavy Electrical Limited. It must not be used directly or indirectly in any way detrimental to the interest of the company.											
स्वतंत्रता एवं गोपनीय इस दस्तावेज में दी गई सूचना भारत भारती उपकरणों की संपत्ति है। इसका प्रयोग एवं प्रसारण के बिना भारत भारती की स्वीकृति के बिना न किया जाए।											
दिनांक एवं हस्ताक्षर SIGN & DATE	23/8/03										
सामग्री सूची संख्या INVENTORY NO.	P-5731	REV. NO. 04	<table border="1"> <tr> <td>निर्माणकर्ता WORKED BY</td> <td>S.K. SHARMA</td> <td></td> <td>21/8/03</td> </tr> <tr> <td>जांचकर्ता CHECKED BY</td> <td>K.B. BATRA</td> <td></td> <td>21.8.03</td> </tr> </table>	निर्माणकर्ता WORKED BY	S.K. SHARMA		21/8/03	जांचकर्ता CHECKED BY	K.B. BATRA		21.8.03
निर्माणकर्ता WORKED BY	S.K. SHARMA		21/8/03								
जांचकर्ता CHECKED BY	K.B. BATRA		21.8.03								

दिनांक एवं हस्ताक्षर SIGN & DATE		उत्पाद मानक PRODUCT STANDARD	ST 48010 पृष्ठ 8 का 7 Page 7 of 8
-------------------------------------	---	---	--

दिनांक एवं हस्ताक्षर SIGN & DATE	SUPERSEDES INVENTORY NO.	A. <u>SIZE NO'S.</u>			
सामग्री सूची संख्या को अधिकारिता प्रदान है		DESC.	MEASURING RANGE KG/SQ.CM. OR BAR	SIZE NO. IN CASE OF KG/SQ.CM.	SIZE NO. IN CASE OF BAR
01. GAUGE PRESSURE		0-250	001	051	
COPYRIGHT AND CONFIDENTIAL The information on this document is the property of Bharat Heavy Electrical Limited. It must not be used directly or indirectly in any way detrimental to the interest of the company		0-200	002	052	
		0-060	003	053	
		0-040	004	054	
		0-025	005	055	
		0-016	006	056	
		0-010	007	057	
		0-006	008	058	
		0-004	009	059	
		(-1)-(0)	010	060	
		(-1)-(+3)	011	061	
		(-1)-(+9)	012	062	
		(-0.3)-(-1)	013	063	
		0-100	014	064	
		0-070	015	065	
		0-050	016	066	
		(-1)-(+15)	017	067	
		(-1)-(+1.5)	018	068	
		0-090	019	069	
		0-400	020	070	
		(-1)-(+80)	021	071	
		(-1)-(+30)	022	072	
		(-1)-(+10)	023	073	

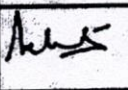
दिनांक एवं हस्ताक्षर SIGN & DATE	REV. NO. 04		निर्माणकर्ता WORKED BY	S.K. SHARMA		21/8/03
सामग्री सूची संख्या INVENTORY NO. P-5731			जांचकर्ता CHECKED BY	K.B. BATRA		21.8.03

SIGN & DATE दिनांक एवं हस्ताक्षर		उत्पाद मानक PRODUCT STANDARD	ST 48010 पृष्ठ 8 का 8 Page 8 of 8
-------------------------------------	---	---	--

SUPERSEDES INVENTORY NO. संस्थापित संख्या एवं संस्थापित संख्या	DESC.	MEASURING RANGE KG/SQ.CM. Or BAR	SIZE NO. IN CASE OF KG/SQ.CM.	SIZE NO. IN CASE OF BAR
	02. ABSOLUTE PRESSURE (PN-4)	0-0.6 Abs 0-0.4 Abs 0-1 Abs	041 042 043	091 092 093
	03. DIFFERENTIAL PRESSURE (PN-100)	0-1000 MMWC 0-100 M BAR	031 —	— 081
		(-100)-(+300) MMWC (-10)-(+30) M BAR	032 —	— 082
		(-100)-(+900) MMWC (-10)-(+90) M BAR	033 —	— 083
	04. FLOW (PN-100)	0-1 BAR 0-60 BAR 0-0.7 0-1.0	— — 101 102	084 085 111 112

COPYRIGHT AND CONFIDENTIAL
 The information on this document is the property of Bharat Heavy Electricals Limited. It must not be used directly or indirectly in any way detrimental to the interest of the company.

गोपनीय
 इस दस्तावेज में दी गई सूचना भारत भारी इलेक्ट्रिकल्स की संपत्ति है। इसका प्रयोग एवं प्रसारण के बिना की जाने वाली नहीं है। इस दस्तावेज को बिना अनुमति के प्रसारित नहीं किया जाये।

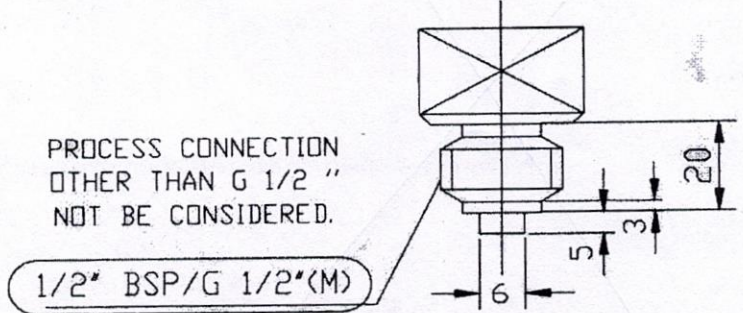

PROCESS CONNECTION
OTHER THAN G 1/2 "
NOT BE CONSIDERED.

FIG -1

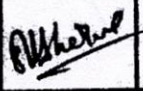
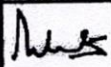
SIGN & DATE दिनांक एवं हस्ताक्षर	23/8/03	REV. NO. 04		निर्माणाकर्ता WORKED BY S.K. SHARMA		21/8/03
INVENTORY NO. संस्थापित संख्या	P-5731			जांचकर्ता CHECKED BY K.B. BATRA		21.8.03

DRAWING NO. 31611770071

PRESSURE TRANSMITTER DATASHEET

1	Drawing Number	
2	KKS TAG No.	
3	Model	3051TA1A2C21AM5Q4 or equivalent
4	Type	Absolute pressure
5	Output signal	4-20mA with Hart Protocol
6	Accuracy	±0.15%
7	Available Range	0-100KPa
8	Housing material	Polyurethane-covered Aluminium
9	Power Supply	24V DC
10	Electrical Connection	Terminals
11	Enclosure Protection	IP65
12	Measure Element Material	SS316L
13	Process connection Wetted Parts Material	SS316L
14	Process Connection	G1/2
15	Mounting Bracket	Yes
16	Process Fluid	Air, water steam
17	Mounted Position	Gas inlet pipeline
18	Function	Sensing gas inlet pressure to DCS
19	Process Range	3.3-100KPa
20	Design operation Value	10.2 KPa
21	Operation Temperature	100 degC (max)
22	Manufacturer	Rosemount Inc

Note: Above instrument is supplied along with equipment. Interchangeable instrument is required for replacement of instrument at site.

Instrument from any customer approved make may also be acceptable if it is interchangeable to originally supplied instrument.

COPYRIGHT AND CONFIDENTIAL
 THE INFORMATION ON THIS DOCUMENT IS THE PROPERTY OF
 BHARAT HEAVY ELECTRICALS LIMITED . IT MUST NOT BE USED DIRECTLY
 OR INDIRECTLY IN ANY WAY DETRIMENTAL TO THE INTEREST OF THE COMPANY.

INVENTORY NO. SIGN & DATE REF. DRG NO.

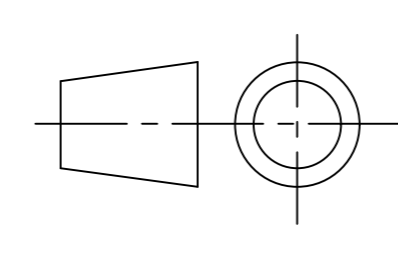
 BHARAT HEAVY ELECTRICALS LTD. HARDWAR		NAME	SIGN	DATE	NO.OF VAR.	
		DRN	LOKESH	.Sd..	11.06.20	---
		CHD	SHIVA KANT	.Sd..	11.06.20	---
		APD	N.PRAKASH	.Sd..	11.06.20	73, 74
DEPT.	HXE	 SCALE WEIGHT(Kg.)	REF. TO ASSY. DRG.		ITEM NO.	NO.OF ITEMS
CODE	4222		--	--	--	--
TITLE		1 CARD CODE X	DRAWING NO.		REV.	
PRESSURE TRANSMITTER FOR VACUUM PUMP			31611770071		---	
SHEET NO.			NO.OF SHEETS			01

ENDORSEMENT SHEET FOR QP
REFERENCE / STANDARD / FIELD QUALITY PLAN (RQP / SQP/RFQP/SFQP)

TO BE FILLED IN BY SUPPLIER AT TIME OF SUBMISSION			To be filled in by NTPC
PROJECT NAME	800 MW, GADARWARA		
CONTRACT NO.:	CS: 9572-110		
MAIN SUPPLIER	M/S BHEL, HEEP, HARIDWAR		
MANUFACTURER WORKS & ADDRESS	1) M/S EMERSON PROCESS PAWNE 2) M/S YIL BANGLORE/(MAKE YOKOGAWA JAPAN) 3) M/S ABB FARIDABAD		
ITEM /EQUIPMENT / SYSTEM/ SUB-SYSTEM DETAILS i.e. MODEL TYPE/SIZE/RATING etc.	ELECTRONIC TRANSMITTERS FOR PRESSURE, DIFFERENTIAL PRESSURE		
APPROVED QP NO.: SQP / RQP	0000 – 999 – QOI – S – 008, REV. NO.: 01 DT. 22.12.2006		
<i>Confirmation by Main Supplier (TICK WHICHEVER APPLICABLE)</i>			
<i>I. That the item/ component is identical to that considered for QP approval</i>			
<i>II. That there are minor changes in the item/ component with respect to that considered for QP approval, however the same do not affect the contents of QP.</i>			
<i>III. That there are minor changes in the item/ component with respect to that considered for QP approval, however the same affect the QP slightly, as indicated below / in attached sheet.</i>			
<p>NOTE: 1. In column 10 (N) of SQP 'W' is to be read as 'V' and only test reports are to be reviewed instead of witnessing. 2. Although date of SQP is expired. The same SQP is endorsed for Gadarwara project. 3. Application: Turbine & Generator integral area & their auxiliaries.</p>			
SIGN.: (Main Supplier)	DATE	SIGN.: (Manufacturer)	DATE:
DISTRIBUTION OF ENDORSEMENT OF			
A) RQP/SQP:			
1. MAIN SUPPLIER (WITH A COPY OF QP)			
2. MANUFACTURER			
3. RIO			
4. CQA-SPL			
5. CQA-O/C			
B) RFQP/SFQP:			
1. MAIN SUPPLIER (with a copy of QP)			
2. MANUFACTURER			
3. NTPC FQA (with a copy of QP)			
4. NTPC Erection (with a copy of QP)			
5. CQA-SPL			
6. CQA-O/C			
The QP is endorsed for this project without any change			
The QP is endorsed for this project with changes as indicated.			
NTPC (Reviewed /Approved by/ Date & Seal)			

2006.12.2
2 15:30:54



Item: (Material, Class, Grade, Rating, Size Etc.) Electronic Transmitters for Pressure, Differential Pressure, Flow & Level		Standard Quality Plan				To Be Filled In By NTPC			Remarks						
Sl. No.	Component & Operations	Class	Characteristics	Type of Check	Quantum Of Check		Reference Document	Acceptance Norms	Format of Record	Agency					
					M	C/N				M	C	N			
		Conforming To Code: BS 6447 & IEC 60770		Quality Plan Number: 0000-999-QOI-S-008		Revision: : 01		Date: 22.12.2006		Page: 01 Of 02		Valid Up To: 21.12.2009		Approved By: Prateek Srivastav	
														S. Samanting O P Niranjani U. R. Khosla	
1	2	4	3	5	6	7	8	9	D** 10	11					
1.00	Raw Materials														
1.01	Raw Materials & Components (Diaphragm, Sensing Material, Housing, Electronic & Other components)	Major	a) Material Properties, Size, Rating, Make, Type / Model No.	Internal Test / Checks	As per Manufacturer's Standard	Purchase Order / Specification / Manufacturers Catalogues / Mfr. Drawing	Purchase Order / Specification / Manufacturers Catalogues / Mfr. Drawing	Internal Records	-	P	-	-	-	-	-
2.00	In Process Inspection														
2.01	Assembly & Fitting	Major	a) Soundness of Fitting, Connections & Terminal Marking	Verification	100%	Purchase Order / Specification / Manufacturers Catalogue / Drawing	Purchase Order / Specification / Mfrs Catalogue / Drawing	Internal Records	-	P	-	-	-	-	-
		Major	b) Insulation Resistance & Dielectric Strength	Measurement	100%	"	"	"	-	P	-	-	-	-	-
3.00	Final Inspection														
3.01	Routine Test	Major	a) Dimensional details & Visual checking (Size, Rating, Make, Type / Model No., Serial No. / Tag)	Measurement / Visual	100%	Purchase Order / Specification / Approved Drawing / Approved Datasheet	Purchase Order / Specification / Approved Drawing / Datasheet	TC	✓	P	W	W	V	-	-
		Major	b) Process Connection / Electric Connection (Plug & Socket Type)	Measurement / Visual	100%	"	"	"	✓	P	W	W	V	-	By Go & No Go Gauge
		Major	c) Accuracy, Calibration & Over Range Test	Measurement	100%	Purchase Order / Specification / Approved Datasheet / Mfrs Catalogues / BS-6447 / IEC-60770	Purchase Order / Specification / Approved Datasheet / Mfrs Catalogues / BS-6447 / IEC-60770	"	✓	P	W	W	W	-	Communication for HART Protocol shall be checked during Calibration

LEGEND: * Records, identified with " Tick" (✓) shall be essentially included by supplier in QA documentation. ** M: Manufacturer / Sub Supplier, C: Main Supplier, N: NTPC, P: Perform, W: Witness and V: Verification as appropriate, "CHP" NTPC shall identify in column "N" As "W".

2006.12

.22

15:31:1

8



Sl. No.	Component & Operations	Characteristics	Class	Type of Check	Quantum Of Check		Reference Document	Acceptance Norms	Format of Record			Agency	Remarks
					M	C/N			M	C	N		
1	2	3	4	5	6	7	8	9	10	11			
<p>Item: (Material, Class, Grade, Rating, Size Etc.) Electronic Transmitters for Pressure, Differential Pressure, Flow & Level</p>													
<p>Standard Quality Plan</p> <p>Conforming To Code: BS 6447 & IEC 60770</p>													
<p>To Be Filled In By NTPC</p> <p>Quality Plan Number: 0000-999-QOI-S-008</p> <p>Revision: 01</p> <p>Date: 22.12.2006</p> <p>Page: 02 Of 02</p> <p>Valid Up To: 21.12.2009</p>													
<p>Reviewed By: Prateek Srivastav</p> <p>Approved By: U. R. Khosla</p>													
<p>4.00 Packing & Dispatch</p>													
<p>d) Effect of Output Load</p> <p>Major</p> <p>Measurement</p> <p>One of Each Type</p> <p>Purchase Order Specification / Approved Datasheet / Manufacturers Catalogues / BS-6447 / IEC-60770</p> <p>8</p> <p>9</p> <p>10</p> <p>11</p>													
<p>a) Completeness of TC's, COC's, Inspection Reports</p> <p>Major</p> <p>Verification</p> <p>100%</p> <p>Ord Specn. & QP</p> <p>100%</p> <p>Documents</p> <p>P</p> <p>V</p>													
<p>b) Identification Marking / Tagging of each Instrument</p> <p>Major</p> <p>Verification</p> <p>100%</p> <p>Ord Specn.</p> <p>100%</p> <p>Internal Records</p> <p>P</p> <p>V</p>													
<p>c) Soundness of Packing against Transit Damage</p> <p>Major</p> <p>Verification</p> <p>100%</p> <p>"</p> <p>P</p> <p>-</p>													

Note: 1) Manufacturer to maintain calibrated instrument having better accuracy than the item under the test. Inspection Engineer shall check the same.
 2) Type Test shall be as per agreement with NTPC Engineering. Review of Type Test clearance - CHP.

LEGEND: * Records, identified with "Tick" (✓) shall be essentially included by supplier in QA documentation. ** M: Manufacturer / Sub Supplier, C: Main Supplier, N: NTPC, P: Perform, W: Witness and V: Verification as appropriate, "CHP" NTPC shall identify in column "N" As "W".