

BHARAT HEAVY ELECTRICALS LIMITED,
(A Government of India Enterprises)
Heavy Plates & Vessels Plant
Visakhapatnam – 530 012 INDIA.
Web Site: www.bhpvl.com



Phone : +91(0891) 6681309, 494
+91(0891) 6681396
Fax : +91(0891) 6681700
E-Mail : skmishra@bhpvl.com

NOTICE INVITING TENDER(NIT)

**Category of Tender: TWO BID
(PRICED + UN - PRICED)**

**SUB: Mechanical items for 25mm plate
bending roll machine**

Our Ref: **MM/2/10/3536/CAP/W-075/5076**

DATE: 22.07.2014

Sealed quotations in duplicate are invited from suppliers on **or before 18.08.2014** **SUPERSCRIBING OUR REFERENCE AND CATEGORY OF TENDER** on the cover, for supply of the under mentioned stores within the above due date, otherwise send **REGRET LETTER**, strictly subject to the Terms & Conditions attached herewith.
LATE TENDERS ARE NOT ACCEPTABLE.

ITEM No.	DESCRIPTION / SPECN. / SIZE	QTY
1.	Mechanical items for 25mm plate bending roll machine	Lot
	Encl: 1. List of Items 1 Pages 2. Drawings 10 Pages 3. General Terms/ commercial terms and conditions 9 Pages (INCLUDING CHECK LIST)	

For BHARAT HEAVY ELECTRICALS LIMITED,

For Sr. MANAGER (MM)

List of items for 25 MM Plate Bending Machine

S.No	Drawing Number	Item Name	Quantity
1.	M4/432/G7-14	U- Cuf for Bending rolls	4 Nos.
2.	M4/2311/G7-134	Top Roller Bull Gear Side Bush	2 Nos.
3.	M4/2307/G7-130	Split Bronze bush side Roller Left Side Gear Box	8 Nos.
4.	M4/2308/G7-131	Bush for left hand side roller	1 No.
5.	M4/3172/G7-185	Casting Bush for 25mm	1 No.
6.	M4/3165/G7-183	Bottom Roll Lifting cylinder	1 No.
7.	M4/3167/G7-184	Top roller for 25 mm bending roll	1 No.
8.	M4/2877/G7-161	Front side roll L.H. bearing	2 Nos.
9.	M2/38/G7-1	Gland Plate Pinch role Lifting Cylinder	2 Nos.
10.	M2/2880/G7-162	Front Side Roll Guide Block for 25mm	2 Nos.

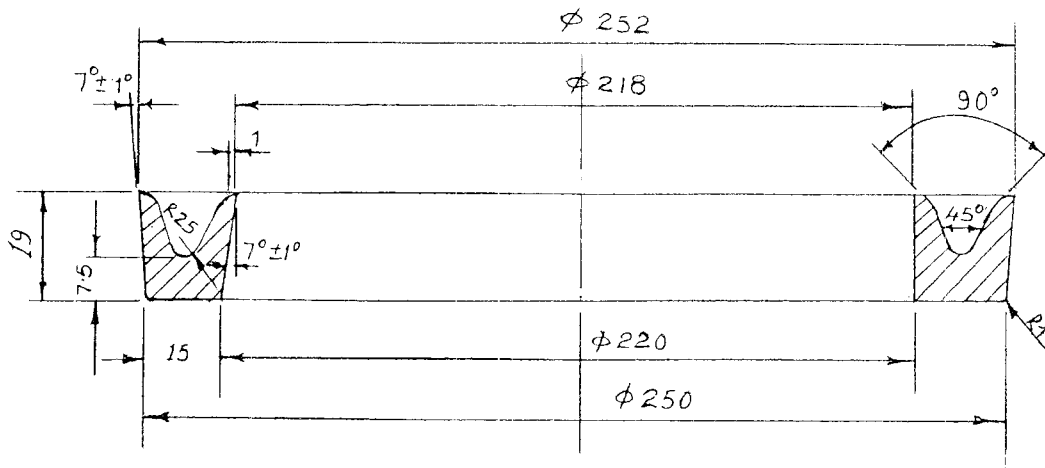

SIZE: 220 X 250

MATERIAL: SYNTHETIC RUBBER

HARDNESS: SHORE 75A TO 80A

WK. PRESSURE: 250 KG/CM²

WK. TEMP: RANGES FROM 30°C TO 100°C

QTY 2 NOS / M/c.

 BHARAT HEAVY PLATE & VESSEL LTD. VISAKHAPATNAM			
PLANT MAINTENANCE		U- CUF FOR BENDING ROLLS XZC 3000/25 I-NO	
DGN.		REF.	
DRN.	<i>[Signature]</i>	M/C TYPE.	
CHD.	<i>[Signature]</i>	SCALE	SIZE
APRD.		M4	M4/432/97-14

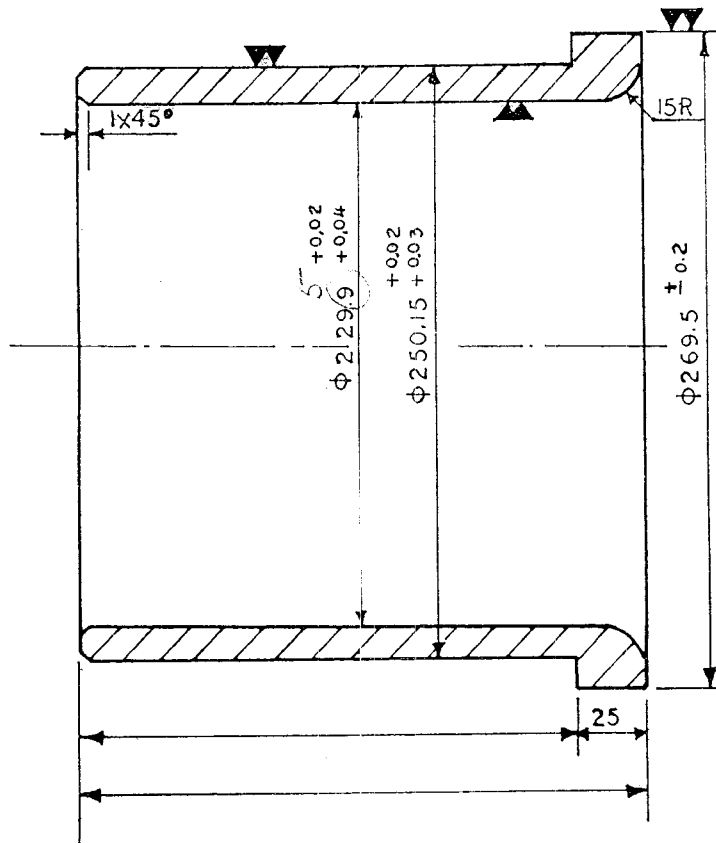

MAT: BRONZE

ITEM No.	DESCRIPTION	MATL./SPEC.	QTY.	REMARKS

▼ ROUGH MACHINING
 ▼ FINE MACHINING
 ▼ GRINDING OR EQUIVALENT
 ALL DIMENSIONS ARE IN MILLIMETRES
 UNLESS OTHERWISE STATED.

 BHADRAT HEAVY PLATE & VESSELS LTD VISAKHAPATNAM-INDIA	
PLANT MAINTENANCE	TOP ROLLER
DGN.	BULL GEAR SIDE BUSH
DRN. <i>V. Prabhakar</i>	M/C TYPE XZP 3000/25 INV. No.
CHD.	SCALE. SIZE. DRAWING No.
APRD.	A4 M4/2311/G7-134

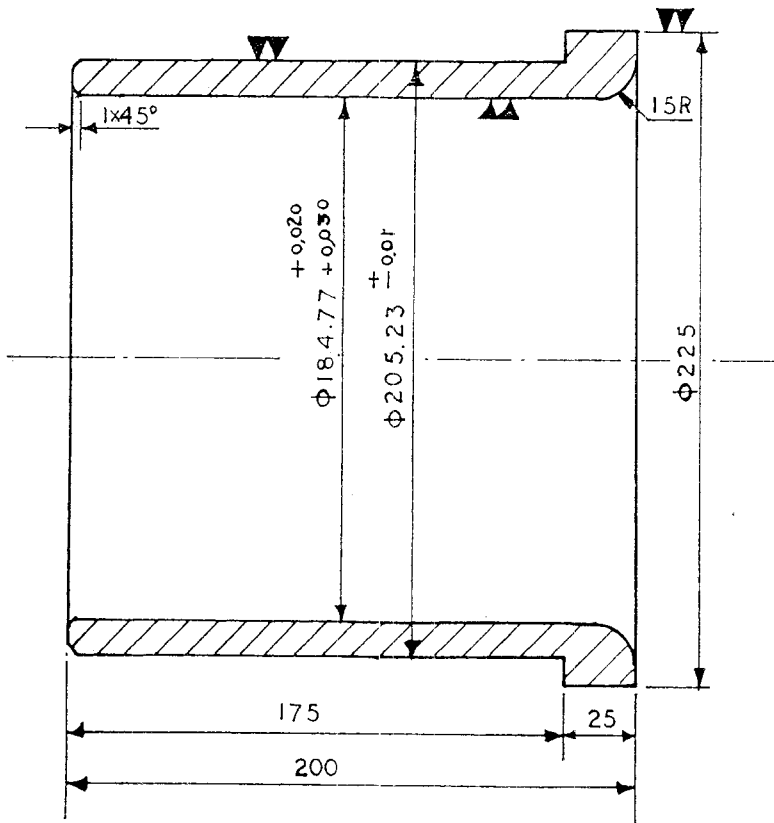

ITEM No.	DESCRIPTION	MATL./SPEC.	QTY.	REMARKS
----------	-------------	-------------	------	---------

▽ ROUGH MACHINING
 ▽ FINE MACHINING
 ▽ GRINDING OR EQUIVALENT
 ALL DIMENSIONS ARE IN MILLIMETRES
 UNLESS OTHERWISE STATED.



BHARAT HEAVY PLATE & VESSELS LTD

VISAKHAPATNAM-INDIA

PLANT MAINTENANCE		SPLIT BRONZE BUSH SIDE		
DGN.		ROLLER LEFT SIDE GEAR BOX		
DRN.	<i>U. Prabhakar</i> 07-11	M/C. TYPE XZP.3000/25	INV. No.	
CHD.	<i>[Signature]</i>	SCALE.	SIZE.	DRAWING No.
APRD.			A ₄	M ₄ /2307/G7-130

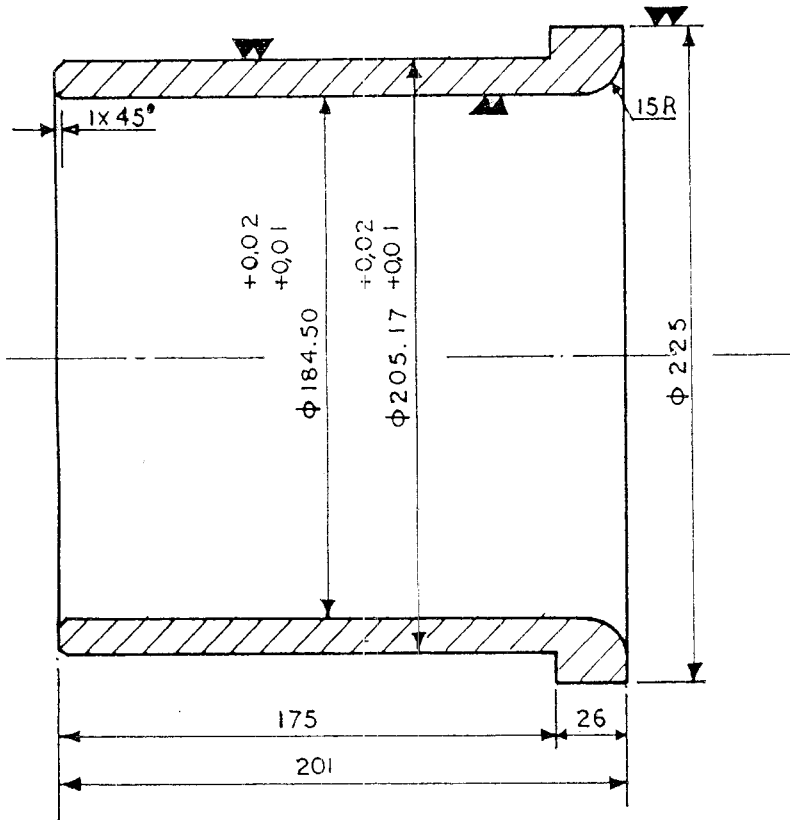

MAT: BRONZE

▼ ROUGH MACHINING
 ▼ FINE MACHINING
 ▼ GRINDING OR EQUIVALENT
 ALL DIMENSIONS ARE IN MILLIMETRES
 UNLESS OTHERWISE STATED.

ITEM No.	DESCRIPTION	MATL./SPEC..	QTY.	REMARKS
 BHARAT HEAVY PLATE & VESSELS LTD VISAKHAPATNAM-INDIA				
PLANT MAINTENANCE		BUSH FOR LEFT HAND SIDE ROLLER		
DGN.	HINGE			
DRN.	<i>U. P. ...</i>	M/C TYPE	X Z P. 3000/25	INV. No.
CHD.	<i>[Signature]</i>	SCALE.	SIZE.	DRAWING No.
APRD.			A ₄	M ₄ / 2308/67-131

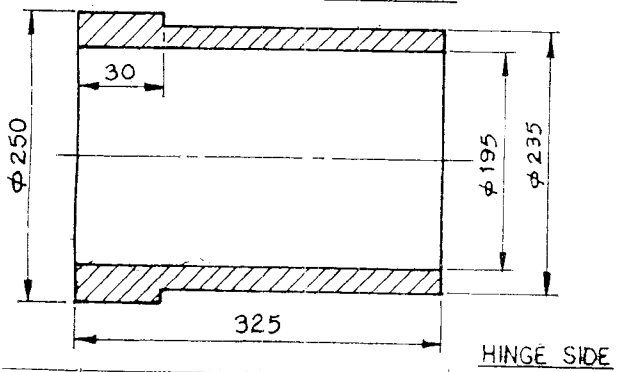
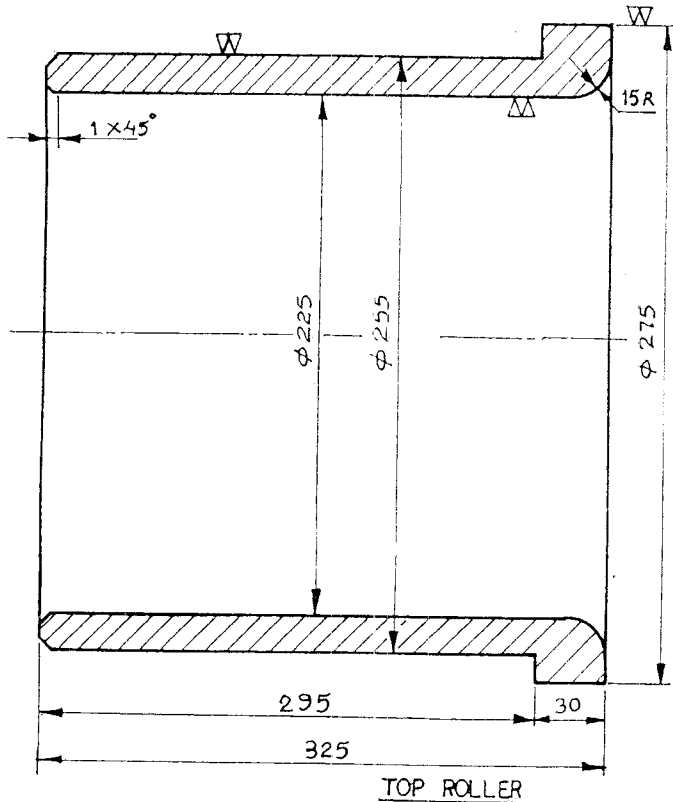

▼ ROUGH MACHINING
 ▼ FINE MACHINING
 ▼ GRINDING OR EQUIVALENT
 ALL DIMENSIONS ARE IN MILLIMETRES
 UNLESS OTHERWISE STATED.

ITEM No.	DESCRIPTION	MATL./SPEC.	QTY.	REMARKS
BHARAT HEAVY PLATE & VESSELS LTD VISAKHAPATNAM-INDIA				
PLANT MAINTENANCE	CASTING BUSH FOR 25 MM			
DGN.	BENDING ROLL			
DRN.	DEMUDU.G 25.11.09	M/C. TYPE	INV. NO.	
CHD.	SCALE.	SIZE.	DRAWING NO.	
APPD.		A4	M4 3172 / G7 - 185	

M 20X300 PCD
8 HOLES THREADED

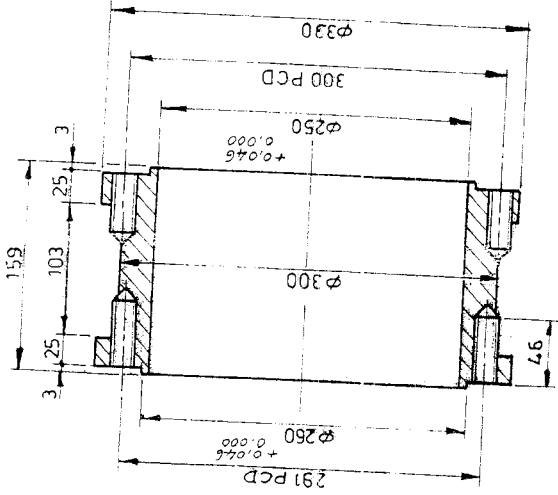
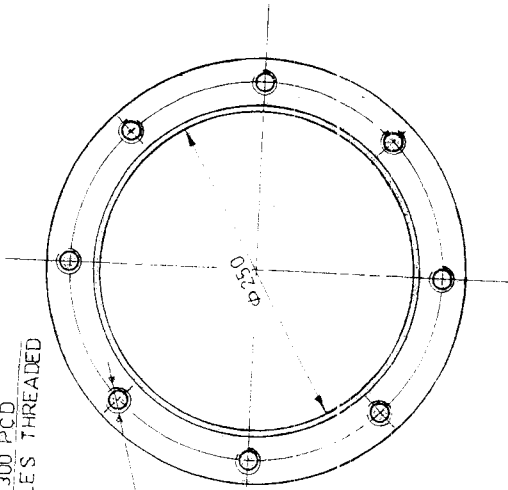

M 20 X 291 PCD
8 HOLES THREADED

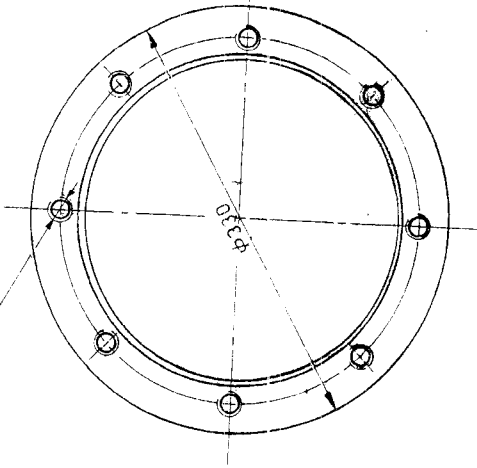

MAT. CAST STEEL

ROUGH MACHINING
FINE MACHINING
GRINDING OR EQUIVALENT

ALL DIMENSIONS ARE IN MILLIMETRES UNLESS OTHERWISE STATED.

REF. DRG. No.

ITEM No.	DESCRIPTION	MATL./SPEC.	QTY.	REMARKS
	 BHARAT HEAVY PLATE & VESSELS LTD VISAKHAPATNAM-INDIA			
PLANT MAINTENANCE		BOTTOM ROLL LIFTING CYLINDER		
DGN.		FOR 25MM BENDING ROLL		
DRN.	Demulla, G 30.10.89	M/C. TYPE	INV. No.	
CHD.	For 10/11/89	SCALE	SIZE.	DRAWING No.
APPR.		A ₁	M. 2165/1.7.107	

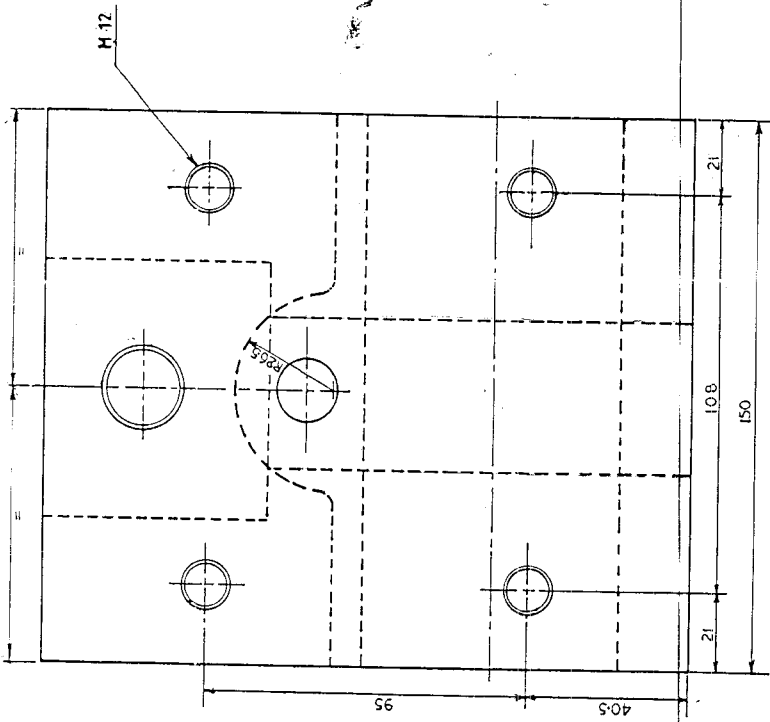
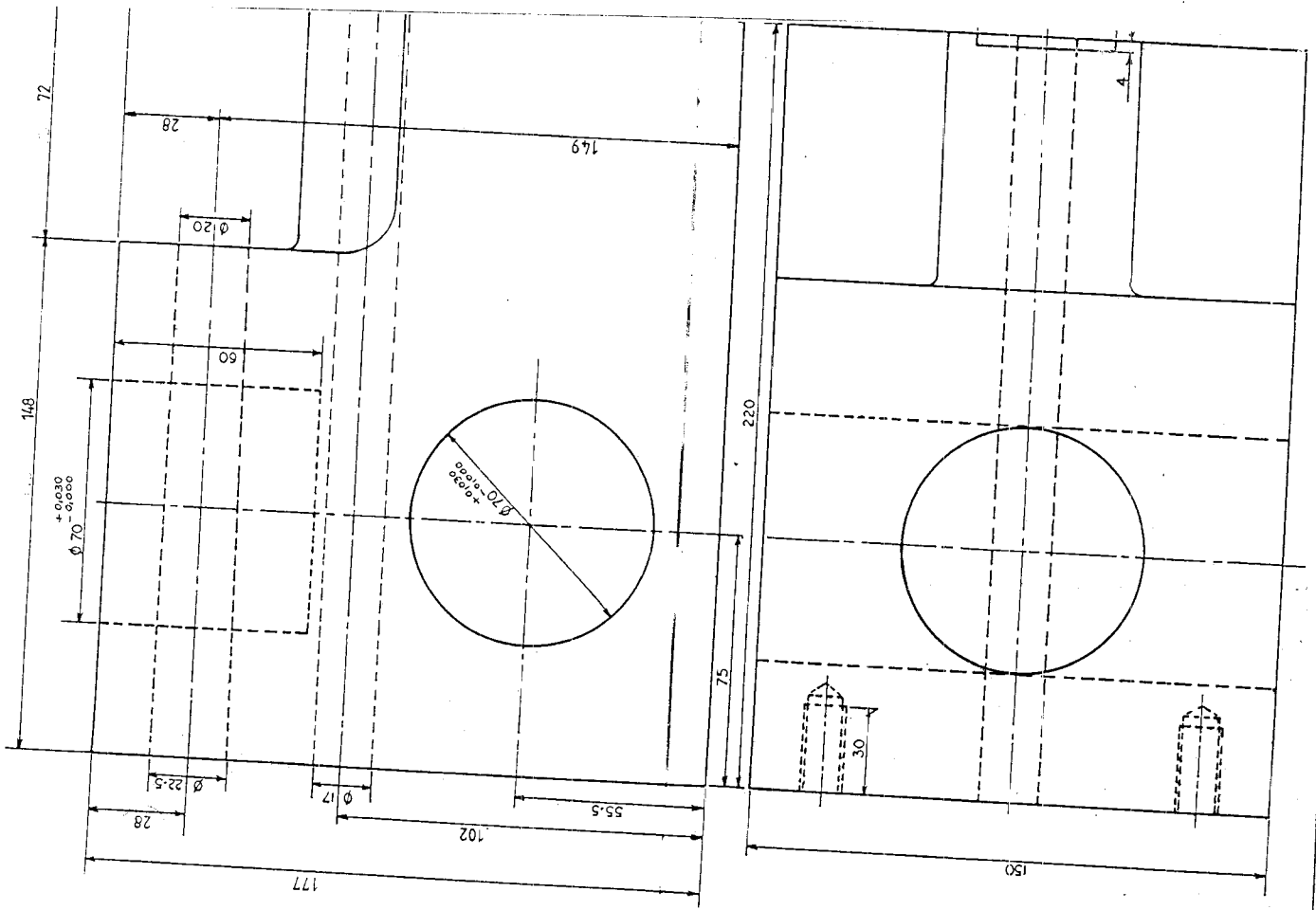

ITEM No.	BEARING HOUSING	C-17/S 210 GT. 25	QTY.	REMARKS
	DESCRIPTION	MATL./SPEC.		
BHARAT HEAVY PLATE & VESSELS LTD VISAKHAPATNAM				
PLANT MAINTENANCE		FRONT SIDE ROLL GUIDE BLOCK		
DGN.		FOR 25mm BENDING ROLL		
DRN.		M/C TYPE	INV. No.	
CHD.	8-25/94	SCALE	SIZE	DRAWING No.
APRD.			A ₂	M ₂ / 2880/G7-162

REF. DRG. No.

ROUGH MACHINING
DIE MACHINING

COMMERCIAL TERMS AND CONDITIONS FOR SUBMISSION OF OFFER**1.0 QUOTATIONS**

Bidders shall submit the offer in TWO INNER ENVELOPES as indicated below which shall be sealed in one outer envelope.

Envelope I: This sealed envelope should contain all the copies of technical bid together with un-priced commercial bid. This envelope should be clearly marked “**Part I – Technical and Un-priced commercial bid**” Indicating Tender No., Due Date and Address & Reference of the Bidder.

Envelope II: This sealed envelope should contain price details this envelope should be clearly marked “**Part II - Price bid**” indicating Tender No., Due Date and Address & Reference of the Bidder.

Both the envelopes (Part I & II) shall be put in one cover, duly sealed, super scribing as Part I and Part II of Tender No., due date of opening and the address and reference of the Bidder

The above offer should reach this office on or before the due date by 14.00 Hrs (IST)
Tender should not be addressed to any Individuals name but only designation to

Sr. Manager (MM)
BHARAT HEAVY ELECTRICALS LIMITED
HEAVY PLATES & VESSELS PLANT
VISAKHAPATNAM - 530 012 (A P), INDIA.

Tenders should be free from CORRECTION AND ERASURES. Corrections if any must be attested. All amounts shall be indicated both in words as well as in figures. Where there is difference between amount quoted in words and figures, amount quoted in words shall prevail.

Offers should be in ENGLISH and accompanied by technical literature catalogue and detailed dimensional drawings in ENGLISH or otherwise the offers will not be considered.

2.0 PART I (TECHNICAL & UN-PRICED COMMERCIAL BID)**2.1 Technical**

This part shall include / indicate the following:

- 2.1.1. Offer should contain complete scope of supply with all technical details, specifications, delivery and other commercial terms and conditions.
- 2.1.2. Point by point confirmation for the Technical Specification enclosed is to be provided. If there are any deviations the same should be clearly specified. Offers received without conformation to our specification will be rejected.
- 2.1.3. List of customers to whom same or similar equipment have been supplied along with performance certificates to be enclosed.
- 2.1.4. Relevant catalogue to be attached.
- 2.1.5. List of spares parts (with part numbers) for two years operation and maintenance should be attached.

2.1.6. Information on shipping weight and cubage (length, width & height) to be provided

2.1.7. In case of foreign bidder offer, the Principal's technical offer only should be enclosed.

2.2 Un-Priced Commercial

This part shall include / indicate the following

2.2.1. Port of shipment / Station of dispatch

2.2.2. Terms of payment

2.2.3. FOB/FCA price along with freight charges up to Chennai port (for foreign bidders) Ex-works/FOR Dispatch Station price along with freight charges up to BHEL Visakhapatnam (for Indian bidders)

2.2.4. Taxes, Service tax & duties including Cess applicable.

2.2.5 Delivery Schedule

2.2.6. Filled-in check list to be enclosed

2.2.7. Offer validity

2.2.8. Country of origin

2.2.9. Percentage of agency commission if any along with a copy of Agency agreement The FOB/FCA/CFR Prices quoted shall include the agency commission.

2.2.10. A copy of "Un-Priced Part II 'i.e., a copy of the Price Bid without the price details to be enclosed.

2.2.11 BHEL Visakhapatnam is eligible for availing CENVAT / VAT credit on both inputs and capital inputs. The suppliers invoice should separately indicate the amount of duty / taxes and should invariably mention the following details:

1. The Central excise registration number, range division and commission rate of the supplier's jurisdiction.
2. The rate of duty and 8 digit central excise tariff heading of the item supplied.
3. The TIN, VAT, CST registration number of the supplier.

The duplicate copy of the invoice is required for availing CENVAT credit and original copy for availing VAT credit, if purchased within the state.

In case of foreign bidders the duplicate copy of the electronic Bill of Entry along with TR6 challan should be made available for availing CENVAT credit on CVD, Cess (S) and SAD.

3.0 **PART II (PRICE – BID)**

This part should contain the schedule of price particulars and to be co-related to the technical details provided in Part-I

4.0 **OPENING OF TENDERS**

The Part I – Technical & un-priced commercial bid alone would be opened on the Tender opening date.

The Part II – Price bid of technically suitable Bidders alone would be opened. The Technically suitable Bidders would be informed about the Price Bid opening date. Clarifications if any required by BHEL Visakhapatnam FOR Technical evaluation / commercial evaluation would be sought from Bidders before opening of Part II – price bid.

GENERAL

5.1 Incomplete offers will not be considered.

5.2 **Fixed priced:** Prices quoted by the bidder shall be fixed and not subject to any escalation whatsoever during the period of bid validity and execution of the Purchase Order A bid submitted with an adjustable price will be treated as non- responsive and rejected Prices shall be written in words and figures. In the event of difference, the price in words shall be valid and binding. Unit prices shall be considered correct in the event of any discrepancy with regards to total price.

5.3 **Bid currency:** Indian bidders should submit the prices only in Indian Rupees. Foreign bidders may submit their bid in their home currency, which should be clearly indicated in the un-priced commercial bid as well as in the price bid. Price bid opening date/ RA date will be considered as effective date for considering exchange rate to evaluate the offers.

- 5.4 **Terms of Delivery:** Bidders are required to quote their best delivery period. Foreign Bidders should submit their offer for net FOB/ FCA – Nearest Sea Port / Air Port as well as CFR / Chennai Seaport/ Airport. Freight charges up to Chennai port to be indicated separately. Indian Bidders should submit their offer for Dispatching station as well as FOR BHEL Visakhapatnam basis. Freight charges from works to BHEL Visakhapatnam to be indicated separately. Delivery from the date of Letter of Intent to be mentioned in the offer.
- 5.5 **Taxes and Duties:** All Taxes and Duties payable as extra to the quoted price should be specifically stated in offers along with CST & TIN No/ Tariff No. etc, failing which the purchaser will not be liable for payment of such Taxes and Duties (Our TIN No.28280189432, APGST No. VSP/04/1/1023 dated 24.08.1968. CST No.VSP/04/1/1012 dated 24.08.1968 & BHEL Visakhapatnam ECC No AAA CB 7076 N-XM001. Assessment circle Visakhapatnam.)
- 5.6 **Validity:** The offers for main equipment and spares shall be kept open for acceptance for a period of 120 days (one hundred and twenty days) from the dates of opening of the tender (part I)
- 5.7 **Terms of Payment:**
- 5.7.1 **Indian Bidders:**
100% payment will be made within 45 days of receipt of material at BHEL,Visakhapatnam and on submission of Performance Bank Guarantee for 10%.
- 5.7.2 **Foreign Bidders**
An Irrevocable letter of Credit shall be established for 80% of FOB/FCA/CFR/ (excluding Indian Agent's commission) 2 months prior to shipment and valid for 3 months for negotiation against shipment Letter of Credit shall be opened through a branch of State Bank of India in the country where order shall be placed. In case, in the country where order is placed, State Bank of India is not there, Letter of Credit will be confirmed by foreign banker. Balance 20% of FOB/FCA/CFR value shall be paid through sight draft on Commissioning & acceptance of the equipment at BHEL Visakhapatnam, against submission of 10% performance bank guarantee. All Bank charges outside India are to supplier's account. Lump sum erection and commissioning charges if any, shall be payable after satisfactory erection & commissioning of the equipment by sight draft against certificate issued by the competent authority.
- 5.7.3 **Common to both India & Foreign Bidders.**
Erection & Commissioning (E&C) charges will be released after deduction of Income Taxes as per the Govt. of India rules. The TDS certificate will be issued by BHEL. Applicable service tax on E&C charges will be payable extra. The liability of depositing the same to the Govt. will be of the supplier.
- 5.7.4 **Loading criteria common to both Indian and foreign bidders:** Vendor should accept the payment terms specified above. However for any deviation to the payment terms offered with reference to the above criterion will be loaded with prime lending rate of SBI prevailing on date of opening of price bid + 2%, which shall be computed for the differential period between BHEL Visakhapatnam terms of payment and the offered basic price.
- 5.8 DUNS number (allotted by M/s. DUN & Bradstreet) shall be mentioned in your offer.
- 5.9 **Guarantee:** The equipment shall be guaranteed for a period of 18 months from the date of supply or 12 months from the date of commissioning and acceptance whichever is earlier.
Offers from vendors not accepting to the requested guarantee period will be rejected.

- 5.10 **Contract Execution Bank Guarantee (CEBG):** The successful tenderer shall furnish a Bank Guarantee from any Nationalized Bank for 5% of Purchase Order value (FOR Dispatching station value – Excluding taxes, duties, freight & insurance – for Indian bidders) & (FOB/FCA value – excluding freight & insurance – for foreign bidders) confirming that the order will be executed as per the terms and conditions and this should be valid till final dispatch date (LR/GR/BL/AWB) with additional 2 months claim period. Letter of Credit will be processed only after receipt of CEBG. The CEBG is to be furnished within 3 weeks from the date of Purchase order.
Offers from vendors not accepting to submit CEBG will be rejected.
- 5.11 **Performance Bank Guarantee (PBG):** The supplier shall furnish a Bank guarantee from any Indian Nationalized Bank approved by BHEL Visakhapatnam in the format, given by BHEL Visakhapatnam along with purchase order for 10% of the Purchase Order value (FOR Dispatching station value – Excluding taxes, duties, freight & insurance – for Indian bidders) & (FOB/FCA value – excluding freight & insurance – for foreign bidders) valid for period of guarantee with additional claim period of 2 months.
Offers from vendors not accepting to submit PBG will be rejected.
- The CEBG & PBG shall be obtained from any Indian Nationalized Bank/ Scheduled Commercial Banks.
- 5.12 **Liquidated damages:** Delivery of the goods specified in the purchase order should be made within the time prescribed. Failure to dispatch the materials in the time as per the delivery quoted in our Purchase Order would make the supplier liable to an un-conditional penalty at the rate of ½% of the value of goods for each week of delay subject to a maximum of 10% of the Purchase Order value.
- 5.12.1 **Loading Criteria for Liquidated Damages:** Any deviation from above LD Clause to the extent for which LD is not agreed by the vendor i.e., differential % value will be loaded on basic price, e.g. If some vendor agrees for say maximum of 6% LD then his price will be loaded by 4% (10 – 6) of his quoted basic price.
- 5.13 **Risk purchase:** If the supplier fails to deliver the goods within the delivery specified in the Purchase Order, BHEL Visakhapatnam will be entitled to terminate the contract and to purchase elsewhere at the risk and cost of the seller either the whole of the goods or any part which the supplier has failed to deliver or dispatch within the delivery period mentioned in the Purchase Order.
Offers from vendors not accepting the above Risk Purchase terms will be rejected.
- 5.14 **Indian Agent & Agency commission:** An Indian Agent can represent only one Foreign Manufacturer against a particular Tender. The FOB/FCA/CFR price quoted by the Foreign bidder shall include the agency commission. However, the agency commission component payable to their Indian Agents shall be shown separately in the offer. This will be paid by BHEL Visakhapatnam in India Rupees, on satisfactory commissioning & acceptance of the equipment. Copies of current Agency Agreement / Authorization Letter in respect of Agency Commission shall be furnished along with offer. For calculation of Rupee equivalent of Agency Commission exchange rate as prevailing on the date of Purchase Order will be taken.
- 5.15 **Short shipment / Warranty replacement:** In case of any short shipment in the main equipment / spares, customs duty levied on such supplies, shall be borne by the supplier. Any warranty replacement during the warrantee period shall be on FOR, BHEL Visakhapatnam, basis.

- 5.16 **Inspection & Testing:** All goods shall be subject to inspection by BHEL Visakhapatnam or its authorized representatives at supplier's works or at BHEL Visakhapatnam stores. The supplier will not charge for the facilities provided for inspection of goods. In case of machine tools the machine would be inspected and proved at supplier's works prior to dispatch however, final inspection and acceptance of the machine will be carried after installation of the machine at BHEL, Visakhapatnam.
- 5.17 **Operating and Maintenance manuals:** The Bidders shall clearly mention in their offer that Operating Maintenance Manuals as called for in the Technical Specification in the required number of copies will be provided.
- 5.18 **Cenvat & VAT credit. (for Indian Bidders only):** The quotation must indicate Tariff item number and rate of Excise Duty applicable. The original Excise Duty Gate Pass will be required to be furnished in case charges to us. If the bidder is availing Cenvat credit for his input materials, the effect of proforma credit should be passed on to the purchaser.
- 5.19 **Packing:** The Supplier shall arrange for packing suitably in all respects considering the peculiarity of the material involves for normal transport by sea / air / rail road and suitably protected against effect of tropical salt laden atmosphere in the event of shipment being delayed at ports.
- 5.20 **Salient Points of HSE** (Health, Safety & Environment) that are to be considered while submissions of offer are:
- 5.20.1 Consumption benchmarks related to output shall be provided wherever applicable for key input resources (energy/fuels/chemicals)
- 5.20.2 Competency requirements for operation, maintenance and calibration, if any, shall be communicated
- 5.20.3 If any Hazardous chemicals as per MSIHC (Manufacturing, Storage and import of Hazardous Chemicals) Rules 1989/94/2000 are used, the MSDS shall be provided, along with on site & OFF site emergency plan (as applicable).
- 5.20.4 The noise level at operator level shall be within 90 DbA
- 5.20.5 OH&S (Occupational Health and Safety) control measures for safe working of machine as applicable shall be specified
- 5.20.6 The machine/equipment shall be fitted with guard for rolling and moving parts and shall comply with applicable OH&S legislations and Factories Act 1948
- 5.20.7 The supplier shall submit the layout drawing of operating controls, displays etc and operating instructions to enable ergonomics evaluation and approval
- 5.20.8 The recommended PPE (Personal Protective Equipment) for the equipment shall be furnished
- 5.20.9 Alarm System (both visual and audible) and Automatic switch off of the equipment shall be provided for any intrusion, overloading, short circuiting or any malfunctioning of the equipment.
- 5.20.10 Details of all hazardous / harmful substances discharges as by-products / wastes during operations of the machine / equipment, such as fumes, gases, dust particles, aerosols UV./IR (Ultra violet / Infra red) radiations, etc shall be furnished, along with their concentrations and their TLV, (Threshold Limit Value)

- 5.20.11 Appropriate pollution control measures shall be proposed to keep the emissions from the machinery / processes within the prescribed limit as stated in Environment Protection Rules 1986.
- 5.20.12 All furnaces, process units, DG sets, paint booths, shot blasting chambers, etc shall be provided with stack(s) of sufficient height as per guidelines laid down in the Environment Protection Rules 1986.
- 5.20.13 wherever industry specific standards are not available for control of pollutants, general emission standards shall be used
- 5.20.14 Chemicals banned due to their negative impact on the environment shall not be used on the process
- 5.20.15 Fuels with sulphur content less than 0.05% shall be proposed.
- 5.20.16 Details regarding nature of waste generated and appropriate disposal practices available shall be provided, along with the operation procedure of the plant / process.
- 5.20.17 Hazardous chemicals and flammable substances shall be transported only through authorized transporters and all safety practices as laid down in applicable legislative requirements such as Central Motor Vehicle Rules, Manufacture, Storage and Import of Hazardous Chemical 1989, etc. shall be followed.
- 5.20.18 Primary materials used in the equipment shall be specified and they shall be eco - friendly.
- 5.21 Evaluation of offers shall be on the basis of delivered cost (Net cash outflow to BHEL Visakhapatnam).
- 5.22 BHEL Visakhapatnam also reserves its right to allow to the Public Sector Enterprises ordering and price preference facilities as admissible under the existing policy.
- 5.23 BHEL Visakhapatnam reserves its right to reject a tender due to unsatisfactory past performance in the execution of a contract at another project / unit.
- 5.24 BHEL Visakhapatnam shall be at liberty to reject or accept any tender, part or in full, at their own discretion and any such action is not liable for any question or claim against BHEL Visakhapatnam.
- 5.25 BHEL Visakhapatnam reserves the right to go for a Reverse Auction (RA) instead of opening the submitted sealed bid, which will be decided after technical evaluation. Information and general terms and conditions governing RA are given below.

GENERAL TERMS AND CONDITIONS OF RA (REVERSE AUCTION)

Against this enquiry for the subject item/system with detailed scope of supply as per enquiry specifications. BHEL Visakhapatnam may resort to “REVERSE AUCTION PROCEDURE” i.e., ON LINE BIDDING ON INTERNET.

1. For the proposed reverse auction, technically and commercially acceptable bidders only shall be eligible to participate.
2. BHEL Visakhapatnam will engage the services of a service provider who will provide all necessary training and assistance before commencement of on line bidding on internet.
3. BHEL Visakhapatnam will inform the vendor in writing in case of reverse auction, the details of service provider to enable them to contact & get trained.

4. Business rules like event date, time, start price, bid decrement, extensions etc. also will be communicated through service provider for compliance.
 5. Vendors have to fax the Compliance form in the prescribed format (provided by Service provider) before start of Reverse auction. Without this, the vendor will not be eligible to participate in the event.
 6. BHEL Visakhapatnam will provide the calculation sheet (e.g., EXCEL sheet) which will help to arrive at "Total Cost to BHEL Visakhapatnam like Packing & Forwarding charges, taxes and Duties, Freight charges, Insurance, Service Tax for Services and loading factors (for non-compliance to BHEL Visakhapatnam standard Commercial terms & conditions) for each of the vendor to enable them to fill-in the price and keep it ready for keying in during the Auction.
 7. Reverse auction will be conducted on scheduled date & time.
 8. At the end of Reverse Auction event, the lowest bidder value will be known on the network.
 9. The lowest bidder has to Fax the duly signed Filled-in prescribed format as provided on case-to-case basis to BHEL Visakhapatnam through Service provider within 24 hours of Auction without fail.
 10. Any variation between the on-line bid value and the signed document will be considered as sabotaging the tender process and will invite disqualification of vendor to conduct business with BHEL Visakhapatnam as per prevailing procedure.
 11. In case BHEL Visakhapatnam decides not to go for Reverse Auction procedure for this tender enquiry, the Price bids and price impacts, if any, already submitted and available with BHEL Visakhapatnam shall be opened as per BHEL Visakhapatnam's standard practice.
- 5.26 **Force Majeure clause:** If at the time during the continuance of this contract the performance in whole or in part by either party of any obligations under this contract shall be prevented or delayed by reason, of any war, hostilities, acts of the public enemy, civil commotion, sabotage, fires, explosions epidemics, quarantine, restrictions or acts of GOD (hereinafter referred to as events) then provided notice of happening of any such events is given by either party to other within twenty one days from the date of occurrence thereof neither party shall reason of such events be entitled to terminate this contract nor shall either party have any such non performance and delay is resumed as soon as practicable after such events has come to an end or ceased to exist, if the performance in whole or part of any obligation under this contract is prevented or delayed by reason or any such event claims for extension of time shall be granted for period considered reasonable by the purchaser subject to prompt notification by the seller to the purchaser of the particulars of the events and supply to the purchaser if required of any supporting evidence. Any waiver of time in respect of partial installment shall not be deemed to be a waiver of time in respect of remaining deliveries.

CHECK LIST

Bidder's acceptance to BHEL Visakhapatnam's Standard Commercial Terms & Conditions.

Applicable for Indian bidders

(To be submitted along with the offer – please do not change the format)

BHEL Visakhapatnam Tender No: & Date:	Bidders Confirmation / response
Prices have been quoted on "FIRM PRICE" basis only (Yes / No)	
Prices have been quoted on "F.O.R BHEL Visakhapatnam" basis only (Yes / No)	
P & F (Please confirm whether included or not)	
Freight (Please confirm whether included or not)	
Insurance (Please confirm whether included or not)	
Validity of offer (we require a minimum period of 120 days from the date of Tender Opening – please Specify)	
Sales Tax (please Specify)	
Excise Duty (please Specify)	
Delivery period from the date of Purchase Order (please Specify). A loading @ ½ % of the Purchase Order value per week will be done for the grace period requested. For evaluation 4 weeks will be considered as one month. Vendors quoting a delivery period beyond the 'the requested delivery plus the allowed grace period' is liable for rejection.	
Liquidated damages as per clause 5.12 (we require acceptance to @ ½% per week subject to a maximum of 10%) (Yes / No)	
Risk Purchase as per clause 5.13 (Yes / No) (Offers from vendors not accepting the Risk Purchase terms will be rejected)	
Payment terms (As per Clause No. 5.7.1) (Yes / No)	
Contract Execution Bank Guarantee (CEBG) as per Clause 5.10 (Yes / No) (Offers from vendors not accepting to submit CEBG will be rejected)	
Performance Bank Guarantee (PBG) as per Clause 5.11 (Yes / No) (Offers from vendors not accepting to submit PBG will be rejected)	
Guarantee as per clause 5.9 (The equipment shall be guaranteed for a period of 18 months from the date of supply or 12 months from the date of commissioning and acceptance whichever is earlier) (Yes / No) (Offers from vendors not accepting to the guarantee period will be rejected)	
Inspection (please Specify the Place of Inspection)	
Erection & Commissioning/ Installation/ Training (Please confirm whether charges are included in the total cost or not)	
Approximate Net Weight of the total Consignment	
Approximate Gross Weight of the total Consignment	

Signature & Office Seal of the bidder

CHECK LIST

Bidder's acceptance to BHEL Visakhapatnam 's Standard Commercial Terms & Conditions.

Applicable for foreign bidders (To be submitted along with the offer – please do not change the format)

BHEL Visakhapatnam Tender No: & Date:	Bidders Confirmation / response
Prices have been quoted on "FIRM PRICE" basis only (Yes / No)	
Prices basis (FOB/CFR/CIF – Please Specify)	
Insurance (Please confirm whether included or not)	
Validity of offer (we require a minimum period of 120 days from the date of Tender Opening – please Specify)	
Currency in which quoted (please Specify)	
Port of loading (please Specify)	
Country of Origin (please Specify)	
Delivery period from the date of Letter of Intent (please Specify) A loading @ ½ % of the Purchase Order value per week will be done for the grace period requested. For evaluation 4 weeks will be considered as one month. Vendors quoting a delivery period beyond the 'the requested delivery plus the allowed grace period' is liable for rejection.	
Liquidated damages as per clause 5.12 (we require acceptance to @ ½% per week subject to a maximum of 10%)	
Risk Purchase as per clause 5.13 (Offers from vendors not accepting the Risk Purchase terms will be rejected) (Yes / No)	
Payment terms (As per Clause No. 5.7.2)	
Agency commission (refer clause 5.14)	
Contract Execution Bank Guarantee (CEPG) as per Clause 5.10 (Yes / No) (Offers from vendors not accepting to submit CEBG will be rejected)	
Performance Bank Guarantee (PBG) as per Clause 5.11 (Yes / No) (Offers from vendors not accepting to submit PBG will be rejected)	
Guarantee as per clause 5.9 (The equipment shall be guaranteed for a period of 18 months from the date of supply or 12 months from the date of commissioning and acceptance whichever is earlier). (Offers from vendors not accepting to the requested guarantee period will be rejected) (Yes / No)	
Inspection (please Specify)	
Erection & Commissioning/ Installation/ Training (Please confirm whether charges are included in the total cost or not)	
Dimension of the Largest Part (please Specify)	
Packing Schedule (No of containers and their Sizes) (please Specify)	
Approximate Net Weight of the total Consignment (please Specify)	
Approximate Gross Weight of the total Consignment (please Specify)	

Signature & Office Seal of the bidder