



A Maharatna Company

ISO 9001 Company  
ISO 50001 Company

பாரத் ஹெவி இலெக்ட்ரிகல்ஸ் லிமிடெட்  
भारत हेवी इलेक्ट्रिकल्स लिमिटेड  
**Bharat Heavy Electricals Limited**

(A Government of India Enterprise)  
Tiruchirappalli – 620 014

**WORKS CONTRACTS MANAGEMENT**

Phone: 0431 – 257 1573, 4564; E-mail: prasath@bhel.in, dineshwar@bhel.in; www.bhel.com

**NOTICE INVITING e-TENDER**

Dear Sir/ Ma'am,

**Ref. : Tender Enq. No.: 9472600019/ 29-04-2026; GeM Bid No.: GEM/2026/B/7449412**

Subject : Open Tender Single Packet **e-Tender** inviting techno-commercial and price bids FOR **SERVICE CONTRACT FOR PART PROCESSING OF LOOSE TUBE BENDS AS PER BHEL DRAWING AT BHEL PREMISES FOR ONE YEAR.**

Kindly submit your competitive offer for the above subject work as per the tender terms and conditions given in the tender document through GeM portal (<https://gem.gov.in/>) only.

1.	Scope of work	Scope of work and technical terms and conditions as per Techno-Commercial Part-I bid.
2.	Location of work	BHEL Trichy Complex.
3.	Period of contract	Twelve (12) Months (one year) from the commencement of work as per WO.
4.	<b>Last date/ time for receipt of tender</b>	<b>15.00 Hrs on dtd. 09-05-2026</b>
5.	<b>Date/ time of opening of Techno-commercial bids</b>	<b>15.30 Hrs on dtd. 09-05-2026</b> <b>Change in opening date, if any, will be intimated later.</b>
6.	GeM Bid Method	GeM-Single Packet method
7.	CRITERIA FOR AWARD OF WORK	Package-wise L1 (lowest bidder) In case of a tie, the L1 bidder would be selected through GeM System selected L1 process (through Run L1 selection process in GeM portal). <b>Bid Evaluation: Single Packet Method in GeM Portal:</b> Technical & Price bids will be opened on the same day. Subsequently Technical bid of only L1 Bidder(s) will be evaluated as per GeM Process, if L1 bidder(s) is/are found technically qualified, order will be issued to L1 bidder as per GeM process. If L1 bidder(s) is/are technically not qualified then the process will be continued until selection of one technically qualified bidders from L2, L3...
8.	Splitting	<b>Not applicable</b> , Contract will be awarded to single source on package basis.
9.	EMD amount	<b>₹ 2,00,000/-</b> EMD Will be waived of for MSE bidders on submission of valid UDYAM certificate
10.	SD Amount	5% of the contract awarding value

Place:  
Date:

Signature of Authorized Signatory  
with seal & full address

**NAME OF WORK: SERVICE CONTRACT FOR PART PROCESSING OF LOOSE TUBE BENDS AS PER BHEL DRAWING AT BHEL PREMISES FOR ONE YEAR.**

**Tender Enq. No.: 9472600019/ 29-04-2026; GeM Bid No.: GEM/2026/B/7449412**

11	Pre bid meeting / Site visit	<p>A pre-bid conference will be arranged on <b>04-05-2026 at 11:00 Hrs. Meeting Location: Conference Hall, WCM Office, III<sup>rd</sup> floor 24 Building, BHEL Trichy, Tamilnadu-62014.</b></p> <p><b>The bidders are required to contact</b> Shri Sriram Prakash K / Manager/ OP &amp; C /Unit-2 , and Shri S Srinivasaraghavan / Sr. Manager/ OP &amp; C //Unit-2 to get information about the pre-bid meeting, and to arrange for gate pass, etc. email: <a href="mailto:sriramprakash@bhel.in">sriramprakash@bhel.in</a> ; Phone: 0431 257 4246</p>
12.	Working Area Contact details	<p>Shri Sriram Prakash K / Manager/ OP &amp; C /Unit-2 0431-257 4246, EMAIL: <a href="mailto:sriramprakash@bhel.in">sriramprakash@bhel.in</a>;</p> <p>Shri S Srinivasaraghavan / Sr. Manager/ OP &amp; C //Unit-2 0431-257 5448; EMAIL: <a href="mailto:srinivasaraghavan@bhel.in">srinivasaraghavan@bhel.in</a>;</p>
		<p><b>Vendors may visit the work area prior to submission of offer to understand the details of scope of work.</b></p>

## **Buyer Added Bid Specific Additional Terms & Conditions (ATC)**

### **1. PRE QUALIFICATION CRITERIA:**

#### **1.1 Pre-qualification Bid/ Earnest Money Deposit (EMD):**

EMD of **₹2,00,000.00/- (2 lakhs)** shall be furnished before tender opening / along with the offer in full as per the amount indicated in the NIT.

- EMD should be submitted as per Prequalification Bid/EMD (including EMD waiver, if any). Techno-commercial bid will be considered only if the Prequalification Bid/EMD is valid. EMD in any other form and tender without EMD will be summarily rejected.
- In case of offline payments, the hardcopies of Earnest Money Deposit (EMD) document/ DD submitted to WCM/BHEL and the soft-copies uploaded at the time of online bid submission should be the same, otherwise the tender will be summarily rejected.
- EMD is waived off for MSE (Micro and Small Enterprises only) vendor by submitting UDYAM certificate.**
- EMD is waived off for Start-up companies by submitting relevant certificates issued by Department of Industrial Policy and Promotion.

Details regarding EMD submission shall be referred from 1.7 of GCC.

#### **1.2 TECHNICAL:**

##### **1.2.1 STATUS OF THE COMPANY:**

**The following documents to be submitted as per the status of the company**

- Proprietorship: PAN card on owner name
- For partnership firms: PAN card and PARTNERSHIP DEED
- For others: PAN card in the name of company / firm / business and CERTIFICATE OF INCORPORATION / MOA and AOA.
- GST Registration certificate

\* As per point no. 1.5 of GCC.

Place:  
Date:

WCM Dept. / 3<sup>rd</sup> Floor, 24 Bldg. / BHEL, Trichy-14

Signature of Authorized Signatory  
with seal & full address

Page 2 of 44

**NAME OF WORK: SERVICE CONTRACT FOR PART PROCESSING OF LOOSE TUBE BENDS AS PER BHEL DRAWING AT BHEL PREMISES FOR ONE YEAR.**

**Tender Enq. No.: 9472600019/ 29-04-2026; GeM Bid No.: GEM/2026/B/7449412**

**1.2.2 PROOF OF EXPERIENCE:** The bidder should have operational **experience in execution of tube / pipe bending for boiler / pressure part components** within the last five years.

**Documentary evidence of this experience must be submitted with the offer:**

- Above experience other than BHEL to be supported by Purchase Order / Work Order / agreement copy along with Completion certificate from work executed agencies.
- Above experience from BHEL to be supported by PO/ Work Order copy

**1.2.3 COMPLIANCE TO SUPPLYING EXPERIENCED OPERATORS FOR BENDING:**

SI No	Description	Bidder's compliance (√ tick mark)
1	To be submitted in the letter head of the company/firm of bidder name for <b>supplying experienced operators for handling of rotary bending machines</b> in his firm name on the date of receipt of Order / LOI or before.	Agreed <input type="checkbox"/> Not agreed <input type="checkbox"/>

To be submitted in the letter head of the company/firm of bidder name

**1.2.4 Tender document (all pages) Duly Signed & seal by bidder's Authorized signatory.**

**1.2.5 All Annexures (Annexure - 1 to 11) duly filled, Signed & seal by bidder's Authorized signatory on bidder's letter.**

**1.2.6 Integrity Pact (Annexure-8)** duly signed and stamped with address and witness signed with name and address.

**1.2.7 POWER OF ATTORNEY (Annexure-15)** to be typed on non-judicial stamp paper of minimum Rs. 100/- and Notarized.

**1.2.8 Conflict of Interest among Bidders/ Agents (Annexure-19)** to be typed and submitted in the **Letterhead** of the Company/Firm of Bidder failing which the offer of Bidder is liable to be summarily rejected.

**1.3 FINANCIAL:** Bidders must have achieved an average annual financial turnover (Audited) of **₹ 25.88 Lakhs** /- or more, over the last Three Financial Years (FY) i.e., 2022-23, 2023-24, 2024-25. (i.e., Assessment year 2023-24, 2024-25, 2025-26). Financial Year to be considered as 1st April to 31st March.

Copy of Income Tax Submission Acknowledgment and copy of Audited Profit & Loss account and Balance Sheet indicating CA membership number including sign-seal of CA to be submitted along with offer.

**1.4** Bidder must not be under Insolvency Resolution Process or Liquidation or Bankruptcy Code Proceedings (IBC) as on date, by NCLT or any adjudicating authority/authorities, which will render him ineligible for participation in this tender, and shall submit undertaking (Annexure-4) to this effect.

**Explanatory Notes for the POC (Pre-Qualification Criteria):**

- Bidder to submit Audited Balance Sheet and Profit and Loss Account for the respective years as indicated against Financial Turnover **POC – 1.3** above along with all annexures.
- In case of audited Financial statements have not been submitted for all the three years as indicated against Financial Turnover as above, then the applicable audited statements submitted by the bidders against the requisite three years, will be averaged for three years i.e. total divided by three.
- If financial statements are not required to be audited statutorily, then instead of audited financial statements, financial statements are required to be certified by Chartered Accountant.
- Credentials furnished by the bidder against "**PRE-QUALIFYING CRITERIA**" shall be verified from the issuing authority for its authenticity. In case, any credential (s) is/are found to be spurious, offer of the bidder is liable to be rejected. BHEL reserves the right to initiate any further action as per extant guidelines for Suspension of Business Dealings.

Place:  
Date:

Signature of Authorized Signatory  
with seal & full address

**NAME OF WORK: SERVICE CONTRACT FOR PART PROCESSING OF LOOSE TUBE BENDS AS PER BHEL DRAWING AT BHEL PREMISES FOR ONE YEAR.**

**Tender Enq. No.: 9472600019/ 29-04-2026; GeM Bid No.: GEM/2026/B/7449412**

**Note:**

1. Bidders are requested to submit only the documents required to meet the pre-qualification criteria as per tender. Documents not relevant to tender pre-qualification criteria / tender shall not be enclosed along with the offer.
2. Digitally signed/ Self-attested copy of all the documents should be uploaded along with Tender.
3. At any stage, BHEL may ask for original documents and contractor has to submit the same. copy of all the documents should be uploaded along with Tender, if at any stage, the document(s) submitted by Contractor is / are found incorrect / false / fake, then necessary action will be taken by BHEL against Contractor viz., legal, Contractual, GeM Policy / Procedural Actions in whatsoever manner as deemed fit.
4. All the above conditions should be met by bidder firm only, not by any associate firm. Experience proof from BHEL shall contain work order copies. For experience other than BHEL, the bidding firms shall submit the work order copies and its completion certificates along with necessary documentary evidence to prove the desired experience.
5. The value of number of work orders allocated against same enquiry to a contractor will be considered as single work order value for qualifying purpose. Details of enquiry and the work orders linked to that enquiry shall be clearly indicated. There shall be sufficient document proof to ensure that the Work Orders submitted are against a single enquiry. BHEL reserves the right to accept the documents based on verification.
6. For consideration of running work order, the value completed on last day of month, previous to the one in which applications are invited will be considered based on certification of executing authority. Work completion certificate shall be submitted in this regard.
7. Participating bidders in this GeM Tender can view each other's Technical documents.

**2.1 SCOPE OF WORK, BILL OF QUANTITY AND TECHNICAL/SPECIAL TERMS & CONDITIONS**

**2.1.1 SCOPE OF WORK:**

1. The contractor is responsible for Bending, Inspection and Handing over of loose tubes as per the BHEL-issued drawings.
2. Bending of loose tubes must be carried out within BHEL's factory premises.
3. BHEL will provide bending machines, prepared tubes, paint, plastic end caps and power supply.
4. The mobilization period shall be 30 days from the date of the Notice to Proceed (NTP).
5. The contractor shall ensure proper handling, identification, and traceability of bend tubes
6. The vendor should be able to work three shift in operations as per the BHEL Requirement

**2.1.2 JOB DETAILS**

1. The prepared tubes along with all relevant drawings will be provided to the contractor.
2. If any defects are noticed in the supplied raw material, the same shall be informed to OP&C immediately.
3. Mark the tubes as per the drawings prior to bending.
4. Carry out the bending of tubes using the bending machine.
5. Check the tubes in the layout / fixture (for burner panel tubes) and carry out any corrections, if required.
6. The fixture required for inspection of burner panel tubes shall be provided by BHEL.
7. Obtain clearance from QC/Customer before proceeding.
8. Once cleared by QC / Customer, the job will be moved for Stress Relieving (SR) and Hydro Testing (if applicable) – BHEL scope.
9. After final job clearance by QC/Customer, carry out painting, stencilling, colour coding and end capping of the loose tubes before handing over.

**2.1.3 Scope of BHEL**

**BHEL shall provide the following:**

1. The tubes will be prepared at Boiler shops (Building 50 and Unit-2) and moved to the bending area for processing.
2. Movement of the job to the bending area is under BHEL scope.
3. Two Bending machine with bending former, power supply, paint, plastic end cap, SR and Hydro Testing will be under BHEL scope.
4. Crane services will be under BHEL scope (For loading, unloading and Inspection purpose only).
5. Power point will be given for chamfering and cutting machines.

**2.1.4 Scope of Contractor**

**The contractor shall provide and perform the following:**

1. The contractor shall deploy adequate skilled manpower for tube marking, bending, layout correction, final inspection, documentation, painting, colour coding, stencilling and end capping of tubes.
2. Contractor should bring all the required Tools and Equipment including chamfering machine, band saw, calibrated

Place:  
Date:

Signature of Authorized Signatory  
with seal & full address

**NAME OF WORK: SERVICE CONTRACT FOR PART PROCESSING OF LOOSE TUBE BENDS AS PER BHEL DRAWING AT BHEL PREMISES FOR ONE YEAR.**

**Tender Enq. No.: 9472600019/ 29-04-2026; GeM Bid No.: GEM/2026/B/7449412**

tape, level gauge, try square, Vernier calliper, straight edge, etc. for completion of the job as per scope of work.

3. The contractor shall maintain a history card for the jobs performed.
4. All PPE and safety equipment required for the contractor's employees shall be provided by the vendor

**2.1.5 General Conditions**

1. The contractor must have experienced manpower with prior experience in the operation of rotary bending machines.
2. The contractor shall ensure the following:
  - a) The contractor has to be capable of engaging experienced and qualified manpower for execution of work.
  - b) The contractor has to be capable of mobilizing skilled manpower during urgent requirements within short notice.
  - c) Manpower should have adequate knowledge in handling materials and operating machines.
  - d) The contractor shall deploy adequate manpower to meet BHEL requirement and agreeable to work in BHEL shifts.
  - e) Ensure that the workmen are not changed frequently.
3. Contractor shall depute adequate supervisors for all co-ordination works with BHEL and managing work force. Above Supervisors shall have adequate knowledge in Fabrication, Quality, NDE requirements.
4. The contractor has to engage manpower for the execution of work during Sundays and holidays as per the production requirement.
5. The contractor shall ensure discipline inside factory premises and maintain safety work culture of their workmen during execution of work.
6. Attendance register should be maintained by the contractor.
7. All Safety equipment & PPE are to be arranged for the workmen by the contractor. BHEL Safety rules and regulations have to be strictly followed.
8. The contractor shall follow and comply with minimum wages along with other additional wages, ESI, PF, Bonus, group insurance and other statutory regulations as stipulated in Factories act and other applicable State/ Central governments rules and regulations.
9. Any Defect or Damage and handling by the contractor / Rejection by BHEL QC during fabrication of the product as per BHEL drawings, if any, the contractor has to attend necessary repairs and supply the product as per the acceptable norms. Materials and consumables will be issued on chargeable basis against repairs/rework.
10. Any damage to BHEL property by the contractor inside factory premises during execution of work will be chargeable at the cost of contractor.
11. Contractor has to ensure judicious usage of consumables and resources provided by BHEL

**2.2 BILL OF QUANTITY**

Schedule No	Activity	UOM	QTY
1	<b>PART PROCESSING OF LOOSE TUBE BENDS AS PER BHEL DRAWING AT BHEL PREMISES FOR ONE YEAR.</b>	NO	507560

GRAND TOTAL i.e. Total lump sum value of the work, for all item based on this BOQ, given for the total contract duration of **12 months**, including all the taxes (inclusive of applicable Goods & Service Tax), should be given only online in **GeM portal only**. However, during bill submission, the bill rate and GST rate should be shown and provided separately

**The quantity mentioned in the BOQ/price bid may be subject to an increase or decrease of 10%.**

- **This tender and the resulting contract shall be governed by the Occupational Safety, Health and Working Conditions Code, 2020, and the rules notified thereunder on 21.11.2025. Compliance with Section 2(p) regarding Core/Non-Core activities is mandatory.**
- **The nature of work is intermittent and temporary in nature, and does not constitute a regular core activity of the establishment as defined under Section 2(p) of the OSH Code, 2020.**

**2.2.1 GENERAL INSTRUCTIONS:**

- i. Contractor shall ensure that services delivered by engaging its employees and supervisor who are aged 18 years to 60 years.

Place:  
Date:

Signature of Authorized Signatory  
with seal & full address

**NAME OF WORK: SERVICE CONTRACT FOR PART PROCESSING OF LOOSE TUBE BENDS AS PER BHEL DRAWING AT BHEL PREMISES FOR ONE YEAR.**

**Tender Enq. No.: 9472600019/ 29-04-2026; GeM Bid No.: GEM/2026/B/7449412**

- ii. The contractor has to disburse the salary/wages for their employees and supervisors only through Bank. If wages are paid through Banking channel, the relevant Bank statement/proof for Bank payment should also be produced along with PF and ESI challans to Welfare Section every month.
- iii. In the event of contractor's failure to deliver services as per the terms and conditions in the tender, BHEL shall be entitled to operate the contract by applying Risk Purchase clause by engaging any other contractor at the risk & cost of contractor.

Any deficiency in delivery of required quantity of services shall be considered as breach of contract and the contractor shall be liable liquidated damages apart from deductions from bills. Similarly, Contractor shall ensure that supervisor engaged by her/him are meeting the qualification requirements stipulated in the tender. Contractor shall ensure to replace such unqualified supervisor with duly qualified supervisor on its own or upon intimation by contract awarding executive

**2.2.2 SPECIAL CONDITIONS FOR SCOPE OF WORK:**

**1. Minimum wages**

- a. The quantities given above are approximate requirement for the given BOQ Qty months' period.
- b. Once in a month, bill should be prepared for the actual quantum of work done and to be submitted along with welfare clearance (for ESI, PF) to Work-in-charge and the same will be scrutinized, certified and forwarded to Finance for payment.
- c. The tendered rate shall be firm throughout the contract period. No cost escalation will be paid on any account.
- d. The contractor shall ensure payment of minimum wages, Bonus to the workmen employed by him at the rates at which shall not less than the minimum wage applicable under law time to time.

***The prevailing minimum wages per day for USW, SSW, SW & Supervisor is tabulated below, contractor should pay not lesser than the minimum prevailing wages to his contract employees., This below mentioned table is for contractor's reference only.***

<b>DETAILS OF MINIMUM WAGES PAYABLE PER DAY TO USW, SSW, SW &amp; SUPERVISOR AT BHEL, TRICHY W.E.F 01.04.2026</b>						
SL NO	DESCRIPTION OF WAGE COMPONENT	Applicable %	<b>Rates W.E.F 01.04.2026</b>			
			UNSKILLED WORKER (₹)	SEMI SKILLED WORKER (₹)	SKILLED WORKER (₹)	SUPERVISOR (₹)
A	<b>Minimum wage - per day</b>	NA				
	1. Basic		258.5	271	278.5	295
	2. Dearness Allowance from 01.04.2026		298.07	298.07	298.07	298.07
	<b>Basic + Variable Dearness Allowance</b>		<b>556.57</b>	<b>569.07</b>	<b>576.57</b>	<b>593.07</b>
B	<b>EMPLOYER CONTRIBUTION TOWARDS PF, ESI &amp; BONUS</b>					
	1. Employer contribution towards Provident Fund	13	72.35	73.98	74.95	77.1
	2. Employer contribution towards ESIC	3.25	18.09	18.49	18.74	19.27
	<b>Total</b>		<b>90.44</b>	<b>92.47</b>	<b>93.69</b>	<b>96.37</b>
	3. Bonus [8.33 % of (Basic +VDA) or (₹7000/26) whichever is higher]]	8.33	<b>46.36</b>	<b>47.4</b>	<b>48.03</b>	<b>49.4</b>
	<b>Total (A+B) (per day)</b>		<b>693.37</b>	<b>708.95</b>	<b>718.29</b>	<b>738.85</b>
	<b>Note:</b>					
	• Employee share of contribution towards PF (12 %) & ESI (0.75%) is not included					
	• If monthly salary is more than Rs. 21,000/-, provisions of Bonus Act and ESI Act will not be applicable.					

**2. The contractor shall pay his contract employees the prevailing minimum wages, including any amendments (in Basic, DA, ESI, PF Bonus, etc) made during the tenure of this contract.**

Place:  
Date:

Signature of Authorized Signatory  
with seal & full address

**NAME OF WORK: SERVICE CONTRACT FOR PART PROCESSING OF LOOSE TUBE BENDS AS PER BHEL DRAWING AT BHEL PREMISES FOR ONE YEAR.**

**Tender Enq. No.: 9472600019/ 29-04-2026; GeM Bid No.: GEM/2026/B/7449412**

**2.2.3 Payment Terms:**

1. Payment will be made after completion of work on pro-rata basis based on actual work executed as per BOQ after acceptance and certification of Area in charge (BHEL Executive). Payment shall be made as follows on submission of bill complete in all respect:
  - I. 90 days from issue of CRAC / SDA for Non-MSME.
  - II. 60 days from issue of CRAC / SDA for Medium (UDYAM Certificate to be submitted).
  - III. 45 days from issue of CRAC / SDA for MSE (for Micro and Small enterprises only- UDYAM Certificate to be submitted).

**If UDYAM Certificate not submitted substantiating the same, payment will be processed in Non-MSME basis.**

2. Bills for every month shall be prepared by the Contractor on the basis of actual services provided with at least minimum numbers of manpower as specified by BHEL and submitted to Engineer incharge for verification. Payments will be effected on actual basis after certification by the Engineer incharge. All the bills of contractors will be cleared by Finance Department subject to production of "Clearance Certificate" by the contractors in respect of compliance of all statutory requirement, issued by the Contract Cell.
  - i) The facility for online invoice registration and document upload has been enabled in the SUVIDHA Portal for all BHEL Suppliers and Contractors. It is mandatory for all Suppliers/Contractors to register their invoices exclusively through the SUVIDHA Portal (<https://suvidha.bhel.in/suvidha/>) along with the required documents.
  - ii) Goods and Services tax will be payable extra by BHEL at prevailing rates and corresponding TDS will be made as per Government norms.
  - iii) Contract for full work will be awarded to only one bidder. L1 will be decided on the total value of contract (Package basis).
  - iv) If the Contractor is not registered for any statutory obligation and not liable thereto, then a declaration shall be submitted along with offer that they are within the threshold limit.
  - v) BHEL will finalize the rates through Price bid in GeM portal without Reverse Auction.
  - vi) **BHEL reserves the right to extend the contract by up to a period of THREE (3) months beyond the original contract period, at the sole discretion of BHEL, upon written notice provided to contractor prior to the expiration of the contract. Such extension shall be on the same rate, terms and conditions as set forth in this contract.**

**2.2.4 LIQUIDATED DAMAGES (LD) / PENALTY**

1. If the tenderer fails to provide services within the initial mobilization period seven (7) days fixed in the tender and indicated in the LOI / work order, or at any time repudiates the contract, then BHEL- without prejudice to any other right or remedy available to it under the contract, may at its discretion shall have right to recover from the contractor, liquidated damages and not by way of penalty an amount of ₹1000/- per day will be recovered from the contractors running bill. In such a case, BHEL may also terminate the contract and forfeit Performance Security if delay extends beyond 15 days.
2. BHEL will provide the vendor with 7 Days' advance notice for each product to mobilize manpower and resources, the vendor is required to complete minimum 1 boiler requirement within 23 working days from the material matching. Failing which Penalty @ 0.5 % of the respective schedule value per day of delay in execution of work as per scope of work or part thereof subject to maximum of 10 % of total order value.
3. In case the Contractor fails to make wage payments to employees or remit contributions to the concerned authorities beyond 30 days from the last day of the wage period, BHEL reserves the right to utilize the security deposit or other dues under the contractor any other contract, may be utilized by BHEL to discharge the Contractor's liability.
4. If the contractor fails to fulfil any of the contractual obligations including legal requirements for workers or providing them with proper safety PPE, seven days' notice will be issued to rectify the defect. Failing which BHEL shall have the right to levy penalty equivalent to 0.05% of the contract value for every defaulting week subject to a maximum of 10% and without prejudice to any other relief or compensation to which the company is entitled under the other conditions of the contract.
5. The penalty/ LD will be subject to a maximum of 10% of the total order value. In case of any change to the order value, the penalty/ LD shall be applicable on revised order value subject to a maximum of 10% of the revised order value.

**2.2.5 SPLITTING OF CONTRACT:**

No splitting for this Contract. The entire Contract will be awarded to single source (Package basis) L1 vendor only.

Place:  
Date:

WCM Dept. / 3<sup>rd</sup> Floor, 24 Bldg. / BHEL, Trichy-14

Signature of Authorized Signatory  
with seal & full address

Page 7 of 44

**NAME OF WORK: SERVICE CONTRACT FOR PART PROCESSING OF LOOSE TUBE BENDS AS PER BHEL DRAWING AT BHEL PREMISES FOR ONE YEAR.**

**Tender Enq. No.: 9472600019/ 29-04-2026; GeM Bid No.: GEM/2026/B/7449412**

**2.2.6 MSE BENEFITS: Applicable as per GeM GTC.**

MSE bidders if not opted for MSE Purchase preference in GeM Portal will be consider as NON-MSE bidder only. It is the responsibility of the bidder to ensure MSE purchase preference while submitting their bid.

**2.2.7 REVERSE AUCTION : NO.**

**2.2.8 BONUS CLAUSE : Not Applicable.**

**2.2.9 PRICE VARIATION CLAUSE (PVC) : Not Applicable (The rate quoted is firm throughout the currency of the contract)**

**2.2.10. OVER RUN COMPENSATION (ORC) : Not Applicable.**

**2.2.11 Period of Contract : The successful bidder/s will be awarded contract for period of 12 months. BHEL may extend at its discretion the period of contract for a further period on the same terms and conditions mutually agreed upon.**

**2.2.12 Part – II - Price Bid: Price to be quoted in GeM portal only.**

**2.2.13 Important Instruction to Bidder: (Price Bid):**

Quoted value should be inclusive of GST i.e., Quoted Value = Rate + GST amount (Please quote the value with GST amount).

**3. TECHNICAL TERMS & CONDITIONS:**

**3.1 Tender Price:**

- a. Unless explicitly stated in the tender document, the contractor shall be responsible for the whole works, based on the schedule of works, bill of quantities and payment shall be made as per accepted rates based on the activities carried out as in the scope of work.
- b. While quoting the “**Lump sum amount**”, bidders should consider all cost elements like financing cost, cost of maintenance of accounts, insurance-premium overheads, profit margins, conveyance charges, amount of security deposit, statutory requirements / obligations, contractual obligations and any other expenditure as deemed relevant by the bidder or cost of any other item under its scope and to meet any expenses / exigencies (including bearing of penalty by bidder as per tender document) so as to ensure continuity of services. While quoting the price, the bidder must keep in view the prevailing applicable minimum wages of the Government of Tamilnadu. It is the responsibility of the bidder to educate himself about all obligations to be performed under the contract, the financing cost, administrative expenses, statutory liabilities, etc and then submit the price accordingly.

**3.2 Applicable Contractual Variations**

Not applicable, the quoted rate is firm throughout the currency of contract including extension period.

**3.3 Work Conditions and Liabilities**

- i. Duration of work in a shift will be 8 Hrs. (excluding 30 Minutes for lunch/dinner break) as per BHEL requirement.
- ii. The shift timing may be as per BHEL requirement.
- iii. The log-book for day-to-day work executed should be maintained by the contractor and the signature should be obtained from the area in-charge/authorized executive of BHEL daily. The user agency will certify as per the contract condition to enable bill section to forward the bill for payment to accounts department after verification. Taxes, duties, penalty if any will be recovered from the bills at sources and as well as ESI, PF, Bonus if the same are not paid.
- iv. In case BHEL be held liable for any loss, damage or compensation to third parties arising from or in relation to transport operations done by the transport contractor, such loss, damage or compensation shall be paid by the contractor to BHEL together with the costs incurred by BHEL on any legal proceedings pertaining thereto.
- v. The contractor is directly responsible for injuries/ death of any person employed by him as well as to the third party occupants or other users arising due to accident or otherwise during the contractual period. At any point of time, BHEL will not be responsible for any loss / damage either to the person or to the property arising out of accident for performing the contractual obligations.

Any damage to BHEL materials due to rough and faulty handling by the contractor's men will have to be made good by the contractor to BHEL. Similarly, if any damage caused to BHEL equipment/ installation, property of third party in the course of work by the contractor's men, the same shall be made good by the contractor.

**3.4 BENEFITS TO STARTUPS:** Start-up companies will be exempted as per government norms. In terms of work Experience & Turnover, such vendors need to meet at least 50% of financial turnover & at least 50% of similar experience on eligibility criteria in the tender.

Place:  
Date:

Signature of Authorized Signatory  
with seal & full address

**NAME OF WORK: SERVICE CONTRACT FOR PART PROCESSING OF LOOSE TUBE BENDS AS PER BHEL DRAWING AT BHEL PREMISES FOR ONE YEAR.**

**Tender Enq. No.: 9472600019/ 29-04-2026; GeM Bid No.: GEM/2026/B/7449412**

For availing start-up benefits, relevant certificates issued by Department for Promotion of Industry and Internal Trade shall be submitted along with the Tender.

**3.5 PROVISION FOR MICRO & SMALL ENTERPRISES (MSE) SUPPLIERS AND START-UPS**

MSE suppliers can avail the intended benefits only if they submit **UDYAM Registration Certificate** along with the offer.

If MSEs quoted price is within price band L-1 + 15%, when L1 is non- MSE, the MSEs will be allowed to supply at least 25% of tendered quantity at L-1 rate subject to acceptance by MSEs to L-1 rate. (Minimum of 3% reservation for women owned MSEs and 6.25% for MSEs owned by SC/ST within the above mentioned 25% reservation). In case the contract cannot be split, the full/ complete supply of total tendered value shall be awarded to MSE. The preference to

the MSEs will be given in order of their ranking L1, L2, L3, etc.

**4 TAXES & DUTIES:**

**4.1** The contractor shall pay all (save the specific exclusions as enumerated in this clause) taxes, fees, license, charges, deposits, duties, tools, royalty, commissions, other charges, etc. which may be levied on the input goods & services consumed and output goods & services delivered in course of his operations in executing the contract. In case BHEL is forced to pay any of such taxes/duties, BHEL shall have the right to recover the same from his bills or otherwise as deemed fit.

However, provisions regarding **GST** on output supply (goods/service) and TDS/TCS as per Income Tax Act shall be as per following clauses.

**4.2 GST (Goods and Services Tax)**

**4.2.1** GST as applicable on output supply (goods/services) are excluded from contractor's scope; therefore, contractor's price/rates shall be **exclusive** of GST. Reimbursement of GST is subject to compliance of following terms and conditions. BHEL shall have the right to deny payment of GST and to recover any loss to BHEL on account of tax, interest, penalty etc. for non-compliance of any of the following condition.

**4.2.2** The admissibility of GST, taxes and duties referred in this chapter or elsewhere in the contract shall be limited to direct transactions between BHEL & its Contractor. BHEL shall not consider GST on any transaction other than the direct transaction between BHEL & its Contractor.

**4.2.3** Contractor shall obtain prior written consent of BHEL before billing the amount towards such taxes. Where the GST laws permit more than one option or methodology for discharging the liability of tax/levy/duty, BHEL shall have the right to adopt the appropriate one considering the amount of tax liability on BHEL/Client as well as procedural simplicity with regard to assessment of the liability. The option chosen by BHEL shall be binding on the Contractor for discharging the obligation of BHEL in respect of the tax liability to the Contractor.

**4.2.4** Contractor has to submit GST registration certificate of the concerned state. Contractor also needs to ensure that the submitted GST registration certificate should be in active status during the entire contract period.

**4.2.5** Contractor/Vendor has to issue Invoice/Debit Note/Credit Note indicating HSN/SAC code, Description, Value, Rate, applicable tax and other particulars in compliance with the provisions of relevant GST Act and Rules made thereunder.

**4.2.6** Vendor has to submit GST compliant invoice within the due date of invoice as per GST Law. In case of delay, BHEL reserves the right of denial of GST payment if there occurs any hardship to BHEL in claiming the input thereof. In case of goods, vendor has to provide scan copy of invoice & GR/LR/RR to BHEL before movement of goods starts to enable BHEL to meet its GST related compliances. Special care should be taken in case of month end transactions.

**4.2.7** Vendor has to ensure that invoice in respect of such services which have been provided/completed on or before end of the month should not bear the date later than last working day of the month in which services are performed.

**4.2.8** Subject to other provisions of the contract, GST amount claimed in the invoice shall be released on fulfilment of all the following conditions by the Contractor: -

- a) Supply of goods and/or services have been received by BHEL.
- b) Original Tax Invoice has been submitted to BHEL.
- c) Contractor/ Vendor has submitted all the documents required for processing of bill as per contract/ purchase order/ work order.
- d) In cases where e-invoicing provision is applicable, vendor/contractor is required to submit invoice in compliance

Place:

Date:

Signature of Authorized Signatory  
with seal & full address

**NAME OF WORK: SERVICE CONTRACT FOR PART PROCESSING OF LOOSE TUBE BENDS AS PER BHEL DRAWING AT BHEL PREMISES FOR ONE YEAR.**

**Tender Enq. No.: 9472600019/ 29-04-2026; GeM Bid No.: GEM/2026/B/7449412**

with e-invoicing provisions of GST Act and Rules made thereunder.

e) Contractor has filed all the relevant GST return (e.g. GSTR-1, GSTR-3B, etc.) pertaining to the invoice submitted and submit the proof of such return along with immediate subsequent invoice. In case of final invoice/ bill, contractor has to submit proof of such return within fifteen days from the due date of relevant return.

f) Respective invoice has appeared in BHEL's GSTR - 2A for the month corresponding to the month of invoice and in GSTR-2B of the month in which such invoices has been reported by the contractor along with status of ITC availability as "YES" in GSTR-2B. Alternatively, BG of appropriate value may be furnished which shall be valid at least one month beyond the due date of confirmation of relevant payment of GST on GSTN portal or sufficient security is available to adjust the financial impact in case of any default by the contractor.

g) Contractor has to submit an undertaking confirming the payment of all due GST in respect of invoices pertaining to BHEL.

**4.2.9** Any financial loss arises to BHEL on account of failure or delay in submission of any document as per contract/purchase order/work order at the time of submission of Tax invoice to BHEL, shall be deducted from contractor's bill or otherwise as deemed fit.

**4.2.10** TDS as applicable under GST law shall be deducted from contractor's bill.

**4.2.11** Contractor shall comply with the provisions of e-way bill wherever applicable. Further wherever provisions of GST Act permits, all the e-way bills, road permits etc. required for transportation of goods needs to be arranged by the contractor.

**4.2.12** Contractor shall be solely responsible for discharging his GST liability according to the provisions of GST Law and BHEL will not entertain any claim of GST/interest/penalty or any other liability on account of failure of contractor in complying the provisions of GST Law or discharging the GST liability in a manner laid down thereunder.

**4.2.13** In case declaration of any invoice is delayed by the vendor in his GST return or any invoice is subsequently amended/alterd/deleted on GSTN portal which results in any adverse financial implication on BHEL, the financial impact thereof including interest/penalty shall be recovered from the Contractor's due payment.

**4.2.14** Any denial of input credit to BHEL or arising of any tax liability on BHEL due to non-compliance of GST Law by the Contractor in any manner, will be recovered along with liability on account of interest and penalty (if any) from the payments due to the Contractor.

**4.2.15** In the event of any ambiguity in GST law with respect to availability of input credit of GST charged on the invoice raised by the contractor or with respect to any other matter having impact on BHEL, BHEL's decision shall be final and binding on the contractor.

**4.2.16 Variation in Taxes & Duties:**

Any upward variation in GST shall be considered for reimbursement provided supply of goods and services are made within schedule date stipulated in the contract or approved extended schedule for the reason solely attributable to BHEL. However downward variation shall be subject to adjustment as per actual GST applicability.

In case the Government imposes any new levy/tax on the output service/goods after price bid opening, the same shall be reimbursed by BHEL at actual. The reimbursement under this clause is restricted to the direct transaction between BHEL and its contractor only and within the contractual delivery period only.

In case any new tax/levy/duty etc. becomes applicable after the date of Bidder's offer but before opening of the price Bid, the Bidder/Contractor must convey its impact on his price duly substantiated by documentary evidence in support of the same before opening of price bid. Claim for any such impact after opening the price bid will not be considered by BHEL for reimbursement of tax or reassessment of offer.

**4.3 Income Tax:**

**TDS/TCS** as applicable under Income Tax Act, 1961 or rules made thereunder shall be deducted/collected from contractor's bill.

**5.1 SUBMISSION OF BILLS BY CONTRACTOR:**

Bills should be submitted within a week after execution of work during the calendar month/ quarter. The Contractor shall submit a bill in triplicate detailing the various items of work done during the month/ quarter supported by the

Place:  
Date:

Signature of Authorized Signatory  
with seal & full address

**NAME OF WORK: SERVICE CONTRACT FOR PART PROCESSING OF LOOSE TUBE BENDS AS PER BHEL DRAWING AT BHEL PREMISES FOR ONE YEAR.**

**Tender Enq. No.: 9472600019/ 29-04-2026; GeM Bid No.: GEM/2026/B/7449412**

requisitions issued from time to time. The Contractor shall, once in every quarter, submit to the end user / executing agency, separately details of his claims for the work done by him up to and including the previous month which are not covered by his contract agreement in any of the following respects:

- i. Deviation from the items provided in the contract documents.
- ii. Extra items / new items of work.
- iii. Items in-respect of which rates have not been settled. He should in addition furnish a clear certificate to the effect that the claims submitted by him as aforesaid cover all his claims and that no further claims shall be raised by him in respect of the work done up to and including the period under report.
- iv. Along with bills, Contractors has to furnish self-attested copy of the following documents for further processing of bills:
- v. Copy of PAN card.
- vi. Documentary proof for payment of PF/ESI (for the last month) with respect to the employees engaged by the contractor with payment details relating to individual names to be submitted.
- vii. Copy of payment challan of previous Month / Quarter as proof of deposit of GST along with a certificate from the Contractor that tax collected from BHEL has been remitted to tax authorities.
- viii. If the Contractor is not registered for any statutory obligation and not liable there to, then a declaration shall be submitted along with offer that they are within the threshold limit.

Any other relevant document which is required from time to time as per BHEL requirement.

**5.2 CONTRACT BILL PROCESSING IN SUVIDHA PORTAL:**

BHEL has launched **SUVIDHA – Unified Supplier Portal** to streamline the processing of supply / Service payments to all vendors. The details are as follows:

**1. Mandatory Registration of Invoices**

❖ All supply / Service invoices, regardless of the invoice amount, must be registered in the BHEL SUVIDHA portal.

**2. For Net Invoice Amount Exceeding ₹5 Lakhs (Including Taxes):**

❖ Upload of a **Class 3 Digitally Signed Tax Invoice (Class 3 Digital Signature Certificate issued by a licensed Certifying Authority)** is mandatory.

❖ All other documents as per the Purchase Order (PO) checklist must also be uploaded.

❖ If any other digitally signed document is specified in the PO checklist, it must be uploaded with a Class 3 Digital Signature.

**3. For Net Invoice Amount Up to ₹5 Lakhs (Including Taxes):**

❖ Upload of all documents as per the PO checklist is mandatory.

❖ Documents can be uploaded without a digital signature.

❖ However, if a digitally signed document is specified in the PO checklist and a non-digitally signed version is uploaded, a hard copy must be submitted.

This system will be enabled from **01.10.2025** onwards. BHEL request all suppliers to comply with the above requirement and upload invoices through the SUVIDHA portal to ensure seamless payment processing.

✦ **Note:** Materials / services will not be accepted at BHEL premises in the absence of the above compliance. A detailed step-by-step procedure for uploading invoices and documents is linked for your reference.

**Portal Link:** <https://suvidha.bhel.in/suvidha/index1.jsp>.

**6. BANK DETAILS FOR EMD & SERCUITY DEPOSIT SUBMISSION:**

For Electronic Fund Transfer the details are as below:

a) Name of the Beneficiary: BHEL, Trichy

b) Bank Particulars (Details of Respectively executing region):

Name of the Company – BHEL, Trichy

Name of the bank - STATE BANK OF INDIA

Bank branch - HEAVY ELECTRICALS, KAILASAPURAM

City –Tiruchirappalli Branch code- 01363

Account Number – 10891588977

Account type – CC

IFSC code - SBIN0001363

MICR code – 620002004

Place:

Date:

Signature of Authorized Signatory  
with seal & full address

**NAME OF WORK: SERVICE CONTRACT FOR PART PROCESSING OF LOOSE TUBE BENDS AS PER BHEL DRAWING AT BHEL PREMISES FOR ONE YEAR.**

**Tender Enq. No.: 9472600019/ 29-04-2026; GeM Bid No.: GEM/2026/B/7449412**

**7. MICRO AND SMALL ENTERPRISES (MSE):**

Any Bidder falling under MSE category shall furnish the following details & submit documentary evidence/ Govt. Certificate etc. in support of the same along with their techno- commercial offer.

Type under MSE	SC/ST owned	Women owned	Others (excluding SC/ ST & Women Owned)
Micro			
Small			

**Note:** If the bidder does not furnish the above, offer shall be processed construing that the bidder is not falling under MSE category.

a) MSE suppliers can avail the intended benefits in respect of the procurements related to the Goods and Services only (Definition of Goods and Services as enumerated by Govt. of India vide Office Memorandum F. No. 21(8)/2011-MA dtd. 09/11/2016 office of AS & DC, MSME) only if they submit along with the offer copy of Udyam Registration. Date to be reckoned for determining the deemed validity will be the last date of Technical Bid submission. Non-submission of supporting document in GeM portal will lead to consideration of their bids at par with other bidders. No benefits shall be applicable for this enquiry if the above required documents are not uploaded at the time of bid submission. Documents submitted by the bidder shall be verified by BHEL for rendering the applicable benefits.

**MSE bidders if not opted for MSE Purchase preference in GeM Portal will be consider as NON MSE bidder only. It is the responsibility of the bidder to ensure MSE purchase preference while submitting their bid.**

**8. PREFERENCE TO MAKE IN INDIA:**

For this procurement, the local content to categorize a supplier as a Class I local supplier/ Class II local Supplier/Non-Local Supplier and purchase preferences to Class I local supplier, is as defined in Public Procurement (Preference to Make in India), Order 2017 dated 04.06.2020 issued by DPIIT. In case of subsequent orders issued by the nodal ministry, changing the definition of local content for the items of the GeM Bid, the same shall be applicable even if issued after issue of this GeM Bid, but before opening of Part-II bids against this GeM Bid.

**9. GRIEVANCE REDRESSAL MECHANISM**

To promote transparency and ensure fair treatment of all bidders, a structured Grievance Redressal Mechanism is in place to address any concerns or issues arising during the tendering process or in subsequent business dealings with the company.

Suppliers/Contractors are requested to follow the below escalation process for grievance resolution:

- i. **First Level:** Any grievance should initially be addressed to the designated Dealing Officer, whose contact details are provided in the Notice Inviting Tender (NIT)/Contract.
- ii. **Second Level:** If the issue remains unresolved, it may be escalated by lodging a formal grievance through the SUVIDHA Portal: <https://suvidha.bhel.in/suvidha/>. Responses will be provided in accordance with the defined escalation matrix."

**10. Order of Precedence:**

In the event of any ambiguity or conflict between the Tender Documents, the order of precedence shall be in the order below:

- a. Amendments/Clarifications/Corrigenda/Errata etc. issued in respect of the tender documents by BHEL.
- b. GeM Bid
- c. Technical Conditions of Contract (TCC)
- d. Buyer Added Bid Specific ATC
- e. GeM GTC

Place:  
Date:

Signature of Authorized Signatory  
with seal & full address

**NAME OF WORK: SERVICE CONTRACT FOR PART PROCESSING OF LOOSE TUBE BENDS AS PER BHEL DRAWING AT BHEL PREMISES FOR ONE YEAR.**

**Tender Enq. No.: 9472600019/ 29-04-2026; GeM Bid No.: GEM/2026/B/7449412**

**11. INTEGRITY PACT (IP):**

(a) IP is a tool to ensure that activities and transactions between the Company and its Bidders/ Contractors are handled in a fair, transparent and corruption free manner. Following Independent External Monitors (IEMs) on the present panel have been appointed by BHEL with the approval of CVC to oversee implementation of IP in BHEL

SI	IEM	Email
1.	Dr. Sarat Kumar Acharya, Ex-CMD, NLC	iem1@bhel.in
2.	Shri R. Mukundan, IRPS (Retd.)	iem2@bhel.in
3.	Shri Madan Lal Meena, IAS (Retd.)	iem3@bhel.in

(b) The IP as enclosed with the tender is to be submitted (duly signed by authorized signatory) along with techno-commercial bid (Part-I, in case of two/ three-part bid) Only those bidders who have entered into such an IP with BHEL would be competent to participate in the bidding. In other words, entering into this pact would be a preliminary qualification.

(c) Please refer Section-8 of IP for Role and Responsibilities of IEMs In case of any complaint arising out of the tendering process, the matter may be referred to the panel of IEMs. All correspondence with the IEMs shall be done through email only).

**Note:**

No routine correspondence shall be addressed to the IEM (phone/post/ email) regarding the clarifications, time extensions or any other administrative queries, etc on the tender issued (p. 12). All such clarification/ issues shall be addressed directly to the tender issuing (procurement) department's officials whose contact details are provided below:

Details of contact person(s):

(1) Name: K Karthikeyan Designation: AGM Dept.: Works Contracts Management Address: Bldg. 24, 3rd Floor, HPBP, BHEL Trichy-14  Phone: 0431-2574638 Email: karthi@bhel.in	(2) Name: K Prasath Designation: Sr. Engineer Dept.: Works Contracts Management Address: Bldg. 24, 3rd Floor, HPBP, BHEL Trichy-14  Phone: 0431-2571573 Email: prasath@bhel.in
--	--

**12. Enclosure:**

- Annexure-1: Check List.
- Annexure-2: Offer forwarding letter/ tender submission letter.
- Annexure-3: No Deviation Certificate.
- Annexure-4: Declaration regarding Insolvency/ Liquidation/ Bankruptcy Proceedings.
- Annexure-5: Declaration by Authorized Signatory.
- Annexure-6: Declaration by Authorized Signatory regarding Authenticity of submitted Documents.
- Annexure-8: Integrity Pact.
- Annexure-10: Declaration reg. Related Firms & their areas of Activities.
- Annexure-11: Declaration for relation in BHEL.
- Annexure-15: Power of Attorney for submission of tender.
- Annexure-16: Proforma of Bank Guarantee for Earnest Money.
- Annexure-17: Proforma of Bank Guarantee for Security Deposit.
- Annexure-18: List of Consortium Bank.
- Annexure-19: Declaration regarding conflict of interest.

Place:  
Date:

WCM Dept. / 3<sup>rd</sup> Floor, 24 Bldg. / BHEL, Trichy-14

Signature of Authorized Signatory  
with seal & full address

Page 13 of 44

**NAME OF WORK: SERVICE CONTRACT FOR PART PROCESSING OF LOOSE TUBE BENDS AS PER BHEL DRAWING AT BHEL PREMISES FOR ONE YEAR.**

**Tender Enq. No.: 9472600019/ 29-04-2026; GeM Bid No.: GEM/2026/B/7449412**

**ANNEXURE- 1**

**CHECK LIST**

**NOTE: - Suppliers are required to fill in the following details in their Letterhead and no column should be left blank**

<b>A</b>	<b>Name and Address of the Vendor</b>		
<b>B</b>	<b>GSTN No. the Supplier (Place of Execution of Contract / Purchase Order)</b>		
<b>C</b>	<b>Details of Contact person for this Tender</b>	Name: Mr./ Ms. Designation: Telephone No: Mobile No: Email ID:	
<b>D</b>	<b>EMD DETAILS</b>		
<b>E</b>	<b>DESCRIPTION</b>	<b>APPLICABILITY (BY BHEL)</b>	<b>ENCLOSED BY BIDDER</b>
i.	Whether <b>Pre - Qualification Criteria</b> is understood and provided proper supporting documents.	Applicable	YES / NO
ii.	Whether all pages of the Tender documents including annexures, appendices etc. are read and understood	Applicable	YES / NO
iii.	Audited Balance Sheet and profit & Loss Account for the last three years	Applicable	YES / NO
iv.	Copy of PAN Card & GST registration	Applicable	YES / NO
v.	Submission of <b>MSE certificate (Udyam certificate)</b> as specified in Tender	Applicable	YES / NO
vi.	<b>Offer forwarding letter</b> / tender submission letter as per Annexure - 2	Applicable	YES / NO
vii.	Submission of <b>Certificate of No Deviation</b> as per Annexure - 3	Applicable	YES / NO
viii.	Declaration regarding <b>Insolvency/ Liquidation/ Bankruptcy Proceedings</b> as per Annexure - 4	Applicable	YES / NO
ix.	Declaration by <b>Authorized Signatory</b> as per Annexure - 5	Applicable	YES / NO
x.	Declaration by <b>Authorized Signatory regarding Authenticity</b> of submitted Documents Annexure - 6	Applicable	YES / NO
xii.	Submission of <b>Integrity Pact</b> as specified in Tender as per Annexure - 8	Applicable	YES / NO
xiv.	Declaration reg. <b>Related Firms &amp; their areas of Activities</b> as per Annexure - 10	Applicable	YES / NO
xv.	Declaration for <b>relation in BHEL</b> as per Annexure - 11	Applicable	YES / NO
xix.	<b>Power of Attorney</b> for submission of tender as per Annexure - 15	If Applicable	YES / NO
xx.	<b>Proforma of Bank Guarantee for Earnest Money</b> as per Annexure - 16	If Applicable	YES / NO
xxi.	<b>Proforma of Bank Guarantee for Performance Security</b> as per Annexure - 17	If Applicable	YES / NO
xxii.	<b>List of Consortium Bank</b> as per Annexure - 18	If Applicable	YES / NO
xxiii.	Declaration regarding conflict of interest as per <b>ANNEXURE - 19</b>	Applicable	YES / NO

**NOTE:** Strike off 'YES' or 'NO', as applicable. Tender not accompanied by the prescribed **above applicable documents** are liable to be summarily rejected.

**DATE:**

**Sign. of the AUTHORISED SIGNATORY  
(With Name, Designation and Company seal**

Place:  
Date:

Signature of Authorized Signatory  
with seal & full address  
Page 14 of 44

**NAME OF WORK: SERVICE CONTRACT FOR PART PROCESSING OF LOOSE TUBE BENDS AS PER BHEL DRAWING AT BHEL PREMISES FOR ONE YEAR.**

**Tender Enq. No.: 9472600019/ 29-04-2026; GeM Bid No.: GEM/2026/B/7449412**

**ANNEXURE - 2**

**OFFER FORWARDING LETTER / TENDER SUBMISSION LETTER**

(To be typed and submitted in the **Letterhead** of the Company/Firm of Bidder failing which the offer of Bidder is liable to be summarily rejected)

---

Offer Reference No: .....

Date: .....

To,

The Senior Engineer,  
WCM/ BHEL Trichy-14

Dear Sir,

Sub: Submission of Offer against GeM Bid No: **GEM/2026/B/7449412**

Having examined the tender documents against your GeM Bid No. \_\_\_\_\_ dated \_\_\_\_\_ and having understood the provisions of the said tender documents and having thoroughly studied the requirements of BHEL related to the work tendered for, in connection with \_\_\_\_\_ (name of work), we hereby submit our offer for the proposed work in accordance with terms and conditions mentioned in the tender documents, at the prices quoted by us and as per the scope of work and delivery schedule given in NIT.

Should our Offer be accepted by BHEL for Award, I/we further agree to furnish 'Performance Security' for the work as provided for in the Tender Conditions within the stipulated time as may be indicated by BHEL.

I/We further agree to execute all the works referred to in the said Tender documents upon the terms and conditions contained or referred to therein and as detailed in the appendices annexed thereto.

I/We have deposited herewith the requisite Earnest Money Deposit (EMD) as per details furnished in the Check List.

**Authorized Representative of Bidder**

Signature:

Name: Address:

Place: Date:

Place:  
Date:

Signature of Authorized Signatory  
with seal & full address

**NAME OF WORK: SERVICE CONTRACT FOR PART PROCESSING OF LOOSE TUBE BENDS AS PER BHEL DRAWING AT BHEL PREMISES FOR ONE YEAR.**

**Tender Enq. No.: 9472600019/ 29-04-2026; GeM Bid No.: GEM/2026/B/7449412**

**ANNEXURE- 3**

**CERTIFICATE OF NO DEVIATION**

(To be typed and submitted in the **Letterhead** of the Company/Firm of Bidder failing which the offer of Bidder is liable to be summarily rejected)

-----  
To,  
The Senior Engineer,  
WCM/ BHEL Trichy-14

Dear Sir,

Subject: **No Deviation Certificate**

Ref: 1) GeM Bid No: **GEM/2026/B/7449412**  
2) All other pertinent issues till date

We hereby confirm that we have not changed/ modified/materially altered any of the tender documents as downloaded from the website/ issued by BHEL and in case of such observance at any stage, it shall be treated as null and void.

We also hereby confirm that we have neither set any Terms and Conditions and nor have we taken any deviation from the Tender conditions together with other references applicable for the above referred GeM Bid.

We further confirm our unqualified acceptance to all Terms and Conditions, unqualified compliance to Tender Conditions.

We confirm to have submitted offer in accordance with tender instructions and as per aforesaid references.

Thanking you,

Yours faithfully,

**(Signature, date & seal of authorized representative of the bidder)**

Date:  
Place:

Signature of Authorized Signatory  
with seal & full address

Place:  
Date:

**NAME OF WORK: SERVICE CONTRACT FOR PART PROCESSING OF LOOSE TUBE BENDS AS PER BHEL DRAWING AT BHEL PREMISES FOR ONE YEAR.**

**Tender Enq. No.: 9472600019/ 29-04-2026; GeM Bid No.: GEM/2026/B/7449412**

**ANNEXURE- 4**

**UNDERTAKING**

(To be typed and submitted in the **Letterhead** of the Company/Firm of Bidder failing which the offer of Bidder is liable to be summarily rejected)

---

**To,**

The Senior Engineer,  
WCM/ BHEL Trichy-14

Dear Sir/Madam,

**Sub: DECLARATION REGARDING INSOLVENCY/ LIQUIDATION/ BANKRUPTCY PROCEEDINGS**

**Ref:** GeM Bid Specification No: GEM/2026/B/7449412

I/We,

---

declare that, I/We am/are not under insolvency resolution process or liquidation or Bankruptcy Code Proceedings (IBC) as on date, by NCLT or any adjudicating authority/authorities, which will render us ineligible for participation in this tender.

**Sign. of the AUTHORISED SIGNATORY  
(With Name, Designation and Company seal)**

Place:

Date:

Signature of Authorized Signatory  
with seal & full address

Place:  
Date:

**NAME OF WORK: SERVICE CONTRACT FOR PART PROCESSING OF LOOSE TUBE BENDS AS PER BHEL DRAWING AT BHEL PREMISES FOR ONE YEAR.**

**Tender Enq. No.: 9472600019/ 29-04-2026; GeM Bid No.: GEM/2026/B/7449412**

**ANNEXURE – 5**

**DECLARATION BY AUTHORISED SIGNATORY OF BIDDER**

(To be typed and submitted in the **Letterhead** of the Company/Firm of Bidder failing which the offer of Bidder is liable to be summarily rejected)

To,

The Senior Engineer,  
WCM/ BHEL Trichy-14

Dear Sir,

Sub: **Declaration by Authorized Signatory**

Ref: 1) GeM Bid Specification No: GEM/2026/B/7449412

2) All other pertinent issues till date

I/We, hereby certify that all the information and data furnished by me with regard to the above Tender Specification are true and complete to the best of my knowledge. I have gone through the specifications, conditions, stipulations and all other pertinent issues till date, and agree to comply with the requirements and Intent of the specification.

I further certify that I am authorized to represent on behalf of my Company/Firm for the above mentioned tender and a valid Power of Attorney to this effect is also enclosed.

Yours faithfully,

(Signature, Date & Seal of Authorized Signatory of the Bidder) Date:

Enclosed: Power of Attorney

Place:  
Date:

Signature of Authorized Signatory  
with seal & full address

**NAME OF WORK: SERVICE CONTRACT FOR PART PROCESSING OF LOOSE TUBE BENDS AS PER BHEL DRAWING AT BHEL PREMISES FOR ONE YEAR.**

**Tender Enq. No.: 9472600019/ 29-04-2026; GeM Bid No.: GEM/2026/B/7449412**

**ANNEXURE – 6**

**DECLARATION BY AUTHORISED SIGNATORY OF BIDDER**

(To be typed and submitted in the **Letterhead** of the Company/Firm of Bidder failing which the offer of Bidder is liable to be summarily rejected)

-----  
To,

The Senior Engineer,  
WCM/ BHEL Trichy-14

Sir,

Sub: **Declaration by Authorized Signatory regarding Authenticity of submitted documents.**

Ref: 1) GeM Bid No. & Date: **GEM/2026/B/7449412**

2) All other pertinent issues till date

I/We, hereby certify that all the documents submitted by us in support of possession of “Qualifying Requirements” are true copies of the original and are fully compliant required for qualifying / applying in the bid and shall produce the original of same as and when required by Bharat Heavy Electricals Limited.

I / We hereby further confirm that no tampering is done with documents submitted in support of our qualification as bidder. I / We understand that at any stage (during bidding process or while executing the awarded contract) if it is found that fake / false / forged bid qualifying / supporting documents / certificates were submitted, it would lead to summarily rejection of our bid / termination of contract. BHEL shall be at liberty to initiate other appropriate actions as per the terms of the Bid / Contract and other extant policies of Bharat Heavy Electricals Limited.

Yours faithfully,

**(Signature, Date & Seal of Authorized Signatory of the Bidder)**

**Date:**

Place:  
Date:

Signature of Authorized Signatory  
with seal & full address

## **INTEGRITY PACT**

### **ANNEXURE – 8**

Bharat Heavy Electricals Ltd. (BHEL), a company registered under the Companies Act 1956 and having its registered office at "BHEL House", Siri Fort, New Delhi - 110049 (India) hereinafter referred to as "The Principal", which expression unless repugnant to the context or meaning hereof shall include its successors or assigns of the ONE PART and \_\_\_\_\_, (description of the party along with address), hereinafter referred to as "The Bidder/ Contractor" which expression unless repugnant to the context or meaning hereof shall include its successors or assigns of the OTHER PART

### **Preamble**

The Principal intends to award, under laid-down organizational procedures, contract/s for \_\_\_\_\_

\_\_\_\_\_, The Principal values full compliance with all relevant laws of the land, rules and regulations, and the principles of economic use of resources, and of fairness and transparency in its relations with its Bidder(s)/ Contractor(s).

In order to achieve these goals, the Principal will appoint Independent External Monitor(s), who will monitor the tender process and the execution of the contract for compliance with the principles mentioned above.

### **Section 1- Commitments of the Principal**

1.1 The Principal commits itself to take all measures necessary to prevent corruption and to observe the following principles: -

- 1.1.1 No employee of the Principal, personally or through family members, will in connection with the tender for, or the execution of a contract, demand, take a promise for or accept, for self or third person, any material or immaterial benefit which the person is not legally entitled to.
- 1.1.2 The Principal will, during the tender process treat all Bidder(s) with equity and reason. The Principal will in particular, before and during the tender process, provide to all Bidder(s) the same information and will not provide to any Bidder(s) confidential/ additional information through which the Bidder(s) could obtain an advantage in relation to the tender process or the contract execution.
- 1.1.3 The Principal will exclude from the process all known prejudiced persons.

1.2 If the Principal obtains information on the conduct of any of its employees which is a penal offence under the Indian Penal Code 1860 and Prevention of Corruption Act 1988 or any other statutory penal enactment, or if there be a substantive suspicion in this regard, the Principal will inform its Vigilance Office and in addition can initiate disciplinary actions.

### **Section 2 - Commitments of the Bidder(s)/ Contractor(s)**

2.1 The Bidder(s)/ Contractor(s) commit himself to take all measures necessary to prevent corruption. He commits himself to observe the following principles during his participation in the tender process and during the contract execution.

2.1.1 The Bidder(s)/ Contractor(s) will not, directly or through any other person or firm, offer, promise or give to the Principal or to any of the Principal's employees involved in the tender process or the execution of the contract or to any third person any material, immaterial or any other benefit which he/ she is not legally entitled to, in order to obtain in exchange any advantage of any kind whatsoever during the tender process or during the execution of the contract.

Place:  
Date:

Signature of Authorized Signatory  
with seal & full address

**NAME OF WORK: SERVICE CONTRACT FOR PART PROCESSING OF LOOSE TUBE BENDS AS PER BHEL DRAWING AT BHEL PREMISES FOR ONE YEAR.**

**Tender Enq. No.: 9472600019/ 29-04-2026; GeM Bid No.: GEM/2026/B/7449412**

2.1.2 The Bidder(s)/ Contractor(s) will not enter with other Bidder(s) into any illegal or undisclosed agreement or understanding, whether formal or informal. This applies in particular to prices, specifications, certifications, subsidiary contracts, submission or non-submission of bids or any other actions to restrict competitiveness or to introduce cartelization in the bidding process.

2.1.3 The Bidder(s)/ Contractor(s) will not commit any penal offence under the relevant Indian Penal Code (IPC) and Prevention of Corruption Act; further the Bidder(s)/ Contractor(s) will not use improperly, for purposes of competition or personal gain, or pass on to others, any information or document provided by the Principal as part of the business relationship, regarding plans, technical proposals and business details, including information contained or transmitted electronically.

2.1.4 Foreign Bidder(s)/ Contractor(s) shall disclose the name and address of agents and representatives in India and Indian Bidder(s)/ Contractor(s) to disclose their foreign principals or associates. The Bidder(s)/ Contractor(s) will, when presenting his bid, disclose any and all payments he has made, and is committed to or intends to make to agents, brokers or any other intermediaries in connection with the award of the contract.

2.2 The Bidder(s)/ Contractor(s) will not instigate third persons to commit offences outlined above or be an accessory to such offences.

2.3 The Bidder(s)/ Contractor(s) shall not approach the Courts while representing the matters to IEMs and will await their decision in the matter.

**Section 3 - Disqualification from tender process and exclusion from future contracts.**

If the Bidder(s)/ Contractor(s), before award or during execution has committed a transgression through a violation of Section 2 above, or acts in any other manner such as to put his reliability or credibility in question, the Principal is entitled to disqualify the Bidder(s)/ Contractor(s) from the tender process or take action as per the separate "Guidelines on Banning of Business dealings with Suppliers/ Contractors", framed by the Principal.

**Section 4 - Compensation for Damages**

1.1 If the Principal has disqualified the Bidder from the tender process prior to the award according to Section 3, the Principal is entitled to demand and recover the damages equivalent Earnest Money Deposit/ Bid Security.

1.2 If the Principal has terminated the contract according to Section 3, or if the Principal is entitled to terminate the contract according to section 3, the Principal shall be entitled to demand and recover from the Contractor liquidated damages equivalent to 5% of the contract value or the amount equivalent to Security Deposit/ Performance Bank Guarantee, whichever is higher.

**Section 5 - Previous Transgression**

5.1 The Bidder declares that no previous transgressions occurred in the last 3 years with any other company in any country conforming to the anti-corruption approach or with any other Public Sector Enterprise in India that could justify his exclusion from the tender process. The date of such transgression, for the purpose of disclosure by the bidder in this regard, would be the date of which cognizance of the said transgression was taken by the competent authority. The transgressions(s), for which cognizance was taken even before the said period of three years, but are pending conclusion, shall also be reported by the bidders.

5.2 If the Bidder makes incorrect statement on this subject, he can be disqualified from the tender process or the contract, if already awarded, can be terminated for such reason or action can be taken as per the separate "Guideline on Banning of business dealings with suppliers / contractors". Framed by the principal.

**Section 6 - Equal treatment of all Bidders/ Contractors / Sub-contractors**

6.1 The Principal will enter into integrity pacts with identical conditions as this integrity pact with all Bidders and Contractors.

6.2 In case of Joint venture, all the partners of the joint venture should sign the integrity pact. In case of sub-contracting,

Place:  
Date:

Signature of Authorized Signatory  
with seal & full address

**NAME OF WORK: SERVICE CONTRACT FOR PART PROCESSING OF LOOSE TUBE BENDS AS PER BHEL DRAWING AT BHEL PREMISES FOR ONE YEAR.**

**Tender Enq. No.: 9472600019/ 29-04-2026; GeM Bid No.: GEM/2026/B/7449412**

the Principal contractor shall be responsible for adherence to provision of IP by the sub-contractor (s)

6.2 The Principal will disqualify from the tender process all bidders who do not sign this pact or violate its provisions.

**Section 7 - Criminal Charges against violating Bidders/ Contractors /Subcontractors**

If the Principal obtains knowledge of conduct of a Bidder, Contractor or Subcontractor, or of an employee or a representative or an associate of a Bidder, Contractor or Subcontractor which constitutes corruption, or if the Principal has substantive suspicion in this regard, the Principal will inform the Vigilance Office.

**Section 8 -Independent External Monitor(s)**

8.1 The Principal appoints competent and credible panel of Independent External Monitor (s) (IEMs) for this Integrity Pact The task of the IEMs is to review independently and objectively, whether and to what extent the parties comply with the obligations under this Integrity Pact on receipt of any complaint by them from the bidder(s).

8.2 The IEMs are not subject to instructions by the representatives of the parties and performs his functions neutrally and independently. He reports to the CMD, BHEL.

8.3 The IEMs shall be provided access to all documents/ records pertaining to the Contract, for which a complaint or issue is raised before them as and when warranted.

8.4 The Principal will provide to the IEMs sufficient information about all meetings among the parties related to the Contract provided such meetings could have an impact on the contractual relations between the Principal and the Contractor. The parties offer to the IEMs the option to participate in such meetings.

8.5 The role of IEM is advisory and the advice of IEM is non-binding on the Organization. However, their advice would help in proper implementation of the IP.

8.6 For ensuring the desired transparency and objectivity in dealing with the complaints arising out of the tendering process, the matter should be examined by the full panel of IEMs jointly, who would look into the records, conduct an examination, and submit their joint recommendations to the Management.

8.7 The IEMs shall examine all the representations/grievances/complaints received by them from the bidders or their authorized representative related to any discrimination.

8.8 The CMD, BHEL shall decide the compensation to be paid to the IEMs and its terms and conditions .

8.9 IEMs should examine the process integrity, they are not expected to concern themselves with fixing of responsibility of officers (p. 10). Complaints alleging mala fide on the part of any officer of the Principal should be looked into by the CVO of the Principal.

8.10 If the IEMs have reported to the CMD, BHEL, a substantiated suspicion of an offence under relevant Bharatiya Nyaya Sanhita (BNS)/ Prevention of Corruption Act, and the CMD, BHEL has not, within reasonable time, taken visible action, the IEMs may also transmit this information directly to the Central Vigilance Commissioner, Government of India.

8.11 After award of work, the IEMs shall look into any issue relating to execution of Contract, if specifically raised before them as an illustrative example, if a contractor who has awarded the contract, during the execution of contract, raises issue a delayed payment etc. Before the IEMs, the same shall be examined by the panel of IEMs.

8.12 However, the IEMs may suggest systemic improvements to the management of the Principal, if considered necessary, to bring about transparency, equity and fairness in the system of procurement.

8.13 The word 'Monitor' would include both singular and plural.

**Section 9 - Pact Duration**

9.1 This Pact shall be operative from the date IP is signed by both the parties till the final completion of contract for successful bidder and for all other bidders 6 months after the contract has been awarded. Issues like warranty / guarantee etc. should be outside the purview of IEMs.

Place:

Date:

Signature of Authorized Signatory  
with seal & full address

**NAME OF WORK: SERVICE CONTRACT FOR PART PROCESSING OF LOOSE TUBE BENDS AS PER BHEL DRAWING AT BHEL PREMISES FOR ONE YEAR.**

**Tender Enq. No.: 9472600019/ 29-04-2026; GeM Bid No.: GEM/2026/B/7449412**

9.2 If any claim is made/ lodged during currency of IP, the same shall be binding and continue to be valid despite the lapse of this pact as specified above, unless it is discharged/ determined by the CMD, BHEL.

**Section 10 - Other Provisions**

- 10.1 This integrity pact is subject to Indian Laws and exclusive jurisdiction shall be of the competent courts as indicated in the tender or contract (Tiruchirappalli) as the case may be.
- 10.2 Changes and supplements as well as termination notices need to be made in writing.
- 10.3 If the bidder (s) Contractor(s) is a partnership or a consortium or a joint venture, this integrity pact shall be signed by all partners of the partnership or joint venture or all consortium members.
- 10.4 Should one or several provisions of this agreement turn out to be invalid, the remainder of this integrity pact remains valid. In this case, the parties will strive to come to an agreement to their original intentions.
- 10.5 Only those bidders / contractors who have entered into this integrity pact with the Principal would be competent to participate in the bidding. In other words, entering into this agreement would be a preliminary qualification.
- 10.6 In the event of any dispute between the Principal and Bidder(s)/ Contractor(s) relating to the Contract, both parties may try to settle the dispute through Mediation before the panel of IEMs in a time bound manner, if required the principal may adopt any meditation rules for this purpose. However, not more than five meetings shall be held for a particular dispute resolution. The fees / expense on dispute resolution shall be equally shared by both the parties. In case, the dispute remains un resolved even after mediation by the panel IEMs, either party may take further action as the terms & Conditions of the contract.

For & On behalf of the Principal

For & On behalf of the Bidder/ Contractor



**K. PRAVEETH**  
Engineer  
Works Contracts Management  
BHEL, TRICHY - 620 014.

(Office Seal)

(Office Seal)

Place-----

Date-----



**DINESHWAR PAHAN**  
Dy. Engineer  
Works Contracts Management  
BHEL, TRICHY - 620 014.

Witness:\_\_\_\_\_

Witness:\_\_\_\_\_

(Name & Address)\_\_\_\_\_

(Name & Address)\_\_\_\_\_

Place:  
Date:

Signature of Authorized Signatory  
with seal & full address

**NAME OF WORK: SERVICE CONTRACT FOR PART PROCESSING OF LOOSE TUBE BENDS AS PER BHEL DRAWING AT BHEL PREMISES FOR ONE YEAR.**

**Tender Enq. No.: 9472600019/ 29-04-2026; GeM Bid No.: GEM/2026/B/7449412**

**ANNEXURE - 10**

**DECLARATION**

(To be typed and submitted in the **Letterhead** of the Company/Firm of Bidder failing which the offer of Bidder is liable to be summarily rejected)

Date: \_\_\_\_\_

To,

The Senior Engineer,  
WCM/ BHEL Trichy-14

Dear Sir/ Madam,

Sub: **Details of related firms and their area of activities**

Ref: 1) GeM Bid Specification No.: GEM/2026/B/7449412

Please find below details of firms owned by our family members that are doing business/ registered for same item with BHEL, (**Write NA, if not applicable**)

1	Material Category/ Work Description	
	Name of Firm	
	Address of Firm	
	Nature of Business	
	Name of Family Member	
	Relationship	
2	Material Category/ Work Description	
	Name of Firm	
	Address of Firm	
	Nature of Business	
	Name of Family Member	
	Relationship	
...		

**Note:** I certify that the above information is true and I agree for penal action from BHEL in case any of the above information furnished is found to be false.

Regards,

(\_\_\_\_\_)

From: M/s \_\_\_\_\_

Supplier Code: \_\_\_\_\_

Address: \_\_\_\_\_

Signature of Authorized Signatory  
with seal & full address

Place:  
Date:

**NAME OF WORK: SERVICE CONTRACT FOR PART PROCESSING OF LOOSE TUBE BENDS AS PER BHEL DRAWING AT BHEL PREMISES FOR ONE YEAR.**

**Tender Enq. No.: 9472600019/ 29-04-2026; GeM Bid No.: GEM/2026/B/7449412**

**ANNEXURE - 11**

**DECLARATION FOR RELATION IN BHEL**

(To be typed and submitted in the **Letterhead** of the Company/Firm of Bidder failing which the offer of Bidder is liable to be summarily rejected)

To,

The Senior Engineer,  
WCM/ BHEL Trichy-14

Dear Sir,

**Sub: Declaration for relation in BHEL**

**Ref:** 1) GeM Bid Specification No: GEM/2026/B/7449412

I/We hereby submit the following information pertaining to relation/relatives of Proprietor/Partner(s)/ Director(s) employed in BHEL

**Tick (✓)any one as applicable:**

1. The Proprietor, Partner(s), Director(s) of our Company/Firm DO NOT have any relation or relatives employed in BHEL

OR

2. The Proprietor, Partner(s), or Director(s) of our Company/Firm HAVE relation/relatives employed in BHEL and their particulars are as below:

i.

ii.

**(Signature, Date & Seal of Authorized Signatory of the Bidder)**

Note:

1. Attach separate sheet, if necessary.
2. If BHEL Management comes to know at a later date that the information furnished by the Bidder is false, BHEL reserves the right to take suitable against the Bidder/Contractor.

Place:  
Date:

WCM Dept. / 3<sup>rd</sup> Floor, 24 Bldg. / BHEL, Trichy-14

Signature of Authorized Signatory  
with seal & full address  
Page 25 of 44

**NAME OF WORK: SERVICE CONTRACT FOR PART PROCESSING OF LOOSE TUBE BENDS AS PER BHEL DRAWING AT BHEL PREMISES FOR ONE YEAR.**

**Tender Enq. No.: 9472600019/ 29-04-2026; GeM Bid No.: GEM/2026/B/7449412**

**ANNEXURE - 15**

**POWER OF ATTORNEY for SUBMISSION OF TENDER**

**(To be typed on non-judicial stamp paper of minimum Rs. 100/- and Notarized)**

KNOW ALL MEN BY THESE PRESENTS, that I/We do hereby make, nominate, constitute and appoint Mr. ...., whose signature given below herewith to be true and lawful Attorney of M/s..... hereinafter called 'Company', for submitting Tender/entering into Contract and inter alia, sign, execute all papers and to do necessary lawful acts on behalf of Company with M/s Bharat Heavy Electricals Ltd, Central Procurement Cell (CPC), in connection with.....vide GeM Bid No: .dated .....

And the Company do hereby agree to ratify and confirm all acts, deeds, things or proceedings as may be lawfully done by the said attorney and by or on behalf of the company and in the name of the company, by virtue of the powers conferred herein and the same shall be binding on the company and shall have full force and effect.

IN WITNESS WHEREOF, the common seal of the company has been hereunto affixed in the manner hereinafter appearing on the document.

Dated at \_\_\_\_\_, this \_\_\_\_\_ day of \_\_\_\_\_

Director/CMD/Partner/Proprietor

Signature of Mr. .... (Attorney)

Attested by: Director/CMD/Partner/Proprietor

Witness

Notary Public

Place:  
Date:

WCM Dept. / 3<sup>rd</sup> Floor, 24 Bldg. / BHEL, Trichy-14

Signature of Authorized Signatory  
with seal & full address  
Page 26 of 44

**NAME OF WORK: SERVICE CONTRACT FOR PART PROCESSING OF LOOSE TUBE BENDS AS PER BHEL DRAWING AT BHEL PREMISES FOR ONE YEAR.**

**Tender Enq. No.: 9472600019/ 29-04-2026; GeM Bid No.: GEM/2026/B/7449412**

**ANNEXURE – 16**

**PROFORMA OF BANK GUARANTEE FOR EARNEST MONEY**

**(On non-Judicial stamp paper of appropriate value)**

Bank guarantees should be received through SFMS (Structured Financial Messaging System) only.

Bank Guarantee No.....

Date.....

**To**

(Employer's Name and Address)

.....

Dear Sirs,

In accordance with the terms and conditions of Invitation for Bids/Notice Inviting Tender No.....<sup>1</sup>(Tender Conditions), M/s. .... having its registered office at .....<sup>2</sup> (hereinafter referred to as the 'Tenderer'), is submitting its bid for the work of.....<sup>3</sup> invited by .....<sup>4</sup>.(name of the Employer) through its Unit at .....(

The Tender Conditions provide that the Tenderer shall pay a sum of Rs ..... as Earnest Money Deposit in the form therein mentioned. The form of payment of Earnest Money Deposit includes Bank Guarantee executed by a Scheduled Bank.

In lieu of the stipulations contained in the aforesaid Tender Conditions that an irrevocable and unconditional Bank Guarantee against Earnest Money Deposit for an amount of .....<sup>5</sup> ..... is required to be submitted by the Tenderer as a condition precedent for participation in the said Tender and the Tenderer having approached us for giving the said Guarantee,

we, the .....[Name & address of the Bank]

..... having our Registered Office at

.....(hereinafter referred to as the Bank) being the Guarantor under this Guarantee, hereby irrevocably and unconditionally undertake to forthwith and immediately pay to the Employer without any demur, merely on your first demand any sum or sums of Rs.

.....<sup>5</sup> (in words Rupees.....) without any reservation,

protest, and recourse and without the beneficiary needing to prove or demonstrate reasons for its such demand.

Any such demand made on the Bank shall be conclusive as regards the amount due and payable by the Bank under this guarantee. However, our liability under this guarantee shall be restricted to an amount not exceeding Rs. \_ \_.

We undertake to pay to the Employer any money so demanded notwithstanding any dispute or disputes raised by the Vendor/Contractor/Vendors in any suit or proceeding pending before any Court or Tribunal, Arbitrator or any other authority, our liability under this present being absolute and unequivocal.

The payment so made by us under this Guarantee shall be a valid discharge of our liability for payment hereunder and the Tenderer shall have no claim against us for making such payment.

We ..... Bank further agree that the Employer shall have the fullest liberty without our consent and without affecting in any manner our obligations hereunder to vary any of the terms and conditions of the said Tender or to extend the time of submission of from time to time or to postpone for any time or from time to time any of the powers exercisable by the Employer against the said Tenderer and we shall not be relieved from our liability by reason of any such variation, or extension being granted to the said Tenderer or for any forbearance, act or omission on the part of the Employer or any indulgence by the Employer to the said Tenderer or by any such matter or thing

Place / स्थान:

Date / दिनांक:

Signature of Authorized Signatory

with seal & full address

**NAME OF WORK: SERVICE CONTRACT FOR PART PROCESSING OF LOOSE TUBE BENDS AS PER BHEL DRAWING AT BHEL PREMISES FOR ONE YEAR.**

**Tender Enq. No.: 9472600019/ 29-04-2026; GeM Bid No.: GEM/2026/B/7449412**

whatsoever which under the law relating to sureties would but for this provision have effect of so relieving us.

The Bank also agrees that the Employer at its option shall be entitled to enforce this Guarantee against the Bank as a principal debtor, in the first instance without proceeding against the Tenderer and notwithstanding any security or other guarantee that the Employer may have in relation to the Tenderer's liabilities.

This Guarantee shall be irrevocable and shall remain in force upto and including.....6 and shall be extended from time to time for such period as may be desired by the Employer.

This Guarantee shall not be determined or affected by liquidation or winding up, dissolution or change of constitution or insolvency of the Tenderer but shall in all respects and for all purposes be binding and operative until payment of all money payable to the Employer in terms hereof. However, unless a demand or claim under this Guarantee is made on us in writing on or before the ..... 7 we shall be discharged from all liabilities under this Guarantee.

Unless a demand or claim under this guarantee is made on us in writing on or before the ..... 8 we shall be discharged from all liabilities under this guarantee thereafter. This Bank Guarantee shall be governed, construed and interpreted in accordance with the laws of India.

Courts at **Tiruchirappalli** shall alone have exclusive jurisdiction over any matter arising out of or in connection with this Bank Guarantee

We, ..... Bank lastly undertake not to revoke this guarantee during its currency except with the previous consent of the Employer in writing.

Notwithstanding anything to the contrary contained hereinabove:

- a. The liability of the Bank under this Guarantee shall not exceed..... 5 .....
- b. This Guarantee shall be valid up to ..... 6
- c. Unless the Bank is served a written claim or demand on or before ..... 7 all rights under this guarantee shall be forfeited and the Bank shall be relieved and discharged from all liabilities under this guarantee irrespective of whether or not the original bank guarantee is returned to the Bank

We, ..... Bank, have power to issue this Guarantee under law and the undersigned as a duly authorized person has full powers to sign this Guarantee on behalf of the Bank.

For and on behalf of  
(Name of the Bank)

Date.....

Place of Issue.....

<sup>1</sup> Details of the Invitation to Bid/Notice Inviting Tender

<sup>2</sup> Name and Address of the Tenderer

<sup>3</sup> Details of the Work

<sup>4</sup> Name of the Employer

<sup>5</sup> BG Amount in words and Figures

<sup>6</sup> Validity Date

<sup>7</sup> Date of Expiry of Claim Period

Place / स्थान:  
Date / दिनांक:

Signature of Authorized Signatory  
with seal & full address

**NAME OF WORK: SERVICE CONTRACT FOR PART PROCESSING OF LOOSE TUBE BENDS AS PER BHEL DRAWING AT BHEL PREMISES FOR ONE YEAR.**

**Tender Enq. No.: 9472600019/ 29-04-2026; GeM Bid No.: GEM/2026/B/7449412**

**Notes:**

1. Units are advised that expiry of claim period may be kept **six (6) months** after validity date. It may be ensured that the same is in line with the agreement/ contract entered with the Vendor.
2. The BG should be on Non-Judicial Stamp paper/e-stamp paper of appropriate value as per Stamp Act prevailing in the State(s) where the BG is submitted or is to be acted upon or the rate prevailing in the State where the BG was executed, whichever is higher. The Stamp Paper/e- stamp paper shall be purchased in the name of Contractor/sub-contractor /vendor/ Bank issuing the guarantee.
3. In line with the GCC, SCC or contractual terms, Unit may carry out minor modifications in the Standard BG Formats. If required, such modifications may be carried out after taking up appropriately with the Unit/Region's Law Deptt.

**4. In Case of Bank Guarantees submitted by Foreign Vendors-**

**a.** From Nationalized/Public Sector / Private Sector/ Foreign Banks (BG issued by Branches in India) can be accepted subject to the condition that the Bank Guarantee should be enforceable in the town/city or at nearest branch where the Unit is located i.e., Demand can be presented at the Branch located in the town/city or at nearest branch where the Unit is located.

**b.** From Foreign Banks (wherein Foreign Vendors intend to provide BG from local branch of the Vendor Country's Bank)

**b.1** In such cases, in the Tender Enquiry/ Contract itself, it may be clearly specified that Bank Guarantee issued by any of the Consortium Banks only will be accepted by BHEL. As such, Foreign Vendor needs to make necessary arrangements for issuance of Counter- Guarantee by Foreign Bank in favor of the Indian Bank's (BHEL's Consortium Bank) branch in India. It is advisable that all charges for issuance of Bank Guarantee/ counter- Guarantee should be borne by the Foreign Vendor. The tender stipulation should clearly specify these requirements.

**b.2** In case, Foreign Vendors intend to provide BG from Overseas Branch of our Consortium Bank (e.g. if a BG is to be issued by SBI Frankfurt), the same is acceptable. However, the procedure at sl.no. b.1 will required to be followed.

**b.3** The BG issued may preferably be subject to Uniform Rules for Demand Guarantees (URDG) 758 (as amended from time to time). The BG Format provided to them should clearly specify the same

Place / स्थान:  
Date / दिनांक:

Signature of Authorized Signatory  
with seal & full address

**NAME OF WORK: SERVICE CONTRACT FOR PART PROCESSING OF LOOSE TUBE BENDS AS PER BHEL DRAWING AT BHEL PREMISES FOR ONE YEAR.**

**Tender Enq. No.: 9472600019/ 29-04-2026; GeM Bid No.: GEM/2026/B/7449412**

**ANNEXURE - 17**

**BANK GUARANTEE FOR SECURITY DEPOSIT**  
(On non-Judicial stamp paper of appropriate value)

**Bank guarantees should be received through SFMS (Structured Financial Messaging System) only.**  
**BANK GUARANTEE will be accepted only from the consortium Banks, List provided in annexure-18**

---

Bank Guarantee No:  
Date:

To  
NAME & ADDRESSES OF THE BENEFICIARY

Dear Sirs,

In consideration of Bharat Heavy Electricals Limited (hereinafter referred to as the 'Employer' which expression shall unless repugnant to the context or meaning thereof, include its successors and permitted assigns) incorporated under the Companies Act, 1956 and having its registered office at \_\_\_\_\_<sup>1</sup> through its Unit at.....(name of the Unit) having awarded to (Name of the Vendor / Contractor / Supplier) with its registered office at \_\_\_\_\_<sup>2</sup> hereinafter referred to as the 'Vendor / Contractor / Supplier', which expression shall unless repugnant to the context or meaning thereof, include its successors and permitted assigns), a contract Ref No.....dated .....<sup>3</sup> valued at Rs.....<sup>4</sup> (Rupees -----) / FC.....(in words.....) for .....<sup>5</sup> (hereinafter called the 'Contract') and the Vendor / Contractor / Supplier having agreed to provide a Contract Performance Bank Guarantee, equivalent to .....% (... Percent) of the said value of the Contract to the Employer for the faithful performance of the Contract,

We, ....., (hereinafter referred to as the Bank), having registered/Head office at ..... and inter alia a branch at ..... being the Guarantor under this Guarantee, hereby, irrevocably and unconditionally undertake to forthwith and immediately pay to the Employer any sum or sums upto a maximum amount of Rs -----<sup>6</sup> (Rupees -----) without any demur, immediately on first demand from the Employer and without any reservation, protest, and recourse and without the Employer needing to prove or demonstrate reasons for its such demand.

Any such demand made on the Bank shall be conclusive as regards the amount due and payable by the Bank under this guarantee. However, our liability under this guarantee shall be restricted to an amount not exceeding Rs. \_ .

We undertake to pay to the Employer any money so demanded notwithstanding any dispute or disputes raised by the Vendor / Contractor / Supplier in any suit or proceeding pending before any Court or Tribunal, Arbitrator or any other authority, our liability under this present being absolute and unequivocal.

The payment so made by us under this Guarantee shall be a valid discharge of our liability for payment thereunder and the Vendor / Contractor / Supplier shall have no claim against us for making such payment.

We the .....bank further agree that the guarantee herein contained shall remain in full force and effect during the period that would be taken for the performance of the said Contract/ satisfactory completion of the performance guarantee period as per the terms of the Contract and that it shall continue to be enforceable till all the dues of the Employer under or by virtue of the said Contract have been fully paid and its claims satisfied or discharged.

Place / स्थान:  
Date / दिनांक:

Signature of Authorized Signatory  
with seal & full address

**NAME OF WORK: SERVICE CONTRACT FOR PART PROCESSING OF LOOSE TUBE BENDS AS PER BHEL DRAWING AT BHEL PREMISES FOR ONE YEAR.**

**Tender Enq. No.: 9472600019/ 29-04-2026; GeM Bid No.: GEM/2026/B/7449412**

We .....BANK further agree with the Employer that the Employer shall have the fullest liberty without our consent and without affecting in any manner our obligations hereunder to vary any of the terms and conditions of the said Contract or to extend time of performance by the said Vendor / Contractor / Supplier from time to time or to postpone for any time or from time to time any of the powers exercisable by the Employer against the said Vendor / Contractor / Supplier and to forbear or enforce any of the terms and conditions relating to the said Contract and we shall not be relieved from our liability by reason of any such variation, or extension being granted to the said Vendor / Contractor/ Supplier or for any forbearance, act or omission on the part of the Employer or any indulgence by the Employer to the said Vendor / Contractor / Supplier or by any such matter or thing whatsoever which under the law relating to sureties would but for this provision have effect of so relieving us.

The Bank also agrees that the Employer at its option shall be entitled to enforce this Guarantee against the Bank as a principal debtor, in the first instance without proceeding against the Vendor / Contractor/ Supplier and notwithstanding any security or other guarantee that the Employer may have in relation to the Vendor /Contractor / Supplier 's liabilities.

This Guarantee shall remain in force upto and including.....<sup>7</sup> and shall be extended from time to time for such period as may be desired by Employer.

This Guarantee shall not be determined or affected by liquidation or winding up, dissolution or change of constitution or insolvency of the Vendor / Contractor / Supplier but shall in all respects and for all purposes be binding and operative until payment of all money payable to the Employer in terms thereof.

Unless a demand or claim under this guarantee is made on us in writing on or before the .....<sup>8</sup> we shall be discharged from all liabilities under this guarantee thereafter. This Bank Guarantee shall be governed, construed and interpreted in accordance with the laws of India.

Courts at **Tiruchirappalli** shall alone have exclusive jurisdiction over any matter arising out of or in connection with this Bank Guarantee.

We, ..... BANK lastly undertake not to revoke this guarantee during its currency except with the previous consent of the Employer in writing.

Notwithstanding anything to the contrary contained hereinabove:

- a. The liability of the Bank under this Guarantee shall not exceed.....<sup>6</sup>
- b. This Guarantee shall be valid up to .....<sup>7</sup>
- c. Unless the Bank is served a written claim or demand on or before .....<sup>8</sup> all rights under this guarantee shall be forfeited and the Bank shall be relieved and discharged from all liabilities under this guarantee irrespective of whether or not the original bank guarantee is returned to the Bank.

We, \_\_\_\_\_ Bank, have power to issue this Guarantee under law and the undersigned as a duly authorized person has full powers to sign this Guarantee on behalf of the Bank.

For and on behalf of  
(Name of the Bank)

Dated.....  
Place of Issue.....

<sup>1</sup> NAME AND ADDRESS OF EMPLOYER i.e., Bharat Heavy Electricals Limited.

<sup>2</sup> NAME AND ADDRESS OF THE VENDOR /CONTRACTOR / SUPPLIER.

<sup>3</sup> DETAILS ABOUT THE NOTICE OF AWARD/CONTRACT REFERENCE.

Place / स्थान:  
Date / दिनांक:

Signature of Authorized Signatory  
with seal & full address

**NAME OF WORK: SERVICE CONTRACT FOR PART PROCESSING OF LOOSE TUBE BENDS AS PER BHEL DRAWING AT BHEL PREMISES FOR ONE YEAR.**

**Tender Enq. No.: 9472600019/ 29-04-2026; GeM Bid No.: GEM/2026/B/7449412**

<sup>4</sup> *CONTRACT VALUE.*

<sup>5</sup> *PROJECT/SUPPLY DETAILS.*

<sup>6</sup> *BG AMOUNT IN FIGURES AND WORDS.*

<sup>7</sup> *VALIDITY DATE.*

<sup>8</sup> *DATE OF EXPIRY OF CLAIM PERIOD.*

**Note:**

1. Units are advised that expiry of claim period may be kept Six (6) months after validity date. It may be ensured that the same is in line with the agreement/ contract entered with the Vendor.
2. The BG should be on Non-Judicial Stamp paper/e-stamp paper of appropriate value as per Stamp Act prevailing in the State(s) where the BG is submitted or is to be acted upon or the rate prevailing in the State where the BG was executed, whichever is higher. The Stamp Paper/e-stamp paper shall be purchased in the name of Vendor/Contractor/Supplier /Bank issuing the guarantee.
3. In line with the GCC, SCC or contractual terms, Unit may carry out minor modifications in the Standard BG Formats. If required, such modifications may be carried out after taking up appropriately with the Unit/Region's Law Deptt.

**4. In Case of Bank Guarantees submitted by Foreign Vendors-**

**a. From Nationalized/Public Sector / Private Sector/ Foreign Banks (BG issued by Branches in India)** can be accepted subject to the condition that the Bank Guarantee should be enforceable in the town/city or at nearest branch where the Unit is located i.e. Demand can be presented at the Branch located in the town/city or at nearest branch where the Unit is located.

**b. From Foreign Banks (wherein Foreign Vendors intend to provide BG from local branch of the Vendor Country's Bank)**

**b.1** In such cases, in the Tender Enquiry/ Contract itself, it may be clearly specified that Bank Guarantee issued by **any of the Consortium Banks only** will be accepted by BHEL. As such, Foreign Vendor needs to make necessary arrangements for issuance of Counter- Guarantee by Foreign Bank in favor of the Indian Bank's (BHEL's Consortium Bank) branch in India. It is advisable that all charges for issuance of Bank Guarantee/ counter- Guarantee should be borne by the Foreign Vendor. The tender stipulation should clearly specify these requirements.

**b.2 In case, Foreign Vendors intend to provide BG from Overseas Branch of our Consortium Bank** (e.g. if a BG is to be issued by SBI Frankfurt), the same is acceptable. However, the procedure at **sl.no. b.1** will required to be followed.

**b.3** The BG issued may preferably be subject to Uniform Rules for Demand Guarantees (URDG) 758 (as amended from time to time). The BG Format provided to them should clearly specify the same.

Place:  
Date:

WCM Dept. / 3<sup>rd</sup> Floor, 24 Bldg. / BHEL, Trichy-14

Signature of Authorized Signatory  
with seal & full address  
Page 32 of 44

**NAME OF WORK: SERVICE CONTRACT FOR PART PROCESSING OF LOOSE TUBE BENDS AS PER BHEL DRAWING AT BHEL PREMISES FOR ONE YEAR.**

**Tender Enq. No.: 9472600019/ 29-04-2026; GeM Bid No.: GEM/2026/B/7449412**

**ANNEXURE - 18**

**LIST OF CONSORTIUM BANK**

**(BANK GUARANTEE will be accepted only from the following consortium Banks)**

<b>Sl. No.</b>	<b>NAME OF THE BANK</b>
1	State Bank of India
2	Canara Bank
3	IDBI Bank Limited
4	ICICI Bank Limited
5	HDFC Bank Limited
6	Axis Bank
7	IndusInd Bank Limited
8	Bank of Baroda
9	Exim Bank
10	Indian Bank
11	Punjab National Bank
12	Union Bank of India
13	Yes Bank Limited
14	RBL Bank Ltd.
15	Standard Chartered Bank
16	Indian Overseas Bank
17	Kotak Mahindra Bank Limited
18	Federal Bank Limited

Place:  
Date:

WCM Dept. / 3<sup>rd</sup> Floor, 24 Bldg. / BHEL, Trichy-14

Signature of Authorized Signatory  
with seal & full address  
Page 33 of 44

**NAME OF WORK: SERVICE CONTRACT FOR PART PROCESSING OF LOOSE TUBE BENDS AS PER BHEL DRAWING AT BHEL PREMISES FOR ONE YEAR.**

**Tender Enq. No.: 9472600019/ 29-04-2026; GeM Bid No.: GEM/2026/B/7449412**

**ANNEXURE - 19**

**Conflict of Interest among Bidders/ Agents**

**(To be typed and submitted in the Letterhead of the Company/Firm of Bidder failing which the offer of Bidder is liable to be summarily rejected)**

---

To,  
(Write Name & Address of Officer of BHEL inviting the Tender)

Dear Sir,  
**Sub: Declaration regarding Conflict of Interest**

Ref: 1) GeM Bid No.: GEM/2026/B/7449412  
2) All other pertinent issues till date

**Treatment of cases regarding conflict of interest:**

The bidder notes that a conflict of interest would said to have occurred in the tender process and execution of the resultant contract, in case of any of the following situations:

- i. If its personnel have a close personal, financial, or business relationship with any personnel of BHEL who are directly or indirectly related to the procurement or execution process of the contract, which can affect the decision of BHEL directly or indirectly;
- ii. The bidder (or his allied firm) provided services for the need assessment/ procurement planning of the Tender process in which it is participating;
- iii. Procurement of goods directly from the manufacturers/ suppliers shall be preferred. However, if the OEM/ Principal insists on engaging the services of an agent, such agent shall not be allowed to represent more than one manufacturer/ supplier in the same tender. Moreover, either the agent could bid on behalf of the manufacturer/ supplier or the manufacturer/ supplier could bid directly but not both. In case bids are received from both the manufacturer/ supplier and the agent, bid received from the agent shall be ignored. However, this shall not debar more than one Authorized distributor (with/ or without the OEM) from quoting equipment manufactured by an Original Equipment Manufacturer (OEM) in procurements under a Proprietary Article Certificate.
- iv. A bidder participates in more than one bid in this tender process. Participation in any capacity by a Bidder (including the participation of a Bidder as a partner/ JV member or sub-contractor in another bid or vice-versa) in more than one bid shall result in the disqualification of all bids in which he is a party. However, this does not limit the participation of an entity as a sub-contractor in more than one bid if he is not bidding independently in his own name or as a member of a JV.

**Declaration**

I/We, hereby declares that I/we have read and understood the above aspects, and the I/we confirms that such conflict of interest does not exist and undertakes that I/we will not enter into any illegal or undisclosed agreement or understanding, whether formal or informal with other Bidder{s), in this regard. This applies in particular to prices, specifications, certifications, subsidiary contracts, submission or non-submission of bids or any other actions to restrict competitiveness or to introduce cartelization in the bidding process. **In case, the I am / We are found having indulged in above activities, the same will be considered as a violation of the tender conditions, and suitable action shall be taken by BHEL as per extant policies/ guidelines.**

Yours faithfully,

(Signature, Date & Seal of Authorized Signatory of the Bidder)

Place:  
Date:

Signature of Authorized Signatory  
with seal & full address  
WCM Dept. / 3<sup>rd</sup> Floor, 24 Bldg. / BHEL, Trichy-14  
Page 34 of 44

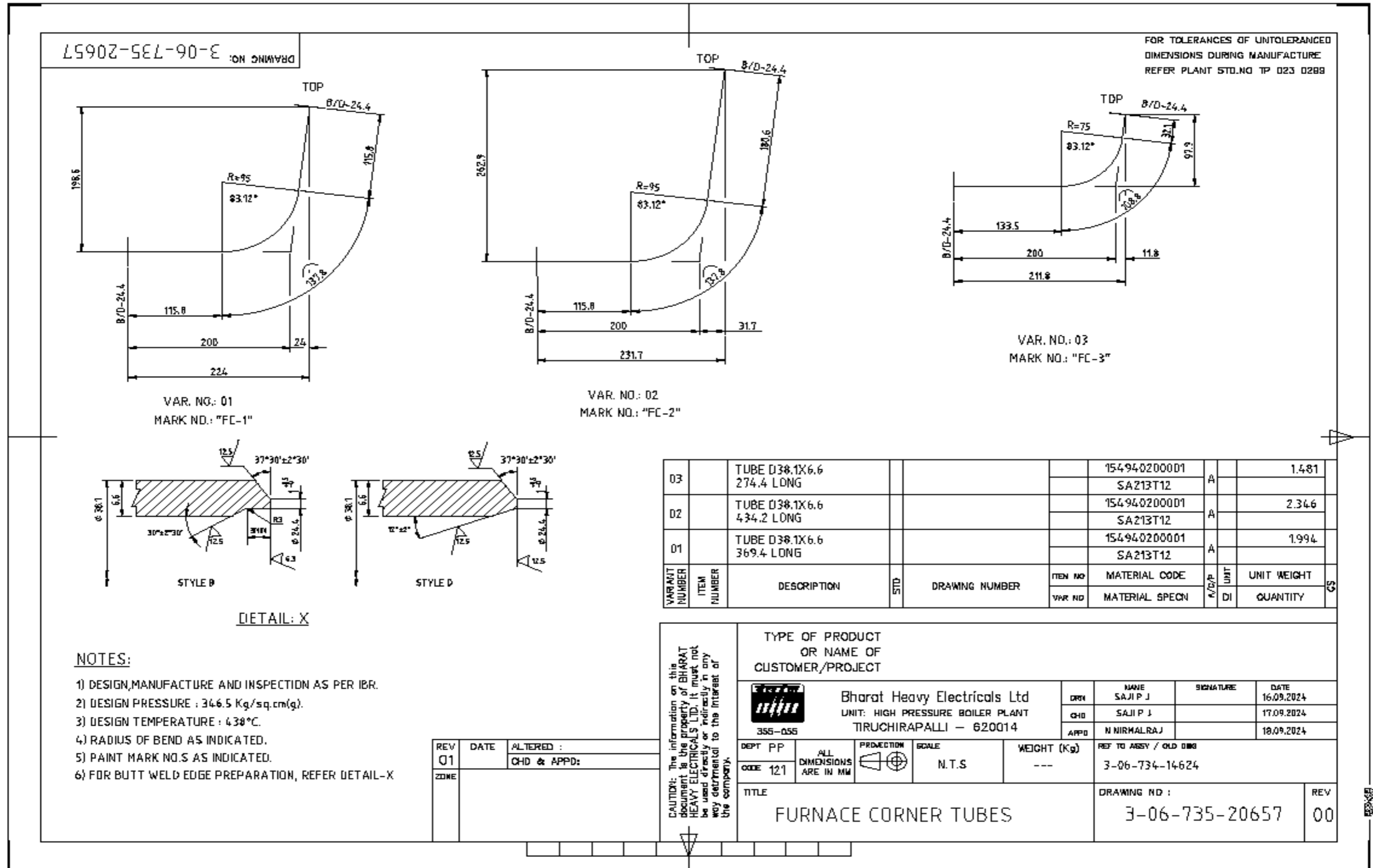

FOR TOLERANCES OF UNTOLERANCED DIMENSIONS DURING MANUFACTURE REFER PLANT STD.NO TP 023 0288

VAR. NO.: 01  
MARK NO.: "FC-1"

VAR. NO.: 02  
MARK NO.: "FC-2"

VAR. NO.: 03  
MARK NO.: "FC-3"

**NOTES:**

- 1) DESIGN,MANUFACTURE AND INSPECTION AS PER IBR.
- 2) DESIGN PRESSURE : 346.5 Kg/sq.cm(g).
- 3) DESIGN TEMPERATURE : 438°C.
- 4) RADIUS OF BEND AS INDICATED.
- 5) PAINT MARK NO.S AS INDICATED.
- 6) FOR BUTT WELD EDGE PREPARATION, REFER DETAIL-X

REV	DATE	ALTERED :
01		CHD & APPD:
ZONE		

CAUTION: The information on this document is the property of BHARAT HEAVY ELECTRICALS LTD. It must not be used directly or indirectly in any way detrimental to the interest of the company.	TYPE OF PRODUCT OR NAME OF CUSTOMER/PROJECT			
	Bharat Heavy Electricals Ltd UNIT: HIGH PRESSURE BOILER PLANT TIRUCHIRAPALLI - 620014		DRN SAJIP J	SIGNATURE DATE 16.09.2024
	DEPT PP CODE 121		CHD SAJIP J	APPD N NIRMALRAJ 18.09.2024
	ALL DIMENSIONS ARE IN MM	PROJECTION 	SCALE N.T.S	WEIGHT (Kg) ---
TITLE FURNACE CORNER TUBES			REF TO ASSY / OLD DWG 3-06-734-14624	
			DRAWING NO : 3-06-735-20657	REV 00



DRAWING NO: 3-06-655-20449

FOR TOLERANCES OF UNTOLERANCED DIMENSIONS DURING MANUFACTURE REFER PLANT STD.NO TP 023 0298

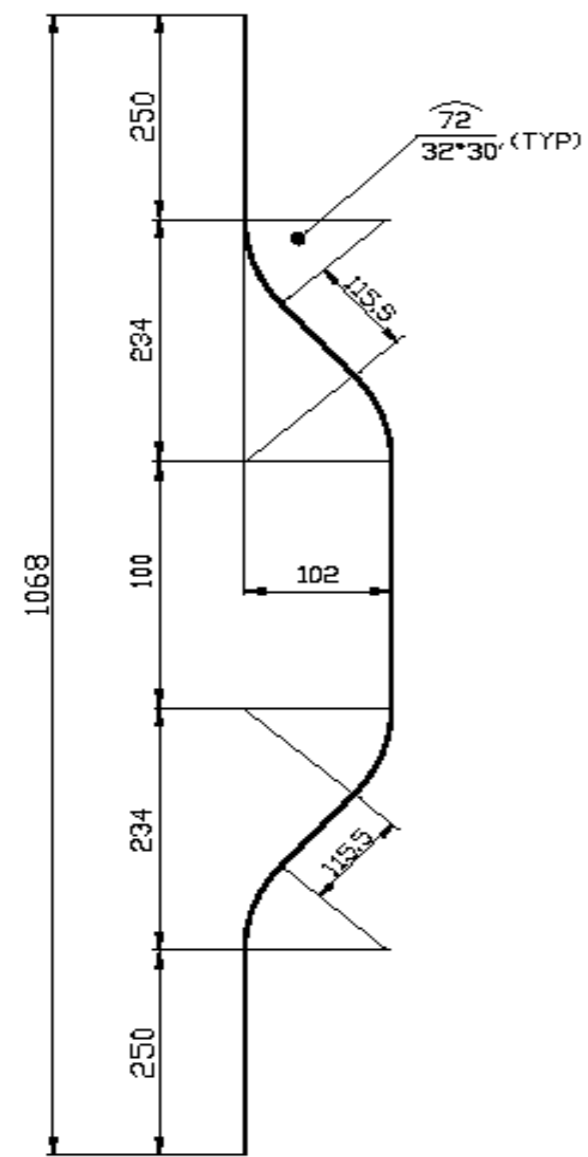

**NOTES: -**

1. DESIGN,MANUFACTURE & INSPECTION AS PER IBR.
2. DESIGN PRESSURE : 216 KG/SQ.CM (g)
3. DESIGN TEMPERATURE : 400° C
4. RADIUS OF BEND : 127
5. EDGE PREPARATION NEED NOT BE DONE AT SHOP.
6. TUBE ENDS TO BE CAPPED BEFORE DESPATCH.

VARIANT NUMBER	ITEM NUMBER	DESCRIPTION	STD	DRAWING NUMBER	ITEM NO	MATERIAL CODE	UNIT	UNIT WEIGHT	CS
		RIFLED TUBE D51 X 7.1 ; 1119			154870590001	SA 210 Gr C	A	9.099	
					VAR NO	MATERIAL SPECN	D1	QUANTITY	

<p>CAUTION: The information on this document is the property of BHARAT HEAVY ELECTRICALS LTD. It must not be used directly or indirectly in any way detrimental to the interest of the company.</p>		TYPE OF PRODUCT OR NAME OF CUSTOMER/PROJECT					
		Bharat Heavy Electricals Ltd UNIT: HIGH PRESSURE BOILER PLANT TIRUCHIRAPALLI - 620014		DRN	NAME	SIGNATURE	DATE
				CHD	RAJAGOPALAN.T		19.06.24
				APPD	R.D.JAYAN		19.06.24
DEPT PP	ALL DIMENSIONS ARE IN MM	SCALE	WEIGHT (Kg)	REF TO ASSY / OLD DWG			
CODE 121		N.T.S	9.099				
TITLE				DRAWING NO :		RE	
WALL BLOWER BEND				3-06-655-20449		00	

CORPORATE DRG ID:TP-DG-3-06-655-20449/00CORPOR

Place:  
Date:

WCM Dept. / 3<sup>rd</sup> Floor, 24 Bldg. / BHEL, Trichy-14

Signature of Authorized Signatory  
with seal & full address  
Page 37 of 44

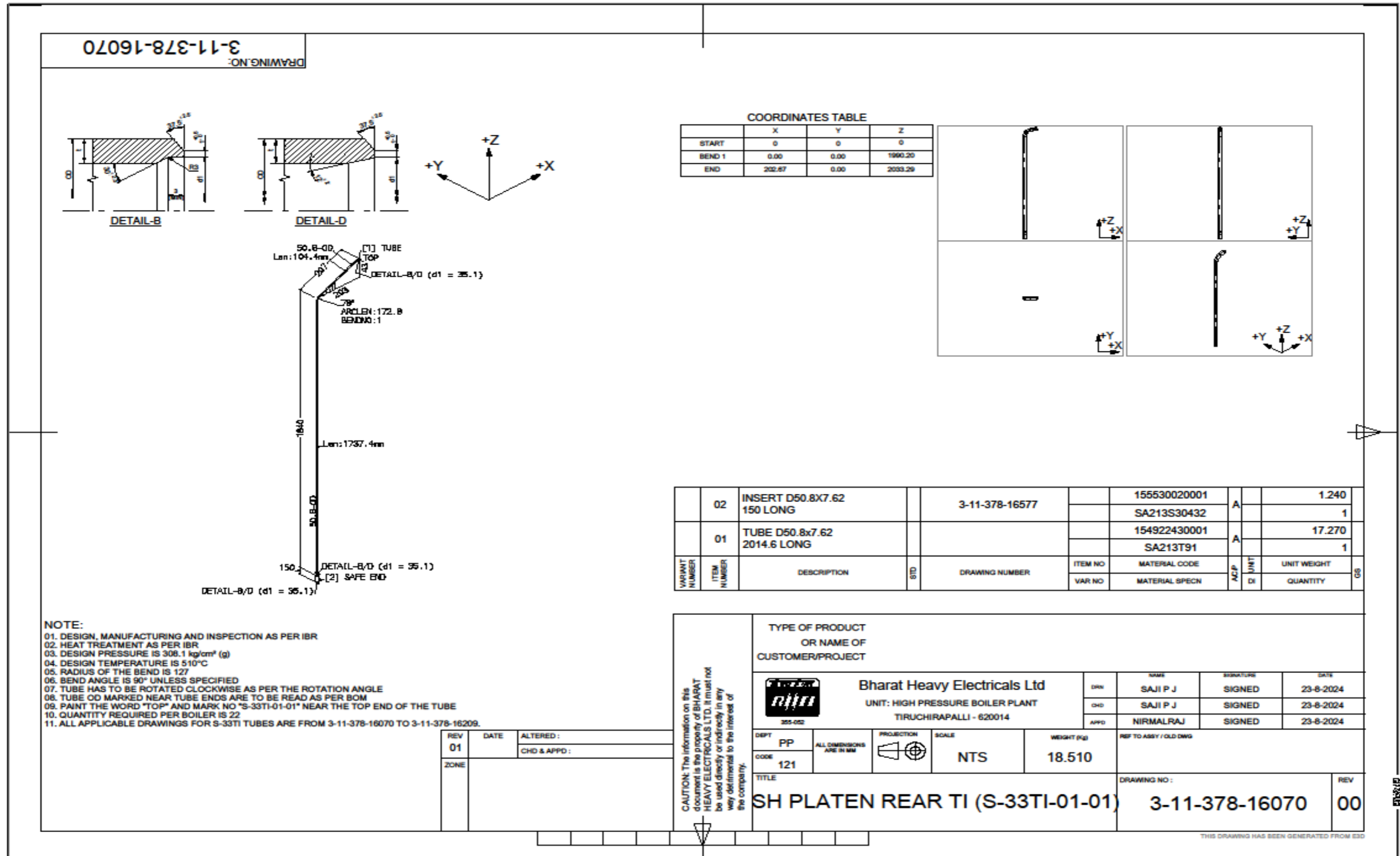

Place:  
Date:

Signature of Authorized Signatory  
with seal & full address  
WCM Dept. / 3<sup>rd</sup> Floor, 24 Bldg. / BHEL, Trichy-14  
Page 38 of 44

NAME OF WORK: SERVICE CONTRACT FOR PART PROCESSING OF LOOSE TUBE BENDS AS PER BHEL DRAWING AT BHEL PREMISES FOR ONE YEAR.

Tender Enq. No.: 947260019/ 29-04-2026; GeM Bid No.: GEM/2026/B/7449412

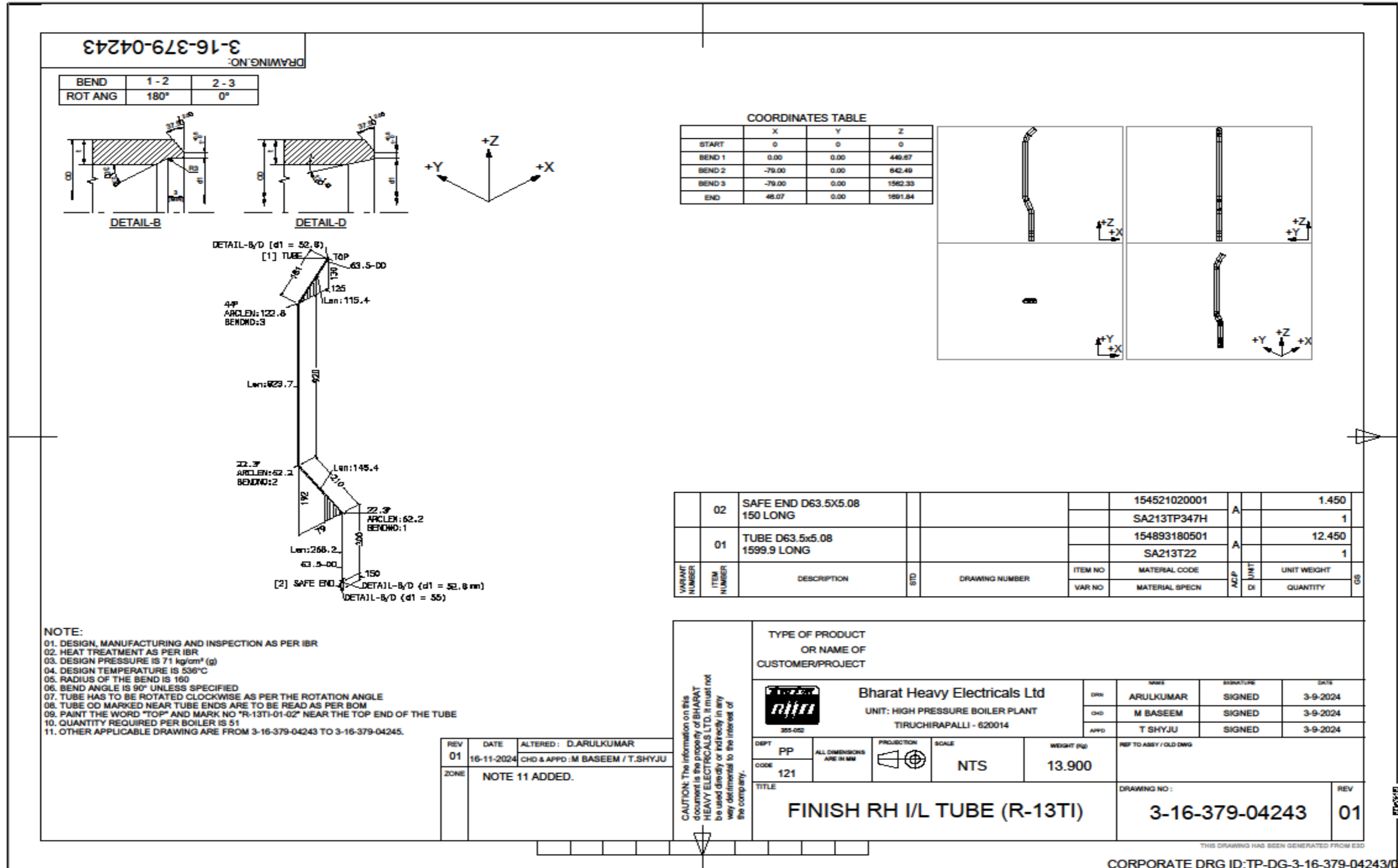

Place:  
Date:

WCM Dept. / 3<sup>rd</sup> Floor, 24 Bldg. / BHEL, Trichy-14

Signature of Authorized Signatory  
with seal & full address  
Page 39 of 44

NAME OF WORK: SERVICE CONTRACT FOR PART PROCESSING OF LOOSE TUBE BENDS AS PER BHEL DRAWING AT BHEL PREMISES FOR ONE YEAR.

Tender Enq. No.: 9472600019/ 29-04-2026; GeM Bid No.: GEM/2026/B/7449412

DRAWING NO: 3-11-074-17247

BEND	1-2	2-3	3-4	4-5
ROT ANG	180°	270°	180°	0°

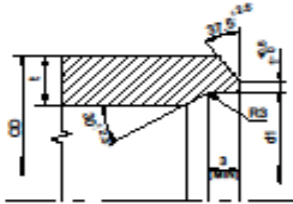
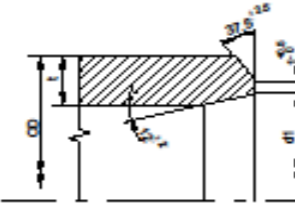

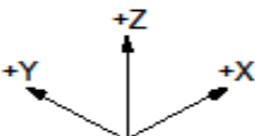

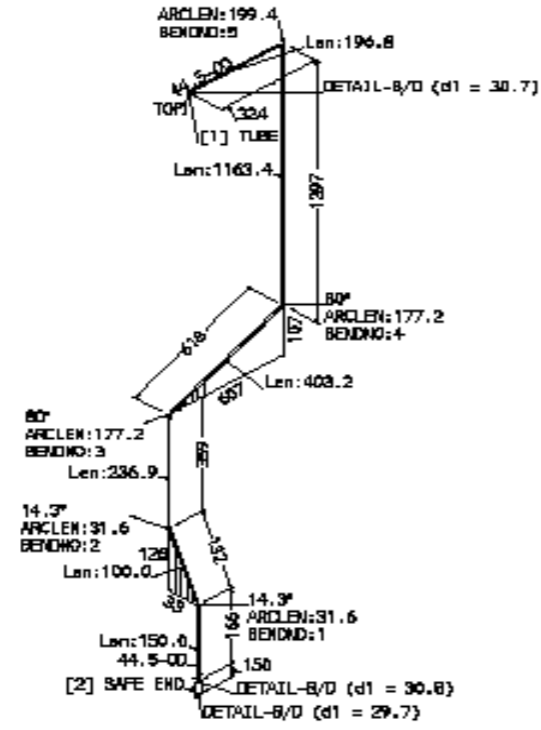

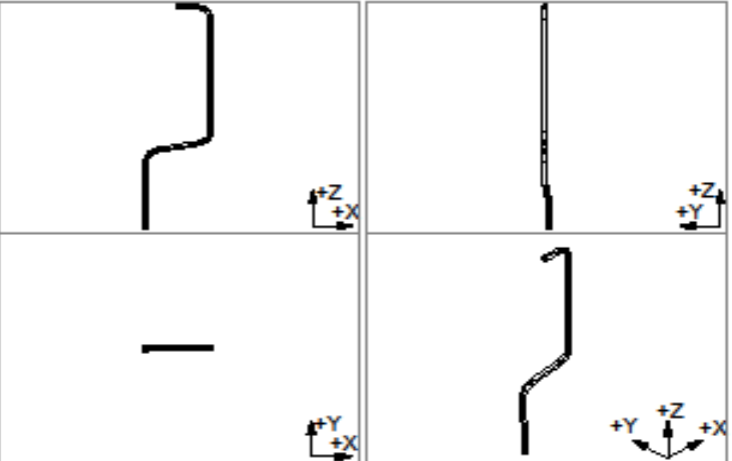

NOTE:  
 01. DESIGN, MANUFACTURING AND INSPECTION AS PER IBR  
 02. HEAT TREATMENT AS PER IBR  
 03. DESIGN PRESSURE IS 300.4 kg/cm<sup>2</sup> (g)  
 04. DESIGN TEMPERATURE IS 546°C  
 05. RADIUS OF THE BEND IS 127  
 06. BEND ANGLE IS 90° UNLESS SPECIFIED  
 07. TUBE HAS TO BE ROTATED CLOCKWISE AS PER THE ROTATION ANGLE  
 08. TUBE OD MARKED NEAR TUBE ENDS ARE TO BE READ AS PER BOM  
 09. PAINT THE WORD "TOP" AND MARK NO "S-39TI-02-11" NEAR THE TOP END OF THE TUBE  
 10. QUANTITY REQUIRED PER BOILER IS 70  
 11. ALL APPLICABLE DRAWINGS FOR S-39TI TUBES ARE FROM 3-11-074-17226 TO 3-11-074-17434.

	X	Y	Z
START	0	0	0
BEND 1	0.00	0.00	315.90
BEND 2	0.00	32.50	443.54
BEND 3	0.00	32.50	808.04
BEND 4	807.00	32.50	910.08
BEND 5	807.00	32.50	2307.00
END	283.20	32.50	2307.00



VAR NO	ITEM NO	DESCRIPTION	STD	DRAWING NUMBER	ITEM NO	MATERIAL CODE	AC/P	UNIT	UNIT WEIGHT	QS
	02	SAFE END D44.45X7.11 150 LONG				155521780001	A		1.070	
						SA213TP347H			1	
	01	TUBE D44.45x6.6 2867.8 LONG				154922539000	A		18.670	
						SA213T91			1	

CAUTION: The information on this document is the property of BHARAT HEAVY ELECTRICALS LTD. It must not be used directly or indirectly in any way detrimental to the interest of the company.

TYPE OF PRODUCT OR NAME OF CUSTOMER/PROJECT		Bharat Heavy Electricals Ltd		DRN	T.SHYJU	SIGNATURE	SIGNED	DATE	13-9-2024
		UNIT: HIGH PRESSURE BOILER PLANT		CHD	R.SAI KUMAR	SIGNATURE	SIGNED	DATE	13-9-2024
		TIRUCHIRAPALLI - 620014		APPD	N.NIRMAL RAJ	SIGNATURE	SIGNED	DATE	13-9-2024
DEPT	PP	ALL DIMENSIONS ARE IN MM	PROJECTION	SCALE	WEIGHT P/G		REF TO ASSY / OLD DWG		
CODE	121			NTS	19.740				
TITLE							DRAWING NO :		REV
BENT TUBE(S-39TI-02-11)							3-11-074-17247		01

THIS DRAWING HAS BEEN GENERATED FROM E3D

CORPORATE DRG ID:TP-DG-3-11-074-17247/01CORI

Place:  
Date:

WCM Dept. / 3<sup>rd</sup> Floor, 24 Bldg. / BHEL, Trichy-14

Signature of Authorized Signatory  
with seal & full address  
Page 40 of 44

**NAME OF WORK: SERVICE CONTRACT FOR PART PROCESSING OF LOOSE TUBE BENDS AS PER BHEL DRAWING AT BHEL PREMISES FOR ONE YEAR.**

**Tender Enq. No.: 947260019/ 29-04-2026; GeM Bid No.: GEM/2026/B/7449412**

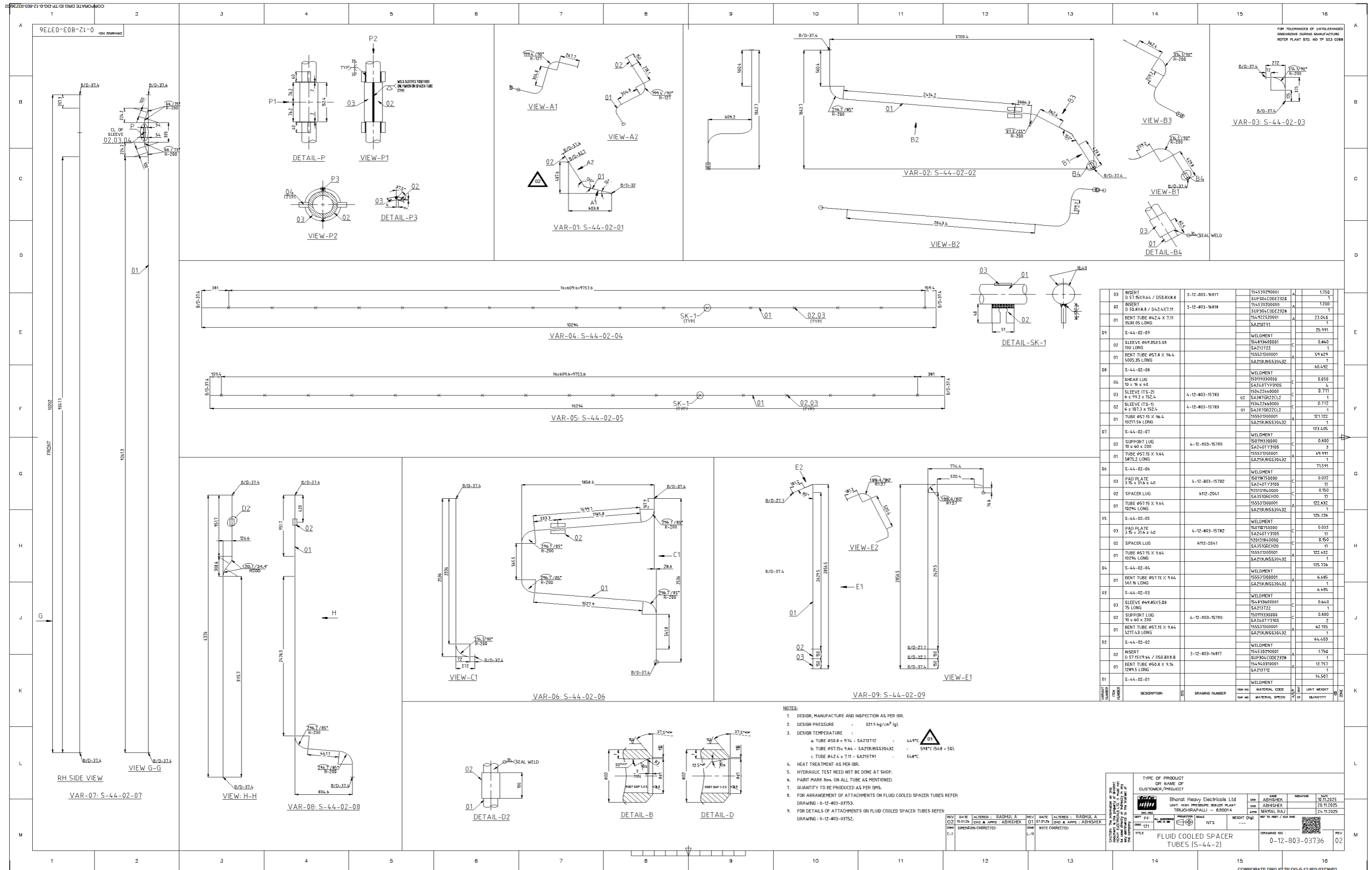

Place:  
Date:

Signature of Authorized Signatory  
with seal & full address  
WCM Dept. / 3<sup>rd</sup> Floor, 24 Bldg. / BHEL, Trichy-14  
Page 41 of 44

NAME OF WORK: SERVICE CONTRACT FOR PART PROCESSING OF LOOSE TUBE BENDS AS PER BHEL DRAWING AT BHEL PREMISES FOR ONE YEAR.

Tender Enq. No.: 9472600019/ 29-04-2026; GeM Bid No.: GEM/2026/B/7449412

**3-06-400-20766**  
DRAWING NO.

BEND	1-2	2-3	3-4	4-5	5-6
ROT ANG	172.49°	208.49°	0°	208.72°	174.45°

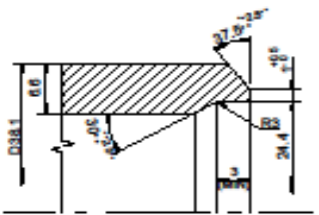
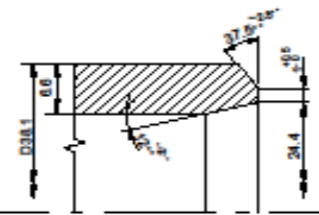

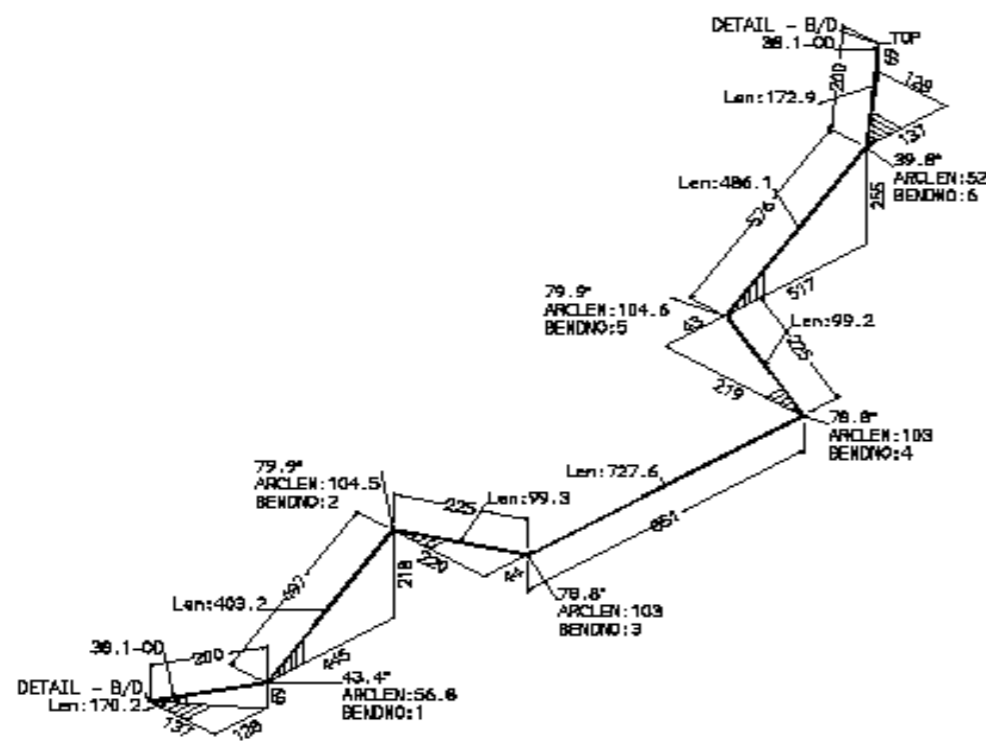

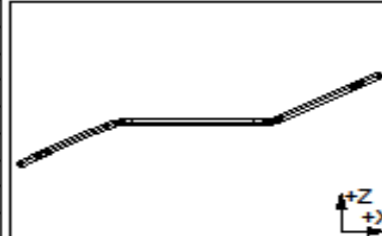
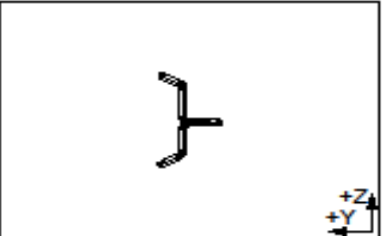

**COORDINATES TABLE**

	X	Y	Z
START	0	0	0
BEND 1	127.97	-137.23	69.23
BEND 2	573.41	-137.23	287.08
BEND 3	617.04	-356.56	287.08
BEND 4	1487.78	-356.56	287.08
BEND 5	1511.41	-137.23	287.08
BEND 6	2027.97	-137.23	542.01
END	2185.20	-9.26	611.24

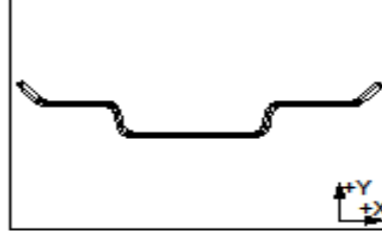
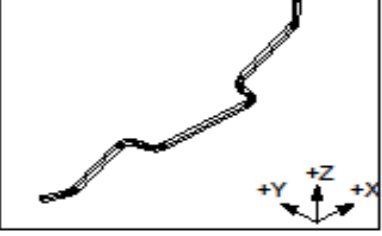
ITEM NUMBER	DESCRIPTION	STD	DRAWING NUMBER	ITEM NO	MATERIAL CODE	ACP	UNIT	UNIT WEIGHT	QTY
	TUBE D38.1x6.6 2682.7 LONG				154940200001 SA213T12	A		14.500	
				VAR NO	MATERIAL SPECN		DI	QUANTITY	

**NOTE:**

01. DESIGN, MANUFACTURING AND INSPECTION AS PER IBR
02. HEAT TREATMENT AS PER IBR
03. DESIGN PRESSURE IS 346.5 kg/cm<sup>2</sup> (g)
04. DESIGN TEMPERATURE IS 438°C
05. RADIUS OF THE BEND IS 75
06. BEND ANGLE IS 90° UNLESS SPECIFIED
07. TUBE HAS TO BE ROTATED CLOCKWISE AS PER THE ROTATION ANGLE
08. TUBE OD MARKED NEAR TUBE ENDS ARE TO BE READ AS PER BOM
09. PAINT THE WORD "TOP" AND MARK NO "F-WB-3A-9" NEAR THE TOP END OF THE TUBE
10. QUANTITY REQUIRED PER BOILER IS 2

REV	DATE	ALTERED :
01		CHD & APPD :
ZONE		

CAUTION: The information on this document is the property of BHARAT HEAVY ELECTRICALS LTD. It must not be used directly or indirectly in any way detrimental to the interest of the company.

TYPE OF PRODUCT OR NAME OF CUSTOMER/PROJECT			
 <b>Bharat Heavy Electricals Ltd</b> UNIT: HIGH PRESSURE BOILER PLANT TIRUCHIRAPALLI - 620014			
DEPT	PP	PROJECTION	SCALE
CODE	121	ALL DIMENSIONS ARE IN MM	NTS
TITLE	<b>BENT TUBE (F-WB)</b>		
WEIGHT (KG)	14.500	REF TO ASSY / OLD DWG	
DRAWING NO :	<b>3-06-400-20766</b>		
REV	<b>00</b>		

Signature of Authorized Signatory  
with seal & full address

Place:  
Date:

WCM Dept. / 3<sup>rd</sup> Floor, 24 Bldg. / BHEL, Trichy-14

Page 42 of 44

THIS DRAWING HAS BEEN GENERATED FROM E3D

NAME OF WORK: SERVICE CONTRACT FOR PART PROCESSING OF LOOSE TUBE BENDS AS PER BHEL DRAWING AT BHEL PREMISES FOR ONE YEAR.

Tender Enq. No.: 9472600019/ 29-04-2026; GeM Bid No.: GEM/2026/B/7449412

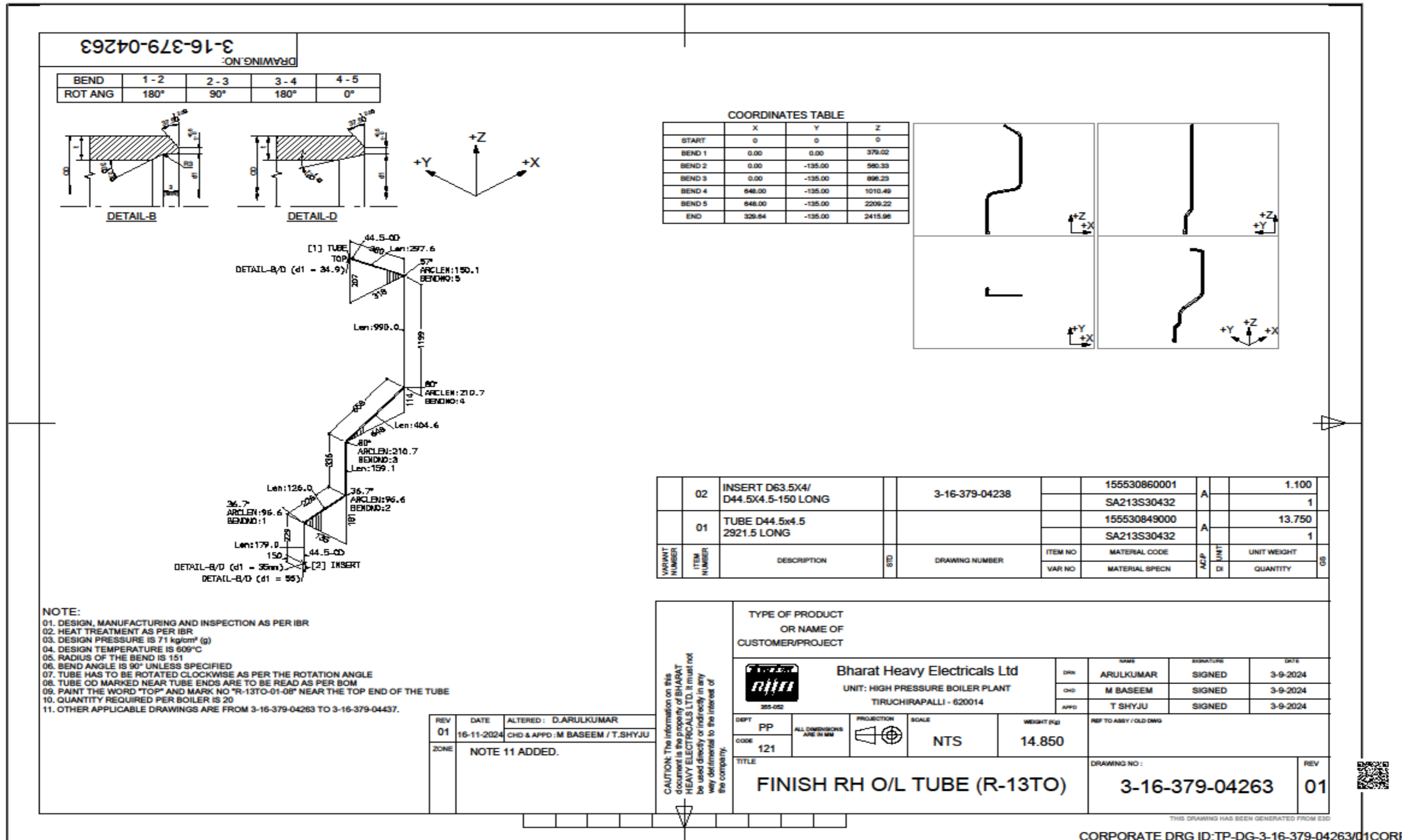

Place:  
Date:

WCM Dept. / 3<sup>rd</sup> Floor, 24 Bldg. / BHEL, Trichy-14

Signature of Authorized Signatory  
with seal & full address  
Page 43 of 44

3-19-804-07751

BEND	1 - 2	2 - 3
ROT ANG	91.61°	147.96°

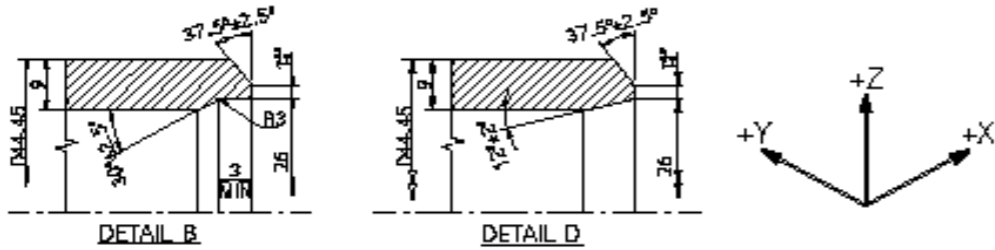

COORDINATES TABLE

	X	Y	Z
START	0	0	0
BEND 1	0.00	0.00	162.12
BEND 2	0.00	-140.00	366.16
BEND 3	-3432.00	-140.00	670.84
END	-5432.00	-140.00	1000.00

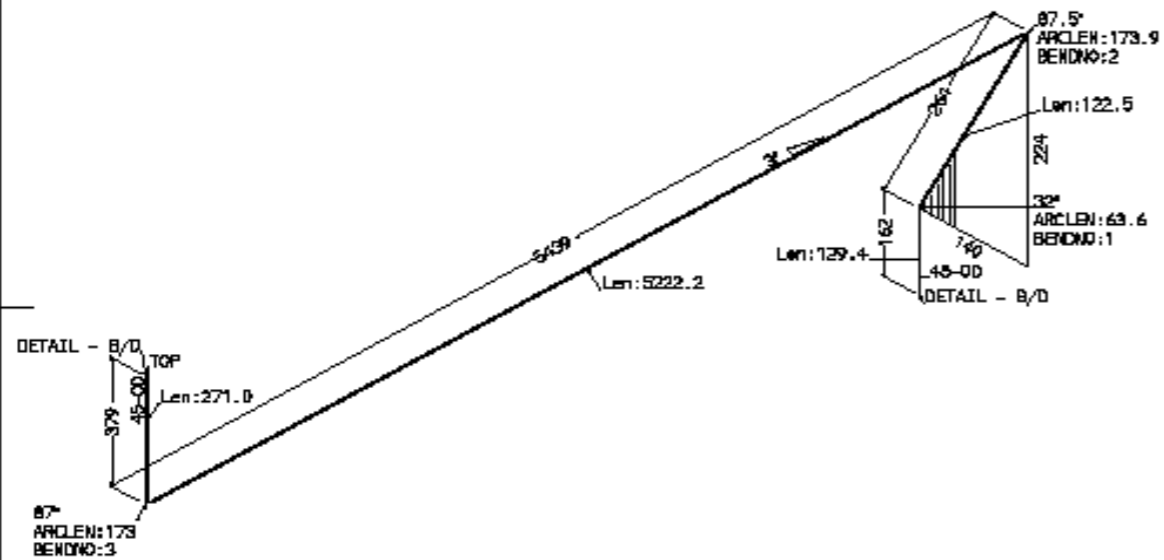
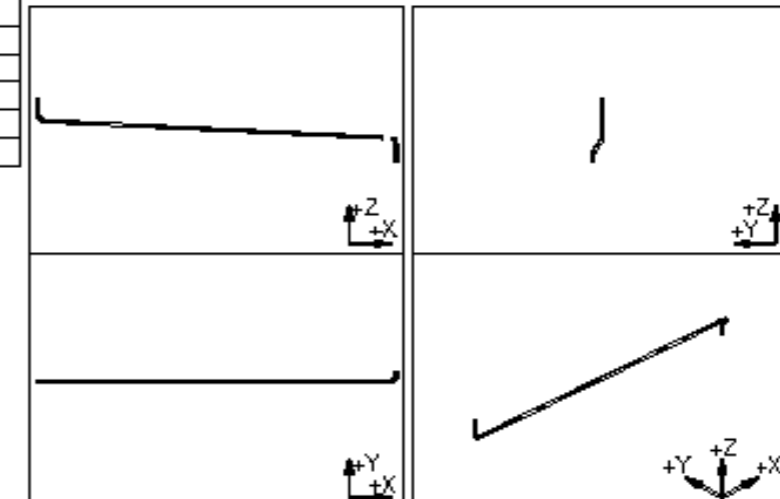

QUANTITY	DESCRIPTION	UNIT	DRAWING NUMBER	ITEM NO	MATERIAL CODE	UNIT	UNIT WEIGHT
50.900	TUBE D44.45x9 6155.9 LONG				154872510201	A	50.900
					SA210GRC		
				VAR NO	MATERIAL SPECN	Q3	QUANTITY

- NOTE:
- DESIGN, MANUFACTURING AND INSPECTION AS PER IBR
  - HEAT TREATMENT AS PER IBR
  - DESIGN PRESSURE IS 342.8 kg/cm<sup>2</sup>
  - DESIGN TEMPERATURE IS 358 °C
  - RADIUS OF THE BEND IS 114
  - BEND ANGLE IS 90° UNLESS SPECIFIED
  - TUBE HAS TO BE ROTATED CLOCKWISE AS PER THE ROTATION ANGLE
  - TUBE OD MARKED NEAR TUBE ENDS ARE TO BE READ AS PER BOM
  - PAINT THE WORD "TOP" AND MARK NO "E-06A-01-10" NEAR THE TOP END OF THE TUBE
  - QUANTITY REQUIRED PER BOILER IS 1

REV	DATE	ALTERED BY	CHK & APPD
01			

CAUTION! The information on this document is the property of BHARAT HEAVY ELECTRICALS LTD. It must not be used directly or indirectly in any way detrimental to the interest of the company.

TYPE OF PRODUCT OR NAME OF CUSTOMER/PROJECT

Bharat Heavy Electricals Ltd  
UNIT: HIGH PRESSURE BOILER PLANT  
TIRUCHIRAPALLI - 620014

DATE	SIGNATURE	DATE	SIGNATURE
26/10/2023	NIRMAI RAJ	26/10/2023	RAJAGDIPALAN
26/10/2023	NIRMAI RAJ	26/10/2023	RAJAGDIPALAN

DEPT: PP ALL DIMENSIONS ARE IN MM PRECISION: NTS WEIGHT (KG): 50.900

TITLE: BENT TUBE (E-06A-01-10) DRAWING NO: 3-19-804-07751 00

THIS DRAWING HAS BEEN GENERATED FROM PDMS

Place: \_\_\_\_\_ Signature of Authorized Signatory  
Date: \_\_\_\_\_ with seal & full address  
WCM Dept. / 3<sup>rd</sup> Floor, 24 Bldg. / BHEL, Trichy-14 Page 44 of 44

**NAME OF WORK: SERVICE CONTRACT FOR PART PROCESSING OF LOOSE TUBE BENDS AS PER BHEL DRAWING AT BHEL PREMISES FOR ONE YEAR.**

**Tender Enq. No.: 9472600019/ 29-04-2026; GeM Bid No.: GEM/2026/B/7449412**

# **General Conditions of Contract (GCC) for Work Order- Services**

---

## **TABLE OF CONTENTS**

### **1. Chapter-1: General Instructions to Tenderers**

- 1.1. Despatch Instructions
- 1.2. Submission of Tenders
- 1.3. Qualification of Tenderers
- 1.4. Evaluation of Bids
- 1.5. Data to be enclosed
- 1.6. Authorization and Attestation
- 1.7. Earnest Money Deposit
- 1.8. Security Deposit
- 1.9. Return of Security Deposit
- 1.10. Bank Guarantee
- 1.11. Validity of offer
- 1.12. Execution of Contract Agreement
- 1.13. Rejection of Tender and other Conditions
- 1.14. Intimation of change of name/re-constitution of the Organization

### **2. Chapter-2**

- 2.1. Definitions
- 2.2. Law Governing Contract and Court Jurisdiction
- 2.3. Issue of Notice
- 2.4. Use of Land
- 2.5. Commencement of Work
- 2.6. Measurement of Work and Mode of Payment
- 2.7. Rights of BHEL
- 2.8. Responsibilities of Contractor in respect of Local Laws, Employment of Workers etc.
- 2.9. Progress Monitoring, Monthly Review and Performance Evaluation
- 2.10. Time of Completion
- 2.11. Extension of Time for Completion
- 2.12. Insurance
- 2.13. Strikes & Lockout
- 2.14. QUANTITY VARIATION
- 2.15. Force Majeure
- 2.16. Settlement of Disputes
- 2.17. Closing of Contracts
- 2.18. Suspension of Business Dealings
- 2.19. Limitation on Liability
- 2.20. Cartel Formation
- 2.21. Fraud Prevention Policy
- 2.22. Order of Precedence
- 2.23. Other Issues

Place:  
Date:

WCM Dept. / 3<sup>rd</sup> Floor, 24 Bldg. / BHEL, Trichy-14  
Regd. Office: BHEL HOUSE, Siri Fort, New Delhi – 110 049

Signature of Authorized Signatory  
with seal & full address

**NAME OF WORK: SERVICE CONTRACT FOR PART PROCESSING OF LOOSE TUBE BENDS AS PER BHEL DRAWING AT BHEL PREMISES FOR ONE YEAR.**

**Tender Enq. No.: 9472600019/ 29-04-2026; GeM Bid No.: GEM/2026/B/7449412**

**CHAPTER -1**

**1. GENERAL INSTRUCTION TO TENDERERS**

**1.1. DESPATCH INSTRUCTION**

- i. The General Conditions of Contract form part of the Tender specifications. **For this tender, bidders shall use electronic Signature viz Digital Signature Certificate while uploading the tender documents on the GeM portal.** The information furnished shall be complete by itself. The tenderer is required to furnish all the details and other documents as required in the following pages.
- ii. Tenderers are advised to study all the tender documents carefully. Any submission of tender by the tenderer shall be deemed to have been done after careful study and examination of the tender documents and with the full understanding of the implications thereof. Should the tenderers have any doubt about the meaning of any portion of the Tender Specification or find discrepancies or omissions in the drawings or the tender documents issued are incomplete or shall require clarification on any of the technical aspect, the scope of work etc., he shall at once, contact the authority inviting the tender well in time (so as not to affect last date of submission) for clarification before the submission of the tender. Tenderer's request for clarifications shall be with reference to Sections and Clause numbers given in the tender documents. The specifications and terms and conditions shall be deemed to have been accepted by the tenderer in his offer. Non-compliance with any of the requirements and instructions of the tender enquiry may result in the rejection of the tender.
- iii. Integrity pact (IP) shall be applicable for all tenders / contracts if indicated in NIT. This IP shall be issued as part of the Tender documents and shall be submitted by the bidder along with Techno-commercial bid duly filled, signed and stamped by the authorized signatory who signs the bid. Entering into this pact shall be a preliminary qualification.

**1.2. SUBMISSION OF TENDERS**

- 1.2.1. The tenderers must submit their tenders to Officer inviting tender as per instructions in the NIT. Tenders shall be submitted through GeM portal as per instruction in NIT.
- 1.2.2. Tenderers to upload offers well in advance in order to avoid last minute congestion in GeM website. However, after submission of the tender, the tenderer can re-submit revised tender but before due date and time of submission of tender as notified.
- 1.2.3. Tenders shall be opened by Officer of BHEL at the time and date as specified in the NIT. For this tender, bidders may attend through online mode, if provisions are available in GeM portal.
- 1.2.4. Tenderers whose bids are found techno commercially qualified shall be notified through GeM system about the date and time of opening of the Price Bids. BHEL's decision in this regard shall be final and binding.
- 1.2.5. The information given in the tender documents is for general guidance and shall not be construed as contractually binding on BHEL/ Owner. All relevant site data/ information as may be necessary for bidding shall have to be obtained/ collected by the Tenderer.
- 1.2.6. The Tenderers are advised to physically visit the site to acquaint and satisfy themselves about the weather conditions, working culture in the area, socio- political environment, safety & security aspects, law & order situation, law of the land, transportation routes, various distances, surroundings of plant/ project premises together with all statutory, obligatory, mandatory requirements of various authorities and obtain for themselves all necessary information as to the risks, contingencies and all other circumstances, which may influence or affect the discharge of various obligations under the Contract during contract period including extended period (if any).
- 1.2.7. The submission of bid will tantamount to due diligence having been done and it shall be deemed that:
  - a) the Tenderer has obtained all necessary information as to risks, contingencies and other circumstances which may influence or affect the Works
  - b) the Tenderer accepts total responsibility for having foreseen all difficulties and costs of successfully completing the Works

Place:  
Date:

Signature of Authorized Signatory  
with seal & full address

**NAME OF WORK: SERVICE CONTRACT FOR PART PROCESSING OF LOOSE TUBE BENDS AS PER BHEL DRAWING AT BHEL PREMISES FOR ONE YEAR.**

**Tender Enq. No.: 9472600019/ 29-04-2026; GeM Bid No.: GEM/2026/B/7449412**

- c) the Tenderer accepts that, the Contract Price shall not be adjusted to take account of any unforeseeable or unforeseen difficulties or costs and the Tenderer shall not raise any claims/ disputes against BHEL and/ or Owner at later date in any manner whatsoever.

**1.3. QUALIFICATION OF TENDERERS**

- i. Only tenderers who have previous experience in the work of the nature and description detailed in the Notice Inviting Tender and/or tender specification are expected to quote for this work duly detailing their experience along with offer.
- ii. Offers from tenderers who do not have proven and established experience in the field shall not be considered.
- iii. The offers of the bidders who are on the debarred list shall be rejected. Further, offer of the bidders, who engage the services of the debarred firms or associated with the debarred firm, for present bid, shall also be rejected. The list of debarred firms is available on BHEL web site [www.bhel.com](http://www.bhel.com).
- iv. Offers from tenderers who do not comply with the latest guidelines of Ministry/Commissions of Govt. of India shall not be considered.

**1.4 EVALUATION OF BIDS**

- i. Technical Bids submitted by the tenderer will be opened first and evaluated for fulfilling the Pre- Qualification criteria and other conditions in NIT/Tender documents, based on documentary evidences submitted along with the offer.
- ii. In case the same qualifying experience is claimed by more than one agency, then:
  - a. The agency who has executed the work as per documentary evidence submitted shall only be qualified. Scope of qualifying work should be totally with the agency who has executed and in case it is only labour and consumables without T&P, then the credentials of execution is assigned to the first agency and not to the agency who has executed only as labour supply contractor. Further, BHEL reserves the right to ask for any other proof for the said job.
  - b. However, if the same is on account of subletting, part of scope by one agency to another agency in a project of BHEL, experience of both the agencies may be considered for the sublet portion of the work provided subletting has been done with the approval of BHEL.
- iii. In case the qualifying experience is claimed by bidder is based on 'Work Order' and 'Experience Certificates' from any organization other than BHEL (main agency), then it shall be the responsibility of the bidder to submit (in addition to the experience certificate from main agency) relevant certificate regarding qualifying experience from the end Customer or the Turnkey-Contractor (if any) who has awarded the work to main agency, as a proof for having executed subject qualifying work. BHEL reserves the right to ask for any other proof for the said job.
- iv. Assessing Bidder's Capacity for executing the current tender shall be as per Notice Inviting Tender.
- v. Price Bids of shortlisted bidders shall only be opened through the electronic price bid opening with/without Reverse Auction, at the discretion of BHEL. Unless specified otherwise in the tender, the L1 bidder amongst all the shortlisted bidders shall be considered for award. However, the L1 bidder shall have no claim on the award & BHEL reserves the right to award the tender at its sole discretion.
- vi. Price Bids of unqualified bidders shall not be opened. Reasons for rejection shall be intimated in due course either through system generated e-mail or through letter/e-mail after award to successful bidder.
- vii. Bidders are advised to also refer to clause no 2.9.4 regarding evaluation of their performance in ongoing projects.

**1.5 DATA TO BE ENCLOSED**

Full information shall be given by the tenderer in respect of the following. Non- submission of this information may lead to rejection of the offer.

**i) INCOME TAX PERMANENT ACCOUNT NUMBER**

Certified copies of Permanent Account Numbers as allotted by Income Tax Department for the Company/Firm/Individual Partners etc. shall be furnished along with tender.

- ii) An attested copy of the Power of Attorney, in case the tender is signed by an individual other than the sole proprietor.

Place:  
Date:

Signature of Authorized Signatory  
with seal & full address

**NAME OF WORK: SERVICE CONTRACT FOR PART PROCESSING OF LOOSE TUBE BENDS AS PER BHEL DRAWING AT BHEL PREMISES FOR ONE YEAR.**

**Tender Enq. No.: 9472600019/ 29-04-2026; GeM Bid No.: GEM/2026/B/7449412**

**iii) IN CASE OF INDIVIDUAL TENDERER:**

His / her full name, address, PAN and place & nature of business.

**iv) IN CASE OF PARTNERSHIP FIRM:**

The names of all the partners and their addresses, copy of the partnership deed/ instrument of partnership duly certified by the Notary Public shall be enclosed.

**v) IN CASE OF COMPANIES:**

- a) Date and place of registration including date of commencement certificate in case of Public Companies (certified copies of Memorandum and articles of Association are also to be furnished).
- b) Nature of business carried on by the Company and the provisions of the Memorandum relating thereof.

**1.6 AUTHORIZATION AND ATTESTATION**

Tenders shall be signed by a person duly authorized/empowered to do so, for which a Power of Attorney is to be submitted along with the tender offer. For company, a Power of Attorney (as per format in Annexure-15) shall be submitted.

**1.7 EARNEST MONEY DEPOSIT**

**1.7.1.** Every tender must be accompanied by the prescribed amount of Earnest Money Deposit (EMD) in the manner described herein.

- i. EMD shall be furnished before tender opening / along with the offer in full as per the amount indicated in the NIT.
- ii. The EMD up to an amount of Rs. 2 Lakh is to be paid only in the following forms:
  - a. Cash deposit as permissible under the extant Income Tax Act (before tender opening).
  - b. Electronic Fund Transfer credited in BHEL account (before tender opening).
  - c. Banker's cheque / Pay order / Demand draft, in favour of 'Bharat Heavy Electricals Limited' and payable at Regional HQ issuing the tender (along with offer).
  - d. Insurance Surety Bonds
  - e. In case EMD amount is more than Rs. Two Lakhs, Tenderer has the option to submit the amount in excess of Rs. Two lakhs in the forms described above in clause no. 1.7.1. ii) (a) to (e) or in the form of Bank Guarantee from Scheduled Bank (along with the Offer). The Bank Guarantee in such cases shall be valid for at least six months from the due date of tender submission. The Bank Guarantee format for EMD shall be in the prescribed formats.
- iii. No other form of EMD remittance shall be acceptable to BHEL.
- iv. Proof of EMD: Bidder shall upload the scanned copy of EMD along with bid submission through GeM Portal. However, for the purpose of realization, the bidder shall send the demand draft/ banker's cheque/ pay order/ Bank Guarantee / Insurance Surety Bonds, in original, to the designated officer through post/courier or by hand within reasonable time.

**1.7.2** EMD by the Tenderer will be forfeited as per NIT conditions, if:

- i. After opening the tender and within the offer validity period, the tenderer revokes his tender or makes any modification in his tender which is not acceptable to BHEL. OR
- ii. The successful Contractor, on whom the work has been awarded, fails to deposit the required Security deposit or commence the work within the period as per LOI/ LOA/ Contract or refuse to accept the LIO/LOA/Contract.

EMD by the tenderer shall be withheld in case any action on the tenderer is envisaged under the provisions of extant "Guidelines on Suspension of business dealings with suppliers/ contractors" of BHEL and forfeited/ released based on the action as determined under these guidelines.

**1.7.3** EMD shall not carry any interest.

**1.7.4** EMD given by all unsuccessful tenderers shall be refunded normally within fifteen days of award of work.

**1.7.5** Cash portion of EMD of successful tenderer will be retained as part of Security Deposit. EMD submitted in the form of Bank Guarantee shall be retained by BHEL until the receipt of the Security Deposit.

Place:  
Date:

Signature of Authorized Signatory  
with seal & full address

**NAME OF WORK: SERVICE CONTRACT FOR PART PROCESSING OF LOOSE TUBE BENDS AS PER BHEL DRAWING AT BHEL PREMISES FOR ONE YEAR.**

**Tender Enq. No.: 9472600019/ 29-04-2026; GeM Bid No.: GEM/2026/B/7449412**

**1.8 SECURITY DEPOSIT**

1.8.1 Upon acceptance of Tender, the successful bidder shall be required to deposit the 5% of the contract value as Security Deposit towards fulfilment of any obligations in terms of the provisions of the contract.

1.8.2 The Security Deposit shall be furnished before start of the work by the contractor.

1.8.3 The required Security Deposit may be accepted in the following forms.

- i) Cash (as permissible under the extant Income Tax Act).
- ii) Local cheques of Scheduled Banks (subject to realization)/ Pay Order/ Demand Draft/ Electronic Fund Transfer in favour of BHEL.
- iii) Securities available from Indian Post offices such as National Savings Certificates, Kisan Vikas Patras etc. (held in the name of Contractor furnishing the security and duly endorsed/ hypothecated/ pledged, as applicable, in favour of BHEL).
- iv) Bank Guarantee from Scheduled Banks/ Public Financial Institutions as defined in the Companies Act. The Bank Guarantee format for Security Deposit shall be in the prescribed formats.
- v) Insurance Surety Bonds.

**Note:**

- i) BHEL will not be liable or responsible in any manner for the collection of interest or renewal of the documents or in any other matter connected therewith.
- ii) In case of delay in submission of Security Deposit, enhanced security deposit which would include interest (Repo rate + 4%) for the delayed period, shall be submitted by the bidder before submission of first bill

1.8.4 The Security Deposit shall not carry any interest.

1.8.5 In case the value of work exceeds the awarded / accepted value, the Security Deposit shall be correspondingly enhanced as given below:

- i) The enhanced part of the Security Deposit shall be immediately deposited by the Contractor or adjusted against payments due to the Contractor.
- ii) Contract value for the purpose of operating the increased value of Security Deposit due to Quantity Variation, shall be exclusive of Price Variation Clause, Over Run Compensation and Extra works done on man-day rates.
- iii) The recoveries made from running bills can be released against submission of equivalent Bank Guarantee in acceptable form, but only once, before completion of work, with the approval of competent authority of BHEL.

1.8.6 The validity of Bank Guarantees towards Security Deposit shall be valid till actual completion of work + Guarantee Period + 3 months.

1.8.7 BHEL reserves the right of forfeiture of Security Deposit in addition to other claims, damages and remedies in the event of the Contractor's failure to fulfil any of the contractual obligations or in the event of termination of contract as per terms and conditions of contract. BHEL reserves the right to set off the Security Deposit against any claims of other contracts with BHEL by giving prior notice to the contractor.

**1.9 RETURN OF SECURITY DEPOSIT**

Security Deposit shall be released to the contractor upon fulfilment of contractual obligations as per terms of the contract including completion of Guarantee Period after deducting all expenses / other amounts due to BHEL under the contract.

**1.10 BANK GUARANTEES**

Where ever Bank Guarantees are to be furnished/submitted by the contractor, the following shall be complied with

- i. Bank Guarantees shall be from Scheduled Banks / Public Financial Institutions as defined in the Companies Act. Bank Guarantees issued by Co-Operative Banks/ Financial Institutions shall not be accepted.
- ii. The Bank Guarantees shall be as per prescribed formats.
- iii. It is the responsibility of the bidder to get the Bank Guarantees revalidated/extended for the required period as per the advice of BHEL. BHEL shall not be liable for issue of any reminders regarding expiry of the Bank Guarantees.

Place:  
Date:

Signature of Authorized Signatory  
with seal & full address

**NAME OF WORK: SERVICE CONTRACT FOR PART PROCESSING OF LOOSE TUBE BENDS AS PER BHEL DRAWING AT BHEL PREMISES FOR ONE YEAR.**

**Tender Enq. No.: 9472600019/ 29-04-2026; GeM Bid No.: GEM/2026/B/7449412**

- iv. In case extension/further extensions of any Bank Guarantees are not required, the bidders shall ensure that the same is explicitly endorsed by the Construction Manager and submitted to the BHEL unit issuing the LOI/LOA.
- v. In case the Bank Guarantees are not extended before the expiry date, BHEL reserves the right to invoke the same by informing the concerned Bank in writing, without any advance notice/communication to the concerned bidder.
- vi. Bidders to note that any corrections to Bank Guarantees shall be done by the issuing Bank, only through an amendment in an appropriate non judicial stamp paper.
- vii. The Original Bank Guarantee shall be submitted to BHEL Trichy/ WCM dept. of BHEL unless specified otherwise in TCC.

### **1.11 VALIDITY OF OFFER**

The rates in the Tender shall be kept open for acceptance for a minimum period of **SIX MONTHS** from latest due date of offer submission (including extension, if any). In case BHEL (Bharat Heavy Electricals Ltd) calls for negotiations, such negotiations shall not amount to cancellation or withdrawal of the original offer which shall be binding on the tenderers.

### **1.12 REJECTION OF TENDER AND OTHER CONDITIONS**

1.12.1 The acceptance of tender will rest with BHEL which does not bind itself to accept the lowest tender nor any tender and reserves to itself full rights for the following without assigning any reasons whatsoever: -

- a) To reject any or all of the tenders.
- b) To split up the work amongst two or more tenderers as per NIT.
- c) To award the work in part if specified in NIT.
- d) In case of either of the contingencies stated in (b) and (c) above, the time for completion as stipulated in the tender shall be applicable.

1.12.2 Conditional tenders, unsolicited tenders, tenders which are incomplete or not in the form specified or defective or have been materially altered or not in accordance with the tender conditions, specifications etc. are liable to be rejected.

1.12.3 Tenders are liable to be rejected in case of unsatisfactory performance of the tenderer with BHEL or tenderer under suspension (debarred) by any unit / region / division of BHEL or tenderers who do not comply with the latest guidelines of Ministry/Commissions of Govt of India. BHEL reserves the right to not consider a bidder for further processing of tender in case it is observed that they are overloaded and may not be in a position to execute this job as per the required schedule in line with 'NIT'. The decision of BHEL will be final in this regard.

1.12.4 If a tenderer who is a proprietor expires after the submission of his tender or after the acceptance of his tender, BHEL may at their discretion, cancel such tender. If a partner of a firm expires after the submission of tender or after the acceptance of the tender, BHEL may then cancel such tender at their discretion, unless the firm retains its character. In case BHEL resolves to cancel the tender under this clause, BHEL will issue a notice in this regard containing reasons as to the cancellation of tender. The contractor shall be required to furnish his response to such notice within a period of 14 days from the date of receipt of such notice through any means (BHEL reserves the right to decrease the period upto 05 days). BHEL after due consideration of the representation made by contractor shall communicate its final decision within a reasonable period.

In case contractor fails to submit any response to the notice issued by BHEL within the period stipulated in the notice, BHEL at its discretion may proceed to cancel the contract.

Contractor shall not be eligible for any compensation whatsoever for the cancellation of contract under this clause

1.12.5 BHEL will not be bound by any Power of Attorney granted by changes in the composition of the firm made subsequent to the execution of the contract. BHEL may, however, recognize such power of Attorney and changes after obtaining proper legal advice, the cost of which will be chargeable to the contractor concerned.

1.12.6 If the tenderer deliberately gives wrong information in his tender, BHEL reserves the right to reject such tender at any stage or to cancel the contract if awarded and forfeit the Earnest Money/Security Deposit/any other money due.

Place:  
Date:

Signature of Authorized Signatory  
with seal & full address

**NAME OF WORK: SERVICE CONTRACT FOR PART PROCESSING OF LOOSE TUBE BENDS AS PER BHEL DRAWING AT BHEL PREMISES FOR ONE YEAR.**

**Tender Enq. No.: 9472600019/ 29-04-2026; GeM Bid No.: GEM/2026/B/7449412**

1.12.7 Canvassing in any form in connection with the tenders submitted by the Tenderer shall make his offer liable to rejection.

1.12.8 In case the Proprietor, Partner or Director of the Company/Firm submitting the Tender, has any relative or relation employed in BHEL, the authority inviting the Tender shall be informed of the fact as per specified format, along with the Offer. Failing to do so, BHEL may, at its sole discretion, reject the tender or cancel the contract and forfeit the Earnest Money/Security Deposit.

1.12.9 The successful tenderer (Contractor) shall not sub-contract any portion of work detailed in the tender specification undertaken by him without written permission of BHEL's Construction Manager/Site in charge. BHEL, at its discretion, may consider the written request from the Contractor and permit subletting of part scope. However, the Contractor is solely responsible to BHEL for the work awarded to him.

1.12.10 The Tender submitted by a techno commercially qualified tenderer shall become the property of BHEL who shall be under no obligation to return the same to the bidder.

1.12.11 Unsolicited discount received after the due date and time of Bid Submission shall not be considered for evaluation. However, if the party who has submitted the unsolicited discount/rebate becomes the L-1 party, then the awarded price i.e. contract value shall be worked out after considering the discount so offered.

1.12.12 BHEL shall not be liable for any expenses incurred by the bidder in the preparation of the tender irrespective of whether the tender is accepted or not.

**1.13 INTIMATION OF CHANGE OF NAME/ RE-CONSTITUTION OF THE ORGANIZATION**

In the event of the organization (Proprietorship/Partnership/Company) undergoing any change of name or reconstitution, prior intimation of the same shall be given to BHEL. Upon such changes coming into effect, the same is to be intimated to BHEL immediately with supporting documents as applicable.

Place:  
Date:

WCM Dept. / 3<sup>rd</sup> Floor, 24 Bldg. / BHEL, Trichy-14  
Regd. Office: BHEL HOUSE, Siri Fort, New Delhi – 110 049

Signature of Authorized Signatory  
with seal & full address

**NAME OF WORK: SERVICE CONTRACT FOR PART PROCESSING OF LOOSE TUBE BENDS AS PER BHEL DRAWING AT BHEL PREMISES FOR ONE YEAR.**

**Tender Enq. No.: 9472600019/ 29-04-2026; GeM Bid No.: GEM/2026/B/7449412**

**CHAPTER-2**

**2.1 DEFINITION:** The following terms shall have the meaning hereby assigned to them except where the context otherwise requires

- i) BHEL shall mean Bharat Heavy Electricals Limited, a company registered under Indian Companies Act 1956, having its Registered Office at BHEL HOUSE, SIRI FORT, NEW DELHI – 110 049, and its office at ..... (inviting tenders) (None of the Unit or Power Sector Regional Offices or its Authorized Officers.
- ii) “EXECUTIVE DIRECTOR” or “GENERAL MANAGER (In- charge)” or “GENERAL MANAGER” shall mean the Officer in Administrative charge of the respective UNIT/Power Sector Region.
- iii) “COMPETENT AUTHORITY” shall mean BHEL Officers who are empowered to act on behalf of BHEL.
- iv) “ENGINEER” or “ENGINEER IN CHARGE” shall mean an Officer of BHEL as may be duly appointed and authorized by BHEL to act as “Engineer” on his behalf for the purpose of the Contract, to perform the duty set forth in this General Conditions of Contract and other Contract documents. The term also includes ‘CONSTRUCTION MANAGER’ or ‘SITE INCHARGE’ as well as Officers of the respective units. For the purpose of joint measurement, verification, certification and/ or approval of the work and/ or documents under the contract the word "Engineer" or "Engineer Incharge" shall be deemed to include the Engineers of the Customer and/ or his Consultant also.
- v) “SITE” shall mean the places or place at which the plants/equipments are to be erected and services are to be performed as per the specification of this Tender.
- vi) “CLIENT OF BHEL” or “CUSTOMER” shall mean the project authorities with whom BHEL has entered into a contract for supply of equipments or provision of services.
- vii) “CONTRACTOR” shall mean the successful Bidder/Tenderer who is awarded the Contract and shall include the Contractor’s successors, heirs, executors, administrators and permitted assigns.
- viii) “CONTRACT” or “CONTRACT DOCUMENT” shall mean and includes the Agreement or Work Order, the accepted appendices of Rates, Schedules, Quantities if any, Offer submitted by contractor including acceptance to General Conditions of Contract, Special Conditions of Contract, Instructions to the Tenderers, Drawings, Technical Specifications, the Special Specifications if any, the Tender documents, subsequent amendments /corrigendum to Tender mutually agreed upon and the Letter of Intent/Award/Acceptance issued by BHEL. Any conditions or terms stipulated by the contractor in the tender documents or subsequent letters shall not form part of the contract unless, specifically accepted in writing by BHEL in the Letter of Intent/Award and incorporated in the agreement or amendment thereof.
- ix) “GENERAL CONDITIONS OF CONTRACT” shall mean the ‘Instructions to Tenderers’ and ‘General Conditions of Contract’ pertaining to the work for which above tenders have been called for.
- x) “TENDER SPECIFICATION” or “TENDER” or “TENDER DOCUMENTS” shall mean General Conditions, Common Conditions, Special Conditions, Price Bid, Rate Schedule, Technical Specifications, Appendices, Annexures, Corrigendum’s, Amendments, Forms, Procedures, Site information etc. and drawings/documents pertaining to the work for which the tenderers are required to submit their offers. Individual specification number will be assigned to each Tender Specification.
- xi) “LETTER OF INTENT/ AWARD” shall mean the intimation by a Letter/Fax/email to the tenderer that the tender has been accepted in accordance with provisions contained in the letter. The responsibility of the contractor commences from the date of issue of this letter and all terms and conditions of the contract are applicable from this date.
- xii) “COMPLETION TIME” shall mean the period by ‘date/month’ specified in the ‘Letter of Intent/Award’ or date mutually agreed upon for handing over of the intended scope of work, the erected equipment/plant which are found acceptable by the Engineer, being of required standard and conforming to the specifications of the Contract.
- xiii) “PLANT” shall mean and connote the entire assembly of the plant and equipments covered by the contract.
- xiv) “EQUIPMENT” shall mean equipment, machineries, materials, structural, electricals and other components of the plant covered by the contract.
- xv) “TESTS” shall mean and include such test or tests to be carried out on the part of the contractor as are prescribed in the contract or considered necessary by BHEL in order to ascertain the quality, workmanship, performance and efficiency of the contractor or part thereof.
- xvi) “APPROVED”, “DIRECTED” or “INSTRUCTED” shall mean approved, directed or instructed by BHEL.
- xvii) “WORK or CONTRACT WORK” shall mean and include supply of all categories of labour, specified consumables, tools and tackles and Plants required for complete and satisfactory site transportation, handling, stacking, storing, erecting, testing and commissioning of the equipments to the entire satisfaction of BHEL.

Place:  
Date:

Signature of Authorized Signatory  
with seal & full address

**NAME OF WORK: SERVICE CONTRACT FOR PART PROCESSING OF LOOSE TUBE BENDS AS PER BHEL DRAWING AT BHEL PREMISES FOR ONE YEAR.**

**Tender Enq. No.: 9472600019/ 29-04-2026; GeM Bid No.: GEM/2026/B/7449412**

- xxviii) "SINGULAR AND PLURALS ETC" words carrying singular number shall also include plural and vice versa, where the context so requires. Words imparting the masculine Gender shall be taken to include the feminine Gender and words imparting persons shall include any Company or Associations or Body of Individuals, whether incorporated or not.
- xix) "HEADING" – The heading in these General Conditions are solely for the purpose of facilitating reference and shall not be deemed to be part thereof or be taken as instructions thereof or of the contract.
- xx) "MONTH" shall mean calendar month unless otherwise specified in the Tender.
- xxi) 'Day' or 'Days' unless herein otherwise expressly defined shall mean calendar day or days of twenty-four (24) hours each. A Week shall mean continuous period of seven (7) days.
- xxii) "COMMISSIONING" shall mean the synchronization testing and achieving functional operation of the Equipment with associated system after all initial adjustments, trials, cleaning, re-assembly required at site if any, have been completed and Equipment with associated system is ready for taking into service.
- xxiii) "WRITING" shall include any manuscript type written or hand written or printed statement or electronically transmitted messages, under the signature or seal or transmittal of BHEL.
- xxiv) "TEMPORARY WORK" shall mean all temporary works for every kind required in or for the execution, completion, maintenance of the work.
- xxv) 'CONTRACT PRICE' or 'CONTRACT VALUE' shall mean the sum mentioned in the LOI/LOA/Contract Agreement subject to such additions thereto or deductions there from as may be made under provisions hereinafter contained.
- xxvi) 'EXECUTED CONTRACT VALUE' shall mean actual value of works executed by the contractor and certified by BHEL. This value shall not include PVC, ORC, Extra Works and Taxes.
- xxvii) "COMMENCEMENT DATE" or "START DATE" shall mean the commencement/start of work at Site as per terms defined in the Tender.
- xxviii) "SHORT CLOSING" or "FORE CLOSING" of Contract shall mean the premature closing of Contract, for reasons not attributable to the contractor and mutually agreed between BHEL and the contractor.
- xxix) "TERMINATION" of Contract shall mean the pre mature closing of contract due to reasons as mentioned in the contract.
- xxx) "DE MOBILIZATION" shall mean the temporary winding up of Site establishment by Contractor leading to suspension of works temporarily for reasons not attributable to the contractor.
- xxxi) "RE MOBILIZATION" shall mean the resumption of work with all resources required for the work after demobilization.
- xxxii) "OVERRUN CHARGES (ORC)" shall mean and include all the costs incurred by the Contractor during the extended period of the contract, including but not limited to any cost arising out of idle labour, administrative cost, T & P and machinery.

## **2.2 LAW GOVERNING THE CONTRACT AND COURT JURISDICTION**

The contract shall be governed by the Laws of India. Subject to clause 2.15 of this contract, the Civil Court having original Civil Jurisdiction at Tiruchirappalli, shall alone have exclusive jurisdiction in regard to all matters in respect of the Contract.

## **2.3 ISSUE OF NOTICE**

### **2.3.1 Service of notice to the Contractor**

Any notice to be given to the Contractor under the terms of the contract shall be served by sending the same by Email/Registered Post/Speed Post to or leaving the same at the Contractor's last known address of the principal place of business (or in the event of the contractor being a company, to or at its Registered Office). In case of change of address, the notice shall be served at changed address as notified in writing by the Contractor to BHEL. Such dispatch or display posting or leaving of the notice as the case may be shall be deemed to be good service of such notice and the time mentioned to the condition for doing any act after notice shall be reckoned from the date so mentioned in such notice.

### **2.3.2 Service of notice to BHEL**

Any notice to be given to BHEL In-charge of the Region under the terms of the Contract shall be served by sending the same by Registered/AD or Speed post to BHEL address or changed address as notified in writing by BHEL to the Contractor.

## **2.4 USE OF LAND**

No land belonging to BHEL or their Customer under temporary possession of BHEL shall be occupied by the contractor without written permission of BHEL.

## **2.5 COMMENCEMENT OF WORK**

2.5.1 The contractor shall commence the work as per the time indicated in the Letter of Intent/Award from BHEL and shall proceed with the same with due expedition without delay.

Place:

Date:

Signature of Authorized Signatory  
with seal & full address

**NAME OF WORK: SERVICE CONTRACT FOR PART PROCESSING OF LOOSE TUBE BENDS AS PER BHEL DRAWING AT BHEL PREMISES FOR ONE YEAR.**

**Tender Enq. No.: 9472600019/ 29-04-2026; GeM Bid No.: GEM/2026/B/7449412**

2.5.2 If the contractor fails to start the work within stipulated time as per LOI/ LOA or as intimated by BHEL, then BHEL at its sole discretion shall have the right to cancel the contract. The Earnest Money and/or Security Deposit furnished by the contractor to under this tender will stand forfeited without any further reference to him and without prejudice to BHEL's other rights and remedies under this contract and the applicable laws in this regard.

2.5.3 All the work shall be carried out under the direction and to the satisfaction of BHEL.

**2.6 MEASUREMENT OF WORK AND MODE OF PAYMENT:**

2.6.1 All payments due to the contractors shall be made by e mode only, unless otherwise found operationally difficult for reasons to be recorded in writing and approved by contract executing department.

2.6.2 For progress running bill payments: - The Contractor shall present detailed measurement sheets in triplicate, duly indicating all relevant details based on technical documents and connected drawings for work done during the month/period under various categories in line with terms of payment as per contract. The basis of arriving at the quantities, weights shall be relevant documents and drawings released by BHEL. These measurement sheets shall be prepared jointly with BHEL Engineers and signed by both the parties.

2.6.3 These measurement sheets will be checked by BHEL Engineer and quantities and percentage eligible for payment under various groups shall be decided by BHEL Engineer. The abstract of quantities and percentage so arrived at based on the terms of payment shall be entered in Measurement Book and signed by both the parties.

2.6.4 Based on the above quantities, contractor shall prepare the bills, along with statutory documents, in prescribed format and work out the financial value. These will be entered in Measurement Book and signed by both the parties. Payment shall be made by BHEL after effecting the recoveries due from the contractor.

2.6.5 All recoveries due from the contractor for the month/period shall be effected in full from the corresponding running bills unless specific approval from the competent authorities is obtained to the contrary.

2.6.6 Measurement shall be restricted to that portion of work for which it is required to ascertain the financial liability of BHEL under this contract.

2.6.7 The measurement shall be taken jointly by persons authorized on the part of BHEL and by the Contractor.

2.6.8 The Contractor shall bear the expenditure involved if any, in making the measurements and testing of materials to be used/ used in the work. The contractor shall, without extra charges, provide all the assistance with appliances and other things necessary for measurement.

2.6.9 If at any time due to any reason whatsoever, it becomes necessary to re-measure the work done in full or in part, the expenses towards such re measurements shall be borne by the contractor unless such re measurements are warranted solely for reasons not attributable to contractor.

2.6.10 Passing of bills covered by such measurements does not amount to acceptance of the completion of the work measured. Any left out work has to be completed, if pointed out at a later date by BHEL.

Final measurement bill shall be prepared in the final bill format prescribed for the purpose based on the certificate issued by BHEL Engineer that entire works as stipulated in tender specification has been completed in all respects to the entire satisfaction of BHEL. The Contractor shall submit the final bill in line with WAM 7 format as per tender documents with an additional recording of the dispute, if any and shall sign with the following declaration:

I/ We hereby certify that I/We have performed the work as per the terms and conditions of Contract Agreement/Work Order No.....dated.....for which payment is claimed as above and that I/We have no further claim under this agreement/work order\* except for the following (nature of claim with details & amount claimed, if any. NIL may be mentioned if there are no further claims). -

- a).....
- b).....
- c) .....

Place:  
Date:

Signature of Authorized Signatory  
with seal & full address

**NAME OF WORK: SERVICE CONTRACT FOR PART PROCESSING OF LOOSE TUBE BENDS AS PER BHEL DRAWING AT BHEL PREMISES FOR ONE YEAR.**

**Tender Enq. No.: 9472600019/ 29-04-2026; GeM Bid No.: GEM/2026/B/7449412**

It is agreed that the authorized signatory of Contractor shall necessarily record his claims/ dispute in Form WAM 7 only and any claim(s)/ dispute in any other form/ letter shall not be taken cognizance of by BHEL and admissible before any forum. BHEL shall make the payment of undisputed amount within the stipulated time without any unreasonable delay.

All the tools and tackles loaned to him should be returned in satisfactory condition to BHEL. The abstract of final quantities and financial values shall also be entered in the Measurement Books and signed by both parties to the contract. The Final Bill shall be prepared and paid within a reasonable time after completion of work.

**2.7 RIGHTS OF BHEL**

BHEL reserves the following rights in respect of this contract during the original contract period or its extensions if any, as per the provisions of the contract, without entitling the contractor for any compensation.

**2.7.1** To withdraw any portion of work and/or to restrict/alter quantum of work as indicated in the contract during the progress of work and get it done through other agencies to fulfil BHEL's commitment to its customer or the date of completion is advance due to other emergent reasons/ BHEL's obligation to its customer.

Where the contractor fails to deploy adequate manpower to meet the contractual target, BHEL reserves the right to deploy manpower to meet such shortfall, through any other agency for expediting activities in the interest of the project. Supplied manpower shall be put on job by the contractor. Fulfilling of all obligations towards payments and other statutory compliances related to such manpower shall be the contractor's responsibility. In case of contractor's failure to fulfil his obligations in respect of such manpower, BHEL shall be entitled to take action as provided herein.

**2.7.2 BREACH OF CONTRACT, REMEDIES AND TERMINATION**

**2.7.2.1** The following shall amount to breach of contract:

- i. Non-supply of material/ non-completion of work by the Supplier/Vendor within scheduled delivery/ completion period as per contract or as extended from time to time.
- ii. The Supplier/Vendor fails to perform as per the activity schedule and there are sufficient reasons even before expiry of the delivery/ completion period to justify that supplies shall be inordinately delayed beyond contractual delivery/ completion period.
- iii. The Supplier/Vendor delivers equipment/ material not of the contracted quality.
- iv. The Supplier/Vendor fails to replace the defective equipment/ material/ component as per guarantee clause.
- v. Withdrawal from or abandonment of the work by the Supplier/Vendor before completion as per contract.
- vi. Assignment, transfer, subletting of Contract by the Supplier/Vendor without BHEL's written permission resulting in termination of Contract or part thereof by BHEL.
- vii. Non-compliance to any contractual condition or any other default attributable to Supplier/Vendor.
- viii. Any other reason(s) attributable to Vendor towards failure of performance of contract. In case of breach of contract, BHEL shall have the right to terminate the Purchase Order/ Contract either in whole or in part thereof without any compensation to the Supplier/Vendor.
- ix. Any of the declarations furnished by the contractor at the time of bidding and/ or entering into the contract for supply are found untruthful and such declarations were of a nature that could have resulted in non-award of contract to the contractor or could expose BHEL and/ or Owner to adverse consequences, financial or otherwise.
- x. Supplier/Vendor is convicted of any offence involving corrupt business practices, antinational activities or any such offence that compromises the business ethics of BHEL, in violation of the Integrity Pact entered into with BHEL has the potential to harm the overall business of BHEL/ Owner.

Note-Once BHEL considers that a breach of contract has occurred on the part of Supplier/Vendor, BHEL shall notify the Supplier/Vendor by way of notice in this regard. Contractor shall be given an opportunity to rectify the reasons causing the breach of contract within a period of 14 days.

In case the contractor fails to remedy the breach, as mentioned in the notice, to the satisfaction of BHEL, BHEL shall have the right to take recourse to any of the remedial actions available to it under the relevant provisions of contract.

**LD against delay in executed work in case of Termination of Contract:**

LD against delay in executed work shall be calculated in line with LD clause no. 2.7.9 of GCC, for the delay attributable to contractor. For limiting the maximum value of LD, contract value shall be taken as Executed Value of work till termination of contract.

Place:  
Date:

Signature of Authorized Signatory  
with seal & full address

**NAME OF WORK: SERVICE CONTRACT FOR PART PROCESSING OF LOOSE TUBE BENDS AS PER BHEL DRAWING AT BHEL PREMISES FOR ONE YEAR.**

**Tender Enq. No.: 9472600019/ 29-04-2026; GeM Bid No.: GEM/2026/B/7449412**

Method for calculation of "LD against delay in executed work in case of termination of contract" is given below.

- i. Let the time period from scheduled date of start of work till termination of contract excluding the period of Hold (if any) not attributable to contractor = T1
- ii. Let the value of executed work till the time of termination of contract= X
- iii. Let the Total Executable Value of work for which inputs/fronts were made available to contractor and were planned for execution till termination of contract = Y
- iv. Delay in executed work attributable to contractor i.e.  $T2=[1-(X/Y)] \times T1$
- v. LD shall be calculated in line with LD clause (clause 2.7.9) of the Contract for the delay attributable to contractor taking "X" as Contract Value and "T2" as period of delay attributable to contractor.

**2.7.2.2 Remedies in case of Breach of Contract.**

- i. Wherein the period as stipulated in the notice issued under clause 2.7.2 has expired and Contractor has failed to remedy the breach, BHEL will have the right to terminate the contract on the ground of "Breach of Contract" without any further notice to contractor.
- ii. Upon termination of contract, BHEL shall be entitled to recover an amount equivalent to 10% of the Contract Value for the damages on account of breach of contract committed by the Contractor. This amount shall be recovered by way of encashing the security instruments like performance bank guarantee etc. available with BHEL against the said contract. In case the value of the security instruments available is less than 10% of the contract value, the balance amount shall be recovered from other financial remedies (i.e. available bills of the contractor, retention amount, from the money due to the Contractor etc. with BHEL) or the other legal remedies shall be pursued.
- iii. wherever the value of security instruments like performance bank guarantee available with BHEL against the said contract is 10% of the contract value or more, such security instruments to the extent of 10% contract value will be encashed. In case no security instruments are available or the value of the security instruments available is less than 10% of the contract value, the 10% of the contract value or the balance amount, as the case may be, will be recovered in all or any of the following manners:
- iv. In case the amount recovered under sub clause (a) above is not sufficient to fulfil the amount recoverable then; a demand notice to deposit the balance amount within 30 days shall be issued to Contractor.
- v. If Contractor fails to deposit the balance amount within the period as prescribed in demand notice, following action shall be taken for recovery of the balance amount:
  - a. from dues available in the form of Bills payable to defaulted Contractor against the same contract.
  - b. If it is not possible to recover the dues available from the same contract or dues are insufficient to meet the recoverable amount, balance amount shall be recovered from any money(s) payable to Contractor under any contract with other Units of BHEL including recovery from security deposits or any other deposit available in the form of security instruments of any kind against Security deposit or EMD.
  - c. In-case recoveries are not possible with any of the above available options, Legal action shall be initiated for recovery against defaulted Contractor.
- vi. It is an agreed term of contract that this amount shall be a genuine pre-estimate of damages that BHEL would incur in completion of balance contractual obligation of the contract through any other agency and BHEL will not be required to furnish any other evidence to the Contractor for the purpose of estimation of damages.
- vii. In addition to the above, imposition of liquidated damages, debarment, termination, de-scoping, short-closure, etc., shall be applied as per provisions of the contract.

Note:

1) The defaulting contractor shall not be eligible for participation in any of the future enquiries floated by BHEL to complete the balance work. The defaulting contractor shall mean and include:

(a) In case defaulted contractor is the Sole Proprietorship Firm, any Sole Proprietorship Firm owned by same Sole Proprietor.

(b) In case defaulted contractor is The Partnership Firm, any firm comprising of same partners/ some of the same partners (but not including any new partner); or sole proprietorship firm owned by any partner(s) as a sole proprietor.

2.7.3 In case Contractor fails to deploy the resources as per requirement informed by BHEL in writing to expedite the work, BHEL can deploy own/hired/otherwise arranged resources and recover the expenses incurred from the dues payable to contractor. Recoveries shall be actual expenses incurred plus 5% overheads or as defined in TCC.

Place:  
Date:

Signature of Authorized Signatory  
with seal & full address

**NAME OF WORK: SERVICE CONTRACT FOR PART PROCESSING OF LOOSE TUBE BENDS AS PER BHEL DRAWING AT BHEL PREMISES FOR ONE YEAR.**

**Tender Enq. No.: 9472600019/ 29-04-2026; GeM Bid No.: GEM/2026/B/7449412**

2.7.4 To terminate the contract or to restrict the quantum of work and pay for the portion of work executed in case BHEL's contract with their customer are terminated for any reason, whatsoever.

2.7.5 Whenever any Claim or Claims for payment of any sum of money(s) arises under this or any other contract against the contractor, BHEL shall be entitled to withhold and also have a lien to retain such sum of money(s) in whole or in part from any money(s) payable to contractor and/or security deposits furnished or deducted in cash from the bills of contractor, (if any) under this contract. In the event of the securities or the amounts payable to Contractor, being insufficient to cover BHEL claims, then BHEL shall be entitled to withhold and have a lien to the extent of such claims from any sum or sums found payable or which at any time thereafter may become payable to the contractor under this or any other contract with BHEL.

- a. Claim or Claims for payment of any sum of money(s) arising from the Contractor under this or any other contract against the contractor, shall mean, the sum of money(s) actually incurred by BHEL in fulfilling the contractual responsibilities of contractor under the contract, to which he has failed to fulfil plus applicable overheads (@ 5%) along with interest as applicable under the Contract on total amount (i.e. money actually incurred plus overheads)
- b. It is an agreed term of the contract that, the sum or sums of money so withheld or retained under the lien by BHEL will be kept withheld or retained as such by BHEL till the claims arising out of this or any other contract are finally adjudicated wither through Arbitration or a Court of competent jurisdiction as the case may be in accordance with the terms of contract. Intimation given by the BHEL Engineer regarding withholding of such money(s) shall be considered as sufficient and relevant date for all purposes. No Interest shall be payable on such sum(s) of money which becomes due or as the case may be adjudged to be due from BHEL to Contractor, whether under contract or otherwise.
- c. Where the contractor is a partnership firm, BHEL shall be entitled to withhold and also have a lien to retain towards such claims in whole or in part, from any other money(s) payable to any partner, whether in his individual capacity or otherwise.
- d. If any money(s) shall, as a result of any claim or application made under the relevant provisions of any Labour Welfare Act and/ or Rules, including but not limited to Contract Labour Regulation & Abolition Act, Minimum Wages Act, Payment of Gratuity Act, BOCW (RE&CS) Act, Provident Fund Act, Employee State Insurance Act, be directed to be paid by the BHEL, such money shall be deemed to be moneys payable to the BHEL by the Contractor.
- e. Where the Contractor fails to repay to BHEL such moneys along with applicable overheads (@ 5%) and interest, as aforesaid within seven days of being demanded, BHEL shall be entitled to recover the same from Contractor's bills/ Security Deposit or any other money(s) payable to Contractor under this Contract or any other Contract with BHEL.

2.7.6 While every endeavour will be made by BHEL to this end, yet BHEL cannot guarantee uninterrupted work due to conditions beyond its control. The Contractor will not be normally entitled for any compensation/extra payment on this account unless otherwise specified elsewhere in the contract.

2.7.7 BHEL may permit or direct contractor to demobilize and remobilize at a future date as intimated by BHEL in case of following situations for reasons other than Force majeure conditions and not attributable to contractor:

- i) suspension of work(s) at a Project either by BHEL or Customer, or
- ii) where work comes to a complete halt or reaches a stage wherein worthwhile works cannot be executed and there is no possibility of commencement of work for a period of not less than three months.

In such cases, charges towards demobilization and remobilization shall be as decided by BHEL after successful remobilization by contractor at site, and decision of BHEL shall be final and binding on the contractor. After remobilization, all conditions as per contract shall become applicable. In case Contractor does not remobilize with adequate resources or does not start the work within the period as intimated, then BHEL reserves the right to terminate the contract and effect remedies under Clause 2.7.2.2. In case of any conflict, BHEL decision in this regard shall be final and binding on the contractor.

2.7.8 In the unforeseen event of inordinate delay in receipt of materials, drawings, fronts etc. due to which inordinate discontinuity of work is anticipated, BHEL on its own or contractor's request at its discretion may consider to short close the contract in any of the following cases:

- a. The balance works (including but not limited to Trial Operation, PG Test etc.) are minor vis a vis the scope of work envisaged as per the contract.

Place:  
Date:

Signature of Authorized Signatory  
with seal & full address

**NAME OF WORK: SERVICE CONTRACT FOR PART PROCESSING OF LOOSE TUBE BENDS AS PER BHEL DRAWING AT BHEL PREMISES FOR ONE YEAR.**

**Tender Enq. No.: 9472600019/ 29-04-2026; GeM Bid No.: GEM/2026/B/7449412**

- b. There has been no significant work in past 6 months OR no significant work is expected in next 6 months (example in Hydro projects or in projects where work has stopped due to reasons beyond the control of BHEL).
- c. The balance works cannot be done within a reasonable period of time as they are dependent on unit shut down or on other facilities of customer or any other such reasons not attributable to the contractor.

At the point of requesting for short closure, contractor shall establish that he has completed all works possible of completion and he is not able to proceed with the balance works due to constraints beyond his control. In such a case, the estimated value of the unexecuted portion of work (or estimated value of services to be provided for carrying out milestone/stage payments like Trial Operation/PG Test etc.) as decided by BHEL, shall however be reduced from the final contract value.

**Note:** The Contractor shall not be eligible for any compensation on account of Quantity Variation arising out of short-closure of contract as per clause no. 2.7.8 (b) above.

**2.7.9 LIQUIDATED DAMAGES**

Liquidated Damages, wherever referred under this Tender/Agreement, shall mean and refer to the damages, not in the nature of penalty, which the contractor agrees to pay in the event of delay in delivery of stores, installation, commissioning, breach of contract etc. as the case may be.

Liquidated Damages leviable upon the contractor is a sum which is agreed by the parties as a reasonable and genuine pre-estimate of damages which will be suffered by BHEL on account of delay/breach on the part of the contractor.

Liquidated Damages shall be calculated in the manner stipulated hereinafter:

In case the work is not completed within the stipulated time period, BHEL at its discretion may grant provisional time extension to contractor for the sole purpose of completion of balance works keeping its right reserved under the contract and law.

Grant of any provisional time extension shall by no means be considered as waiver of BHEL rights under the contract or law.

After the completion of work, duly certified by Engineer Incharge, a comprehensive delay analysis shall be carried out to ascertain the attribution of delays in the provisional time extensions granted to contractor. The delay analysis shall record:

- a) Delays solely attributable to contractor
- b) Delays attributable to BHEL
- c) Delays on account of Force Majeure (as specified elsewhere in the contract)

The total period under the final time extension shall be equal to the period between the scheduled date of completion and the actual date of completion of contract. LD shall be imposed/ levied for the portion of time extensions solely attributable to contractor and recoverable from the dues payable to the contractor.

For the periods, wherein the delay as per the comprehensive delay analysis carried out is solely attributable to contractor, BHEL shall have the right to impose Liquidated Damage at the rate of 0.5% of the contract value, per week of delay or part thereof subject to a maximum of 10% of the contract value.

Contract Value for this purpose, shall be the final executed value exclusive of ORC, Extra Works executed on Man-day rate basis, Supplementary/ Additional Items and PVC. Before levying LD, the contractor shall be duly intimated the amount and reasons thereof for imposition of LD.

**2.8 RESPONSIBILITIES OF THE CONTRACTOR IN RESPECT OF LOCAL LAWS, EMPLOYMENT OF WORKERS ETC.**

The following are the responsibilities of the contractor in respect of observance of local laws, employment of personnel, payment of taxes etc. The subcontractor shall fully indemnify BHEL against any claims of whatsoever nature arising due to the failure of the contractor in discharging any of his responsibilities hereunder:

2.8.1 As far as possible, Unskilled Workers shall be engaged from the local areas in which the work is being executed.

2.8.2 The contractor at all times during the continuance of this contract shall, in all his dealings with local labour for the time being employed on or in connection with the work, have due regard to all local festivals and religious and other customs.

Place:  
Date:

Signature of Authorized Signatory  
with seal & full address

**NAME OF WORK: SERVICE CONTRACT FOR PART PROCESSING OF LOOSE TUBE BENDS AS PER BHEL DRAWING AT BHEL PREMISES FOR ONE YEAR.**

**Tender Enq. No.: 9472600019/ 29-04-2026; GeM Bid No.: GEM/2026/B/7449412**

2.8.3 The contractor shall comply with all applicable State and Central Laws, Statutory Rules, Regulations, Notifications etc. such as Payment of Wages Act, Minimum Wages Act, Workmen Compensation Act, Employer's Liability Act, Industrial Disputes Act, Employers Provident Fund and Miscellaneous Provisions Act, 1952, Employees State Insurance Scheme, Contract Labour (Regulation and Abolition) Act, 1970, Payment of Bonus & Gratuity Act, Building and Other Construction Workers (Regulation of Employment and Conditions of Service) Act 1996, The Building and Other Construction Workers' Welfare Cess Act 1996 and other Acts, Rules, and Regulations for labour/workers as applicable and as may be enacted by the State Government and Central Govt. during the tenure of the Contract and having force or jurisdiction at Site. The Contractor shall also comply with provisions of and give all such notices to the local Governing Body, Police and other relevant Authorities as may be required by the Law. The Contractor shall without any fail maintain all the registers/records in proper formats as per all the Acts, Rules and Regulations mentioned in this clause 2.8.3.

2.8.4 The Contractor shall obtain independent License under the Contract Labour (Regulations and Abolition) Act, 1970 for engaging contract labour as required from the concerned Authorities based on the certificate (Form- V or as applicable) issued by the Principal Employer/Customer.

2.8.5 The contractor shall pay and bear all taxes, fees, license charges, Cess, duties, deposits, tolls, royalties, commission or other charges which may be leviable on account of his operations in executing the contract.

2.8.6 While BHEL would pay the inspection fees and Registration fees of Boiler/Electrical Inspectorate, all other arrangements for site visits periodically by the Inspectorate to site, Inspection certificate etc. will have to be made by contractor. However, BHEL will not make any payment to the Inspectorate in connection with contractor's Welders/Electricians qualification tests etc.

2.8.7 Contractor shall be responsible for provision of Health and Sanitary arrangements (more particularly described in Contract Labour Regulation & Abolition Act), Safety precautions etc. as may be required for safe and satisfactory execution of contract.

2.8.8 The contractor shall be responsible for proper accommodation including adequate medical facilities for personnel employed by him.

2.8.9 The contractor shall be responsible for the proper behavior and observance of all regulations by the staff employed by him.

2.8.10 The contractor shall ensure that no damage is caused to any person/property of other parties working at site/company" premises. If any such damage is caused, it is responsibility of the contractor to make good the losses or compensate for the same.

2.8.11 All the properties/equipments/components of BHEL/their Client/Customer loaned with or without deposit to the contractor in connection with the contract shall remain properties of BHEL/their Client/Customer.

2.8.12 The contractor shall use such properties for the purpose of execution of this contract. All such properties/equipments/components shall be deemed to be in good condition when received by the contractor unless he notifies within 48 hours to the contrary. The contractor shall return them in good condition as and when required by BHEL/their Client. In case of non-return, loss, damage, repairs etc. the cost thereof as may be fixed by BHEL Engineer will be recovered from the contractor.

2.8.13 In case the contractor is required to undertake any work outside the scope of this contract, the rates payable shall be those mutually agreed upon if the item rates are not mentioned in existing contract.

2.8.14 Any delay in completion of works/or non-achievement of periodical targets/or non-execution of contract due to the reasons attributable to the contractor, the same may have to be compensated by the contractor either by increasing manpower and resources or by working extra hours and/or by working more than one shift. All these are to be carried out by the contractor at no extra cost.

2.8.15 The contractor shall arrange, coordinate his work in such a manner as to cause no hindrance to other agencies working in the same premises.

2.8.16 All safety rules and codes applied by the Customer /BHEL at site shall be observed by the contractor without exception. The contractor shall be responsible for the safety of the equipment/material and works to be performed by him and shall maintain all light, fencing guards, slings etc. or other protection necessary for the purpose. Contractor shall also

Place:  
Date:

Signature of Authorized Signatory  
with seal & full address

**NAME OF WORK: SERVICE CONTRACT FOR PART PROCESSING OF LOOSE TUBE BENDS AS PER BHEL DRAWING AT BHEL PREMISES FOR ONE YEAR.**

**Tender Enq. No.: 9472600019/ 29-04-2026; GeM Bid No.: GEM/2026/B/7449412**

take such additional precautions as may be indicated from time to time by the Engineer with a view to prevent pilferage, accidents, fire hazards. Due precautions shall be taken against fire hazards and atmospheric conditions. Suitable number of Clerical staff, watch and ward, store keepers to take care of equipment/materials and construction tools and tackles shall be posted at site by the contractor till the completion of work under this contract.

The contractor shall arrange for such safety devices as are necessary for such type of work and carry out the requisite site tests of handling equipment, lifting tools, tackles etc. as per prescribed standards and practices.

Contractor has to ensure the implementation of Health, Safety and Environment (HSE) requirements as per directions given by BHEL/Customer. The contractor has to assist in HSE audit by BHEL/Customer and submit compliance Report. The contractor has to generate and submit record/reports as per HSE plan/activities as per instruction of BHEL/Customer.

2.8.17 The contractor shall be directly responsible for payment of wages to his workmen/labours before the expiry of seven days from the last day of wage period and to ensure disbursement of wages in the presence of the representative from BHEL. A pay roll sheet giving all the payments given to the workers and duly signed by the contractor's representative should be furnished to BHEL site for the purpose of maintaining the records for compliance,

Contractor shall create awareness amongst their workforce by helping & encouraging in opening bank accounts and to encourage them to adopt digital mode of transactions. While releasing wages/ salary to their workers/ supervisors/ staff, Contractor shall comply with the GOI's guidelines for maximizing such transactions through Non-Cash / digital means.

2.8.18 In case of any class of work for which there is no such specification as laid down in the contract, such work shall be carried out in accordance with the instructions and requirements of the Engineer.

2.8.19 Also, no idle charges will be admissible in the event of any stoppage caused in the work resulting in contractor's labour and Tools & Plants being rendered idle due to any reason at any time.

2.8.20 The contractor shall take all reasonable care to protect the materials and work till such time the plant/equipment has been taken over by BHEL or their Customer whichever is earlier.

2.8.21 The contractor shall not stop the work or abandon the site for whatsoever reason of dispute, excepting force majeure conditions. All such problems/disputes shall be separately discussed and settled without affecting the progress of work. Such stoppage or abandonment shall be treated as breach of contract and dealt with accordingly.

2.8.22 The contractor shall keep the area of work clean and shall remove the debris etc. while executing day-to-day work. Upon completion of work, the contractor shall remove from the vicinity of work, all scrap, packing materials, rubbish, unused and other materials and deposit them in places specified by the Engineer. The contractor will also demolish all the hutments, sheds, offices etc. constructed and used by him and shall clean the debris. In the event of his failure to do so, the same will be arranged to be done by the Engineer and the expenses recovered from the contractor.

2.8.23 The contractor shall execute the work in the most substantial and workman like manner in the stipulated time. Accuracy of work and timely execution shall be the essence of this contract. The contractor shall be responsible to ensure that the quality, assembly and workmanship conform to the dimensions and clearance given in the drawings and/ or as per the instructions of the Engineer.

2.8.24 The Contractor to note that some of BHEL's T&Ps/MMDs may not be insured. The Contractor will take necessary precautions and due care to protect the same while in his custody from any damage/ loss till the same is handed over back to BHEL. In case the damage / loss is caused due to carelessness/ negligence on the part of the contractor, the Contractor is liable to get them repair/ replaced immediately and in case of his failure to do so within a reasonable time, BHEL shall recover the loss from the contractor.

2.8.25 For all works having contract value of Rs. 5,00,000/- or above, BHEL shall recover the amount of compensation paid to victim(s) by BHEL towards loss of life/ permanent disability due to an accident which is attributable to the negligence of contractor, agency or firm or any of its employees as detailed below.

a) Victim: Any person who suffers permanent disablement or dies in an accident as defined below.

b) Accident: Any death or permanent disability resulting solely and directly from any unintended and unforeseen injurious occurrence caused during the manufacturing/ operation and works incidental thereto at BHEL factories/ offices and precincts thereof, project execution, erection and commissioning, services, repairs and maintenance, trouble

Place:  
Date:

Signature of Authorized Signatory  
with seal & full address

**NAME OF WORK: SERVICE CONTRACT FOR PART PROCESSING OF LOOSE TUBE BENDS AS PER BHEL DRAWING AT BHEL PREMISES FOR ONE YEAR.**

**Tender Enq. No.: 9472600019/ 29-04-2026; GeM Bid No.: GEM/2026/B/7449412**

shooting, serving, overhaul, renovation and retrofitting, trial operation, performance guarantee testing undertaken by the company or during any works/ during working at BHEL Units/ Offices/ townships and premises/ Project Sites.

c) Compensation in respect of each of the victims:

- i) In the event of death or permanent disability resulting from Loss of both limbs: Rs. 10,00,000/- (Rs. Ten Lakh).
- ii) In the event of other permanent disability: Rs.7,00,000/- (Rs. Seven Lakh)

d) Permanent Disablement: A disablement that is classified as a permanent total disablement under the proviso to section 2 (I) of the Employee's Compensation Act, 1923.

2.8.26 Contractor shall be fully responsible for the safety of their T&Ps and other material mobilized at site. In any case, BHEL shall not be liable for any damage/loss/misuse of any item(s) belong to the contractor.

2.8.27 Contractor will ensure that the work/job is executed through his/her employees on and under no circumstances, the contractor shall subcontract the job without prior written permission from BHEL.

2.8.28 The liability for any compensation on account of injury sustained by an employee of the contractor will be exclusively that of the contractor.

**2.9 EXECUTION PLAN, PROGRESS MONITORING, MONTHLY REVIEW AND PERFORMANCE EVALUATION**

2.9.1 A tentative plan/ programme for completion of the contractual scope of work as per the time schedule given in the contract shall be made jointly by BHEL and Contractor, before commencement of work. The above programme shall be supported by month wise deployment of resources viz Manpower, T&P, Consumables, etc. Progress will be reviewed periodically (Daily/Weekly/Monthly) vis-à-vis this jointly agreed programme.

Subsequently, every month, quarterly rolling plan will be made by BHEL based on budgeted targets.

Monthly plan in F-14 format shall be drawn from this Quarterly plan. Monthly plan shall necessarily include activities required for achieving targets/ milestones unless inputs/ fronts are not available. While planning and arriving on asking rate all available inputs shall be taken into consideration.

Vendor will be required to execute the monthly plan in that month in addition to make full efforts to minimize the cumulative shortfall attributable to him up to the month.

BHEL may require monthly work plan up to one and half times of average monthly value and demand matching manpower.

Where, Average Monthly Value = Total Contract Value (as per latest revision) / Period of Contract (in months)

Provided, this requirement is reflected in the rolling quarterly plan two months in advance. If the Contractor refuses to sign the F-14 format, those F-14 formats requiring Contractor's signature shall be deemed to have been signed and accepted by the Contractor, if communicated to the Contractor through email or any other mode as stated in clause 2.3.1.

The Contractor shall submit periodical progress reports (Daily/Weekly/Monthly) and other reports/ information including manpower, consumables, T&P mobilization etc. as desired by BHEL.

2.9.2 Monthly progress review between BHEL and Contractor shall be based on the agreed programme as above, availability of inputs/fronts etc., and constraints if any, as per prescribed formats (i.e. Form F-14). Manpower, T&P and consumable reports as per prescribed formats shall be submitted by contractor every month. Release of RA Bills shall be contingent upon certification by BHEL Site Engineer of the availability of the above prescribed formats duly filled in and signed.

2.9.3 The burden of proof that the causes leading to any shortfall is not due to any reasons attributable to the contractor is on the contractor himself. The monthly progress review shall record shortfalls attributable to (i) Contractor, (ii) Force Majeure Conditions, and (iii) BHEL

2.9.4 Performance of the Contractor shall be assessed as per prescribed formats and shall form the basis for 'Assessment of Capacity of Bidder' for Tenders where the Contractor is a bidder. BHEL reserves the right to revise the evaluation formats during the course of execution of the works.

Place:  
Date:

Signature of Authorized Signatory  
with seal & full address

**NAME OF WORK: SERVICE CONTRACT FOR PART PROCESSING OF LOOSE TUBE BENDS AS PER BHEL DRAWING AT BHEL PREMISES FOR ONE YEAR.**

**Tender Enq. No.: 9472600019/ 29-04-2026; GeM Bid No.: GEM/2026/B/7449412**

**2.10 TIME OF COMPLETION**

2.10.1 The time for completion shall be as mentioned in the LOA/Contract. The time for completion shall be reckoned from the date of commencement of work at Site as certified/notified in writing by BHEL Engineers.

2.10.2 Time being the essence of the contract, the entire work shall be completed by the contractor within the time schedule or within such extended periods of time as may be allowed by BHEL under clause 2.11.

**11 EXTENSION OF TIME FOR COMPLETION**

2.11.1 If the completion of work as detailed in the scope of work gets delayed beyond the contract period, the contractor shall request for an extension of the contract and BHEL at its discretion may extend the Contract. If the completion of work gets delayed for reasons not attributable to the contractor, the contract period may be suitably extended at the sole discretion of BHEL.

2.11.2 Based on the F-14 formats, the works balance at the end of original contract period less the backlog attributable to the contractor shall be quantified, and the number of months of 'Time extension' required for completion of the same shall be jointly worked out. Within this period of 'Time extension', the contractor is bound to complete the portion of backlog attributable to the contractor. Any further 'Time extension' or 'Time extensions' at the end of the previous extension shall be worked out similarly.

2.11.3 However, if any 'Time extension' is granted to the contractor to facilitate continuation of work and completion of contract, due to backlog attributable to the contractor alone, then it shall be without prejudice to the rights of BHEL to impose penalty/LD for the delays attributable to the contractor, in addition to any other actions BHEL may wish to take under Clause 2.7.2 of GCC i.e. Breach of Contract, Remedies and Termination.

2.11.4 Planning, progress monitoring, monthly review and performance monitoring shall be carried out as per clause 2.9 of GCC.

**2.12 INSURANCE**

2.12.1 BHEL/their customer shall arrange for insuring the materials/properties of BHEL/customer covering the risks during transit, storage, erection and commissioning.

2.12.2 It is the sole responsibility of the contractor to insure his materials, equipment, workmen etc. against accidents and injury while at work and to pay compensation, if any, to workmen as per Workmen's compensation Act. The work will be carried out in a protected area and all the rules and regulations of the client /BHEL in the area of project which are in force from time to time will have to be followed by the contractor.

2.12.3 If due to negligence and or non-observation of safety and other precautions by the contractors, any accident/injury occurs to the property / manpower belong to third party, the contractor shall have to pay necessary compensation and other expense, if so decided by the appropriate authorities.

2.12.4 The contractor will take necessary precautions and due care to protect the material, while in his custody from any damage/ loss due to theft or otherwise till the same is taken over by BHEL or customer. For lodging / processing of insurance claim, the contractor will submit necessary documents. BHEL will recover the loss including the deductible franchise from the contractor, in case the damage / loss is due to carelessness / negligence on the part of the contractor. In case of any theft of material under contractor's custody, matter shall be reported to Police by the contractor immediately and copy of FIR and subsequently police investigation report shall be submitted to BHEL for taking up with insurance. However, this will not relieve the contractor of his contractual obligation for the material in his custody.

**2.13 STRIKES & LOCKOUT**

2.13.1 The contractor will be fully responsible for all disputes and other issues connected with his labour. In the event of the contractor's labour resorting to strike or the Contractor resorting to lockout and if the strike or lockout declared is not settled within a period of one month, it may be considered as 'Breach of Contract' under Clause 2.7 and the remedies under Clause 2.7.2.2 may be executed, at the discretion of BHEL.

2.13.2 For all purposes whatsoever, the employees of the contractor shall not be deemed to be in the employment of BHEL.

**2.14 QUANTITY VARIATION**

Place:  
Date:

Signature of Authorized Signatory  
with seal & full address

**NAME OF WORK: SERVICE CONTRACT FOR PART PROCESSING OF LOOSE TUBE BENDS AS PER BHEL DRAWING AT BHEL PREMISES FOR ONE YEAR.**

**Tender Enq. No.: 9472600019/ 29-04-2026; GeM Bid No.: GEM/2026/B/7449412**

2.14.1 The quantities given in the contract are tentative and may change to any extent (both in plus side and minus side). No compensation becomes payable in case the contract gets partially executed/ short closed/ terminated/ work withdrawn under Rights of BHEL mentioned in Clause 2.7 of GCC."

**2.15 FORCE MAJEURE**

2.15.1 "Force Majeure" shall mean circumstance which is:

- a. beyond control of either of the parties to contract,
  - b. either of the parties could not reasonably have provided against the event before entering into the contract,
  - c. having arisen, either of the parties could not reasonably have avoided or overcome, and d) is not substantially attributable to either of the parties
- And  
Prevents the performance of the contract,

Such circumstances include but shall not be limited to:

- i) War, hostilities, invasion, act of foreign enemies.
- ii) Rebellion, terrorism, revolution, insurrection, military or usurped power, or civil war.
- iii) Riot, commotion or disorder by persons other than the contractor's personnel and other employees of the contractor and sub-contractors.
- iv) Strike or lockout not solely involving the contractor's personnel and other employees of the contractor and sub-contractors.
- v) Encountering munitions of war, explosive materials, ionizing radiation or contamination by radio-activity, except as may be attributable to the contractor's use of such munitions, explosives, radiation or radio- activity.
- vi) Natural catastrophes such as earthquake, tsunami, volcanic activity, hurricane or typhoon, flood, fire, cyclones etc.
- vii) Epidemic, pandemic etc.

2.15.2 The following events are explicitly excluded from Force Majeure and are solely the responsibilities of the non-performing party: a) any strike, work-to-rule action, go-slow or similar labour difficulty (b) late delivery of equipment or material (unless caused by Force Majeure event) and (c) economic hardship.

2.15.3 If either party is prevented, hindered or delayed from or in performing any of its obligations under the Contract by an event of Force Majeure, then it shall notify the other in writing of the occurrence of such event and the circumstances thereof within 15 (fifteen) days after the occurrence of such event.

2.15.4 The party who has given such notice shall be excused from the performance or punctual performance of its obligations under the Contract for so long as the relevant event of Force Majeure continues and to the extent that such party's performance is prevented, hindered or delayed. The Time for Completion shall be extended by a period of time equal to period of delay caused due to such Force Majeure event.

2.15.5 Delay or non-performance by either party hereto caused by the occurrence of any event of Force Majeure shall not

- a. Constitute a default or breach of the Contract.
- b. Give rise to any claim for damages or additional cost expense occasioned thereby, if and to the extent that such delay or non-performance is caused by the occurrence of an event of Force Majeure.

2.15.6 BHEL at its discretion may consider short closure of contract after 1 year of imposition of Force Majeure in line with extant guidelines. In any case, Supplier/Vendor cannot consider deemed short-closure after 1 year of imposition of Force Majeure

**2.16 Settlement of Dispute**

If any dispute or difference of any kind whatsoever shall arise between BHEL and the Supplier/Vendor, arising out of the contract for the performance of the work whether during the progress of contract termination, abandonment or breach of the contract, it shall in the first place referred to Designated Engineer for amicable resolution by the parties. Designated Engineer (to be nominated by BHEL for settlement of disputes arising out of the contract) who within 60 days after being requested shall give written notice of his decision to the contractor. Save as hereinafter provided, such decision in respect of every matter so referred shall forthwith be given effect to by the Supplier/Vendor who shall proceed with the work with all due diligence, whether he or BHEL desires to resolve the dispute as hereinafter provided or not.

Place:  
Date:

Signature of Authorized Signatory  
with seal & full address

**NAME OF WORK: SERVICE CONTRACT FOR PART PROCESSING OF LOOSE TUBE BENDS AS PER BHEL DRAWING AT BHEL PREMISES FOR ONE YEAR.**

**Tender Enq. No.: 9472600019/ 29-04-2026; GeM Bid No.: GEM/2026/B/7449412**

If after the Designated Engineer has given written notice of this decision to the party and no intention to pursue the dispute has been communicated to him by the affected party within 30 days from the receipt of such notice, the said decision shall become final and binding on the parties. In the event the Supplier/Vendor being dissatisfied with any such decision or if amicable settlement cannot be reached then all such disputed issues shall be resolved through conciliation in terms of the BHEL Conciliation Scheme 2018 as per Clause 2.15.1

**2.16.1 Conciliation:**

Any dispute, difference or controversy of whatever nature howsoever arising under or out of or in relation to this Agreement (including its interpretation) between the Parties, and so notified in writing by either Party to the other Party (the "Dispute") shall, in the first instance, be attempted to be resolved amicably in accordance with the conciliation procedure as per BHEL Conciliation Scheme 2018. The proceedings of Conciliation shall broadly be governed by Part-III of the Arbitration and Conciliation Act 1996 or any statutory modification thereof and as provided in - "Procedure for conduct of conciliation proceedings" (as available in www.bhel.com)).

**Note:** Ministry of Finance has issued OM reference No. 1/2/24 dated 03.06.2024 regarding "Guidelines for Arbitration and Mediation in Contracts of Domestic Public Procurement. In the said OM it has been recommended that Government departments/ Entities/agencies are to encourage mediation under the Mediation Act. 2023. The said Act has not yet been notified by the Government. Therefore, the clause "Settlement of Disputes" shall be modified accordingly as and when the Mediation Act 2023 gets notified.

**2.16.2 ARBITRATION:**

2.16.2.1 Except as provided elsewhere in this Contract, in case Parties are unable to reach amicable settlement (whether by Conciliation to be conducted as provided in Clause 2.15 herein above or otherwise) in respect of any dispute or difference; arising out of the formation, breach, termination, validity or execution of the Contract; or, the respective rights and liabilities of the Parties; or, in relation to interpretation of any provision of the Contract; or, in any manner touching upon the Contract (hereinafter referred to as the 'Dispute'), then, either Party may, refer the disputes to Arbitral Institution (to be identified by the contract issuing agency (e.g. "IIAC" (India International Arbitration Centre) for Delhi/NCR offices) and such dispute to be adjudicated by Sole Arbitrator appointed in accordance with the Rules of said Arbitral Institution.

2.16.2.2 A party willing to commence arbitration proceeding shall invoke Arbitration Clause by giving notice to the other party in terms of section 21 of the Arbitration & Conciliation Act, 1996 (hereinafter referred to as the 'Notice') before referring the matter to arbitral institution. The Notice shall be addressed to the Head of the Region, Power Sector/ Unit, BHEL, executing the Contract and shall contain the particulars of all claims to be referred to arbitration with sufficient detail and shall also indicate the monetary amount of such claim including interest, if any.

2.16.2.3 After expiry of 30 days from the date of receipt of aforesaid notice, the party invoking the Arbitration shall submit that dispute to the Arbitral Institutions..... ( to be identified by the contract issuing agency) and that dispute shall be adjudicated in accordance with their respective Arbitration Rules. The matter shall be adjudicated by a Sole Arbitrator who shall necessarily be a Retd Judge having considerable experience in commercial matters to be appointed/nominated by the respective institution. The cost/expenses pertaining to the said Arbitration shall also be governed in accordance with the Rules of the respective Arbitral Institution. The decision of the party invoking the Arbitration for reference of dispute to a specific Arbitral institution for adjudication of that dispute shall be final and binding on both the parties and shall not be subject to any change thereafter. The institution once selected at the time of invocation of dispute shall remain unchanged.

2.16.2.4 The fee and expenses shall be borne by the parties as per the Arbitral Institutional rules.

2.16.2.5 The Arbitration proceedings shall be in English language and the seat and venue of Arbitration shall be (to be identified by the contract issuing agency) .....(i. e. New Delhi for Delhi/NCR based Units).

2.16.2.6 Subject to the above, the provisions of Arbitration & Conciliation Act 1996 and any amendment thereof shall be applicable. All matters relating to this Contract and arising out of invocation of Arbitration clause are subject to the exclusive jurisdiction of the Court(s) situated at.....( i. e. New Delhi for Delhi/NCR based Units).

2.16.2.7 Notwithstanding any reference to the Designated Engineer or Conciliation or Arbitration herein, a. the parties shall continue to perform their respective obligations under the Contract unless they otherwise agree. Settlement of Dispute clause cannot be invoked by the Contractor, if the Contract has been mutually closed or 'No Demand Certificate' has been furnished by the Contractor or any Settlement Agreement has been signed between the Employer and the Contractor.

Place:  
Date:

Signature of Authorized Signatory  
with seal & full address

**NAME OF WORK: SERVICE CONTRACT FOR PART PROCESSING OF LOOSE TUBE BENDS AS PER BHEL DRAWING AT BHEL PREMISES FOR ONE YEAR.**

**Tender Enq. No.: 9472600019/ 29-04-2026; GeM Bid No.: GEM/2026/B/7449412**

2.16.2.8 It is agreed that Mechanism of resolution of disputes through arbitration shall be available only in the cases where the value of the dispute is less than Rs. 10 Crores.

2.16.2.9 In case the disputed amount (Claim, Counter claim including interest is Rs. 10 crores and above, the parties shall be within their rights to take recourse to remedies other than Arbitration, as may be available to them under the applicable laws after prior intimation to the other party. Subject to the aforesaid conditions, provisions of the Arbitration and Conciliation Act, 1996 and any statutory modifications or re-enactment thereof as amended from time to time, shall apply to the arbitration proceedings under this clause.

2.16.2.10 In case, multiple arbitrations are invoked (whether sub-judice or arbitral award passed) by any party to under this contract, then the cumulative value of claims (including interest claimed or awarded) in all such arbitrations shall be taken in account while arriving at the total claim in dispute for the subject contract for the purpose of clause 21.2.9. Disputes having cumulative value of less than 10 crores shall be resolved through arbitration and any additional dispute shall be adjudicated by the court of competent jurisdiction.

**2.16.3 In case of Contract with Public Sector Enterprise (PSE) or a Government Department, the following shall be applicable:**

In the event of any dispute or difference relating to the interpretation and application of the provisions of commercial contract(s) between Central Public Sector Enterprises (CPSEs)/ Port Trusts inter se and also between CPSEs and Government Departments/Organizations (excluding disputes concerning Railways, Income Tax, Customs & Excise Departments), such dispute or difference shall be taken up by either party for resolution through AMRCD (Administrative Mechanism for Resolution of CPSEs Disputes) as mentioned in DPE OM No. 05/0003/2019-FTS-10937 dated 14-12-2022 as amended from time to time.

**2.16.4 NO INTEREST PAYABLE TO CONTRACTOR**

Notwithstanding anything to the contrary contained in any other document comprising in the Contract, no interest shall be payable by BHEL to Contractor on any moneys or balances including but not limited to the Security Deposit, EMD, Retention Money, RA Bills or the Final Bill, or any amount withheld and/or appropriated by BHEL. etc., which becomes or as the case may be, is adjudged to be due from BHEL to Contractor whether under the Contract or otherwise.

**2.17 CLOSING OF CONTRACTS**

The Contract shall be considered completed and closed upon completion of contractual obligations and settlement of Final Bill or completion of Guarantee period whichever is later. Upon closing of Contract, BHEL shall issue a performance/ experience certificate as per standard format, based on specific request of Contractor as per extant BHEL guidelines through the online portal available at <https://siddhi.bhel.in> only.

**2.18 SUSPENSION OF BUSINESS DEALINGS**

BHEL reserves the right to take action against Contractors who either fail to perform or Tenderers/Contractor who indulge in malpractices, by suspending business dealings with them in line with BHEL guidelines issued from time to time.

The offers of the bidders who are under suspension as also the offers of the bidders, who engage the services of the banned firms / principal / agents, shall be rejected. The list of banned firms is available on BHEL web site [www.bhel.com](http://www.bhel.com).

If any bidder / supplier / contractor during pre-tendering / tendering / post tendering / award / execution / post-execution stage indulges in any act, including but not limited to, mal-practices, cheating, bribery, fraud or and other misconduct or formation of cartel so as to influence the bidding process or influence the price or tampers the tendering process or acts or omits in any manner which tantamount to an offence punishable under any provision of the Indian Penal Code, 1860 or any other law in force in India, or does anything which is actionable under the Guidelines for Suspension of Business dealings, action may be taken against such bidder / supplier / contractor as per extant guidelines of the company available on [www.bhel.com](http://www.bhel.com) and / or under applicable legal provisions. Guidelines for suspension of business dealings is available in the webpage: [http://www.bhel.com/vender\\_registration/vender.php](http://www.bhel.com/vender_registration/vender.php)

**2.19 LIMITATION ON LIABILITY:**

Notwithstanding anything to the contrary in this Contract or LOA or Work Order or any other mutually agreed document between the parties, the maximum liability, for damages, of the contractor, its servants or agents, shall under no circumstances exceed an amount equal to the Price of the Contract or the Work Order. The Contractor shall not in any case be liable for loss of profit or special, punitive, exemplary, indirect or consequential losses whatsoever. This shall not be

Place:  
Date:

Signature of Authorized Signatory  
with seal & full address

**NAME OF WORK: SERVICE CONTRACT FOR PART PROCESSING OF LOOSE TUBE BENDS AS PER BHEL DRAWING AT BHEL PREMISES FOR ONE YEAR.**

**Tender Enq. No.: 9472600019/ 29-04-2026; GeM Bid No.: GEM/2026/B/7449412**

applicable on the recoveries made by Customer from BHEL on account of Contractor, any other type of recoveries for workmanship, material, T&P etc. due from the contractor.

**2.20 Cartel Formation**

The Bidder declares that they will not enter into any illegal or undisclosed agreement or understanding, whether formal or informal with other Bidder(s). This applies in particular to prices, specifications, certifications, subsidiary contracts, submission or non-submission of bids or any other actions to restrict competitiveness or to introduce cartelization in the bidding process. In case, the Bidder is found having indulged in above activities, suitable action shall be taken by BHEL as per extant policies/ guidelines.

**2.21 Fraud Prevention Policy**

Bidder along with its associate /collaborators /sub-contractors /sub-vendors / consultants/ service providers shall strictly adhere to BHEL Fraud Prevention Policy displayed on BHEL website <http://www.bhel.com> and shall immediately bring to the notice of BHEL Management about any fraud or suspected fraud as soon as it comes to their notice.

**2.22 Order of Precedence**

In the event of any ambiguity or conflict between the contract Documents, the order of precedence shall be in the order below:

- a. Contract agreement with its Amendments/Clarifications/Corrigenda/Errata etc. issued in respect of the tender documents by BHEL
- b. Notice Inviting Tender (NIT)
- c. Price Bid
- d. Technical Conditions of Contract (TCC)
- e. Special Conditions of Contract (SCC)
- f. General Conditions of Contract (GCC)
- g. Forms and Procedures

**2.23 OTHER ISSUES**

2.23.1 Value of Non judicial Stamp Paper for Bank Guarantees and for Contract Agreement shall be not less than Rs 100/- unless otherwise required under relevant statutes.

2.23.2 In case of any conflict between the General Conditions of Contract and Special Conditions of Contract, provisions contained in the Special Conditions of Contract shall prevail.

2.23.3 Unless otherwise specified in NIT, offers from consortium/ JVs shall not be considered.

**GENERAL CONDITIONS OF THE CONTRACT FOR FACILITY MANAGEMENT, MANPOWER SUPPLY AND SECURITY SERVICES**

CL AU SE NO.	DESCRIPTION	CLAUSE
	<b>CONTRACT PERIOD</b>	The contract will commence on the date as mentioned in the contract/agreement and will remain in force for a period of _____. However, this Agreement shall be liable for termination by the BHEL at any time by giving minimum 30 days' notice to the Contractor without assigning any reason thereof and without prejudice to the rights of BHEL to recover any amount becoming due under this Agreement.
	<b>CONTRACT DOCUMENTS</b>	"Contract Documents" shall include the Contract Agreement, Scope of Work, Special Conditions of the Contract (SCC), General Conditions of the Contract (GCC), Scope of Work, Commercial Conditions of the Contract, amendments, schedules and any other document specified in the contract agreement.  This agreement is the outcome of joint efforts of the parties.

Place:  
Date:

Signature of Authorized Signatory  
with seal & full address

**NAME OF WORK: SERVICE CONTRACT FOR PART PROCESSING OF LOOSE TUBE BENDS AS PER BHEL DRAWING AT BHEL PREMISES FOR ONE YEAR.**

**Tender Enq. No.: 9472600019/ 29-04-2026; GeM Bid No.: GEM/2026/B/7449412**

<p><b>INTERPRETATION OF THE CONTRACT</b></p>	<p>3.1 Subject to the order of precedence as set out in Sub- Clause b) below, all documents forming part of the Contract are intended to be correlative, complementary and mutually explanatory. The Contract shall be read and construed as a whole document.</p> <p>3.2 In case of any conflict or contradiction between two or more documents with respect to the terms defined in the said documents, the order of precedence shall be as set out below-</p> <ul style="list-style-type: none"> <li>i) Contract Agreement;</li> <li>ii) Commercial Terms of the Contract;</li> <li>iii) Special Conditions of the Contract; and</li> <li>iv) General Conditions of the Contract</li> </ul> <p><i>Note: Any annexure to any of the above shall be read along with the covering document.</i></p> <p>3.3 In case of any ambiguity or discrepancy, the Company Representative nominated by BHEL shall issue the necessary clarifications or instructions to the Contractor.</p> <p>3.4 Notwithstanding the sub-division of the Contract into sections, every part of each section shall be deemed to be supplementary to and complementary of each other.</p> <p>3.5 All headings, sub-headings and marginal notes to the items of the Contract or to the Specifications or to any other document forming part of the Contract are solely for the purpose of giving a concise indication of the general subject matter thereof, and not a summary of the contents thereof and they shall never be deemed to be part thereof or be used in the interpretation or construction thereof.</p>
<p><b>SECURITY DEPOSIT</b></p>	<p>4.1 Security Deposit means the security provided by the Contractor towards fulfilment of any obligations in terms of the provisions of the contract. The total amount of Security Deposit shall be as per the SCC. The contractor shall submit the security deposit in any of the following forms:</p> <ul style="list-style-type: none"> <li>i. Cash (as permissible under the extant Income Tax Act)</li> <li>ii. Local cheque of Scheduled Banks (subject to realization)/ Pay Order/ Demand Draft/ Electronic Fund Transfer in favour of BHEL</li> <li>iii. Bank Guarantee from Scheduled Banks/ Public Financial Institutions as defined in the Companies Act.</li> <li>iv. v. Securities available from Indian Post offices such as National Savings Certificates, Kisan Vikas Patras etc. (held in the name of Contractor furnishing the security and duly endorsed/ hypothecated/ pledged, as applicable, in favor of BHEL).</li> </ul> <p>4.2 <b>COLLECTION OF SECURITY:</b> The entire security amount is to be deposited in advance. However, security may be collected in installments in exceptional cases. In such cases at least 50% of the required Security Deposit, including the EMD, shall be collected before start of the work. Balance of the Security Deposit can be collected by deducting 10% of the gross amount progressively from each of the running bills of the Contractor till the total amount of the required Security Deposit is collected. If the value of work done at any time exceeds the contract value, the amount of Security Deposit shall be correspondingly enhanced and the additional Security Deposit shall be immediately deposited by the Contractor or recovered from payment/s due to the Contractor. The recoveries made from running bills (cash deduction towards balance SD amount) can be released against submission of equivalent Bank Guarantee in acceptable form, but only once, before completion of work.</p> <ul style="list-style-type: none"> <li>i. The security deposit shall not carry any interest.</li> <li>ii. EMD of successful tenderer shall be adjusted as part of Security Deposit.</li> </ul>

Place:  
Date:

Signature of Authorized Signatory  
with seal & full address

**NAME OF WORK: SERVICE CONTRACT FOR PART PROCESSING OF LOOSE TUBE BENDS AS PER BHEL DRAWING AT BHEL PREMISES FOR ONE YEAR.**

**Tender Enq. No.: 9472600019/ 29-04-2026; GeM Bid No.: GEM/2026/B/7449412**

		<p>iii. The validity of Security Deposit shall be up to the validity of contract plus three months.</p> <p>iv. BHEL reserves the right of forfeiture of Security Deposit towards its claims and penalties under the contract in the event of the Contractor's failure to fulfill any of the contractual obligations or in the event of termination of contract as per terms and conditions of contract.</p> <p><b>4.3 RETURN OF SECURITY DEPOSIT:</b> Security Deposit shall be refunded / Bank Guarantee(s) will be released to the Contractor upon fulfilment of all the Contractual / Statutory obligations or after 03 (three) months from the date of completion of the contract whichever is later, after deducting all expenses / other amounts due to BHEL under the contract.</p> <p><b>4.4 BANK GUARANTEES:</b> Wherever Bank Guarantee is to be furnished / submitted by the Contractor, the following shall be complied with</p> <p>i. Bank Guarantee shall be from Scheduled Banks / Public Financial Institutions as defined in the Companies Act.</p> <p>ii. The Bank Guarantee shall be as per prescribed formats.</p> <p>iii. It is the responsibility of the contractor to get the Bank Guarantee revalidated / extended for the required period, as per the advice of BHEL. BHEL shall not be liable for issue of any reminders regarding expiry of the Bank Guarantee.</p> <p>iv. In case the Bank Guarantee is not extended before the expiry date, BHEL reserves the right to invoke the same by informing the concerned Bank in writing, without any advance notice/communication to the concerned contractor.</p> <p>v. Contractors to note that any corrections to Bank Guarantee shall be done by the issuing Bank, only through an amendment in an appropriate non-judicial stamp paper.</p>
	<b>Compliance with BHEL's Fraud prevention policy.</b>	The Contractor along with its associate/collaborators/ sub-contractors/ sub-vendors/ consultants associated with the scope of work shall strictly adhere to BHEL Fraud Prevention Policy displayed on BHEL website <a href="http://www.bhel.com">http://www.bhel.com</a> and shall immediately bring to the notice of BHEL Management about any fraud or suspected fraud as soon as it comes to their notice.
	<b>Maintaining Quality of the Job and rectification of any deficiency</b>	The Contractor will be responsible for the quality of the job as per the specifications and will immediately rectify the deficiency pointed out in the job performed.
	<b>SUBCONTRACTING</b>	The Contractor cannot sub-contract part or complete work detailed in the tender specification undertaken by him without written permission of BHEL. The Contractor is solely responsible to BHEL for the work awarded to him.
	<b>TERMINATION OF CONTRACT</b>	BHEL reserves the right to terminate the whole or part of the contract without assigning any reason by giving prior written notice of 30 days. The notice of termination shall specify, the portion/scope of the contract which stands terminated and the date on which such termination becomes effective. No compensation for termination shall be payable to the contractor. However, the Contractor shall be entitled to receive contract price for the services rendered upto the date of termination after effecting recoveries due from the contractor. The Contractor hereby waives any claim for compensation for losses/damages and/or reimbursement of costs.
	<b>Liquidated Damages and Penalties</b>	The Contractor shall be liable to BHEL for liquidated damages and penalties in accordance with the Special Conditions/commercial conditions of the contract.
	<b>RECOVERY FROM CONTRACTOR</b>	Whenever under the contract, any sum of money is recoverable from or payable by the contractor, the same may be deducted from any sum then due or which at any time thereafter may become due to the contractor under the contract or from his security deposit, or the contractor shall pay the claim on demand.

Place:  
Date:

Signature of Authorized Signatory  
with seal & full address

**NAME OF WORK: SERVICE CONTRACT FOR PART PROCESSING OF LOOSE TUBE BENDS AS PER BHEL DRAWING AT BHEL PREMISES FOR ONE YEAR.**

**Tender Enq. No.: 9472600019/ 29-04-2026; GeM Bid No.: GEM/2026/B/7449412**

	<b>POST PAYMENT AUDIT OF WORK &amp; BILLS</b>	BHEL reserves the right to carry out a post payment audit and technical examination of the work and final bill including all supporting vouchers, abstracts etc. and to enforce recovery of any sums becoming due as a result thereof. However, no such recovery shall be enforced after three years of payment of the final bill.
	<b>CONFIDENTIAL INFORMATION</b>	<p>The Contractor agrees &amp; acknowledges that in the course of their discussions and interactions, BHEL may disclose information of confidential proprietary nature relating to its business, products, know-how, technology, customers, employees and financial. Such information shall be considered as confidential. The contractor agrees to keep it confidential &amp; secret at all times and not directly or indirectly disclose to any party other than its employees and authorized personnel's strictly on a need know basis, without the prior written permission of BHEL.</p> <p>The above condition shall however not apply to that information, which-</p> <ul style="list-style-type: none"> <li>i. now or hereafter enters the public domain through no fault of that party;</li> <li>ii. can be proven to have been possessed by that party at the time of disclosure and which was not previously obtained, directly or indirectly, from the other party hereto; and</li> <li>iii. otherwise lawfully becomes available to that party from a third party that has no obligation of confidentiality.</li> </ul> <p>The provisions of this Clause shall survive termination for a period of ____ years, for whatever reason, of the Contract.</p>
	<b>SETTLEMENT OF DISPUTES</b>	<p>13.1 The Parties agree that if at any time (whether before, during or after the arbitral or judicial proceedings), any Disputes (which term shall mean and include any dispute, difference, question or disagreement arising in connection with construction, meaning, operation, effect, interpretation or breach of the contract/tender which the Parties are unable to settle mutually), arise inter-se the Parties, the same may, be referred by either party to Conciliation to be conducted through Independent Experts Committee to be appointed by competent authority of BHEL.</p> <p>13.2 The proceedings of Conciliation shall broadly be governed by Part-III of the Arbitration and Conciliation Act 1996 or any statutory modification thereof.</p> <p>13.3 In case the parties are unable to reach any amicable settlement (whether by Conciliation to be conducted as provided hereinabove or otherwise), then, either Party may, commence arbitration in accordance with the arbitration rules of the arbitral institution mentioned in the SCC for adjudication by Sole Arbitrator to be appointed by the said arbitral institution.</p> <p>13.4 A party willing to commence arbitration proceeding shall invoke the Arbitration Clause by giving notice to the other party in terms of section 21 of the Arbitration &amp; Conciliation Act, 1996 (hereinafter referred to as the 'Notice') before referring the matter to the arbitral institution.</p> <p>13.5 After expiry of 30 days from the date of receipt of aforesaid notice, the party invoking the Arbitration shall submit that dispute to the said arbitral institution and it shall be adjudicated in accordance with the respective arbitration rules of the said arbitral institution. The matter shall be adjudicated by a Sole Arbitrator who shall necessarily be a retired Judge or Advocate having considerable experience in dealing with such commercial disputes.</p> <p>13.6 The cost and expenses pertaining to the Arbitration shall be governed by the Rules of the said Arbitral Institution.</p> <p>13.7 The seat and venue of the arbitration shall be the place from which the Contract is issued by BHEL.</p>

Place:  
Date:

Signature of Authorized Signatory  
with seal & full address

**NAME OF WORK: SERVICE CONTRACT FOR PART PROCESSING OF LOOSE TUBE BENDS AS PER BHEL DRAWING AT BHEL PREMISES FOR ONE YEAR.**

**Tender Enq. No.: 9472600019/ 29-04-2026; GeM Bid No.: GEM/2026/B/7449412**

		<p>13.8 The cost of arbitration shall be shared by the parties during the arbitration proceedings in equal proportion and shall be finally borne as per the award of the Arbitrator.</p> <p>13.9 Subject to arbitration in terms of clause above, the Courts at the place from which the Contract is issued shall have exclusive jurisdiction over any matter arising out of or in connection with this Contract or Arbitration proceedings.</p> <p>13.10 Notwithstanding the existence or any dispute or difference and/or reference for the arbitration, the Contractor shall proceed with and continue without hindrance the performance of its obligation under this Contract with due diligence and in a professional manner except where the Contract has been terminated by either Party.</p> <p>13.11 It is agreed between the parties that Arbitration as a dispute redressal mechanism shall be applicable only in case where the amount involved in the disputes is less than Rs.10 crores.</p> <p><b>Note:</b> Ministry of Finance has issued OM reference No. 1/2/24 dated 03.06.2024 regarding “Guidelines for Arbitration and Mediation in Contracts of Domestic Public Procurement. In the said OM it has been recommended that Government departments/ Entities/agencies are to encourage mediation under the Mediation Act. 2023 . The said Act has not yet been notified by the Government. Therefore, the clause “Settlement of Disputes” shall be modified accordingly as and when the Mediation Act 2023 gets notified.</p>
	<p><b>APPLICABLE LAWS AND JURISDICTION OF COURTS</b></p>	<p>Indian laws both substantive and procedural, for the time being in force, including modifications thereto, shall govern the Contract including Arbitration proceedings. The court of competent civil jurisdiction at the place of the concerned BHEL Unit awarding the contract and only the said Court(s) shall have jurisdiction to entertain and try any such action(s) and/or proceeding(s) to the exclusion of all other Courts.</p>
	<p><b>DEFAULT/BREACH OF CONTRACT AND CONTRACTOR'S OBLIGATION</b></p>	<p>If the Contractor fails to provide the required services as per the Contract / fails to deliver the goods or materials or any instalment thereof within the period(s) fixed for such delivery or delivers goods or services not of the contracted quality and failing to adhere to the contract specifications or at any time repudiates or otherwise abandons the contract before expiry of such period or refuses or is unable to supply / provide goods / services or materials covered by the Order/ Contract either in whole or in part or otherwise fails to perform the Order/ Contract or commits any breach of the Order/Contract not herein specifically provided for, the contractor agrees that BHEL would be entitled to recover 10% of the contract value as damages for breach. Such compensation may be recovered from the security instruments like performance/security bank guarantee available with BHEL. In case the value of the security instruments available is less than 10% of the contract value, the balance amount shall be recovered from other financial remedies (i.e. available bills of the contractor, retention amount, etc. with BHEL) under the contract or other legal remedies.</p>
	<p><b><u>FORCE MAJEURE</u></b></p>	<p>16.1 “Force Majeure” shall mean any event beyond the reasonable control of the BHEL or of the Contractor, as the case may be, and which is unavoidable notwithstanding the reasonable care of the party affected, and shall include, without limitation, the following:</p> <ul style="list-style-type: none"> <li>i. war, hostilities, or warlike operations whether a state of war be declared or not, invasion, act of foreign enemy and civil war;</li> <li>ii. rebellion, revolution, insurrection, mutiny, usurpation of civil or military government, conspiracy, riot, civil commotion, and terrorist acts;</li> <li>iii. epidemics, quarantine, and plague;</li> <li>iv. earthquake, landslide, volcanic activity, fire, flood or inundation, tidal wave, typhoon or cyclone, hurricane, storm or other natural or physical disaster.</li> </ul>

Place:  
Date:

Signature of Authorized Signatory  
with seal & full address

**NAME OF WORK: SERVICE CONTRACT FOR PART PROCESSING OF LOOSE TUBE BENDS AS PER BHEL DRAWING AT BHEL PREMISES FOR ONE YEAR.**

**Tender Enq. No.: 9472600019/ 29-04-2026; GeM Bid No.: GEM/2026/B/7449412**

		<p>16.2 If either party is prevented, hindered, or delayed from or in performing any of its obligations under the Contract by an event of Force Majeure, then it shall notify the other in writing of the occurrence of such event and the circumstances thereof within 14 days after the occurrence of such event.</p> <ul style="list-style-type: none"> <li>i. If the contractor issues a notice under this clause, BHEL shall examine the existence of such force majeure and may excuse the contractor from performance of the contract during the existence of such force majeure.</li> <li>ii. The party or parties affected by the event of Force Majeure shall use reasonable efforts to mitigate the effect thereof upon its or their performance of the Contract and to fulfil its or their obligations under the Contract.</li> <li>iii. No delay or non-performance by either party hereto caused by the force majeure shall             <ul style="list-style-type: none"> <li>(a) constitute a default or breach of the Contract; or</li> <li>(b) give rise to any claim for damages or additional cost or expense occasioned thereby.</li> </ul> </li> <li>iv. If the performance of the Contract is substantially prevented, hindered, or delayed for a single period of more than 60 days or an aggregate period of more than 120 days on account of one or more events of Force Majeure during the currency of the Contract, the parties will attempt to develop a mutually satisfactory solution, failing which either party may terminate the Contract by giving a notice to the other.</li> </ul>
	<p><b>TERMS OF PAYMENT</b></p>	<p>17.1 The Contract Price shall be paid by BHEL to the Supplier as per the terms specified in Special Conditions of the Contract.</p> <p><b>17.2 Discrepant Amounts</b>            In the event BHEL finds any discrepancy, within fifteen (15) days from receipt, in any invoice raised by the Contractor, BHEL shall give a notice regarding discrepant amount to the Contractor and withhold such part of the invoice value which is discrepant till such time the discrepancy is resolved between the Parties. If the Contractor intends to dispute the discrepant amount, the Contractor shall provide documentary evidence to BHEL within fifteen (15) days of receipt of notice regarding such discrepant amount. If Contractor's documentary evidence is accepted by BHEL, it shall pay the amount as mentioned in the invoice raised by the Contractor. In the event that the Parties are unable to resolve any issue in relation to such discrepant amount(s) within thirty (30) days of issue of the notice by BHEL in relation to the discrepant amount, such dispute shall be resolved in accordance with Clause 13.</p> <p>17.3 Notwithstanding anything to the contrary in the Contract, the payment of any invoice by BHEL shall not prejudice, at any point of time, any rights of BHEL under the Contract, including the right of BHEL to notify any discrepancy in accordance with Clause herein above in respect of any amounts therein, as may be identified by way of any audit or inspection, that may have been conducted subsequent to the payment of such invoice. In the event any such discrepancy is identified in relation to any invoice that has already been paid by BHEL, BHEL shall have the right to adjust any amount that may be due and payable by the Supplier.</p> <p>17.4 The Contractor agrees that no interest shall be payable by BHEL on any amount due under this contract.</p>
	<p><b>NO CLAIM CERTIFICATE</b></p>	<p>The Contractor shall not, be entitled to make any claim, whatsoever, against BHEL under or by virtue of or arising out of this contract nor shall BHEL entertain or consider any such claim after Contractor has signed a "no claim certificate (<b>WAM 10</b>)" in favour of BHEL or in such forms as shall be required by BHEL after the works are finally accepted.</p>
	<p><b>LIASONING WITH LOCAL AND STATE AUTHORITIES</b></p>	<p>Contractor will co-ordinate with state and local authorities for the work being done, as and when needed.</p>
	<p><b>REPORTING</b></p>	<p>Contractor will submit the Daily, Weekly, Monthly, Quarterly, Half-Yearly and Annual Reports as per the formats discussed and decided between BHEL and Contractor.</p>

Place:  
Date:

Signature of Authorized Signatory  
with seal & full address

**NAME OF WORK: SERVICE CONTRACT FOR PART PROCESSING OF LOOSE TUBE BENDS AS PER BHEL DRAWING AT BHEL PREMISES FOR ONE YEAR.**

**Tender Enq. No.: 9472600019/ 29-04-2026; GeM Bid No.: GEM/2026/B/7449412**

<p><b>COMMISSION FOR EMPLOYMENT</b></p>	<p>21.1 The Contractor hereby undertakes that it shall not charge any fees in whatever name, or take any monetary / non-monetary considerations / deductions from its workforces/ individual/ persons/ resources engaged by it, to be deployed at BHEL site. The Contractor further agrees that it will not indulge in any unethical practices and acknowledges that any noncompliance of the aforesaid undertaking will be treated as a material breach of the Contract, in which case BHEL shall have the right to take appropriate independent actions including termination of the Contract and actions as deemed fit.</p> <p>21.2 After award of contract, if the Contractor is found to be charging any amount from the manpower on its roll in any manner, the agreement shall be terminated immediately with forfeiture of Performance Security amount and also the Contractor will be blacklisted. Any amount received from its manpower as registration or any fees by the Contractor will be recovered from the pending bills and will be paid directly to the concerned manpower.</p>
<p><b>CONTRACTOR'S REPRESENTATIVE</b></p>	<p>The Contractor shall nominate a coordinator/ Single Point of Contact (SPOC) who shall be responsible for regular interaction with BHEL so that optimal services of the persons deployed could be availed without any disruption.</p>
<p><b>STATUTORY OBLIGATIONS/ COMPLIANCES/ REQUIREMENTS</b></p>	<p>23.1 Contractor shall comply with all the statutory requirements, rules, regulations, notifications in relation to employment of his workforces. The Contractor shall duly comply with all Acts, Laws, or other Statutory rules, regulations, bye-laws applicable or which might become applicable to the place of work with regard to the performance of the work under the contract. Contractor shall indemnify BHEL against all claims and losses arising out of any non-compliance and violation of any applicable Law in connection with the subject matter of the contract. Contractor, wherever applicable, shall maintain proper records prescribed by the concerned statutory authorities and also provide a copy of the same to BHEL.</p> <p>23.2 The Contractor shall alone be responsible for Compliance of all labour legislation's (as may be amended from time to time) in respect of persons employed by or through him and deputed for the services being provided to <b>BHEL.</b></p> <p>23.3 Minimum rates of wages shall be as per the notifications of concerned State Government/Appropriate Government from time to time.</p> <p>23.4 The Contractor shall prepare, maintain and submit all records, documents, returns, registers, notice, etc. as required under various Labour Legislations in the prescribed manner as applicable from time to time and within prescribed time to the concerned statutory authorities and produce the same on demand. <b>The Contractor</b> shall keep itself updated of the various labour laws as applicable to it and which may become applicable to it from time to time and shall take effective and speedy steps to comply with the same. In the event of breach of any law as applicable to its personnel or otherwise, by the contractor, <b>the Contractor</b> alone shall be responsible and liable for legal action that may arise as a result of such breach or violation and consequences thereof, if any.</p> <p>23.5 The Contractor shall ensure to pay the entire wages payable by it under Minimum Wages Act as applicable from time to time to the workforce deployed / to be deployed and further ensure to deposit the PF and ESI contribution on such gross wages with the appropriate authorities within due dates and shall submit the copy of challan for the PF &amp; ESI contribution deposited by it along with its details to BHEL as and when called upon to do so. It is agreed that BHEL shall be entitled to withhold contractor's payment, should the contractor fail to submit records of statutory compliances as and when called for, until such record is produced before BHEL. <b>If it is discovered that the Contractor has failed in its statutory compliances, BHEL shall terminate the Contract.</b></p>

Place:  
Date:

Signature of Authorized Signatory  
with seal & full address

**NAME OF WORK: SERVICE CONTRACT FOR PART PROCESSING OF LOOSE TUBE BENDS AS PER BHEL DRAWING AT BHEL PREMISES FOR ONE YEAR.**

**Tender Enq. No.: 9472600019/ 29-04-2026; GeM Bid No.: GEM/2026/B/7449412**

		<p>23.6 The <b>Contractor</b> will regulate recruitment, terms &amp; conditions of employment, welfare amenities, disciplinary action, grievance handling, transfer, promotion, wages, allowances, leaves/holidays &amp; benefits, provision for lunch, etc. of personnel deployed with BHEL.</p> <p>23.7 The Contractor shall ensure that the personnel deployed in the premises of BHEL follow the safety norms, rules, regulations and instructions strictly including prohibiting smoking inside the Premises.</p> <p>23.8 The Contractor shall prepare and disburse wages/salaries of its personnel latest by 7<sup>th</sup> of every month or as prescribed by law from time to time and shall not delay the same for any reasons whatsoever. <b>The Contractor</b> shall provide <b>BHEL with</b> a copy of salary/wage payment register duly certified by <b>it</b> as and when required by BHEL. <b>BHEL</b> shall be entitled to depute it representative to oversee the disbursement of wages/salaries.</p> <p>23.9 The Contractor <b>shall</b> be liable to pay retrenchment compensation, notice pay, gratuity or bonus as payable to its personnel as and when required and BHEL shall not be liable for any such obligation of the <b>Contractor</b>.</p>
	<p><b>DEATH CUM ACCIDENTAL INSURANCE POLICY</b></p>	<p><b>The Contractor shall necessarily buy death cum accidental insurance (24x7) policy for all of his workforce to be deployed under the contract before the start of work. No workforce should enter the BHEL-premises or working area without insurance cover. Copy of the Insurance Policy to be necessarily submitted by the Contractor in the first month itself of start of the contract.</b> The coverage shall be of Rs. <b>5.00 Lakhs</b> per individual. The sum assured (Rs. <b>5.00 Lakhs</b>) shall become payable to the nominee/legal heir in the event of death due to accident of insured person. In the event of death of any member of workforce deployed by the contractor without proper insurance cover, the contractor shall be liable to pay Rs. <b>5.00 Lakhs</b> to the nominee/ legal heir of such deceased member of workforce. Accident Insurance Scheme which will be a one-year cover, renewable from year to year, offering accidental death &amp; disability on account of an accident. The Contractor will be responsible to pay the premium per annum per member for all the workforce during the contract. The Contractor must submit documentary evidence to show coverage of all the workforce under the above-mentioned insurance scheme at all times during the validity of contract. The Contractor have to assess the premium of insurance cover for the entire contract period. Contractors should include the impact of cost of insurance cover in their quote (i.e. Service Charge) itself.</p>
	<p><b>CONTRACTOR'S OBLIGATIONS</b></p>	<p>25.1 The Contractor will have full and exclusive liability for Wages, PF, ESI, Bonus, Insurance, overtime, Uniform etc.; for the personnel deployed by the contractor and other obligation arising under the applicable law at present and hereafter imposed by the Government / Local Bodies. The Contractor shall be fully responsible for the timely payment of wages, provident fund, bonus or any other benefits payable under the aforesaid Acts, Laws and regulations to the Workforce engaged by him at the work premises of BHEL. BHEL shall not be responsible for these payments or any other liability on this account. The Contractor shall also indemnify and compensate BHEL for any liability incurred by BHEL, including costs incurred thereon. In such an event, the nominated officer of BHEL shall be entitled to recover the amount so incurred, from the contractor, including forfeiture of the Security Deposit; and, if the sum so payable and / the Security Deposit is less than the amount due, it shall be lawful for BHEL to recover the balance amount as a debt from the Contractor.</p> <p>25.2 Contractor will ensure that the job is executed through his workforce on his rolls and under no circumstances the contractor will deploy any casual workforce to carry out the job nor shall sub-contract the job.</p> <p>25.3 The Contractor shall perform the work assignments to the satisfaction of BHEL. In case of unsatisfactory performance by the Contractor, BHEL shall</p>

Place:  
Date:

Signature of Authorized Signatory  
with seal & full address

**NAME OF WORK: SERVICE CONTRACT FOR PART PROCESSING OF LOOSE TUBE BENDS AS PER BHEL DRAWING AT BHEL PREMISES FOR ONE YEAR.**

**Tender Enq. No.: 9472600019/ 29-04-2026; GeM Bid No.: GEM/2026/B/7449412**

	<p>intimate the same in writing to the Contractor; however, if the performance of the contractor does not improve within 7 days from the date of the above intimation, then, BHEL shall have the right to terminate the contract by giving one month's notice. BHEL shall also have the right to recover its damages (10%) from the Security Deposit received from the Contractor or any other financial holds including future invoices in the present or any other contract between the parties.</p> <p>25.4 The Contractor shall exhibit its licence (Labour Licence if applicable etc.) or copy thereof in a conspicuous place at its place of work in BHEL premises. Every contractor shall display an abstract of the Contract Labour (Regulation and Abolition) Act, 1970 and rules in English and Hindi and in the language spoken by the majority of workforce in such form as may be approved by the Chief Labour Commissioner (Central).</p> <p>25.5 Contractor shall ensure necessary assistance by its workforce to the police or to BHEL's authority in the process of any investigation pertaining to the activities of the Contractor.</p> <p>25.6 It shall be the sole responsibility of the Contractor to settle disputes, if any arising out of the engagement between himself and the personnel engaged by him. In the event, any personnel approach the Competent Authority under any law or to the Court, the entire expenses in this behalf shall be borne by the Contractor.</p> <p>25.7 The entire administration and deployment of the workforce will be the responsibility of the Contractor. The Proprietors/director(s) / authorized representative(s) on behalf of Contractor shall visit and check their workforce deployed at BHEL premise periodically in different shift and monitor their performance.</p> <p>25.8 Personal bag &amp; baggage of all the workforce deployed by Contractor at BHEL-Premise shall be liable for physical check-up both at the time of entry into the campus and while leaving at the security gate.</p> <p>25.9 The contractor shall ensure that while on duty, his workforce puts proper uniforms in distinctive color code and in neat &amp; clean conditions issued to them by the Contractor.</p> <p>25.10 For security reasons, the contractor shall furnish /submit the details of his workforce along with photograph at BHEL's Security Office before they are brought into the BHEL-premise for providing various services. Without the prior knowledge of the BHEL, the contractor shall not deploy any workforce for any job within BHEL premises. In case the Contractor decides to change one or more member of his workforce, this shall be brought in writing to the notice of the BHEL.</p> <p>25.11 The contractor shall not deploy any workforce below the age of 18 years.</p> <p>25.12 The contractor's workforce shall not loiter in the BHEL premises and also not normally move out of their specified areas. Persons other than those who are required to work or visit the specified premises shall not be allowed into such places.</p> <p>25.13 The contractor's workforce shall not indulge in entertaining their guests/outsideers in the work premise during their working hours.</p> <p>25.14 While every care has been taken to ensure that the contents (w.r.t. Statutory Obligations / Compliances) of this tender document are accurate and up to date. In case of any conflict between the statutory provisions stipulated in this tender document and in the original source such as applicable Acts or the prevailing laws</p>
--	---

Place:  
Date:

Signature of Authorized Signatory  
with seal & full address

**NAME OF WORK: SERVICE CONTRACT FOR PART PROCESSING OF LOOSE TUBE BENDS AS PER BHEL DRAWING AT BHEL PREMISES FOR ONE YEAR.**

**Tender Enq. No.: 9472600019/ 29-04-2026; GeM Bid No.: GEM/2026/B/7449412**

		<p>/ rules, the statutory provisions contained in the extant law/rule and the original instructions shall prevail.</p> <p>25.15 All the consumable materials will be of standard quality as mentioned in the scope of services and that will be verified by the Company Representative before the use.</p> <p>25.16 The Workforce deployed by the Contractor shall have no right or claim or complaint of any nature whatsoever against BHEL including permanent absorption in BHEL. Any complaint as regards the working condition or dispute of any nature can only be taken up through the Contractor.</p>
	<p><b>CARE &amp; TREATMENT:</b></p>	<p>Contractor or his representative should be in regular touch with all his workforce during all work timings. If any member of workforce falls ill or suffers an accident / injury, the contractor or his authorized representative, shall immediately arrange to take him/her for proper medical care. Delay / ignoring will be treated as violation of contractual obligations. <b>Provisions of First Aid Facility should be provided &amp; maintained by the Contractor so</b>, as to be readily accessible during all working hours. In case, while on duty and during the course of engagement in work premises of BHEL under this Agreement, if any of the Contractor's Workforce meet (s) with any injury / illness due to accident or other natural calamities, the Contractor shall ensure that immediate and adequate medical aid viz., first -aid and subsequent treatment facilities are provided to the person(s) concerned free of cost without fail. In addition, the Contractor shall also be liable for meeting other statutory liabilities like ESI, Insurance etc. Contractor shall make every arrangement to render all the possible assistance to their workforce in such cases.</p>
	<p><b>REGISTERS AND RECORDS AND COLLECTION OF STATISTICS</b></p>	<p>All registers and other records required to be maintained under various Labour Laws / Rules, shall be maintained complete and up-to-date, and, unless otherwise provided for, shall be kept with Work Supervisor or the nearest convenient building within the precincts of the workplace or at a place within a radius of three kilometres. Such registers shall be maintained legibly in English and Hindi or in the language understood by the majority of the workforce. In case of any call seeking information or statistics in relation to Contractor's workforce at any time by an order in writing, the same should be provided without fail. The contractor shall maintain all Register(s); or alternative suitable Register(s) in lieu of any of the registers prescribed below.</p> <p><b>27.1 Contract Labour (Regulation &amp; Abolition), Act, 1970 &amp; Payment of Wages Act, 1936:</b></p> <ul style="list-style-type: none"> <li>• Employee Register in FORM- A.</li> <li>• Wage Register in FORM- B.</li> <li>• Register of Loan / Recoveries in FORM- C</li> <li>• Attendance Register in FORM- D.</li> <li>• Employment Card in FORM – XII</li> <li>• Copies of Wage Slips in FORM – XIX.</li> <li>• Copies of Half-Yearly Returns in in FORM –XXIV.</li> </ul> <p><b>27.2 Employee State Insurance Act, 1948:</b></p> <ul style="list-style-type: none"> <li>• Register of employees in FORM-6</li> <li>• Accident Book in FORM-11</li> </ul> <p><b>27.3 Employees Provident Fund &amp; Miscellaneous Provisions Act, 1952:</b> The Contractor has to maintain the Eligibility Register and Online Returns submitted in compliance to Para 36B of the EPF Scheme 1952. Copies of Nomination cum Declaration prescribed under the Payment of Wages Act 1936, The Employees Provident Fund &amp; Miscellaneous Provisions Act 1952, and The ESI Act 1948.</p> <p><b>27.4 The Payment of Bonus Act, 1962:</b></p>

Place:  
Date:

Signature of Authorized Signatory  
with seal & full address

**NAME OF WORK: SERVICE CONTRACT FOR PART PROCESSING OF LOOSE TUBE BENDS AS PER BHEL DRAWING AT BHEL PREMISES FOR ONE YEAR.**

**Tender Enq. No.: 9472600019/ 29-04-2026; GeM Bid No.: GEM/2026/B/7449412**

		<ul style="list-style-type: none"> <li>Register showing the details of the amount of bonus due to each of the contract workers, the deductions under Sections 17 and 18 and the amount actually disbursed, in <b>FORM- C</b>.</li> <li>The contractor shall send a return in <b>FORM – D</b> to the Inspector so as the reach him within 30 days after the expiry of the time limit specified in Section 19 for payment of Bonus.</li> </ul> <p><b>27.5 The Ease of Compliance to Maintain Registers under various Labour Laws Rules, 2017:</b> Ministry of Labour &amp; Employment has since notified “Ease of Compliance to maintain Registers under various Labour Laws Rules, 2017” on 21st February 2017 which has in effect replaced the 56 Registers/Forms under 9 Central Labour Laws and Rules made thereunder in to 5 common Registers/Forms. This will save efforts, costs and lessen the compliance burden by various establishments. These Rules are available on the Website of this Ministry at the link below:  <a href="http://labour.gov.in/whatsnew/ease-compliance-maintain-registers-undervarious-labour-laws-rules-2017">http://labour.gov.in/whatsnew/ease-compliance-maintain-registers-undervarious-labour-laws-rules-2017</a></p> <ul style="list-style-type: none"> <li>Employee Register – FORM A.</li> <li>Wage Register – FORM B.</li> <li>Register of Loan/Recoveries – FORM C.</li> <li>Attendance Register – FORM D.</li> </ul>
	<b>RETURNS UNDER LABOUR LAWS</b>	The Unified Shram Suvidha Portal, developed by Government of India, facilitates reporting of inspections & submission of Returns and has also been envisaged as a single point of contact between employer, employee and enforcement agencies bringing in transparency in their day-to-day interactions. For integration of data among various enforcement Agencies, the Contractor, as an inspectable unit, is required to register and obtain Labour Identification Number (i.e. LIN) from Shram Suvidha Portal and submit the same in BHEL. Single Online Common Annual Return under 9 Central Labour Acts {(1) <i>Payment of Wages Act, 1936</i> (2) <i>Minimum Wages Act, 1948</i> (3) <i>Contract Labour (Regulation and Abolition) Act, 1970</i> (4) <i>Maternity Benefit Act, 1961</i> (5) <i>Building and Other Construction Workers (Regulation of Employment and Condition of Service) Act, 1996</i> (6) <i>Payment of Bonus Act, 1965</i> (7) <i>Inter-State Migrant Workmen (Regulation of Employment and conditions of Service) Act, 1979</i> (8) <i>Industrial Disputes Act, 1947</i> (9) <i>The Mines Act 1952</i> } has been made operational on Shram Suvidha Portal since 24th April 2015 to facilitate filing of simplified Single Online Return by the establishments instead of filing separate Returns, under the Various Acts and same shall be duly filed by the contractor with a copy to BHEL. The Contractor shall submit annual returns in Form-6A and Form 3A, prescribed under statutory EPF scheme, 1952 and annual returns in Form-6 prescribed under ESI Act, in respect of all the workforce (wherever applicable) deployed by him with a copy to BHEL.
	<b>COMPLIANCE WITH BHEL RULES</b>	The contractor shall comply with all norms stipulated by BHEL such as gate passes, discipline & decency at and around the work site etc.
	<b>INDEMNITY</b>	The Contractor shall indemnify and compensate BHEL against any liability that BHEL is subjected to on account of any statutory or contractual violation including any liability arising under the Contract Labour (Regulation and Abolition) Act, 1970 towards the workforce engaged by the contractor. BHEL shall be entitled to recover its losses arising out of such liability from the security deposit or other financial holdings in the contract. The Contractor shall also indemnify and hold BHEL harmless from and against all claims, damages, losses or expenses arising out of or resulting from the work/ services under the contract.
	<b>COMPANY REPRESENTATIVE</b>	BHEL will nominate for each work premise covered under this Agreement, a Representative (hereinafter called "the Company Representative"). The Company Representative shall be the point of contact between the Contractor and the Company.

Place:  
Date:

Signature of Authorized Signatory  
with seal & full address

**NAME OF WORK: SERVICE CONTRACT FOR PART PROCESSING OF LOOSE TUBE BENDS AS PER BHEL DRAWING AT BHEL PREMISES FOR ONE YEAR.**

**Tender Enq. No.: 9472600019/ 29-04-2026; GeM Bid No.: GEM/2026/B/7449412**

	<b>WITHDRAWAL OF WORKFORCE</b>	In the event of termination of contract for any reason whatsoever or on completion of contract, the contractor shall withdraw all his workforce from the establishment of BHEL. In case the contractor has to discontinue services of any workforce (due to any reason) deployed under this agreement at any of BHEL premise, he should settle all statutory dues/payments of such individual immediately.
	<b>INSTRUCTION BOOK</b>	The Contractor shall maintain an instruction book at job premises, serially numbered on each page, so that BHEL's visiting officers can issue instructions regarding progress and quality of job to the Contractor. The Contractor or the contractor representative will sign in the instruction book in token of receipt of and understanding of such instructions. Action taken on the instructions by the contractor or the contractor's representative shall be intimated to Company Representative or any other authorized representative of BHEL and their comment be recorded in the instruction book.
	<b>IDENTITY</b>	The Contractor shall ensure that the Workforces engaged by him must wear & display ID-cards prominently on their uniform during their duty period (as the same duly endorsed by BHEL). Each Workforce shall also wear his name badge (to be issued by the contractor) while on duty. All the personnel so deployed will follow strictly the security regulations of the BHEL, in vogue from time to time.
	<b>ATTENDANCE RECORD</b>	Attendance of the workforce deployed by the Contractor will be maintained by the Contractor and copy of such document duly signed & stamped by the Contractor shall be provided to BHEL as and when called for. Contractor shall provide proper Biometric Employment cards for the contract workers to be deployed by him for Work/Services, duly signed by the contractor or authorized person on behalf of contractor. Contractor is required to install Biometric Attendance System to regulate attendance of the workforce engaged by them. Contractor shall provide proper Biometric Employment cards for the workforce to be deployed by him for Work/Services, duly signed by the contractor or authorized person on behalf of contractor. All the workforce deployed by the Contractor at work premises should also mark their attendance in the Bio-Matric Attendance System installed at BHEL premises. For the same, the Contractor should complete all formalities before deployment of workforce at work premises. However, a physical attendance register (Muster-Roll) shall be also maintained by the concerned Work Supervisor of the Contractor at work premise for physical verification by BHEL / statutory authorities.
	<b>CHARACTER VERIFICATION AND ANTECEDENCE</b>	The contractor should get the character / antecedents of all the workforce deployed by them at the work premises, verified by the Police Authorities before engaging & deploying them in BHEL premises. It is mandatory for the Contractor to Arrange / Apply for "On Line" Police Verification in respect of each individual deputed for BHEL on his own expenses and submit Police Verification Report obtained from the Police Authorities in respect of each individual before deploying him/her for BHEL treating it as a mandatory requirement. Please note that online application for Police Verification is to be made by the Contractor himself/themselves giving declaration that the individual in question is his/their own employee. Police Verification applied by the individual will not be accepted. In case the contractor desires to change the Workforce deployed by him/her due to any reason or BHEL requires the Contractor to withdraw any workmen, the new incumbent (replacement) should be deployed subject to verification as explained above.
	<b>CHARGES FOR EXTRA SERVICES</b>	The Contractor shall be entitled to claim additional charges for extra services beyond the initial scope of work at the rates agreed under the Special Conditions of the Contract. In addition to normal duty hours, extra services may be required. However, the Contractor shall not render any extra services unless he receives specific written instructions from Company Representative of BHEL. The Contractor shall ensure that the personnel deployed by it receive their overtime charges as prescribed under the law applicable at the place of deployment, if they are made to work for extra hours or on holidays by the Contractor.

Place:  
Date:

Signature of Authorized Signatory  
with seal & full address

**NAME OF WORK: SERVICE CONTRACT FOR PART PROCESSING OF LOOSE TUBE BENDS AS PER BHEL DRAWING AT BHEL PREMISES FOR ONE YEAR.**

**Tender Enq. No.: 9472600019/ 29-04-2026; GeM Bid No.: GEM/2026/B/7449412**

<p><b>WORKING DAYS / HOLIDAYS / LEAVE</b></p>	<p>38.1 All the workforce must be allowed at least one whole day of rest / weekly-off for every six continuous working days or as laid down in the prevailing laws. No deduction shall be made by the Contractor from the wages of any workforce on account of Weekly-Off, National Holidays or Public Holidays. Workforce deployed by the Contractor shall be required to work normally on all six days (Monday to Saturday) for 8 ½ Hrs. with a break of half-an-hour after every 04 Hrs. or as provided under the applicable law from time to time. The Contractor's shall ensure that its workforce is granted leaves as per the applicable Shops and Establishment Act or Factories Act as amended from time to time.</p> <p>38.2 Payment against encashment of paid leave shall be made to the Contractor when the Contractor submits proof of such payment at the end of one year i.e. annual basis (and not with every monthly bill).</p> <p>38.3 If there are any changes in statutory laws / periodicity of payment of leave entitlement or if any other leave / holidays are enforced or modified in future, the Contractor will be authorized for billing to cover the same accordingly. The Contractor will maintain proper records of Leaves/ Holidays/ Weekly off etc. granted to the workforce.</p>
<p><b>WORKING TIME &amp; NATURE OF SERVICES</b></p>	<p>The contractor shall perform all the job / services as details mentioned in the scope of work.</p>
<p><b>SAFETY, HEALTH AND ENVIRONMENT (SHE) MANAGEMENT</b></p>	<p>40.1 All necessary precautions for safety of the man / machine, fire hazard &amp; environmental aspects shall have to be taken by the Contractor for the activities performed by his workforce.</p> <p>40.2 The Contractor will be responsible for meeting all obligations for providing a safe and healthy workplace for its workforce. The contractor will be responsible for frequent and regular safety inspections of the worksites, materials, and equipment by its competent employees.</p> <p>40.3 <b>Safety and Personal Protective Equipment:</b> Unless otherwise specified, the contractor is responsible for providing all necessary safety and personal protective equipment (PPE) needed by its workforce. This equipment must meet appropriate OSHA requirements and be in good working order. The contractor shall ensure that its workforce have received appropriate training on the use and maintenance of safety and PPE prior to its use. Failure to correctly use appropriate safety equipment is a violation of the contract and may result in damages in law and any applicable penalties in line with Special Conditions of the Contract.</p> <p>40.4 <b>Safety Training:</b> The contractor must ensure that its workforces have completed appropriate health and safety training when required by statute/regulation and provide documentation of such training when required by BHEL.</p> <p>40.5 <b>Safety and Health Plan:</b> The contractor must develop and implement a comprehensive health and safety plan for his or her workforce, which covers all aspects of operations and activities associated with the contract. This plan must comply with all statutorily applicable health and safety regulations and any project specific requirements that BHEL has specified.</p> <p>40.6 It will be solely the Contractor's responsibility to fulfill all the legal formalities with respect to the "<b>National Policy on Safety, Health and Environment at Workplace</b>".</p>
<p><b>BHEL'S RIGHT TO WITHDRAW / RELAX</b></p>	<p>BHEL reserves the right to withdraw / relax any of the terms and condition mentioned in the contract, so as to overcome the problem encountered at a later stage. No such withdrawal or relaxation in any term shall be deemed to affect the</p>

Place:  
Date:

Signature of Authorized Signatory  
with seal & full address

**NAME OF WORK: SERVICE CONTRACT FOR PART PROCESSING OF LOOSE TUBE BENDS AS PER BHEL DRAWING AT BHEL PREMISES FOR ONE YEAR.**

**Tender Enq. No.: 9472600019/ 29-04-2026; GeM Bid No.: GEM/2026/B/7449412**

		other terms and conditions of the contract unless done so expressly and in writing.
	<b>NO EMPLOYER EMPLOYEE RELATIONSHIP</b>	The workforce deployed by the Contractor shall be the employees of the Contractor and there shall not be any employer – employee relationship between BHEL and the said workforce of Contractor on any ground whatsoever. BHEL will not issue any experience certificate to the workforces of the Contractor.
	<b>FACILITIES AND UTILITIES TO BE PROVIDED BY THE BHEL TO CONTRACTOR AT SITE</b>	<p>43.1 <b>WATER &amp; ELECTRICITY:</b> Water &amp; electricity shall be supplied to the contractor by BHEL free of cost subject to that the contractor will utilize the Water/Electricity for the services to be provided to BHEL. BHEL does not guarantee to maintain uninterrupted supply of water/ electricity and it will be incumbent on the contractor to make alternative arrangement for proper supply of the same at their own cost in the event of any break down in the government water/ electricity mains so that the services to be provided against this contract is not held up for the want of the same.</p> <p>43.2 <b>STORES:</b> The contractor shall be provided free of cost a space for storing the materials related to the scope of work which will be utilized against this contract only. The contractor shall at all times keep the place tidy, clean and in sanitary condition to the entire satisfaction of the Officer In-charge. The safety &amp; security of the contractor’s materials will be the responsibility of contractor himself. BHEL will not provide any compensation due to theft, damage or loss of contractor’s materials. The stores provided to the contractor will not be utilized as the accommodation for the workers or for any other purpose than storing the materials related to housekeeping and catering services.</p>
	<b>CONTRACTOR’S WORKFORCE</b>	<p>44.1 The Contractor shall provide workforce in sufficient numbers to meet the requirement of the scope of work and to the satisfaction of the BHEL’s Company Representative. Estimated quantities envisaged for all services shall be as provided in the Special Conditions. In order to maintain quality services and minimize operational problems, the contractor may rotate the workforce with prior intimation to BHEL. For satisfactory services, the Contractor shall continuously maintain workforce strength as required to cope up with the requirement as arisen for satisfactory services to BHEL. Contractor has to deploy the minimum workforce as emphasized in the scope of services in the contract at any given day. Any deficiencies of the scope of services, the monthly payment against the job / services provided shall be deducted to the tune of shortages.</p> <p>44.2 The workforce shall be classified as follows-</p> <p>i) <b>TYPE-A- Unskilled (USW):</b> For providing Services at Job-Premise, the Contractor has to deploy unskilled workforce who must be minimum 5th Pass and know operations that involve the performance of simple duties, which require the experience of little of no independent judgment or previous experience although familiarity with the occupational environment is necessary.</p> <p>ii) <b>TYPE-B- Semi-skilled (SSW) / Non- Matriculate:</b> For providing services at Job- Premise, the Contractor has to deploy semiskilled workforce who must be minimum Non Matriculate (8th Pass), his/her work will be limited to the performance of routine operations of limited scope.</p> <p>iii) <b>TYPE-C- Skilled (SW)/Work Supervisor (SW) / Matriculate:</b> For providing Services at Job Premise, the Contract has to deploy skilled workforce who must be Matriculate (10th Pass), his/her shall be capable of working efficiently of exercising considerable independent judgement and of discharging his duties with responsibility. They must possess thorough &amp; comprehensive knowledge of the trade, craft or industry in which they will be deployed by the Contractor. Specific work, wherever required, work supervisor, receptionist etc. should have basic knowledge of operating computer. The Contractor i.e. the employer of contract workers will give certification regarding eligibility of an individual for his/her respective category for TYPE-A, TYPE-B &amp; TYPE-C (mentioned above) on the basis of their skills/experience etc.</p> <p>44.3 Efficiency, promptness, quality service, good behavior and politeness of the workforce are shall be ensured at all times. The Contractor is required to</p>

Place:  
Date:

Signature of Authorized Signatory  
with seal & full address

**NAME OF WORK: SERVICE CONTRACT FOR PART PROCESSING OF LOOSE TUBE BENDS AS PER BHEL DRAWING AT BHEL PREMISES FOR ONE YEAR.**

**Tender Enq. No.: 9472600019/ 29-04-2026; GeM Bid No.: GEM/2026/B/7449412**

		<p>supervise the operations at all working hours and his manager or supervisor shall personally supervise operations in the kitchen and dining area at the BHEL premises.</p> <p>44.4 The workforce deployed by the contractor shall be hail and healthy and should not be suffering from any communicable diseases. The contractor shall get his employee medically examined on regular intervals and such reports shall be produced as and when called upon by BHEL.</p> <p>44.5 The persons deployed by the Contractor shall not be entitled to pay, perks and other facilities admissible to regular/ confirmed employees during the currency or after expiry of the Agreement.</p> <p>44.6 No medical facilities or reimbursement or any sort of medical claims thereof in respect of workforces provided by the Contractor will be entertained by BHEL.</p> <p>44.7 The Contractor shall furnish the following documents in respect of the manpower deployed by them to BHELs premise/ designated premise in the given time limit:</p> <ul style="list-style-type: none"> <li>• List of persons deployed (monthly)</li> <li>• Biodata/resume with antecedents' details (at the time of deployment)</li> <li>• Copy of Aadhaar Card of the candidates (at the time of deployment)</li> <li>• Identity Cards issued by Contractor bearing photograph (within 8 days of joining)</li> <li>• Identity proof and residential proof (at the time of deployment)</li> <li>• Copy of police verification certificate (at the time of deployment)</li> <li>• Copy of birth certificate, if required (at the time of deployment - for domicile purpose)</li> </ul> <p>44.8 For all intents and purposes, the Contractor shall be the "Employer" within the meaning of different Rules &amp; Acts in respect of manpower so deployed. The persons deployed by the Contractor shall not have any claim whatsoever like employer and employee relationship with BHEL. No deployed manpower shall be allowed to stay in the BHEL's premise/ designated premise unnecessarily after working hours without BHEL's permission.</p>
	<p><b>SUPERVISION OF CONTRACTOR'S WORKFORCE</b></p>	<p><b>SUPERVISORY SERVICES:</b> Due supervision of jobs at the work premises shall be ensured by the contractor's work supervisors daily for closely monitoring services under the job contract and work supervisor shall be equipped with cell phone facility for effective coordination with BHEL. Adequate intercommunication facilities for communication between supervisors/manager shall also be provided by the contractor. The major responsibility of the works Supervisor would be as under:</p> <p>45.1 Obtaining instructions from the concerned BHEL Official(s) for carrying out the works pertaining to their areas.</p> <p>45.2 Passing on the work instructions to his team of workforce ensuring completion of work within the stipulated time as instructed above and as per the terms &amp; conditions of the tender document.</p> <p>45.3 To ensure proper conduct and discipline by his team of workforce, while performing their duty at BHEL premises.</p> <p>45.4 To report / intimate any constraint in writing, if so felt, during the execution of designated works by his team of workforce.</p>
	<p><b>ASSIGNMENT</b></p>	<p>The Contractor shall not, without the express prior written consent of BHEL, assign to any third party the Contract or any part thereof, or any right, benefit, obligation or interest therein or thereunder.</p>
	<p><b>TERMINATION</b></p>	<p><b>47.1 Termination for BHEL's Convenience</b></p> <p>(i) BHEL may at any time terminate the Contract for any reason by giving the Contractor a notice of termination that refers to this clause.</p> <p>(ii) Upon receipt of the notice of termination under Sub clause 1), the Contractor shall, either immediately or upon the date specified in the notice of termination,</p> <p>(a) cease all further work, except for such work as BHEL may specify in the notice of termination; and</p> <p>(b) remove all Contractor's Equipment from the Site, repatriate the Contractor's personnel from the Site, remove from the Site any wreckage,</p>

Place:  
Date:

Signature of Authorized Signatory  
with seal & full address

**NAME OF WORK: SERVICE CONTRACT FOR PART PROCESSING OF LOOSE TUBE BENDS AS PER BHEL DRAWING AT BHEL PREMISES FOR ONE YEAR.**

**Tender Enq. No.: 9472600019/ 29-04-2026; GeM Bid No.: GEM/2026/B/7449412**

		<p>rubbish and debris of any kind, and leave the whole of the Site in a clean and safe condition.</p> <p>(c) In the event of termination of the Contract under Sub clause 1), the BHEL shall pay to the Contractor the Contract Price, properly attributable to the parts of the Facilities executed by the Contractor as of the date of termination;</p> <p><b>47.2 Termination for Contractor's Default</b></p> <p>(i) BHEL, without prejudice to any other rights or remedies it may possess, may terminate the Contract forthwith in the following circumstances by giving a notice of termination and its reasons therefor to the Contractor:</p> <p>a) if the Contractor becomes bankrupt or insolvent, has a receiving order issued against it, compounds with its creditors, or, if the Contractor is a corporation, a resolution is passed or order is made for its winding up, other than a voluntary liquidation for the purposes of amalgamation or reconstruction, a receiver is appointed over any part of its undertaking or assets, or if the Contractor takes or suffers any other analogous action in consequence of debt; and</p> <p>b) has abandoned or repudiated the Contract or has without valid reason failed to commence work on the Facilities promptly or has suspended the progress of Contract performance after receiving a written instruction from the BHEL to proceed;</p> <p>c) persistently fails to execute the Contract or remedy any breach or persistently neglects to carry out its obligations under the Contract;</p> <p>then BHEL may, without prejudice to any other rights it may possess under the Contract, give a notice to the Contractor, stating the nature of the default and requiring the Contractor to remedy the same. If the Contractor fails to remedy or to take steps to remedy the same within 14 days of its receipt of such notice, then BHEL may terminate the Contract forthwith by giving a notice of termination to the Contractor.</p> <p>a) Upon receipt of the notice of termination under Sub clause (i), the Contractor shall, either immediately or upon such date as is specified in the notice of termination, cease all further work, except for such work as BHEL may specify in the notice of termination.</p> <p>(ii) the Contractor shall be entitled to be paid the contract price attributable to the works executed/services performed upto the date of termination. Any sums due to BHEL from the Contractor accruing prior to the date of termination and already intimated to the Contractor shall be deducted from the amount to be paid to the Contractor under this Contract.</p> <p><b>47.3 Termination by Contractor</b></p> <p>(i) If BHEL has failed to pay the Contractor any sum due under the Contract within the specified period, if any, without just cause, the Contractor shall give a notice to BHEL of the same.</p> <p>(ii) If BHEL fails to pay such sums or give its reasons for withholding such sums within 14 days after receipt of the Contractor's notice, the Contractor may by a further notice to BHEL shall be entitled terminate the Contract.</p> <p>(iii) In calculating any monies due from the BHEL to the Contractor, account shall be taken of any sum previously paid to the Contractor under the Contract, including any advance payment paid. The Contractor shall be entitled to be paid the contract price attributable to the works executed/services performed upto the date of termination</p>
	<p>SUSPENSION OF BUSINESS DEALINGS</p>	<p>BHEL reserves the right to take action against Contractors who either fail to perform or indulge in malpractices, by suspending business dealings with them in line with BHEL guidelines issued from time to time.</p>

Place:  
Date:

Signature of Authorized Signatory  
with seal & full address

**NAME OF WORK: SERVICE CONTRACT FOR PART PROCESSING OF LOOSE TUBE BENDS AS PER BHEL DRAWING AT BHEL PREMISES FOR ONE YEAR.**

**Tender Enq. No.: 9472600019/ 29-04-2026; GeM Bid No.: GEM/2026/B/7449412**

TECHNICAL BID FORM (Part-I)				
Note: All relevant details should be filled by bidder and the same documents to be uploaded in GeM portal. Ref tender document for more details.				
Sl. No.	DESCRIPTION	RESPONSE	ATTACHMENT IN ONLINE PORTAL	APPLICABILITY
1	Name of the Enterprise/ Company/ Firm			
2	BHEL VENDOR CODE (IF ANY)			
3	Address of the Firm/ Company			
4	Name, Designation and Contact details of person signing the Tender. (In case of authorized signatory signing the tender, the copy of Power of Attorney (POA) should be uploaded as per tender <b>document Annexure - 15</b> )		ATTACH (POA)	IF APPLICABLE
5	Contact Phone no. (Landline)			
6	Mobile Number			
7	EMAIL ID			
8	UDYAM REGN. NO.		ATTACH	IF APPLICABLE
9	<b>Qualifying Criteria:</b>			
A	<b>Earnest Money Deposit: ₹ 2,00,000.00/- (2 lakhs)</b> <b>(EMD):</b> / EMD should be submitted as per Prequalification Bid/EMD (including EMD waiver, if any). Techno-commercial bid will be considered only if the Prequalification Bid/EMD is valid. EMD in any other form and tender without EMD will be summarily rejected. <b>(Copy to be uploaded in GeM portal)</b>		MANDATORY	
B	<b>STATUS OF THE COMPANY:</b> <b>The following documents to be submitted as per the status of the company</b> <ul style="list-style-type: none"> <li>• Proprietorship: PAN card on owner name</li> <li>• For partnership firms: PAN card and PARTNERSHIP DEED</li> <li>• For others: PAN card in the name of company / firm / business and CERTIFICATE OF INCORPORATION / MOA and AOA.</li> <li>• GST Registration certificate</li> </ul> <b>(Copy to be uploaded in GeM portal)</b>		MANDATORY	

Place:  
Date:

WCM Dept. / 3<sup>rd</sup> Floor, 24 Bldg. / BHEL, Trichy-14

Signature of Authorized Signatory  
with seal & full address  
Page 1 of 3

**NAME OF WORK: SERVICE CONTRACT FOR PART PROCESSING OF LOOSE TUBE BENDS AS PER BHEL DRAWING AT BHEL PREMISES FOR ONE YEAR.**

**Tender Enq. No.: 9472600019/ 29-04-2026; GeM Bid No.: GEM/2026/B/7449412**

C	<p><b>PROOF OF EXPERIENCE:</b> The bidder should have operational <b>experience in execution of tube / pipe bending for boiler / pressure part components</b> within the last five years.</p> <p><b>Documentary evidence of this experience must be submitted with the offer:</b></p> <ul style="list-style-type: none"> <li>• Above experience other than BHEL to be supported by Purchase Order / Work Order / agreement copy along with Completion certificate from work executed agencies.</li> <li>• Above experience from BHEL to be supported by PO/ Work Order copy</li> </ul>		MANDATORY	
D	<p><b>Tender document (all pages)</b> duly Signed &amp; sealed by bidder's Authorized signatory.  <b>(Digitally/ Physically Signed copy of Tender document to be uploaded in GeM portal)</b></p>		MANDATORY	
E	<p><b>All Annexures (Annexure- 1 to 11) duly filled, Signed &amp; seal by bidder's Authorized signatory on bidder's letter head. (to be uploaded in GeM portal)</b></p>		MANDATORY	
F	<p><b>Integrity Pact (Annexure-8)</b> duly signed and stamped with address and witness signed with name and address.</p>		MANDATORY	
G	<p><b>POWER OF ATTORNEY (Annexure-15)</b> to be typed on non-judicial stamp paper of <b>minimum Rs. 100/- and Notarized</b></p>		MANDATORY	
H	<p><b>Conflict of Interest among Bidders/ Agents (Annexure-19)</b> to be typed and submitted in the <b>Letterhead</b> of the Company/Firm of Bidder failing which the offer of Bidder is liable to be summarily rejected.</p>		MANDATORY	
I	<p><b>FINANCIAL:</b> Bidders must have achieved an average annual financial turnover (Audited) of <b>₹ 25.88 Lakhs /-</b> or more, over the last Three Financial Years (FY) i.e., 2022-23, 2023-24, 2024-25. (i.e., Assessment year 2023-24, 2024-25, 2025-26). Financial Year to be considered as 1st April to 31st March.  Copy of Income Tax Submission Acknowledgment and copy of Audited Profit &amp; Loss account and Balance Sheet indicating CA membership number including sign-seal of CA to be submitted along with offer.</p>		MANDATORY	

Place:  
Date:

**NAME OF WORK: SERVICE CONTRACT FOR PART PROCESSING OF LOOSE TUBE BENDS AS PER BHEL DRAWING AT BHEL PREMISES FOR ONE YEAR.**

**Tender Enq. No.: 9472600019/ 29-04-2026; GeM Bid No.: GEM/2026/B/7449412**

J	Income Tax Registration ( <b>PAN NUMBER</b> ) (Copy to be uploaded in GeM portal)		MANDATORY	
K	<b>GST Regn. No.</b> (Copies to be uploaded in GeM portal)		MANDATORY	
L	<b>% OF GST APPLICABLE TO THE VENDOR FOR THIS WORK</b> (In case of GST exempted vendor they can put NIL).	_____%	MANDATORY	TO BE FILLED
M	EPF Registration (Copy of EPF Registration to be uploaded)		MANDATORY	
N	ESI Registration (Copy of ESI Registration to be uploaded)		MANDATORY	
10	NEFT BANK FORMAT (If applicable)		ATTACH	IF APPLICABLE
11	In case of bid submitted by partnership firm, PAN of all partners to be uploaded. (Copy to be uploaded in GeM portal)		ATTACH	IF APPLICABLE
12	DISCLAIMER CLAUSE: Neither the Organization (Bharat Heavy Electricals Ltd.) nor the service provider (M/s. GeM.) is responsible for any failure of submission of bids due to failure of internet or other connectivity problems or reasons thereof. (To be agreed by bidder)		To be "AGREED" by bidder	
13	Offer should be submitted as single part bids (Techno-commercial bid + Price bid) in the GeM portal. Sufficient notice would be given by BHEL for corrigendum / extensions and it will be published in following websites- <a href="https://gem.gov.in/">https://gem.gov.in/</a> , <a href="http://bhel.com">http://bhel.com</a> ; After the scrutiny of techno-commercial bids, the price bids of only techno-commercially qualified offers will be opened with prior intimation. (To be agreed by bidder)		To be "AGREED" by bidder	
14	Declaration for website downloaded and non-tampering of tender document: I/We hereby declare that I/We have downloaded the Tender Document from the website <a href="https://gem.gov.in">https://gem.gov.in</a> and I/We have not tampered the tender document. In case at any stage, if it is found that the information given above is false or incorrect, BHEL shall have the absolute right to take any action as deemed fit without any prior intimation. (To be agreed by bidder)		To be "AGREED" by bidder	
15	I / We confirm that none of its group concern or affiliates etc., appears on the list of banned firms/ companies by BHEL (list available on <a href="http://www.bhel.com">www.bhel.com</a> ) nor any of the Director / Partner / proprietor of bidder / such group concern or affiliate etc. are involved with such company. (To be agreed by bidder)		To be "AGREED" by bidder	

Place:  
Date:

WCM Dept. / 3<sup>rd</sup> Floor, 24 Bldg. / BHEL, Trichy-14

Signature of Authorized Signatory  
with seal & full address  
Page 3 of 3