



TECHNICAL SPECIFICATION OF FGD ABSORBER AGITATORS

TRY/PE-BM/FGD/AGITATOR SPEC:001/ Rev 01





BHARAT HEAVY ELECTRICALS LIMITED
(A GOVT OF INDIA UNDERTAKING)

BOILER MOUNTING--PRODUCT ENGG(FB)
BHEL -TRICHY

TECHNICAL SPECIFICATION OF FGD ABSORBER AGITATORS

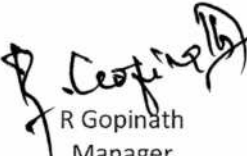
SPECIFICATION NO : TRY/PE-BM/FGD/AGITATOR SPEC:001/REV 01
BUYER (EPC) : BHEL
APPLICATION : WET LIMESTONE FGD

01	28-03-2022	General Revision	 Sathiesh Kumar S Manager PE / FB (BM)	 R Gopinath Manager PE / FB (BM)	 V. Gunasekaran DGM PE / FB (BM)
00	01-07-2021	Fresh Release	Sathiesh Kumar S	R Gopinath	V. Gunasekaran
REV	Date	Description	Prepared	Checked	Approved

This document is meant for the exclusive purpose of bidding against this specification and shall not be transferred, reproduced or otherwise used for purposes other than that for which it is specifically issued.



TECHNICAL SPECIFICATION OF FGD ABSORBER AGITATORS

TRY/PE-BM/FGD/AGITATOR SPEC:001/ Rev 01

I) DOCUMENTS TO BE SUBMITTED ALONG WITH THE OFFER:

Sl. No	Description	Offer part	Purpose
1.	Documents for meeting the Pre-Qualification Requirement as per Annexure-X has to be submitted along with supporting documents	Part -1	Qualification requirement for considering the offer
2.	Reference list – Annexure-I	Part -1	Qualification requirement for considering the offer
3.	Compliance to the Agitator and Motor Technical Specification with all Annexures.	Part-1	Technical evaluation
4.	Compliance to the Agitator Indicative MQP (Annexure-VIII) & CQR for LT Motors if Applicable (Annexure-IX)	Part -1	Technical evaluation
5.	GA drawing, Exploded view with Material of construction, total weight of all Agitators models offered	Part -1	Technical evaluation
6.	Schedule of Guarantees (Annexure-V) specific to the Enquiry	Part -1	Technical evaluation
7.	List of Deviations (Annexure-VI)	Part -1	Technical evaluation
8.	Duly filled, Mandatory Spare list (Annexure-XI)	Part -1	Technical evaluation
9.	Motor vendor list and mechanical seal vendor list	Part -1	Technical evaluation
10.	Start-up & Commissioning Spares	Part -1	Technical evaluation
11.	List of Special Tools	Part -1	Technical evaluation
12.	Catalogue	Part -1	Technical evaluation
13.	Duly filled Annexure –XII , FGD ABSORBER AGITATOR Checklist Cum Datasheet . All the documents and data as mentioned in the Annexure-XII shall be submitted by bidder for evaluation, else the offer is liable for technical rejection	Part -1	Technical evaluation



TECHNICAL SPECIFICATION OF FGD ABSORBER AGITATORS

TRY/PE-BM/FGD/AGITATOR SPEC:001/ Rev 01

II) DOCUMENTS TO BE SUBMITTED AFTER CONTRACT:

Sl. No.	Description	Purpose	Delivery Time
1.	GA drawing, Exploded view, sectional view with Material of construction, mechanical seal , gearbox for all Agitator models	END CUSTOMER/BHEL approval to start manufacturing	2 week
2.	Data sheet for all Agitator	END CUSTOMER/BHEL approval to start	2 week
3.	Agitator Performance curve of all Agitators	END CUSTOMER/BHEL approval to start	2 week
4.	Electrical motor GA drawing & Data sheet and performance curves of all motors	END CUSTOMER/BHEL approval to start manufacturing	2 week
5.	Quality plan & Inspection and Test Procedure	END CUSTOMER/BHEL approval for inspection	2 month after contract
6.	Agitator and Motor Sizing Calculation (Annexure-III)	END CUSTOMER/BHEL approval to start	2 week
7.	Bending moment and Shaft design calculation	END CUSTOMER/BHEL approval to start manufacturing	2 week
8.	GA, BOM and Technical details of Emergency Flush Pipe with Flanges and Blind Flange	END CUSTOMER/BHEL approval to start manufacturing	2 week
9.	GA, BOM and Technical details of Agitator Nozzles and Emergency Flush Pipe Nozzles GA, BOM and Technical details	For Fabrication	2 week
10.	Utility Consumption	To arrange utility	2 week
11.	Foundation Data including Anchor plan	To civil design	2 week
12.	Lubricating oil list	Record purpose	4 week
13.	Special tools list	For maintenance	4 week
14.	Installation and assembly procedure	For erection	4 week
15.	Approximate weight of each skid	To arrange lifting device	4 week
16.	Pre Commissioning Check List	For erection	4 week
17.	Operation and Maintenance Manual	For O&M	4 week
18.	Start-up & Commissioning Spares	For commissioning	4 week
19.	List of Special Tools	For arranging	4 week
20.	P & I Diagram (if applicable)	For information	4 week



TECHNICAL SPECIFICATION OF FGD ABSORBER AGITATORS

TRY/PE-BM/FGD/AGITATOR SPEC:001/ Rev 01

CONTENTS:

MAIN SUPPLY	
1.0	APPLICABLE CODES & REGULATIONS
2.0	INTENT OF SPECIFICATION
3.0	PROVENNESS CRITERIA / QUALIFICATION REQUIREMENTS
4.0	MATERIAL OF CONSTRUCTION
5.0	SCOPE OF SUPPLY
6.0	GENERAL REQUIREMENTS
7.0	PACKING & FORWARDING
8.0	SUPERVISION OF ERECTION, TESTING & COMMISSIONING
9.0	EXCLUSION
10.0	INSPECTION, TESTING AND QUALITY REQUIREMENTS
11.0	PAINTING
12.0	SPARES, TOOLS & TACKLES
13.0	PERFORMANCE GUARANTEE
14.0	BID EVALUATION CRITERIA FOR POWER CONSUMPTION
15.0	LIQUIDATED DAMAGES FOR POWER CONSUMPTION
16.0	WARRANTY / DEFECT LIABILITY
17.0	FIRST FILL OF CONSUMABLES
18.0	TRAINING
19.0	DELIVERY CONDITION
20.0	DOCUMENTATION



TECHNICAL SPECIFICATION OF FGD ABSORBER AGITATORS

TRY/PE-BM/FGD/AGITATOR SPEC:001/ Rev 01

1.0 APPLICABLE CODES & REGULATIONS

The design and materials shall conform to the requirements of applicable codes and regulations of the latest edition. The design, manufacture, installation and testing of the Agitator shall follow the latest applicable Indian/International (AISI / ASME/EN/Japanese) Standards.

2.0 INTENT OF SPECIFICATION

This specification covers the minimum requirements for the complete design, material, manufacturing, shop inspection, testing at the manufacturer's works, supervision of erection & performance testing at bidder's works/ site of Agitators along with accessories which is furnished in the Flue Gas Desulphurization plant for END CUSTOMER Project. The following points have to be noted.

- a. Agitators are envisaged in FGD Absorber.
- b. Bidder shall assume full unit responsibility for the entire equipment assembly and make all possible efforts to comply strictly with the requirements of this specification and other specifications/attachments to inquiry/order.
- c. The Bidder shall offer only proven design which meets the Provenness /Pre-qualification requirement of END CUSTOMER. Necessary document evidences as per **Annexure-X for qualification** shall be submitted along with the bid. If bidder doesn't meet the specified Provenness criteria, their offer will be rejected.
- d. In case, deviations are considered essential by the Bidder (after exhausting all possible efforts), the same shall be separately listed in the Bidder's proposal under separate section, titled as "List of Deviations/Exceptions to the Enquiry Document (**ANNEXURE VI- LIST OF DEVIATIONS OR EXCEPTIONS TO THE ENQUIRY DOCUMENT**)
- e. Any deviation, not listed under the above section, even if reflected in any other portion of the proposal, shall not be considered applicable.
- f. No deviation or exception shall be permitted without the written approval of the purchaser.
- g. Compliance to this specification shall not relieve the Bidder of the responsibility of furnishing equipment and accessories/auxiliaries of proper design, materials and workmanship to meet the specified start up and operating conditions.
- h. In case, the Bidder considers requirement of additional instrumentation, controls, safety devices and any other accessories/auxiliaries essential for safe and satisfactory operation of the equipment, the same shall be recommended along with reasons in a separate section and include the same in scope of supply.
- i. All accessories, items of work, though not indicated but required to make the system complete for its safe, efficient, reliable and trouble free operation and maintenance shall also be in supplier's scope unless specifically excluded.

3.0 PROVENNESS CRITERIA/PRE-QUALIFICATION REQUIREMENT:

The Bidders are required to meet the Pre-Qualification Requirement (PQR) for Agitators as per the Provenness Criteria & shall submit the credentials as called in **Annexure-X. Only Manufacturers qualifying as per the Qualification requirement shall be considered for placement order.**

4.0 POWER SUPPLY DETAILS:

Refer Clause 5.3 for details.



TECHNICAL SPECIFICATION OF FGD ABSORBER AGITATORS

TRY/PE-BM/FGD/AGITATOR SPEC:001/ Rev 01

5.0 SCOPE OF SUPPLY

Scope for the bidders shall include Design, Manufacturing, Supply, and Supervision of Erection & Commissioning

Design: Includes basic engineering, detail engineering, preparation and submission of engineering drawings/calculations/datasheets/quality assurance documents/field quality plans, storage instructions, commissioning procedures, operation & maintenance manuals, performance guarantee test procedures and assisting BHEL in obtaining time bound approval from END CUSTOMER.

Supply: Includes manufacturing/fabrication, shop floor testing, stage inspections, final inspections, painting & packing.

Supervision of Erection & commissioning: Includes supervision of erection & commissioning, supervision of trial operation, training of customer's O&M Personnel.

Scope of bidder	
AGITATOR ASSEMBLY complete with	
i.	AGITATOR Blades
ii.	AGITATOR Shafts
iii.	Coupling arrangement (Flexible)
iv.	Single Mechanical Seals
v.	Shaft Sleeve
vi.	Lanterns/ Stools (Bearing Housing), Safety Guard
vii.	Bearings
viii.	Agitator Mounting Flanges with gaskets and fasteners
ix.	Drive Motor(IE3) with gearbox / belt and pulley arrangement
x.	Supporting arrangement of Side Entry Agitator on the tank Wall.
xii.	Supply of Agitator Vessel Nozzle and Emergency Flush Pipe Nozzle shall be in BHEL Scope, however bidder to provide complete documents like Nozzle General Arrangement with Sectional & Plan views, BOM, Shop Manufacturing/Fabrication drawing, Procedure, Material Cutting Plan drawings indicating all required dimensions and sizes for Manufacturing/Fabrication of Agitator Vessel & Emergency Flush Pipe Nozzles. Any technical support required for Manufacturing/Fabrication of Nozzles shall be extended by bidder post order stage.
xiii.	Agitator end mating flange, gaskets, fasteners and all other accessories for mounting agitator on the Agitator Vessel Nozzle shall be in bidder scope.
xiii.	Emergency Flushing system for startup consisting of Pipe with Flange, Nozzle mating flange, Blind flange for plugging, gaskets, fasteners and all other accessories required for completeness Emergency Flushing system shall be in bidder scope.
xiv.	Foundation plate with foundation bolts
xv.	Painting and Rust Prevention during shipment and construction
xvi.	Supervision of Erection & commissioning at site
xvii.	Conducting and Proving of Performance guarantee tests at site
xviii.	Special tools & tackles as applicable
xix.	Start-up spares as applicable
xx.	Installation, operation and maintenance manuals
xxi.	Any other items required for completeness of the equipment except the items covered in the exclusions.



TECHNICAL SPECIFICATION OF FGD ABSORBER AGITATORS

TRY/PE-BM/FGD/AGITATOR SPEC:001/ Rev 01

The scope of supply for AGITATORS shall include but not limited to the following:

5.1	TECHNICAL REQUIREMENTS
1.	Agitators shall be supplied in tanks and vessels to prevent caking and settlement of particles out of the slurry, e.g. in the absorber vessel.
2.	All agitators shall be designed for continuous operation unless otherwise specified. The design of the agitators shall be of proven type. CFD analysis, if required, shall be provided during detailed engineering or drawing approval stage at no extra cost.
3.	Standard type agitators with suitable characteristics shall be used wherever practical. The agitators shall be complete with motor, gearbox, agitator shaft, coupling, safety guards, mechanical seal (for side entry agitators), impeller, support legs, agitator mounting flange including bolts nuts and gasket etc.
4.	All agitator parts and accessories in contact with the stirred fluid shall be constructed of materials specifically designed for the conditions and nature of the stirred fluid and be resistant to erosion and corrosion.
5.	MOC of various agitator parts shall be as per “Technical Information for sizing of Absorber Agitators for respective project” . This does not release the bidder of the responsibility for selecting the correct materials. All parts which are in contact with slurry or in contact with slurry fumes shall be considered as wetted part. The material selected shall be suitable to the service conditions.
6.	Each agitator and its associated equipment shall be arranged in such a manner as to permit easy access for operation, maintenance and agitator removal without interrupting plant operation. It shall be possible to remove the sealing devices of the Agitators of the absorber vessel without having to drain completely the absorber.
7.	To prevent mechanical blocking load start-up after standstill of pumps, piping and agitators for slurries shall be applied with C-hose connection.
8.	Lifting lugs and eyes and other special tackle shall be provided as necessary to permit easy handling of the agitators and their components.
9.	Static and dynamic (as far as applicable) balancing of all agitators shall be carried out after assembly.
10.	All agitator parts and components shall be designed and calculated for fatigue life, considering maximum bending loads, induced by fluctuating hydraulic forces and torsional loads, based on the installed motor power. For side entry agitators the alternating bending moment resulting from impeller and shaft weight has to be considered additionally.
11.	All exposed moving parts shall be covered by guards.
12.	The shape of the impeller blades of side entry agitators shall be designed to avoid wear on the impellers which will affect the agitator performance as specified for a minimum period of 2 years of continuous operation under design conditions for the range of coal & limestone specified in the specification. In order to avoid excessive wear impeller tip speeds must not exceed 12 m/s
13.	Belt drives (if applicable) shall be properly designed to provide a minimum lifetime of 2 years under design conditions
14.	Clause Deleted.
15.	Maintaining a uniform concentration over the 95% of liquid column. Absolute sweeping of solid particle from tank bottom is a must for all Agitators. If speed is required to be increased to guarantee the above requirements; the same can be increased by vendor.



TECHNICAL SPECIFICATION OF FGD ABSORBER AGITATORS

TRY/PE-BM/FGD/AGITATOR SPEC:001/ Rev 01

16.	For Absorber, Auxiliary Tank and Drain Sump Agitators : There shall not be any slurry settlement at the Bottom of the Tank and all solids shall be suspended off the tank bottom (i.e. Off Bottom suspension)
17.	It is to be noted that in continuous process any deposit at tank bottom is the loss of material which are not getting converted as per process. Hence, total loss of material by sedimentation is a loss to FGD Process & determines the "In efficiency of the Agitator".
18.	Vendor should ensure nil settlement; utilization of solid material shall be a guaranteed parameter and will be assessed in percentage (%) term to net wet of solid mass of inflow or out flow. This is one of the guarantee parameter.
19.	Agitator and its driver shall perform on the test stand at shop and on the Agitator's permanent location at site within vibration limit the vibration of combined unit will be the responsibility of Agitator manufacturer. Agitator manufacturer is to ensure that Site performance of vibration is one of the "Acceptance Criteria" of the equipment. Please note vibration at test stand can only be taken as for information.
20.	Every Tank will have a pump whose suction line shall be connected to tank. These pumps are to operate continuously at the lowest operating level which is decided by Process requirement. Hence, the minimum operating level of liquid in every tank for every Agitator is a must to assess the combined operation of Agitator as well as that of pump alone. The Tank water level is indicated as per " Technical Information for sizing of Absorber Agitators ".
21.	Agitator must have low-pitch propeller with low solidity ratio and low Power Number. Power number shall be in the range of 0.3-0.35(preferably) or lower. The Maximum Input Power at motor terminal shall be considered as a guaranteed parameter under "Schedule of Guaranteed Parameters" in "Annexure-V-Schedule of Guarantees" and the same shall be calculated for maximum liquid level in tank. A calculation of power specifying the hydraulic power of Agitator, Seal loss, Gear box and Motor internal loss must be submitted along with the offer. A characteristics curve showing power versus liquid level should be submitted from the lowest liquid level, required for Agitator to maximum liquid level in the tank. Motor should be selected based on the highest power demand with a margin as per clause 5.3.2 at maximum liquid level as indicated in "Technical Information for sizing of Absorber Agitators", taking into account frequency variation.
22.	" Typical Arrangement of side entry agitator in absorber " drawing is provide with the specification wherein scope demarcation, height restriction of the agitator are indicated. Bidder to provide full compliance for this drawing with Signature and Seal.
5.2	CONSTRUCTIONAL FEATURES
A)	BLADE AND HUB OF PROPELLER
i)	The type of impeller shall be selected on the basis of suspended solids where the work is being performed. The selected profile shall be consistent with the specified operating conditions ,i.e., the type of tank, solid concentration etc.
ii)	It must be possible to remove the blades from their joining point. Each blade shall be made of one single piece.
iii)	The Blade design of the Agitator to be of most efficient design in order to offer least power consumption. The Agitator power consumption is part of the guarantee parameters.
iv)	Although Agitator will have substantial low speed because of reduction Gear Box, hydraulic unbalance at impeller can cause severe vibration, hence it is mandatory that rotating assembly shall be dynamically balanced to its rated speed.



TECHNICAL SPECIFICATION OF FGD ABSORBER AGITATORS

TRY/PE-BM/FGD/AGITATOR SPEC:001/ Rev 01

v)	Impeller should be dynamically balanced to Gr: G16: ISO-1940 after rubber lining of shaft.
B)	SEAL
I.	Agitators should be provided with Single Stage mechanical seal. the mechanical seal should be as per ISO-21049 / API 682.
II.	The wetted parts of the mechanical seal material shall be minimum "ASTM A240 SUPER DUPLEX 2507" and shall be suitable for the slurry service conditions.
III.	The Mechanical Seals shall be so arranged that repacking or fitting of replacement seals can be carried out with the minimum of disruption to plant operation.
IV.	Design the mechanical seals chamber to have sufficient room to lubricate and get seal face cool with its own slurry.
V.	Provide requirements for periodical flushing to rinse the seal face for leaked slurry.
VI.	All mechanical seals, regardless of type or arrangement, shall be of the cartridge design. Hook sleeve cartridge should not be used.
VII.	Requirement of flushing water, its quantity, and pressure to be indicated in data sheet.
VIII.	Zero leakage is the intension of this specification. However, quantity of leakage, if it is unavoidable, it should have a provision of collecting / or discharging back to the tank.
IX.	Mechanical seals shall be fitted and installed in the Agitator before shipment and shall be clean. Mechanical seals shall be plugged with screw for shipping.
X.	Intention of the specification is not to specify Type of Seal, Seal design, Spring configuration, Seal configuration, Balanced or Unbalance type etc. Agitator manufacturer to decide the same along with seal manufacturer the best seal that is suitable for the offered Agitator
XI.	Seal life has to be guaranteed, taking into consideration all its components for 25000 hrs. If the seals fail before the completion of guaranteed period, the same should be replaced free of cost by the bidder.
XII.	The sub-vendor of the seal shall be approved by END CUSTOMER during contract execution.
C)	SHAFT
	Use of dissimilar material at flange joint shall be avoided to eliminate any crevice corrosion. Spacing of the shaft joint should not be more than 3.0 m for easy assembly if it is more than 40kg. If welding is used for joining two tubes, welding joint must be 100% radio graphed. If split shaft is proposed for larger tanks , shaft flange at the joining interface has to be rubber lined at manufacturer's works and necessary fasteners have to be provided.
D)	BEARING & BEARING HOUSING IN GEAR BOX
I.	Bearing shall be of rolling type radial and thrust bearing (FAG/SKF make only) as required. Thrust bearing shall be sized for continuous operation under all specified condition.
II.	Thrust bearing shall provide full load capability if the Agitator's normal direction of rotation is reversed. Up-thrust and Down-thrust load must be taken into account in sizing bearing. Life of the every anti-friction bearing, used in the bearing housing as per manufacturer's design, should have L10 of 25000 hr. (minimum).



TECHNICAL SPECIFICATION OF FGD ABSORBER AGITATORS

TRY/PE-BM/FGD/AGITATOR SPEC:001/ Rev 01

III.	Bearing housing should be grease/oil lubricated. If bearing is oil lubricated, constant-level sight-feed oiler of 100cc size or bigger capacity is to be provided. Bearing housing should have oil drain, constant oil level indicator. A provision of one(1) number G1/2" thread(ISO-228,Part-1)port is required for remote control of temperature of bearing housing oil bath RTD.
IV.	If bearing housing requires cooling water, volume and pressure of cooling water is to be indicated in Technical Data Sheet.
V.	Lubricating oil will be the responsibility of Gear Box manufacturer. Hence, manufacturer has to make arrangement of first fill of oil at installation and at commissioning stage. Quantity of oil and its grade is to be indicated in Drawing and Operation Manual.
E)	MATERIALS
	Agitator components designated as "Full Compliance Material" shall meet the requirements of the industry specification as listed for the material in the " Technical Information for sizing of Absorber Agitators " as well as in the specification in the respective section.
F)	Driver (Motor)
I.	Driver shall be sized to meet all specified operating conditions including bearing housing , seal, external gear box and coupling loss(if any).
II.	Motor shall be able to accelerate to speed at reduced voltage and frequency as specified in "Site Power Supply Condition" as per Clause: 5.3.
III.	It should meet Motor specification enclosed (Refer clause 5.3 of the specification).
G)	GEAR BOX
	Complete up-thrust and down-thrust, developed by Agitator shall be taken by thrust bearing housing of Gear Box. Rating of at Gear box shall be at least 1.5 times the rated torque of Agitator.
H)	COUPLING & COUPLING GUARD
I.	Coupling and coupling guard should be supplied between driver and driven equipment.
II.	Coupling should be designed taking into consideration adequate service factor.
III.	Design rating of the coupling (excluding service factor) should be indicated in data sheet.
IV.	Coupling must be having locking screw so that it does not slide over shaft in due course operation.
V.	It is desirable that for servicing of seal, coupling half should not be removed. Coupling should be dynamically balanced to Gr: G6.3, ISO-1940.
VI.	Removable coupling guard shall conform to the requirements of all applicable national, industrial or statutory regulations.



TECHNICAL SPECIFICATION OF FGD ABSORBER AGITATORS

TRY/PE-BM/FGD/AGITATOR SPEC:001/ Rev 01

I)	PLATE AND FASTENING BOLTS
I.	Alignment between Gear Head Shaft and Agitator shaft shall be within the permissible limit of Gear Box. Similarly, misalignment between Motor shaft and Gear Box Shaft shall be within 0.050 micron (radial) and 2 degree (angular) or better as per requirement of Motor and Gear Box
II.	Clause Deleted
J)	OTHER COMPONENTS
	All fasteners used in wetted condition must be of alloy material or better material (bidder shall refer to the “Technical Information for sizing of Absorber Agitators” for details regarding the MOC of Wetted Fasteners) so that even if it comes in contact with liquid by swelling of rubber, thread remains unaffected. All fasteners provided inside the tank (even if it is exposed to the slurry vapour) shall be treated as wetted part only.
	GENERAL REQUIREMENT OF SIDE ENTRY AGITATORS:
I.	All Agitators shall be designed for continuous operation.
II.	The Material of Construction (MOC) of side entry Agitators shall be as per “Technical Information for sizing of Absorber Agitators” .
III.	It should be of Flange mounted type.
IV.	“Nozzle size” on which Agitator shall be mounted, shall have enough opening to Insert rotating assembly (i.e. impeller hub) from side.
V.	The Bidder to consider Gypsum Sedimentation during stoppage of Agitator.
VI.	<p>The following information to be provided along with the bid:</p> <ul style="list-style-type: none"> a) <u>Impeller Diameter</u> b) <u>Impeller Speed</u> c) <u>Agitator Pumping Capacity (m³/min)</u> d) <u>Volume per Agitator:</u> e) <u>Basis for selection of motor rating (calculation)</u> f) <u>Basis for selection of gear box, shaft, impeller etc.,</u>

5.3 MOTOR

1.	For Technical specification of LT AC Motors - Refer Annexure – VII
2.	Maximum continuous rating (MCR) of the motor shall have at least 20% margin over the maximum load demand of the driven equipment including voltage and frequency variation. <i>This clause shall supersede the clause “10.C” in the Technical specification of</i>



TECHNICAL SPECIFICATION OF FGD ABSORBER AGITATORS

TRY/PE-BM/FGD/AGITATOR SPEC:001/ Rev 01

LT AC Motors - Annexure – VII.

Guideline for minimum motor rating calculation of agitator is as below,

MINIMUM MOTOR RATING CALCULATION:

a. Calculated Volume of the Slurry Tank, $M^3 = \text{Width(M)} \times \text{Depth(M)} \times \text{Maximum liquid level in the tank(M)}$

For dimensions refer “*Technical Information for sizing of Absorber Agitators*”, for Width, Depth and Maximum liquid level in the tank.

b. Slurry Volume handled by each agitator = $\frac{\text{Calculated Volume of the Slurry Tank}}{\text{No: of agitator (i.e. 2 no's)}}$

c. Calculated Motor Rating = Slurry Volume handled by each agitator x 0.065 Kw.

Note: 0.065 Kw is the minimum motor rating per M^3 volume.

3. d. **Minimum Motor Rating = 20% margin over the Calculated Motor Rating (as per clause 5.3.2).**

Note: the above “Minimum Motor Rating” is the minimum design requirement, However Vendor may decide a higher motor rating based on the design and experience.

Calculation illustration with example:

Tank dimensions: - Width = 26.9M; Depth=10.9M; Max. liquid level in the tank=6M.

a. Calculated Volume of the Slurry Tank, $M^3 = 26.9 \times 10.9 \times 6 = 1759.26 M^3$.

b. Slurry Volume handled by each agitator = $\frac{1759.26}{2} = 879.63 M^3$

c. Calculated Motor Rating = $879.63 \times 0.065 = 57.19Kw$.

d. **Minimum Motor Rating = 68.62 Kw (With 20% margin over 57.19Kw).**

6.0 GENERAL REQUIREMENTS:

S.No	Description
1.	Metric unit shall be used in the drawings and in the any displays on the equipment's. Special attention should be taken that the unit of pressure shall be in dual scales of kPa and kg/cm ² G. For instance the pressure gauges should have dual unit's indication.
2.	Descriptions in the drawings, in the documents, and in the displays shall be in English
3.	All rotating parts such as coupling shall be covered with suitable protective guards. Guards shall be



TECHNICAL SPECIFICATION OF FGD ABSORBER AGITATORS

TRY/PE-BM/FGD/AGITATOR SPEC:001/ Rev 01

S.No	Description
	easily removable type.
4.	The equipment shall be designed to withstand the corrosive and moist environment in which these are proposed to operate.
5.	Noise level produced by any rotating equipment individually or collectively shall not exceed 85 dB measured at a distance of 1.0 meters from the source in any direction and 1.5m above operating floor.
6.	The overall vibration level shall be as per ISO 10816.
7.	Suitable drain connections shall be provided.
8.	The equipment shall be suitable for stable operation continuously.
9.	Corrosion allowance: Corrosion allowance for entire equipment shall be in accordance with latest applicable Indian / International standard.
10.	Unless otherwise specified , flanges shall be in accordance with ANSI B16.5 Class 150
11.	Name plate: All equipment shall be provided with nameplates indicating the item number and service name. Name plates shall be of 304 Stainless steel plate and placed at a readily visible location. Nameplate of main equipment shall have enough information, which will be confirmed during engineering phase. Stainless steel nameplates for all instruments and valves shall be provided.
12.	Rotation arrows shall be cast in or attached with stainless steel plate on each item of rotation equipment at a readily visible location.
13.	Unless otherwise specified, all equipment items where the weight exceeds 15 kg shall be provided with suitable lifting lugs, ears or ring bolts or tapped holes for lifting rings. Minimum shock factor for lifting lugs shall be minimum 2.0. The position of lifting lugs and reference dimension shall be shown on GA and/or outline drawings. NDT shall be conducted for lifting lugs. When any spreader bars are required for lifting and laydown, the bidder shall provide spreader bar with equipment.
14.	Skid Mount/Transportation: Equipment shall be fabricated as skid mount design as much as practical to minimize erection at the site.
15.	If the driver/driven equipment train is in the resonance condition or any vibration problems occur, the bidder shall solve the problems in a timely manner.
16.	Bidder shall provide the necessary gaskets.
17.	All the surfaces of the carbon steel should be rust prevented before shipment for the period of at least 12 months for storage and construction.
18.	Bidder to provide capacity of crane or hoist required for material handling and the details of heaviest component to be handled.
19.	The list of all Bought out items with makes and country of origin to be mentioned along with offer to be submitted.



TECHNICAL SPECIFICATION OF FGD ABSORBER AGITATORS

TRY/PE-BM/FGD/AGITATOR SPEC:001/ Rev 01

S.No	Description
20.	Quality Plan to be submitted along with the offer.
21.	Cost towards the participation in discussions/meetings, providing technical assistance during technical discussions/meetings with customer for approval of drawing/documents etc. TA/DA, boarding and lodging to attend these meetings shall be borne by the bidder and shall be inclusive in supply portion.
22.	Material of construction for all equipment/components shall be subject to END CUSTOMER/ BHEL approval during detail engineering. Accordingly bidder shall consider MOC for all equipment/component as per best engineering practice, global standard and global references.
23.	Bidder to provide sub vendor list and Bidder shall strictly adhere to END CUSTOMER approved vendor list. In case bidder proposes an additional vendor for an item or vendor approval is required for any new item, acceptance shall be subject to approval by END CUSTOMER/ BHEL before placing order and bidder shall submit relevant documents to take up with END CUSTOMER for approval.
24.	It shall be the complete responsibility of the successful bidders to obtain "Sub Vendor Approval" from BHEL / END CUSTOMER for all equipment's & components. Any delay in sub vendor's approval should not affect the project schedule. If any of the sub vendors does not have the approval of END CUSTOMER/ BHEL, the same may be replaced with another END CUSTOMER/BHEL approved sub-vendor only, without any price implications to BHEL.
25.	<p>The modalities of inspection (Stage, Final, In-process) shall be finalized during detail engineering after submission of quality assurance plan (QAP). It shall be reviewed by the END CUSTOMER and BHEL. Bidder shall follow the procedures of inspection as per the approved QAP. Bidder has to submit the following documents along with inspection call and if any other documents required as per approved QAP.</p> <ul style="list-style-type: none">- Raw material inspection certificate- Internal test reports- Statutory certificates as required.- All inspection & testing shall be carried out based on the following documents:<ul style="list-style-type: none">a. Relevant Standardsb. Specificationsc. Approved drawingsd. Data Sheetse. Calibration certificate for all the measuring instrumentsf. Bidder should also coordinate in getting the MDCC's (Material Dispatch clearance certificate) and all types of IC's (Inspection Certificates) from the END CUSTOMER along with BHEL.
26.	During detail engineering, bidder to strictly adhere to BHEL/END CUSTOMER drawing formats, document numbering, quality plan & FQP formats
27.	The identification and numbering of equipment, systems, items, etc. of supply, as well as of all documents and drawings shall be in accordance with reference Designation System for Power Plants



TECHNICAL SPECIFICATION OF FGD ABSORBER AGITATORS

TRY/PE-BM/FGD/AGITATOR SPEC:001/ Rev 01

S.No	Description
	- KKS system.
28.	Complete detail engineering drawings, calculations, selection of components etc. shall be reviewed & subject to approval of BHEL/END CUSTOMER during detail engineering
29.	Bidder shall furnish necessary inputs & drawings of all equipment in editable Auto CAD/ MS-Word /Excel format.
30.	During detail engineering, successful bidder shall ensure flow of drawings/documents as per schedule. Any comments from BHEL/END CUSTOMER should be addressed timely by the bidder.
31.	Bidder to note that list above is not exhaustive and any work /items required for completing the smooth operation and ensuring satisfactory running of the machines till final hand over to the end user shall also be in the scope of the bidder.
32.	Bidder shall submit the signed and stamped copy of all the pages which constitutes this technical enquiry specification signed by authorized signatory and clearly mentioning each clause under following two categories to avoid any ambiguity in scope understanding & the scope division along with technical offer. a. "Accepted without deviation and considered in scope of work" b. "Not considered in scope of work"
7.0	PACKING AND FORWARDING
1.	Proper packing to be ensured. Indigenous Supply: Agitator & sub system assembly shall be wrapped in polythene bags & packed in a strong rigid wooden crate. Rain water should not enter into the Agitator internals during storage in the outer yard of power plant. Imported Supply: All imported supply should be packed as per Sea worthy packing standards PE-TS-888-100-A001. All imported items should have Sea worthy packing. Liberal packing materials and struts shall be provided to arrest rolling and to protect from transit damages.
2.	Equipment and process materials shall be packed and semi-knocked down, to the extent possible, to facilitate handling and storage and to protect bearings and other machine surfaces from oxidation. Each container, box, crate or bundle shall be reinforced with steel strapping in such a manner that breaking of one strap will not cause complete failure of packaging. The packing shall be of best standard to withstand rough handling and to provide suitable protection from tropical weather while in transit and while awaiting erection at the site.
3.	Equipment and materials in wooden cases or crates shall be properly cushioned to withstand the abuse of handling, transportation and storage. Packing shall include preservatives suitable to tropical conditions. All machine surfaces and bearings shall be coated with oxidation preventive compounds. All parts subject to damage when in contact with water shall be coated with suitable grease and wrapped in heavy asphalt or tar impregnated paper.
4.	Crates and packing material used for shipping will become the property of owner.(END CUSTOMER)
5.	Packaging or shipping units shall be designed within the limitations of the unloading facilities of the receiving ports and the ship will be used. It shall be the bidder's responsibility to investigate these



TECHNICAL SPECIFICATION OF FGD ABSORBER AGITATORS

TRY/PE-BM/FGD/AGITATOR SPEC:001/ Rev 01

S.No	Description
	limitations and to provide suitable packaging and shipping to permit transportation to site.
6.	Packing (tare) shall be part of the equipment cost and shall not be subject to return. The packing should ensure integrity and cohesiveness of each delivery batch of equipment during transportation. In case of equipment assemblies and unit's delivery in the packing of glass, plastics or paper the specification of packing with the material and weight characteristics are to be indicated.
7.	Each package should have the following inscriptions and signs stenciled with an indelible ink legibly and clearly: <ul style="list-style-type: none">a. Destinationb. Package Numberc. Gross and Net Weightd. Dimensionse. Lifting placesf. Handling marks and the following delivery marking
8.	Each package or shipping units shall be clearly marked or stenciled on at least two sides as per the dispatch instruction gives during the contract: In addition, each package or shipping unit shall have the symbol painted in red on at least two sides of the package, covering one fourth of the area of the side.
9.	Each part of the equipment which is to be shipped as a separate piece or smaller parts packed within the same case shall be legibly marked to show the unit of which it is part, and match marked to show its relative position in the unit, to facilitate assembly in the field. Unit marks and match marks shall be made with steel stamps and with paint.
10.	Each case shall contain a packing list showing the detailed contents of the package. When any technical documents are supplied together with the shipment of materials no single package shall contain more than one set of such documents. Shipping papers shall clearly indicate in which packages the technical documents are contained.
11.	The case number shall be written in the form of a fraction, the numerator of which is the serial number of the case and the denominator the total number of case in which a complete unit of equipment is packed.
12.	Wherever necessary besides usual inscriptions the cases shall bear special indication such as "Top", "Do not turn over", "Care" , "Keep Dry" etc. as well as indication of the center of gravity (with red vertical lines) and places for attaching slings (with chain marks)
13.	Marking for Safe handling: To ensure safe handling, packing case shall be marked to show the following: <ul style="list-style-type: none">a. Upright positionb. Sling position and center of Gravity positionc. Storage categoryd. Fragile components (to be marked properly with a clear warning for safe handling)



TECHNICAL SPECIFICATION OF FGD ABSORBER AGITATORS

TRY/PE-BM/FGD/AGITATOR SPEC:001/ Rev 01

S.No	Description
14.	Each crate or package is to contain a packing list in a waterproof envelope. All items are to be clearly marked for easy identification against the packing List. All cases, packages etc. are to be clearly marked on the outside to indicate the total weight where the weight is bearing and the correct position of the slings are to bear an identification mark relating them to the appropriate shipping documents. All stencil marks on the outside of cases are either to be made in waterproof material or protected by shellac or varnish to prevent obliteration in transit.
15.	The packing slip shall contain the following information: - Customer name, Name of the equipment, Purchase Order number with Date, Address of the delivery site, Name and Address of the Sender, Serial Number of Agitator, BHEL item Code, Gross Weight and Net weight of Supplied items.
16.	Prior to transport from manufacturer's work to destination, components of the unit shall be completely cleaned to remove any foreign particles. Flange faces and other machined surfaces shall be protected by an easily removable rust preventive coating followed by suitable wrapping.
17.	All necessary painting, corrosion protection & preservation measures shall be taken as specified in painting schedule. Supplier shall consider the coastal environment zone which is defined as "very severe" during final finishing/shipping.
18.	Successful bidder shall furnish the detail packing /shipment box details with information like packing box size, type of packing, weight of each consignment, sequence no. of dispatch, no. of consignment for each deliverable item against each billing break up units/ billable blocks. Without these details the BBU shall not be approved during detail engineering. Also, complete billing break-up with above mentioned details shall be submitted within 10days of LOI.
19.	All items/equipment shall be dispatched in properly packed condition (i.e. no item shall be dispatched in loose condition such that it becomes difficult to store/identify its location at site at a later stage).
20.	Cases which cannot be marked as above shall have metal tags with the necessary markings on them. The metal tags shall be securely attached to the packages with strong steel binding wire. Each piece, Skid, Case or package shipped separately shall be labelled or tagged properly.



TECHNICAL SPECIFICATION OF FGD ABSORBER AGITATORS

TRY/PE-BM/FGD/AGITATOR SPEC:001/ Rev 01

S.No	Description
8.0	SUPERVISION OF ERECTION, TESTING AND COMMISSIONING
1.	The erection of Agitators will be done by owner as per Erection Manual and check List. However, the bidder shall make visit as per enquiry/PO for the supervision of erection, pre-commissioning & post-commissioning check-up, start-up, testing and trial runs of all the items covered under the scope of supply.
2.	<p>Optional price to be quoted by the bidder in terms of price per man-day for erection and commissioning support.</p> <p>If commissioning engineer is deputed from Indian office, then the payment will be released in INR only.</p> <p>This service will be utilized by BHEL-site through power sector regions. Separate PO will be released by BHEL-Site through power sector regions to avail the vendor's supervision service.</p> <p>Depending upon the actual duration of erection and commissioning support availed, the payment will be paid by BHEL- power sector regions based on the vendor quoted amount (price per man-day).</p> <p>The price calculated for 07 days of erection and commissioning per absorber will be considered for price comparison.</p>
3.	The bidder will be informed well in advance for the visit.
4.	All TA/DA, Site Expenses, Travel charges boarding and lodging shall be borne by the bidder and shall be inclusive in supervision portion.
5.	Price comparison for evaluating the lowest bid will be considered all Main Supply, Supervision of E&C charges and Mandatory Spares price all together.
9.0	EXCLUSION
	<p>The following work associated with the Agitators will be by others:</p> <ul style="list-style-type: none">a. Walkways, platforms and laddersb. Element handling hoists.



TECHNICAL SPECIFICATION OF FGD ABSORBER AGITATORS

TRY/PE-BM/FGD/AGITATOR SPEC:001/ Rev 01

S.No	Description
10.0	INSPECTION, TESTING AND QUALITY REQUIREMENTS
	<p>A detail quality plan is to be submitted along with offer for all items marked "Full Compliance Material". Refer "Annexure – VIII" for Indicative Quality Plan & "Annexure – IX" Customer Quality Requirements for LT motors.</p> <p>NOTE: <i>Indicative Quality Plan</i> is for reference purpose only and is not exhaustive. All relevant points of Technical Specification shall be addressed in the Final MQP. The MQP approval will be given only post-contract stage and is subject to the addition of inspection stages or quantum by the customer and shall be performed by the Supplier without any cost/delivery implication.</p> <p>The General inspection requirements to be considered are as below:</p>
1.	Bidder shall furnish written copies of shop production, fabrication and quality test procedures and drawings to be used on the Agitators for review by BHEL/END CUSTOMER prior to manufacture.
2.	The Bidder shall furnish performance test procedure along with standard. The test procedure will be reviewed and approved by the BHEL/END CUSTOMER.
3.	Since there is no standard for "Acceptance Test Procedure" for Agitator, Agitator manufacturer is to submit a test procedure and Quality Plan, clearly indicating that equipment will meet the desired parameter.
4.	Power consumption at motor terminal and vibration of equipment will be conducted at site. Vendor to indicate other material tests that are to be conducted as per their practice in their Quality plan.
5.	Clause Deleted.
6.	DYNAMICS
7.1	CRITICAL SPEED
7.1.1	Operation speed of the Agitator motor shall be at least 25% below the first critical speed
7.1.2	Additional to the requirement of the critical speed of Agitator, as specified above. Agitator manufacturer is to analyze the torsional critical speed of combined system of Agitator, Gear Box and Motor to establish that the torsional critical speed is well off the operating speed by 20% from the operating speed.
7.2	VIBRATION SEVERITY
7.2.1	During performance test, unfiltered vibration measurements shall be made with running of Agitator in Air. Measurement shall be taken on the Gear Box thrust bearing housings as well in motor top.
7.2.2	Guaranteed Site vibration of the equipment on its own pedestal, at commissioning with normal level of liquid and with maximum liquid at respective tank, Vibration limit at site will be as per ISO-10816.
7.2.3	Vibration measurements of bearing housing shall be made in root mean square (RMS) velocity.
7.2.4	Vibration levels measured on the non-rotating parts shall not exceed the zone limit "B" as defined in ISO 10816 at steady conditions and shall not exceed the zone limit "C" as defined in ISO 10816 at



TECHNICAL SPECIFICATION OF FGD ABSORBER AGITATORS

TRY/PE-BM/FGD/AGITATOR SPEC:001/ Rev 01

S.No	Description
	transient conditions.
8.	For surfaces with rubber lining Welding shall be visually inspected to verify the absence of rough area and unacceptable transition between surfaces which prevent the adequate adherence of rubber. The acceptance criteria shall be as per latest standard.
9.	For surfaces with rubber lining, degree of cleaning shall be visually checked before the application of the coating. There must be no area with oxidation, dirt or partially or generalized corrosion defects.
10.	Test certificates shall be issued for each lot of raw material used in the coating, corresponding to specific weight and traction resistance.
11.	For surfaces with rubber lining, adherence test shall be conducted on production samples. Adherence test shall be conducted on the actual surface through hammering. In order to verify the absence of air packets (or) surface without adherence.
12.	For surfaces with rubber lining, Coating thickness shall be checked at 100%. A High voltage porosity test will be conducted on 100 % of the coated surface.
13.	Out of all Agitators One Number of each type will be inspected at the Bidder's works before dispatch or where the test facilities are available.
14.	The Bidder shall conduct performance test for the remaining Agitators and submit the reports.
15.	Contract shaft mechanical seals shall be used during shop tests, unless the seal design is unsuitable for the shop-test condition, if applicable.
16.	Agitators shall not be released for shipment, until shop tests data and performance tests curves have been approved by Owner.
17.	Bidder should furnish performance guarantee as per applicable standard guarantee for the design, manufacture, material and safe operation of the equipment's.
18.	BHEL shall witness the test at Bidder's works and a notice of minimum three (3) weeks shall be given for attending the inspection.
19.	Bidder to arrange all calibrated gauges, Instruments during inspection.
20.	Mechanical running and the performance test shall be carried out. Bidder to arrange Motor of same / higher rating for the shop test and inspection.
21.	Final acceptance of the quality plan will be approved by ultimate user (hereafter called END CUSTOMER) during post order stage. Hence, it is expected that manufacturer to submit quality plan (QAP) along with the offer. The same shall be followed at post order stage also. QAP should be as per the best practice followed internationally to avoid any conflict of interest.
22.	Raw material of fastener must undergo Inter-granular Corrosion test as per ISO-3651, Part-1 for Nitric Acid test.



TECHNICAL SPECIFICATION OF FGD ABSORBER AGITATORS

TRY/PE-BM/FGD/AGITATOR SPEC:001/ Rev 01

S.No	Description
11.0	PAINTING
1.	<p>Painting details for agitator support: - Surface Preparation: Blast Cleaning SA 2.5 PRIMER COAT: α. Primer: One coat of Two component moisture curing zinc (ethyl) silicate primer coat (Min 80% metallic zinc content in dry film, solid by volume minimum 60% \pm2). Zinc dust composition and properties shall be as per Type II as per ASTM D520-00 DFT- 70μ Intermediate: One coat of Two component polyamide cured epoxy with MIO content (containing lamellar MIO Min 30% on pigment, solid by volume min. 80%\pm2) DFT- 100μ . FINISH COAT: Two coats of two pack aliphatic isocyanate cured acrylic polyurethane paint to IS 13213 solid by volume min.55%\pm2) DFT- 35μ/ coat With gloss retention (SSPC paint spec no.36, ASTM D4587, D2244, D523 of level 2 after min. 1000 hrs exposure, gloss less than 30 and colour change less than 2.0Δ E) COLOUR CODE Base: To be informed during contract stage Lettering: To be informed during contract stage</p>
2.	Rust preventive paint after inspection at shop floor before dispatch shall be in bidder's scope
3.	Corrosion protection, coating and galvanizing, painting shall be taken care by the bidder. Bidder shall submit the painting scheme during detail Engg in line with the specification and shall be subject to approval of BHEL / END CUSTOMER.
12.0	SPARES, TOOLS & TACKLES
	Any special tools & tackles required for the entire equipment to disassemble, assemble or maintain the units, they shall be included in the quotation and furnished as part of the initial supply of the machine. List of special tools & tackles shall be decided by bidder as per his proven practice. When special tools are provided, they shall be packaged in separate, boxes with lugs and marked as "Special Tools for (tag / item number)." Each tool shall be stamped or tagged to indicate its intended usage. Levers and eye bolts for the removal of parts to be serviced shall be submitted with special tools.
12.1	START UP & COMMISSIONING SPARES
	Start-up & Commissioning Spares shall be part of the main supply of the Agitators. Start-up & commissioning spares are those spares which may be required during the start- up and commissioning of the equipment/system. All spares required for successful operation till commissioning of Agitator shall come under this category. Bidder shall provide an adequate stock of such start up and commissioning spares, the same shall be supplied along with main supply to the site for the equipment erection and commissioning. The spares must be available at site before the equipment's are energized. The List of such spares to be provided during bidding stage.



TECHNICAL SPECIFICATION OF FGD ABSORBER AGITATORS

TRY/PE-BM/FGD/AGITATOR SPEC:001/ Rev 01

S.No	Description
12.2	RECOMMENDED SPARES
	Bidders shall also furnish the recommended spares list along with the offer required for 3 years of normal operation of the plant and should be independent of the list of the mandatory spares. Prices of recommended spares will not be used for evaluation of the bids. The price of these spares will remain valid up to 6 months after placement of Notification of Award for the main equipment
12.3	MANDATORY SPARES:
	<p>Bidder to quote for the mandatory spares as per the Mandatory Spare list given for a specific project (Refer "Annexure-XI").</p> <p>Bidder shall quote for the "Mandatory Spares Part List", and it will be considered for L1 evaluation. mandatory spare parts items shall be handed over separately and shall not be mixed with the supply of the main equipment parts. Spares shall be sent in pre-decided lots in containers/secure boxes. All boxes/containers are to be distinctly marked in red color with boldly written "S" mark on each face of the containers. Spares shall not be dispatched before dispatch of corresponding main equipment's. Each item shall be labelled in English and be packed against damage and sealed to prevent deterioration from corrosion. The protection shall be sufficient for a minimum of 10 years' storage in a dry weatherproof building.</p> <p>All spares supplied under this contract shall be strictly inter-changeable with the parts for which they are intended for replacements. All the mandatory spares shall be manufactures along with the main equipment components as a continuous operation as per same specification and quality plan.</p> <p>Any special tools & tackles required for the entire equipment to disassemble, assemble or maintain the units, they shall be included in the quotation and furnished as part of the initial supply of the machine. List of special tools & tackles shall be decided by bidder as per his proven practice. When special tools are provided, they shall be packaged in separate, boxes with lugs and marked as "Special Tools for (tag / item number)." Each tool shall be stamped or tagged to indicate its intended usage. Levers and eye bolts for the removal of parts to be serviced shall be submitted with special tools.</p>
13.0	PERFORMANCE GUARANTEE
	<p>All performance tests for Agitators shall be carried out by bidder in accordance with any latest international codes/standards.</p> <p>Bidder shall furnish Performance guarantee for the design, manufacture, material, safe and trouble-free operation of the Agitators and its accessories</p> <p>The Bidder shall ensure a design of the equipment to achieve an average target availability of 98% for 120 days and average target availability of 95% for 1 year.</p> <p>Noise level ≤ 85 dB (A) at 1m horizontal distance from equipment/enclosures and 1.5m above operating floor is to be guaranteed.</p> <p>Vibration levels measured on the non-rotating parts shall not exceed the zone limit "B" as defined in ISO 10816 at steady conditions and shall not exceed the zone limit "C" as defined in ISO 10816 at transient conditions.</p>



TECHNICAL SPECIFICATION OF FGD ABSORBER AGITATORS

TRY/PE-BM/FGD/AGITATOR SPEC:001/ Rev 01

S.No	Description
	<p>Acceptance tests to be carried out as per the procedure defined by the bidder which shall be submitted for BHEL/ END CUSTOMER approval.</p> <p>In the event that the performance test is unsuccessful, bidder shall take necessary remedial action at his cost and the performance test shall be repeated.</p>
14.0	WARRANTY/DEFECT LIABILITY
1.	<p>The Bidder warrants that the equipment's/items shall be free from defects in the design, engineering, materials and workmanship of the Plant and Equipment supplied and of the work executed. The Warranty Period shall be twenty-four (24) months from the date of Supply or eighteen (18) months from the date of commissioning, whichever first occurs. If during the Warranty/Defect Liability Period any defect should be found in the design, engineering, materials and workmanship of the Plant and Equipment supplied or of the work executed by the Bidder, the Bidder shall promptly, in consultation and agreement with BHEL regarding appropriate remedying of the defects, and at its cost, repair, replace or otherwise make good (as the Bidder shall, at its discretion, determine) such defect as well as any damage to the Facilities caused by such defect.</p>
2.	<p>In case of failure of the equipment to meet the guarantee, END CUSTOMER/BHEL reserves the right to reject the equipment. However, END CUSTOMER/BHEL reserves the right to use the equipment until new equipment supplied by bidder meets the guaranteed requirement .</p>
15.0	FIRST FILL OF CONSUMABLES:
	<p>Bidder's scope shall also include supply and filling of all chemicals, reagents, resins, lubricants, grease, filters and consumable items for operation up to commissioning including top up requirements. All lubricants proposed for the plant operation shall be suitable for all operating and environmental conditions that will be met on site consistent with good maintenance procedures as instructed in the maintenance manuals.</p>
	<p>Detailed specifications for the lubricating oil, grease, gases, servo fluids, control fluids, chemicals including items qualities and quantities required per month of the plant operation for the END CUSTOMER/BHEL's approval herein shall be furnished within 2 months of placement of Order. On completion of erection complete list of bearings/equipment giving their location and identification marks shall be furnished to BHEL along with lubrication requirements. All types of consumables, lubricants and grease shall be readily obtainable locally and the number of different types shall be kept to a minimum. For each type and grade of lubricant recommended, bidder shall list at least three equivalent lubricants manufactured by alternative companies.</p>
16.0	TRAINING
	<p>Successful bidder shall provide comprehensive training for END CUSTOMER/BHEL Engineering, O&M, Erection & Commissioning staffs at site covering all aspects of the Agitators - Operation & Maintenance, Troubleshooting etc.</p>



TECHNICAL SPECIFICATION OF FGD ABSORBER AGITATORS

TRY/PE-BM/FGD/AGITATOR SPEC:001/ Rev 01

S.No	Description
17.0	CONFLICT
	Bidder's equipment shall be designed for and shall meet the service, performance and minimum level of quality requirements specified. Bidder shall be solely responsible for advising END CUSTOMER in writing of any conflicts between the specifications and Bidder's design, including performance and levels of quality. Bidder agrees that its obligations, liabilities and warranties shall not be diminished or extinguished due to its meeting the requirements of the Specification.
18.0	DOCUMENTATION
A	DOCUMENTS TO BE SUBMITTED ALONG WITH THE OFFER
	The Bidder shall submit all documents, drawings, diagrams and all such information, which are necessary to fully understand the offer for techno – commercial Offer. Vendors are requested to comply with above in all respect.
B	DOCUMENTS TO BE SUBMITTED AFTER AWARD OF CONTRACT
	<p>The Successful bidder shall submit necessary data, documents and drawings for review, approval as specified in this specification. Drawings that are reviewed by the END CUSTOMER/ BHEL will be returned to bidder with a transmittal letter with any comments and / or questions marked on the drawings or noted in the letter. All comments and questions must be resolved before a resubmission of drawings / documents. If the design has not developed enough to resolve some of the comments or questions, bidder shall place a "hold" on those items or areas of design. END CUSTOMER/ BHEL reserves the right to return drawings unprocessed to bidder if there exists any evidence that bidder has not acknowledged all comments and questions.</p> <p>All necessary GA drawings, sections, sub-assembly drawings, specifications of main and sub components and necessary set of operation & maintenance manual as asked by END CUSTOMER must be furnished by bidder in soft and hard copy forms. For all documents softcopy format shall be searchable pdf, however in addition all drawings, diagrams shall be supplied in ACAD or other editable format and all lists in Excel format. Further break up of technical documents will be discussed during finalization of the purchase contract.</p> <p>Unless agreed otherwise, Ten (10) hard copies and five (05) sets of electronic copies of all documents are to be submitted in the English language. Electronic Copies shall be submitted in primary original data format (e.g. DOC, XLS, DWG) as well as in a printable non-proprietary document format (e.g. PDF). Especially P&IDs shall be submitted as DWG files and PDF files. Bidder to ensure submission of hard copies as per END CUSTOMER requirement for all engineering drg/doc and for all subsequent revisions along with a soft copy through email to concerned project team.</p>



TECHNICAL SPECIFICATION OF FGD ABSORBER AGITATORS

TRY/PE-BM/FGD/AGITATOR SPEC:001/ Rev 01

ANNEXURE-I – REFERENCE LIST

Project :

Enquiry No :

REFERENCE LIST as per format shown below. (Reference plant details for Horizontal Agitators)

S.No	Project Name , Customer & Plant capacity	Coal fired Yes/No	Wet Limest one Based FGD Yes/No	Model	Size of Tank	Type Horizontal / Vertical	Speed rpm	Year of Commg	Qty

Note :

Bidders shall also submit reference list of Horizontal agitators as per the format given above.

BIDDER SIGN : _____

DESIGNATION : _____

DATE : _____

BIDDER SIGN WITH SEAL AND DATE:



TECHNICAL SPECIFICATION OF FGD ABSORBER AGITATORS

TRY/PE-BM/FGD/AGITATOR SPEC:001/ Rev 01

Annexure-II TECHNICAL DATASHEET OF AGITATORS (TO BE FILLED FOR EACH AGITATOR)

Project :

Enquiry No:

SL.NO	PARAMETERS	UNITS	DATA
1.	General		
1.1	Project		
1.2	Ultimate Customer		
1.3	Location		
1.4	Order Number/Enquiry No		
1.5	Agitator Name		
1.6	Service		
1.7	Installation		
1.8	No. of Agitator per Tank		
1.9	Total No's of Agitator for all the units		
1.10	Type of Agitator		SIDE ENTRY
1.11	Model Number		
1.12	No of Stage(No of propeller per Agitator)		
1.13	Mounting of Agitator		
1.14	Mounting of Gear Head		
1.15	Mounting of Motor		
2	Performance Details		
a.	Input power at Motor terminal at highest frequency and Maximum liquid level in tank	KW	
b.	Input power at Motor terminal at Normal frequency (50Hz) and Normal liquid level in tank	KW	
c.	Motor rating	KW	
d.	Rated speed	rpm	
e.	Critical Speed	rpm	
f.	Tip speed	m/s	
g.	Direction of rotation of Motor and Gear box viewed from Motor non-driving end		
h.	Direction of rotation of Agitator viewed from Gear head end		
i.	Minimum submergence required over blade centre line for continuous operation	mm	
j.	Impeller diameter	mm	
k.	Minimum clearance required below impeller centre line	mm	
l.	Maximum liquid level over propeller centre line up to which Agitator can work without overloading of motor at 50Hz	mm	



TECHNICAL SPECIFICATION OF FGD ABSORBER AGITATORS

TRY/PE-BM/FGD/AGITATOR SPEC:001/ Rev 01

3	Construction Features		
3.1	Impeller		
	a) Type		
	b) Diameter(tip to tip)	mm	
	c) Hub diameter	mm	
	d) No of blade per Impeller		
	e) Thickness of blade	mm	
3.2	Tube thickness, if any	mm	
3.3	Shaft diameter at coupling (GH-Agitator)	mm	
3.4	Length of Top shaft	mm	
3.5	Connection Details		
	· Blade to Hub:		
	· Hub to Shaft/Tube		
	· Line Shaft to Line shaft		
	· Line shaft to top shaft		
3.6	Bearings in Gear Head		
	Thrust bearings Housing		
	a) Type		
	b) Make		
	Bearing Number		
	· Radial Bearing		
	· Radial Bearing		
	· Thrust Bearing		
	c) Type of lubrication		
	d) Lubricator		
3.7	Coupling between Agitator & Gear Head		
	a) Type		
	b) Make & Model No.		
	c) Rating	KW/rpm	
3.8	Stuffing Box/Mechanical Seal		
	a) Type		
	b) Details of gland packing		
	c) No of packing		
	d) Cooling water		
	e) Lubrication type		
	f) Qty of grease and interval of lubrication.		
4	Material of Construction		
a.	Blade of Impeller		
b.	Hub of Impeller		
c.	Base Plate/Gear head Stand		
d.	Line Shaft & Line shaft Coupling		
e.	Impeller Shaft		
f.	Top Shaft		
g.	Gland Sleeve		
h.	Location of Thrust bearing		
i.	Coupling guard		



TECHNICAL SPECIFICATION OF FGD ABSORBER AGITATORS

TRY/PE-BM/FGD/AGITATOR SPEC:001/ Rev 01

j.	Fasteners in Wet region		
k.	Fasteners in Dry region		
l.	Stuffing Box		
m.	Gland		
n.	Gland packing		
5	Weight		
	a) Bare Agitator weight Kgs		
	b)Rotating Assembly weight Kgs		
	c) Motor weight Kgs		
	d) Gear Head weight Kgs		
	e)Wt. of the equipment, (a+c+d)		
	f) Heaviest single piece component of Agitator to be handled. Kgs		



TECHNICAL SPECIFICATION OF FGD ABSORBER AGITATORS

TRY/PE-BM/FGD/AGITATOR SPEC:001/ Rev 01

Annexure-III MOTOR SIZING CALCULATION (TO BE FILLED FOR EACH AGITATOR)

Project :

Enquiry No :

S.No	Parameters		Data
1	Tank size (Dimension in m)		
2	Specific Gravity of Slurry	ρ	
3	IMPELLER TIP DIA(in m)	d	
4	AGITATOR SPEED(RPM)	n	
5	POWER NO OF THE AGITATOR	Np	
6	NO OF IMPELLER STAGES	l	
7	AGITATOR POWER(P)	$Np * \rho * d^5 * n^3 * l$	
8	GEARBOX EFFICIENCY	η_1	
9	BEARING TRANSMISSION EFFICIENCY	η_2	
10	EFFICIENCY DUE TO ANY OTHER LOSSES	η_3	
11	MECHANICAL POWER REQUIRED	$\text{Agitator BKW} = P / (\eta_1 * \eta_2 * \eta_3)$	
12	MOTOR EFFICIENCY	η	
13	Rated Input Power at Motor Terminal at Normal water level and at Normal voltage and Frequency or Agitator BKW	$\text{Power consumed at Motor terminal} = \text{Agitator BKW} / \eta$	
14	MOTOR POWER (KW)	Motor Power shall be at least 1.2 times the Power consumed at Motor Terminal.	



TECHNICAL SPECIFICATION OF FGD ABSORBER AGITATORS

TRY/PE-BM/FGD/AGITATOR SPEC:001/ Rev 01

Annexure-IV MOTOR DATASHEET FOR AGITATORS (TO BE FILLED FOR EACH AGITATOR)

Project :

Enquiry No :

SL.NO	DESCRIPTION	DATA
A.	GENERAL	
1.	Manufacturer & Country of origin.	
2.	Equipment driven by motor	"Name of the Agitator"
3.	Motor type	
4.	Quantity	
B.	DESIGN AND PERFORMANCE DATA	
1.	Frame size	
2.	Type of duty	
3.	Type of enclosure /Method of cooling/ Degree of protection	
4.	Applicable standard to which motor generally conforms	
5.	Efficiency class as per IS 12615(IE3)	
6.	(a)Whether motor is flame proof	
	(b)If yes, the gas group to which it conforms as per IS:2148	
7.	Type of mounting	
8.	Direction of rotation as viewed from DE END	
9.	Standard continuous rating at 40 deg.C. Ambient temp. as per Indian Standard (KW)	
10.	Derated rating for specified normal condition i.e. 50 deg. C ambient temperature (KW)	
11.	Maximum continuous load demand of driven equipment in KW	
12.	Rated Voltage (volts)	
13.	Permissible variation of :	
	a. Voltage (Volts)	
	b. Frequency (Hz)	
	c. Combined voltage and frequency	
14.	Rated speed at rated voltage and frequency(RPM)	
15.	At rated Voltage and frequency:	
	a. Full load current	
	b. No load current	
16.	Power Factor at	



TECHNICAL SPECIFICATION OF FGD ABSORBER AGITATORS

TRY/PE-BM/FGD/AGITATOR SPEC:001/ Rev 01

	a. 100%/75%/50% load	
	b. NO load	
	c. Starting.	
17.	Efficiency at rated voltage and Frequency,	
	a.100% load	
	b. 75% load	
	c. 50% load	
18.	Starting current (amps) at	
	a. 100 % voltage	
	b. 85% voltage	
	c. 80% voltage	
19.	Minimum permissible starting Voltage (Volts)	
20.	Starting time with minimum permissible voltage/80%/ 100%/ 110%	
	a. Without driven equipment coupled	
	b. With driven equipment coupled	
21.	Safe stall time with 100% ,110% & 80% of rated voltage	
	a. From hot condition	
	b. From cold condition	
22.	Torques :	
	a. Starting torque at min. permissible voltage(kg-mtr.)/ rated voltage	
	b. Pull up torque at rated voltage.	
	c. Pull out torque	
	d. Min accelerating torque (kg.m) available at lowest permissible starting voltage	
	e. Rated torque (kg.m)	
23.	Stator winding resistance per phase (ohms at 20 Deg.C.)	
24.	GD2 value of motors	
25.	No of permissible successive starts when motor is in hot condition	
26.	Locked Rotor KVA Input	
27.	Locked Rotor KVA/KW	
28.	Vibration limit :Velocity (mm/s)	
29.	Noise level limit (dBA)	
C.	CONSTRUCTIONAL FEATURES	
1.	Stator winding insulation	
	a. Class & Type	



TECHNICAL SPECIFICATION OF FGD ABSORBER AGITATORS

TRY/PE-BM/FGD/AGITATOR SPEC:001/ Rev 01

	b. Winding Insulation Process	
	c. Tropicalised (Yes/No)	
	d. Temperature rise over specified maximum ambient temperature of 50 deg C	
	e. Method of temperature measurement	
	f. Stator winding connection	
2.	Main Terminal Box	
	a. Type	
	b. Location(viewed from NDE side)	
	c. Entry of cables(bottom/side)	
	d. Recommended cable size(To be matched with cable size envisaged by owner)	
	e. Fault level (MVA),Fault level duration(sec)	
	f. Cable glands & lugs details (shall be suitable for power cable)	
3.	Type of DE/NDE Bearing	
4.	Motor Paint shade	
5.	Weight of	
	a. Motor stator (KG)	
	b. Motor Rotor (KG)	
	c. Total weight (KG)	
D.	List of accessories.	
1.	Space Heaters (Nos./Power in watts/supply voltage)	
2.	Terminal Box for Space Heater (Yes/No)	
3.	Speed switch (Yes/No)	
	No of contacts and contact ratings of speed switch	
4.	Insulation of bearing (Yes/No)	
5.	Noise reducer(Yes/No)	
6.	Grounding pads	
	i) No and size on motor body	
	ii) Nos on terminal Box	
7.	Any other fitments	
E.	List of curves.	
	Torque speed characteristic of the motor	



TECHNICAL SPECIFICATION OF FGD ABSORBER AGITATORS

TRY/PE-BM/FGD/AGITATOR SPEC:001/ Rev 01

	Thermal withstand characteristic	
	Starting. current Vs. Time	
	Starting. current Vs speed	
	P.F. and Effi. Vs Load	



TECHNICAL SPECIFICATION OF FGD ABSORBER AGITATORS

TRY/PE-BM/FGD/AGITATOR SPEC:001/ Rev 01

Annexure-V -Schedule of Guarantees (TO BE FILLED FOR EACH AGITATOR)

Project:

Enquiry No:

Agitator Name:

SL. NO.	DESCRIPTION	UNIT	DATA
1	Rated Input Power at Motor Terminal at Normal water level and at Normal voltage and Frequency (*)	KW	
2	Possible Rate of deposit of solid particles at tank bottom of total solid particle inflow/outflow	%	
2	Noise level at a distance of 1.0 meter from the equipment at site	dB(A)	85
3	Maximum vibration velocity at site (RMS)	mm/sec	
4	Life of Agitator components parts from the date of Commissioning for continuous operation		24 months
5	Anti-friction Bearing		25000 hrs.

BIDDER SIGN : _____

DESIGNATION : _____

DATE : _____



TECHNICAL SPECIFICATION OF FGD ABSORBER AGITATORS

TRY/PE-BM/FGD/AGITATOR SPEC:001/ Rev 01

Annexure-VI-- LIST OF DEVIATIONS OR EXCEPTIONS TO THE ENQUIRY DOCUMENT

Project :

Enquiry No:

*We hereby accept to the Technical Specification for agitators and **all the parameters for this project**

SIGNATURE OF BIDDER -----

NAME -----

DESIGNATION -----

(OR)

*The following are the technical deviations to the specification:

SI No	Clause No	Page No	Description of Deviation

SIGNATURE OF BIDDER -----

NAME -----

DESIGNATION -----

*Strike out whichever is not applicable

BIDDER SIGN WITH SEAL AND DATE:

SIDE VIEW

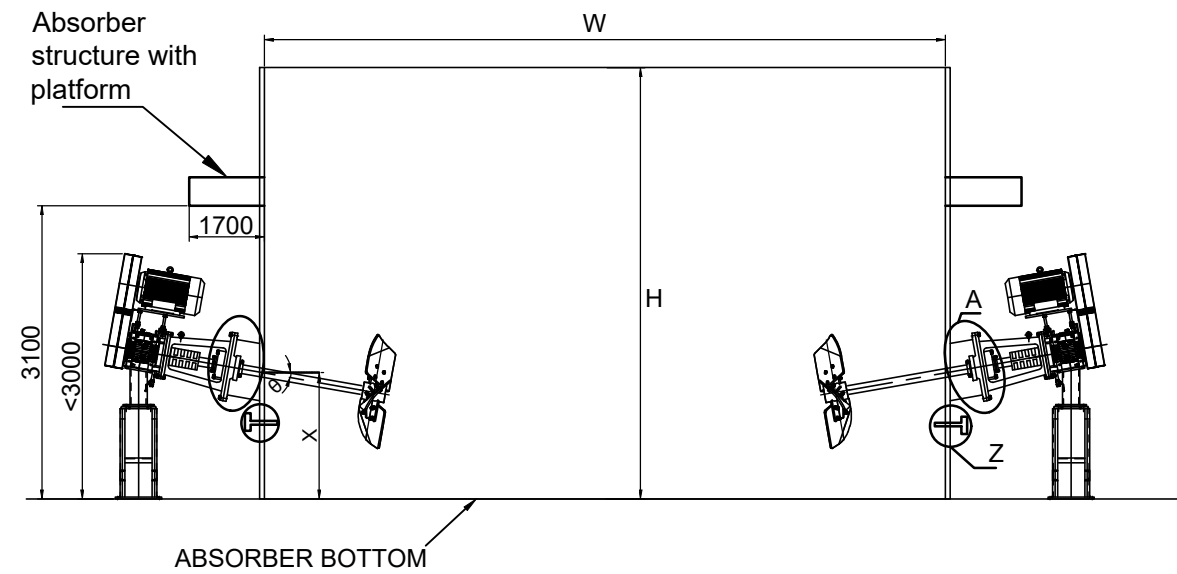

TOP VIEW

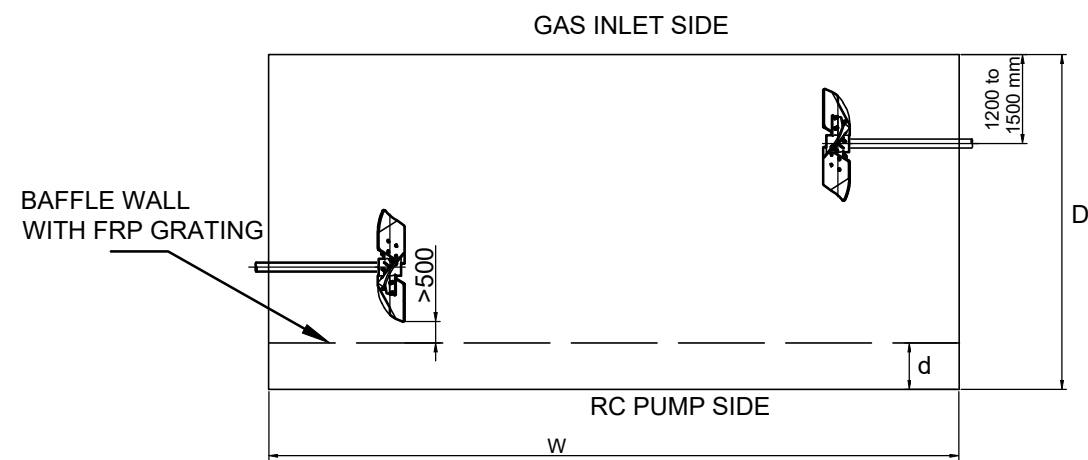

NOTES:-

1. TYPICAL ARRANGEMENT IS SHOWN WITH V BELT & PULLEY. VENDOR CAN ALSO OFFER GEAR BOX DRIVEN AGITATOR.
2. FOR TANK HEIGHT (H), WIDTH(W) AND DEPTH(D), BIDDER SHALL REFER TO BE TECHNICAL INFORMATION FOR SIZING OF ABSORBER AGITATORS
3. BAFFLE WALL IS LOCATED AT A DISTANCE 'd' FROM THE ABSORBER WALL
IF $D < \text{or} = 9900 \text{ MM}$, THEN $d = 2200 \text{ MM}$
 $D > 9900 \text{ MM}$, THEN $d = (D - 8000) \text{ MM}$
THE ABSORBER AGITATOR SHALL BE DESIGNED TO PREVENT THE SLURRY SETTLEMENT AT BOTTOM OF THE ENTIRE TANK INCLUDING THE AREA BETWEEN THE BAFFLE WALL AND THE ABSORBER WALL.
4. THE AGITATOR LOCATION SHALL BE SUGGESTED BY VENDOR CONSIDERING THE LOCATION OF THE BAFFLE WALL. BAFFLE WALL IS MADE OF FRP GRATINGS, VENDOR TO INDICATE THE VALUE OF X AND θ .
5. AGITATOR AND EMERGENCY FLUSH LINE NOZZLES SUPPLY BY BHEL, HOWEVER COMPLETE DESIGN, ENGINEERING, PRODUCTION DRAWINGS AND SUPPORT FOR PRODUCTION ARE IN AGITATOR VENDOR SCOPE

ABSORBER AGITATOR NOZZLE ARRANGEMENT

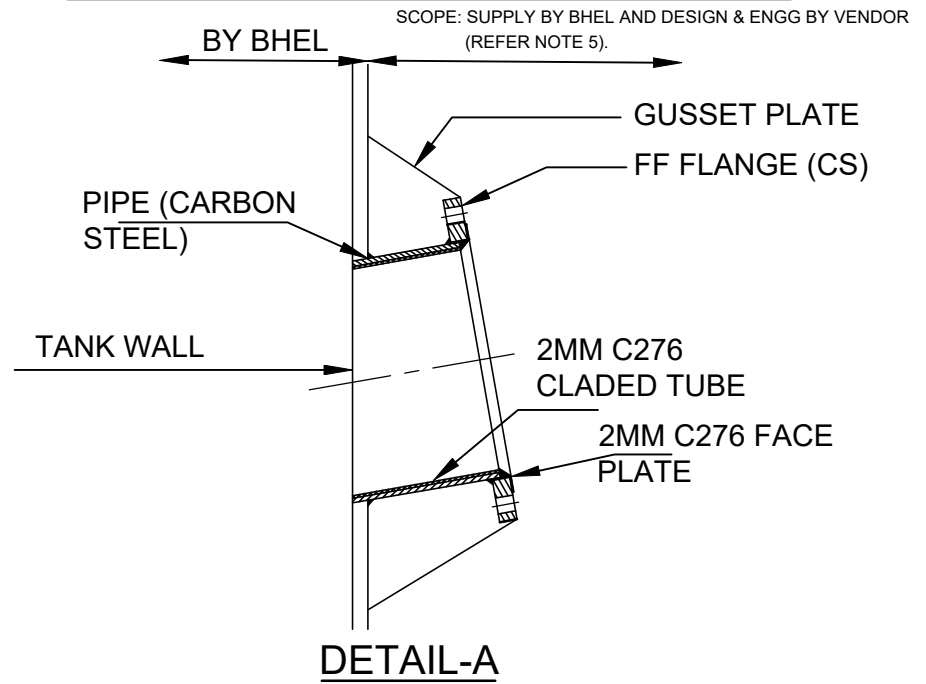

EMERGENCY FLUSH PIPE ARRANGEMENT (ABSORBER AGITATOR)

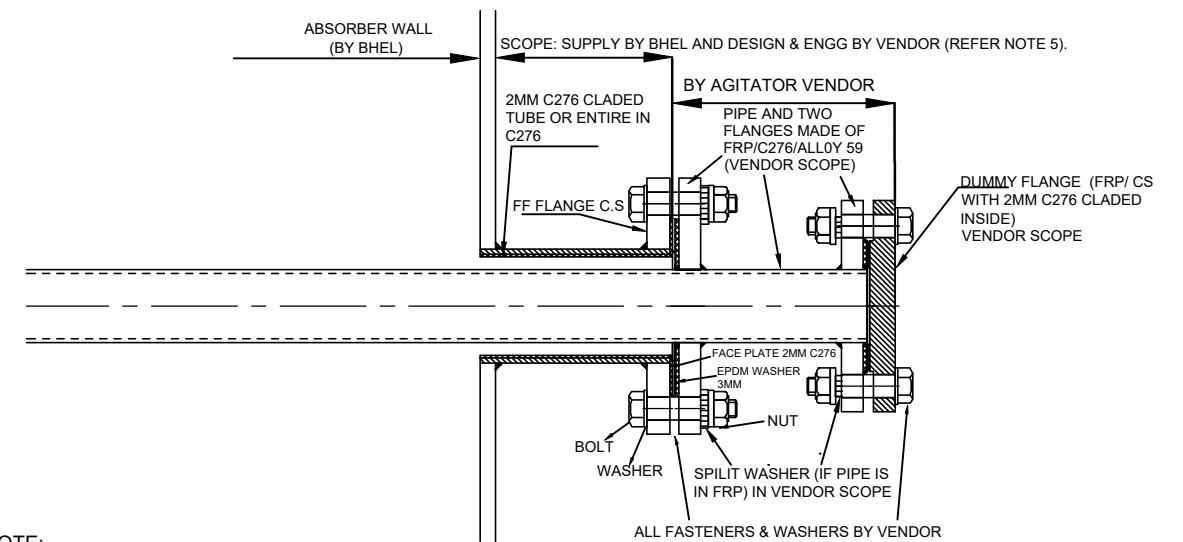

NOTE:

FLAT FACE SHEET ON C276 CLADDING FLANGE SHALL ACT AS RAISED FACE. OD OF C276 SHEET ON THE FLANGE SHALL BE EQUAL TO ASME B16.5 CLASS 150.

DETAIL-Z

CAUTION: The information on this document is the property of BHARAT HEAVY ELECTRICALS LTD. It must not be used directly or indirectly in any way detrimental to the interest of the company.	TYPE OF PRODUCT OR NAME OF CUSTOMER/PROJECT		FGD SYSTEM PACKAGE			
	Bharat Heavy Electricals Ltd UNIT: HIGH PRESSURE BOILER PLANT TIRUCHIRAPALLI - 620014		DRN	NAME	SIGNATURE	DATE
	355-055		CHD	THANGAMALAR P		21.03.2021
	DEPT BM		APPD	SATHESH KUMAR S		21.03.2021
CODE 121	ALL DIMENSIONS ARE IN MM	PROJECTION	SCALE	WEIGHT (Kg)	REF TO ASSY / OLD DWG	
TITILE		DRAWING NO :			REV	
TYPICAL ARRANGEMENT OF SIDE ENTRY AGITATOR IN ABSORBER		3-FG-365-08024			00	



BHARAT HEAVY ELECTRICALS LIMITED

HIGH PRESSURE BOILER PLANT, TIRUCHIRAPALLI-620 014

CONTROLS & INSTRUMENTATION/FB

Page 1 of 8

TECHNICAL SPECIFICATION OF

LT AC MOTORS (SAFE AREA)

SPECIFICATION REFERENCE - TCI : 140, Rev. 13

Revision History

Rev. No.	Date	Description	Prepared & Reviewed	Approved
01 -12		Earlier Revisions	-Sd-	-Sd-
13	05-06-21	General Revisit	<i>M. M. J. J.</i>	<i>A. P. J.</i>



Sl. No.	Description	Requirement
1	Site Conditions :-	
	Altitude above MSL	500 meters
	Ambient temperature	50° C
	Relative Humidity	100 %
	Atmosphere	Tropical, dusty, salty, corrosive and highly polluted environment.
2	Motor type	Squirrel cage type induction motor suitable for direct on line starting through any type of breaker.
3	Applicable Standards	IS-325, IS 12615, IS/IEC-60034, IS-12065, IS-12075, IS 15999, IS/IEC-60529, IS 4029, IS-1231, IS-6362, IS-2253. (Latest version of relevant standards shall be referred).
4	Type of Enclosure and degree of protection	Totally Enclosed Fan Cooled (TEFC), IP-55 as per IS/IEC-60529
5	Duty Cycle	Continuous, S1
6	Energy Efficiency Class	IE2/IE-3 as per IS-12615/IEC 60034-30. Refer project specific transmittal furnished along with enquiry for applicable energy efficiency class.
7	Rated Voltage & Tolerance	415 V AC, 3 Phase, ± 10 %.
8	Rated Frequency & Tolerance	50 Hz, ± 5 %
9	Combined voltage & frequency tolerance	10 % (absolute sum)
10	General Requirements	<p>a. All motors shall be so designed that maximum inrush currents, locked rotor and pull out torque, developed at the extreme voltage and frequency variations do not endanger the motor and driven equipment.</p> <p>b. Motor shall be designed to keep the torsional and rotational natural frequencies of vibration, at least 25 percent above the motor rated speed ranges to avoid resonant vibration over the operating speed range of the motor and driven equipment.</p>



Sl. No.	Description	Requirement
		c. Maximum continuous rating (MCR) of the motor shall have at least 15 % margin over the maximum load demand of the driven equipment including voltage and frequency variation. (Applicable only if vendor supplies motor along with the driven equipment or load).
11	Torque requirements	Accelerating torque at any speed with the lowest permissible starting voltage shall be at least 10% of motor full load torque. Pull Out torque at rated voltage shall not be less than 205 % of full load torque.
12	Requirements during Starting & Running	<ul style="list-style-type: none"> • Motor shall start with rated load and accelerate to full speed with 80 % rated voltage at motor terminals • The motor shall be capable of withstanding the stresses imposed if started at 110 % rated voltage. • The motor shall be capable of operating satisfactorily at full load for 5 minutes without injurious heating with 75 % rated voltage at motor terminals.
13	Momentary Overload withstanding capability	The motor shall be designed to withstand momentary overload of 60% of full load torque for 15 seconds without any damage.
14	Momentary Over speed Withstanding capability	The motor shall be designed to withstand 120 % of rated speed for 2 minutes without any mechanical damage.
15	Hot thermal withstand curve	Margin of at least 10% over the full load current
16	Class of Insulation	Class-F insulation with temperature rise limited to Class-B. Temperature rise of the motor shall be limited to 70° C (by resistance method) over an ambient temperature of 50° C.
17	Stress withstanding capability during Bus Transfer	The motor may be subjected to sudden application of 150 % rated voltage during bus transfer, due to the phase difference between the incoming voltage and motor residual voltage.
18	Capacity to restart for rated voltage	<ul style="list-style-type: none"> a. Two successive starts from cold condition. b. Three equally spread starts per hour. c. Two hot starts in succession, with motor initially running at normal temperature.



Sl. No.	Description	Requirement
19	Starting Current	The starting current (% of FLC) shall be limited as per the standard IS-12615.
20	Locked Rotor Condition	The ratio of Locked Rotor KVA at rated voltage to rated KW shall not exceed as indicated below (without any further tolerance) For Motor rating from 50 KW and up to 110 KW: 11
21	Locked Rotor with-stand time	For motor with starting time up to 20 seconds at minimum permissible voltage during starting, the locked rotor withstand time under hot condition at highest voltage limit shall be at least 2.5 seconds more than starting time.
		For motor with starting time more than 20 seconds but not exceeding 45 seconds at minimum permissible voltage during starting, the locked rotor withstand time under hot condition at highest voltage limit shall be at least 5 seconds more than the starting time.
		For motor with starting time more than 45 seconds at minimum permissible voltage during starting, the locked rotor withstand time under hot condition at highest voltage limit shall be 10% more than the starting time
		Vendor to provide Speed switches mounted on the motor shaft in case the above requirement is not met with.
22	Type of balancing of rotor	Dynamic balancing
23	Method of cooling	IC-0411 as per IS-6362
24	Direction of cooling air flow	NDE side to DE Side
25	Winding wire	Enameled Copper Wire, Grade-2, as per IS-13730, Part-3. Windings shall be non-hygroscopic, oil resistant and flame resistant.
26	Treatment on Winding Insulation	Winding Insulation shall be given tropical and fungicidal treatment for operation of motor in hot, humid & tropical climate.



Sl. No.	Description	Requirement
27	Bearing	<p>Deep Groove Ball Bearing or Roller bearing as per the motor design, properly sealed to protect against the ingress of dust and water.</p> <p>Lubrication : Grease.</p>
28	Noise level	Noise level shall be limited to 85 dB at 1 meter distance.
29	Vibration level	The peak amplitude of vibration shall be as per IS-12075 (Limits of Severity-Normal grade shall be followed).
30	Shaft extension	Motor shall be provided with key slotted bare shaft extension, with key at the drive end.
31	Terminal box	<p>Weather proof terminal box shall be provided. The terminal box shall be capable of being turned through 360° in steps of 180° or 90°. Shall meet IP 55 protection class requirements as per IS60529.</p> <p>Minimum Distance between center of the terminal stud & the gland plate and Minimum inter-phase/ phase-earth air clearance shall be provided as per IS/ IEC standards. Refer Project Specific transmittal for project specific requirements of dimensions.</p> <p>Terminal box shall have adequate space to terminate the Power cable applicable to the motor by using suitable lugs.</p> <p>Connection diagram shall be marked inside the terminal box.</p> <p>The terminal box shall be capable of withstanding a fault level of 50 kA rms for 1 second (Voltage : 415 V) at the terminals.</p>
32	Cable Entries, Cable Glands & Lugs	<p>Cable entries, Cable glands and Lugs shall be provided suitable for the power cable size, which will be indicated after PO placement during datasheet approval. Tentative sizes are indicated in the project specific transmittal.</p> <p>Double Compression type, brass with nickel plated, weather proof cable glands shall be provided – Quantity to be matched with the number of entries.</p> <p>6 Nos. of Tinned Copper Lugs shall be provided.</p>
33	Terminals	Separate Terminals for Space heaters and Windings with suitable connecting links shall be supplied.



Sl. No.	Description	Requirement
34	Earthing provisions	Earthing provisions shall be provided on motor body (2 nos. at opposite locations) and in terminal boxes as per the standard.
35	Space heater for motors rated 30 KW and above	Separate space heater suitable for 240 V AC, Single Phase supply shall be provided.
36	Lifting device	Eye bolt.
37	Project specific requirements	Vendor to take care of the project specific requirements indicated in the annexure - "Project specific transmittal".
38	Name Plates	Motor shall have name plate as per relevant IS and in addition, Manufacture's name, frame size, Energy Efficiency class, Insulation class, Bearing details, year of manufacture shall also be indicated.
39	Type test reports	<p>Type test reports shall be produced for the following tests as per the requirements spelt in the standards,</p> <ul style="list-style-type: none"> • Measurement of resistance of windings of stator. • No load test at rated voltage to determine input current power and speed • Full load test to determine efficiency, power factor and slip. • Temperature rise test. • Momentary excess torque test. • High voltage test. • Test for vibration severity of motor. • Test for noise levels of motor. • Test for degree of protection. • Over speed test. • Energy Efficiency test. <p>In case the vendor is not able to submit report of the type test(s) conducted within last 5 years from the date of bid opening, or in case the type test report(s) are not found to be meeting the specification requirements, the vendor shall conduct all such tests either in an independent laboratory or at manufacturer's works in presence of Owner's representative under this contract, free of cost to the Owner and submit the reports for approval.</p>



Sl. No.	Description	Requirement
40	Confirmation and Documents to be submitted by the vendor, during Purchase Enquiry.	Vendor to indicate the references of the technical specification, project specific annexure and indicate "No Deviation" in the Sub-Delivery Enquiry deviation form. Any deviation shall only be indicated in the Sub-Delivery Enquiry deviation form. Deviations indicated elsewhere in the offer will not be considered.
41	Documents to be submitted by the vendor for approval by BHEL/Customer, after placement of purchase order.	3 Sets of the following: - a. Final technical Data sheet as per the format submitted by BHEL. b. Motor GA drawing indicating details of foundation, shaft dimensions and terminal box arrangement with complete dimensions. c. Motor Characteristic curves (Torque Vs. Speed, Current Vs. Speed, Speed Vs. time, Current Vs. time, Efficiency and PF Vs. load, Thermal withstand characteristic) d. O & M manuals.
42	Packing	The packing shall be suitable for safe transport, safe delivery at site and shall avoid damages due to environmental conditions during storage at site.
43	Painting	Paint shade shall be as per the purchase enquiry. The finish shall be corrosion resistant, epoxy based paint.

Project specific Transmittal
Reference :- TR: LT AC-DC MOTOR: KORBA FGD

CLAUSE NO.	<p align="center">TECHNICAL REQUIREMENTS</p> 																											
	<p align="center">MOTORS</p> <p>1.00.00 GENERAL REQUIREMENTS</p> <p>1.01.00 For the purpose of design of equipment/systems, an ambient temperature of 50 deg. Centigrade and relative humidity of 95% (at 40 deg C) shall be considered. The equipment shall operate in a highly polluted environment.</p> <p>1.02.00 All equipment's shall be suitable for rated frequency of 50 Hz with a variation of +3% & -5%, and 10% combined variation of voltage and frequency unless specifically brought out in the specification.</p> <p>1.03.00 Contactor shall provide fully compatible electrical system, equipment's, accessories and services.</p> <p>1.04.00 All the equipment, material and systems shall, in general, conform to the latest edition of relevant National and international Codes & Standards, especially the Indian Statutory Regulations.</p> <p>1.05.00 Paint shade shall be as per RAL 5012 (Blue) for indoor and outdoor equipment.</p> <p>1.06.00 The responsibility of coordination with electrical agencies and obtaining all necessary clearances for Contactors equipment and systems shall be under the Contactor scope.</p> <p>1.07.00 Degree of Protection</p> <p>Degree of protection for various enclosures as per IEC60034-05 shall be as follows :-</p> <table border="0"> <tr> <td>i) Indoor motors</td> <td>-</td> <td>IP 54</td> </tr> <tr> <td>ii) Outdoor motors</td> <td>-</td> <td>IP 55</td> </tr> <tr> <td>iii) Cable box-indoor area</td> <td>-</td> <td>IP 54</td> </tr> <tr> <td>iv) Cable box-Outdoor area</td> <td>-</td> <td>IP 55</td> </tr> </table> <p>2.00.00 CODES AND STANDARDS</p> <table border="0"> <tr> <td>1) Three phase induction motors</td> <td>:</td> <td>IS/IEC:60034</td> </tr> <tr> <td>2) Single phase AC motors</td> <td>:</td> <td>IS/ IEC:60034</td> </tr> <tr> <td>3) Crane duty motors</td> <td>:</td> <td>IS:3177, IS/IEC:60034</td> </tr> <tr> <td>4) DC motors/generators</td> <td>:</td> <td>IS:4722, IS/IEC:60034</td> </tr> <tr> <td>5) Energy Efficient motors</td> <td>:</td> <td>IS 12615, IEC:60034-30</td> </tr> </table>	i) Indoor motors	-	IP 54	ii) Outdoor motors	-	IP 55	iii) Cable box-indoor area	-	IP 54	iv) Cable box-Outdoor area	-	IP 55	1) Three phase induction motors	:	IS/IEC:60034	2) Single phase AC motors	:	IS/ IEC:60034	3) Crane duty motors	:	IS:3177, IS/IEC:60034	4) DC motors/generators	:	IS:4722, IS/IEC:60034	5) Energy Efficient motors	:	IS 12615, IEC:60034-30
i) Indoor motors	-	IP 54																										
ii) Outdoor motors	-	IP 55																										
iii) Cable box-indoor area	-	IP 54																										
iv) Cable box-Outdoor area	-	IP 55																										
1) Three phase induction motors	:	IS/IEC:60034																										
2) Single phase AC motors	:	IS/ IEC:60034																										
3) Crane duty motors	:	IS:3177, IS/IEC:60034																										
4) DC motors/generators	:	IS:4722, IS/IEC:60034																										
5) Energy Efficient motors	:	IS 12615, IEC:60034-30																										
<p align="center">LOT-3 PROJECTS FLUE GAS DESULPHURISATION (FGD) SYSTEM PACKAGE</p>	<p align="center">TECHNICAL SPECIFICATION SECTION – VI, PART-B BID DOC NO : CS-0011-109(3)-9</p>	<p align="center">SUB SECTION-II-E2 MOTORS</p>	<p align="center">PAGE 1 OF 9</p>																									

Annexure-VII

CLAUSE NO.	TECHNICAL REQUIREMENTS	
3.00.00	TYPE	
3.01.00	<p>AC Motors:</p> <p>a) Squirrel cage induction motor suitable for direct-on-line starting.</p> <p>b) Continuous duty LT motors upto 200 KW Output rating (at 50 deg.C ambient temperature), shall be Premium Efficiency class-IE3, conforming to IS 12615, or IEC:60034-30. LT motors shall have minimum design efficiency of 95 %. However, tolerance on this efficiency value shall be applicable as per IEC 60034</p> <p>c) Crane duty motors shall be slip ring/ squirrel cage Induction motor as per the requirement.</p> <p>d) Motor operating through variable frequency drives shall be suitable for inverter duty with VPI insulation. Also these motors shall comply the requirements stipulated in IEC: 60034-18-41 and IEC: 60034-18-42 as applicable.</p> <p>e) Motors operating through variable frequency drives shall also meet the requirements mentioned in subsection for VFD.</p>	
3.02.00	DC Motors Shunt wound.	
4.00.00	RATING	
	<p>(a) Continuously rated (S1). However, crane motors shall be rated for S4 duty, 40% cyclic duration factor.</p> <p>(b) Whenever the basis for motor or driven equipment ratings are not specified in the corresponding mechanical specification sub-sections, maximum continuous motor ratings shall be at least 10% above the maximum load demand of the driven equipment under entire operating range including voltage and frequency variations.</p>	
5.00.00	TEMPERATURE RISE	
	<p>Air cooled motors</p> <p>70 deg. C by resistance method for both thermal class 130(B) & 155(F) insulation.</p> <p>Water cooled</p> <p>80 deg. C over inlet cooling water temperature mentioned elsewhere, by resistance method for both thermal class 130(B) & 155(F) insulation.</p>	
6.00.00	OPERATIONAL REQUIREMENTS	
6.01.00	Starting Time	
LOT-3 PROJECTS FLUE GAS DESULPHURISATION (FGD) SYSTEM PACKAGE	TECHNICAL SPECIFICATION SECTION – VI, PART-B BID DOC NO : CS-0011-109(3)-9	SUB SECTION-II-E2 MOTORS
		PAGE 2 OF 9

Annexure-VII

CLAUSE NO.	TECHNICAL REQUIREMENTS		
6.01.01	For motors with starting time upto 20 secs. at minimum permissible voltage during starting, the locked rotor withstand time under hot condition at highest voltage limit shall be at least 2.5 secs. more than starting time.		
6.01.02	For motors with starting time more than 20 secs. and upto 45 secs. at minimum permissible voltage during starting, the locked rotor withstand time under hot condition at highest voltage limit shall be at least 5 secs. more than starting time.		
6.01.03	For motors with starting time more than 45 secs. at minimum permissible voltage during starting, the locked rotor withstand time under hot condition at highest voltage limit shall be more than starting time by at least 10% of the starting time.		
6.01.04	Speed switches mounted on the motor shaft shall be provided in cases where above requirements are not met.		
6.02.00	Torque Requirements		
6.02.01	Accelerating torque at any speed with the lowest permissible starting voltage shall be at least 10% motor rated torque.		
6.02.02	Pull out torque at rated voltage shall not be less than 205% of rated torque. It shall be 275% for crane duty motors.		
6.03.00	Starting voltage requirement		
	(a) Up to 85% of rated voltage for ratings below 110 KW		
	(b) Up to 80% of rated voltage for ratings from 110 KW to 200 KW		
	(c) Up to 85% of rated voltage for ratings from 201 KW to 1000 KW		
	(d) Up to 80% of rated voltage for ratings from 1001 KW to 4000 KW		
	(e) Up to 75 % of rated voltage for ratings above 4000KW		
7.00.00	DESIGN AND CONSTRUCTIONAL FEATURES		
7.01.00	Suitable single phase space heaters shall be provided on motors rated 30KW and above to maintain windings in dry condition when motor is standstill. Separate terminal box for space heaters & RTDs shall be provided. However for flame proof motors, space heater terminals inside the main terminal box may be acceptable.		
7.02.00	All motors shall be either Totally enclosed fan cooled (TEFC) or totally enclosed tube ventilated (TETV) or Closed air circuit air cooled (CACA) type. However, motors rated 3000KW or above can be Closed air circuit water cooled (CACW). The method of movement of primary and secondary coolant shall be self-circulated by fan or pump directly mounted on the rotor of the main motor as per IEC 60034-6. However VFD driven motors can be offered with forced cooling type with machine mounted fan or pump driven by separate electric motor. Motors and EPB located in hazardous areas shall have flame proof enclosures conforming to IS:2148 as detailed below		
LOT-3 PROJECTS FLUE GAS DESULPHURISATION (FGD) SYSTEM PACKAGE	TECHNICAL SPECIFICATION SECTION – VI, PART-B BID DOC NO : CS-0011-109(3)-9	SUB SECTION-II-E2 MOTORS	PAGE 3 OF 9

Annexure-VII

CLAUSE NO.	TECHNICAL REQUIREMENTS		
			
7.03.00	<p>(a) Fuel oil area : Group – IIB</p> <p>(b) Hydrogen generation : Group - IIC or (Group-I, Div-II as per plant area NEC) or (Class-1, Group-B, Div-II as per NEMA /IEC60034)</p> <p>Winding and Insulation</p> <p>(a) Type : Non-hygroscopic, oil resistant, flame resistant</p> <p>(b) Starting duty : Two hot starts in succession, with motor initially at normal running temperature.</p> <p>(c) 11kV, 6.6 KV & 3.3 kV AC motors : Thermal class 155 (F) insulation. The winding insulation process shall be total Vacuum Pressure Impregnated i.e resin poor method. The lightning Impulse & interturn insulation surge withstand level shall be as per IEC-60034 part-15.</p> <p>(d) 240VAC, 415V AC & 220V DC motors : Thermal Class (B) or better</p>		
7.04.00	Motors rated above 1000KW shall have insulated bearings/housing to prevent flow of shaft currents.		
7.05.00	Motors with heat exchangers shall have dial type thermometer with adjustable alarm contacts to indicate inlet and outlet primary air temperature.		
7.06.00	Noise level for all the motors shall be limited to 85 dB(A) except for BFP motor for which the maximum limit shall be 90dB(A). Vibration shall be limited within the limits prescribed in IS:12075 / IEC 60034-14 . Motors shall withstand vibrations produced by driven equipment. HT motor bearing housings shall have flat surfaces, in both X and Y directions, suitable for mounting 80mmX80mm vibration pads		
7.07.00	In HT motors, at least four numbers simplex / two numbers duplex platinum resistance type temperature detectors shall be provided in each phase stator winding. Each bearing of HT motor shall be provided with dial type thermometer and minimum 2 numbers duplex platinum resistance type temperature detectors.		
7.08.00	Motor body shall have two earthing points on opposite sides.		
7.09.00	11 KV motors shall be offered with Separable Insulated Connector (SIC) as per IEEE 386. The offered SIC terminations shall be provided with protective cover and trifurcating sleeves. SIC termination kit shall be suitable for fault level of 25 KA for 0.17 seconds.		
7.10.00	3.3/6.6 KV motors shall be offered with dust tight phase separated double walled (metallic as well as insulated barrier) Terminal box. Contractor shall provide termination kit for the offered Terminal box. The offered Terminal Box shall be		
LOT-3 PROJECTS FLUE GAS DESULPHURISATION (FGD) SYSTEM PACKAGE	TECHNICAL SPECIFICATION SECTION – VI, PART-B BID DOC NO : CS-0011-109(3)-9	SUB SECTION-II-E2 MOTORS	PAGE 4 OF 9

Annexure-VII

CLAUSE NO.	TECHNICAL REQUIREMENTS		
	<p>suitable for fault level of 250 MVA for 0.12 sec. Removable gland plates of thickness 3 mm (hot/cold rolled sheet steel) or 4 mm (non magnetic material for single core cables) shall be provided.</p>		
7.11.00	The spacing between gland plate & centre of bottom terminal stud shall be as per Table-I.		
7.12.00	All motors shall be so designed that maximum inrush currents and locked rotor and pullout torque developed by them at extreme voltage and frequency variations do not endanger the motor and driven equipment.		
7.13.00	The motors shall be suitable for bus transfer schemes provided on the 11kV, 6.6 KV, 3.3 kV /415V systems without any injurious effect on its life.		
7.14.00	For motors rated 2000 KW & above, neutral current transformers of PS class shall be provided on each phase in a separate neutral terminal box.		
7.15.00	The size and number of cables (for HT motors) to be intimated to the successful Contactor during detailed engineering and the Contactor shall provide terminal box suitable for the same.		
8.00.00	<p>The ratio of locked rotor KVA at rated voltage to rated KW shall not exceed the following (without any further tolerance):</p> <p>(a) From 50KW & upto 110KW : 11.0</p> <p>(b) From 110 KW & upto 200 KW : 9.0</p> <p>(c) Above 200 KW & upto 1000KW : 10.0</p> <p>(d) From 1001KW & upto 4000KW : 9.0</p> <p>(e) Above 4000KW : 6 to 6.5</p>		
10.00.00	TYPE TEST		
10.01.00	HT MOTORS	Clause Nos. 10.01.00 to 10.01.06 - Type test requirements for HT motor are not applicable. Go to Page no. 07/09	
10.01.01	The Contactor shall carry out the type tests as listed in this specification on the equipment to be supplied under this contract. The Contactor shall indicate the charges for each of these type tests separately in the relevant schedule of Section - VII- (BPS) and the same shall be considered for the evaluation of the bids. The type tests charges shall be paid only for the test(s) actually conducted successfully under this contract and upon certification by the Employer's engineer.		
10.01.02	The type tests shall be carried out in presence of the Employer's representative, for which minimum 15 days notice shall be given by the Contactor. The Contactor shall obtain the Employer's approval for the type test procedure before conducting the type test. The type test procedure shall clearly specify the test set-up, instruments to be used, procedure, acceptance norms, recording of different		
LOT-3 PROJECTS FLUE GAS DESULPHURISATION (FGD) SYSTEM PACKAGE	TECHNICAL SPECIFICATION SECTION – VI, PART-B BID DOC NO : CS-0011-109(3)-9	SUB SECTION-II-E2 MOTORS	PAGE 5 OF 9

Annexure-VII

CLAUSE NO.	TECHNICAL REQUIREMENTS 		
10.01.03	<p>parameters, interval of recording, precautions to be taken etc. for the type test(s) to be carried out.</p> <p>In case the Contactor has conducted such specified type test(s) within last ten years as on the date of bid opening, he may submit during detailed engineering the type test reports to the Employer for waiver of conductance of such test(s). These reports should be for the tests conducted on the equipment similar to those proposed to be supplied under this contract and test(s) should have been either conducted at an independent laboratory or should have been witnessed by a client. The Employer reserves the right to waive conducting of any or all the specified type test(s) under this contract. In case type tests are waived, the type test charges shall not be payable to the Contactor.</p>		
10.01.04	<p>Further the Contactor shall only submit the reports of the type tests as listed in "LIST OF TESTS FOR WHICH REPORTS HAVE TO BE SUBMITTED" and carried out within last ten years from the date of bid opening. These reports should be for the test conducted on the equipment similar to those proposed to be supplied under this contract and the test(s) should have been either conducted at an independent laboratory or should have been witnessed by a client. However if the Contactor is not able to submit report of the type test(s) conducted within last ten years from the date of bid opening, or in the case of type test report(s) are not found to be meeting the specification requirements, the Contactor shall conduct all such tests under this contract at no additional cost to the Employer either at third party lab or in presence of client/Employers representative and submit the reports for approval.</p>		
10.01.05	<p>LIST OF TYPE TESTS TO BE CONDUCTED</p> <p>The following type tests shall be conducted on each type and rating of HT motor</p> <ul style="list-style-type: none"> (a) No load saturation and loss curves upto approximately 115% of rated voltage (b) Measurement of noise at no load. (c) Momentary excess torque test (subject to test bed constraint). (d) Full load test(subject to test bed constraint) (e) Temperature rise test at rated conditions. During heat run test, bearing temp., winding temp.,coolant flow and its temp. shall also be measured. In case the temperature rise test is carried at load other than rated load, specific approval for the test method and procedure is required to be obtained. Wherever ETD's are provided, the temperature shall be measured by ETD's also for the record purpose. 		
LOT-3 PROJECTS FLUE GAS DESULPHURISATION (FGD) SYSTEM PACKAGE	TECHNICAL SPECIFICATION SECTION – VI, PART-B BID DOC NO : CS-0011-109(3)-9	SUB SECTION-II-E2 MOTORS	PAGE 6 OF 9

Annexure-VII

CLAUSE NO.	TECHNICAL REQUIREMENTS <div style="float: right; border: 1px solid black; padding: 2px; text-align: center;">  </div>		
10.01.06	<p>LIST OF TESTS FOR WHICH REPORTS HAVE TO BE SUBMITTED</p> <p>The following type test reports shall be submitted for each type and rating of HT motor</p> <ul style="list-style-type: none"> (a) Degree of protection test for the enclosure followed by IR, HV and no load run test. (b) Terminal box-fault level withstand test for each type of terminal box of HT motors only. (c) Lightning Impulse withstand test on the sample coil shall be as per clause no. 4.3 IEC-60034, part-15 (d) Surge-withstand test on inter-turn insulation shall be as per clause no. 4.2 of IEC 60034, part-15 		
10.02.00	<p>LT Motors</p>		
10.02.01	<p>LT Motors supplied shall be of type tested design. During detailed engineering, the Contactor shall submit for Employer's approval the reports of all the type tests as listed in this specification and carried out within last <i>ten</i> years from the date of bid opening. These reports should be for the test conducted on the equipment similar to those proposed to be supplied under this contract and the test(s) should have been either conducted at an independent laboratory or should have been witnessed by a client.</p>		
10.02.02	<p>However if the Contactor is not able to submit report of the type test(s) conducted within last ten years from the date of bid opening, or in the case of type test report(s) are not found to be meeting the specification requirements, the Contactor shall conduct all such tests under this contract at no additional cost to the Employer either at third party lab or in presence of client/Employers representative and submit the reports for approval.</p>		
10.02.03	<p>LIST OF TESTS FOR WHICH REPORTS HAVE TO BE SUBMITTED</p> <p>The following type test reports shall be submitted for each type and rating of LT motor of above 100 KW only</p> <ul style="list-style-type: none"> 1. Measurement of resistance of windings of stator and wound rotor. 2. No load test at rated voltage to determine input current power and speed 3. Open circuit voltage ratio of wound rotor motors (in case of Slip ring motors) 4. Full load test to determine efficiency power factor and slip 5. Temperature rise test 		
LOT-3 PROJECTS FLUE GAS DESULPHURISATION (FGD) SYSTEM PACKAGE	TECHNICAL SPECIFICATION SECTION – VI, PART-B BID DOC NO : CS-0011-109(3)-9	SUB SECTION-II-E2 MOTORS	PAGE 7 OF 9

Annexure-VII

CLAUSE NO.	TECHNICAL REQUIREMENTS 
10.03.00	<ol style="list-style-type: none">6. Momentary excess torque test.7. High voltage test8. Test for vibration severity of motor.9. Test for noise levels of motor(Shall be limited as per clause no 7.06.00 of this section)10. Test for degree of protection and11. Overspeed test.12. Type test reports for motors located in fuel oil area having flame proof enclosures as per IS 2148 / IEC 60079-1 <p>All acceptance and routine tests as per the specification and relevant standards shall be carried out. Charges for these shall be deemed to be included in the equipment price.</p>
10.04.00	<p>The type test reports once approved for any projects shall be treated as reference. For subsequent projects of NTPC, an endorsement sheet will be furnished by the manufacturer confirming similarity and "No design Change". Minor changes if any shall be highlighted on the endorsement sheet.</p>

LOT-3 PROJECTS FLUE GAS DESULPHURISATION (FGD) SYSTEM PACKAGE	TECHNICAL SPECIFICATION SECTION – VI, PART-B BID DOC NO : CS-0011-109(3)-9	SUB SECTION-II-E2 MOTORS	PAGE 8 OF 9
---	--	-----------------------------	----------------

Annexure-VII

CLAUSE NO.	TECHNICAL REQUIREMENTS																													
	<p>TABLE - I</p> <p>DIMENSIONS OF TERMINAL BOXES FOR LV MOTORS</p> <table style="width: 100%; border-collapse: collapse;"> <thead> <tr> <th style="width: 60%; text-align: left;">Motor MCR in KW</th> <th style="width: 40%; text-align: left;">Minimum distance between centre of bottom terminal stud and gland plate in mm</th> </tr> </thead> <tbody> <tr> <td>UP to 3 KW</td> <td>As per manufacturer's practice.</td> </tr> <tr> <td>Above 3 KW - upto 7 KW</td> <td style="text-align: center;">85</td> </tr> <tr> <td>Above 7 KW - upto 13 KW</td> <td style="text-align: center;">115</td> </tr> <tr> <td>Above 13 KW - upto 24 KW</td> <td style="text-align: center;">167</td> </tr> <tr> <td>Above 24 KW - upto 37 KW</td> <td style="text-align: center;">196</td> </tr> <tr> <td>Above 37 KW - upto 55 KW</td> <td style="text-align: center;">249</td> </tr> <tr> <td>Above 55 KW - upto 90 KW</td> <td style="text-align: center;">277</td> </tr> <tr> <td>Above 90 KW - upto 125 KW</td> <td style="text-align: center;">331</td> </tr> <tr> <td>Above 125 KW-upto 200 KW</td> <td style="text-align: center;">385/203 (For Single core cables only)</td> </tr> </tbody> </table> <p>For HT motors the distance between gland plate and the terminal studs shall not be less than 500 mm.</p> <p>PHASE TO PHASE/ PHASE TO EARTH AIR CLEARANCE:</p> <p>NOTE: Minimum inter-phase and phase-earth air clearances for LT motors with lugs installed shall be as follows:</p> <table style="width: 100%; border-collapse: collapse;"> <thead> <tr> <th style="width: 60%; text-align: left;">Motor MCR in KW</th> <th style="width: 40%; text-align: left;">Clearance</th> </tr> </thead> <tbody> <tr> <td>UP to 110 KW</td> <td style="text-align: center;">10mm</td> </tr> <tr> <td>Above 110 KW and upto 150 KW</td> <td style="text-align: center;">12.5mm</td> </tr> <tr> <td>Above 150 KW</td> <td style="text-align: center;">19mm</td> </tr> </tbody> </table>	Motor MCR in KW	Minimum distance between centre of bottom terminal stud and gland plate in mm	UP to 3 KW	As per manufacturer's practice.	Above 3 KW - upto 7 KW	85	Above 7 KW - upto 13 KW	115	Above 13 KW - upto 24 KW	167	Above 24 KW - upto 37 KW	196	Above 37 KW - upto 55 KW	249	Above 55 KW - upto 90 KW	277	Above 90 KW - upto 125 KW	331	Above 125 KW-upto 200 KW	385/203 (For Single core cables only)	Motor MCR in KW	Clearance	UP to 110 KW	10mm	Above 110 KW and upto 150 KW	12.5mm	Above 150 KW	19mm	
Motor MCR in KW	Minimum distance between centre of bottom terminal stud and gland plate in mm																													
UP to 3 KW	As per manufacturer's practice.																													
Above 3 KW - upto 7 KW	85																													
Above 7 KW - upto 13 KW	115																													
Above 13 KW - upto 24 KW	167																													
Above 24 KW - upto 37 KW	196																													
Above 37 KW - upto 55 KW	249																													
Above 55 KW - upto 90 KW	277																													
Above 90 KW - upto 125 KW	331																													
Above 125 KW-upto 200 KW	385/203 (For Single core cables only)																													
Motor MCR in KW	Clearance																													
UP to 110 KW	10mm																													
Above 110 KW and upto 150 KW	12.5mm																													
Above 150 KW	19mm																													
<p>LOT-3 PROJECTS FLUE GAS DESULPHURISATION (FGD) SYSTEM PACKAGE</p>	<p>TECHNICAL SPECIFICATION SECTION – VI, PART-B BID DOC NO : CS-0011-109(3)-9</p>	<p>SUB SECTION-II-E2 MOTORS</p>																												
		<p>PAGE 9 OF 9</p>																												

Annexure-VIII

Supplier Logo	MANUFACTURING QUALITY PLAN (* Indicative*)							PROJECT: PACKAGE: FGD PACKAGE CONTRACT No.: CUST No: Contractor- BHEL						
	Manufacturer Name and Address				ITEM: AGITATOR									
					QP NO: ,REV:0 DT:									
					Page 1 of 2									
SL. NO.	COMPONENT OPERATION	CHARATERISTICS	CLASS	TYPE OF CHECK	QUATUM OF CHECK		REFERENCE DOCUMENT	ACCEPTANCE NORMS	FORMAT OF RECORD		AGENCY			REMARKS
					M	C/N			M	C	N			
1	2	3	4	5	6	C/N	7	8	9	D*	10	11		

1.0	Raw Material Inspection												
1.1	All materials including casting & forgings	Chem. & Mech. Dimensions Surface Defects	MA MA MA	Review of MTC Measurement Visual	1/Heat 100% - 100%	1/H eat - -	As per Spec. & Appd. Dwg.	TC IR IR	√	P P P	V - -	V - -	
2.0	Motor: Review of Manufacture Test Certificate												
3.0	In Process Inspection												
3.1	Welding Qualifications	WPS & PQR	MA	WPS, PQR & WPQ	100%		ASME Sec IX	IR	√	P	V	V	Recent qualified WPS,PQR and WPQ shall be submitted for review during inspection.
3.2	Marking, Cutting, Edge Preparation Tacking	Dimensions	MA	Measurement	100%	-	Appd. Dwg.	IR		P	-	-	
3.3	Welds	Dimensions & Surface Quality	MA	Measurement & Visual	100%		Appd. Dwg. & .ASME Sec VIII	IR	√	P	W	V	
3.4	Machining of Components	Dimensions Surface Defects	MA	Measurement Visual	100% 100%	- -	Appd. Dwg.	IR		P P	- -	- -	
3.5	Impeller	Static balance test	MA	Measurement	100%		As per Specs.	TR	√	P	V	V	
3.6	Rubber Lining	Spark test, Hardness, Adhesion test, Coating thickness, High voltage porosity test	MA	Measurement	100%		As per Specs./ Appd Dwg & Data sheet	TR	√	P	W	V	
3.7	Assembly	Dimensions Completeness	MA	Measurement Visual	100% 100%		Appd.Drg.	IR	√	P P	V V	V V	
4.0	Final Inspection												
4.1	Final Assembly	Overall Dimensions & Completeness	MA MA	Measurement Visual	100%	10%	Appd.Drg. & Spec.	IR	√	P	W	V	

MANUFACTURER	Prepared by	LEGEND: * RECORDS, IDENTIFIED WITH "TICK" (√) UNDER COLUMN 'D'SHALL BE SUBMITTED TO CUSTOMER AS A QA DOCUMENTATION PACKAGE. M: MANUFACTURE/SUB SUPPLIER, C MAIN CONTRACTOR/ N: NTPC/ P: PERFORM W: WITNESS AND V: REVIEW OF RECORDS				
	Approved by					
SIGNATURE			FOR CUSTOMER USE	REVIEWED BY	APPROVED BY	APPROVAL SEAL

Annexure-VIII

Supplier Logo		MANUFACTURING QUALITY PLAN (* Indicative*)						PROJECT: PACKAGE: FGD PACKAGE CONTRACT No.: CUST No: Contractor- BHEL							
		Manufacturer Name and Address				ITEM: AGITATOR									
						QP NO: ,REV:0 DT:									
						Page 2 of 2									
SL. NO.	COMPONENT OPERATION	&	CHARATERISTICS	CLASS	TYPE OF CHECK	QUATUM OF CHECK		REFERENCE DOCUMENT	ACCEPTANCE NORMS	FORMAT OF RECORD		AGENCY			REMARKS
						M	C/N			9	D*	M	C	N	
1	2	&	3	4	5	6	C/N	7	8	9	D*	10	11	11	

4.2	Free Air Run Test of complete assembly		Measurement Current, RPM, Noise & Vibration	MA	Measurement	100%	10%	Vendor Standard / Approved Drawing / Data Sheet	IR	√	P	W	W	
4.3	Review of QA Documents		Verification of QA Documents	MA	Verification	100%	100%	As per Appd.MQP	IR		P	V	V	
5.0	Painting & Preservation													
5.1			Painting material	MI	Review of MTC	100%		Appd. "Painting Procedure" / Approved Painting Schedule	IR	√	P	V	-	
5.2			Surface treatment and inspection	MI	Visual	100%	-	-do-	IR	√	P	-	-	
5.3			DFT Check	MI	Measurement	10%		-do-	IR	√	P	V	-	
5.4			Painting Surface Quality	MI	Visual	100%		-do-	IR	√	P	V	-	
6.0	Inspection before Delivery													
6.1	Packing		Size, appearance & firmness	MI	Measurement & Visual	100%		As per "Packing Procedure"	IR	√	P	V	-	
6.2	Deliver Documents		Markings, Packing List & Detail Packing List, etc. Check	MI	Verification	100%		As per "Packing Procedure"	IR	√	P	V	-	

NOTES:

1. For Agitator Motor rating is 45KW and motor make NTPC/BHEL Approved source.
2. Routine test report duly witnessed by main contractor as per applicable standard shall be reviewed during inspection (more than 30KW Rating).

**The above mentioned QP is for reference purpose only and is not exhaustive. Engineering Technical specification is the base document for QP. All relevant points of Technical Specification shall be addressed in the Final MQP. The MQP approval will be given only post-contract stage and is subject to the addition of inspection stages or quantum by the customer and shall be performed by the Supplier without any cost/delivery implication **

MANUFACTURER	Prepared by	LEGEND: * RECORDS, IDENTIFIED WITH "TICK" (√) UNDER COLUMN 'D' SHALL BE SUBMITTED TO CUSTOMER AS A QA DOCUMENTATION PACKAGE. M: MANUFACTURE/SUB SUPPLIER, C MAIN CONTRACTOR/ N: NTPC/ P: PERFORM W: WITNESS AND V: REVIEW OF RECORDS				
	Approved by					
SIGNATURE			FOR CUSTOMER USE	REVIEWED BY	APPROVED BY	APPROVAL SEAL

Annexure-IX

CONTRACT QUALITY REQUIREMENTS (CQR) for LT MOTORS(IE3) up to 200KW used in ABSORBER AGITATOR

1. Motor make:

Motor make should satisfy one of the below 3 conditions.

- a) NTPC (end customer) approved makes
 - i. KEC / Bengaluru (Up to 200KW) & Hubli (Up to 90KW)
 - ii. CGL/Ahmednagar (Up to 200KW)
 - iii. SIEMENS/Mumbai (Up to 200KW)
 - iv. ABB/Faridabad (Up to 55KW) and Bengaluru (Up to 200KW)
 - v. BBL/Mumbai (Up to 200KW)
 - vi. NGEF/ Bengaluru (Up to 15KW)
 - vii. Marathon / Kolkata (Up to 200KW)
 - viii. Jyoti / Vadodara (Up to 200KW)
 - ix. Laxmi Hydraulics Private Limited (LHPL) / Solapur (Up to 200KW)
- b) Motor make with past experience of supplying to BHEL – Necessary documents shall be furnished by the agitator vendor for past experience with BHEL for the supply of motor of similar type and rating (ratings in clause 4),
- c) Motor make that is not in the above two categories - The necessary documents to validate the manufacturing and testing facilities of the motor make shall be submitted by agitator vendor for BHEL/NTPC's review. If required, further assessment of manufacturing and testing facilities of motor make will be done by BHEL/NTPC for approval, before placement of purchase order. This process shall be facilitated by the agitator vendor for motor make approval by BHEL/NTPC.

2. Quality Plan:

- a) LT motor manufacturer with valid NTPC approved Quality Plan – Agitator Vendor shall submit the filled up Endorsement sheet (format attached) along with NTPC approved Quality Plan in the event of Purchase Order from BHEL and the same shall be subject to approval of BHEL/NTPC.
- b) LT Motor Manufacture without valid NTPC approved Quality Plan – Agitator Vendor shall submit a Quality Plan (format attached) for BHEL/NTPC approval. An indicative list of tests/checks to be included in the Quality plan is given in Annexure-1.

3. Type tests:

The type test requirements are given in the Technical Specification of LT AC Motors (Safe Area), Specification Reference - TCI :140, Rev. 13.

4. Inspection Categorization:

- a) Motor rating 75 kW to 200 kW - Categorization II
- b) Motor rating 50kW to 75 kW – Categorization III
- c) Motor rating up to 50 kW – Categorization III

Annexure-IX

Inspection categorization II: Physical inspection will be by BHEL.

Inspection categorization III: No physical inspection by BHEL.

Categorization may change from II to III, subject to NTPC approval.

Vendor has to issue COC (Certificate of Conformance) confirming as follows for review:

It is hereby confirmed that the above motor/motors was/were manufactured taking care of Customer specific requirements regarding ambient temp., voltage & frequency variation, hot starts, pull out torque, starting KVA/KW, temp. rise, distance between centre of stud & gland plate, space heater and tested in accordance with approved drawing/data sheets.

The final acceptance by BHEL/NTPC on the basis of review of documents as per approved Quality Plan.

Annexure-IX

OEM SUPPLIER WITH OEM MFGR.'s LOGO (TO BE FILLED BY OEM SUPPLIER)	LT MOTOR MANUFACTURER'S NAME AND ADDRESS (TO BE FILLED BY OEM / LT MOTOR MANUFACTURE)	MANUFACTURING QUALITY PLAN				PROJECT: PACKAGE: FGD PACKAGE NTPC CONTRACT NO: MAIN CONTRACTOR: BHEL - TIRUCHIRAPPALLI SUB CONTRACTOR (OEM) & ADDRESS: (TO BE FILLED BY OEM SUPPLIER)				
		ITEM: LT MOTOR(IE3) UP TO 200KW FOR FGD APPLICATION SUB-SYSTEM: FGD - SLURRY PUMP SYSTEM	QP NO.:SLURRY PUMP :LT MOTOR:001 REV.NO.: 00 DATE: PAGE: OF....							

SL. NO	COMPONENT & OPERATIONS	CHARACTERISTICS	CLASS	TYPE OF CHECK	QUANTUM OF CHECK		REFERENCE DOCUMENT	ACCEPTANCE NORMS	FORMAT OF RECORD		AGENCY			REMARKS
					M	C/N				D*	M	C	N	
1.	2.	3.	4.	5.	6.		7.	8.	9.	D*	** 10.			11.

		LEGEND: * RECORDS, IDENTIFIED WITH "TICK" (✓) SHALL BE ESSENTIALLY INCLUDED BY SUPPLIER IN QA DOCUMENTATION. ** M: OEM MANUFACTURER/LT MOTOR SUB-SUPPLIER C: MAIN SUPPLIER – BHEL/BHEL AIA , N: NTPC P: PERFORM W: WITNESS AND V: VERIFICATION. AS APPROPRIATE, CHP: NTPC SHALL IDENTIFIED IN COLUM "N" AS ' W"		FOR NTPC USE	DOC. NO.: REVIEWED BY	REV..... CAT..... APPROVED BY	APPROVAL SEAL
OEM MANUFACTURER/ LT MOTOR SUPPLIER	MAIN (BHEL) SUPPLIER						
SIGNATURE							

FORMAT NO.: QS-01-QAI-P-09/F1-R1

ENGG. DIV./QA&I



Annexure-IX

ENDORSEMENT SHEET FOR QP REFERENCE / STANDARD / FIELD QUALITY PLAN (RQP / SQP/RFQP/SFQP)

TO BE FILLED IN BY SUPPLIER AT TIME OF SUBMISSION			To be filled in by NTPC
PROJECT NAME		2REVIEW & ENDORSEMENT BY NTPC PROJECT SPECIFIC QP NUMBER ALLOTTED QP NO: REV. NO.: 00 DT :	
CONTRACT NO.:	CS-----		
MAIN SUPPLIER	M/S.BHEL, TIRUCHIRAPPALLI , TAMIL NADU., INDIA		
MANUFACTURER WORKS & ADDRESS	(TO BE FILLED BY OEM / LT MOTOR SUPPLIER)		
ITEM /EQUIPMENT / SYSTEM/ SUB-SYSTEM DETAILS i.e. MODEL TYPE/SIZE/RATING etc.	LT MOTOR(IE3) - ABSORBER AGITATOR SYSTEM FOR FGD APPLICATION		
APPROVED QP NO.: RQP/SQP/RFQP/SFQP	(TO BE FILLED BY OEM / LT MOTOR SUPPLIER)		
Confirmation by Main Supplier (TICK WHICHEVER APPLICABLE)		<i>(TICK APPLICABLE)</i>	
I. That the item/ component is identical to that considered for SQP approval. ✓		The MQP/RQP/SQP is endorsed for this project without any change	
II. That there are minor changes in the item/ component with respect to that considered for MQP/RQP/SQP approval, however the same do not affect the contents of MQP/RQP/SQP			
III. That there are minor changes in the item/ component with respect to that considered for MQP/RQP/SQP approval, however the same affect the MQP/RQP/SQP slightly, as indicated below / in attached sheet.		The SQP is endorsed for this project with changes as indicated.	
		<u>DISTRIBUTION OF ENDORSEMENT OF</u> A) MQP/RQP/SQP: 1. MAIN SUPPLIER (WITH A COPY OF MQP/RQP/SQP) 2. MANUFACTURER 3. RIO 4. CQA-SPL 5. CQA-O/C B) RFQP/SFQP: 1. MAIN SUPPLIER (with a copy of MQP/RQP/SQP) 2. MANUFACTURER 3. NTPC FQA (with a copy of MQP/RQP/SQP) 4. NTPC Erection (with a copy of MQP/RQP/SQP) 5. CQA-SPL 6. CQA-O/C	
(TO BE FILLED BY OEM / LT MOTOR SUPPLIER)			
SIGN.: (Main Supplier)	DATE:	SIGN.: (Manufacturer)	DATE:
		NTPC (Reviewed /Approved by/ Date & Seal)	

Annexure-IX



CLAUSE NO.

QUALITY ASSURANCE

Wound stator	Y	Y						Y	Y										
Wound Exciter	Y	Y						Y	Y										
Rotor complete	Y	Y						Y					Y	Y					
Exciter, Stator, Rotor, Terminal Box assembly	Y	Y						Y											
Accessories, RTD, BTD, CT, Space heater, antifriction bearing, gaskets etc.	Y	Y	Y																
Complete Motor	Y	Y	Y												Y	Y	Y	Y1	Y

Note: 1. This is an indicative list of tests/checks. The manufacture is to furnish a detailed Quality Plan indicating the practices & Procedure followed along with relevant supporting documents during QP finalization [REDACTED]

2. Additional routine tests for Flame proof motors shall be applicable as per relevant standard

3. Makes of major bought out items for HT motors will be subject to NTPC approval.

4. Y1 = for HT Motor / Machines only.

2415

Annexure-X

	<p>QUALIFYING REQUIREMENTS FOR AGITATORS</p> <p>NTPC PROJECTS</p>
<p>AGITATORS:QR-3K</p>	

ANNEXURE- 3K: QUALIFYING REQUIREMENTS FOR AGITATORS

The following terminology shall be followed for 3K Document:

- a) Bidder means BHEL
- b) Bidder's sub-vendor means Agitator Manufacturer.
- c) Employer or owner means NTPC

Agitator Vendor shall meet the below qualification requirement of NTPC.

NTPC CLAUSE NO	DESCRIPTION			
4.01.00	The Bidder / Bidder's sub-vendor(s) is required to meet the Provenness criteria and/or qualification requirement for critical equipment's, auxiliaries, systems and bought out items as per criteria stipulated below			
4.01.01	Agitators for the Wet Limestone based Flue Gas Desulphurisation (FGD) System offered by the Bidder shall be only from such manufacturer(s) who has previously designed (either by itself or under collaboration / licensing agreement), manufactured / got manufactured the respective equipment(s) of the type, application and minimum equipment rating as stipulated below such that the respective equipment(s) should have been in successful operation in at least one (1) plant for a period not less than one(1) year.			
Type and Rating for Qualification				
	Name of Equipment	Type of Equipment	Application	Equipment Rating
4.01.01(f)	Agitators	Vertical/ Horizontal	Wet Limestone based FGD application in Coal fired power plant	Agitator rating not less than that supplied for 500 MW or higher size unit for similar application
4.01.03	A JV / Subsidiary Company formed for manufacturing and supply of equipment(s) as listed at clause no. 4.01.01 above in India, shall also be considered qualified for manufacturing such equipment(s), provided that it has a valid collaboration or licensing agreement for design, engineering, manufacturing of such equipment(s) in India with a qualified equipment manufacturer who meets the requirements stipulated at clause 4.01.01 above (or the technology provider of the qualified equipment manufacturer) for the respective equipment(s). Before taking up the manufacturing of such equipment(s), the bidder/ his sub-vendor(s) must create /have created manufacturing facilities at his works as per collaborator's/licenser's design, manufacturing and quality control system for such equipment(s). Further, in such a case, such qualified equipment manufacturers should have, directly or indirectly through its holding company/ subsidiary company, at least 26% equity participation in the Indian Joint			

Annexure-X



QUALIFYING REQUIREMENTS FOR AGITATORS

NTPC PROJECTS

AGITATORS:QR-3K

	Venture Company/ Subsidiary Company, which shall be maintained for a lock-in period of seven (7) years from the date of incorporation of such Joint Venture/ Subsidiary or upto the end of defect liability period of the contract, whichever is later.
4.01.06	In case the Bidder or the proposed sub-vendor is not manufacturer of proven Agitators as per clause 4.01.01(f) above but is a manufacturer of Agitators for similar process/duty application in petrochemical or metals and mining industry, the Bidder or the proposed sub-vendor shall also be considered qualified for manufacturing Agitators, provided it has collaboration or valid licensing agreement for design, engineering, manufacturing, supply of such Agitators in India with such manufacturer who meets the requirements stipulated at clause 4.01.01(f) above for the Agitators. Before taking up the manufacturing of such equipment, the bidder/ his sub-vendor must create /have created manufacturing facilities at his works as per collaborator's /licenser's design, manufacturing and quality control system for such equipments
04.01.08	Before taking up the manufacturing of such equipment(s) as per clause 4.01.03, 4.01.06 above, the Bidder / its sub vendor(s) must create (or should have created) manufacturing and testing facilities at its works as per Collaborator / licenser's design, manufacturing and quality control system for such equipments duly certified by the Collaborator / licensor. Further, the Collaborator / Licenser shall provide (or should have provided) all design, design calculation, manufacturing drawings and must provide (or should have provided) technical and quality surveillance assistance and supervision during manufacturing, erection, testing, commissioning of equipments.
04.01.09	Bidder shall offer and supply only the type of the above equipment(s) for which it, itself or the manufacturer / Collaborator(s) / Licenser(s) proposed by the Bidder for the above equipment(s) is qualified.
04.01.10	The Employer reserves the right to fully satisfy himself regarding capability and capacity of Bidder / its sub-vendor(s) and the proposed arrangement and may prescribe additional requirement before allowing manufacture of the equipment listed above for this contract.
	Note to clause 4.01.01: Whenever the term 'coal fired' is appearing above, "Coal" shall be deemed to also include bituminous coal/brown coal/Anthracite Coal/lignite.

**FLUE GAS DESULPHURISATION (FGD) SYSTEM PACKAGE
FOR
LOT-3 PROJECTS
BIDDING DOCUMENT NO. CS-0011-109(3)-9**

Bidder's Name and Address:
Bharat Heavy Electricals Limited,
BHEL House, Siri Fort,
New Delhi - 110049

To
Contract Services-III
NTPC Limited
Noida-201301

Summary of Critical Equipment indicated under clause 4.01.00, sub-section-I, Part-A of Section-VI.

Equipment Name	Sub-Vendor Name	Collaborator's Name, if applicable	Seeking Qualification as per clause Sub-Section-I, Part-A of Section-VI
Booster Fans	BHEL		*1.2 /*1.3 /*1.4
*Slurry Recirculation Pumps			*4.01.01 /*4.01.03 /*4.01.07
Oxidation Blowers			*4.01.01 /*4.01.03 /*4.01.04
Wet limestone Grinding mills			*4.01.01 /*4.01.03 /*4.01.05 (i)/ 4.01.05 (ii)
Slurry Pumps			*4.01.01/*4.01.03
Agitators			*4.01.01 /*4.01.03 /*4.01.06
Vacuum Belt filters			*4.01.01 /*4.01.03

Note : *Strike-off whichever is not applicable.

Signature of authorized signatory.....

3567

3568

1. If qualification sought as per clause 4.01.01, sub-section-I-A, Part-A of Section-VI then the details of the sub vendor (manufacturer) shall be filled by the bidder in the format A to G. (Format "F" Only applicable for this enquiry).
2. If the qualification sought as per the clause 4.01.02, sub-section-I-A, Part-A of Section-VI, then the details of proposed sub vendor (i.e manufacturer of such equipment for at least *195/*250/*500/**660 MW unit rating) shall be filled individually by the bidder in the format A and the details of collaborator who meets the requirement stipulated at 4.01.01, sub-section-I-A, Part-A of Section-VI shall also be filled by the bidder in the format A separately. Further, in case of qualification vide clause 4.01.02, sub-section-I-A, Part-A of Section-VI a copy of valid ongoing collaboration and technology transfer agreement for design, engineering, manufacturing, supply of such equipment in India with the collaborator who meets the requirement stipulated at 4.01.01, sub-section-I-A, Part-A of Section-VI shall also be furnished.
3. If the qualification sought as per the clause 4.01.03, sub-section-I-A, Part-A of Section-VI then the details of JV/Subsidiary Company formed for manufacturing of such equipment in India shall be furnished individually for each equipment by the bidder such as,
 - i) Copy of document of incorporation of JV/Subsidiary company in India
 - ii) Copy of valid ongoing collaboration and technology transfer agreement for design, engineering, manufacturing, supply of such equipment in India with the collaborator who meets the requirement stipulated at 4.01.01, sub-section-I-A, Part-A of Section-VI.
 - iii) Copy of document of at least 26% equity participation of qualified equipment manufacturer in the Indian JV company/subsidiary company directly or indirectly through its holding company /Subsidiary company, which shall be maintained for a lock -in period of seven (7) years from the date of incorporation of such JV/subsidiary or up to the end of defect liability period of the contract which ever is later.

Further, the details of collaborator or technology provider of the qualified equipment manufacturer who meets the requirement stipulated at 4.01.01, sub-section-I-A, Part-A of Section-VI shall be filled by the Bidder in the format A to G (format given at 1.00.00). In addition to that, the sub vendor along with the Indian JV company/subsidiary company, qualified equipment manufacturer and its holding company/subsidiary company as applicable shall furnish the Letter of Support as per the format enclosed at Annexure-I.

*** strike out whichever is not applicable.**

- 1.00.00 (Applicable for Bidder/his sub vendors seeking qualification as per clause no. 4.01.01, Sub section-I, Part-A of Section-VI. Bidder shall furnish the required data only for those equipments / auxiliaries which are proposed to be sourced under this route.)

Signature of authorized signatory

We, hereby furnish the data on proveness criteria for critical equipment, auxiliaries, systems and Bought Out Items such as Booster Fans, *Slurry Recirculation Pumps, Oxidation Blowers, Wet Limestone Grinding Mills, Slurry Pumps, & Agitators which have been designed (either by self manufacturer or under valid ongoing collaboration and technology transfer agreement), *manufactured/ *got manufactured and supplied by us /Manufacturer (or manufactured/ got manufactured & supplied by our proposed sub-vendors) and these are in successful operation in at least one (1) plant for a period not less than one year reckoned as on the date of consideration for approval but not later than six months to award date of contract to the Main bidder. The details of type and minimum equipment rating of such equipment are given below :

3569

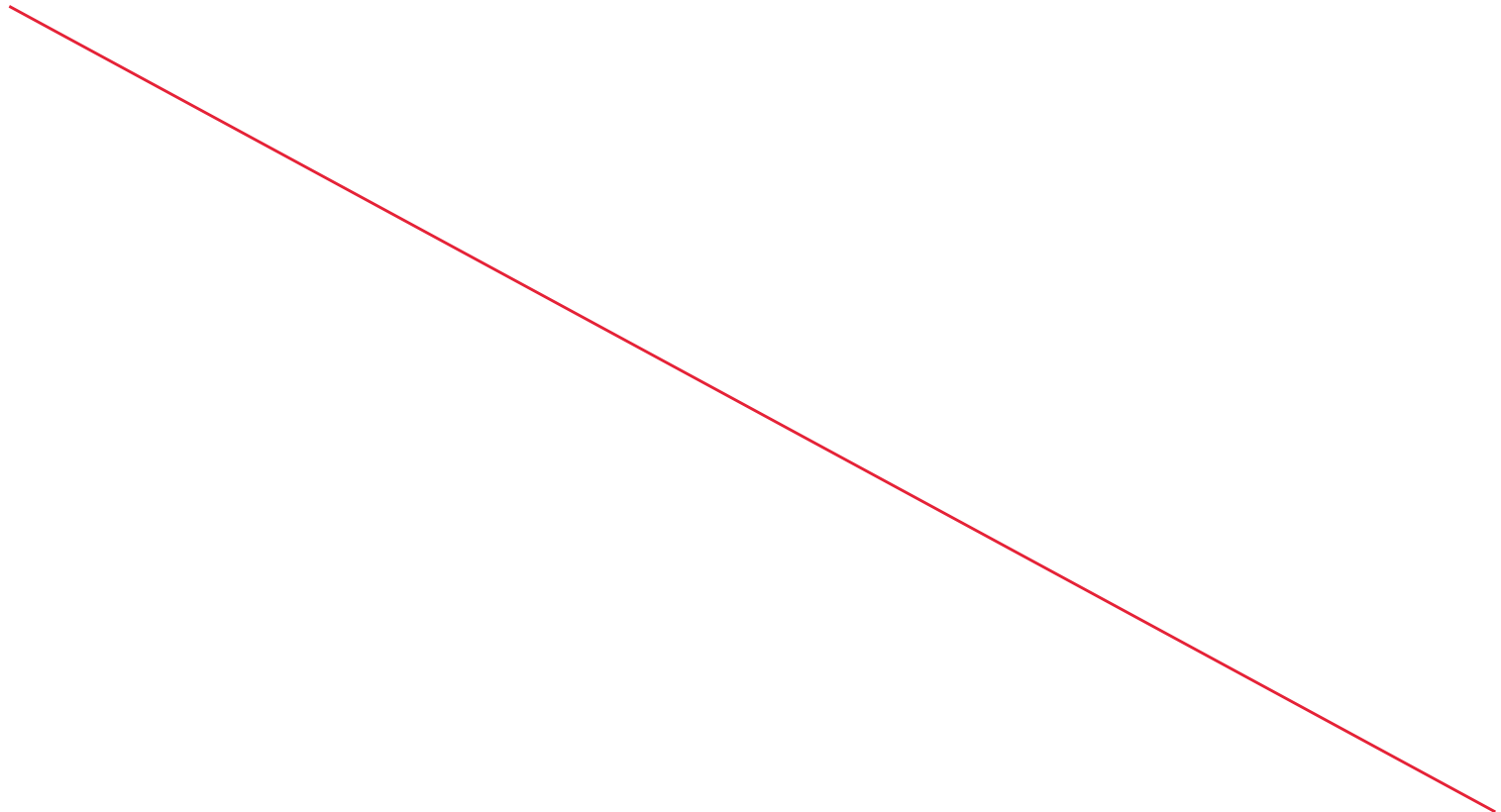

Annexure-X

F. Agitators: We declare that, we/our Sub-Vendor, have designed (either by itself or under collaboration / licensing agreement),*manufactured/*got manufactured and supplied at least one (1) number of Agitators with rating not less than that supplied for 500 MW or higher size unit for similar application, Vertical/Horizontal type working in Wet Limestone based FGD application in Coal fired power plant and which has been in successful operation for minimum one(1) year reckoned as on the date of consideration for approval but not later than six months to award date of contract to the Main bidder, as per the details furnished below::

Sl. No.	Description	Reference Work
1.	Name of the reference plant & location:	
2.	Client name and his address:	
3.	No. of units and capacity in MW of unit:	
4.	Whether power plant is coal fired	-*Yes/*No
5.	Whether operating in a Wet Limestone based FGD application in coal fired power plant	-*Yes/*No
6.	Name of equipment manufacturer & address:	
7.	Date of commission of the equipments:	
8.	Model no. of the equipment:	
9.	Brief Technical particulars of the equipments:	
10.	Agitators supplied forMW unit size

3581

Signature of authorized signatory

Annexure-X

3582

Sl. No.	Description	Reference Work
11.	Whether the equipment(s) are in successful operation in atleast one(01) plant for a period not less than one(01) year reckoned as on the date of consideration for approval but not later than six months to award date of contract to the Main bidder	
12.	Flue gas Desulphurization system details:	*Drawing from user or *contract document or *scheme or *any document in public domain enclosed at annexure ... to Attachment-3K
13.	Scope of Work:	*Letter of Award or *Contract or *P.O. enclosed at Annexure to Attachment-3K
14.	Performance details:	*Certificate/*Letter/*E-mail from End user enclosed at Annexure to Attachment-3K

* Strike off whichever is not applicable.

Signature of authorized signatory

*2.00.00 Applicable for Bidder/his sub vendors seeking provenness criteria as per clause no. 4.01.02, Sub-section-I, Part-A of Section-VI.

2.01.00 We, hereby confirm that we/our sub-vendors are a regular manufacturer of Booster Fan for up to 1000000/500/660 MW rating and the details in this regard on provenness criteria as per clause 4.01, sub-section-I, Part-A, Section-VI are hereby furnished below:

*Bidder to strike off whichever is not applicable.

(Data to be furnished in line with format given at 1.00.00 of this Attachment)

2.02.00 We further confirm that details in respect of collaboration/ joint venture agreement for the aforesaid equipment as per 2.01.00 above who meets the requirement stipulated at clause 4.01, sub-section-I, Part-A, Section-VI are enclosed at Annexure..... to this Attachment. The data in respect of provenness criteria for these equipment which are in successful operation in at least one (1) plant for a period not less than 6 months, reckoned as on the date of consideration for approval but not later than six months to award date of contract to be submitted by bidder are furnished below. We further confirm that we/ our sub vendor(s) have created manufacturing/ testing facilities at our/ their works as per collaborator's/ Licensor's design, manufacturing & quality control system for these equipment(s)/ Auxiliary(ies).

(Data to be furnished in line with format given at 1.00.00 of this Attachment)

LATER, IF APPLICABLE

Signature of authorized signatory.....

***3.00.00** Applicable for JV Company/Subsidiary Company meeting provenness criteria as per clause no. 4.01 Sub section-IA, Part-A of Section-VI.

3.01.00 We, hereby confirm that JV company/ Subsidiary company (Strike off whichever is not applicable) formed for manufacturing and supply of equipment(s) (*Booster Fans, *Slurry Recirculation Pumps, *Oxidation Blowers, *Wet Limestone Grinding Mills, *Slurry Pumps, *Agitators, *Vacuum Belt Filters) has a valid ongoing collaboration and technology transfer agreement for design, engineering, manufacturing of such equipment(s) in India with a qualified equipment manufacturer who meets the requirements stipulated at clause 4.01.01 of sub-section-I, Part-A, Section VI of bidding documents (or a technology provider of the qualified equipment manufacturer). Further, in such a case, such qualified equipment manufacturer is having, directly or indirectly through its holding company/subsidiary company, at least 2% equity participation in the Indian Joint Venture Company/subsidiary company, which shall be maintained for a minimum period of (rev) years from the date of incorporation of such Joint Venture / Subsidiary or up to the end of defect liability period of the contract, whichever is later. Before taking up the manufacturing of such equipment(s) (*Booster Fans, *Slurry Recirculation Pumps, *Oxidation Blowers, *Wet Limestone Grinding Mills, *Slurry Pumps,*Agitators, *Vacuum Belt Filters) we, as a subcontractor(s) *will create /*have created manufacturing facilities at his works as per collaborator's/licenser's design, manufacturing and quality control system.

We further confirm that details in respect of collaboration and licencing agreement for the aforesaid equipment(s) (*Booster Fans, *Slurry Recirculation Pumps, *Oxidation Blowers, *Wet Limestone Grinding Mills, *Slurry Pumps, *Agitators, *Vacuum Belt Filters) who meets the requirement stipulated at clause 4.01.01, sub-section-I, Part-A, Section-VI for are enclosed at Annexure..... to this Agreement.

LATER, IF APPLICABLE

Signature of authorized signatory.....

*7.00.00 Applicable for Bidder/his sub vendors seeking provenness criteria as per clause no. 4.01.06, Sub-section-I, Part-A of Section-VI.

7.01.00 We, hereby confirm that *we/*our sub-vendors is a manufacturer of a manufacturer of Agitator similar process duty application in petrochemical or metals and mining industry. (Details of references enclosed as per clause no.)

(Data to be furnished in line with format given at 1.00.00 of this Attachment)

7.02.00 We further confirm that details in respect of collaboration / valid licensing agreement for the Agitator between *us/*our sub-vendors, as per 6.01.00 above, and with qualified Agitator manufacturer, which fulfills the requirement stipulated at clause 4.01.01, sub-section-I, Part-A, Section-VI are enclosed as per clause no. to this Attachment. The data in respect of provenness criteria for the qualified Agitator manufacturer, which is necessary to be supplied at least one (1) plant for a period not less than one reckoned as on the date of consideration for approval but not later than six months to award date of contract to the Main bidder are furnished below.

We further confirm that before taking up manufacturing of such Agitator, *we/ *our sub vendor(s) *will create /*have created manufacturing facilities at his works as per Manufacturer's/licenser's design, manufacturing and quality control system.

(Data to be furnished in line with format given at 1.00.00 of this Attachment)

LATER, IF APPLICABLE

Signature of authorized signatory.....

3650