

Bharat Heavy Electricals Limited
High Pressure Boiler Plant
Tiruchirappalli – 620 014. India
Civil Engineering Department (Factory)

TENDER DOCUMENT (QUALIFICATION BID)

Name of work : **Supplying & fixing of Aluminium zinc alloy coated high tensile steel sheets for roofing and side sheeting to replace existing AC sheets in Factory Buildings of HPBP, SSTP and allied areas in BHEL, Trichy Complex.**

Value of work : **Rs.200/- Lakh**

Tender Notice No. : **02/11-12**

Tender Schedule No. : **11/11-12**

Period of Contract : **12 (Twelve) Months**

Issued to M/s / S/Shri :

**BHARAT HEAVY ELECTRICALS LIMITED
TIRUCHIRAPPALLI – 620 014**

CIVIL ENGINEERING DEPARTMENT (FACTORY)

BHE: SM: C: F:P:02/67:

Dt.

To

The Tenderer

Dear Sirs,

Sub: Supplying & fixing of Aluminium zinc alloy coated high tensile steel sheets for roofing and side sheeting to replace existing AC sheets in Factory Buildings of HPBP, SSTP and allied areas in BHEL, Trichy Complex.– reg.

Ref: 1. Tender Notice No. 02 /11-12
2. Tender Schedule No.11/11-12

Please find enclosed / attached non-transferable tender document containing I) Qualification bid consisting of Preamble, Specifications, General Conditions of Contract, Norms for Qualification and Qualification Performa ii) Price bid consisting of Bill of Quantities to offer your most competitive rates for all the items of Bill of Quantities attached in the Price Bid.

Tender for the work should be submitted in a sealed cover consisting of three inner sealed covers such as I) EMD cover ii) Qualification bid cover & iii) Price bid cover, all super scribing the name of work, tender schedule number etc.

- 1) **EMD cover shall contain requisite EMD in the form of DD.** Tenderers who had already remitted one time EMD should furnish the details of cash receipt No._____ dt. _____, on the top of EMD cover. Tender without EMD / one time EMD reference will be summarily rejected and the qualification bid & price bid shall not be considered.

In case of tender documents downloaded from website, tender shall accompany the tender cost of Rs.750/- in the form of Demand Draft (separate) in addition to the EMD amount in the form of Demand Draft.

All Demand Draft shall be drawn in favour of **BHEL, Trichy** payable at Tiruchirappalli.

- 2) Qualification bid cover shall contain duly filled in qualification bid document signed by the tenderer in all the pages with documentary evidences for pre-qualification such as experience, value of work executed in the similar nature of work, etc. Any bid without proper documentary evidence for pre-qualification shall not be considered for further evaluation.

CONTRACTOR

2

ACCEPTING OFFICER

- 3) The Price Bid cover shall contain price bid document duly filled in and signed by the tenderer in all the pages. **The tenderer has to quote most competitive rates for all the items in the Bill of Quantities from page No. 3 to 6 of Price Bid.**

The completed qualification bid and price bid along with requisite EMD of **Rs.2,00,000/-** for the work in the form of Demand Draft in favour of BHEL, Trichy shall reach the office of the undersigned on or before **28.10.11 at 14.55 hrs.** Tenderers who had already remitted one time EMD should furnish the details of cash receipt No. _____ dt. _____, on the top of EMD cover. EMD in any other form will not be accepted. The qualification bid will be opened on the **same day at 15.00 hrs.** In case of opening day falls on holiday or happened to be declared as a holiday, the receipt and opening of the tender shall automatically fall on the same timing of the next working day. Date and time of opening of the Price Bid shall be intimated only to the bidders those who have qualified after evaluation of the qualification bid. You / your authorized representative may participate in the tender opening.

Clarification if any, can be obtained contacting following phone No. 0431 – 2574658 / 2574650. Fax No. : 0431 – 2520333.

Kindly acknowledge the receipt of the entire set of tender document.

Thanking you,

Yours faithfully
For and on behalf of
BHARAT HEAVY ELECTRICALS LIMITED,

SR.MANAGER/ CIVIL / FACTORY (PLANNING)
BUILDING No. 53.

BHARAT HEAVY ELECTRICALS LIMITED
TIRUCHIRAPPALLI – 620 014

CIVIL ENGINEERING DEPARTMENT (FACTORY)

PREAMBLE

01. The scope of work includes **Supplying & fixing of Aluminium zinc alloy coated high tensile steel sheets for roofing and side sheeting by replacing existing AC sheets in Factory Buildings of HPBP, SSTP and allied areas in BHEL, Trichy Complex** . The estimated value of Work is **Rs.200 LAKH** cost of materials which will be supplied by BHEL at free of cost as per Schedule 'B' of Price Bid..
02. The Aluminium zinc alloy coated high tensile steel sheets and specials shall be 0.47 to 0.50mm thick (TCT) Aluminium (around 55%, Zinc around 43%) alloy coated high tensile sheets (Yield strength 550 MPA) colour coated rib profile sheets as per ASTM A792M, coating standard as per AS 1397-1933 having cover width of 1000 plus or minus 10mm and over all width of 1060mm of any length to suit site conditions.
03. About 90% area of the Aluminium zinc alloy coated high tensile steel sheets and specials shall be colour coated with Light Blue RAI 5012 and 10% of the covered area is of with off white.
04. BHEL Engineer will visit the tenderer's manufacturing facility for Pre Delivery Inspection. All necessary test certificates shall be produced.
05. Time is the essence of the contract. Being a time bound work in nature, the contractor should make all efforts to complete the work in the stipulated period of **TWELVE (12) MONTHS**.
06. Usually, working hours are limited to day time only. In emergency cases to carryout works during nights, it may be done so with the specific prior permission of BHEL. In such case, it is to be carried out in the presence of BHEL officials or their authorized persons.
07. The tenderers are advised to visit BHEL Factory at Tiruchrappalli and get themselves acquainted with the site conditions before submitting the offer.
08. The following eligibility criteria shall be complied to fulfill the Qualification Bid:-
 1. **Separate Registration for EPF, ESI,PAN, Sales tax,& Service tax, Proof of IT returns submitted for the last three years 2007-08 to 2009-10), Profit & Loss account and balance sheet certified by the auditor.**
 2. **Average annual turnover in the last 3 financial years shall be at least for a value of minimum of Rs..60.00 Lakhs.**
 3. **During last seven financial years should have successfully completed works either**
 - a) **Three similar works each not less than Rs. 80.00 Lakhs (or)**
 - b) **Two similar works each not less than Rs. 100.00 Lakhs (or)**
 - c) **One similar work not less than Rs.160 Lakhs**
 4. **Solvency certificate shall be minimum for Rs. 80.00 Lakhs (The Certificate should have been issued within 6 months from the date of tender opening.)**

9. The norms for qualification with prescribed score is attached in the Qualification Bid Document. Evaluation will be done accordingly. Minimum score required for qualification is 60.
10. The works executed in the own name of the tenderer only will be considered for eligibility criteria.
11. Dissimilar / irrelevant works will not be considered for eligibility criteria.
12. Documentary evidences (Xerox copies - attested) for turnover, works experience, P.F, ESI registration etc., all as indicated & required in the tender document should be furnished without which it will not be taken into account.
13. The tender value of **Rs.200 Lakh** includes cost of Aluminium zinc alloy coated high tensile steel sheets, poly carbonate sheets etc., except for item No. 3 & 5 free issue materials supplied by BHEL are indicated in Schedule B of the Price bid document.
14. Tender Value is only approximate and liable for variation without entitling the tenderer to any compensation, till the total value of contract vary by more than 20% (twenty percentage).
15. Quoted rate shall be from throughout the contract period of **12 months** and extended contract period also and no cost escalation is allowed on any account.
16. **The work shall be carried out as per drawings released from time to time, Civil Engineering Department Work & Safety procedure, specifications, standard code of practice and as per the instructions of Engineer-in-charge. Tenderer has to quote rates both in figures and in words for all the items given in the Bill of Quantities provided in the Price Bid. (From page No. 3 to 6).**
17. The item rates offered are for finished item of works as per Bill of Quantities and shall provide for the complete cost towards fuel, tools, tackles, plant & machinery, temporary works, labour, materials, levies, taxes, transport, lay-out, repairs, rectifications, maintenance till handing over, supervision, labour colonies, establishment, services, roads, revenue expenses, overheads, profits & all other incidentals etc., complete. **However if the service tax is applicable for this contract, the same will be reimbursed on production of valid document / proof for having paid service tax by the tenderer.**
18. For any item of work not covered in Bill of Quantities, the rate will be worked out based on the conditions given in BHEL General Conditions of Contract.
19. After award of work the contractor has to furnish the security deposit, as per Clause 13 of Tender Notice, attached in the Price Bid. Also it is to be noted that subsequent to award of work the contractor has to furnish 50 % of security deposit before the commencement of work.
20. The contractor should bring necessary machineries like drilling machine, cutter, hammer etc., as and when required for the work without any delay. Also required number of the tools & Plants / instruments shall be made available always at site for the works.
21. The contractor has to deploy sufficient number of lorries to collect & transport the construction materials debris generated, etc. at site. Otherwise BHEL would clear the debris at the contractor's risk and cost.
22. The quantity indicated in the Bill of Quantity is only tentative. The contractor has to execute any item of work irrespective of the quantity without any reservation till the total value of contract exceeds by 20%.

23. The contractor has to carryout the work in production shops after obtaining proper shut down and without affecting the production by planning such work on holidays .
24. The decision of Engineer-in-charge shall be final and binding on the contractor regarding clarification of items in this tender schedule.
25. The contractor shall strictly adhere to various labour laws in force.
26. The contractor shall follow norms of BHEL security system for movement of men & materials within the complex including biometric movement system.
27. Since the responsibility for the quality, workmanship and accuracy of any work being carried out under this contract lies with the contractor, the contractor should ensure that no work is done without the presence of contractor's representative at the work spot.
28. The contractor has to submit the organization chart of their set up for the works and any change thereafter in the organization set up shall have the prior approval of BHEL.
29. Statement of completed works with detailed measurements along with material reconciliation statements shall be submitted by the contractor in the last week of every month for processing bill.
30. The contractor should establish his own site office, labour colony, handling facility, storage facility etc., for which vacant land will be allotted on specific request for which the rent will not be collected.
31. The contractor is required to carry out construction activities as directed by the department officials. It is required to engage certain minimum strength of staff for effective supervision of works as indicated below:

Site in-charge / Construction Manager	-	1 No.
Planning Engineer and co-ordinator	-	1 No.
Supervisor (Diploma Holder)	-	2 Nos.
32. An Engineer to look after Quality and one Safety Engineer should be deployed at site to look after safe working.
33. The tenderer has to deploy a adequate skilled labour of required categories so as to execute the works simultaneously in all areas of work..
34. Separate non-technical persons should be engaged for arranging daily gate passes for labours and vehicles entry in all the gates of Factory Complex.
35. The tenderer shall carry out health performance test at his cost for all the workmen engaged in the work through a registered medical practitioner and produce certificate on demand.
36. It shall be the responsibility of the contractor to see that the workmen do not utilize the departmental canteen facilities. Contractor has to make his own arrangements to provide refreshment for the workmen.
37. **All the works shall be executed as per the specifications provided in BOQ / TNBP / BIS.**

38. The works contract entered with the successful tenderer will be governed by the BHEL Revised General Conditions of Contract in force.
39. All the materials to be used in the work and the nature of work shall conform to the respective TNBP, IRC & BIS and National Building Organisation, Standard Specifications forming part of "ALL INDIA STANDARD SCHEDULE OF RATES" specifications.
40. The contractor should maintain proper accounts for materials if any supplied by this organisation and these should be available at the site of work for verification and check by the Officials of this Organisation at any time.
41. All materials brought by the Contractor for incorporation in the work shall be got inspected and approved by the Engineer-in-charge before they are actually incorporated in the work.
42. All safety measures are to be followed during execution of work during stocking, hoisting and laying of metal roof sheets, polycarbonate sheets, turbo air ventilators etc. Necessary scaffolding, ladders, safety net, life lines barricaddings etc. are to be provided with prior permission from safety department. Necessary work permit to work at heights to be obtained.
43. The contractor should use only the materials of brand and quality approved by BHEL.
44. The contractor should submit the programme for the completion of work and indicate the list of machineries and site personnel to be deployed for the work along with tender.
45. All bought out items and consumables brought by the contractor should have manufacturer's certificate.
46. The contractor has to plan and work for the areas on priority and availability on mutual agreement with execution and user production department obtaining prior permission and shut down if any from concerned departments.
47. Contractor's materials and tools & plants shall be brought inside factory with proper invoice / voucher and make necessary entry at the security gate. They should maintain proper record for tools and plants, materials, etc., brought inside the factory complex.
48. The contractor should extend fullest co-operation with the third party agencies engaged, if any by BHEL to adhere the Quality Control Procedures ensuring quality.
49. The contractor should extend full co-operation to the other contractors who may be doing other works in the same areas enabling them to execute their portions of work without any delay or difficulty.
50. With regard to specifications not covered by the General and Special Conditions of Contract, those contained in the Tamil Nadu Building Practice Standard Specifications or other specifications approved by Bharat Heavy Electricals Limited, shall apply.

51. At the written request from the contractor **Water required for the work and labour colony will be provided by this organization at only one point near the site of the work at free of cost.** In case of failure of water supply, the Contractor will have to make his own arrangements for water without any extra claims until supply is restored. BHEL does not accept any liability whatsoever for non-supply or delay in the supply of water under any circumstances. The contractor shall ensure that there is no wastage of water otherwise supply of water is liable to be stopped at contractor's risk and cost.
52. At the written request from the contractor **Electrical energy required for the work will be given by this organization at any one point near the site of work at free of cost.** BHEL does not accept any liability whatsoever for non-supply, delay in supply or failure of supply of electrical energy. Contractor shall ensure that there is no wastage of electrical energy otherwise supply is liable to be stopped at contractor's risk and cost. The contractor shall make leak proof / fire proof shed and provide control panel board of required capacity and lay the required cables at their own cost for further distribution.
53. At the written request from the contractor **Compressed air for the work will be provided by this organization at only one point near the site of work at free of cost.** The contractor should be in a position to make his own arrangement for compressed air without any extra claim for the uninterrupted operation of jackhammer with silencer wherever BHEL is not in a position to supply compressed air.
54. Tenderers are requested to furnish the duly filled in E-format attached in the last page of the Qualification Bid (Page No.47) tender document (i.e.) acceptance for Electronic Fund Transfer / RTGS Transfer for any payment from BHEL, Trichy.
55. Bank Guarantee format can be obtained after award of work in case of successful tenderer.
56. No advance / mobilization advance will be given.
57. LD/Penalty clause is applicable as per General Conditions of Contract. All the terms & conditions in the documents are binding on the tenderers and BHEL reserves its right to accept / reject any or all the tenders and to award the work in full or parts to more than one agency without assigning any reasons. Also it reserves its right to finalize the contract through reverse auction, please refer Page No.9 & 10 of Qualification Bid.
58. The rules, terms and conditions regarding reverse action are enclosed in the tender document Qualification Bid.

REVERSE AUCTION

BHEL reserves the right to go for a Reverse Auction (RA) instead of Opening the submitted sealed bid, which will be decided after technical evaluation. Information and general terms and conditions governing RA are given below.

GENERAL TERMS AND CONDITIONS OF RA

Against this tender for the subject work/system with detailed scope of work as per tender specifications, BHEL may resort to "REVERSE AUCTION PROCEDURE" i.e., ON LINE BIDDING ON INTERNET.

1. For the proposed reverse auction, technically and commercially acceptable bidders only shall be eligible to participate.
2. BHEL will engage the services of a service provider who will provide all necessary training and assistance before commencement of on line bidding on internet.
3. BHEL will inform the vendor in writing in case of reverse auction, the details of Service Provider to enable them to contact & get trained.
4. Reverse Auction rules like event date, time, Start price, bid decrement, extensions etc. also will be communicated through service provider for compliance.
5. Vendors have to fax the Compliance form in the prescribed format (provided by Service provider) before start of Reverse auction. Without this, the vendor will not be eligible to Participate in the event.
6. BHEL will provide the calculation sheet (e.g., EXCEL sheet) which will help to arrive at "Total Cost to BHEL" like Taxes and Duties, Freight charges, Insurance and loading factors (for non-compliance to BHEL standard Commercial terms & conditions) for each of the vendor to enable them to fill-in the price and keep it ready for keying in during the Auction.

However if the service tax is applicable for this contract, the same will be reimbursed on production of valid document proof for having paid service tax by the tenderer.

7. Reverse auction will be conducted on scheduled date & time.
8. At the end of Reverse Auction event, the lowest bidder value will be known on the network.
9. The lowest bidder has to Fax the duly signed Filled-in prescribed format as provided on case-to-case basis to BHEL through Service provider within 24 hours of Auction without fail.
10. Any variation between the on-line bid value and the signed document will be considered as sabotaging the tender process and will invite disqualification of vendor to conduct business with BHEL as per prevailing procedure.
11. In case BHEL decides not to go for Reverse Auction procedure for this tender enquiry, the Price bids and price impacts, if any, already submitted and available with BHEL shall be opened as per BHEL's standard practice.
12. BHEL reserves the right to negotiate if need be, with the "L1" vendor of the Reverse Auction

Force Majeure clause: If at any time during the continuance of this contract the performance in whole or in part by either party of any obligations under this contract shall be prevented or delayed by reason, of any war, hostilities, acts of the public enemy, civil commotion, sabotage, fires, explosions, epidemics, quarantine, restrictions or acts of GOD (hereinafter referred to as events) then provided notice of happening of any such events is given by either party to other within twenty one days from the date of occurrence thereof neither party shall reason of such events be entitled to terminate this contract nor shall either party have any such non performance and delay is resumed as soon as practicable after such events has come to an end or ceased to exist. If the performance in whole or part of any obligation under this contract is prevented or delayed by reason or any such event claims for extension of time shall be granted for period considered reasonable by BHEL subject to prompt notification by the tenderer to BHEL of the particulars of the events and supply to the BHEL if required of any supporting evidence. Any waiver of time in respect of partial installment shall not be deemed to be a waiver of time in respect of remaining deliveries.

The correspondence exchanged against the tender from both tenderer and BHEL through email are considered as valid document legally though it is not signed. It is treated as valid confirmations made on behalf of the respective company and very much comes under the legal ambit of the business transaction and hence it is binding on both the parties to the business.

Any transaction pertaining to the tender from both the parties of business done round the clock irrespective of the office or business hours of the companies, are valid legally and binding on both the parties. This applies to the extent only in such cases where deadline time for transaction is not specifically declared by either or both the parties to the business.

In case Letter of Intent (LOI) is issued through email, the PC generated time and date of mail shall be construed as the official time and date of release of LOI. In as much as this date is within the last date of validity given by the bidder the LOI is said to have been issued within the validity period and shall be binding on both the parties to the business.

Tenderers participating in the tender should declare in their technical bid that whether they have been black-listed / kept on hold for a specified period / given Business holiday for a specified period by any Public sector undertaking or Government departments. The reasons for such action with details and the current status of such hold shall be clearly furnished to BHEL. If no such details are mentioned in the offer then it will be construed that the subject bidder is not under any such hold. But at a later date if it comes to the notice of BHEL about any such hold under enforcement on the subject bidder, BHEL will have every right to reject the offer of such vendors at any point of time and also under any stage of the finalisation of the subject tender irrespective of the status of the subject bidder in that tender. Such bidders will not be permitted to participate in the further tender proceedings and will be communicated suitably. They will not be also considered for any on going tenders even if participated till the hold is officially lifted and confirmed in writing.



BHARAT HEAVY ELECTRICALS LIMITED
(A Government of India Undertaking)
Unit : TIRUVERUMBUR, BOILER PROJECT, P.O.
TIRUCHIRAPALLI - 620 014.

CIVIL ENGINEERING DEPARTMENT

NOTICE INVITING TENDER

01. Name of work : **Supplying & fixing of Aluminium zinc alloy coated high tensile steel sheets for roofing and side sheeting to replace existing AC sheets in Factory Buildings of HPBP, SSTP and allied areas in BHEL, Trichy Complex.**
02. Estimated Cost : **Rs.200 Lakh**
03. Earnest Money Deposit : **Rs.2,00,000/-**
04. Completion Time : **TWELVE (12) Months**
(From the date of commencement of the work which will be reckoned from the date of handing over to the Contractor)
05. Cost of Tender Document : **Rs.750/-** (including Sales Tax) in DD form
This amount will not be refunded under any circumstances
06. Last Date for Receipt of Tenders : **14.55 Hrs. on 28.10.11**
07. Date of Tender Opening : **15.00 Hrs. on 28.10.11**
08. Maintenance Period : **6 (Six Months from the date of actual completion of the entire work and handing over to Bharat Heavy Electricals Limited)**

Tender document contains **93** pages in Qualification Bid and **6** pages in Price Bid including Bill of Quantities, Drawing etc.

Issued to Messrs. / Thiru :

.....

.....

.....

ISSUING OFFICER

CONTRACTOR

11

ACCEPTING OFFICER

INSTRUCTIONS TO TENDERERS

1. The tender is open to all Contractors. The Contractors not borne on the approved list of contractors of this Organization must submit the following testimonials simultaneously with their tenders.
 - i. A Certificate to establish that the tenderer is an independent contractor working on his own
 - ii. At least two certificates from responsible Officers of Government of Firms of repute, regarding the tenderer's capacity to undertake to undertake and carryout the work tendered for or similar work satisfactorily

NOTE :

- a) Copies of testimonials unless attested a Gazetted Officer will not be accepted
- b) Non – Submission of the above testimonials simultaneously with the tenders may result in the tender being rejected
2. The tenders should be accompanied by a list of contracts already held by the contractor at the time of submitting the tender and giving the following particulars
 - a) Value of each contract
 - b) The balance value of work to be done on the same
3. The tenderer is advised to obtain the tender documents in person or by a messenger duly authorized to do so. The BHARAT HEAVY ELECTRICALS LIMITED will not under any circumstances accept responsibility for the non – receipt of delay in the receipt of the tender documents by the tender.
4. Rate for each item of the tender schedule should be quoted in FIGURES and in WORDS. In case of any difference in the rates quoted in figures and in words, the lower of the two rates will be taken as the tendered rate. Unit rate quoted shall be the basis for arriving the total value of the tender. The total amount for every item shall be arrived by multiplying the unit rate with the quantity indicated for that item. In case of any arithmetic deviation is noticed in the total amount, the same will be corrected and evaluated by taking unit rate as basis and multiplying with the quantity indicated.
5. Rate quoted shall include all royalties, terminal taxes, Octroi duties, Central or Provincial Excise Tax, Sales Tax, cess on Building and other construction workers Act 1996 and any other taxes leviable under the State or Central Government rules. The Bharat Heavy Electricals Ltd., will not entertain any claim whatever in this respect. **However if the service tax is applicable for this contract, the same will be reimbursed on production of valid document proof for having paid service tax by the tenderer.**
6. Tender Value is only approximate and liable for variation without entitling the tenderer to any compensation, till the total value of contract vary by more than 20% (Twenty Percentage)
7. Quoted rate shall be firm throughout the contract period of **12 months** and no cost escalation is allowed on any account including extended period if any.
8. The works contract to be entered in to with the contractor will be governed by the BHEL Revised General Conditions of contract in force.
9. Should a tender find discrepancies or omissions in the drawings or any of the tender documents or should be in doubt as to their meaning, he should at once address the authority inviting the tender for clarification. Every Endeavour is made to avoid any error which can materially affect the basis of the tender but the successful tenderer shall take upon himself to provide for the risk of any error which may be subsequently by discovered and shall make no subsequent claim on account thereof.

10. Tenders submitted by post should be sent "Registered Post with Acknowledgement due". These should be posted with due allowance for any delay in postal delivery. Tenders received after the due date and time of opening, tenders are liable to be rejected.
11. Where the tender called for covers only the building work and excludes internal services such as sanitary and water supply installations, electrification etc., the building contractor will have to leave pockets, holes, etc., as required for other works and will have to phase his work to ensure smooth progress of the work of the other agencies also as directed by the Engineer – in – charge.
12. Where the tender schedule contains special items of work such special floor finishes, foam concrete for insulation, special water proofing treatment to roofs etc., it will be entirely at the discretion of the Project Authorities to allot these items of work to other contractors specialized in these works. In such cases, the main building Contractor will have to tender all necessary co-operation to the agencies involved so as to ensure the smooth progress of all work.
13. The contractor's responsibility under this shall commence from the date of receipt of the contract order of acceptance of his tender. The scheduled period of completion for this work will be as mentioned in page No. 01, and the Contractor will have to plan his work accordingly.
14. Generally, the maintenance period for any work under BHEL Organization will be Six(6) months .
15. **Earnest Money Deposit:**

Earnest Money is to be paid by each tenderer to ensure that the tenderer does not refuse to execute the work after it is awarded to him. EMD be furnished only in the form of Pay Order or Demand Draft in favour of BHEL, Trichy , EMD in any other form will not be accepted. The rate of earnest money deposit shall be as under:

Works costing up to Rs. 2 lakhs	NIL
Works costing more than Rs.2 lakh and up to Rs. 5 lakhs	Rs. 10000/-
Works costing more than Rs.5 lakhs and up to Rs.10 lakhs	Rs. 20000/-
Works costing more than Rs.10 lakhs and up to Rs.20 lakhs	Rs. 40,000/-
Works costing more than Rs.20 lakhs and up to Rs.30 lakhs	Rs. 60,000/-
Works costing more than Rs.30 lakhs and up to Rs.50 lakhs	Rs.1,00,000/-
Works costing more than Rs.50 lakhs and up to Rs.100 lakhs	Rs.1,50,000/-
Works costing more than Rs.100 lakhs	Rs. 2,00,000/-

One time EMD will also be Rs.2.00 lakhs.

EMD by the Tenderer will be forfeited as per tender Documents if:

- After opening the tender, the tenderer revokes his tender within the validity period or increases his earlier quoted rates,
- The tenderer does not commence the work within the period as per LOI / Contract. In case the LOI / contract is silent in this regard then within 15 days after award of contract.
- EMD given by all unsuccessful tenderers shall be refunded normally within fifteen days of acceptance of award of work by the successful tenderer.
- EMD shall not carry any interest.

16. Should a tenderer or a contractor on the list of approved Contractors have a relative, or in the case of a firm or Company of contractors any of its share holders or shareholder's relative, employed in a gazetted capacity in the Engineering Department of the Bharat Heavy Electricals Limited, the authority inviting tenders shall be informed of this fact at the time of submission of the tender, failing which tender, may be disqualified or if such fact subsequently comes to light, the contract may be rescinded in accordance with the relevant provisions in the General Conditions of Contract.
17. If tenderer expires after the submission of his tender or after the acceptance of his tender the BHEL may, at their discretion, cancels such tender. If a partner of a firm expires after submission of tender or after the acceptance of the Tender, BHEL may cancel such Tender at their discretion unless the firm retain its character.
18. The Bharat Heavy Electricals Limited will not be bound by any power of attorney granted by the tenderer or by changes in the composition of firm made subsequent to the execution of the contract. They may however recognize such power of attorney and changes after obtaining proper legal advice the cost of which will be chargeable to the contract concerned.
19. If the tenderer deliberately gives wrong information in his tender or creates conditions favorable for the acceptance of his tender, the Bharat heavy Electricals Limited, reserves the right to reject such tender at any stage.
20. Words importing the singular number shall also be deemed to include the plural number and vice versa where the context so requires.
21. The expenses for competing and stamping the agreement shall be paid by the contractor.
22. The General and special conditions are complementary to each other and where they are conflict the Special Conditions shall prevail. In regard to matters not covered by the General and Special Conditions of Contract, those contained, those contained in the Tamil Nadu Building Practice Standard Specifications or other specifications approved by the Bharat Heavy Limited, Shall apply.
23. Tenderers shall not increase their quoted rates in case the Bharat Heavy Electricals Limited, negotiates for negotiation for reduction of rates. Such negotiation shall not amount to cancellation or withdrawal of the original offer and the rates originally quoted shall be binding on the tenderes for a period of three months from the date of opening of tenders.
24. Canvassing in any form in connection with tenders is strictly prohibited and the tenders submitted by the contractors who resort to canvassing will be liable to rejection
25. All contractors will have to produce Income tax Clearance Certificate from the Income Tax– Officer concerned along with their tenders. Those Contractors whose income is not taxable will be required to give an affidavit of their income on the prescribed form. If the successful tenderer fails to produce the Income – tax clearance certificate within the stated period the Earnest Money Deposit and Security Deposit of the tenderer may be forfeited and the contract terminated.

TENDER NOTICE

NAME OF WORK : Supplying & fixing of Aluminium zinc alloy coated high tensile steel sheets for roofing and side sheeting to replace existing AC sheets in Factory Buildings of HPBP, SSTP and allied areas in BHEL, Trichy Complex.

ESTIMATED COST : Rs 200.00 LAKHS

1. SEALED TENDERS for the above noted work are hereby invited from contractor experienced in works of similar kind and magnitude. Tenders will be received by **SR MANAGER/CIVIL/PLANNING(FACTORY)** Bharat Heavy Electricals Limited, Tiruchirappalli – 620 014. Up to 14.55 Hrs. on **28.10.11** and will be opened on the same day at 15.00 Hrs. at the **Office of the SR.MANAGER /CIVIL/ PLANNING (FACTORY)** in the presence of such of those tenderers. Or their agents who may choose to attend.
2. TENDER FORMS and other particulars regarding the proposed work can be obtained on any working day from 8.00 A.M. to 4.30 P.M. up to **27.10.11** on payment of the prescribed sum of Rs. **750 / -** per set (including Sales Tax) in the form of Demand Draft Amount nor refundable.
3. TENDERS must be submitted in sealed covers and should be addressed to the with full name and address of the tenderer and the name of work being noted on the cover
4. All entries in the tender documents should be in the one ink. Erasers and over writings are not permitted. All cancellations and insertions should be duly signed by the tenderer concerned.
5. TENDERERS should fill in all the required particulars in the blank spaces provided for this purpose in the tender documents and also sign each and every page of Tender Documents including the drawings attach there to before submitting their tender.
6. UNIT rate should be quoted in figures as well as in words with reference to each item and for all the items shown in the attached schedule. These rates shall be for the finished work in site. Amount of each item and the total page by page and also the grand total amount of the whole contract should be filled in by the tenderers. Unit rate quoted shall be the basis for arriving the total value of the tender. The total amount for every item shall be arrived by multiplying the unit rate with the quantity indicated for that item. In case of any arithmetic deviation is noticed in the total amount, the same will be corrected and evaluated by taking unit rate as basis and multiplying with the quantity indicated.
7. QUANTITIES shown in the attached schedule are only approximate and are liable to variation without entitling the Contractors to any compensation, provided the total value of the Contract does not vary by more than 20% (twenty percent)
8. In quoting their rates, the tenderers are advised to take account all factors including any fluctuations in the market rates etc. No claim will be entertained on this account after acceptance of the tender or during the currency of the contract.
9. Before tendering, the tenderers are advised to inspect the site of work and its environments and be well acquainted with the actual working and other Prevalent conditions position of materials and labour, General and Special Conditions of Contract. Instructions to tenders, drawings and Specifications and all other documents which form part of the Agreements to be entered into.

CONTRACTOR

15

ACCEPTING OFFICER

10. The rates quoted in the tender shall remain valid for a period THREE MONTHS from the date of opening of tenders.
11. In the event of tender being submitted by firm the tender must be signed separately and legibly by each partner or member of the firm or in their absence, by the person holding the power of attorney on behalf of the firm concerned in the latter case a copy of the power of attorney duly attested by a Gazetted Officer must accompany the tender.
12. Every tender must be accompanied with EMD for the amount as specified in Page No. 01 in any of the form mentioned in Para 12 of the "Instruction to Tenderers". This Earnest Money will be refunded to the unsuccessful tenderers within fifteen days of finalization of the award of work. In case of the successful tenderer, the Earnest Money will be retained as part of the Security Deposit for satisfactory completion of the work in accordance with Clause 16 of the General Conditions of Contract

NOTE : Cheques, Currency Notes and Money Orders will not be accepted in lieu of the deposit receipt referred to above

13. Security Deposit

13.1 Security Deposit should be collected from the successful tenderer . The rate of Security Deposit will be as below:

Up to Rs. 10 lakhs	: 10%
Above Rs. 10 lakhs up to Rs.50 lakhs	: 1 lakh + 7.5% of the amount exceeding Rs. 10 lakhs.
Above Rs. 50 lakhs	:Rs.4 lakhs + 5% of the amount exceeding Rs. 50 lakhs.

The security Deposit should be collected before start of the work by the contractor.

13.2 Security Deposit may be furnished in any one of the following forms

- i) Cash (as permissible under the Income Tax Act)
- ii) Pay Order, Demand Draft in favour of BHEL.
- iii) Local cheques of scheduled banks, subject to realization.
- iv) Securities available from Post Offices such as National Savings Certificates, Kisan Vikas Patras etc.
(Certificates should be held in the name of Contractor furnishing the security and duly pledged in favour of BHEL and discharged on the back).
- v) Bank Guarantee from Scheduled Banks / Public Financial Institutions as defined in the Companies Act. The Bank Guarantee format should have the approval of BHEL.
- vi) Fixed Deposit Receipt issued by Scheduled Banks / Public Financial Institutions as defined in the Companies Act . The FDR should be in the name of the contractor, A/C BHEL, duly discharged on the back.
- vii) Security deposit can also be recovered at the rate of 10% from the running bills. However in such cases at least 50% of the Security Deposit should be collected before start of the work and the balance 50% may be recovered from the running bills.

- viii) EMD of the successful tenderer shall be converted and adjusted against the security deposit.
- ix) The security deposit shall not carry any interest.

NOTE: Acceptance of Security Deposit against Sl. No. (iv) and (vi) above will be subject to hypothecation or endorsement on the documents in favour of BHEL. However, BHEL will not be liable or responsible in any manner for the collection of interest or renewal of the documents or in any other matter connected therewith.

- 14. Unless the contractor whose tender is accepted signs the Contract Agreements and makes the necessary security deposit specified in Para 13 above within Seven days of the date of the order directing him to do so the amount of Earnest Money Deposit already deposited by him will be forfeited and acceptance of his tender withdrawn.
- 15. If after opening of tenderer revokes his tender or increases his earlier quoted rates or after acceptance of his tender does not commence the work in accordance with the instruction of the Engineer-in-charge, the Earnest Money deposited by him will be forfeited and acceptance of his tender withdrawn. If only a part of the work included in the tender had been awarded to the tenderer, the amount of Earnest Money to be forfeited will be based on the value of the contract so awarded.
- 16. The Bharat Heavy Electricals Limited reserve the right to reject any or all the received or accept any tender or part there of without assigning any reason thereof. In the case acceptance of part of tender, time for completion may also be reduced to the extent considered appropriate by the Accepting Authority.
- 17. Conditional and Unwitnessed tenders, tender containing absurd rates and amounts tenders which are incomplete or otherwise considered defective and tenders not in accordance with the tender conditions laid down by the Accepting Officer are liable to be rejected.
- 18. Tenders not submitted on the prescribed form are liable to be rejected
- 19. The work must be completed within a period as mentioned in Page No.11.
- 20. The Chairman / General Manger / Deputy General Manager / Deputy Manager / Senior Engineer shall be Accepting Officer, herein after referred to as such for the purpose of this contract.
- 21. This tender notice shall be deemed to form an integral part of the contract to be entered into for this work.
- 22. The tenderers are advised to go through the condition stipulated in Tender document & code of conduct for 'Health & Safety of Contract Labourer' in details. Any violation thereof will invite punitive action being taken against them. While quoting the rate all the above factors are to be taken into account.

ISSUING OFFICER

GENERAL AND SPECIAL CONDITIONS OF CONTRACT

GENERAL CONDITIONS

1. No night work will be permitted without the written permission of the Engineer – in – charge.
2. Bulkage test on the sand to be used on the work should be conducted periodically to arrive at the correct quantity of sand to be mixed for the different proportions as and when required.
3. Items of work other than those mentioned in the Bill of Quantities (Tender Schedule) attached hereto will be carried out at the rates to be fixed by this organization as per relevant clauses of the General Conditions of Contract.
4. **(a) On the written request from the contractor Water required for the work may be provided by this organization at only one point at the site of the work at free of cost.** In case of failure of water supply, the Contractor will have to make his own arrangements for water without any extra claims until supply is restored. BHEL does not accept any liability whatsoever for non supply or delay in the supply of water under any circumstances. The contractor shall ensure that there is no wastage of water otherwise supply of water, is liable to be stopped at contractor's risk and cost.
(b) On the written request from the contractor Electrical energy required for the work may be given by this organization at any one point at the site of work at free of cost. BHEL does not accept any liability whatsoever for non-supply, delay in supply or failure of supply of electrical energy. Contractor shall ensure that there is no wastage of electrical energy otherwise supply is liable to be stopped at contractor's risk and cost. The contractor shall make leak proof / fire proof shed and provide control panel board of required capacity and lay the required cables at their own cost for further distribution.
(c) On the written request from the contractor Compressed air alone will be provided this organization at only one point near the site of work at free of cost. The contractor has to provide further arrangements from that point to his other areas. Also the contractor should be in a position to make his own arrangement for compressed air without any extra claim for the uninterrupted operation of jack hammer with silencer wherever BHEL is not in a position to supply compressed air
5. Permission for erection of temporary work sheds etc., at site will have to be obtained from BHEL in writing in advance.
6. The works contract to be entered into with the successful tenderer will be governed by the BHEL revised General Conditions of Contract in force.
7. The successful tenderer / Contractor shall observe all safety regulations and take necessary safety precaution as called for under the "BHEL General Conditions of Contract and Safety Precautions" enclosed herewith.
8. In all matters of dispute, the decision of the General Manager, Bharat Heavy Electricals Ltd., Tiruchirappalli – 620 014. shall be final and binding on the tenderer / contractor.
9. Some changes are likely in the quantities furnished as well as in the layout, design and specifications of the work. The rate quoted shall be deemed to be inclusive of all such contingencies.
10. All the materials to be used in the work and nature of work shall conform to respective TNBP, IS and National Buildings Organisation Standard Specifications and shall be got approved by the Engineer – in – charge before actual incorporation in the work

SPECIAL CONDITIONS

1. Unless otherwise indicated in the Bill of Quantities cement, reinforcement steel (MS rods, CTD bars etc.), structural steel sections and other items (as mentioned in Schedule B) will be issued at BHEL Stores at free of cost. The Contractor's quoted rates shall therefore be inclusive of the cost of conveyance of these items from BHEL Stores to site of work including, loading, unloading and other incidental costs etc. The quantities of each items to the extent required for actual incorporation of the work will be treated as ISSUED FREE OF COST.

2. CEMENT:

Excess consumption of cement over and above the theoretical requirement as per BHEL Data upto a limit of 5% will be charged at the rate of Rs.6,668/per M.T. + applicable taxes at the time of recovery. Consumption beyond 5% will be charged at the punitive recovery rate of Rs.13,336/per M.T.. + applicable taxes at the time of recovery.

The above rates are only indicative and BHEL issue rate on date of actual issue will be applied

Gunny bags or Polythene Bags or Paper Bags in which cement is issued from BHEL Stores, need not be returned by Contractor to BHEL. The cost for each empty cement bag will be recovered from the Contractor's bills at the following rates.

- | | | |
|-----|------------------------|-----------------------------|
| i. | Empty cement gunny bag | Rs.1.25 + ST and SC / each |
| ii | Empty Polythene bag | Rs. 0.50 + ST and SC / each |
| iii | Empty paper bag | Rs. 0.25+ST and SC / each. |

3. REINFORCEMENT STEEL:

All surplus reinforcement rod with the contractor shall be returned to BHEL Stores at his own cost in the form of full lengths, useful cut bits and scrap. The invisible (non-returnable) wastage should not exceed a maximum of 0.5% of the actual quantity consumed in the work.

The contractor shall return all the scrap to the disposal stores at his own cost. Bent rods will also be taken as scrap only, irrespective of their length. The maximum permissible limit of scrap without recovery is 5% of actual consumption. The recovery details for the materials are as follows:

- | | | |
|----|--|--|
| a) | Single recovery rate for the non returned scrap upto 5% of actual consumption | : Rs.49,547/- per M.T + applicable taxes at the time of recovery |
| b) | The punitive recovery rate for steel qty. not accounted and extra scrap generated beyond 5% of actual consumption | : Rs.99,095/- per M.T. + applicable taxes at the time of recovery |

The above rates are only indicative and BHEL issue rate on date of actual issue will be applied.

4. STRUCTURAL STEEL SECTIONS:

All surplus raw steel remaining with the contractor shall be returned to BHEL stores at his own cost after completion of fabrication, in the form of full lengths, useful cut bits and scrap. The following yardstick will be adopted for the purpose of classification of scrap.

(a) Mild steel and alloy Steel plates and sheets	1000X500mm and above	Useful cut bit
(b) Mild steel and alloy Steel plates and sheets	Less than 1000 X 500 mm	Scrap
(c) Structural	One metre and above in length	Useful cut bits
(d) Structural	Less than one metre in length	Scrap

The invisible (Non-returnable) wastage should not exceed a maximum of 2% by weight of fabricated steel work and returnable wastage generated by way of scrap or useful cutbits shall be returned at "Actuals". Maximum permissible limit for scrap without recovery shall be 5% of actual fabricated quantity. However every care should be taken to see that raw steel is utilised most economically by preparing necessary cutting lists to restrict the scrap within the permissible limit.

Should the quantum of invisible wastage exceed the 2% permissible limit, RECOVERY AT TWO TIMES OF THE VALUE OF the extra tonnage involved (which will be evaluated on an average cost per tonne basis considering the total raw steel materials issued) will be effected from the contractor for the excess quantity involved (**2 times x Rs. 48,495 = Rs.96,990 / MT + applicable taxes at the time of recovery**).

The above rates are only indicative and BHEL issue rate on date of actual issue will be applied.

The Contractor shall submit a material tallying statement on completion of the work indicating the details of quantities of each material (section by section) received quantities used for fabrication as per DOD lists. Quantity returned in full length, useful cut bits and scrap and the quantity reckoned as invisible wastage.

i) For Structural Steel:

- a) **Single recovery rate for the non returned scrap upto 5% of actual consumption** : **Rs.48,495/- per M.T + applicable taxes at the time of recovery**
- b) **The punitive recovery rate for steel qty. not accounted and extra scrap generated beyond 5% of actual consumption** : **Rs.96,990/- per M.T. + applicable taxes at the time of recovery**

ii) For Rails:

- a) **Single recovery rate for the non returned scrap upto 5% of actual consumption** : **Rs.65,739/- per M.T + applicable taxes at the time of recovery**
- b) **The punitive recovery rate for steel qty. not accounted and extra scrap generated beyond 5% of actual consumption** : **Rs.1,31,478/- per M.T. + applicable taxes at the time of recovery**

iii) For ERW Tubes:

- a) **Single recovery rate for the non returned scrap upto 5% of actual consumption** : **Rs.42,534/- per M.T + applicable taxes at the time of recovery**
- b) **The punitive recovery rate for steel qty. not accounted and extra scrap generated beyond 5% of actual consumption** : **Rs.85,068/- per M.T. + applicable taxes at the time of recovery**

iv) For Seamless Steel Tubes:

- a) **Single recovery rate for the non returned scrap upto 5% of actual consumption** : **Rs.1,23,260/- per M.T + applicable taxes at the time of recovery**
- b) **The punitive recovery rate for steel qty. not accounted and extra scrap generated beyond 5% of actual consumption** : **Rs.2,46,520/- per M.T. + applicable taxes at the time of recovery**

The above rates are only indicative and BHEL issue rate on date of actual issue will be applied.

5. The Contractor should maintain proper accounts of cement, MS rods / CTD bars, structural steel sections and other materials if any supplied by this organization and these should be available at the site of the work for verification and check by the official of this organization at any time.
6. All materials brought by the Contractor for incorporation in the work shall be got inspected and approved by the Engineer-in-charge before they are incorporated in the work
7. The Manager / Civil or his duly authorized representative shall have all reasonable times access to Contractor's premises of work and shall have the power at all the reasonable times to inspect and test any portion of the work or examine the materials and workmanship of the structures during their manufacture and test. The contractor shall give due notice in writing to the Inspecting Engineer of BHEL when the materials supplied to be incorporated in the work are ready for inspection and test. No material shall be incorporated in the work until the inspecting Engineer certified in writing that such materials have been inspected and approved by him.
8. The Contractor shall closely scrutinize all the drawings issued in connection with the work by this organization and bring to the notice of the Engineer-in-charge if any discrepancies, omissions in the drawings before undertaking the actual work pertaining thereto.
9. The contractor should submit in advance every fortnight a detailed programme of work to be undertaken from time to time strictly in conformities with the "Time and Progress Chart" covering the entire constructed work and reschedule them wherever necessary during the progress of the work so as to achieve the target set. Periodical progress reports of every fortnight should also be furnished by the Contractor regarding the collection of materials issued and to be issued from BHEL Stores and other relevant information as asked for by the Engineer-in-charge and other BHEL Officers-in-charge of the work.
10. The contractor should extend full co-operation to the other contractors who may be doing other works in the same areas to enable them to execute their portions of work without any delay or difficulty.

GENERAL SAFETY PRECAUTIONS TO BE FOLLOWED AT WORK SITE DURING EXECUTION

The following safety measures should be strictly adhered to during execution of works at sites.

1. Providing the working platform with toe board and handrail for continuous working at heights.
2. Providing safety belt and life line at all times for men working at heights.
3. Providing dust or fume respirator in places where dust and fume concentration exists.
4. Providing goggles and welding screens.
5. Providing acid and alkali proof rubber gloves for handling acid and alkali and chemical which are corrosive.
6. Providing rubber gloves for working on electrical works.
7. Ensuring proper lashing of the components while being transported in vehicles.
8. The vehicles must have side supports or have body to support the materials conveyed.
9. The materials should not be allowed to extend or overflow the sides of the vehicles.
10. Materials should not be allowed to overhang from the rear edge of the body of the vehicle.
11. Driver of the vehicle must possess license.
12. Vehicle must not be overloaded prescribed limits.
13. Red flags and lights for parts projecting from the body of vehicle must be provided.
14. The speed restrictions within the factory premises must be strictly adhered to.
15. The gas cylinders must be always handled on trolleys or kept tied down not in use. They should never be rolled as Roller for conveying.
16. Cylinders should not be used without regulators.
17. All excavations must be barricaded and red lamps must be provided.
18. All electrical connections must be properly earthed.
19. No work should be taken up for execution inside shop floor, without obtaining necessary work permit.
20. Providing helmet, safety belt, etc., for high level work and sufficient number of Industrial Safety nets at appropriate level to safeguard the persons working at high level particularly in trusses, girders, roofing etc., of industrial and high roof buildings.
21. The contractor should maintain a register regarding the driver license particulars.
22. All personal protective equipment conform with standard specification as per the details given in the code of conduct.

Contractor including their sub contractors, agents and labour engaged on the work are required to scrupulously adhere to the safety regulations, safety precautions and measures. Any violation thereof will invite punitive action being taken against them. Also contractors with frequent violations of safety regulations will not be entrusted with further work in this organization.

SAFETY PRECAUTIONS TO BE OBSERVED WHILE TRANSPORTING MATERIALS

I. VEHICLE

1. Vehicles carrying material should have proper registration documents and must be produced on demand by our Security Staff.
2. The light on right side, i.e., over the drivers cabin shall be in working condition.
3. Both the head lights as well as park lamps must be in working conditions.

II. MOVEMENT OF VEHICLE

1. The vehicle should not travel at more than 20 km.ph in our premises.
2. The Driver of the vehicle must possess heavy duty licence and produce on demand by the Security Staff.
3. Vehicles carrying inflammable liquids in the tank containers should have grounding chain or the tank should be coated with insulating material also to avoid Static Electricity.
4. In road junctions, speed breakers and railway crossing, the speed should be lowered and vehicle should proceed cautiously.
5. The driving should 'KEEP TO THE LEFT' at all places.
6. The vehicle should not be parked in road which could obstruct the vehicular traffic.
7. No person other than driver should be allowed to sit or stand on the prime mover or trailer.
8. The vehicle should pass only through the approved routes. Short cuts should be forbidden.
9. There must be a safe distance behind another moving truck.
10. The driver should avoid making quick starts, jerky stops or quick turns at excessive speed.

III SHIPPING

1. Strong side supports should be provided on both sides of the trailer. The side supports should be fixed in such a way that it cannot be removed even temporarily.
2. Adequate packing must be given for easy slinging operation. The packing materials should be good enough to withstand the load.
3. The stacking of loads in the truck should be evenly placed. The load should not be heaped together or dumped over the chassis.
4. The loaded materials should be fastened tightly with 'WIRE ROPE'. Manila rope or coir rope should not at all be used. There must be side packing such as gunny or rubber tyre between the sharp edge of the job and wire rope in order to avoid cut in the wire rope.
5. There must be minimum two fastenings and it should be more in case of lengthier loads.
6. The wire rope should be in sound conditions i.e, there should not be links, knots or bristles etc.,
7. The wire rope ends should be clamped with 'U' clamps.
8. The load on the truck should not be beyond its standard capacity. The carrying capacity must be clearly marked on the trailer also.
9. The loose pieces should be bundled before loading on the truck.
10. There must be red flags or red lamps for the lengthy loads which extend beyond chassis.
11. The load should not be over hanging more than 3 ft. from the end of the body.
12. The materials should not be stacked too high to avoid hitting against live electric lines.
13. While transporting the scraps, there must be wire knitting cover to prevent falling of scrap.

IV GENERAL

The vehicles should not be moved directly inside the production building in case the materials are to be unloaded there. But the vehicle should be parked outside the building and the driver should ascertain the passage as well as the unloading points with the help of shop officials. This will avoid the congestion of blocking of traffic in the gangway.

**TERMS AND CONDITIONS REGARDING COMPLIANCE WITH VARIOUS LABOUR
LAWS BY THE CONTRACTORS FOR BHEL**

1. The Contractor shall not employ in connection with the work any person who has not completed 18 years of age.

2. The Contractor shall in respect of labour employed by him either directly or through subcontractors, comply with or cause to be complied with the following statutory provisions and rules and in regard to all matters provided therein.
 - a) The Contract Labour (Regulation & Abolition) Act 1970 and the related Tamil Nadu Rules.
 - b) The Minimum Wages Act 1948 and the related Tamil Nadu Rules.
 - c) The Payment of Wages Act 1936 and the related Tamil Nadu Rules.
 - d) The Factories Act 1948 and the related Tamil Nadu Rules.
 - e) The Employee's Provident Fund & Miscellaneous Provisions Act 1952.
 - f) The Employees State Insurance Act 1948.
 - g) The Workmen Compensation Act 1923.
 - h) The Industrial Disputes Act 1947.and any other law or modifications to the above or to the Rules made thereunder from time to time.

REGISTRATION AND LICENSING

3. Every Contractor shall register his name with the Welfare Section of BHEL before taking up the work awarded to him by giving the following information and getting a Code Number :
 - a) The Name of the Contractor
 - b) Nature of Contract Work
 - c) Period of work
 - d) Number of maximum labour employed by him on any one day
 - e) License No. & Date (Applicable in case of contractor employing 20 or more workers)
 - f) Whether enrolled for PF, ESI, etc., and enrolment No.

This information is called for, for the purpose of informing the Inspectorate of Factories whenever they call for information regarding contracts.

4. The Contractor employing 20 or more workmen is required to obtain license from the authorities (The Deputy Chief Inspector of Factories / Assistant Commissioner of Labour as the case may be). The license shall be amended and / or renewed wherever, there is an increase in the workmen employed by him or in the event of contract being extended or renewed. The Contractor shall inform the licence number to the BHEL Management before taking up the work.

5. The Contractor (Licensed or unlicensed) shall promptly furnish every information and document required by BHEL authorities for the purpose of fulfilling their obligations as Principal Employer and / or Occupier of the Factory and shall render all necessary assistance for the same.

WAGES

6. The Contractor shall pay wages to the workmen employed by him at the rate which shall not be less than the minimum wages applicable under Law from time to time.
7. The Contractor shall fix wage periods in respect of which wages shall be payable. No wage period shall exceed one month.
8. The Contractor shall ensure payment of wages to the contract labour employed by him within three days from the end of wage period in case the wage period is one week or a fortnight and in all other cases before 10th day of the following month.
9. All Payment of wages shall be made on working days at the work site and during the working time and on date notified in advance. In case the work is completed before the expiry of the wage period final payment shall be made within 48 hours of the last working day.
10. Where the employment of any worker is terminated by or on behalf of the Contractor, the wages earned by him shall be paid before the expiry of the second working day from the day on which his employment is terminated.
11. Wages due to every worker shall be paid to him direct or to the person authorized by him in this behalf. All wages shall be paid in current coin or currency in both.
12. The Contractor shall ensure the disbursement of wages in the presence of such authorized representative of BHEL Management.
13. The above payment shall be verified by the authorized officer / representative of BHEL with the following certificate of the payment sheet "Certified that the amount shown in Column No..... has been paid to the workmen concerned in my presence onat....."
14. A certificate of payment shall be furnished in duplicate by the Contractor to the Engineer in charge each month in Form 'A'.
15. A notice showing the wage period and the place and time of disbursement of wages shall be displayed at the place of work and a copy to be sent to the Welfare Department by the Contractor under acknowledgement.
16. Notices showing the rate of wages, weekly rest days, hours of work, wage period, date of payment of wages, names and addresses of the Inspector having jurisdiction, the date of unpaid wages shall be displayed in Tamil and English in conspicuous places at the establishment and at work site by the Contractor. The Contractor shall inform the BHEL Management every month the details of contract labour engaged for contract in this following form :
 - a) Serial Number
 - b) Location
 - c) Period of work
 - d) No. of contract labour engaged during the month
 - e) No. of days worked
 - f) No. of men worked
 - g) Wages paid to workers

The above statement shall be furnished to BHEL Management at the end of every month.

REGISTERS AND RECORDS AND COLLECTION OF STATISTICS

17. The following documents / formats under Contract Labour (Regulation & Abolition) Act 1970 and Tamil Nadu Rules thereunder shall be maintained by each contractor.
 - a) Register of persons employed by the Contractor
 - b) Employment Card
 - c) Service Certificate
 - d) Muster Roll, Wage Register, Deduction Register, Wage slip, Overtime Register, Register of Fines, Register of Advances etc.,
18. The Contractor shall display the abstract of the Contract Labour (Regulation&Abolition) Act and the Rules thereunder both in English and Tamil.
19. Half yearly Return shall be sent by the Contractor in duplicate to the Licensing Officer.
20. The Contractor shall submit the returns required under the Contract Labour (Regulation & Abolition) Act 1970 periodically to BHEL Management.
21. The Contractor shall without fail give upto date information in writing of the attendance of the workers employed by him.
22. The Contractor shall ensure that his workers keep and produce their Employment Card when coming to duty and take them back when leaving duty.
23. All the above registers and records shall be preserved in original for a period of three years. All the registers, records and notice maintained under the Act and rules shall be produced on demand by Inspector or any authority under the Act.

WORKING HOURS AND WORKING CONDITIONS

24. No worker shall be required or allowed to work on Sunday unless he has or will have a holiday on anyone of the three days before or after the said day.
25. The Contractor shall inform BHEL Management in the prescribed form details of the contract workers scheduled to work on Sunday, the day of rest and also indicate the substituted holiday in lieu thereof. This shall be intimated two days in advance before his workmen are booked for work on Sunday.
26. The contract labour working for more than nine hours in any day or for more than 48 hours in any week shall be paid wages at the rate of twice the ordinary rate of wages in accordance with the provisions of Sections 59 of the Factories Act 1948.
27. The Contractor shall provide all safety devices and personal protective equipment to his workmen at his own cost and shall ensure that his workmen wear / use such devices or equipment provided to them while doing the work and there should not be any relaxation on this.
28. The Contractor shall give four paid National Holidays to his workers, viz., 26th January, 1st May, 15th August and 2nd October.
29. The Contractor shall ensure that his workmen vacate the premises after the shift is over.

30. The Contractor shall give leave with wages to his workmen who have worked for a period of 240 days or more in the Factory premises during a calendar year. This leave shall be allowed during the subsequent calendar year at the rate of one day for every 20 days of work performed by the worker during the previous calendar year. The worker whose services commences on a day other than the first of January shall be entitled to leave with wages at the above rate (One day for every 20 days of work) only if he had worked for a minimum of 2 /3 of the total number of days in the remainder of the calendar year. This leave will be admissible only during the subsequent calendar year.
31. No woman worker shall be required or allowed to work in the Factory except between the hours of 6.00 A.M. and 7.00 P.M.
32. The Contractor shall comply with the provisions relating to Welfare and Health facilities as provided in the Contract Labour (Regulation and Abolition) Act 1970 read with the Tamil Nadu Contract Labour Rules 1975.

NOTICE OF ACCIDENTS

33. Notwithstanding anything contrary to this, in the event of accident the contractor shall be required to fill injury report and submit the Engineer in charge immediately and ensure the compliances of ESI / Workmen's compensation Act, Factories Act and Rules made thereunder. He shall also maintain a register of accident as per the Act.
34. The Contractor shall get the contract labour engaged by him insured under Workmen's Compensation policy from General Insurance Corporation of India before actually starting the work of contract. The insurance coverage should be for the entire period of Contract. The Contract shall comply with the provisions of the Workmen's Compensation Act 1923. (This should be read in conjunction with the provisions of ESI Act)

COVERAGE UNDER THE ESI ACT / PF AND MISCELLANEOUS PROVISIONS ACT

35. The contractor shall ensure that all his workmen are covered under the Employee's State Insurance Act and produce to BHEL such Registration Number / Enrolment Number before executing the contract work.
36. The Contractor shall regularly pay the amount of contribution. i.e., employer's contributions as well as employees' contribution pursuant of the above scheme as fixed from time to time. The Contribution payable presently is 1.75% wages to be recovered from his workmen and 4.75% of wages to be contributed by the Contractor. Contributions recovered from employee and contribution made by the contractor may be rounded to the next higher multiples of five paise.
37. The Contractor shall take note of any amendment that may be brought forth in the above contribution rate and act accordingly.
38. The contractor shall ensure that his workmen are covered under the EPF & Miscellaneous Provisions Act 1952 and accordingly produce to the BHEL Management the registration / enrolment number before awarding of contract work. As per the existing provisions every worker shall be entitled and required to become a member of the fund. The employee's contribution payable at present is 12% of wages which will be recovered by the contractor from the wages of his workmen and the contractor should pay equal contribution. The contractor is also liable to pay any administrative charges in this behalf that may be decided from time to time. It will be the responsibility of the contractor to ensure such contribution payable in respect of workmen employed through sub-contractors also.

39. The Contractor shall take note of any amendment in the rate of contribution payable under the scheme from time to time.
40. The Contractor shall within seven days of the close of every month submit to BHEL a statement showing the amount of contribution payable / paid for employees engaged by him or through him and shall also furnish to BHEL such information as Principal Employer is required to furnish under the provisions of the ESI Act and PF as well as the schemes made thereunder to the authorities concerned.
41. Whenever any sum of money is found to be recoverable from or payable by the contractor under the above Act, the sum shall be deducted from any sum that may be due or which at any time thereafter may become due to the Contractor under this contract or under any other contract or from his security deposit. In case the recoveries are not sufficient to satisfy the claim, the contractor shall pay the balance thereof on demand. In case any recoveries are made under this clause from security deposit, the contractor shall immediately thereafter pay such further sums as may be required to replenish the shortage caused by such recoveries in amount of security deposit.
42. The Contractor shall abide by all the labour and other laws applicable to contract labour / worker under this contract and shall at all times keep BHEL indemnified against all losses, claims, prosecutions under any law.
43. In case of non-compliance of any of the provisions of the Acts and in case BHEL having complied with the same, BHEL will be entitled to recover the same from the contractor / sub-contractor.
44. Non-exercise of any of the powers or rights available to BHEL hereunder or under any law, shall not in any way operate as waiver thereof.

Note : The Specimen forms for the following are available in BHEL.

- | | | | |
|----|-----------|---|--|
| 1) | Form 'A' | - | Payment Certificate |
| 2) | Form IV | - | Application for License |
| 3) | Form XIII | - | Register of Workmen employed by contractor |
| 4) | Form XIV | - | Employment Card |
| 5) | Form XV | - | Service Certificate |
| 6) | Form XVI | - | Muster Roll |
| 7) | Form XVII | - | Register of wages |
| 8) | Form XIX | - | Wage slip |

GENERAL CONDITIONS OF CONTRACT FOR LUMP SUM, ITEM RATES AND
PERCENTAGE CONTRACT

CONTENTS

Condition No	Description
	CHAPTER - I
1	DEFINITIONS
	CHAPTER - II
	SCOPE OF CONTRACT
2	HEADING TO THE CONTRACT
3	CONTRACT DOCUMENTS
4	WORKS TO BE CARRIED OUT
5	PROVISIONAL ITEMS
6	DEVIATIONS
7	TIME
8	STORES & MATERIALS
9	DELAY & EXTENSION OF TIME
10	PATENT RIGHTS
11	OCTROI AND OTHER DUTIES
12	ROYALTIES
13	PLANT & EQUIPMENT
14	ASSIGNMENT OR TRANSFER OF CONTRACT
	a) SUB-CONTRACT
15	COMPLIANCE TO REGULATIONS AND BYE-LAWS
	CHAPTER - III
	PERFORMANCE OF THE CONTRACT
16	SECURITY DEPOSIT
17	ORDERS UNDER THE CONTRACT
18	ADMISSION TO SITE
19	CONTRACTOR'S SUPERVISION
20	LABOUR
21	WATER
22	TEMPORARY WORKSHOPS, STORES ETC.
23	STORES & MATERIALS ON SITE
24	TOOLS AND PLANTS ON SITE
25	STATEMENT OF HIRE CHARGES
26	PRECAUTIONS AGAINST RISKS
27	NOTICE & FEES
28	SETTING OUT OF THE WORKS & PROTECTION & MAINTAINING SIGNALS AND WORKS
29	SITE DRAINAGE

30	EXCAVATIONS, RELICS ETC.
31	FOUNDATIONS
32	COVERING-IN WORKS
33	APPROVAL OF WORKS BY STAGES
34	EXECUTION OF WORKS
35	DAY WORKS
36	INSPECTION OF THE WORKS
37	RESPONSIBILITY FOR BUILDING
38	INSURANCE OF WORKS
39	DAMAGE AND LOSS TO PRIVATE PROPERTY & INJURY TO WOKMEN
40	COMPLETION
41	COMPENSATION FOR DELAY
42	LAWS GOVERNING THE CONTRACT
43	CANCELLATION OF CONTRACT FOR CORRUPT ACT
44	CANCELLATION OF CONTRACT FOR INSOLVENCY,ASSIGNMENT OR SUB LETTING OF CONTRACT
45	CANCELLATION OF CONTRACT FOR DEFAULT
46	TERMINATION OF CONTRACT FOR DEATH
47	SPECIAL POWERS OF DETERMINATION
48	FAIR WAGE

CHAPTER – IV

VALUATION AND PAYMENT

49	RECORDS & MEASUREMENTS
50	VALUATION OF DEVIATIONS
51	REIMBURSEMENT/ REFUND ON VARIATION IN PRICE
52	ADVANCES ON ACCOUNT
53	FINAL BILL
54	PAYMENT OF BILLS
55	RECOVERY FROM CONTRACTOR
56	POST TECHNICAL AUDIT OF WORKS AND BILLS
57	REFUND OF SECURITY DEPOSIT
58	ARBITRATION

ANNEXURE

BHEL CONTRACTOR'S LABOUR REGULATIONS
MODEL RULES FOR LABOUR LAWS
BHEL SAFETY CODE

CHAPTER- I

1. DEFINITIONS

In these General Conditions of Contract, the following terms shall have the meaning hereby assigned to them except where the context otherwise requires:-

- a) The “CONTRACT” means the documents forming the tender and acceptance thereof, together with all documents referred to therein including General and Special Conditions of Contract, Schedules ‘A’, ‘B’, ‘C’, ‘D’, ‘E’, and / or General Summary attached to the form of tender, the Bharat Heavy Electricals Limited, Schedule of Rates as amended and in force the Specifications and the Drawings. All these documents as applicable taken together shall be deemed to form one Contract and shall be complementary to one another.
- b) The “TENDER DOCUMENTS” means the form of Tender the applicable Schedules ‘A’, ‘B’, ‘C’, ‘D’, ‘E’, and / or General Summary, General and Special Conditions of Contract and the Specification and / or Drawings as given to Contractors on payment for the purpose of preparing their tenders.
- c) The “WORK” means the work described in the tender documents in individual work orders and/or accompanying Drawings and Specifications as may be issued from time to time to the Contractor by the Engineer-in-charge within the powers conferred upon them, including all modified or additional works and obligations to be carried out either at the site or at any Factory Workshop or other place as required for the performance of the Contract.
- d) The “SITE” means the lands and/or other places on, in into or through which the work is to be executed under the Contract or any adjacent land, path or street which may be allotted to or used for the purpose of carrying out the contract.
- e) The “CONTRACTOR” means the individual, firm or Company, whether incorporated or not undertaking the work and shall include the legal personal representatives of such individuals or the persons composing the firm or Company, or the successors of the firm or Company and the permitted assigns of such individual or firm or Company.
- f) The “ Engineer-in-charge” means the Engineer who is incharge for the works referred.

CHAPTER II

SCOPE OF CONTRACT

2. Heading to the Contract:

The heading to these conditions shall not effect the interpretation thereof.

3. Contract Documents

The Accepting Officer shall furnish to the Contractor on demand “FREE OF COST” three copies of signed drawings and one copy of the signed agreement comprising of preamble to agreement, General and Special Specifications, Schedule ‘A’, ‘B’, ‘C’, & ‘E’, etc., (but excluding General Conditions of Contract and Drawings) and **three** copies of all further drawings issued during the progress of work.

However, for any additional copies of the agreement or drawings required by the Contractor the same will be supplied on payment at the specified cost.

The Contractor shall keep one copy of all the Drawings and the Specifications at the site and the Engineer-in-charge or his representative shall have access to them at all reasonable times.

None of these documents shall be used by the contractor for any purpose other than that of this contract.

The Contractor shall take necessary steps to ensure that all persons employed on any work in connection with this contract have noticed that the Indian official Secrets Act 1923 (XIX of 1923) applies to them and shall continue so to apply even after the execution of such works under the contract.

4. Works to be Carried Out

The Contract shall, except as provided under Schedules 'B' and 'C' include all labour, materials, tools, plants equipment and transport which may be required in preparation for, and in the entire execution and full completion of the work. Schedule 'A' shall be deemed to have been prepared in accordance with good practice and recognized principles and unless otherwise stated, the descriptions given therein shall be held to include waste on materials carriage and cartage, lead, return of empties, hoisting, setting, fitting in position and all other labour necessary in and for the entire execution and full completion aforesaid. Any error in description or quantity in schedule 'A' or any omission there from shall not vitiate the Contract or release the Contractor from the execution of the whole or any part of the work comprised therein according to the Drawings and Specifications, or from any of his obligations under the Contract. The insertion of the name of any firm of suppliers in the Tender Documents is for the purpose of obtaining a particular class or quality of materials or workmanship but the articles or materials specified may be obtained from any other firm subject to prior written approval of the Engineer – in – charge.

In the case of a discrepancy between Schedule 'A' the specification and / or the Drawing, the Accepting Officer shall be the sole deciding authority as to which shall prevail and his decision shall be final and conclusive. If neither Drawings nor Specifications contain any mention of minor details of construction, which in the opinion of the Accepting Officer whose decision shall be final and conclusive, are reasonable and obviously and fairly intended for the satisfactory completion of the work, such details shall be provided by the Contractor without any extra cost as if they were specially mentioned and shall be deemed to be included in the contract.

The contractor will be deemed to have satisfied himself as to the nature of the site, local facilities of access and all matters affecting the execution and completion of the work. No extra charges consequent on any mis-understanding in these respects or otherwise will be allowed.

5. Provisional Items

The full amount of provisional lumpsums and the value annexed to each provisional item inserted in the tender documents shall be deducted from the contract sum and the value of work ordered and executed thereunder shall be ascertained by measurement or valuation as for deviations.

No work under these items is to be begun without instructions in writing from the Engineer-in-charge.

The extent of quantities or items described as “Provisional” shall not be held to guarantee or limit the amount and description of the work to be executed by the contractor either in respect of the items concerned or the work as a whole.

No addition or deduction shall be made by the Contractor to the amount of the provisional lumpsums as included in the tender documents.

6. Deviations

The contractor shall not make any alteration in addition to or omission from the work as described in the tender documents except in pursuance of the written instructions of the Engineer-in-charge. No such deviation from the work described in the tender documents shall be valid unless the same has been specifically confirmed and accepted by the Accepting Officer in writing and incorporated in the contract.

The Accepting Officer may deviate either by way of addition or deduction, from the work so described, provided that the contract sum be not thereby varied on the whole by more than the percentage set out in the tender documents. The value of all addition and deductions will be added to, or deducted from the contract sum. Whenever the Accepting Officer intends to exercise such a right, his intention shall specify the deviations which are to be made, the lumpsum assessment or the proposed basis of payment, the extra time allowed, if any, and the date for completion of the entire contract.

Any objection by the Contractor to any matter concerning the order shall be notified by him in writing to the Engineer-in-charge within **Seven days** from the date of such order, but under no circumstances shall the work be stopped (unless so ordered by the Engineer-in-charge) owing to differences or controversy that may arise from such an objection. In the absence of such a notification of objection by the contractor, he will be deemed to have accepted the order and the conditions stated therein. In the event of the contractor failing to agree with the Engineer-in charge regarding the terms of the proposed deviation, the objection shall be referred to the Project Manager whose decision shall be final conclusive and binding on the Contractor.

7. Time

Time is the essence of the contract and is specified in the tender document or in each individual Work Order.

As soon as possible after the contract is let or any substantial Work Order is placed and before work under is to begin, the Engineer-in-charge and the Contractor shall agree to a Time and Progress Chart. The Chart shall be prepared in direct relation to the time stated in the Tender Documents or the Work Order for the completion of the individual items there of and/the contract or order as a whole. It shall indicate the forecast of the dates for the commencement of the various trade processes or sequences of the work, and shall be amended as may be required by agreement between the Engineer-in-charge and the Contractor within the limitation of the time imposed in the Tender Documents or Order

In the absence of any specific Time and Progress chart to be agreed to between the Contractor and the Engineer-in-charge, the contractor shall ensure and maintain uninterrupted progress of the work such that the entire work shall be completed within the time imposed in the Tender Documents or Order and that the proportion of work completed upto any time in relation to the entire work to be under the Contractor Order shall not be less than the proportion that the time elapsed bears to the total time of completion provided in the Tender Documents or Order.

The contractor shall suspend the execution of the work, or any part or parts thereof whenever called upon in writing by the Engineer-in-charge to do so, and

shall not resume work thereon until so directed in writing by the Engineer-in-charge. The Contractor will be allowed an extension of time for completion not less than the period of suspension. However, no other claim in this respect for compensation or otherwise however will be admitted. Provided the cause for suspension is not attributable to any default on the contractor's part to proceed with or fulfill the contractual obligations. This may also be extended to allow for alteration of work made by the deviation order.

8. Stores and Materials

The Contractor shall, at his own cost and expense, provide all materials required for the works, other than those listed in Schedule 'B', which are to be supplied by Bharat Heavy Electricals Limited. All materials to be supplied by the Contractor shall be of the best kind as described in the specifications and the Contractor shall, if requested by the Engineer-in-charge, furnish proof to the satisfaction of the Engineer-in-charge, that the materials so comply with the specifications.

The contractor shall, at his own expense and without delay, supply samples of materials proposed to be used in the execution of the work for approval of the Engineer-in-charge, who may reject the materials not corresponding either in quality or character to the approved samples.

In the case of stores provided under Schedule 'B' the Contractor shall bear the cost of loading, transporting to site, unloading, storing under cover as required assembling and jointing the several parts together as necessary and incorporating or fixing these stores materials in the work, including all preparatory work of whatever description as may be required, and of closing, preparing, loading and returning empty cases or containers to the place of issue without any extra charges.

9. Delay and Extension of Time:

if, in the opinion of Engineer-in-charge the work is delayed:

- i) by reason of abnormally bad weather, OR
- ii) by reason of serious loss or damage by fire, OR
- iii) by reason of Civil commotion, local combination of workmen strike or lockout, affecting any of the trades employed on the work OR.
- iv) by delay on the part of the agency or tradesman engaged by BHEL in executing work not forming part of this contract, OR
- v) by reason of any other cause which in the absolute discretion of the Engineer-in-charge is (when he is the Accepting Officer of the Contract) beyond the Contractor's reasonable control, than in such case the Accepting Officer on the recommendation of the Engineer-in-charge (or higher authority) may make fair and reasonable extension in the completion dates of the individual items of work or the contract as a whole. Such extension which will be communicated to the Contractor by the Engineer-in-charge in writing shall be final and binding on the Contractor. No other claim in this respect for compensation or otherwise howsoever is admissible. Upon the happening of any such event causing delay, the Contractor shall immediately given notice thereof in writing to the Engineer-in-charge but shall nevertheless use constantly his best endeavour to prevent or make good the delay and shall do all that may reasonably be required to the satisfaction of the Engineer-in-charge to proceed with the work.

10. Patent Rights:

The Contractor shall fully indemnify B.H.E.L or the agent, servant, or employee of B.H.E.L against any action, claim or proceeding relating to infringement or the use of any patent or design or any alleged patent or design rights, and shall pay any royalties which may be payable in respect of any article / or part there of included in the contract.

In the event of any claims being made or action brought against B.H.E.L or any agent, or servant or employee of BHEL in respect of matters aforesaid the Contractor shall immediately be notified thereof for taking necessary action provided that payment of indemnity shall not apply when such infringement has taken place in complying with the specific directions issued by the BHEL but the Contractor shall pay any royalties payable in respect of any such use.

11. Octroi and Other Duties:

All charges on account of Octroi, Terminal or Sales Tax and/or other duties on material obtained for the work (excluding materials provided by B.H.E.L on payment) shall be borne by the contractor.

12. Royalties:

Royalties fixed from time to time as per prevalent local rules will be recovered for materials, which the Contractor may be allowed to remove from quarries situated on land which is in charge of the B.H.E.L authorities.

13. Plant and Equipment:

The Contractor, shall at his own expense, supply all tools, plant and equipment (here-in-after referred to as T & P) required for the execution of the contract other than those listed in Schedule 'C' which subject to their availability may be hired by B.H.E.L., to the Contractor or issued free for use in the execution of the work as specified in Tender Documents.

14. Assignment or Transfer of Contract:

The Contractor shall not, without the prior written approval of the Accepting Officer, assign or transfer the Contract or any part thereof, or any share, or interest therein to any other person. No sum of money which may become payable under the Contract shall be payable to any person other than the Contractor unless the prior written approval of the Accepting Officer to the assignment or transfer of such money is given.

14. (a) Sub Contract:

The Contractor shall not sub-let any portion of the Contract without the prior written approval of the Accepting Officer.

15. Compliance to Regulations and Bye Laws:

The Contractor shall conform to the provision of any statute relating to the work and regulations and bye-laws of any local authority and of any water and lighting Companies or Undertakings with whose system the work is proposed to be connected. He shall, before making any variation from the drawings or the specifications that may be necessitated for such connections give the Engineer–

in- charge notice, specifying the variation proposed to be made and the reasons there for and shall not carry out any such variation until he has received instructions from the Engineer-in-charge in respect thereof. The contractor shall be bound to give all notice required by Statute Regulations or Bye-laws as aforesaid and to pay all fees, and taxes payable to any authority in respect thereof.

CHAPTER III

PERFORMANCE OF THE CONTRACT

16. Security Deposit

16.1 Security Deposit should be collected from the successful tenderer. The rate of Security Deposit will be as below:

Upto Rs. 10 lakh	10%
Above Rs. 10 lakh upto Rs.50 lakh	1 lakh + 7.5% of the amount Exceeding Rs.10 Lakh
Above Rs. 50 lakh	4 lakh + 5 % of the amount exceeding Rs.50 Lakh

At least 50% of the security Deposit should be furnished before start of the work by the contractor in the form of Demand Draft / Bank Guarantee.

Security Deposit may be furnished in any one of the following forms :-

- i) Cash (as permissible under the Income Tax Act)
- ii) Pay Order, Demand Draft in favour of BHEL.
- iii) Local cheques of scheduled banks in the name of BHEL subject to realization.
- iv) Securities available from Post Offices such as National Savings Certificates, Kisan Vikas Patras etc. (Certificates should be held in the name of Contractor furnishing the security and duly pledged in favour of BHEL and discharged).
- v) Bank Guarantee from Scheduled Banks / Public Financial Institutions as defined in the Companies Act subject to a maximum of 50% of the total security deposit value. The balance 50% has to be remitted either by cash or in the other form of security. The Bank Guarantee format should have the approval of BHEL.
- vi) Fixed Deposit Receipt issued by Scheduled Banks / Public Financial Institutions as defined in the Companies Act . The FDR should be in the name of the contractor, A/C BHEL, duly discharged on the back.
- vii) Security deposit can also be recovered at the rate of 10% from the running bills. However in such cases at least 50% of the Security Deposit should be collected before start of the work and the balance 50% may be recovered from the running bills.
- viii) EMD of the successful tenderer shall be converted and adjusted against the security deposit.
- ix) The security deposit shall not carry any interest.

NOTE: Acceptance of Security Deposit against Sl. No. (iv) and (vi) above will be subject to hypothecation or endorsement on the documents in favour of BHEL. However, BHEL will not be liable or responsible in any manner for the collection of interest or renewal of the documents or in any other matter connected therewith.

All compensation or other sums of money payable by the Contractor to BHEL, under the terms of this Contract or under any other contract with BHEL, may be deducted from the Security Deposit or realized by the sale of the Securities or from the interest arising there from or from any sums which may be due or may become due to the Contractor payable by BHEL, on any account whatsoever against this Contract or any other Contract with BHEL, and in the event of his Security Deposit being reduced by reason of such deductions or sale as aforesaid, the Contractor shall, within seven days thereafter, make good in cash or in securities endorsed as aforesaid, any sum or sums by which the Security Deposit has been so reduced.

50% of the Security Deposit / may be refunded on completion of the work after payment of the final bill and the balance 50% of the Security Deposit is refundable only after the expiry of the maintenance period of six (6) months from the date of completion of work as stipulated in the Contract concerned.

17. Order under the contract

All orders, notices etc., to be given under the contract shall be in writing typescript or printed and if sent by registered post to the address given in the tender of the contractor, shall be deemed to have been served on the date when in the ordinary course they would have been delivered to him.

The contractor shall carry out without delay all orders given to him.

18. Admission to site

The Contractor shall not enter on (other than for inspection purposes) or take possession of the site unless permitted to do so by the Engineer-in-charge. The portions of the Site to be occupied by the Contractor will be clearly defined and marked on the site plan, and the Contractor will on no account be allowed to extend his operations beyond these areas.

The Contractor shall provide, if necessary or required at the Site, temporary access there to and shall alter, modify and maintain the same as required from time to time. He shall take out and clear away the access route when no longer required and restoring the area to its original condition.

The Engineer-in-charge shall have power to execute other works (whether or not connected with the work in the contract agreement) on the site contemporaneously with the execution of the original work and Contractor shall give reasonable facilities for this purpose.

B.H.E.L reserves the right of taking over, at any time, any portion of the site which they may require and the Contractor shall at his own expense clear such portion forthwith. No photographs of the Site or of the work or any part thereof shall be taken, published or otherwise circulated without the prior approval of the Engineer-in-charge.

No such approval shall however exempt the contractor from complying with any statutory provisions in regard to the taking and publication of such photographs.

B.H.E.L Officials connected with the Contract shall have the right of entry to the Site at all times.

Engineer - in charge shall have the power to exclude from the site any person whose admission there to may, in his opinion be undesirable for any reason whatsoever.

19. Contractor's Supervision

The Contractor shall either himself supervise the execution of the Contract or shall appoint a competent Agent approved by the Engineer-in-charge to act in his stead. The contractor shall employ an Engineer/Agent having at least a 'Degree of Bachelor of Civil Engineering' from a recognized University/on any work with a Contract value exceeding rupees two lakhs, and having at least a Diploma in civil Engineering from a recognised college, on work with a contract value exceeding Rs. 50,000/- but not exceeding rupees two lakhs.

The Employment of an Engineer/Agent as aforesaid shall not be necessary if the Contractor himself in possession of a recognized technical qualification and is in opinion of the Engineer-in-charge capable of receiving instructions of the Engineer-in-charge and of executing the work to the satisfaction of the Engineer-in-charge. If the Contractor fails to appoint a suitable Engineer/ Agent as aforesaid, the Engineer-in-charge shall have full powers to suspend the execution of work and stop payment of any advances that may have become due until such date as a suitable Engineer/Agent is appointed and the contractor shall be held responsible for the delay caused to the work and no extension of time on this account shall be given to him as stipulated in condition (9) above.

Orders given to the Contractor's Agent/Engineer shall be considered to have the same force as if they had been given to the Contractor himself.

The contractor or his Agent shall be in attendance at the site during all working hours and shall superintend the execution of work with such additional assistance in each trade as the Engineer-in - charge may consider necessary.

The contractor or his accredited agent shall attend when required and without making any claim for doing so, either the Office of the Engineer-in-charge or the work site to receive instructions.

The Engineer-in-charge shall have full powers, and without assigning any reason to require the Contractor immediately to cease to employ in connection with the Contract any Agent, servant or employee whose continued employment is, in his opinion undesirable.

The Contractor shall not be allowed any compensation on this account.

LABOUR

20. The Contractor shall employ labourer in sufficient numbers either directly or through sub-contractors to maintain the required rate of progress and of quality to ensure workmanship of the degree specified in the Contract and to the satisfaction of the Engineer-in-charge. The Contractor shall not employ in connection with the works any person who has not completed his fifteen years of age.

The Contractor shall furnish to the Engineer-in-charge at the intervals specified by him, a distribution return of the number and description by trades of the work people employed on the works. The Contractor shall also submit on the 4th and 19th of every month to the Engineer-in-charge a true statement showing in respect of the second half of the preceding month and the 1st half of the current month (i) the accidents that occurred during the said fortnight showing the circumstances under which they happened and the extent of damage and injury caused by them and (ii) The number of female workers who have been allowed maternity benefit as provided in the Maternity Benefit Act, 1961 or Rules made thereunder and the amount paid to them.

The Contractor shall pay to labour employed by him either directly or through sub-contractors wages not less than fair wages as defined in the Contractor's Labour Regulations.

The contractor shall in respect of labour employed by him either directly or through sub – contractors comply with or cause to be complied with Contractor's Labour Regulations in regard to all matters provided therein.

The Contractor shall comply with the provisions of the Payment of Wages Act 1936, Minimum Wages Act 1948, Employers liability Act 1938, Workmen's Compensation Act 1923, Industrial Disputes Act 1947, Maternity Benefit Act 1961 and Mines Act 1952, Contract Labour Regulation and Abolition Act 1970 or any modifications there of or any other law relating thereto and rules made thereunder from time to time.

The contractor shall be liable to pay his contribution and the employees' contribution to the State Insurance Scheme in respect of all labour employed by him for the execution of the contract, in accordance with the provision of " The Employees" State Insurance Act, 1948" as amended from time to time. In case the contractor fails to submit full details of his account of labour employed and the contribution payable, the Engineer-in-charge shall recover from the running bills of contractor an amount of contribution as assessed by him. The amount so recovered shall be adjusted against the actual contribution payable for Employees' State Insurance.

The Engineer-in-charge shall on a report having been made by an Inspecting Officer as defined in the Contractor's labour Regulations have the power to deduct from the moneys due to the Contractor any sum required or estimated to be required for making good the loss suffered by the worker or worker by reason of non-fulfillment of the Conditions of the Contract for the benefit of workers, non-payment of wages or of deductions made from his or their wages which are not justified by the terms of the Contract or non-observance of the said Contractor's Labour Regulations.

The Contractor shall indemnify the B.H.E.L against any payments to be made under and for observance of the Regulations aforesaid without prejudice to his right to claim indemnity from his sub-contractors.

In the event of the Contractor committing a default or breach of any of the provisions of the aforesaid Contractor's Labour Regulations, as amended from time to time or furnishing any information or submitting or filling any form / Register/Slip under the provisions of these Regulations which is materially incorrect then on the report of the Inspecting Officers as defined in the Contractor's Labour Regulation, the Contractor shall without prejudice to any other liability pay to the B.H.E.L a sum not exceeding Rs. 50/- as liquidated damages for every default breach or furnishing, making submitting, filling materially incorrect statement as may be fixed by the Engineer-in-charge and in the event of the Contractor's default continuing in this respect, the liquidated damages may be enhanced to Rs. 50/- per day for each day of default subject to a maximum percent of the estimated cost of works put to tender.

The Engineer in charge shall deduct such amount from bills or security deposit of the Contractor and credit the same to the Welfare Fund constituted under Regulations. The decision of the Engineer-in-charge in this respect shall be final and binding.

Model Rules for Labour Welfare

The Contractor shall at his own expense comply with or cause to be complied with Model Rules for Labour welfare as appended to these Conditions or rules framed by Government from time to time for the protection of health and for making sanitary arrangements for workers employed directly/or indirectly on the works. In case the Contractor fails to make arrangements as aforesaid, the Engineer-in-charge shall be entitled to do so and recover the cost thereof from the Contractor.

Safety Code

The Contractor shall at his own expense arrange for the safety provisions as appended to these conditions or as required by the Engineer – in – charge, in respect of all labour directly or indirectly employed for performance of the works and shall provide all facilities in connection therewith. In case the Contractor fails to make arrangements and provide necessary facilities as aforesaid, the Engineer– in–charge shall be entitled to do so and recover the cost thereof from the Contractor.

Failure to comply with model Rules for Labour Welfare, Safety Code, or the provisions relating to report on accidents and to grant of maternity benefits to female workers shall make the Contractor liable to pay to the B.H.E.L as liquidated damages an amount not exceeding Rs. 50/- for each default or materially incorrect statement. The decision of the Engineer-in-charge in such matters based on reports from the Inspecting Officers as defined in the Contractor's Labour Regulation as appended to these conditions shall be final and binding and deductions for recovery of such liquidated damages may be made from any amount payable to the Contractor.

WATER

21. The Contractor shall allow in his Tender and provide at his cost all water required for the work or his employees on the work, together with all pipes and fittings or other means that may be necessary or required to ensure a proper and ample supply of water for all purposes connected with the work.

Water will be supplied from the BHEL supply system, or other sources at one point fixed by the Engineer-in-charge on the site of work at free of cost. The Contractor shall make necessary arrangement for lifting pumping, carrying or conveying the water as required at his own cost.

22. Temporary Workshops, Stores Etc.

The Contractor shall, during the progress of the work provide, erect and maintain at his own expense all necessary temporary workshops, stores, offices, etc., required for the proper and efficient execution of the work. The planning, siting and erection of these buildings shall have the approval of the Engineer-in-charge and the Contractor shall at all times keep them tidy and in a clean and sanitary condition to the entire satisfaction of the Engineer-in-charge.

On completion of the work all such temporary buildings shall be cleared away and the site restored and left in a clean and tidy condition to the entire satisfaction of the Engineer-in-charge.

23. Stores and Materials on Site

All stores and materials required for the work are to be deposited by the Contractor only in places to be indicated by the Engineer-in-charge.

Where in accordance with the contract stipulations certain Stores & Materials (for incorporation in the work) are to be issued to the Contractor by the BHEL as detailed under Schedule 'B' **such items will be so issued only to the extent required for the actual completion of the work** as stipulated in the contract. The decision of the Engineer-in-charge regarding the quantities to be issued as above shall be final and binding on the contractor. For any excess quantities consumed on the work upto 5% over the theoretical consumption will be charged at issue rates and excess consumption beyond this limit, their cost will be recovered from the Contractor at punitive rates which will be 100% (Hundred Percent) more than the issue rates of the BHEL as specified in the Instructions to the Tenderers.

In regard to the materials and stores which may be issued to the Contractor by BHEL the Contractor shall give the Engineer-in-charge reasonable notice in writing of his requirements of such stores and materials and on the approval of his demand being notified to him, he shall make immediate arrangements for drawing the same. Such stores and materials shall be transported by the Contractor at his own expense direct from the place of issue to the site of the work, unless prior written approval is obtained from the Engineer-in-charge to take them to a Store or Workshop elsewhere.

The Contractor shall have to build a weather proof shed for the storage of cement required for 15 days consumption of the work.

BHEL Officers connected with the Contract shall have the power at any time to inspect and examine any stores or materials intended to be used in or on the work, whether on the site or at any factory or workshop or other place where such stores or materials are being fabricated or manufactured or at any place where the same are lying and the contractor shall give necessary facilities for such inspection and examination.

The Engineer-in-charge shall be entitled to have tests made of any stores or materials supplied by the Contractor who shall provide at his own expense all facilities which the Engineer-in-charge may require for this purpose. If at the discretion of the Engineer-in-charge an independent expert is employed to make any such tests his charges shall be borne by the Contractor only if the test discloses that the said stores or materials are not in accordance with the provisions of the Contract.

Should the Engineer-in-charge consider at any time during the construction or re-construction, on prior to the expiry of the "MAINTENANCE PERIOD" that the stores or materials provided by the Contractor are unsound or of a quality inferior to that contracted for or otherwise not in accordance with the contract (in respect whereof the decision of the Engineer-in-charge shall be final and conclusive) the Contractor, shall on demand, in writing from the Engineer-in-charge specifying the Stores or materials complained of, notwithstanding that the same may have been inadvertently passed, certified and paid for, forthwith remove the stores or materials so specified and provide other proper and suitable stores or materials at his own expense; to the entire satisfaction of the Engineer-in-charge and in the event of his failing to do so within a period to be specified by the Engineer-in-charge in his demand aforesaid the Engineer-in-charge may replace within others the stores or materials complained of at the risk and expense in all respects of the Contractor. The liability of the contractor under this condition shall not extend beyond the maintenance period aforesaid except as regards stores or materials which the Engineer-in-charge shall have previously given notice to the contractor to replace. (*MAINTENANCE PERIOD for any work under this Organisation will be SIX MONTHS FROM THE DATE OF ACTUAL COMPLETION of the particular work and handing over to B.H.E.L).

All stores and materials brought to the Site shall become and remain the property of B.H.E.L and shall not be removed from the site without prior written approval of the Engineer-in-charge. However, when the work is finally completed, the Contractor shall at his own expense forthwith remove from the site all surplus stores or materials originally supplied by him and upon such removal, the same shall revert in and become the property of Contractor. All B.H.E.L Stores and materials issued to Contractor for in-corporation or fixing in the work and which, making due allowance for reasonable wear and tear/or waste, have not on completion of the work been so incorporated or fixed, shall be returned by the Contractor at his own expense to the place of issue.

Credit for surplus stores and/ or materials returned by the contractor to B.H.E.L will be given to him at a price based on the prevailing market rate but not exceeding that at which the said stores and materials were originally issued to him but due consideration shall be given to the allowance claimed by B.H.E.L in respect or any depreciation or damage suffered by the stores and/or materials whilst in the custody of the Contractor regarding which the decision of Engineer-in-charge shall be final and conclusive.

If, in the opinion of the Engineer-in-charge (which shall be final and conclusive) any stores, supplied by B.H.E.L have either during currency of the work or after completion of the work whilst under the custody of the Contractor, become damaged to such an extent that they cannot be usefully utilized, either in the same work or in other works, the Engineer-in-charge shall not accept the stores and in the event of his rejection the contractor shall be charged for the said Stores at a rate as fixed by the Accepting Officer. The Contractor shall not be entitled to any claim whatsoever on this account.

24 Tools and Plants on site:

All tools, plants and equipment brought to the site shall become the property of B.H.E.L and shall not be removed from the site without the prior written approval of the Engineer-in-charge when the work is finally completed or the Contract is determined for reasons other than the default of the Contractor he shall forthwith remove from the site all tools, plants, equipments etc., (other than those as may have been provided by B.H.E.L) and upon such removal, the same shall in, and become the property of the Contractor.

25. Statement of Hire Charges:

A monthly detailed statement of the hire charge incurred in respect of B.H.E.L tools, plants, equipments etc., shall be given to the Contractor by the Engineer-in-charge.

26. Precaution Against risks:

The Contractor shall be responsible for providing at his own expense, for all precautions to prevent loss or damage from any and all risks and to minimize the amount of any such loss or damage and for the necessary steps to be taken for the said purpose until the works have been handed over complete in all respect of the Engineer-in-charge.

The Contractor shall provide all watchmen necessary for the protection of the site, the work, the materials, tools, plants, equipments and anything else lying on the Site during the progress of the work. He shall be solely responsible for and shall take all reasonable and proper steps for protecting, securing, lighting and watching, all places on or about the work and the Site which may be dangerous to any person whomsoever.

27. Notices and Fees:

The Contractor shall give all notices required by any Statutory provision or by the regulations and/or bylaws of any local Authority and/or of any Public Service, Company or Authority affected by the work or with whose system the same are or will be connected. The Contractor shall pay and indemnify B.H.E.L against any fees and charges payable under such Acts. Regulation and/or bylaws in respect of the work and shall make and supply all drawings and plans required in connection with any such notice.

28. Setting out of the Works and Protective and Maintaining Signals and Works:

The Engineer-in-charge shall supply dimensioned drawings, levels and other information necessary to enable the contractor to set out the work. The Contractor shall at his own expense set accurately according to the drawings and figured dimension thereon, all the work comprised in the contract and any extras or additions there-to and shall be solely responsible for their being so set out and executed. All bench marks, pegs, signals on the surface, alignment stones, milestones and all similar marks whether put in by B.H.E.L Authorities for the purpose of checking the Contractor's work or in the nature of permanent survey marks will during the tenure of the contract, be under the care of the Contractor who shall, at his own expense, take, all proper and reasonable precautions and care to preserve and maintain them in their true position. In the event of these marks being disturbed or obliterated by accident or due to any other cause whatsoever, the same may, if deemed necessary, be replaced by the Engineer-in-charge at the Contractor's expense and the cost thereof deducted from any money then or thereafter becoming due to the Contractor.

Where requested by the Contractor, the level marks, center line and chainage pegs corresponding to those shown on the Drawing will be pointed out to the Contractor on the ground but all bench marks or chainage pegs additional to those shown on the Drawing will be set out by BHEL authorities.

29. Site Drainage:

All water that may accumulate on the site during the progress of the work or in trenches and excavations shall be removed to the entire satisfaction of the Engineer-in-charge and at Contractor's expense.

30. Excavations, Relics Etc.

Material of any kind obtained from excavation on the site shall remain the property of BHEL and shall be disposed off as Engineer-in-Charge directs.

All gold, silver, oil and other minerals of any description and all precious stones, coins, treasures, relics, antiques and other similar items which may be found in or upon the site shall be the property of Bharat Heavy Electricals Limited and the Contractor shall duly preserve the same to the satisfaction of the BHEL and shall from time to time deliver the same to such person or persons as the B.H.E.L may appoint to receive the same.

31. Foundations

The Contractor shall not lay any foundations until the excavations for the same have been examined and approved in writing by the Engineer-in-charge.

32. Covering-in Work

The Contractor shall give reasonable notice in writing to the Engineer-in-charge whenever any work is to be permanently covered up or concealed, whether by earth or other means so that it can finally be inspected or measured if necessary. In default of so doing, the Contractor shall, if required by the Engineer-in-charge uncover such work at his own expense.

33. Approval of works by Stages:

All work embracing more than one process shall be subject to examination and approval at each stage thereof and the Contractor shall give due notice in writing to the Engineer-in-charge when each stage is ready. In default of such notice being received, the Engineer-in-charge shall be entitled to approve the quality and extent thereof at any time he may choose and in the event of any dispute, the decision of the Engineer-in-charge thereon shall be final and conclusive.

34. Execution of the Work:

The work shall be executed in a workman-like manner and to the satisfaction in all respects of the Engineer-in-charge.

The Engineer-in-charge will communicate or confirm his instructions to the Contractor in respect of the execution of the Work in a "Work Site Order Book" maintained at his office and the Contractor shall visit this office daily and shall confirm receipt of such instructions by signing the relevant entries in this book. Such entries will rank as order or notices in writing within the intent and meaning of these conditions.

35. Day Work:

No day-work shall be performed without the prior written instructions of the Accepting Officer.

The Contractor shall give to the Engineer-in-charge reasonable notice of the start of any work ordered to be executed by day-work and shall deliver to the Engineer-in-charge within two days of the end of each pay week a return in duplicate giving full detailed accounts of labour and materials for that pay-week. One copy of each of these returns, if found correct, will be certified by the Engineer-in-charge and returned to the contractor and must be produced at the time of adjustment of accounts.

An invoice in duplicate signed by the Contractor or his agent shall be sent with each delivery of materials for day-work and the Contractor will be furnished with a receipt signed by the Engineer-in-charge specifying the description, quantities weight or measurement (as the case may be) of the articles approved, reference will be made in this receipt in the return aforesaid and the Contractor's Bill.

In the case of Lumpsum Contracts, the rates to be charged and the percentage addition for profit and establishment charges, etc., will be agreed upon between the Accepting Officer and the Contractor prior to the execution of the work.

36. Inspection of the Work:

B.H.E.L Officers concerned with the Contract shall have power at any time to inspect and examine any part of the work and the Contractor shall give such facilities as may be required to be given for such inspection and examination Should Engineer-in-charge consider, at any time during the expiry of the

maintenance period, that any work has been executed with unsound, imperfect or unskilled workmanship or of a quality inferior to that contracted for or not otherwise in accordance with the contract (in respect) whereof the decision of the Engineer-in-charge shall be final and conclusive the Contractor shall on demand in writing from the Engineer-in-charge specifying the fault notwithstanding that the same may have been inadvertently passed, certified and paid for, forthwith rectify or remove and reconstruct the work so specified in whole or in part as the case may be required at his own expense to the entire satisfaction of the Engineer-in-charge and in the event of his failing to do so within a period to be specified by the Engineer-in-charge in his demand as aforesaid, the Engineer-in-charge may carry out the work by other means at the risk and expense in all respects of the Contractor. However, the liability of the Contractor under this condition shall not extend beyond the maintenance period except as regards workmanship which the Engineer-in-charge shall have previously given notice to the Contractor to rectify.

37. Responsibility for Building:

In the event of any building or part of any building being handed over to the Contractor for the execution of work thereto under the provisions of the Contract, he shall give a written receipt for all fixtures, glass etc. and he shall be required to make good at his own expense all damages resulting from any cause whatsoever while in his charge and on completion of the work to deliver the said building or part thereof in a clean state complete in every particular to the entire satisfaction of the Engineer-in-charge.

38. Insurance

The contractor shall within one month after the date of the acceptance of the contract, insure the work against loss or damage to the contract works, temporary work and materials erected in performance of the contract on "all risks" basis from the time of arrival on site until taken over by BHEL on completion of the contract.

The cover shall also include wherever necessary the risks of testing including breakdown or explosion of plant and machinery undergoing testing, trial and commissioning operations. The insurance shall also specifically cover removal of debris cost. The sum insured shall represent the estimated full value of the contract works inclusive of value of free supply materials by BHEL, transport charges, customs dues, express freight, overtime charges, cost of erection, value of constructional plants and machinery, removal of debris and escalation of costs where the contract includes a maintenance period, the insurance cover shall specifically include the contractors' liabilities during the maintenance period. The insurance shall also be extended to cover third party personal injury and property damage for a sum to be specified by BHEL. The insurance shall be effected in the name of BHEL and the contractor shall submit to BHEL a draft of the insurance policy for approval. The policy when issued will be lodged with BHEL together with receipts of premium for such insurance and the contractor shall maintain such policies in force until the obligations of the contractor are fully discharged.

If the contractor fails to comply with the terms of this condition the Accepting officer may insure the work and may deduct the amount of premiums from any money that may become payable to the contractor or may at his discretion refuse payment of any advances to the contractor until the contractor shall have complied with the terms of this condition. This provision does not, however, absolve the contractor of his responsibility for taking up the insurance. The contractor is, therefore, primarily responsible for taking up the insurance in time.

39. Damage and loss to private property and injury to workmen

The contractor shall at his own expense reinstate and make good to the satisfaction of the Engineer-in-charge and pay compensation for any injury, loss or damage occasioned to any property or rights whatever including property and rights of **B.H.E.L.**, (or agents, servants or employees of **B.H.E.L.**) the injury loss or damage arising out of or in anyway in connection with the execution or purported execution of the contract and further the contractor shall indemnify B.H.E.L, against all claims enforceable against B.H.E.L, or any agent, servant, or employee of B.H.E.L a private person, in respect of any such injury (including injury resulting in death loss or damage to any person) whosoever or property, including all claims which may arise under the workmen's Compensation Act or otherwise, or which would be enforceable against B.H.E.L.

40. Completion

The works shall be completed to the entire satisfaction of the Engineer-in-charge and in accordance with the Contractor's forecast of Time and Progress where operative, and all unused stores and materials, tools, plants, equipments, temporary buildings and things shall be removed and the site and work cleared of rubbish and all waste materials and delivered up clean and tidy to the satisfaction of the Engineer-in-charge at the Contractor's expense and/or before the Scheduled date of completion.

The B.H.E.L shall have power to take over from the Contractor from time to time each sections of the work as have been completed to the satisfaction of the Engineer-in-charge.

In case the Contractor fails to remove any of his properties, assets or fails to clear the rubbish and waste materials within 30 days of the completion of the contract, it is lawful for the contractee, that is BHEL to take such action as it deems fit to clear dispose of such properties, assets or such waste materials and charge the contractor any expenses incurred thereon.

The Engineer-in-charge shall certify to the Contractor the date on which the work is completed and the state thereof.

The Engineer-in-charge shall also certify to the Contractor the state of the work at the end of maintenance period, where applicable.

41. Compensation for Delay:

If the contractor fails to maintain the required progress in terms of condition 7 or to complete the work and clear the site on or before the contracted or extended period of completion, he shall, without prejudice to any other right or remedy of the B.H.E.L on account of such breach, pay as agreed compensation an amount calculated as stipulated below or such smaller amount as may be fixed by the BHEL on the contract value of the work for every week that the progress remains below that specified in condition 7 or that the work remains incomplete.

This will also apply to items or group of items for which separate period of completion has been specified.

For this purpose the term 'Contract Value' shall be the value at contract rates of the work as ordered.

- a. Completion period (as originally-stipulated) -- at 1 percent per week.
Not exceeding 6 months.

- b. Completion period (as originally-stipulated) -- at ½ percent per week
Exceeding 6 months and not exceeding 2 years.
- c. Completion period (as originally-stipulated) -- at ¼ percent per week
Exceeding 2 years.

Provided always that the total amount of compensation for delay to be paid under this condition shall not exceed the under noted percentage of the contract value or of the contract value of the item or group of items of work for which a separate period of completion is given:

- a. Completion period (as originally-stipulated) -- 10 percent.
Not exceeding 6 months.
- b. Completion period (as originally-stipulated) -- 7½ percent.
Exceeding 6 months and not exceeding 2 years.
- c. Completion period (as original-stipulated) -- 5 percent.
Exceeding 2 years

The amount of compensation may be adjusted or set-off against any sum payable to the Contractor under this or any other contract with the B.H.E.L.

42. Laws Governing the Contract:

This contract shall be governed by the Indian Laws for the time being inforce.

43. Cancellation of Contract for Corrupt Acts:

The Accepting Officer, whose decision shall be final and conclusive, shall, without prejudice to any other right or remedy which shall have accrued or shall accrue thereafter to Bharat Heavy Electricals Limited, cancel the contract in any of the following cases and the Contractor shall be liable to make payment to B.H.E.L for any loss or damage resulting from any such cancellation for default.

If the Contractor shall:

- a. Offer or give or agree to give to any person in BHEL service any gift or consideration of any kind as an inducement or reward for doing or for bearing to do or for having done or forborne to do a day act in relation to the obtaining or execution of this or any other contract for BHEL service **OR**
- b. Enter into a contract with B.H.E.L in connection with which commission has been paid or agreed to be paid by him or with his knowledge, unless the particulars of any such commission and the terms of payment thereof have previously been disclosed in writing to the Accepting Officer, **OR**
- c. Obtain a contract with B.H.E.L as a result of ring tendering or by non-bonafide methods of competitive tendering without first disclosing the fact in writing to the Accepting Officer.

44. Cancellation of Contract for Insolvency, Assignment or Transfer or Sub-Letting of Contract:

The Accepting Officer, without prejudice to any other right or remedy which shall accrue thereafter to B.H.E.L shall cancel the contract in any of the following cases:

- If the Contractor,
- a) Being an individual, or if a firm any partner thereof shall at any time be adjudged bankrupt or have a receiving order or orders for administration of his Estate made against him or shall take any proceedings, for liquidation or composition under any Bankruptcy Act for the time being in force or make any conveyance or assignment of his effects of composition or arrangement for the benefit of his creditor or purport to do so, or if any application be made under any Bankruptcy Act for the time being in force for the sequestration of his Estate or if a trust deed be granted by him on behalf of his creditors, OR
 - b) Being a Company, shall pass a resolution or the Court shall make an order for the liquidation of its affairs, or a Receiver or Manager on behalf of the debentures holders shall be appointed or circumstances shall arise which entitle the court or debentures holders to appoint a Receiver or Manager **OR**.
 - c) Assigns, transfers, sub-lets or attempts to assign, transfer or sub-let any portion of the work without the prior written approval of the Accepting Officer. **OR**
 - d) Shall suffer an execution being levied on his goods and allow it to be continued for a period of 21 days.

Whenever the Accepting Officer exercises his authority to cancel the Contract under this condition, he may complete the work by any means at the Contractor's risk and expense provided always that in the event of cost of the completion (as certified by Engineer-in-charge which is final and conclusive) being less than the contract cost, the advantage shall accrue to the BHEL and that if the cost of completion exceeds the money due to the Contractor under the contract, the Contractor shall either pay the excess amount ordered by the Engineer-in-charge or the same shall be recovered from the Contractor by other means.

Engineer-in-charge will have powers to take possessions of the site and any materials, constructional plant, implements, stores, etc, thereon and or carryout the work by any means at the risk and cost of the contractor.

In case the BHEL completes the work under the provisions of this condition the cost of such completion to be taken into account in determining the excess cost to be charged to the contractor under this Condition shall consist of the cost of materials purchased and/or labour provided by the BHEL with an addition of such percentage to cover superintendence and establishment charges as may be decided by the Project Manager/Project Engineer whose decision shall be final and conclusive.

If the contractor fails to pay the excess sum within a period of 30 days, the Engineer-in-charge shall have the right to sell any or all of the contractor's unused materials, constructional plant implements, temporary buildings, etc., and apply the proceeds of sale thereof towards the satisfaction of any sum due from the contractor under the contract and if thereafter be any balance outstanding from the contractor, it shall be recovered in accordance with the provisions of the contract.

45. Cancellation of contract in part or in full for contractor's default:

If the Contractor:

- (a) makes default in commencing the work within a reasonable time from the date of handing over of the site and continue in that state after a reasonable notice from Engineer-in-charge, OR

- (b) in the opinion of the Engineer-in-charge at any time, whether before or after the date or extended date for completion, makes default in proceeding with the work, with due diligence and continue in that state after a notice of seven days from Engineer-in-charge, OR
- (c) fails to comply with any of the terms and conditions of the contract or after 7 days notice in writing with orders properly issued there under, (OR)
- (d) fails to complete the work order and items of work individual dates for completion and clear the site on or before the date of completion or fails to achieve the progress as set out under clauses 7 of these General Conditions of Contract.

The Accepting Officer may, without prejudice to any other right or remedy which shall have accrued or shall accrue there after to B.H.E.L cancel the contract as a whole or in part thereof or only such work order or items of work in default from the contract. Whenever the Accepting Officer exercises his authority to cancel the contract as a whole or in part under this conditions he may complete the work at the Contractor's risk and cost, provided always that in the event of the cost of completion (as certified by Engineer-in-charge which is final and conclusive) being less than the contract cost the advantage shall accrue to the B.H.E.L if the cost of completion exceeds, the money due to the contractor under this contract, the contractor shall either pay the excess amount ordered by Project Manager or the same shall be recovered from the contractor by other means. Engineer-in-charge will have power to take possession of the site and any materials, constructional plant, implements, Stores, etc., thereon.

In case the B.H.E.L completes the work or any part thereof under the provisions of this conditions the cost of such completion to be taken in to account in determining the excess cost to be charged to the contractor under this conditions shall consists of the cost of materials purchased and/or labour provided by the B.H.E.L with an addition of such percentage to cover superintendence and establishment charges as may be decided by the Project Manager/Engineer whose decision shall be final and conclusive.

If the contractor fails to pay the excess sum within a period of 30 days, the Engineer-in-charge shall have the right to sell any or all of the contractor's unused materials, constructional plant implements, temporary buildings, etc, and apply the proceeds of sale thereof towards the satisfaction of any sum due from the contractor under the contract and if thereafter be any balance outstanding from the contractor it shall be recovered in accordance with the provision of the contract.

46. Termination of Contract for Death

Without prejudice to any of the rights or remedies under this contract if the contractor dies, the accepting Officer shall have the opinion of terminating the contract without compensation to the contractor.

47. Special Powers of Determination

If at any time after the acceptance of the tender B.H.E.L shall for any reason whatsoever not require the whole or any part of the work, to be carried out the project Manager/Engineer shall give notice in writing of the fact to the Contractor who shall have no claim to any payment of compensation or otherwise howsoever on account of any profit or advantage which he might have derived from the execution of the work in full but which he did not derive in consequence of the foreclosing of the work.

He shall be paid at Contract rates, for the full amount of the work executed including such additional works, e.g. clearing of site, etc., as may be rendered necessary by the said fore closing. He shall also be allowed a reasonable payment (as decided by the Accepting Officer) for any expenses sustained on account of labour and materials collected but which could not be utilised on the work, as verified by the Engineer-in-charge. Neither shall the Contractor have any claim for compensation on account of any alterations having been made in the original specifications, drawings, designs and instructions, involving any curtailment of the work as originally contemplated.

48. Fair Wage

- a) The contractor shall pay not less than the “ Fair Wage” to labourers engaged by him on the work.

“Fair Wage” means wage whether for time or piece work notified at the time of inviting tenders for the work and where such wages have not been notified the wages prescribed by the Project Manager/Engineer for the stations at which the work is done.

- b) The Contractor shall not with standing the provision of any contract to the contrary, cause to be paid a “Fair Wage” to labourers indirectly engaged on the work, including any labour engaged by the Sub-Contractors in connection with the said work, as if the labourers had been directly employed by him.
- c) In respect of labourers directly or indirectly employed on the work for the performance of the Contractors part of this Agreement, the Contractor shall comply with or cause to be complied with B.H.E.L Contractor's Labour Regulations (appended here to as Annexure 'A' to these conditions) in regard to payment of wages, wage period deduction from wages, recovery of wages not paid and deductions unauthorisedly made, maintenance of wage book, wage-slips publication of scale of wage and other terms of employment inspection and submission of periodical returns and all other matters of alike nature.
- d) The Engineer-in-charge concerned shall have the right to deduct from the money due to the contractor any sum required or estimated to be required for making good the loss suffered by a worker or workers by reason of non-fulfilment of the conditions of the contract for the benefit of the workers non-payment of wages or of deductions made from his or their wages which are not justified by the terms of the contract or non-observance of the regulations.
- e) The Contractor shall be liable primarily for all payments to be made under the contract and for the observance of the Regulations aforesaid without prejudice to his right to claim indemnity from his sub-contractors.
- d) The regulations aforesaid shall be deemed to be a part of this contract and any breach thereof shall be deemed to be a breach of this Contract.

CHAPTER IV

VALUATION AND PAYMENT

49. Records and Measurements:

All items having a financial value shall be entered in the B.H.E.L Measurement Book so that a complete record is obtained of all works performed under the Contract.

Buildings, etc., priced in Schedule 'A' as a unit lumpsum will be entered by number at the unit lumpsum.

Work carried out for agreed lumpsum will be described and similarly recorded.

Lumpsum omissions will be entered for deduction. Measurement shall be restricted to that required to ascertain the financial liability of B.H.E.L under the contract.

Work which fails to be measured in detail shall be measured physically, without reference to any local custom that may obtain excepting where it may otherwise be directed in the tender documents. The measurements shall be taken jointly by any person duly authorized on the part of the BHEL and by the Contractor.

The Engineer-in-charge shall give reasonable notice in writing to the Contractor of appointment for measurement.

The Contractor shall, without extra charge, provide assistance with appliance and other things necessary for measurement.

The Contractor shall bear all the cost of measurement of his work.

Measurement shall be entered in the B.H.E.L Measurement Book and signed and dated by both parties each day at the Site on completion of measurement. If the Contractor objects to any of the measurements recorded on behalf of the B.H.E.L a note to that effect will be made in the BHEL Measurement Book or against the item or items objected to; and such note shall be signed and dated by both the parties engaged in taking the measurement.

If, as a result of such objection, it becomes necessary to re-measure the work wholly or in part, the expense of such re- measurement shall be borne by the party requiring the measurement.

Measurement to be re-taken, provided that a net error is found by this remeasurement to amount to less than 5% (five percent) of the value as recorded by the first measurement. But, where the net errors amount to 5% and over of the said value, then the cost is to be borne by the other party. In any case, if the net value of errors found exceeds Rs. 500/- the expense of re-measurement is to be borne by the other party. If the Contractor's representative fails to attend when required, the Engineer-in-charge shall have power to proceed by himself to take measurement and in that case these measurements shall be accepted by the Contractor as final.

The contractor shall, once every month, submit to the Engineer-in-charge with a copy to the Civil Manager/Senior Engineer details of his claims for the work done by him up to and including the previous month which are not covered by his Contract Agreement in any of the following respects;

- a. Deviation from the items and Specifications provided in the contract documents.
- b. Extra Items/New Items of work
- c. Quantities in excess of those provided in the contract schedule.
- d. Items in respect of which rates have not been settled. He should, in addition furnish a clear certificate to the effect that the claims submitted by him as aforesaid cover all his claim and that no further claims shall be raised by him in respect of the work done up to and including the period under report.

Except where any general or detailed description of the work in quantities expressly shows to the contrary, schedule of quantities shall be deemed to have been prepared and measurements shall be taken in accordance with

the procedure set forth in the schedule of rates specification notwithstanding any provision in the relevant standard method of measurement or any general or local custom. In the case of items which are not covered by the schedule of rates / specification, measurements shall be taken in accordance with relevant standard method of measurement issued by the Indian Standard Institution or as per standard engineering practice.

50. Valuation of Deviations:

Rates for deviated items of work will be fixed as follows:-

1. For any item of work required to be carried out after the contract has been awarded and which is not covered by Contractor's Schedule but is covered by B.H.E.L Schedule of rates the rate payable for such a fresh item will be derived from B.H.E.L Schedule by the method of proportion as follows:
 - a. In the same proportion to rate in B.H.E.L Schedule of Rates as the tendered rate for the nearest analogous item of work in Contractor's schedule bears to rate for the particular analogous item of work in B.H.E.L Schedule of rates.
 - b. If a single appropriate analogous item of work is not available in both Schedule (Contractor's and B.H.E.L Schedule) then the method of proportion will be applied to the nearest analogous group of items available in both the Schedules referred to i.e. in the same proportion as the total tendered cost of that particular group of items (the sum of the products of the tendered rates and the quantities for which orders are placed bears to the total cost of the same items and quantities at the B.H.E.L Schedule of Rates.
 - c. If even an appropriate analogous group of items is not available in Contractor's Schedule and B.H.E.L Schedule, then the methods of proportion will be applied to all those items of the whole work, which are available in both the Schedules and for which orders have been placed on the contractor, i.e., in the same proportion as the total cost of all these items of work (the sum of the products of the tendered rates and the quantities for which orders are placed) bears to the total cost of the same items and qualities at the B.H.E.L Schedule of Rates.
- II. If any work not covered by any of the foregoing is ordered on the Contractor, the basis of payment shall be decided by the Accepting Officer whose decision shall be final and conclusive and binding on the parties.

The selection of analogous items or analogous group of items referred to above shall be done by the Engineer-in-charge. Where the rates for deviated items or new items of work can be derived by the selection of different analogous items or analogous group of items, the lowest of all such derived rates shall be taken as the correct rate.

In the case of the contracts for which the Engineer-in-charge is the Accepting Officer, all disputes regarding the settlement of rates of deviated or new items or work shall be referred to the Deputy Manager/Manager whose decision shall be final and conclusive as the case may be.

51. Reimbursement / Refund on Variation in Price, Materials:

If after submission of the tender and/or during the progress of the works, the price of any material (not being a material supplied from the B.H.E.L store in accordance with the Conditions of the Contract) is increased or decreased by an Act of Legislature (Central or State) and/or any notification there under or on account of new duties or levies such as octroi or on account of increase or decrease in such duties affecting the price of materials required for incorporation

in the works and made from materials of which the price has increased or decreased as aforesaid and the Contractor has thereupon to pay in respect of such material or item a price which is higher or lower than the price of that material or item as prevailing immediately before the passing of such Act or levying, increasing/ decreasing of such duty, the B.H.E.L shall in case of increase in price or the duty reimbursed to the contractor and in case of decrease in price, the B.H.E.L shall be entitled to a refund of the reduction price or the reduction in duty. Provided, however no reimbursement or refund shall be made if the increase/decrease is not more than 10% of the said price, and if so, the reimbursement or refund shall be made only on the excess over 10% provided always that any such increase shall not be payable if, in the opinion of the Deputy Manager/Manager (whose decision shall be final and conclusive) the increase is attributable to the delay in the execution of the contract within the control of the contractor or that any such increase has become operative after the contracted/or extended date of completion of the work or items of work in question.

The Contractor shall, for the purpose of this condition, keep such books of account and other documents as are necessary to show the amount of any increase claimed or any reduction available and shall allow inspection of the same by any duly authorized representative of the B.H.E.L and further shall at the request of the Engineer-in-charge furnish for verification such other information of the Engineer-in-charge may require.

The Contractor shall within a reasonable time of his becoming, aware of any alteration in the prices of any such materials, give notice thereof in writing to the Engineer-in-charge stating that the rate is submitted in pursuance to this condition together with all information relating thereto which he may be in a position to supply.

52. Advances on Account:

No payment shall be made for work estimated to cost less than Rupees **FIVE THOUSAND** till the whole of the work shall have been completed and a certificate of completion given by the Competent Authority.

In the case of work estimated to cost more than Rupees **FIVE THOUSAND** the contractor may at intervals of not less than one month or as otherwise provided for in the Contract Documents, counting from the date on which order to commence work is given by Engineer-in-charge submit claims on B.H.E.L forms for payment of advances on account of work done and of materials delivered in connection with the Contract.

The contractor shall be paid in respect of such claims to the extent approved and passed by the Engineer-in-charge subject a maximum of 90% of the value of the work actually executed to the satisfaction of the Engineer-in-charge. The certificate of the Engineer-in-charge regarding such approval and passing of the sums so payable shall be final and conclusive against the Contractor.

“After the full amount of Security Deposit is made up through the 10% deduction from On account” bills, 100% payment of all subsequent bills may be made to the Contractor.

The Contractor may also be paid during the progress of the work 75% of the value of any materials which are in the opinion of the Engineer-in-charge in accordance with the Contract, and are actually required for incorporation in the work and which have reasonably been brought to the site in connection therewith and are adequately stored and / or protected against damage by weather or other causes, but which have not at the time of payment of the

advance been incorporated in the work on furnishing a formal hypothecation deed. Payment of such advances, however, shall be purely at the discretion of the Deputy Manager/Senior Engineer provided always that payments shall not be made under these periodical certificates in respect of perishable materials like lime, cement, timber, sand, kankar, etc., Any sums/due from the Contractor on account of Tools and Plant, Stores or any other items provided by B.H.E.L shall be deducted from the respective advances, the Engineer-in-charge shall from time to time certify the sums payable to the contractor after retaining the reserves.

Any certificate relating to work done or materials delivered may be modified or corrected by any subsequent interim certificate or by the final certificate and no certificate of the Engineer-in-charge supporting an advance payment shall itself be conclusive evidence that any work or materials to which it relates are in accordance with the contract. All such intermediate payments shall be regarded as advances against the final payment only and shall not be considered as an admission of the due performance of the contract or any part thereof in any respect or the accruing of any claim whatsoever.

Such intermediate payment shall not conclude, determine or affect in any way the powers of the Engineer-in-charge as to the final settlement and adjustment of the accounts or otherwise, or in any way vary or affect the contract.

53. Final Bill

As soon as possible after the completion of the work to the satisfaction of the Engineer-in-charge, the contractor shall forward a certified final account on BHEL form, in duplicate.

It shall be accompanied by all abstracts, vouchers etc., in support thereof and shall be prepared in the manner prescribed by the Engineer-in-charge.

No claims will be entertained after the receipt of the final bill.

The Contractor shall be entitled to be paid the final sum less the value of payments already made on account subject to certification of the final bill by the Engineer-in-charge. Any sums due from the contractor on account of Tools & Plant, Stores or any other items provided by BHEL not yet recovered from the contractor shall be deducted from the final sum aforesaid.

No charge shall be allowed to the Contractor on account of the preparation of the final bill.

54. Payment of Bills

All payment to be made to the Contractor under this contract shall be by "Crossed Cheque" marked 'A/C payee only (Within a reasonable time after the Certification by the Engineer-in-charge) at the State Bank of India or their subsidiaries located in the station where either the work is executed or service rendered or at their branch nearest to the station where the Officer of the Engineer-in-charge is located.

55. Recovery from Contractor:

Whenever under the contract any sum of money shall be recoverable from or payable by the contractor the same may be deducted from any sum then due or which at any time thereafter may become due to the Contractor under the contract or under any other Contract with BHEL or from his Security Deposit or he shall pay the claim on demand.

56. Post Technical Audit of Work and Bills:

BHEL reserves the right to carry out a post-payment audit and technical examination of the work and final bill including all supporting vouchers, abstracts etc., and to enforce recovery of any sums becoming due as a result thereof in the manner provided in the preceding sub-paragraphs provided however that no such recovery shall be enforced after three years of passing the final bill.

57. Refund of Security Deposit:

50% of the Security Deposit mentioned in condition 16 above, may be refunded to the contractor in respect of all contracts on completion of work and after payment of final bill and the balance 50% on expiry of the maintenance period, (described under clause 23) provided the contractor shall have rendered a "No-Demand" Certificate. In case of works where maintenance period is not involved 100% of the Security Deposit may be refunded after payment of final bill provided that the contractor shall have rendered a "No-Demand Certificate".

58. Arbitration:

Except where otherwise provided for in the contract all questions and disputes relating to the meaning of the specifications, designs, drawings and instructions hereinbefore mentioned and as to the quality of workmanship or materials used on the work or as to any other question, claim, right, matter or thing whatsoever in any way arising out of or relating to the contract, designs, drawings, specifications, estimates, instructions, orders or these conditions or otherwise concerning the work or failure to execute the same whether arising during the progress of the work or after the completion or abandonment thereof shall be referred to the sole arbitration of the Executive Director / General Manager of BHEL and if ED is unable or unwilling to act, to the sole arbitration of some other person appointed by the ED / General Manager, willing to act as such arbitrator. The cases referred to arbitration shall be other than those for which the decision of the Manager / Senior Engineer / Engineer-in-charge is expressed in the contract to be final and conclusive. There will be no objection if the arbitrator so appointed is an employee of B.H.E.L and that he had to deal with the matters to which the contract relates and that in the course of his duties as such he had expressed views on all or any of the matters in dispute or difference.

The arbitrator to whom the matter is originally referred being transferred or vacating his office or being unable to act for any reason, such Executive Director / General Manager as aforesaid at the time of such transfer, vacation of office or inability to act, shall appoint another person to act as arbitrator in accordance with the terms of the contract. Such person shall be entitled to proceed with the reference from the stage at which it was left by his predecessor.

Subject as aforesaid the provision of the Arbitration & Reconciliation Act, 1996 or any statutory modification or re-enactment thereof and the rules made there under and for the time being in force shall apply to the arbitration proceeding under this clause.

It is a term of the contract that the party involving arbitration shall specify the dispute or disputes to be referred to arbitration under this clause together with the amount or amounts claimed in respect of each such dispute.

The arbitrator(s) may from time to time with consent of the parties enlarge the time for making and publishing the award.

The work under the Contract shall, if reasonably possible, continue, during the arbitration proceedings and no payment due or payable, to the Contractor shall be withheld on account of such proceeding.

The Arbitrator shall be deemed to have entered on the reference on the date he issues notice to both the Parties fixing the date of first hearings.

The arbitrator shall give a separate award in respect of each dispute or difference referred to him.

The venue of arbitration shall be such place as may be fixed by the Arbitrator in his sole discretion.

The award of the arbitrator shall be final, conclusive and binding on all parties to this contract.

In the event of disputes or differences arising between one public sector enterprise and a Govt. Department or between two public sector enterprises the above stipulations shall not apply the provisions of BPE office memorandum No. BPE/CL 001/ 76MAN / 2 (1.10) 75-BPE (GM-1) dated 1st January 1976 or its amendments for arbitration shall be applicable.

ANNEXURE 'A'

B.H.E.L CONTRACTOR'S LABOUR REGULATIONS (See condition 20)

1. Definition:

In these regulations, unless otherwise expressed or indicated, the following words and expressions shall have the meaning hereby assigned to them.

- a) "Labour" means workers employed by a contractor directly, or indirectly through a sub-contractor, or by an agent on his behalf on a payment not exceeding Rs.500 per month.
- b) "Fair Wage" means wages, which shall include wages for weekly day of rest and other allowances, whether for time or piece work, after taking into consideration prevailing market rates for similar employments in the neighborhood but shall not be less than the minimum rates of wages fixed under the minimum Wages Act.
- c) "Contractor" for the purpose of these Regulations shall include an agent or Sub-Contractor employing labour on the work taken on contract.
- d) "Inspecting Officer" means any Labour Enforcement Officer, or Assistant Labour Commissioners of the Chief Labour Commissioner's Organisation.
- e) "Form" means a form appended to these Regulations.

2. Notice of Commencement :

The Contractor shall, within **SEVEN DAYS** of commencement of the work, furnish in writing to the Inspecting Officer of the area concerned the following information with copy to the Engineer-in-charge.

- a) Name and situation of the work.
- b) Contractor's name and address.
- c) Particulars of the Department for which the work is undertaken.
- d) Name and address of sub-contractors as and when they are appointed
- e) Commencement and probable duration of the work
- f) Number of workers employed and likely to be employed,
- g) 'Fair wages' for different categories of workers.

- 3. (i) Number of hours which shall constitute a normal working day:
The number of hours which shall constitute a normal working day for an adult shall be **NINE** hours. The working day of an adult worker shall be so arranged that of intervals, if any, for rest it shall not spread over more than twelve hours on any day. When an adult worker is made to work for more than **NINE** hours on any day or for more than **FORTY EIGHT** hours in any week he shall in respect of overtime work, be paid wages at double the ordinary rate of wages.
- (ii) Weekly day of rest: Every worker shall be given a weekly day of rest which shall be fixed and notified atleast **TEN** days in advance. A worker shall not be required or allowed to work on the weekly rest day unless he has or will have a substituted rest day, on one of five days immediately before or after the rest day. Provided that no substitution shall be made which will result in the worker working for more than ten days consecutively without a rest day for a whole day.

Where in accordance with the foregoing provisions a worker works on the rest day and has been given a substituted rest day he shall be paid wages for the work done on the weekly rest day at the overtime rate of wages.

NOTE: The expression 'Ordinary rate of wages' means the fair wage the worker is entitled to.

4. Display of Notice Regarding Wages, Weekly Day of Rest, Etc.:

The Contractor shall before he commences his work on contract display and correctly maintain and continue to display and correctly maintain in clean and legible condition in conspicuous places on the works, notice in English and in the local Indian languages, spoken by majority of workers, given the rate of fair wages, the hours of work for which such wages are payable, the weekly rest days workers are entitled to and name and address of the Inspecting Officer. The Contractor shall send a copy each of such notices to the Inspecting Officers and the Engineer-in-charge.

5. Fixation of Wage Periods:

The Contractor shall fix wage periods in respect of which wages shall be payable .
No wage period shall normally exceed one week.

6. Payment of Wages:

(i) Wages due to every worker shall be paid to him direct. All wages shall be paid in current coins or currency or in both.

Wages of every worker employed on the contract shall be paid where the wage period is one week, within, **THREE DAYS** from the end of the wage period, and in any other case before the expiry of the 7th day or 10th day from the end of the wage period according as number of workers does not exceed 1,000.

(ii) When employment of any worker is terminated by or on behalf of the contractor, the wages earned by him shall be paid before expiry of the day succeeding the one on which his employment is terminated.

(iii) Payment of wages shall be made at the work site on a working day except when the work is completed before expiry of the wage period, in which case final payment shall be made at the work site within 48 hours of the last working day and during normal working time.

NOTE: The term "Working Day" means a day on which the work on which labour is employed is in progress.

7. Register of Workmen :

A register of workmen shall be maintained in the form appended to these regulations and kept at the work site or as near to it as possible, and the relevant particulars of every workmen shall be entered therein within **THREE** days of his employment.

8. Employment Card:

The Contractor shall issue an employment card in the Form appended to these regulations to each worker on the day of work or entry into his employment. If a worker has already any such card with him issued by the previous employer the contractor shall merely endorse that Employment Card with relevant entries. On termination of employment the Employment Card shall again be endorsed by the Contractor and returned to the worker.

9. Register of Wages etc., :

- (i) A register of Wages-cum-Muster Roll in the Form appended to these regulations shall be maintained and kept at the work site or as near to it as possible.
- (ii) A wage slip in the form appended to these regulations shall be issued to every worker employed by the Contractor atleast a day prior to disbursement of wages.

10. Fines and Deductions which may be made from wages:

- (i) Wages of worker shall be paid to him without any deductions of any kind except the following:
 - a. Fines;
 - b. Deductions for absence from duty, i.e., from the place or the places where by the terms of his employment, he is required to work. The amount of deduction shall be in proportion to the period for which he was absent.
 - c. Deduction for damage to or loss of goods expressly entrusted to the employed person for custody, or for loss of money which he is required to account for, where such damage or loss is directly attributable to his neglect or default;
 - d. Deductions for recovery of advances or for adjustment of overpayment of a wages. Advance granted shall be entered in a register;

and
 - e. Any other deduction, which the B.H.E.L may from time to allow.
- ii. No fines shall be imposed on a worker save in respect of such acts and omissions on his part as have been approved by the Chief Labour Commissioner.
- iii. No fines shall be imposed on a worker and no deductions for damage or loss shall be made from wages until the worker has been given an opportunity of showing cause against such fines or deductions.
- iv. The total amount of fines which may be imposed in any one wage period on a worker shall not exceed an amount equal to three paise in rupee of the wages payable to him in respect of that wage period.
- v. No fine imposed on a worker shall be recovered from him in instalments, or after expiry of sixty days from the date on which it was imposed. Every fine shall deemed to have been imposed on the day of the act or omission in respect of which it was imposed.
- vi. The Contractor shall maintain both in English and the local Indian language a list, approved by the Chief Labour Commissioner, clearly stating the acts and omissions for which penalty or fine may be imposed on a workman and display it in good condition in a conspicuous place on the work site.
- vii. The Contractor shall maintain a register of fines and the register of deductions for damage or loss in the Forms appended to these regulations which should be kept at the place of work.

11. Register of Accidents :

The Contractor shall maintain a register of accidents in such form as may be convenient at the work place but the same shall include the following particulars:

- a. Full particulars of the labourers who met with the accident.
- b. Rates of Wages.
- c. Sex
- d. Age
- e. Nature of accident and cause of accident.
- f. Time and date of accident.
- g. Date and time when admitted in hospital.
- h. Date of discharge from the hospital.
- i. Period of treatment and result of treatment.
- j. Percentage of loss of earning capacity and disability as assessed by Medical Officer.
- k. Claim required to be paid under Workmen's Compensation Act.
- l. Date of payment of compensation.
- m. Amount paid with details of the person to whom the same was paid.
- n. Authority by whom the compensation was assessed.
- o. Remarks.

12. Preservation of Registers :

The Register of Wages-cum-Muster Roll required to be maintained under these Regulations shall be preserved for 3 years after the date on which last entry is made therein.

13. Enforcement :

The Inspecting Officer shall either on his own motion or on a complaint received by him carry out investigations, and send a report to the Engineer-in-charge specifying the amounts representing workers, dues and amount of penalty to be imposed on the contractor for breach of these Regulations, that have to be recovered from the contractor, indicating full details of the recoveries proposed and the reasons therefore. It shall be obligatory on the part of the Engineer-in-Charge on receipt of such a report to deduct such amounts from payments due to the contractor.

14. Disposal of amounts recovered from the Contractor :

The Engineer-in-charge shall arrange payment to workers concerned within **FORTY FIVE** days from receipt of a report from the Inspecting Officer except in cases where the contractor had made an appeal under Regulation, 16 of these Regulations. In cases where there is an appeal, payments of workers, due would be arranged by the Engineer-in-charge, wherever such payments arise, within **THIRTY** days from the date of receipt of the decision of the Regional Labour Commissioner (R.L.C.).

15. Welfare Fund:

All money that are recovered by the Engineer-in-charge by way of workers, due which could not be disbursed to workers within the time-limit prescribed above, due to reasons such as where-about of workers not being known, death of a worker, etc., and also amounts recovered as penalty, shall be credited to a fund to be kept under the custody of B.H.E.L for such benefit and welfare of workmen employed by contractors.

16. Appeal against decision of Inspecting Officer :

Any person aggrieved by a decision of the Inspecting Officer may appeal against such decision to the Regional Labour Commissioner concerned within THIRTY days from the date of the decision, forwarding simultaneously a copy of his appeal to the Engineer-in-charge. The decision of the Regional Labour Commissioner shall be final and binding upon the Contractor and the workmen.

17. Representation of Parties:

- i. A workman shall be entitled to be represented in any investigation or enquiry under these Regulations by an Officer of a registered trade union of which the said trade union is affiliated or where the workman is not a member of any registered trade union, by an Officer of a registered trade union connected with, or any other workmen employed in the industry in which the worker is employed.
- ii. A Contractor shall be entitled to be represented in any investigation or enquiry under these Regulations by an officer of an association of contractors of which he is a member or by an officer of a Federation of Associations of Contractors to which the said association is affiliated or where the contractor is not a member of any association of employers, connected with, or by any other employer engaged in the industry in which the contractor is engaged.
- iii. No party shall be entitled to be represented by a legal practitioner in any investigation or enquiry under these Regulations.

18. Inspection of Books and other Documents:

The Contractor shall allow inspection of the Register and other documents prescribed under these Regulations by Inspecting Officer and the Engineer-in-charge or his authorized representative at any time and by the worker or his agent on receipt of due notice at a convenient time.

19. Interpretation etc.

On any question as to the application, interpretation or effect of the Regulations the decision of the Chief Labour Commissioner or Deputy Chief Labour Commissioner (Central) shall be final and binding.

20. Amendments:

Central Government may, from time to time, add to or amend the Contractor's Labour Regulations and issue such directions as it may consider necessary for the proper implementation of the Contractor's Labour Regulations or for the purpose of removing any difficulty which may arise in the administration thereof, based on which the B.H.E.L., Contractor's Labour Regulations herein contained shall be subject to revision.

**MODEL RULES FOR LABOUR WELFARE
(See Condition 20)**

1. Definition:

- (a) 'Workplace' means a place at which, on an average, twenty or more workers are employed.
- (b) 'Large Workplace' means a place at which on an average, 500 or more workers are employed.

- 2. First Aid:** At every workplace, there shall be maintained in a readily accessible place first-aid appliances including an adequate supply of sterilized dressings and sterilized cotton wool as prescribed in the Factory Rules of the State in which the work is carried on. The appliances shall be kept in good order

and, in large work places, they shall be placed under the charge of a responsible person who shall be readily available during working hours.

At large workplaces, where hospital facilities are not available within easy distance of the works First Aid posts shall be established and be run by a trained compounder.

Where large workplaces are remotely situated and far away from regular hospitals an indoor ward shall be provided with one bed for every 250 employees.

Where large workplaces are situated in cities, towns or in their suburbs and no beds are considered necessary owing to proximity of city or town hospitals, suitable transport shall be provided to facilitate removal of urgent cases to these hospitals. At other workplaces, some conveyance facilities shall be kept readily available to take injured person or persons suddenly taken seriously ill, to the nearest hospital.

At large workplaces there shall be provided and maintained an ambulance room of the prescribed sizes, containing the prescribed equipment and in the in-charge of such medical and nursing staff as may be prescribed. For this purpose the relevant provisions of the Factory Rules of the State Government of the area where the work is carried on may be taken as the prescribed standard.

3. **Accommodation for Labour:** The Contractor shall during the progress of the works provide, erect and maintain necessary temporary living accommodation and ancillary facilities for labour at his own expense and to standards and scales as approved by the Engineer-in-charge.

4. **Drinking Water:** In every workplace, there shall be provided and maintained at suitable places, easily accessible to labour, a sufficient supply of cold water fit for drinking.

Where drinking water is obtained from an intermittent public water supply each workplace shall be provided with storage where drinking water shall be stored. Every water supply storage shall be at a distance of not less than 15 meters from any latrine drain or other source of pollution. Where water has to be drawn from an existing well, which is within such proximity of latrine drain or any other source of pollution, the well shall be properly chlorinated before water is drawn from it for drinking. All such wells shall be entirely closed in and be provided with a trap door which shall be dust and water-proof.

A reliable pump shall be fitted to each covered well, the trap door shall be kept locked and opened only for cleaning or inspection which shall be done at least once a month.

5. **Washing and Bathing places:** Adequate washing and bathing places shall be provided separately for men and women. Such places shall be kept in clean and drained condition.

6. **Scale of Accommodation in Latrines and Urinals:** These shall be provided within the precincts of every workplace latrines and urinals in an accessible place, and the accommodation, separately for each of these, shall not be less than at the following scales:

	No.of Seats
a) Where number of persons does not exceed 50	2
b) Where number of persons exceed 50 but does not exceed 100	3
c) For additional persons	3

Per 100 or part thereof.

In particular cases, the Engineer-in-charge shall have the power to increase the requirement, where necessary.

7. **Latrines and Urinals:** Except in workplaces provided with water flushed latrines connected with a waterborne sewage system, all latrines shall be provided with receptacles on dry-earth system which shall be cleaned at least four times daily and at least twice during working hours and kept in a strictly sanitary condition. Receptacles shall be tarred inside and outside at least once a year.

If women are employed, separate latrine and urinals, screened from those for men and marked in the vernacular in conspicuous letters "For Women only" shall be provided on the scale laid down in rule 6. Those for men shall be similarly marked "For Men only" A poster showing the figure of a man and of a woman shall also be exhibited at the entrance to latrines for each sex. There shall be adequate supply of water close to latrines and urinals.

8. **Construction of Latrines:** Inside walls shall be constructed of masonry or other non-absorbent material and shall be cement-washed inside and outside at least once a year. The dates of cement washing shall be noted in a register maintained for the purpose and kept available for inspection. Latrines shall have at least thatched roof.
9. **Disposal of Excreta:** Unless otherwise arranged for by the local sanitary authority, arrangement for proper disposal of excreta by incineration at the workplace shall be made by means of a suitable incinerator approved by the local medical health and municipal or cantonment authorities. Alternatively local excreta may be disposed off by putting a layer of night soil at the Bottom of pucca tank prepared for the purpose and covering it with a 15 cm. layer of waste or refuse and then covering it with a layer of earth for a fortnight (when it will turn into manure).

The contractor shall, at his own expenses, carry out all instruction issued to him by the Engineer-in-charge to effect proper disposal of soil and other conservancy work in respect of Contractor's work-people or employees on the Site. The Contractor shall be responsible for payment of any charges which may be levied by municipal or cantonment authority for execution of such work on his behalf.

10. **Provision of shelters during rest:** At every workplace there shall be provided, free of cost, four suitable sheds, two for meals and two others for rest, separately for use of men and women labour. Height of each shelter shall not be less than 3 meters from floor level to lowest part of roof. Sheds shall be kept clean and space provided shall be on the basis of at least 0.5 sq.m. per head.
11. **Crèches:** At a place at which 20 or more women workers are ordinarily employed, there shall be provided at least one hut for use of children under the age of 6 years of such women. Huts shall not be constructed to a standard lower than that of thatched roof, mud floor and walls with wooden planks spread over mud floor and covered with matting.

Huts shall be provided with suitable and sufficient openings, for light and ventilation. There shall be adequate provision of sweepers to keep the places clean. There shall be two 'dais' in attendance. Sanitary utensils shall be provided to the satisfaction of local medical, health and municipal or cantonment authorities. Use of huts shall be restricted to children, their attendants and mothers of children.

When the number of women workers is more than 25 but less than 50, the Contractor shall provide at least one hut and one Dais to look after children of women workers.

Size of crèche (s) shall vary according to the number of women workers employed. Creche(s) shall be properly maintained and necessary equipment like toys, etc. provided.

12. Canteen: A cooked food canteen on a moderate scale shall be provided for the benefit of workers wherever it is considered necessary.

13. Planning, setting and erection of the above mentioned structures shall be approved by the Engineer-in-charge, and the whole of such temporary accommodation shall at all times during the progress of the works be kept tidy and in a clean and sanitary condition to the satisfaction of the Engineer-in-Charge and at the Contractor's expense. The Contractor shall conform generally to sanitary requirements of local medical, health and municipal or cantonment authorities and at all times adopt such precautions as may be necessary to prevent soil pollution of the site.

On completion of the works the whole of such temporary structures shall be cleared away, all rubbish burnt, excreta or other disposal pits or trenches filled in and effectively sealed off and the whole of site left clean and tidy to the entire satisfaction of the Engineer-in-Charge, and at the Contractor's expenses.

14. Anti-malarial precautions: The Contractor shall, at his own expense, conform to all anti-malarial instructions given to him by the Engineer-in-charge, including filling up of any borrow pits which may have been dug by him.

15. Enforcement: The Inspecting Officer mentioned in the Contractors Labour Regulations or any other officer nominated in his behalf by the Engineer-in-Charge shall report to the Engineer-in-Charge all cases of failure on the part of the Contractor and or his sub-contractors to comply with the provisions of these Rules either wholly or in part and the Engineer-in-Charge shall impose such fines and other penalties as are prescribed in the conditions.

B.H.E.L SAFETY CODE See Condition-20

1. Suitable scaffolds shall be provided for workmen for all work that cannot safely be done from the ground, or from solid construction except such short period of work as can be done safely from ladders. When a ladder is used an extra mazdoor shall be engaged for holding the ladder and if the ladder is used for carrying materials as well, suitable footholds and hand-holds shall be provided on the ladder and the ladder shall be given an inclination not steeper than $\frac{1}{4}$ to 1 ($\frac{1}{4}$ horizontal and 1 vertical)
2. Scaffolding or staging more than 3.25 meters above the ground or floor, swung or suspended from an overhead support or erected with stationary support, shall have a guard rail properly attached, bolted, braced and otherwise secured atleast 1 meter high above the floor or platform of such scaffolding or staging and extending along the entire length of the outside and ends thereof with only such openings as may be necessary for the delivery of materials. Such scaffolding or staging shall be so fastened as to prevent it from swaying from the building or structure.
3. Working platform, gangways, and stairways shall be so constructed that they do not sag unduly or unequally, and if height of a platform or gangway or stairway is more than 3.25 meters above ground level or floor level, it shall be closely bordered have adequate width and be suitably fenced, as described in 2 above
4. Every opening in floor of a building or in a working platform shall be provided with suitable means to prevent fall of persons or materials by providing suitable fencing or railing with a minimum height of 1 meter.

5. Safe means of access shall be provided to all working platforms and other working places. Every ladder shall be securely fixed. No portable single ladder shall be over 9 meters in length. Width between side rails in a rung, ladder shall in no case be less than 30 cm, for ladders upto and including 3 metres in length. For longer ladders this width shall be increased by atleast 6 mm for each additional 30 cm. of length. Uniform step spacing shall not exceed 30 cm.

Adequate precautions shall be taken to prevent danger from electrical equipment. No materials on any of the sites shall be so stacked or placed as to cause danger or inconvenience to any person or the public. The Contractor shall provide all necessary fencing and lights to protect public from accidents and shall be bound to bear expenses of defence of every suit action or other proceedings at law that may be brought by any person for injury sustained owing to neglect of the above precautions, and pay any damages and costs which may be awarded in any such suit, action or proceeding to any such person or which may with the consent of the Contractor be paid to compromise any claim by any such person.

6. Excavation and Trenching:

All trenches, 1.5 metres or more in depth, shall at all times be supplied with atleast one ladder for each 30 m length or fraction thereof. Ladder shall be extended from bottom of trench to atleast 1 metre above surface of the ground. Sides of a trench 1.5 metres or more in depth shall be stepped back to give suitable slope or securely held by timber bracing, so as to avoid the danger of sides collapsing. Excavated materials shall not be placed within 1.5 metres of the edge of trench or half the depth of trench, whichever is more. Cutting shall be from top to bottom. Under no circumstances shall undermining or undercutting be done.

7. **Demolition:** Before any demolition work is commenced and also during the process of the work:

- a. All roads and open areas adjacent to the work site shall either be closed or suitably protected:
- b. No electric cable or apparatus which is liable to be a source of danger over a cable or apparatus used by the operator shall remain electrically charged.
- c. All practical steps shall be taken to prevent danger to persons employed, from risk of fire or explosion, or flooding. No floor, roof, or other part of a building shall be so overloaded with debris or materials as to render it unsafe.

8. All necessary personal safety equipment as considered adequate by the Engineer-in-Charge shall be available for use of persons employed on the site and maintained in a condition suitable for immediate use and the Contractor shall take adequate steps to ensure proper use of equipment by those concerned.

- a. Workers employed on mixing asphaltic materials cement and lime mortars/ concrete shall be provided with protective footwear and protective gloves.
- b. Those engaged in handling any material which is injurious to the eye shall be provided with protective goggles.

- c. Those engaged in welding works shall be provided with welder's protective eye-shields.
- d. Stone breaker shall be provided with protective goggles and protective clothing and seated at sufficiently safe intervals.
- e. When workers are employed in sewers and manholes which are in use, the

Contractor shall ensure that manhole covers are opened and manholes are ventilated atleast for an hour before workers are allowed to get into them. Manholes so opened shall be cordoned off with suitable railing and provided with warning signals or boards to prevent accident to public.

The Contractor shall not employ men below the age of 18 and women on the work of painting with products containing lead in any form. Whenever men above the age of 18 are employed on the work of lead painting, the following precautions shall be taken:

- i. No paint containing lead or lead products shall be used except in the form of paste or ready-made paint.
 - ii. Suitable face masks shall be supplied for use by workers when paint is applied in the form of spray or a surface having lead paint is dry rubbed and scraped.
 - iii. Overalls shall be supplied by the Contractor to workmen and adequate facilities shall be provided to enable working-painters to wash during on cessation of work.
9. When work is done near any place where there is risk of drowning, all necessary equipment shall be provided and kept ready for use and all necessary steps taken for prompt rescue of any person in danger and adequate provision made for prompt first aid treatment of all injuries likely to be sustained during the course of the work.
10. Use of hoisting machine and tackles including their attachments, anchorage and supports shall conform to the following:
- a.
 - i. These shall be of good mechanical construction, sound material and adequate strength and free from defects and shall be kept in good working order.
 - ii. Every rope used in hoisting or lowering materials or as a means of suspension shall be of durable quality and adequate strength, and free from defects.
 - b. Every crane driver or hoisting appliance operator shall be properly qualified and no person under the age of 21 years shall be in charge of any hoisting machine including any scaffolding winch or give signals to operator.
 - c. In case of every hoisting machine and of every chain, ring, hook, shackle, swivel and pulley block used in hoisting or lowering or as means of suspension, safe working load shall be ascertained by adequate means. Every hoisting machine and all gear referred to above shall have the safe working load plainly marked there on, In case of a hoisting machine having a variable safe working load, each safe working load and the conditions under which it is applicable shall be clearly indicated. No part of any machine or any gear referred to above in this paragraph shall be loaded beyond the safe working load except for the purpose of testing.

- d. In case of departmental machine, safe working load shall be notified by the Engineer-in-Charge. As regards contractor's machine the Contractor shall notify safe working load of each machine to the Engineer-in-Charge whenever he brings it to site of work and get it verified by the Engineer-in-Charge.
11. Motors, gearing, transmission, electric wiring and other dangerous parts of hoisting appliances shall be provided with efficient safeguards; hoisting appliances shall be provided with such means as will reduce to the minimum risk of accidental descent of load. Adequate precautions shall be taken to reduce to the minimum risk of any part of a suspended load becoming accidentally displaced. When workers are employed on electrical installations which are already energized, insulating mats, working apparel such as gloves, sleeves and boots, as may be necessary shall be provided. Workers shall not wear any rings, watches carry keys or other materials which are good conductors of electricity.
12. All scaffolds, ladders and other safety devices mentioned or described herein shall be maintained in a safe condition and no scaffold, ladder or equipment shall be altered or removed while it is in use. Adequate washing facilities shall be provided at or near the places of work.
13. These safety provision shall be brought to the notice of all concerned by display on a notice board at a prominent place at the work spot. Persons responsible for ensuring compliance with the Safety Code shall be named thereon by the Contractor.
14. To ensure effective enforcement of the rules and regulations relating to safety precautions, arrangements made by the Contractor shall be open to inspection by the Engineer-in-Charge or his representatives and the Inspecting Officers as defined in the Contractor's Labour Regulations.
15. Notwithstanding the above conditions 1 to 14, the Contractor is not exempted from the operation of any other Act or Rule in force.

FORM OF REGISTER OF WORKMEN

(Regulation-7)

- i. Name and address of the Contractor-----
- i. Number and date of the **WORK ORDER & CONTRACT AGREEMENT** -----
- iii. Name and address of the department awarding the contract-----
- iv. Nature of the Contract and location of the work-----
- v. Duration of the Contract-----

Sl. No	Name and surname of the workers	Age & Sex	Father's / Husband's Name	Nature of employment Designation.	Permanent / Home address of Employee (Village, Distt. Thana).	Present address	Date of commencement of employment	Date of termination or leaving of employment	Signature or thumb impression of the employee.	Remarks
1	2	3	4	5	6	7	8	9	10	11

CONTRACTOR

ACCEPTING OFFICER

**FORM OF EMPLOYMENT CARD
(Regulation-8)**

- i Name and Sex of the Worker-----
- ii Father's / Husband's Name -----
- iii Address -----
- iv Age or Date of birth-----
- v Identification mark -----

Particulars of next of kin (wife/husband and children, if any, or of dependent next of kin in case the worker has no wife/ husband or child):-
Name-----

Full address of Dependents
(Specify Village, Dist., and State)-----

Sl. No	Name & Address of employer (specify Whether a contractor or a sub contractor).	Particulars of location of worksite and description of work done	Total period for which the worker is employed from..... to.....)	Actual number of days worked	Leave taken (No. of days should be specified).	Nature of Work done by the worker.	Wage rate With Particulars of unit in Case of Piece work.	Total Wage earned by the Worker during the period shown Under Col.5.	REMARKS	Signature of the Employee
1	2	3	4	5	6	7	8	9	10	11

N.B:- For a worker employed at one time on piece-work basis and at another on daily wages, relevant entries in respect of each type of employment should be made separately.

CONTRACTOR

70

ACCEPTING OFFICER

**FORM OF WAGE SLIP
(Regulation-9)**

- i. Name of the Contractor -----
 - ii. Place -----

 - 1. Name of the worker with
father's / husband's name.
 - 2. Nature of employment.
 - 3. Wage period.
 - 4. Rate of Wages payable
 - 5. Total attendance / Unit of work done.
 - 6. Dates on which overtime worked
 - 7. Overtime Wages.
 - 8. Gross Wages payable.
 - 9. Total deductions (indicating
nature of deductions)
 - 10. Net wages payable.
-

Contractor's Signature /
Thumb impression.

Employees' Signature/
Thumb impression.

FORM OF REGISTER OF FINES

(Regulations No.10 vii)

Sl. No.	Name	Father's / Husband's name	Sex	Department	Nature and date of the offence for which fine imposed	Whether workmen showed cause against fine or not, if so, enter date	Rate of wages	Date and amount of fine imposed	Date on which fine realised	Remarks
1	2	3	4	5	6	7	8	9	10	11

CONTRACTOR

72

ACCEPTING OFFICER

FORM OF REGISTER OF WAGES-CUM-MUSTER ROLL

(Regulation – 9)

- i. Name and address of the Contractor-----
- ii. No. & Date of the Contract Agreement /Work Order-----
- iii. Name and address of the department awarding the Contract-----
- iv. Nature of the Contract and location of the work-----
- v. Duration of the Contract-----
- vi. Wage period-----

		Fair Wage Wages payable paid				Overtime Worked		Deduction from wages															
Serial Number	Name and Surname of the worker	Father's/Husband's name	Sex	Designation and Nature of work	Daily attendance (No. of units worked 1,2,3,4,5,6,7,31)	Total attendance Units	Basic	D.A. & other allowance	Basic	D.A. & other allowance	Date	No.of hours.	Overtime wages earned.	Total wages paid	*Fine	Deduction for damage or loss	House rent	Recovery of advances	Other deductions	Net wages payable	Date of payment	Signature of thumb impressior of the worker	Remarks
01	02	03	04	05	06	07	08	09	10	11	12	13	14	15	16	17	18	19	20	21	22	23	24
Reasons to be recorded in Column 24.																							

CONTRACTOR

73

ACCEPTING OFFICER

The contractor should engage Technical persons and Workmen with the following qualifications for works as detailed below and the contractor shall carry out the Health Performance check at his cost for the workman engaged in the work through a registered medical practitioner and produce the certificate on demand.

CHECK FOR HEALTH PERFORMANCE

Sl. No.	Activity	Hazard	Exposure Consequence	Check for	Periodicity
1	Concrete Dismantling	Emission of Dust & Noise	1	Lung function	Once in a Year
2	Concrete Mixing	Emission of Dust & Noise	1	Lung function	Once in a Year
3	Painting	Emission of Dust & fumes	1	Lung & throat function	Once in a Year
4	Cutting & Welding	Emission of fumes and gas. Exposure to Live wire	3	Eyes & Lung function	Once in a Year
5	Working on AC sheets	Emission of Dust	3	Lung function	Once in a Year
6	Sweeping of Roads	Emission of Dust	2	Lung function	Once in a Year
7	Collection and disposal of Sanitary waste	Foul smell & susceptibility to decease.	3	Lung function and skin irritation	Once in a Year
8	Handling of Oxygen & Acetylene Cylinders	Leakage of gas	4	Throat irritation	Once in a Year
9	Cleaning of Manholes	Exposure to poisonous gas	4	Suffocation	Once in a Year
10	Cleaning of Overhead tank	Emission of Dust	1	Suffocation & skin irritation	Once in a Year

NOTE: Exposure Consequence

1. Slightly harmful
2. Harmful
3. Very harmful
4. Extremely harmful



**BHARAT HEAVY ELECTRICALS LIMITED ,
UNIT: TIRUCHIRAPALLI - 620 014**

CIVIL ENGINEERING DEPARTMENT (FACTORY)

NORMS FOR QUALIFICATION

Name of Work: Supplying & fixing of Aluminium zinc alloy coated high tensile steel sheets for roofing and side sheeting to replace existing AC sheets in Factory Buildings of HPBP, SSTP and allied areas in BHEL, Trichy Complex.

(Tender Notice No. 02 /11-12 & Tender schedule No. 11 / 11-12)

Sl. No.	Thrust Area	Score	Tender value Rs. 200.00 Lakhs
I	ELIGIBILITY: 1. Separate Registration for EPF, ESI,PAN, Sales tax,& Service tax, Proof of IT returns submitted for the last three years 2007-08 to 2009-10), Profit & Loss account and balance sheet certified by the auditor. 2. Average annual turnover in the last 3 financial years shall be at least for a value of minimum of Rs.60.00 Lakhs. 3. During last seven financial years should have successfully completed works either a) Three similar works each not less than Rs. 80.00 Lakhs (or) b) Two similar works each not less than Rs. 100.00 Lakhs (or) c) One similar work not less than Rs.160 Lakhs 4. Solvency certificate shall be minimum for Rs. 80.00 Lakhs (The Certificate should have been issued within 6 months from the date of tender opening.)		
	THRUST AREA	SCORE	Qualification Norms
II	NATURE OF COMPANY	5	
	Public Limited	5	
	Private Limited/Partnership firm	3	
	Sole Proprietor	2	
III	Similar Experience in Supply and laying or Laying of Aluminium zinc alloy coated high tensile steel sheet work.	40	
	Total Value of Aluminium zinc alloy coated high tensile steel sheet works executed in the last three years) (Pro-rata for in between cases)	40	Rs. 360.00 Lakhs
	More than	24	Rs. 180.00 Lakhs

IV	Performance on previous works	20	
	Successful completion of three major works in time. (Each not less than Rs. 80.00 Lakhs)	20	
	Successful completion of two major works in time.	16	
	Successful completion of one major work in time.	12	
V	Highest value of single work completed (Rs.80.00 L)	10	
	(Pro-rata for in between cases)	10	Rs. 160.00 Lakhs
	More than	6	Rs. 80.00 Lakhs
VI	Equipments / Tools & Plants owned	10	
	Drilling Machines, Lifting tackles, ,Sheet Cutting scissors, Safety ladders, nets, ropes for lifeline.	10	
	Drilling Machines, Lifting tackles,, Sheet Cutting scissors, Safety ladders , ropes for lifeline.	6	
VII	Qualified staff availability	5	
	Two Supervisors & 15 Skilled labourers along with Site In charge available.	5	
VIII	Financial stability (Solvency)	10	
	(Pro-rata for in between cases)	10	Rs.160.00 Lakhs
	More than .	6	Rs. 80.00 Lakhs
	Total	100	

NOTE: Minimum score required for qualification is **60 out of 100.**

12. Is the individual/sole proprietor/any partner/ directors of company:
- (a) Dismissed Government Servant Yes No
- (b) Having business banned/suspended by any government in the past Yes No
- (c) Convicted by a court of law Yes No
- (d) Retired Engineer / Official from Engineering Departments of Govt. of India within last two years Yes No
- (e) Director or partner of any other company / firm enlisted with CPWD or any other department Yes No
- (f) Member of Parliament or any State Legislative Assembly If answer to any of the above is 'Yes', furnish details on a separate sheet Yes No
13. Name of person holding power of attorney. (Copy to be enclosed)
- (a) Nationality Indian Other
- (b) Liabilities
14. Name of Banker with full address (Note: Banker's report in original preferably in sealed cover, giving the financial capacity to handle works of the required magnitude should be enclosed)
15. Place of business
16. Date of commencement of business
17. Details of Income Tax paid during last three years. 1. 2009-10
2. 2008-09
3. 2007-08
18. State whether Income Tax Returns filed Acknowledged by IT Office, Audited report for Profit and Loss Account & Balance Sheet for last three years enclosed 1. 2009-10
2. 2008-09
3. 2007-08
19. Contractor's capital in the business. (in case of partnership, please mention percentage of shares and amount)
20. Quantum of business done during last three financial years 1. 2009-10
2. 2008-09
3. 2007-08
21. Value of fixed assets of the business in the last three years 1. 2009-10
2. 2008-09
3. 2007-08
22. Guarantee limits (if any) enjoyed by the firm.

23. Over-draft limits (if any) enjoyed by the firm.

24. Details of Technically qualified staff :-

Sl. No.	Name and Designation	Qualification	Experience and Specialization	Remarks if any

25. Whether the details of T & P, Machinery, Equipments and work shop as per Annexure – I given. Yes No

26. Whether enlisted with any other Department (a) If yes, give details: Yes No

(i) Name of Department & address

(ii) Money limit

(iii) Enlistment No. & date

(iv) Valid up to

27. License No. and validity of license obtained from Dy. Chief Inspector of Factories / Assistant Commissioner of Labour

28. Whether the applicant has registered his workmen under Employees' State Insurance Act. If so, code number may be furnished.

29. Whether the applicant has registered his workmen under Employees' Provident Funds and Miscellaneous Provisions Act ?. If so, the code number may be furnished

30. Is any person working with the applicant as a near relative of the Officer / Official of BHEL Yes No

(a) If yes, give details

(i) Name

(ii) Staff No.

(iii) Designation & Department

(iv) Unit

31. Details of similar works completed during the last seven years (To be submitted in separate sheet as per Annexure-II.)

32. Certificates from clients in original as per proforma given in Annexure -III for all eligible works.
33. Certificates:
- (i) I/We (including all partners) certify that I/We have read the Preamble & Terms and conditions and shall abide by them.
 - (ii) I/We certify that the information given above is true to the best of our knowledge. I/We also understand that if any of the information is found wrong, I/We am/are liable to be debarred.
 - (iii) I/We certify that I/We will not get myself / ourselves registered as contractor(s) in BHEL under more than one name.
 - (iv) (a) I certify that I did not retire as an Engineer of Gazetted rank or as any Gazetted Officer employed on Engineering or Administrative duties in any Engineering Department of the Government of India during the last two years. I also certify that I have neither such a person under my employment nor shall I employ any such person within two years of his retirement except with the prior permission of the Government. (For Individuals seeking enlistment in their own name).
 - (b) We certify that none of the partners/directors retire as an Engineer of Gazetted rank or as any Gazetted Officer employed on Engineering or Administrative duties in last two years. We also certify that we have neither under our employment any such person nor shall we employ any person within two years of his retirement except with the prior permission of the Government. (For partnership firms and limited companies).

Signature(s) of the applicant(s) Name	Signature	Address (Seal in case of Firm)
1.
2.
3.
4.
5.

Date:

- NOTE: 1) All the relevant certificates, details etc. should be attached with the application.
2) The terms that are not applicable may be scored out.

Details of documents attached:-

- 1.
- 2.
- 3.
- 4.
- 5.
- 6.
- 7.
- 8.
- 9.
- 10.

ANNEXURE – I

DETAILS OF PLANTS AND EQUIPMENTS OWNED

Sl. No.	Name of Equipments	Nos.	Capacity or Type	Age	Remarks
	Earth moving equipments				
1.	Excavator (Various sizes)				
	Equipments for hoisting & lifting				
1	Mobile crane				
2.	Tower crane				
3.	Builder's hoist				
	Equipments for concrete works				
1.	Concrete batching plant				
2.	Concrete pump				
3.	Concrete transit mixer				
4.	Concrete mixer (diesel)				
5.	Concrete mixer (electrical)				
6.	Concrete vibrator (electrical)				
7.	Concrete vibrator (petrol)				
8.	Table vibrator (elect./petrol)				
	Equipments for building works				
1.	Block making machine				
2.	Bar bending machine				
3.	Bar cutting machine				
4.	Wood thickness planer				
5.	Drilling machine				
6.	Circular saw machine				
7.	Welding generators				
8.	Welding transformers				
9.	Cube testing machine				
10.	Steel shuttering				
11.	Steel scaffolding				
12.	Grinding/polishing machine				
	Equipments for road works				
1.	Road roller				
2.	Bitumen paver finisher				
3.	Hot mix plant				
4.	Spreaders				
5.	Earth rammers				
6.	Vibratory road roller				
	Equipments for transportation				
1.	Tipper				
2.	Truck				
	Pneumatic equipments				
1.	Air compressor (diesel)				
	Dewatering equipments				
1.	Pump (diesel)				
2.	Pump (electrical)				
	Power equipments				
1.	Diesel generator				
	Any other plants/equipments				

ANNEXURE - II

**DETAILS OF SIMILAR WORKS COMPLETED DURING THE LAST SEVEN YEARS
(2003 – 2004 TO 2009-2010)**

Sl. No.	Name of work & Agreement No.	Date of commencement	Date of completion		Reasons for delay & compensation levied, if any	Work order Value	Gross cost of completion		Name, designation & complete address of the authority for whom the work was done
			Stipulated	Actual			Including cost of cement, steel reinforcement & strl. steel	Excluding cost of cement, steel reinforcement & strl. steel	

DETAILS OF WORK COMPLETION CERTIFICATES, WORK ORDERS ETC. ARE TO BE FURNISHED

Only work orders or Completion Certificates will not be considered. Both of them are essential for technical evaluation.

CONTRACTOR

ACCEPTING OFFICER

ANNEXURE - III

**CLIENT'S CERTIFICATE REGARDING PERFORMANCE OF
CONTRACTORS**

Name & Address of the Client

.....
.....

Details of works executed by Shri . M/s

.....

1. Name of work with brief particulars :
2. Agreement No. and date :
3. Date of commencement :
4. Stipulated date of completion :
5. Actual date of completion :
6. Details of compensation levied for delay, if any:
7. Tendered amount :
8. Gross amount of the work completed :
9. Name and address of the authority under whom work executed :
10. Whether the contractor employed qualified Engineer/Overseer during execution of work? :
11. (i) Quality of work (indicate grading) : Outstanding/V.Good/Good/Poor
(ii) Amount of work paid on reduced rate basis, if any :
12. (i) Did the contractor go for arbitration ? :
(ii) If yes, amount of claim :
(iii) Amount received :
13. Comments on the capabilities of the contractor
(a) Technical Proficiency : Outstanding/V.Good/Good/Poor
(b) Financial Soundness : Outstanding/V.Good/Good/Poor
(c) Mobilisation of adequate T & P : Outstanding/V.Good/Good/Poor
(d) Mobilisation of manpower : Outstanding/V.Good/Good/Poor
(e) General behaviour : Outstanding/V.Good/Good/Poor

NOTE: All columns should be filled in properly.

Signature of the Certifying Officer
with Official seal.

CONTRACTOR

84

ACCEPTING OFFICER

**SCHEDULE 'A' ATTACHED IN THE PRICE BID
SCHEDULE 'B'**

1. The following materials will be issued FREE of cost to contractor at BHEL Stores / Stock yard.

SI.No.	DESCRIPTION	PLACE OF ISSUE
1	Cement	BHEL STORES or Stock yard
2	M.S Rounds, C.T.D Bars & Structural Steel, rails and all railway materials	BHEL STORES or Stock yard
3	Aluminium zinc alloy coated high tensile steel	BHEL STORES or Stock yard
4	Cast iron pipes & specials including pig lead for jointing	BHEL STORES or Stock yard

2. It will be the responsibility of the Contractor to submit his demands for the above stores in writing atleast seven days in advance of the actual requirement.
3. Issue of Stores is subject of the availability at the place of issue cited above, items of stores to be issued by BHEL which are not available at the time of indenting by the contractor may be supplied by BHEL after necessary procurement. The contractor shall not be entitled to any claim of compensation for delay in the supply of stores by BHEL under any circumstances.
4. The materials will be issued only during the working hours of the BHEL Stores Department (8.00 a.m. to 4.30 p.m.). Contractor shall have to transport them to the site of work at his own cost as soon as they are issued to him.
5. The steel materials if issued will be in random lengths and sizes as stocked by the BHEL and the cost of all cutting, conversion, substitution and fabrication as well as wastage shall have to be borne by the Contractor.
6. The contractor shall from time to time render proper account of all materials issued to him by BHEL. If he fails to do so, no further issue of materials will be made to him and he will be held responsible for any delay in the execution of the work which may occur on this account.
7. Where A.C. Sheets and accessories, Doors, Windows, Sanitary fittings, Special glasses or other items are issued free of cost to the contractor, the contractor will have to make good at his own cost any loss or damage to any part or whole of the items issued to him as above. All wastage within the premises limits as fixed by BHEL will be charged for at the prescribed issued rates of BHEL. Excess wastage will be charged for at punitive rates which will be 100% higher than the issue rates.
8. All surplus materials in good condition which are not returned to the BHEL Stores as also quantities of materials consumed in excess of the max. permissible limit as fixed by BHEL shall be charged for at punitive rates.

The decision of the Senior Engineer / Dy. Manager / Manager as to the extent to which materials have been rendered surplus or consumed in excess of the actual requirements shall be final and conclusive and binding on the contractor.

SCHEDULE 'C'

ISSUE OF TOOLS AND PLANTS TO CONTRACTORS

Sl.No.	Qty.	Particulars	Details of BHEL Crew Supplied	Hire Charges Per unit Per Day	Place of Issue	Remarks
--------	------	-------------	-------------------------------------	--	----------------------	---------

.....Nil.....

a. Machineries shall not be operated over time without the written permission of the Sr. Engineer / Dy. Manager / Manager.

b. All Coolies, Watermen etc., required in addition to BHEL crew mentioned in column 4 above shall be arranged by the contractor at his own expense.

SCHEDULE 'D'

NOTE : All Drawings are to be signed by the Contractor as well as the officer entering into contract.

SL.No.	DRAWING NUMBER	DESCRIPTION
1	Sketch-1	Details of accessories for metal sheet roofing and side cladding.
2	Sketch-2	Details of end curve

SCHEDULE 'E'

LEAD STATEMENT

Sl.No.	Name of Material	Name of Source	Lead Particulars both for Factory and Township
1	Aluminium zinc alloy coated high tensile steel sheet	BHEL Stores	2 Kilometre

C.A.....Date
(To be used in conjunction with BHE Ltd., General Conditions of Contract)

AUTHORITY TO TENDER

Tender Notice No. **02/11-12** Office of the
SR.MANAGER/CIVIL/FACTORY(PLANNING)
BHARAT HEAVY ELECTRICALS LIMITED
TIRUCHY – 14.

Tender Schedule No. **11/11-12**

~~Lumpsum / Percentage rate /~~ Item rate tender for works required in **“Supplying & fixing of Aluminium zinc alloy coated high tensile steel sheets for roofing and side sheeting to replace existing AC sheets in Factory Buildings of HPBP, SSTP and allied areas in BHEL, Trichy Complex.”**

Messrs. are / is hereby authorized to tender for the above work. The Tender is to be delivered at the Office of the **SR.MANAGER/CIVIL/FACTORY (PLANNING)** Bharat Heavy Electricals Limited Unit, Thiruverumbur, Tiruchirappalli – 620 014 superscribing the name of works as mentioned above.

Any correspondence concerning this Tender should be addressed as indicated above quoting the Tender Notice, schedule No. and other relevant particulars.

BHARAT HEAVY ELECTRICALS LIMITED DO NOT BIND THEMSELVES TO ACCEPT THE LOWEST OR ANY TENDER

**Issuing Officer with
Designation**

Contract Agreement No.....

TENDER

To

The SR.MANAGER/CIVIL/FACTORY (PLANNING)
Bharat Heavy Electricals Limited
Unit : Tiruverumbur
TIRUCHIRAPPALLI – 620 014.

I / We hereby offer to carry out the work of **“Supplying & fixing of Aluminium zinc alloy coated high tensile steel sheets for roofing and side sheeting to replace existing AC sheets in Factory Buildings of HPBP, SSTP and allied areas in BHEL, Trichy Complex.”**

I / We hereby carefully perused the following documents connected with the above noted work and agree to obide the same.

1. Specifications (General & Particular)
2. Drawings
3. Schedule ‘A’, ‘B’, ‘C’, ‘D’ & ‘E’ and Bill of Quantities attached hereto.
4. Schedule or rates
5. BHE Ltd., General & Special Conditions of Contract, Tender Notice and Instructions to Tenders attached hereto.

I / We forward herewith the sum of Rs.....as Earnest Money, which shall be refunded should this tender be rejected. I / We further agree to deposit such sum which along with the sum of Rs.....mentioned above shall make up 50% of the fully Security Deposit for this work as provided for under conditions of the BHARAT HEAVY ELECTRICALS LIMITED General Conditions of Contract.

I / We further agree to execute all the work referred to in the said documents upon the terms & condition contained or referred therein and as detailed in Schedule ‘A’ and Bill of Quantities annexure thereto an to carry out such deviations as may be ordered, vide conditions 6 of the BHEL Ltd., General Conditions of Contract upto a maximum of 20% of the tendered of Rs.....

I / WE further agree to refer all disputes, as required by condition 62 of the General conditions of Contract to the sole arbitration of an Officer, to be appointed by the General Manager, B.H.E. Ltd., in his sold discretion whose decision shall be final and binding.

WITNESS

Signature of the Contractor

Date :

1.

2.

GENERAL SUMMARY

1.	(a) Net Cost of works or building etc., from Schedule 'A' and Bill of quantities annexed thereto	Rs.
2.	Provisional sum	Rs.
	Total Rs.

Rupees.....
.....
.....Shri..... in the capacity of has been duly authorized by me / use to sign the tender for and on behalf of
.....
(in block letters)

Date : _____ SIGNATURE OF CONTRACTOR

Witness : _____ Postal Address :

1..... Telephone No.
Address

2.....
Address

..... alternations have been made in the Tender Document and as evidence that these alternations were made before the execution of contract agreement, they have been initialed by the Contractor and the

..... is hereby authorized to sign and initial on my behalf the documents forming part of this contract (Number of alternation in figures and words to be given me)

The above tender is accepted by me on behalf of the Bharat Heavy Electricals Limited, Unit Thriuverumbur, Tiruchirappalli – 620 014. for a sum of Rs.
.....
..... at the item rates as indicated in the Bill of Quantities attached to Schedule 'A'.

Signature Date.....

Designation

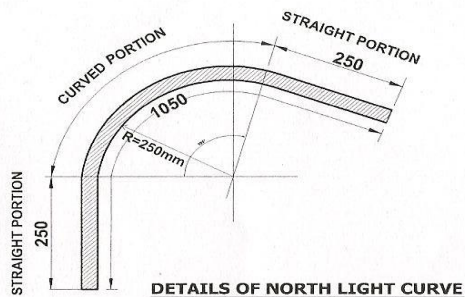

DETAILS OF NORTH LIGHT CURVE

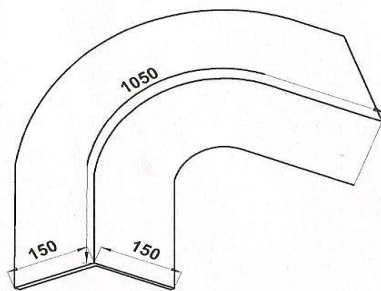

NORHLIGHT CURVE LEFT BARGE BOARD (PROFILE TO MATCH NORTH LIGHT CURVE) (CURVE LENGTH 1050MM)

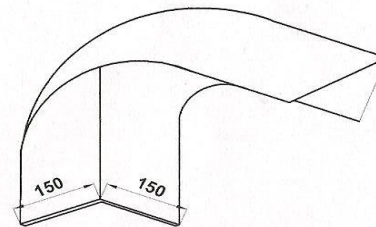

NORHLIGHT CURVE RIGHT BARGE BOARD (PROFILE TO MATCH NORTH LIGHT CURVE) (CURVE LENGTH 1050MM)

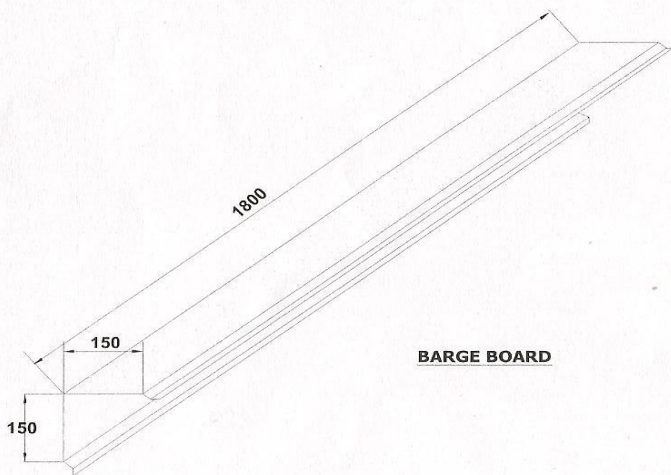

BARGE BOARD

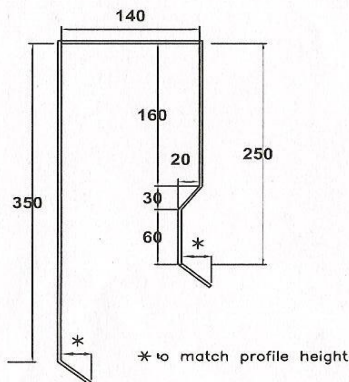

DETAILS OF OPENING FLASHING

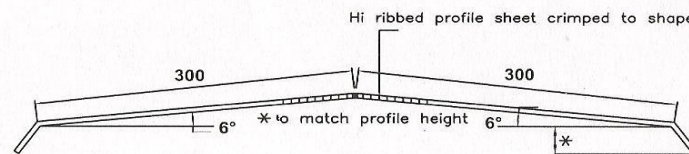

DETAILS OF RIDGE PIECE

SKETCH 1: DETAILS OF ACCESSORIES FOR METAL SHEET ROOFING & SIDE CLADDING.

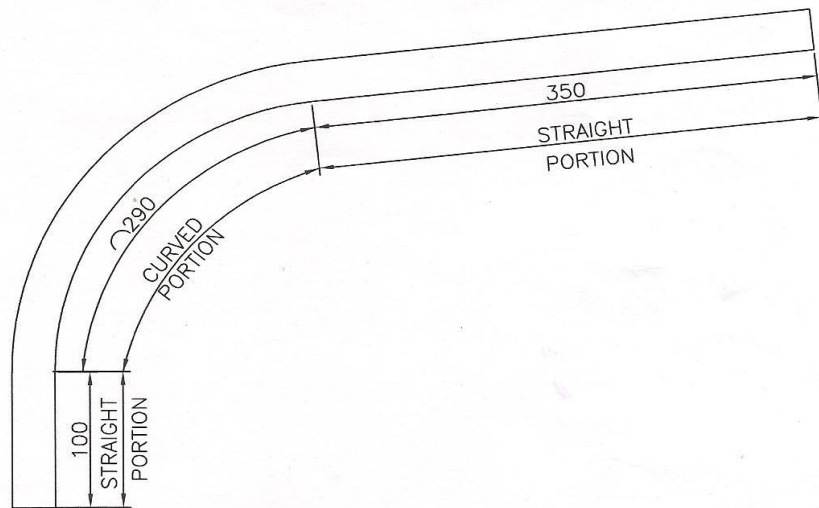

ALL DIMENSIONS ARE IN MM

SKETCH 2 : DETAILS OF END CURVE

To
THE PURCHASE/CONTRACT EXECUTING AGENCY/BHEL

E FORMAT

ACCEPTANCE FOR ELECTRONIC FUND TRANSFER / RTGS TRANSFER

01	Name & Address of the Supplier / Sub-contractor											
02	VENDOR CODE assigned by BHEL											
Details of Bank Account:												
03	NAME & ADDRESS OF THE BANK											
04	NAME OF THE BRANCH											
05	BRANCH CODE											
06	MICR CODE	<table border="1"><tr><td></td><td></td><td></td><td></td><td></td><td></td><td></td><td></td><td></td><td></td></tr></table>										
07	ACCOUNT NUMBER											
08	TYPE OF ACCOUNT	CURRENT A/C / OD / CASH CREDIT										
09	BENEFICIERY'S NAME											
10	IFSC CODE OF THE BRANCH	<table border="1"><tr><td></td><td></td><td></td><td></td><td></td><td></td><td></td><td></td><td></td><td></td></tr></table>										
11	EMAIL ID											
12	TELEPHONE/MOBILE NO.											

CERTIFICATE

I / We hereby agree to receive the payments due from BHARAT HEAVY ELECTRICALS LIMITED by the National Electronic Funds Transfer and/or RTGS Transfer mode by credit to my / our above mentioned Bank Account. I / We also agree that payments made to the above mentioned Account is a valid discharge of the liability of Bharat Heavy Electricals Limited. I / We also agree to bear the applicable Bank Charges for the above mode of transfer. **A copy of the cheque leaf/cancelled cheque leaf of the above account is sent herewith.**

AUTHORISED SIGNATORY WITH NAME SEAL

Banker's Certification

We confirm that we are enabled for receiving RTGS and NEFT credits and we further confirm that the account number of _____ (name of account holder), the signature of the authorized signatory and the MICR and IFSC codes of our Branch mentioned above are correct.

PLACE:
DATE :

(Manager / Officer's)
Signature Under Bank stamp and Name Seal
With Membership No.
(Telephone / Mobile No.)

Forwarded to Accounts Dept.

We confirm the above details are verified with the records available with us.

Signature of the BHEL Executive with Name Seal (Operating the Contract/Services)

SIGNATURE OF THE APPLICANT

CONTRACTOR

93

ACCEPTING OFFICER